

Device/PLC Connection Manuals



About the Device/PLC Connection Manuals

Prior to reading these manuals and setting up your device, be sure to read the "Important: Prior to reading the Device/PLC Connection manual" information. Also, be sure to download the "Preface for Trademark Rights, List of Units Supported, How to Read Manuals and Documentation Conventions" PDF file. Furthermore, be sure to keep all manual-related data in a safe, easy-to-find location.

1

Direct Access Communication

The *Direct Access* (Programless) format, which does not burden the PLC with protocol programs, runs communication between the GP and PLC. This chapter describes Direct Access Communication.

1.1

Communication Method

Depending on the part or tag setup, the GP can easily specify the PLC device. By doing so, the GP automatically requests the data required for operations (System Data) and the screen display from the PLC. Then the GP, depending on the PLC response, changes its screen display corresponding to its animation settings. Plus, data can be sent to the PLC using GP touch key input.

With Direct Access communication, the GP is always the master in the communication link.

In Direct Access Communication, data required by the screen display is automatically sent and received from the GP. Therefore, a PLC program for screen display operations is not necessary, thereby simplifying installation of the graphical control panel.

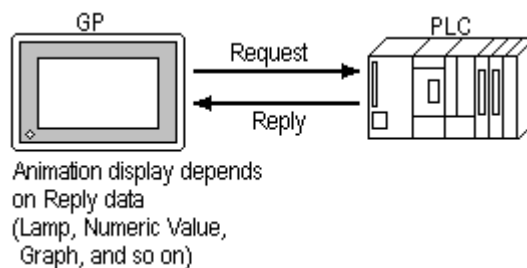

Caution

When an error occurs because data is read or written outside the PLC device range, the read/write operation continues retrying until the error is restored. For this reason, the action on the GP display screen may not seem to work. Check to make sure the device used for the part or tag is within the designated range for the PLC in use.

1.1.1 System Area Start Address

Setting up GP's INITIALIZE/STARTING ADDRESS OF SYSTEM DATA AREA automatically prepares the System Area in the PLC to make communication with the GP possible.

Reference For more information on setting starting address of System Data Area, refer to "PLC SETUP" in each GP unit's User's manual (sold separately).

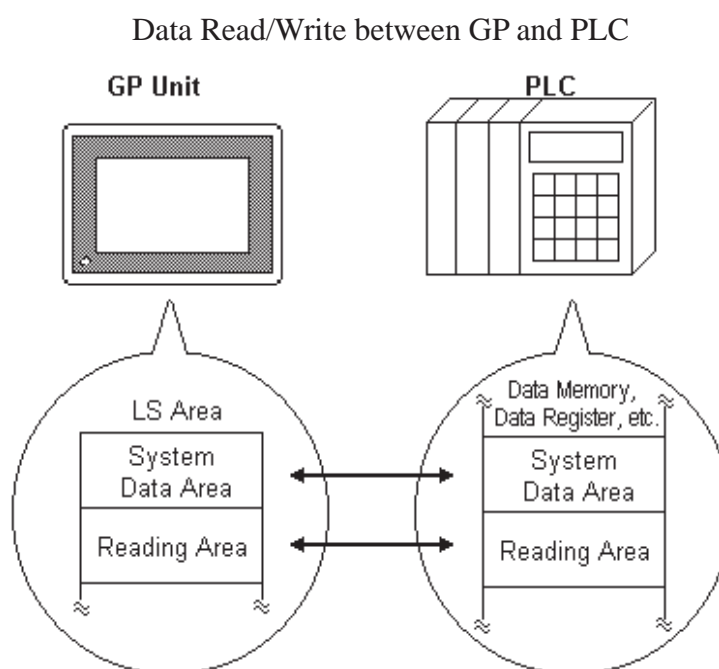

- Depending on the PLC, the System Data Area can be set to a certain device. In that device, only the addresses not used by the PLC can be used for the System Data Area.
- Devices that are highlighted with a double lined box in the device table described in Chapter 2 and Chapter 5 are the only device areas that can be used for the System Area.
- The starting address of the system data area can also be specified using the GP-PRO/PBIII software's "system settings" area.

Reference For more information, refer to the GP-PRO/PBIII for Windows Operation Manual.

1.1.2 LS Area Structure

The LS Area, located in the GP memory, is the area used for the GP's operations. The LS Area structure is as follows.

LS0	System Data Area
⋮	
LS19	Reading Area
LS20	
⋮	User Area
⋮	
LS2032	Special Relays
⋮	
LS2047	Reserved
LS2048	
⋮	User Area
LS2095	
LS2096	Reserved
⋮	
LS8191 * ¹	Reserved
LS8192	
⋮	Extended System Data Area* ³
LS8999	
LS9000	
⋮	
⋮	
LS9999	

System Data Area This is the data write area for GP screen control data or error information necessary for operations.

Reading Area Stores data common to all screens, the block display data for trend graph, or video control data.*² Up to 256 words can be designated here.

User Area The devices which are only for the GP's internal use, and cannot be allocated in the PLC. This area is used to process Parts and Tags which can only be processed by the GP internally and cannot be controlled by the PLC. This area can also store the video control data*².



When using the Device Monitor feature, the User Area (LS2096 to LS4095) will be reserved and cannot be used.

*¹ Except for GP2000 Series units, 4096 words (LS0 to LS4095) can be used.

*² When using the GP-570VM, be sure to set the video control area (22 words). The video control area is designated in either the reading area or the user's area.

Reference Each unit's User Manual (sold separately)

*³ Can be used for GP2000 Series only

Special Relays

This area, during GP communications, is where the various status information is setup.



Note: The following describes how to access the LS Area.

- Word Address access

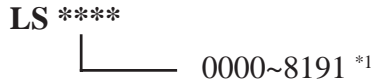

- Bit Address access



*1 Except for GP2000 Series units, 4096 words (LS0 to LS4095) can be used.

*2 When using Yaskawa Electronic CP9200SH Series protocol, Bit No. is from 0 to F.

■ Extended System Area

This area is used for a specific feature. It can be used for GP2000 Series only. For details of addresses, see reference of each feature.

LS9000	Trend Graph Previous Data Display function	▼ Reference ▼	<i>Tag Reference Manual</i> 2.31.6 Principles of Historical Function
LS9099			
LS9100	Script-processing Area	▼ Reference ▼	<i>Tag Reference Manual</i> 3.1.3 Using D-Script, 3.2.3 Setting Parameters
LS9199			
LS9200	CSV Data Transfer function	▼ Reference ▼	<i>Tag Reference Manual</i> 4.4.6 Automatic Transfer Operation on the GP
LS9210			
LS9211	Reserved		
LS9299			
LS9300			
LS9309			
LS9310			
LS9311			
LS9999			
	Security Feature	▼ Reference ▼	<i>Operation Manual</i> 4.7 Security Feature
	Reserved		

Reserved

Please do not use this area. It is only for GP's internal use. If you use this area, the GP will not operate properly.

1.1.3 About Each Address

Up to 20 words can be set as the System Data Area; up to 256 words can be set as the Reading Area.*¹ The size of these determines each area's number of addresses.

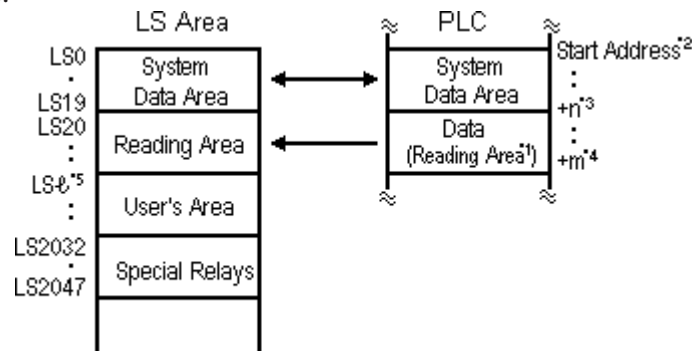

- **Part or Tag addresses cannot be set so that they include the System Area and the Reading Area, or the Reading Area and the User's Area.**
- **When setting Parts or Tags inside the System Data Area's addresses, specify their data length as 16 bits.**

*¹ If the device range of your PLC is less than 256 words, the size of the PLC's device range minus the size of System Data Area gives the maximum size for the Reading Area.

*² The Start Address means the start address of System Data Area specified in the **INITIALIZE** menu.

Reference For more information, refer to "5.5 PLC SETUP" in each unit's User's Manual (sold separately)

*³ $n = 0 \sim 20$: Differs with the number of items selected for the System Data Area in the **INITIALIZE** menu.

*⁴ $m =$ Reading Area Size

*⁵ $\emptyset =$ Reading Area Start Address (20) + Reading Area Size(m)

1.1.4 Contents and Range of System Data Area

The following table describes the data write contents of the System Area for each address.

■ For a PLC using 16-bit addressing



Important

- **If your PLC supports only 8-bit addresses, please refer to the table on page 1-1-9.**
- **When you wish to turn off the GP's display, use the display's ON/OFF bit (word address +9). Do not use the Control area's Backlight OFF bit (word address +14).**



Note:

- **The Word Address values assume that all the items have been selected for the System Data Area in the GP's INITIALIZE menu.**
- **Here, "item #" represents the item numbers shown in the System Environment Setup area's SYSTEMAREA SETUP; found in the GP OFFLINE mode's INITIALIZE area.**

	Item #	Word Addr	Contents	Bit	Detail
GP ↓ PLC E x c l u s i v e W r i t i n g A r e a	1	+0	Display Screen Number	1 to 8999 (However, 1 to 1999 when using BCD input)	
	2	+1	Error Status	0,1	Not used
			Each bit changes to reflect the GP error status. When an error occurs, the bit is set ON. A bit that has turned ON remains ON until the power is turned OFF and back ON, or until RUN mode is re-entered from OFFLINE mode. For Error Status data and processing notes, refer to the end of this section.	2	System ROM/RAM
				3	Memory Checksum
				4	SIO Framing
				5	SIO Parity
				6	SIO Over-run
				7,8	Not used
				9	Memory requires Initialization
				10	Timer Clock Error
	11	PLC			
	12 to 15	Not used			
	3	+2	Current YEAR, BCD 2 digits	Last two digits	
			+3	Current MONTH, BCD 2 digits	01 to 12 (month)
			+4	Current DAY, BCD 2 digits	01 to 31 (date)
			+5	Current TIME, BCD 4 digits	00 to 23 hr, 00 to 59 min
	4	+6	Status ^{*5}	0,1	Reserved
				2	Now Printing ^{*1}
				3	Writes a set value ^{*2}
				4 to 6	Reserved
7				PLC monopoly ^{*3}	
8				K-tag entry error ^{*4}	
9				Display 0: Possible, 1: Not Possible ^{*6}	
10				Backlight OFF ^{*7}	
11				Touch-panel input error ^{*8}	
12 to 15	Reserved				
5	+7	Reserved			

	Item #	Word Addr	Contents	Bit	Detail
PLC ↓ GP E x c l u s i v e R e a d i n g A r e a	6	+8	Change Screen Number		1 to 8999 (However, 1 to 1999 when using BCD input) When the address top-most bit is turned ON, the PLC changes the mode to Forced Screen Change mode. While this mode is enabled, the GP cannot be used to change screens. Please refer to this document's "Forced Screen Change" section for details.
	7	+9	Screen Display On/Off ^{*15}		FFFFh: Screen clears almost immediately. 0h: Screen turns ON. All other bits are reserved.
	8	+10	Clock's YEAR set value, BCD 2 digits (+flag)		Last 2 digits (bit #15 is the clock's data write change flag ^{*9})
		+11	Clock's MONTH set value, BCD 2 digits		01 to 12
		+12	Clock's DATE set value, BCD 2 digits		01 to 31
		+13	Clock's TIME set value, BCD 4 digits		00 to 23 Hr: 00 to 59 Min
	9	+14	Control ^{*16}	0	Backlight OFF ^{*10}
				1	Buzzer ON
				2	Starts printing
				3	Reserved
				4	Buzzer ^{*11} 0: Enabled, 1: Disabled
				5	AUX Output ^{*11} 0: Enabled, 1: Disabled
				6	Reserved
				7	PLC monopoly ^{*12} 0: Disabled, 1: Enabled
				8	VGA Display ^{*13} 0: Disabled, 1: Enabled
				9,10	Reserved
	11	Hard copy output ^{*14} 0: Enabled, 1: Disabled			
	12 to 15	Reserved			
	A	+15	Reserved		Set to 0
	B	+16	Window Control ^{*17}	0	Display - 0: OFF, 1: ON
1				Changing the order of window overlapping 0: Possible, 1: Not Possible	
2 to 15				Reserved	
C	+17	Window Registration Number ^{*17}		Global Window registration number selected by Indirect setup (Bin/BCD)	
D	+18	Window Display Position (X coordinate data) ^{*17}		Global Window display coordinates selected by Indirect setup (Bin/BCD)	
	+19	Window Display Position (Y coordinate data) ^{*17}			

- *1 This bit turns on during printing. Changing to OFFLINE mode while this bit is ON can scramble the print output.
- *2 Every time a value is written with the K-tag or Keypad Input Display, the bit is reversed.
- *3 When using Multi-link, the bit turns ON in the middle of PLC Monopolize.
- *4 When an alarm is setup in the middle of K-tag input, and a value outside the alarm range is entered, the bit turns ON. When you enter a value within the alarm range, or a screen change takes place, the bit turns OFF.
- *5 Monitor, in bit units, only the necessary bits. Since reserved bits may be used for GP system maintenance, etc., their ON/OFF status is not defined.
- *6 <Display ON/OFF status>
The GP/GLC screen display ON/OFF can be detected from the PLC. This bit will change in the following cases:
 - (1) "FFFFh" is written to the system data area's screen display ON/OFF bit (LS9 when using link type), to turn the screen display OFF. (Bit 9 = 1)
 - (2) After the stand-by time has elapsed, the screen display OFF bit is turned ON automatically. (Bit 9 = 1)
 - (3) The screen display OFF status has been changed to the screen display ON status via screen switching and touching. (Bit 9 = 0)
 - (4) The screen display ON/OFF status bit will not change via turning ON/OFF the system data area backlight OFF bit (Bit 0).
- *7 <Backlight Burnout Detection>
The bit turns ON when backlight burnout is detected. This feature is available only on GP-377R, GP-377, GP2000, and GLC2000 series unit.
- *8 <Touch-panel input error>
The touch-panel input error bit is turned ON when input in the same position continues for longer than the specified time.
- *9 When the data write flag changes (OFF→ON, or ON→OFF), the clock data is rewritten.

E.g. October 16, 1995, 9:57 pm

The current data in word address +10 is 0000.

Month, Date, Time data is written as follows:

- In word address +11 0010
- In word address +12 0016
- In word address +13 2157

When the YEAR's 15th bit is turned on, the data is written.

- Inputting 8095 into word address +10 causes the clock data to rewrite.

- *10 With the System Data area's GP series except GP-477R, GP-470 and GP870 series units, the backlight turns OFF when this bit is ON(LCD display does not change) and turns ON when the bit is OFF.

When the Backlight OFF bit (word address +14) turns ON, only the backlight will turn OFF, however, the LCD display will remain ON and all touch switches set up on the display can still be used. Use the Screen display ON/OFF bit (word address +9) to actually turn the screen display OFF.

- *11 Control Bit 1(Buzzer On) is output as shown below.

Buzzer output..... When control bit 1 is ON, the GP internal buzzer is activated.

- *12 When using n:1 (multi-link), PLC is monopolized when ON.

Reference Refer to Chapter 4.5, "About PLC Monopolize."

- *13 <Control VGA display>

When the control VGA display bit is turned ON, the entire screen becomes a VGA display in the compatible mode using the VM unit with the GP-570VM, GP-870VM, or GP-2500/GP-2600.

When the VM unit is used with the GP-570VM, GP-870VM, or GP-2500/GP-2600 in the compatible mode, turning the control VGA display bit ON makes the entire screen a VGA display. Touching any position on the screen during the VGA display turns this bit OFF.

- *14 Turning ON bit 11(Hard Copy Output) in the Control Area (word address +14) cancels the current printing of the display's hard copy.

- After printing is cancelled, bit 11, however, will not turn OFF automatically. Therefore, after checking the Status Area's Now Printing bit, turn OFF the Control Area's bit 11.

- When bit 11 in the Control Area is turned ON, hard copy cannot be created. If you cancel printing before it is completed, printing will stop after the last line of data on the panel's current display has been output. Data already input in the printer buffer's memory will not be deleted.

- *15 After the System Data area's screen display ON/OFF bit (word address +9) is set to OFF, simply touching the screen will turn the display ON again.

- *16 Be sure to turn all reserved bits OFF since they may be used for GP system maintenance, etc.



When writing data to the Control Area (Address +14) be sure to use bit units. Writing data in Word units can cause values to change.

- *17 **Reference** For more about windows, refer to "2.26 U-tag (Window Display)" in the Tag Reference Manual.

■ For a PLC using 8-bit addressing



- The Byte Address values assume all the items have been selected for INITIALIZE's System Area. They differ depending upon whether the PLC addresses are displayed as decimal or octal.
- The High and Low positions of the Byte Address of all items vary among PLCs.
- To turn OFF the screen display, normally use address +18 (decimal) or address +22 (octal) (turning ON/OFF the screen display), rather than the Backlight OFF bit at address +28 (decimal) or address +34 (octal) (control).



- Here, "item numbers" represent the item numbers shown in the [System Environment Setup] area's [SYSTEM AREA SETUP]; found in the GP OFFLINE mode's [INITIALIZE] area.

	Item #	Byte Addr		Contents	Bit	Detail
		Decimal	Octal			
GP ↓ PLC E x c l u s i v e W r i t i n g A r e a	1	+0	+0	Display Screen Number	1 to 8999 (However, 1 to 1999 when using BCD input)	
		+1	+1			
	2	+2	+2	Error Status Each bit changes to reflect the GP error status. When an error occurs, the bit is set ON. A bit that has turned ON remains ON until the power is turned OFF and back ON, or until RUN mode is re-entered from OFFLINE mode. For details and the handling process about the Error Status contents, refer to the end of this section.	0,1	Not used
					2	System ROM/RAM
					3	Memory Checksum
					4	SIO Framing
					5	SIO Parity
					6	SIO Over-run
		7	Not used			
		0	Not used			
		1	Memory requires Initialization			
		2	Timer Clock Error			
3	PLC SIO Error					
4 to 7	Not used					
	3	+4	+4	Current YEAR	Last 2 digits	
		+5	+5	BCD 2digits		
		+6	+6	Current MONTH	01 to 12 (month)	
		+7	+7	BCD 2digits		
		+8	+10	Current DAY	01 to 31 (date)	
		+9	+11	BCD 2digits		
		+10	+12	Current TIME	00 to 23 hr, 00 to 59 min	
		+11	+13	BCD 4digits		

	Item #	Byte Addr		Contents	Position	Bit	Detail	
		Decimal	Octal					
GP ↓ PLC	4	+12	+14	Status *7	Low	0,1	Reserved	
						2	Now Printing *1	
						3	K-tag write *2	
						4 to 6	Reserved	
						7	PLC Monopoly *3	
High	0	K-tag entry error *4						
	1	Display: 0:ON, 1:OFF						
	2	Backlight Burnout Detection *5						
	3	Touch-panel input error *6						
	4 to 7	Reserved						
5	+14	+16	Reserved					
								+15
PLC ↓ GP E x c l u s i v e R e a d i n g A r e a	6	+16	+20	Change Screen Number		1 to 8999 (However, 1 to 1999 when using BCD input) When the address top-most bit is turned ON, the PLC changes the mode to Forced Screen Change mode. While this mode is enabled, the GP cannot be used to change screens. Please refer to this document's "Forced Screen Change" section for details.		
		+17	+21					
	7	+18	+22	Screen Display On/Off *16		FFFFh: Screen clears almost immediately. 0h: Screen turns ON. All other bits are reserved.		
		+19	+23					
	8	+20	+24	Clock's YEAR setup value BCD 2 digits (+flag)		Last 2 digits (15th bit of high address is the clock's data write change flag *8)		
		+21	+25					
		+22	+26			Clock's MONTH setup value BCD 2 digits	01 to 12	
		+23	+27					
		+24	+30			Clock's DATE setup value BCD 2 digits	01 to 31	
		+25	+31					
		+26	+32			Clock's TIME setup value BCD 4 digits	00 to 23 Hr: 00 to 59 Min	
	+27	+33						
	9	+28	+34			Low	0	Backlight OFF *9
1							Buzzer ON	
2							Starts printing	
3							Reserved	
4		Buzzer *10 0: Enabled, 1: Disabled						
5		AUX Output *10 0: Enabled, 1: Disabled						
6		Reserved						
7		PLC Monopoly *11 0: Disabled, 1: Enabled						
High	0	VGA Display *12 0: Disabled, 1: Enabled						
	1 to 2	Reserved						
	3	Hard Copy output 0: Enabled, 1: Disabled						
	4 to 7	Reserved						
A	+30	+36	Reserved			Set to 0		
	+31	+37						

	Item #	Byte Addr		Contents	Position	Bit	Detail	
		Decimal	Octal					
PLC ↓ GP E R e a d i n g A r e a	B	+32	+40	Window Control *13 *15	Low	0	Display 0: Possible, 1: Not Possible	
						1	Changing the order of window overlapping 0: Possible, 1: Not Possible	
		+33				+41	2 to 15	Reserved
							High	2 to 15
	C	+34	+42	Window Registration Number *13	Selected Global registration number for Indirect setup (Bin/BCD)			
		+35	+43					
	D	+36	+44	Window Display Position (X coordinate data) *13	Global Window display coordinates for Indirect setup (Bin/BCD)			
		+37	+45					
		+38	+46	Window Display Position (Y coordinate data) *13	Global Window display coordinates for Indirect setup (Bin/BCD)			
		+39	+47					

*1 This bit turns ON during printing. Changing to OFFLINE mode while this bit is ON can scramble the print output.

*2 Every time a value is written with the K-tag, the bit is reversed.

*3 When using Multi-link, the bit turns on in the middle of PLC Monopolize.

*4 When an alarm is set up in the middle of K-tag input, and a value outside the alarm range is entered, the bit turns ON. When you enter a value within the alarm range, or a screen change takes place, the bit turns OFF.

*5 <Backlight Burnout Detection>

The bit turns ON when backlight burnout is detected. This feature is available only on GP-377R, GP-377, GP2000, and GLC2000 series unit.

*6 <Touch-panel input error>

The touch-panel input error bit is turned ON when input in the same position continues for longer than the specified time.

*7 The vertical relationship of addresses differs depending on the PLC type.

Monitor, in bit units, only the necessary bits.

Since reserved bits may be used for GP system maintenance, etc., their ON/OFF status is not defined.

*8 When the data write flag changes (OFF→ON, or ON→OFF), the clock data is rewritten.

E.g. October 16, 1995, 9:57 pm

The current data in byte data addresses +24 and +25 is 0000.

Month, Date, Time byte data is written as follows:

- In byte addresses +26,27 0010
- In byte addresses +30,31 0016
- In byte addresses +32,33 2157

When the YEAR's 15th bit is turned on, the data is written.

- Inputting 8095 into byte addresses +24 and +25 causes the clock data to rewrite.

*9 For GP-675, GP-570, GP-577R, GP-370, GP-270, and GP-H70, the backlight turns OFF when this bit is ON. (LCD displays do not change.) Lights up when this bit turns OFF. When the Backlight OFF bit (byte address +34) turns ON, only the backlight will turn OFF, however, the LCD display will remain ON, and all touch switches set up on the display can still be operated. Use the Screen display ON/OFF bit (byte address +22) to turn OFF the screen display.

- *10 Control Bit 1(Buzzer On) is output as shown below.
Buzzer output When control bit 1 is ON, the GP internal buzzer is activated.
AUX output When control bit 1 is ON, the AUX buzzer is activated.
- *11 When using **n:1** (multi-link), PLC is monopolized when ON.
Refer to **Chapter 4.5, "About PLC Monopolize."**
- *12 **Reference** The entire screen becomes a VGA display. Pressing a free position on the screen in the middle of VGA display turns this OFF.
- *13 **Reference** For more about windows, refer to "**2.26 U-tag (Window Display)**" in the Tag Reference Manual.
- *14 The vertical relationship of addresses differs depending on the PLC type. Be sure to keep all Reserved bits turned OFF, since these bits may be needed for the GP system maintenance.
- *15 The vertical relationship of addresses differs depending on the PLC type.
- *16 After the screen display ON/OFF bit in System Data area's byte address +22 is set to OFF, simply touching the screen will turn the display ON again.
- *17 Turning ON bit 3(Hard Copy Output) in the Control Area (byte address +35) cancels the current printing of the display's hard copy.
 - After printing is cancelled, bit 3, however, will not turn OFF automatically. Therefore, after checking the Status area's Now Printing bit, turn OFF Control area bit 3.
 - When bit 3 in the Control area is turned ON, hard copy cannot be created. If you cancel printing before it is completed, printing will stop after the last line of data on the panel's current display has been output. Data already input in the printer buffer's memory will not be deleted.

■ Forced Screen Change

◆ Performing a forced screen change

A forced screen change operation takes place when the host (PLC) System Data Area +8's (Change Screen Number storage address) top bit is set to 1. Add 8000h to the desired screen number before writing this data to the System Data Area. This action is possible only from the host (PLC) side. The forced screen change has priority over other screen change operations.

E.g. To change to screen number 2

When the touch panel input has the highest priority for screen change, the screen change does not take place even if the same data is written to host (PLC) System Area +8.

However, when using the forced screen change, the actions explained previously

can cause a screen change.



Note:

When forcing a screen change when screen number data is in BCD form, set up the system so as it is controlled in the screen number range 1 to 1999.

◆ Releasing Forced Screen Change

Forcing a screen change prevents touch panel screen changes until the enforcing bit is released. Therefore, the top bit in the data in the +8 address must be set OFF. This action is valid only from the host (PLC) side.

■ Error Status Contents and Correction Process

Error	Origin	Solution
System ROM/RAM	Problem with the hardware	Run Self-Diagnosis.
Memory Checksum	Because the screen file is corrupted, the screen memory data checksum does not match.	After powering up, check the screen where the error developed. (For details, refer to your Use's Manual, "Error Message" section.)
SIO Framing	Framing error	Check the SIO Setup. (For details, refer to you User's Manual, "Would Not Communicate" section.)
SIO Parity	Parity error	
SIO Over-run	Over-run error	
Memory requires Initialization	Internal Memory has not been initialized.	Initialize internal memory.
Timer clock Error	The GP internal clock has been interrupted.	The GP internal battery may be drained. Contact your local GP distributor for service.
PLC SIO Error (only for Direct Access type)	Either the SIO setup between the GP and PLC do not match, or an error has developed on the PLC side.	Check the SIO Setup. (For details, refer to you User's Manual, "Would Not Communicate" section.)

■ Printing out from the GP

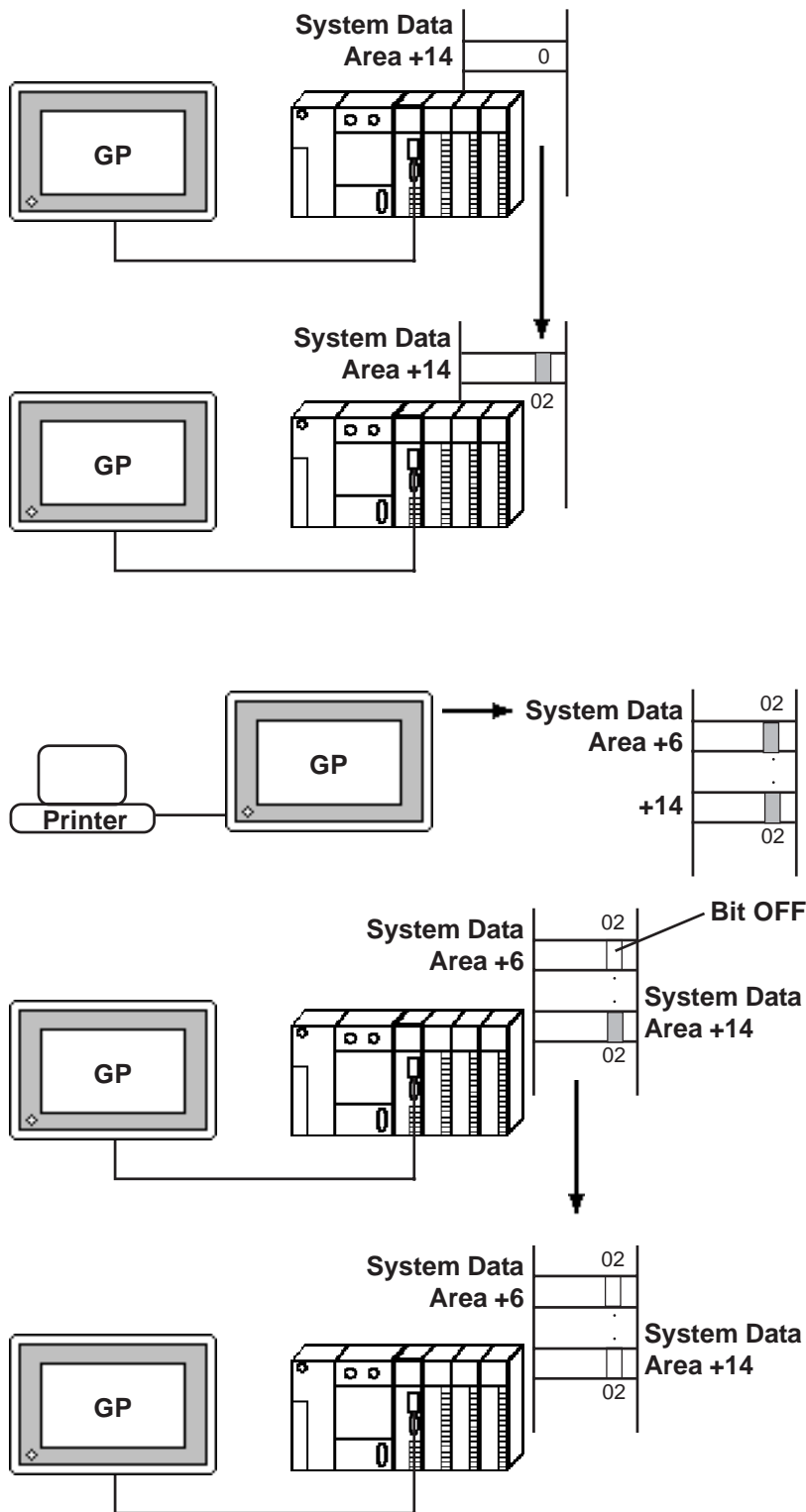

1) When the second bit in PLC System Data Area +14 is turned ON, (data 4) is written.

2) When the second bit in System Data Area +14 is turned ON, the on-screen data is output to the printer for (hard copy).

At the same time, the second bit in System Data Area +6 is turned ON.

3) After printing is finished, the second bit in System Data Area +6 turns OFF, however, the second bit in System Data Area +14 remains ON.

4) After checking the second bit in System Area +6 turned OFF, please turn OFF the second bit in System Area +14. Be sure to use the PLC to turn this bit OFF.

1.1.5 Special Relays

The structure of the Special Relays is as follows.

LS2032	Common Relay Information	
LS2033	Base Screen Information	
LS2034	Reserved	
LS2035	1 Second Binary Counter	
LS2036	Tag Scan Time	
LS2037	SIO Cycle Time	
LS2038	Tag Scan Counter	
LS2039	SIO Error Code	
LS2040	max Token Circulation Speed	} Used only with n:1 multi-link connection
LS2041	current Token Circulation Speed	
LS2042	Reserved	
:		
LS2047		

■ Common Relay Information (LS2032)

15 14 13 12 11 10 9 8 7 6 5 4 3 2 1 0

--	--	--	--	--	--	--	--	--	--	--	--	--	--	--	--

Bit	Description
0	Repeatedly turns ON/OFF in a communication cycle.
1	Remains ON after when a screen change (base, window) occurs until the tag scan is complete.
2	ON only in the middle of an SIO error developing.
3	ON when displaying the Initial screen after powering up.
4	Always ON
5	Always OFF
6	Turns ON when backup SRAM data has been delated (Only for GP's equipped with backup SRAM).
7	Turns ON if a BCD error occurs while D script is being used. For more information about D script, refer to the Tag Reference Manual's section 3.1 "D script".
8	Turns ON if a zero division error occurs while D script is being used.
9	Filing data. Turns ON if the data is not transferred to Backup SRAM.
10	Filing data transfer is triggered by the Control Word Address. Turns ON if the data can not be transferred from PLC to SRAM. Also data transfer between PLCs is triggered by the Filing Data Display. Turns ON if the data is not transferred from PLC to SRAM only when the transfer complete bit address is used.
11	Filing data. Via transfer data to and from SRAM to LS area, via Filing Data Display.
12	When using D-script, turns ON if a communication error occurs when the function memcpy () is used, or reading the data from designated Address Offset. Turns OFF when data read is normally completed.
13	When there's no setting of a connected device for a generic SIO, if a sending function, a receiving function, Control, Status, or the number of received data is read out, Turns ON.
14	When reading out an expansion script exclusive function (such as a character string operation function) via a generic SIO script, or when reading a generic SIO exclusive function via an expansion script, Turns On.
15	Reserved

Reference

For more information about *D* script, refer to *Tag Reference Manual "3.1 D-Script/ Global D-Script"*.

■ **Base Screen Information (LS2033)**

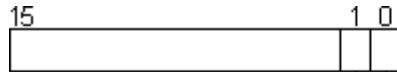

- Repeatedly turns On/Off in a communication cycle.
- Remains on from the base screen change to when the tag scan is complete.

■ **Reserved (LS2034)**

The *Reserved* area value is indeterminate. Do not use this area.

■ **1 Second Binary Counter (LS2035)**

Begins counting in 1 second units, after powering up. The data is in binary format.

■ **Tag Scan Time (LS2036)**

The time it takes to scan the setup screen display tags. The data is stored in binary *ms* units. The data renews at the point when the management of all the object tags is complete. The initial data value is **0**. The measured time may differ by ± 10 ms with the actual time.

■ **SIO Cycle Time (LS2037)**

The time it takes in 1 cycle, from the beginning to the end, to scan the SIO object (PLC internal System Area) and various devices. The data renews at the point when the management of the System Area and all the object devices is complete. The initial data value is **0**. The unit is 10ms.

■ **Tag Scan Counter (LS2038)**

Begins counting in binary units, roughly when the scan of the tags setup on the display screen is complete.

■ **SIO Error Code (LS2039)**

When an SIO error arises, the SIO error code displayed last is stored in binary data.

■ **Maximum Token Circulation Speed (LS2040)**

(only when using **n:1** Multi-link connection)

The maximum time it takes for the *token packet* (the right to communicate exclusively to the PLC) to circulate to the **n** number of connected GP's. The data is stored in binary *ms* units. The data renews when the maximum value changes or a screen change occurs. Its initial data

value is **0**. The unit is 10ms.

■ **Current Token Circulation Speed** (LS2041)

(only when using **n:1** Multi-link connection)

The current time it takes for the *token packet* (the right to communicate exclusively to the PLC) to circulate to the **n** number of connected GP's. The data is stored in binary *ms* units. The data renews when the current value changes or a screen change occurs. The initial data value is **0**. The unit is 10ms.



- ***If a problem occurs which causes an SIO error for an extended period of time, such as the unit's data transmission cable becomes loose or disconnected, etc., it may ultimately create a System Error. When this occurs, reset the GP.***
- ***When using the 1 Second Binary Counter and Tag Scan Counter value as the W-tag's monitor bit or D script's trigger bit, and the SIO error condition continues, it may develop into a System Error. When this occurs, reset the GP.***



Special Relays are not write protected. Be careful not to use a tag to overwrite this data.



When using a 1:1 connection, the initial Token Circulation Speed values remain (0).

1.2 Efficient Data Communication

When using the PLC Direct Access Type, the GP unit communicates based on the device addresses set on each screen. As a result, the more parts or tags set on a screen, the more data is transferred, reducing the communication speed. For this reason, to speed up the response times, make data communication as efficient as possible.

On the GP, in addition to the ordinary communication method, there are the *Block Transfer* and *LS Area Communication* methods, which upgrade data transfer efficiency.

1.2.1 Block Transfer

When displaying consecutive PLC devices on the GP, the GP automatically groups the transmission data into a block, which increases the communication speed.

The addresses in the determined data number range*¹ must be consecutive to use Data Block Transfer.

When parts or tags are set up in consecutive addresses, the GP automatically reads the data as a single block. When you wish to transfer a block, design your part or tag layout so that the addresses are consecutive.

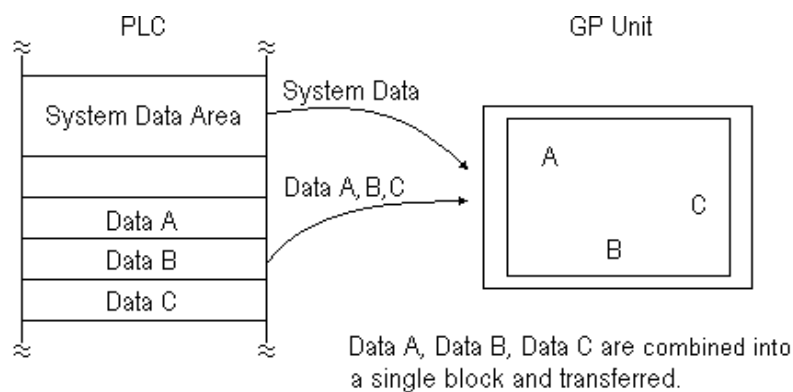

*1 The maximum number of consecutive addresses is limited by the PLC device. Refer to the Appendix, "Maximum Number of Consecutive Addresses".

1.2.2 LS Area Communication

Use the LS area for communication in the following cases: when there is display data common to all screens, when there is Trend Graph block display data, or when a video window display is used. (GP-570VM only)

To run LS Area communication, first set up the size of the Reading Area in GP's INITIALIZE setting. Then transfer the common display data or block display trend graph data to the Reading Area, allocated in the PLC's internal memory. (Transfer according to the PLC ladder program.)

By doing so, the data transferred into the Reading Area *and* the System Data is transmitted to the GP unit in one transmission.

By using the LS Area Communication method, no matter what screen is displayed on the GP, the System Data is transmitted continually. Therefore, to change screens quicker, use LS Area Communication instead of Block Transfer.

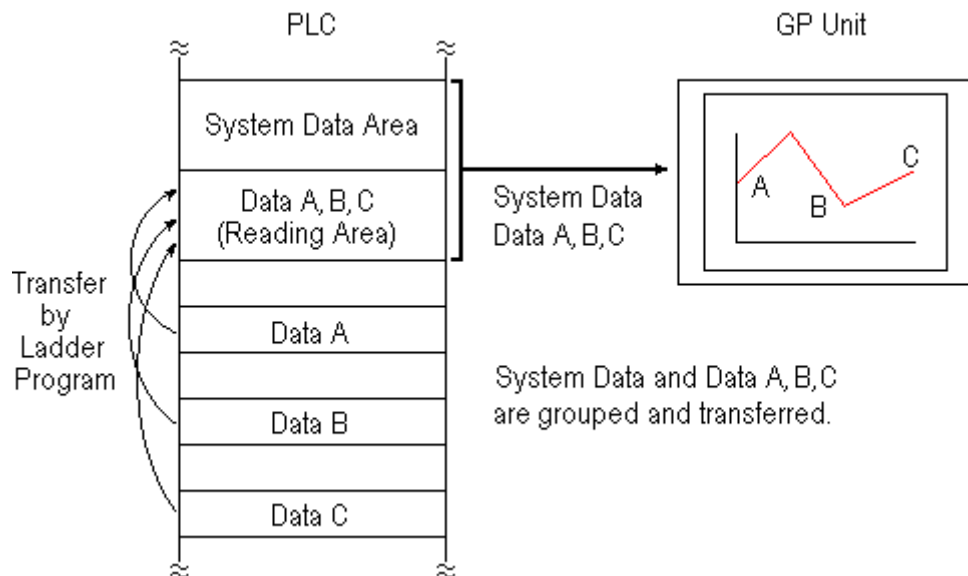

- **Use LS Area transmission only when there is data common to all screens, when Trend Graph block display data is available, or when a video window display is being used. Otherwise, communication efficiency will not be realized.**
- **Setting up a Reading Area that is too large can cause the display of tags that do not use the Reading Area, or can slow data communication speed.**
- **When there are many parts or tags on a screen, set all the parts or tags to consecutive addresses. Block data transfer can be utilized as a result, speeding up transmission.**

1.2.3 Reset GP on Data Write Error

If a Write error occurs, you can cancel the error from the error display. You will need to set up this feature beforehand via the GP's OFFLINE mode's INITIALIZE area.

Reference Each GP User's Manual OFFLINE Mode



- This feature is available only with GP77R, GP-377, GP-2000 series units.
- The factory setting is OFF.

The following list shows the PLC types which do not support this feature.

SIEMENS	PROFIBUS-DP INTERBUS SLAVE
Allen-Bradley	AB DataHighway Plus AB Remote I/O
Modicon	Modicon Modbus (SLAVE) Modicon Modbus Plus
DeviceNet Slave I/O	
CC-Link	
Memory Link SIO	
Memory Link Ethernet	

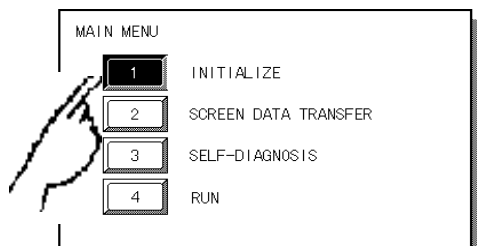

- 1) Touch item #1, INITIALIZE. The INITIALIZE menu will appear.

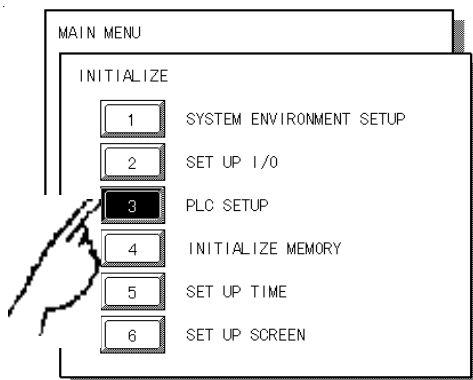

- 2) Touch item #3, PLC SETUP. The PLC SETUP menu appears.

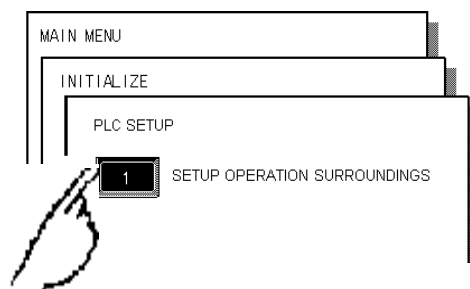

- 3) Touch item #1, SET UP OPERATION SURROUNDINGS. The SET UP OPERATION SURROUNDINGS menu will appear.

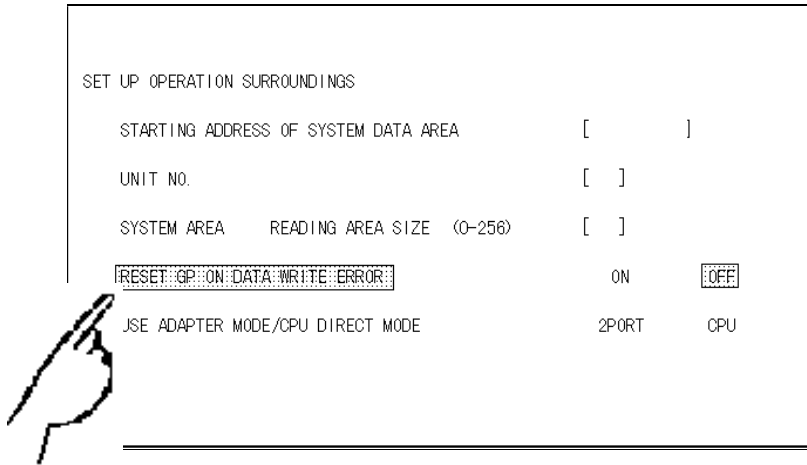

4) Touch the “RESET GP ON DATA WRITE ERROR” selection. The selected item is highlighted.



5) When DATA WRITE ERROR occurs, select ON to cancel the data write error.

When a DATA WRITE ERROR occurs, the screen shown here will be displayed.

*OFFLINE Mode **Reference**
GP User Manual OFFLINE Mode

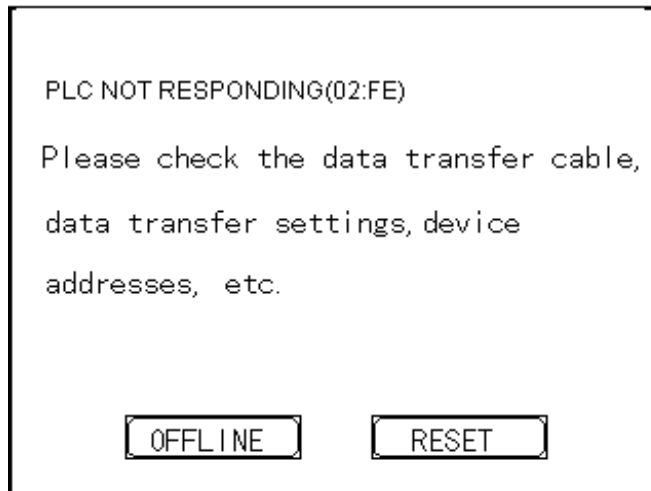

- If you select "OFFLINE" : The main menu will be displayed.
- If you select " RESET" : The GP will be reset, then change automatically to "OFFLINE" mode and a DATA WRITE ERROR will not occur.