



**SEMIKRON® 4**

## Power Bridge Rectifiers

### SKD 160

#### Features

- Robust plastic case with screw terminals
- Large, isolated base plate
- Blocking voltage up to 1800 V
- High surge currents
- Three phase bridge rectifier
- Easy chassis mounting
- UL recognized, file no. E 63 532

#### Typical Applications\*

- Three phase rectifiers for power supplies
- Input rectifiers for variable frequency drives
- Rectifiers for DC motor field supplies
- Battery charger rectifiers

1) Available in limited quantities

2) Mounted on a painted metal sheet of min. 250 x 250 x 1 mm;

$R_{th(c-a)} = 1,8 \text{ K/W}$

$V_{RSM}$ V	$V_{RRM}, V_{DRM}$ V	$I_D = 160 \text{ A (full conduction)}$ ( $T_c = 100 \text{ °C}$ )
800	800	SKD 160/08
1200	1200	SKD 160/12
1400	1400	SKD 160/14
1600	1600	SKD 160/16
1800	1800	SKD 160/18 <sup>1)</sup>

Symbol	Conditions	Values	Units
$I_D$	$T_c = 85 \text{ °C}$	205	A
	$T_a = 45 \text{ °C; chassis } ^2)$	30	A
	$T_a = 45 \text{ °C; P1/200}$	75	A
	$T_a = 35 \text{ °C; P1/120F}$	145	A
	$T_a = 35 \text{ °C; P3/120F}$	146	A
$I_{FSM}$	$T_{vj} = 25 \text{ °C; 10 ms}$	1800	A
	$T_{vj} = 150 \text{ °C; 10 ms}$	1500	A
$i^2t$	$T_{vj} = 25 \text{ °C; 8,3 ... 10 ms}$	16200	A <sup>2</sup> s
	$T_{vj} = 150 \text{ °C; 8,3 ... 10 ms}$	11200	A <sup>2</sup> s
$V_F$	$T_{vj} = 25 \text{ °C; } I_F = 300 \text{ A}$	max. 1,65	V
$V_{(TO)}$	$T_{vj} = 150 \text{ °C}$	max. 0,85	V
$r_T$	$T_{vj} = 150 \text{ °C}$	max. 3	mΩ
$I_{RD}$	$T_{vj} = 25 \text{ °C; } V_{DD} = V_{DRM}; V_{RD} = V_{RRM}$	max. 0,5	mA
	$T_{vj} = 150 \text{ °C; } V_{RD} = V_{RRM}$	6	mA
$R_{th(j-c)}$	per diode	0,65	K/W
	total	0,11	K/W
$R_{th(c-s)}$	total	0,03	K/W
$T_{vj}$		- 40 ... + 150	°C
$T_{stg}$		- 40 ... + 125	°C
$V_{isol}$	a. c. 50 Hz; r.m.s.; 1 s / 1 min.	3600 ( 3000 )	V
$M_s$	to heatsink	$5 \pm 15 \%$	Nm
$M_t$	to terminals	$5 \pm 15 \%$	Nm
$m$		270	g
Case		G 37	

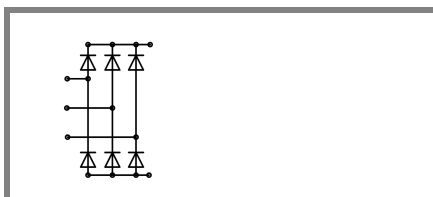

**SKD**

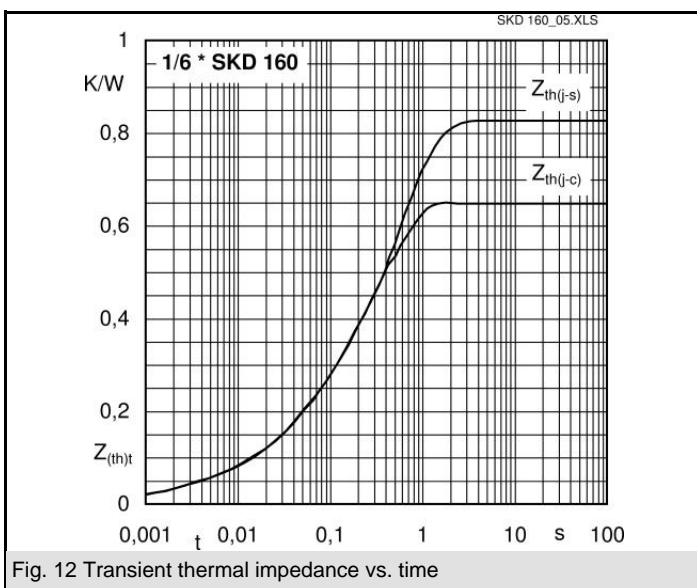
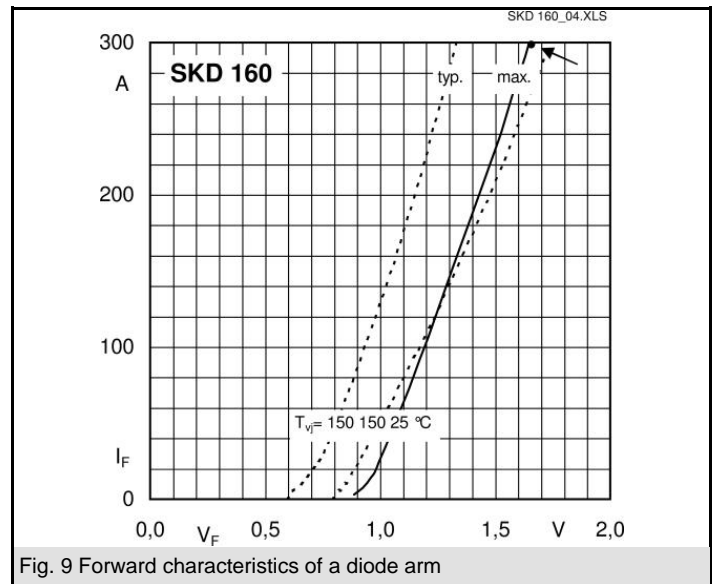
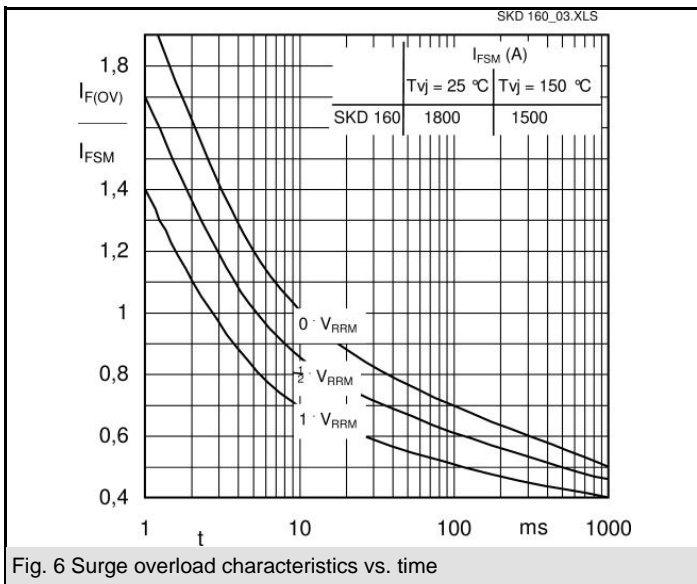
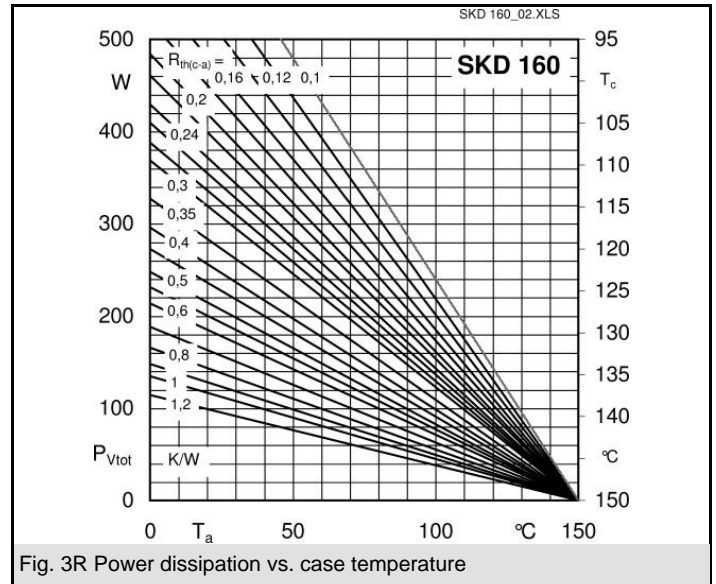
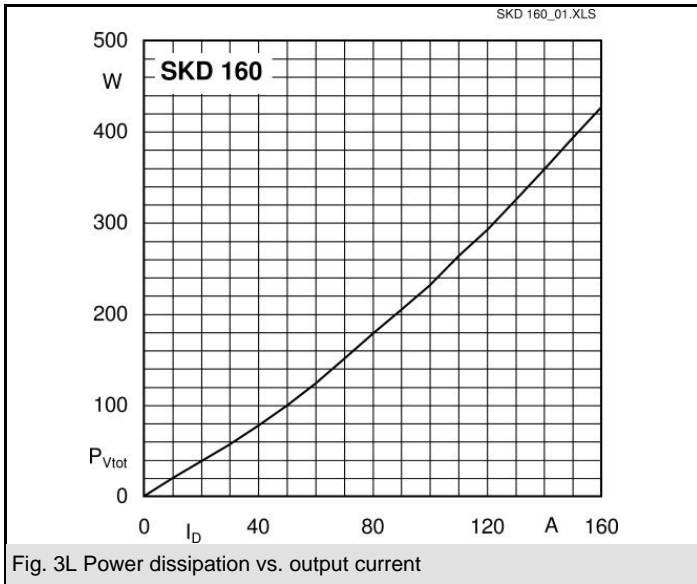

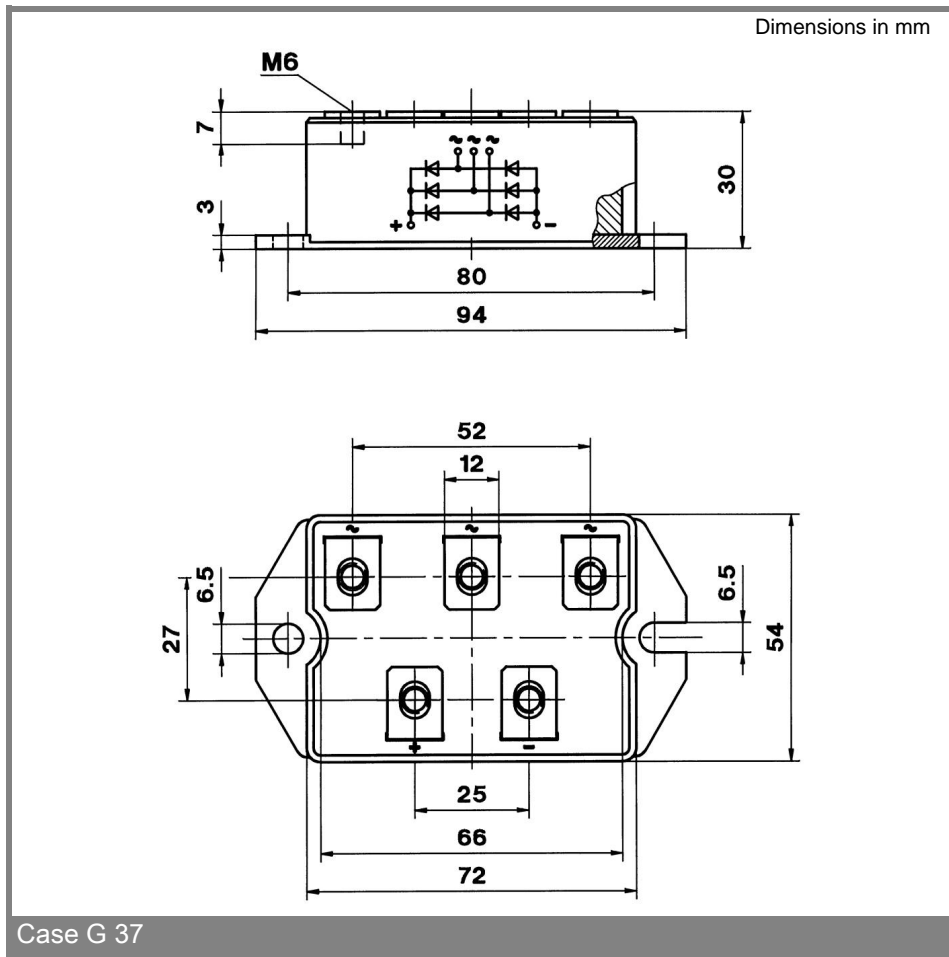

Case G 37

\* The specifications of our components may not be considered as an assurance of component characteristics. Components have to be tested for the respective application. Adjustments may be necessary. The use of SEMIKRON products in life support appliances and systems is subject to prior specification and written approval by SEMIKRON. We therefore strongly recommend prior consultation of our personal.