



# MASTERDRIVE

## Modular Synchronous and Asynchronous Servo Drive System

Technical Specifications



**LUST**

ANTRIEBSTECHNIK

# THE MASTERDRIVE DRIVE SYSTEM

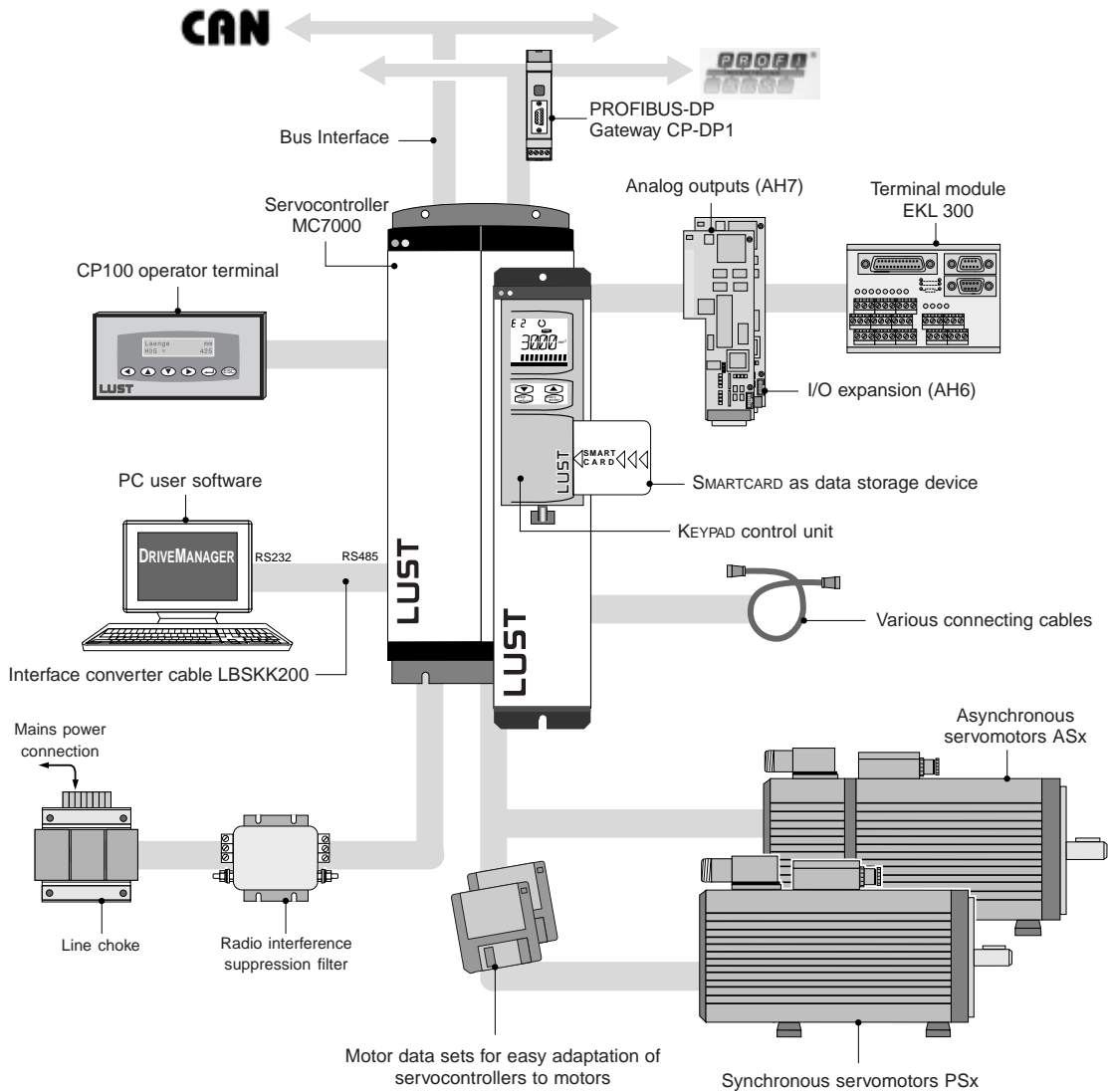

## The Application packages for the MC7000 – tailored to your drive tasks

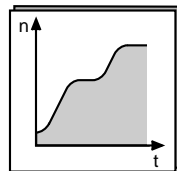

**BASIC**

- Speed control with various reference inputs, e.g. via  $\pm 10\text{ V}$ , fixed speeds or pulse input
- Torque control

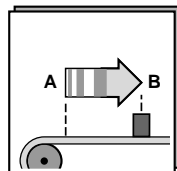

**MOTION**

- Additionally:
- Stepper motor mode
  - Electronic gearing
  - Point-to-point positioning

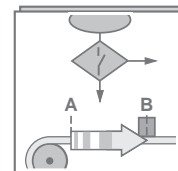

**PosMod**

- Freely programmable single-axe positioning system

For the PosMod application package please contact us to obtain the MASTERDRIVE "MC7000 PosMOD SINGLE-AXLE Positioning System" data specification.

# **MASTERDRIVE**

## Technical Specifications

The following pages give you  
a summary of the  
contents of the MASTERDRIVE Specification Booklet

By referring to the Contents (pages 1-4)  
you will be able to quickly access  
individual chapters and subchapters

# CHAPTER 1

Summary of the contents of the MASTERDRIVE

# CHAPTER 2

Servocontroller MC7000  
 $I_N = 2/4/8/12/16/32/64 \text{ A}$

# CHAPTER 4

Operation



DRIVEMANAGER

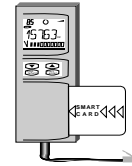

KEYPAD KP100



### Properties

- extended scope of functions by using the Vecon chip set
- minimum unit volume for 2 A, 4 A and 8 A device

### BASIC operation modes: Page

- speed control with external position control 2-7
- speed control with  $\pm 10 \text{ V}$  reference generation 2-8
- speed control with fixed speeds 2-9
- speed control via pulse input 2-10
- torque control 2-11

### MOTION operation modes:

- stepper motor operation 2-14
- electronic gearing 2-15
- point-to-point positioning 2-16

**SMARTCARD** Page 2-20

**MC7000**  
with motor-specific parameters



for application packages  
BASIC + MOTION

mode-guided  
PC surface

for application  
package BASIC

parameter editor

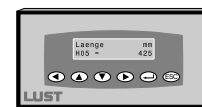

CP100 operator terminal

For BASIC + MOTION  
application packages

Display and input of  
custom variables

Order details:

MC7000, BASIC Page 2-12

MC7000, MOTION Page 2-18

Order details:







DRIVEMANAGER Page 4-3

KEYPAD Page 5-4

OPERATOR TERMINAL Page 5-5

# CHAPTER 3

## Servomotors

		synchronous motor	
size	built-in window	PSM...	Page 3-10
M		□ 55 mm	$M_N = 0.32 \dots 0.9 \text{ Nm}$
N		□ 70 mm	$M_N = 0.55 \dots 2.0 \text{ Nm}$
0		□ 92 mm	$M_N = 0.8 \dots 4.1 \text{ Nm}$
$M_N = 1.3 \dots 6.5 \text{ Nm}$	1		□ 110 mm $M_N = 3.2 \dots 8.6 \text{ Nm}$
$M_N = 3.5 \dots 16.5 \text{ Nm}$	2		□ 140 mm $M_N = 7 \dots 25 \text{ Nm}$
$M_N = 13 \dots 47 \text{ Nm}$	3		□ 190 mm
$M_N = 40 \dots 143 \text{ Nm}$	4		□ 260 mm

**Asynchronous motor**  
ASM... Page 3-9

**Preferred types**  
ASM and PSM  
See page 3-6

# CHAPTER 5

## Encoder cable

## Motor cable

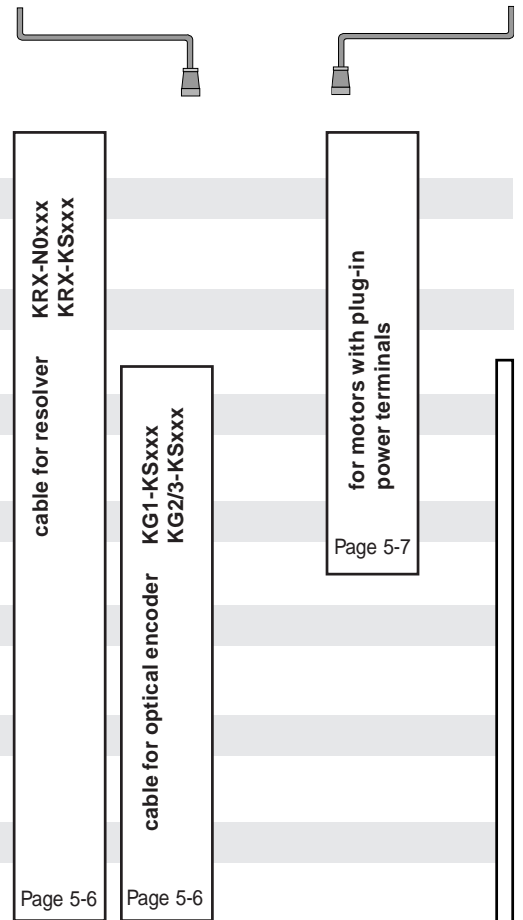

Motors with terminal boxes can be connected with a standard screened motor cable

**Mains filter**  
Page 5-2

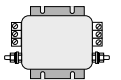

**Line chokes**  
Page 5-3

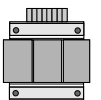

Order details:  
Servomotors ASx and PSx Page 3-2

Order details:  
Mains filter Page 5-2  
Line chokes Page 5-3  
Accessories for PROFIBUS-DP Page 5-6  
Pre-assembled cables Page 5-9  
User information Page 5-12

# CONTENTS

<b>CHAPTER 1</b>	Summary of the contents of MasterDrive	1-1
	Overview of the chapters in the Specification booklet	1-4
	Contents	
<b>CHAPTER 2</b>	Servocontroller <i>MASTERCONTROL</i> MC7000 (2 ... 64 A)	2-1
	Technical Data of MC7000	2-3
	Application package MC7000 <i>BASIC</i>	2-6
	Order details for servocontroller MC7000 <i>BASIC</i>	2-12
	Possible versions of MC7000 <i>BASIC</i>	2-13
	Application package MC7000 <i>MOTION</i>	2-14
	Order details for servocontroller MC7000 <i>MOTION</i>	2-18
	Possible versions of MC7000 <i>MOTION</i>	2-19
	Accessories for servocontroller MC7000	2-20
<b>CHAPTER 3</b>	Synchronous and asynchronous servomotors (0,32 ... 143 Nm)	3-1
	Order details for the servomotors ASx and PSx	3-2
	Versions of the servomotors	3-3
	Basic equipment for the servomotors	3-5
	Preferred types of servomotor	3-6
	Selected system components for the preferred types	3-7
	Typical M-n characteristic curve of the servomotors	3-8
	Technical data of the asynchronous servomotors ASx-xx	3-9
	Technical data of the synchronous servomotors PSx-xx	3-10
	Simplified diagrams of the servomotors	3-12
	Table of dimensions for shaft, flange and base	3-13
	Simplified diagrams of the servomotors (repetition)	3-14
	Table of dimensions for a motor with a self cooling and external cooling system	3-15
	Built-on flange, power and encoder connection	3-16
	Permissible axial and lateral force	3-18
	Technical data of model and shaft packing IP65	3-19
	Technical data of self cooling and external cooling system	3-20
<b>CHAPTER 4</b>	PC user software <i>DRIVEMANAGER</i>	4-1
	Order details for PC user software <i>DRIVEMANAGER</i>	4-3
	Accessories for <i>DRIVEMANAGER</i>	4-4

## CHAPTER 5

Technical data of holding brake	3-22
Accessories for MASTERDRIVE servodrives	5-1
Interference prevention filter	5-2
Line chokes	5-3
Control unit KEYPAD KP100	5-4
Operator terminal CP100	5-5
Accessories for PROFIBUS-DP	5-6
Wiring accessories	5-7
External accessories for the servocontroller	5-8
Prepared encoder cables	5-9
Prepared motor cables	5-10
Motor accessories	5-11
User information	5-12

# CHAPTER 2 SERVOCONTROLLER SERIES MASTERCONTROL MC7000

## Assembly and layout plan MC7402 - MC7408

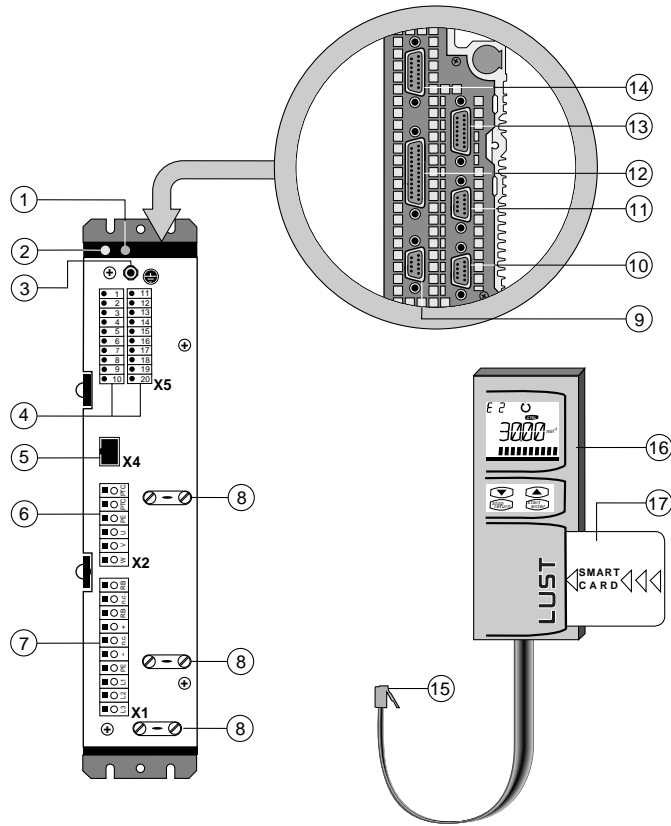

### Legend

No.	Function	No.	Function
1,2	Displays	10/ 11	Connection for application hardware 2 or for bus interface
3	Center point for all earthing lead connections	12	Connection for application hardware 1 or also for CAN bus
4	Control terminals X5: 2 digital inputs, 2 analog inputs <sup>1)</sup> , 1 hardware release, 2 digital outputs, 1 relay output (standard version)	13	Encoder interface 2: encoder simulation and pulse input
5	Socket-contact for control unit KP100	14	Encoder interface 1: for connecting the encoder built into the motor
6	Connection for motor and PTC	15	Plug of the control unit KEYPAD KP100
7	Connection for mains input, DC link and braking resistor	16	Control unit KEYPAD KP100 (can be supplied as an accessory, see Chapter 5)
8	Cable clamps for cable stress reduction and for correct EMC screening	17	SMARTCARD for adapting the controller to the motors and storage medium for all controller parameters
9	Connection for serial interface RS485		

### Directives and Standards

	Conformity with the Machinery Directive 89/392/EEC	all MC7000 devices (MC7402 ... MC7464)
	UL - recognized FILE: E146022	Mark of conformity pending
	Conformity with the basic specifications EN50081-1 (interference emission: residential area) EN50082-2 (interference immunity: industrial area)	all MC7000 devices using appropriate mains when using a corresponding mains filter <sup>2)</sup> (MC7402 and MC7404 with integral mains filter)

<sup>1)</sup> Alternatively, analog inputs can also be used as digital inputs.

<sup>2)</sup> Further information in chapter 5 Accessories



# CHAPTER 2 SERVOCONTROLLER SERIES MASTERCONTROL MC7000

## Assembly and layout plan MC7412 - MC7464

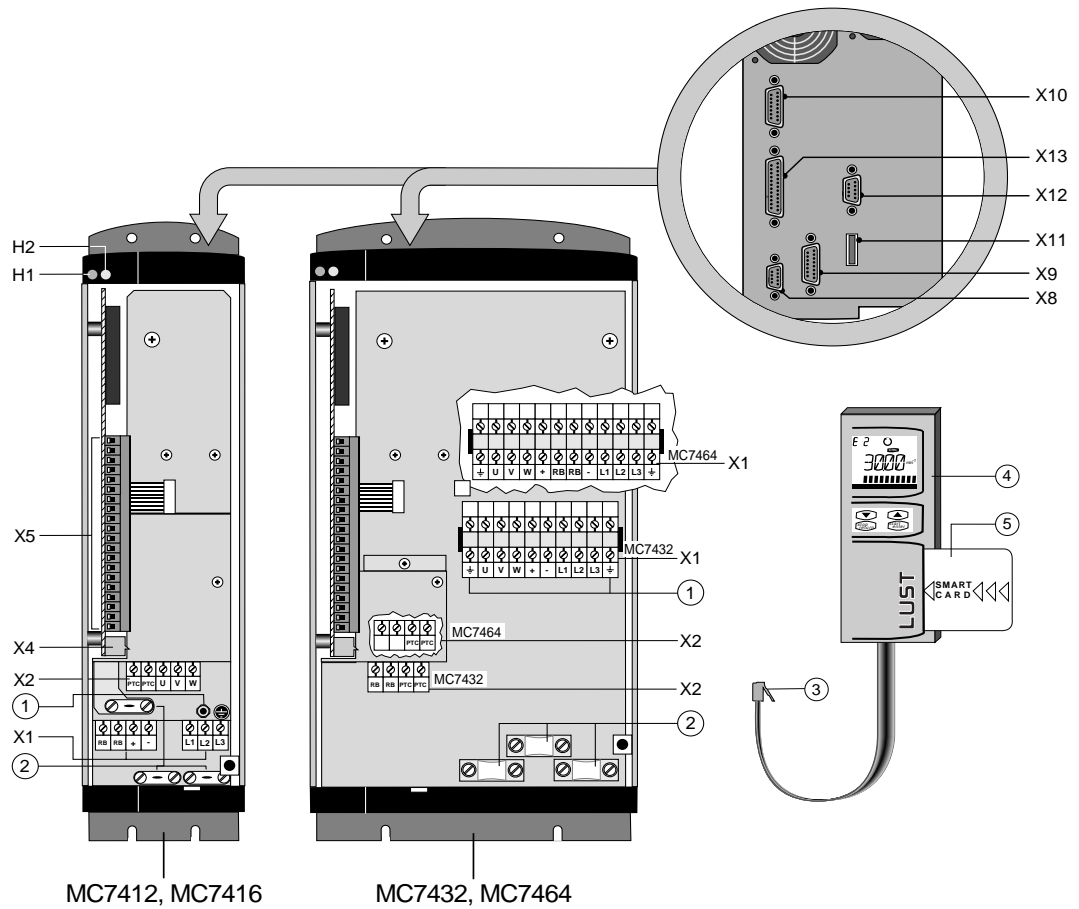

### Legend

No.	Function	No.	Function
H1	Green LED, display	X11*	Connection for application hardware 2,
H2	Yellow LED, fault indication	X12*	(e.g. AH7 with 2 analog outputs) or for bus interface
X1	Connection for mains input, DC link and braking resistor	X13*	Connection for application hardware or (e.g. AH6 for I/O extension) and also for CAN bus
X2	Connection for motor and PTC	1	Center point for earthing lead connection
X4	Socket for KEYPAD	2	Cable clamps for correct EMC screening and cable stress reduction
X5	Control terminals	3	KEYPAD plug
X8	Serial interface RS485	4	Control unit KEYPAD KP100
X9	Encoder interface 2: encoder simulation and pulse input	5	Data memory of SMARTCARD
X10	Encoder interface 1, for connecting the encoder built into the motor		

\* Depending on the version of the device being used.

# CHAPTER 2 TECHNICAL DATA MC7000

Mains filter  
integrated (limit  
value curve A  
industrial area)

## Output motor end

	Des.	Dim.	MC7402	MC7404	MC7408	MC7412	MC7416	MC7432	MC7464	
Rated power (400V mains) <sup>1)</sup>	S	kVA	1.4	2.8	5.5	8.3	11	22	44	
Rated power (460V mains) <sup>1)</sup>	S	kVA	1.6	3.2	5.2	9.5	11	22	50	
Voltage (RMS)	U	V	3 x 400/460							
Contin. current (RMS) (400V/460V) <sup>1)</sup>	I <sub>N</sub>	A	2 / 2	4 / 4	8 / 6.5	12 / 12	16 / 14	32 / 32	64 / 64	
Contin. current (RMS) (400V/460V) <sup>2)</sup>	I <sub>N</sub>	A	1.5 / 1.5	2.5 / 2	4 / 2.5	7.5 / 6	9 / 7	32 / 28	60 / 56	
Pulse current for 10s	I <sub>max</sub>	A	2 · I <sub>N</sub>							<sup>6)</sup>
Switching frequency of the power stage	f <sub>s</sub>	kHz	4, 8, 16 (factory setting 8 kHz <sup>3)</sup> )							
Motor system			asynchronous or synchronous							
Protection against short circuit and earth fault			yes, but not at terminals for braking resistor							
Mains voltage <sup>5)</sup>	U	V	3 x 400/460 ± 10%							
Asymmetry of the mains voltage		%	≤ 3							
Frequency	f	Hz	48 ... 62							
Power factor of the fundamental mode	cosφ <sub>1</sub>		> 0.97							
Efficiency <sup>1) 4)</sup>	η	%	> 95							
Power-loss <sup>1) 4)</sup>	P <sub>V</sub>	W	70	110	200	250	310	600	1000	
Peak braking power with internal braking resistor ( max. duration)	P <sub>SP</sub>	kW	1.9 (17 s)	3.4 (10 s)	6 (3 s)	6 (8 s)	6 (8 s)	–	–	
Cyclical braking operation	P <sub>eff</sub>	W	80	80	40	90	30	–	–	
Minimum ohmic resistance of external braking resistors (design code BR3)	R <sub>min</sub>	Ω	280	160	90	33		13	10	
Peak braking power at external resistance R <sub>min</sub>	P <sub>SPex</sub>	kW	1.9	3.4	6.0	16.8		42	55	
Pulses per revolution at encoder versions G1, G3, G5 (sin/cos encoder)	G1 G3 G5		2048							
Standard pulses per revolution for encoder versions (resolver)R1, R2, R8 (value range)	R1		1024 (128, 256, 512, 1024, 2048, 4096)							
	R2		2048 (256, 512, 1024, 2048, 4096, 8192)							
	R8		3072 (384, 768, 1536, 3072, 6144, 12288)							
Zero pulses per revolution for encoder versions G1, G3, G5 (sin/cos encoder)	G1		1							
	G3 G5		0							
Zero pulses for encoder versions R1, R2, R8 (resolver)	R1		1							
	R2		2							
	R8		3							

<sup>1)</sup> For factory setting 8 kHz switching frequency of the power stage (4 kHz for MC7432 and MC7464).  
All other data applies irrespective of the switching frequency of the power stage!

<sup>2)</sup> At a switching frequency of 16 kHz (8 kHz for MC7432 and MC7464).

<sup>3)</sup> Servocontroller MC7432 and MC7464: factory setting 4 kHz.

<sup>4)</sup> For rated voltage and rated current.

<sup>5)</sup> Operation on an IT network is not permitted.

<sup>6)</sup> Pulse current: **MC7432** at 4 kHz: 2.0 · I<sub>N</sub> (at 8 kHz: 1.3 · I<sub>N</sub>), for **MC7464** at 4 kHz: 1.5 · I<sub>N</sub> (at 8 kHz: 1.0 · I<sub>N</sub>).

# CHAPTER 2 TECHNICAL DATA MC7000

## Ambient conditions

	Des.	Dim.	MC7402	MC7404	MC7408	MC7412	MC7416	MC7432	MC7464
Cooling air temperature (1000 m a.s.l.)	$T_N$	°C	0 ... 40						
Type of cooling			forced cooling						
Relative humidity	rF	%	15 ... 85, non-condensing (VDE0160)						
Power reduction depending on the mounting height	$\Delta P_H$	%	5 % per 1000 m above 1000 m a.s.l., max. 2000 m a.s.l.						
Length of motor lead	$L_{ML}$	m	0 ... 10 m, with power reduction 10 ... 50 m						
Power reduction depending on the length of the motor lead at 4+8 kHz at 16 kHz	$\Delta P_{ML}$	mA/m mA/m	0 25	25 65	50 70			100 150	
Storage temperature	$T_L$	°C	-25 ... +55 (VDE0160)						
Transport temperature	$T_T$	°C	-25 ... +70 (VDE0160)						
Vibration			2 g (IEC 68-2-6)						
Protection type			IP20, VBG4						
Mounting type			vertical wall mounting						
Mass	m	kg	3.7		7.5		10	15	
Dimensions	$\varnothing A$	mm	$\varnothing 4.8$		$\varnothing 5.8$		$\varnothing 7$		
	B	mm	347		360		440		
	C	mm	315		345		425		
	D	mm	65		142.5		190	285	
	E	mm	7.5						
	F	mm	40		100		150	240	
	G	mm	69		- (G = D)				
	H	mm	260		260		290		
	J	mm	112		-				
Minimum mounting distance	K	mm	100		150				
	L	mm	0		0				
	M	mm	0		0				
<p>The diagram shows three views of the LUST MC7000 unit. The front view (left) shows dimensions B, C, D, F, G, and H. The side view (middle) shows dimensions A, E, K, L, M, and U. The rear view (right) shows dimensions J and H. The unit is shown mounted on a wall with a minimum distance K from the wall to the front of the unit. The side view shows the unit is mounted on a wall with a minimum distance M from the wall to the side of the unit. The rear view shows the unit is mounted on a wall with a minimum distance H from the wall to the back of the unit.</p>									

## Mechanics

**Note:** The control unit KEYPAD KP100 must be ordered as a separate item. For further information see chapter 5 Accessories

## CHAPTER 2

# APPLICATION PACKAGES FOR SERVOCONTROLLER MASTERCONTROL MC7000

The application packages enable the MASTERCONTROL MC7000 to perform the motion tasks of the servodrive system even more quickly and simply:

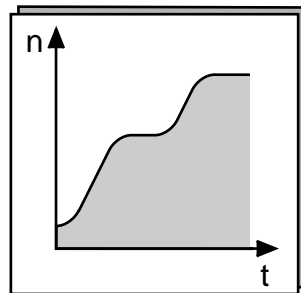

### BASIC

Operation modes:	Page
• speed control with external position control	2-7
• speed control with $\pm 10$ V reference generation	2-8
• speed control with fixed speeds	2-9
• speed control via pulse input	2-10
• torque control	2-11

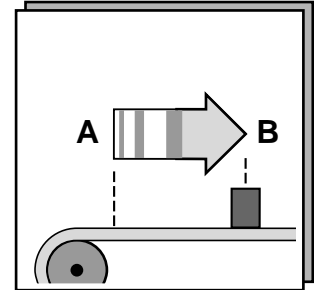

### MOTION

All operation modes of BASIC plus the operation modes:	Page
• stepper motor operation	2-14
• electronic gearing	2-15
• point-to-point positioning	2-16

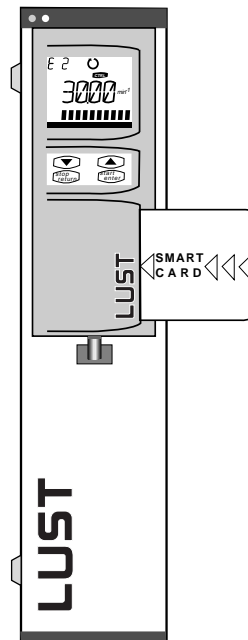

### Tailored to your drive requirements

With the application packages you can use the flexibility of the MC7000 to perform standard motion tasks very quickly using the operation modes. Every application package is equipped with selected hardware and software, which is tuned to specific operation modes.

You require the PC user software **DRIVEMANAGER** if you want to use the application packages for the servocontroller. The functions and scope of the PC user software **DRIVEMANAGER** are described in chapter 4.

## CHAPTER 2 APPLICATION PACKAGE BASIC

The **application package Basic** contains the operation modes speed control with external position control, speed control with  $\pm 10$  V reference generation, speed control with fixed speeds, speed control via pulse input and torque control. These operation modes have the following advantages:

- Only one encoder is required for controlling the torque and the speed and it can also be used for an external position control. This means that no additional encoders and cabling are required.
- Short scanning periods of the control circuits: torque control  $62.5 \mu\text{s}$  and speed control  $250 \mu\text{s}$ . This means that a very high quality of control is achieved as a result.

### Control connections

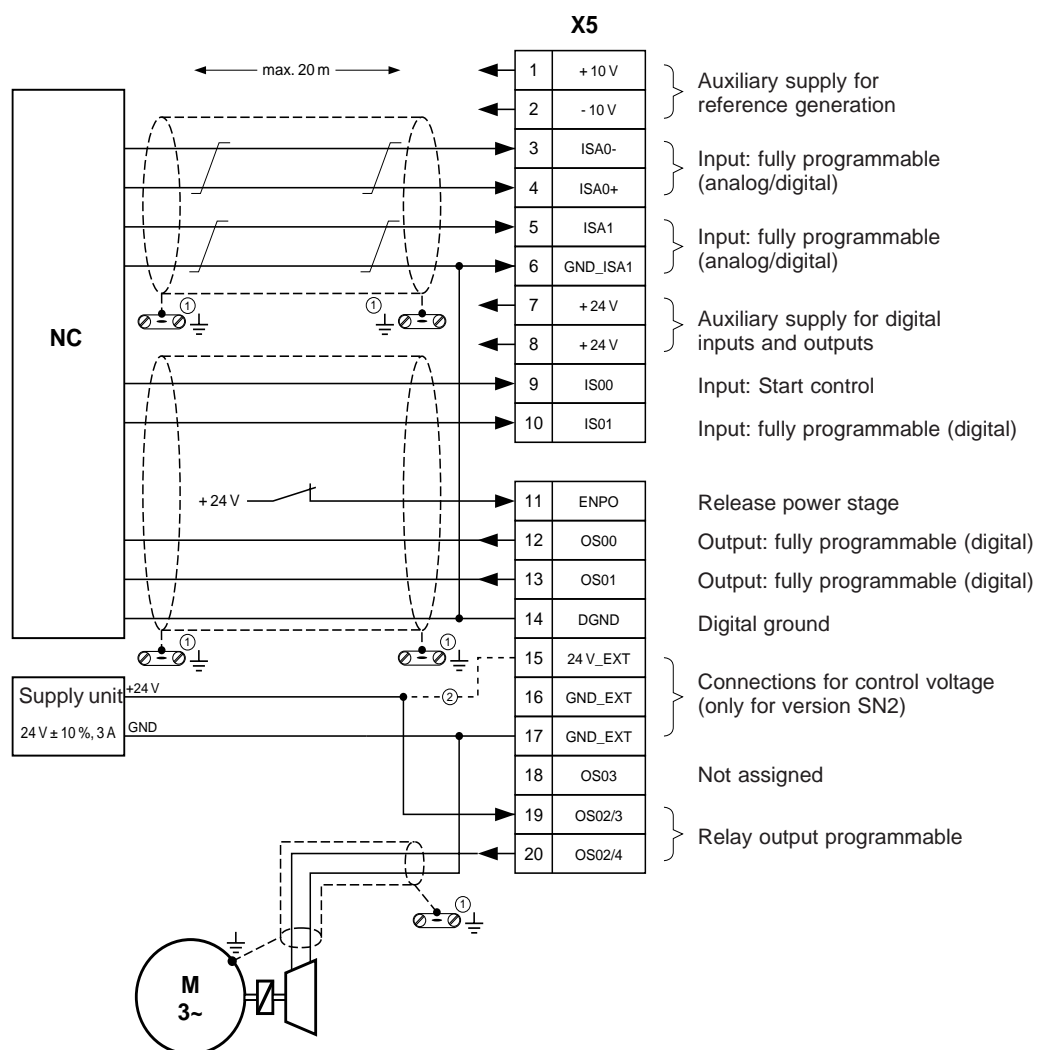

- ① Earth all screens at both ends to the casing over a large surface area using cable clamps!
- ② Only use the control voltage connection for version SN2 (external supply of the control unit)!

# CHAPTER 2 APPLICATION PACKAGE BASIC

**Operation mode  
speed control with  
external position control**

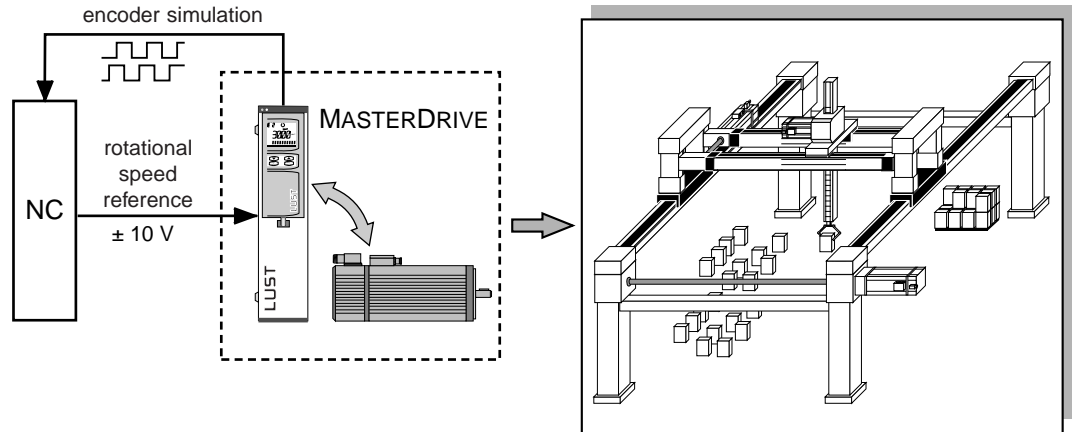

In the operation mode **speed control with external position control** the MC7000 can be directly operated using an NC, which carries out the position control. This operation mode is characterized by the following properties:

- encoder simulation, number of lines on the resolvers parameterizable
- resolution of analog input: 12 bit
- possibility of torque limitation by means of second analog input
- 1 analog input, 3 digital inputs, 1 hardware-release, 2 digital outputs, 1 relay output

**Control connections  
mode-related**

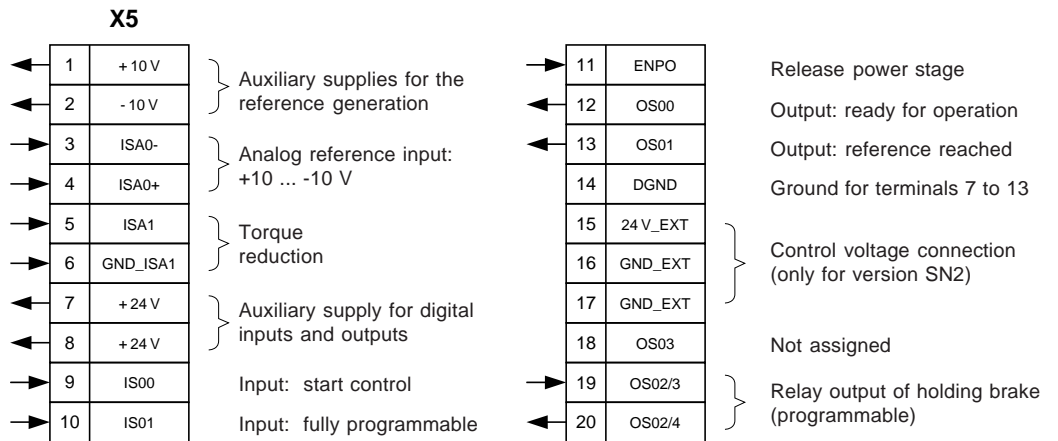

# CHAPTER 2 APPLICATION PACKAGE BASIC

## Operation mode speed control with $\pm 10V$ reference generation

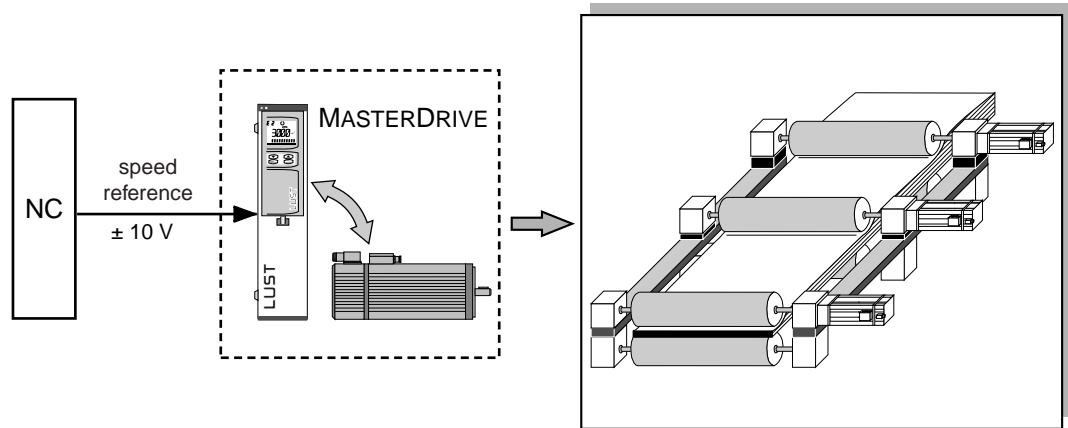

The operation mode **speed control with  $\pm 10V$  reference generation** is characterized by the following properties:

- linear and  $\sin^2$ -shaped ramps to ensure that the movements do not wear out the mechanism
- generation of analog references
- resolution of analog input: 12 bit
- possibility of torque limitation by means of second analog input
- 1 analog input, 3 digital inputs, 1 hardware-release, 2 digital outputs, 1 relay output

## Control connections mode-related

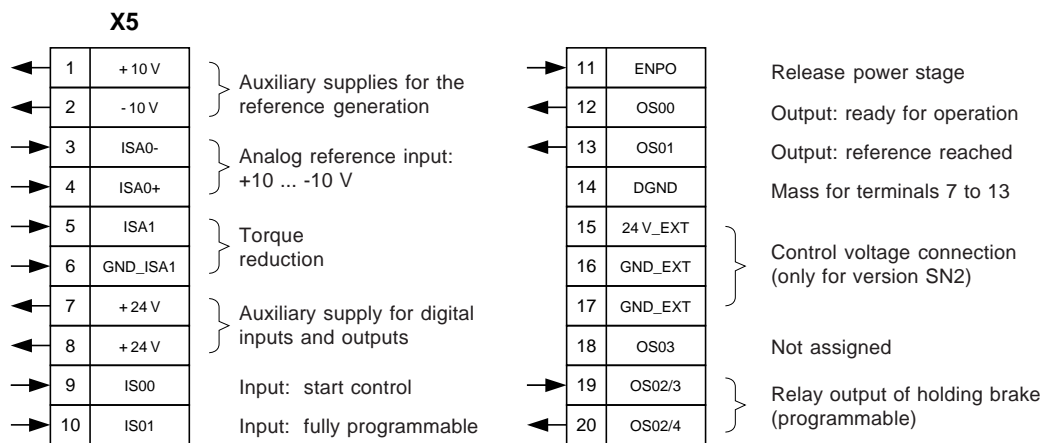

# CHAPTER 2 APPLICATION PACKAGE BASIC

## Operation mode speed control with fixed speeds

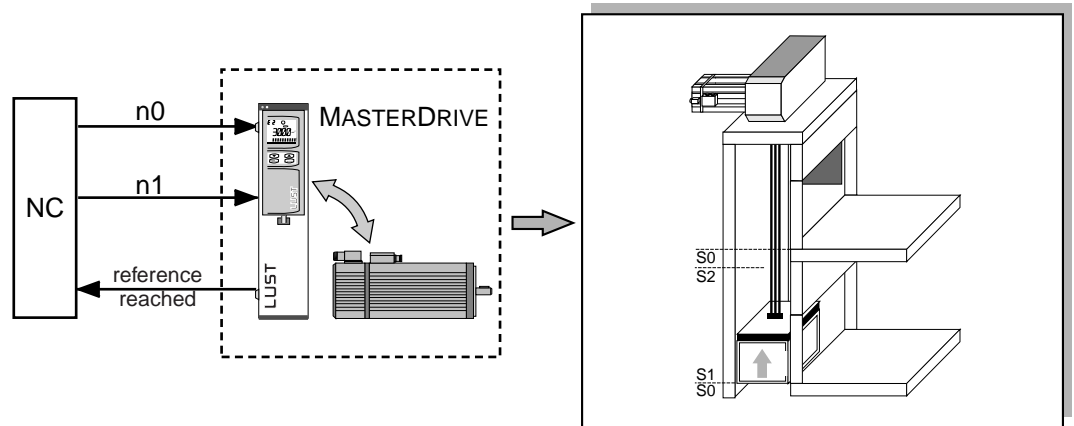

In the operation mode **speed control with fixed speeds** up to four fixed speeds can be filed in the MC7000, which are then selected in running operation by means of two binary coded inputs.

## Control connections mode-related

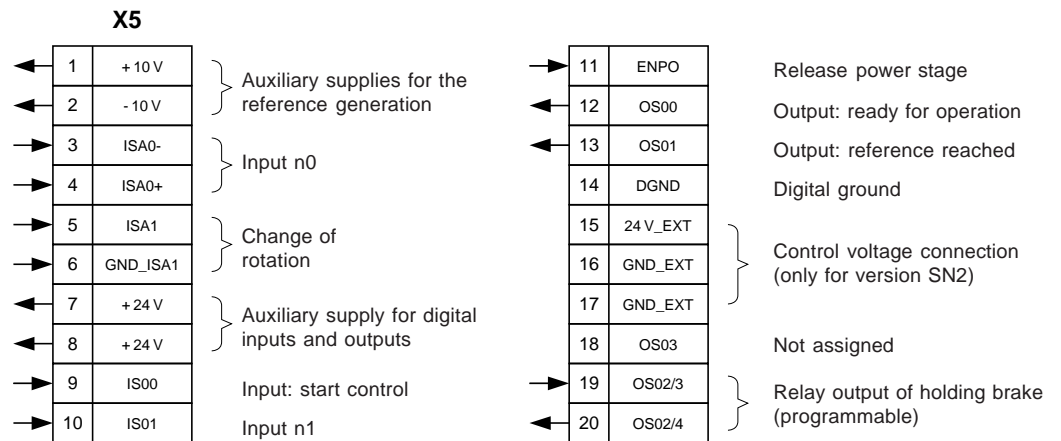

S0 = switch for rotational speed 0 (e.g. stop)

S1 = switch for rotational speed 1 (e.g. high speed)

S2 = switch for rotational speed 2 (e.g. crawl speed)



# CHAPTER 2 APPLICATION PACKAGE BASIC

## Operation mode speed control via pulse input

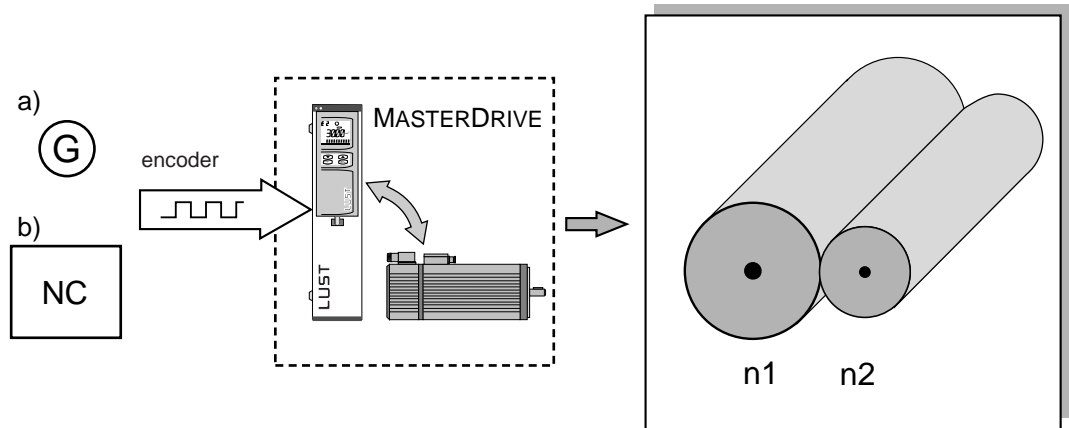

In the operation mode **speed control via pulse input** the MC7000 precisely follows the rotational speed of a master axis. Since no position controller is active, you must note that although the rotational speeds can be synchronized by the master and slave axis, but not the angular positions. The operation mode is characterized by the following properties:

- driven at RS422 level ( $\pm 5\text{ V}$ ) by:
  - signals of a square-wave incremental transmitter,
  - encoder simulation of an MC6000 or MC7000 or
  - pulse-direction signals (virtual master axis)
- precise speed synchronism
- speed ratio adjustable online by 16-bit counter and 16-bit denominator
- 4 digital inputs, 1 hardware-release, 2 digital outputs, 1 relay output

## Control connections mode-related

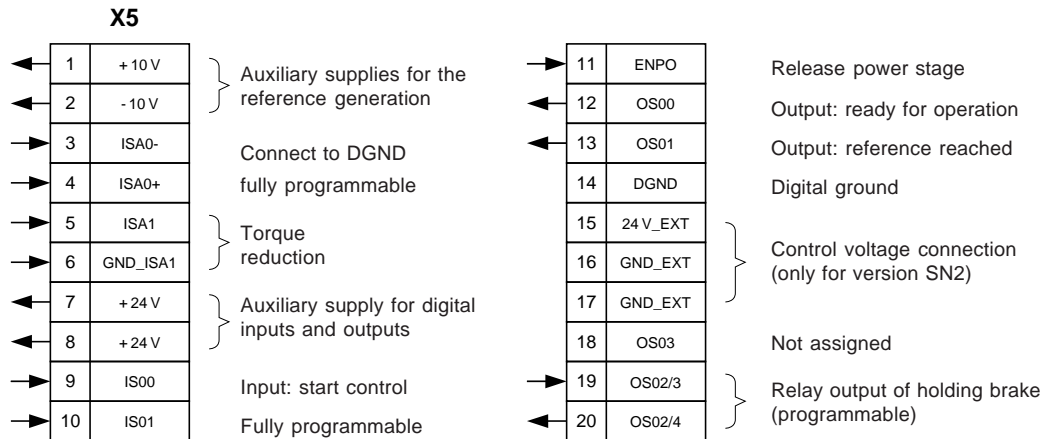

## Encoder connection

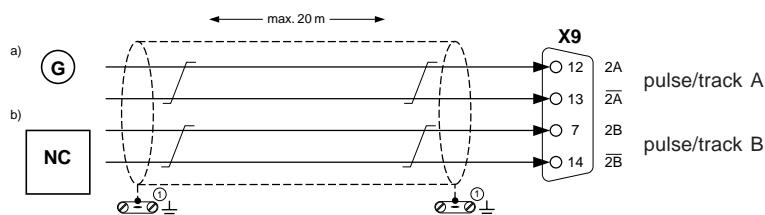

# CHAPTER 2 APPLICATION PACKAGE BASIC

## Operation mode torque control

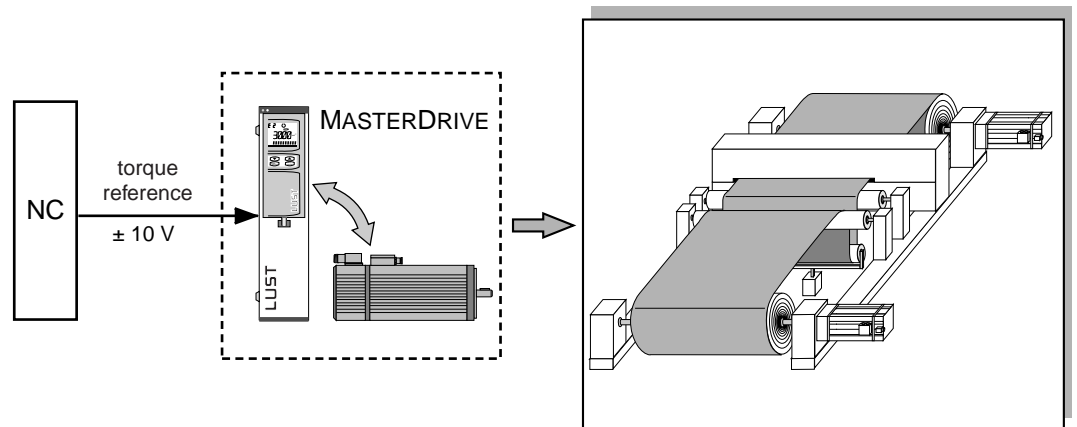

The operation mode **torque control** is a suitable means of controlling the tensile force and has the following properties:

- limitation of the operating speed by internal speed limiting controller
- resolution of the analog input: 12 bit
- 1 analog input, 3 digital inputs, 1 hardware-release, 2 digital outputs, 1 relay output

## Control connections mode-related

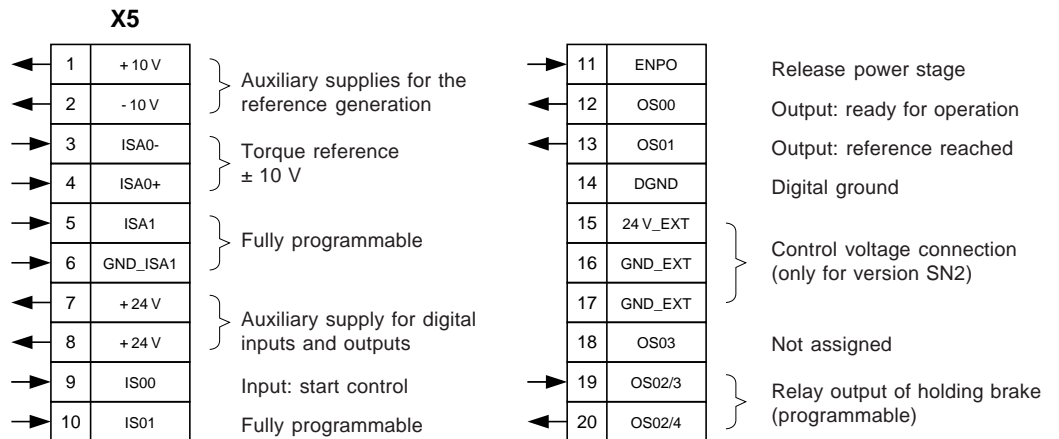

# CHAPTER 2 ORDER DETAILS FOR SERVOCONTROLLER MC7000 BASIC

## General

The functionality of the servocontroller is indicated by the order designation. Other versions differing from the standard package are indicated by adding design codes to the order designation.

Only one of the possible versions shown may be ordered per type of interface (e.g. encoder interface, bus interface etc.).

## Standard version Order or type designation

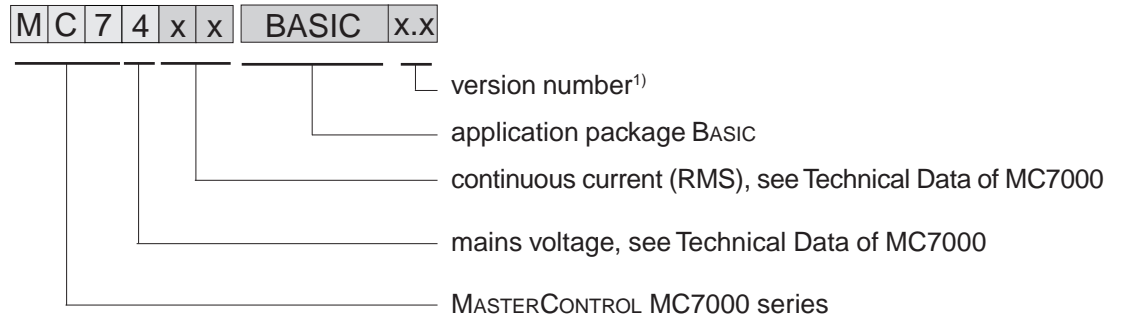

## Standard version:

- encoder interface for analysis of resolvers
- encoder simulation
- for MC7402 and MC7404 with built-in mains filter for complying with the limit value curve of class A (industrial area)
- Instruction Manual

**Note:** The KeyPad KP100 control unit should be ordered as a separate item. For further information see section 5, "Accessories".

## Design codes for deviations from the standard

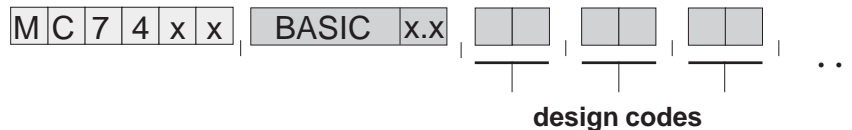

The design codes are separated by a comma and can be written one after the other in any order.

## Example

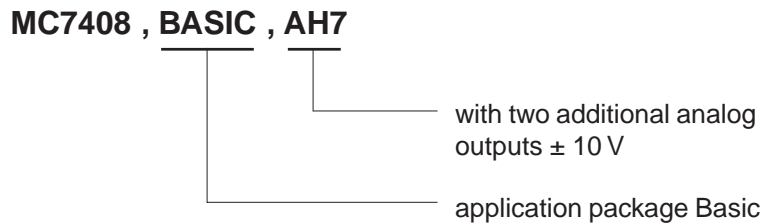

1) The version number indicates the technical version of the application package. If the number is not quoted in the order, we will deliver the current version.

## CHAPTER 2 POSSIBLE VERSIONS of MC7000 BASIC

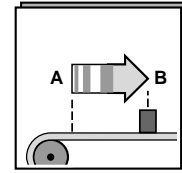
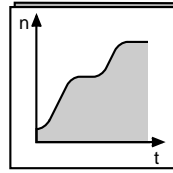

**BASIC**

**MOTION**

Type of interface location	Version code	Brief description
Encoder interface 1	Standard	Encoder interface for analysis of resolvers
	D2	Encoder interface for analyzing the latest model of optical encoders, with incremental sin/cos outputs and additional absolute position information as a single-turn or multi-turn variant
Bus-Interface	Standard	Without bus interface
	C11	CAN bus interface (CAN) with connection system Sub-D 25-pole; for 2 x 9-pole connections use terminal module EKL300 (see chapter 5 Accessories).  The CAN bus interface is also to be used as a connection for the PROFIBUS-DP via the PROFIBUS-DP gateway CP-DP1 (see section 5, "Accessories").
	C15	CANopen with connection via two 9-pin Sub-D connectors. <b>Caution!</b> Version C15 excludes use of version AH7.
Brake chopper version	Standard for MC7402 to MC7416	Brake chopper power electronics with braking resistor in the heat sink
	Standard for MC7432 to MC7464	Brake chopper power electronics (c.d.f. 100 %) to the direct connection of an external braking resistor
	BR3 for MC7402 to MC7416	Brake chopper power electronics (c.d.f. 100 %) to the direct connection of an external braking resistor
Supply of control unit	Standard	With own supply of the control unit (without external 24 V supply)
	SN2	External 24 V supply of the control unit
Control of holding brake	Standard	With relay output for controlling a holding brake
	HB1	With additional output for controlling a holding brake (+ 24 V, max. 2 A), with short circuit and cable fracture monitoring, <b>Caution:</b> Not possible for MC7432 and MC7464!
Application hardware 2	Standard	Without application hardware 2
	AH7	With 2 additional analog outputs, output signal $\pm 10$ V, resolution 12 bit, with connection system Sub-D 9-pole <b>Caution!</b> Version AH7 excludes use of version C15.

There may be only one version at each assignment point.

## CHAPTER 2 APPLICATION PACKAGE MOTION

The **application package MOTION** contains the operation modes:

- stepper motor operation
- electronic gearing
- point-to-point positioning

These operation modes have an integrated position controller with a scanning period of 250  $\mu$ s. This has the following advantages compared with an external position controller:

- no need for encoder analysis in the control system
- reduced amount of cabling required
- minimum down times in the position control circuit resulting in a high quality of control

The application package MOTION can only be operated with the operating software DRIVEMANAGER (see chapter 4).

### Operation mode stepper motor operation

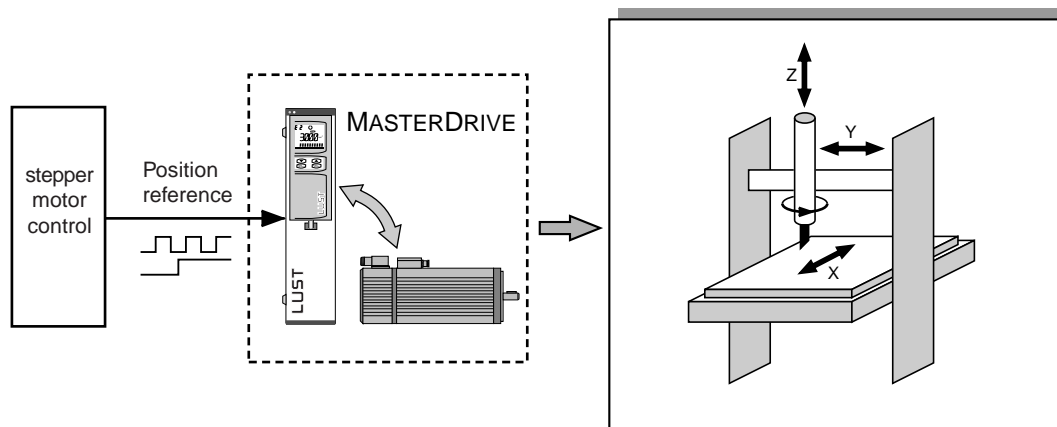

In the operation mode **stepper motor operation** the MC7000 can be directly driven by a stepper motor control system and has the following properties:

- no steps are omitted or left out
- good rotation, even at low rotational speeds
- the maximum step frequency is only limited by the maximum motor speed
- 16 to 1,048,576 steps per revolution
- angle precision to below 0.1°
- reference run with zero-point correction
- limit-switch analysis
- 12 digital inputs, 1 hardware-release, 6 digital outputs, 1 relay output

## CHAPTER 2 APPLICATION PACKAGE MOTION

### Operation mode electronic gearing

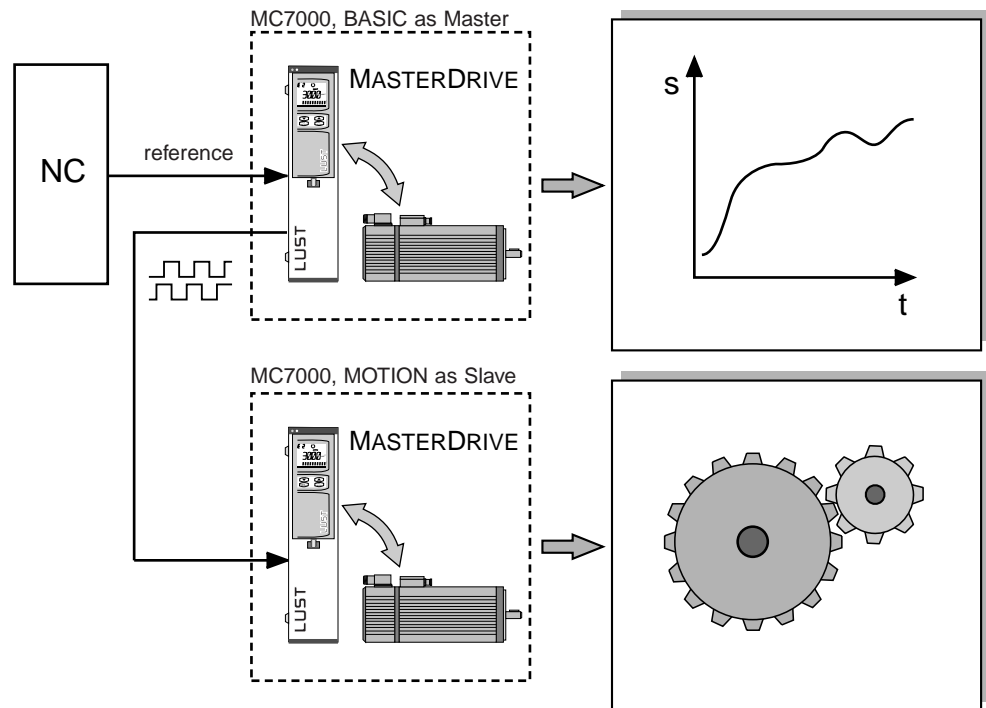

In mechanical engineering electronic gears are increasingly taking over from mechanical gears and line shafts since in many cases they are more precise and cheaper, allow a more flexible design of machinery and shorten the standstill times when changing products.

The MC7000 has the following properties in the operation mode **electronic gearing**:

- control by:
  - signals of a square-wave incremental transmitter
  - encoder simulation of an MC6000 or MC7000
- transmission ratio adjustable online by 16-bit counter and 16-bit denominator
- synchronization precision to below  $0.1^\circ$
- reference run with zero-point correction
- limit-switch analysis
- displacement of the synchronous position (register control)
- 12 digital inputs, 1 hardware-release, 6 digital outputs, 1 relay output

## CHAPTER 2 APPLICATION PACKAGE MOTION

### Operation mode point-to-point positioning

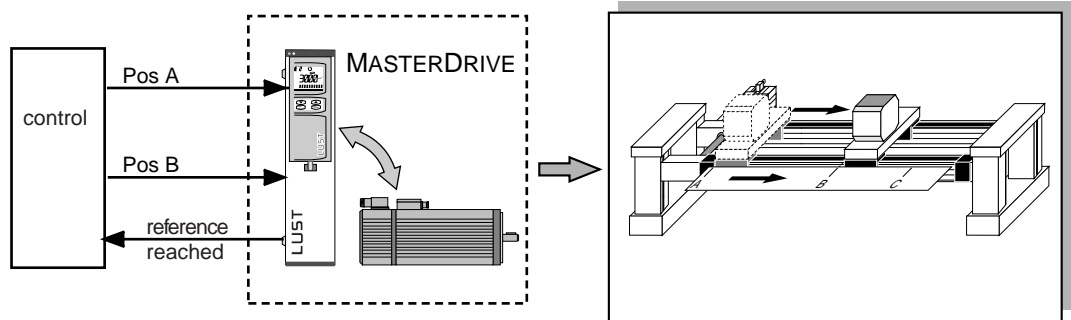

In **point-to-point positioning** mode a controller or the DriveManager generates up to 15 positioning sets which are transferred offline to the MC7000. The controller selects the current positioning set by way of four binary coded inputs.

In the operation mode **point-to-point positioning** the MC7000 has the following properties:

- a maximum of 15 positioning sets can be selected for absolute or relative positioning
- linear and  $\sin^2$ -shaped speed ramps to ensure that the movements do not wear out the mechanism
- reference run
- limit-switch analysis
- 12 digital inputs, 1 hardware-release, 6 digital outputs, 1 relay output

### Positioning and sequential program

If you find the functions of the operation mode **point-to-point positioning** are not enough to perform a certain drive task, we are prepared to create a positioning and sequential program for your particular application. Please let us know if you are interested in such an offer.

### For entering the positioning sets with target position, speed and acceleration

Set no.	Dest. position	Mode	Speed [rpm]	Acceleration [%]
1	1500	Absolute	3000	80
2	2000	Absolute	1000	50
3	1000	Absolute	3000	100
4	3500	Absolute	3000	50
5	0	Absolute	2000	50
6	-1000	Absolute	1000	50
7	0	Absolute	0	0

It is not possible to enter the point-to-point positioning using the KEYPAD.

# Chapter 2 APPLICATION PACKAGE MOTION

## Control connections for point-to-point positioning

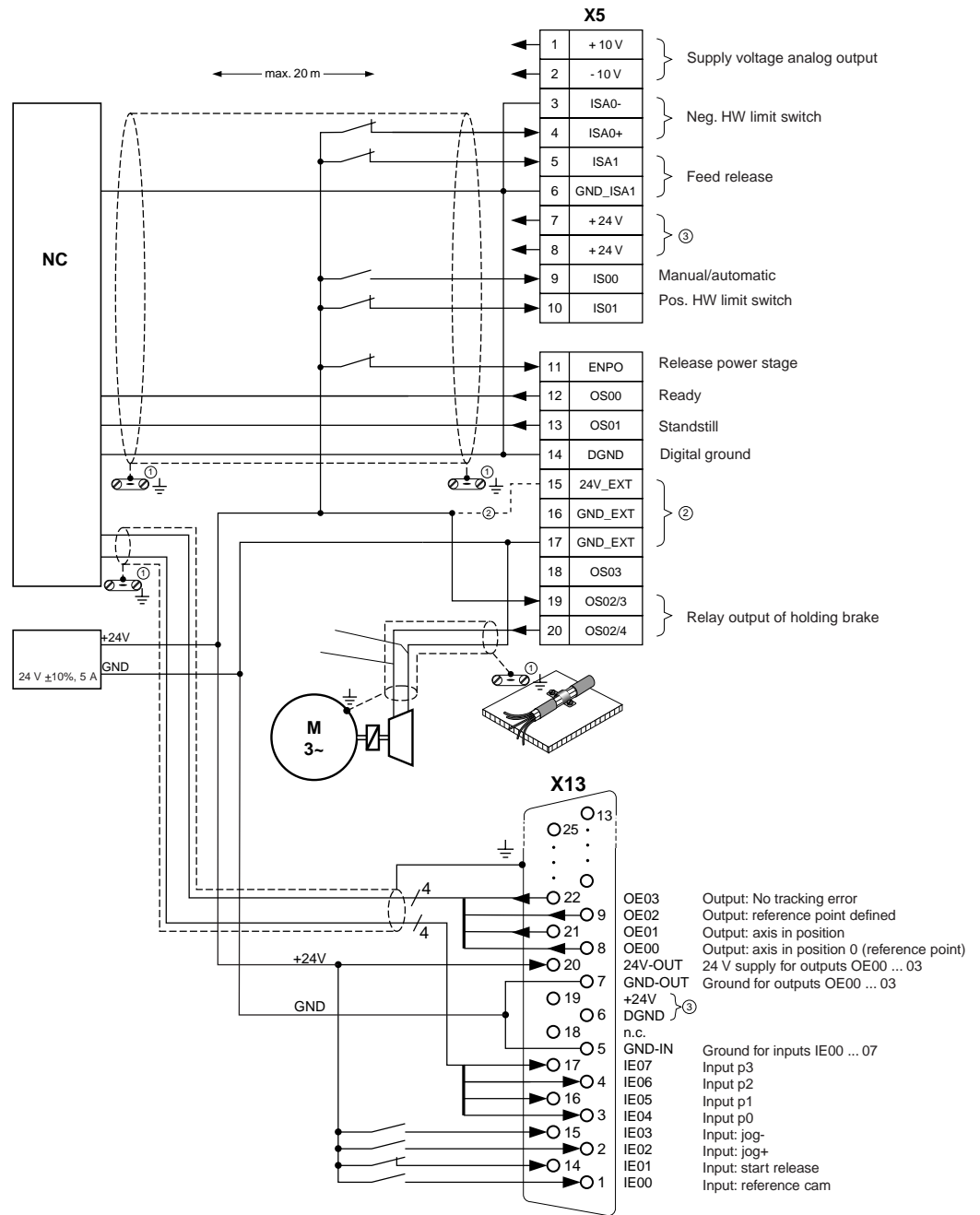

- ① Earth all screens at both ends to the casing over a large surface area using cable clamps!
- ② Only use the control voltage connection for version SN2 (external supply of the control unit)!
- ③ The internal 24 V of the servocontroller is used to supply inputs and outputs at X5 (max. loading capacity: 200 mA in total).



# CHAPTER 2 ORDER DETAILS FOR SERVOCONTROLLER MC7000 MOTION

## General

The functionality of the servocontroller is characterized by the order designation. Other versions differing from the standard package are indicated by appendices of design codes in the order designation.

In the versions shown only one version can be ordered per terminal location (e.g. encoder interface, bus interface etc.).

## Order or type designation (Standard version)

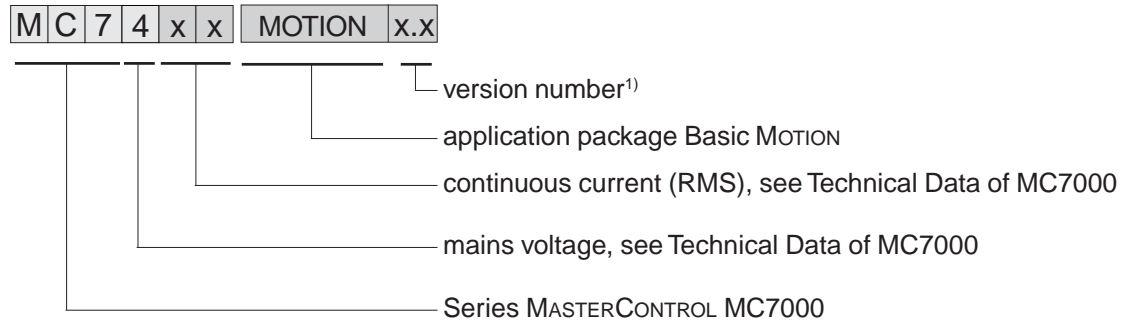

## Standard version:

- encoder interface for analysis of resolvers
- encoder simulation
- 12 digital inputs, and 6 digital outputs
- limit-switch analysis
- for MC7402 and MC7404 with built-in mains filter for complying with the limit value curve of class A (industrial area)
- instruction Manual

**Note:** The KeyPad KP100 control unit should be ordered as a separate item. For further information see section 5, "Accessories".

## Design codes for deviations from the standard

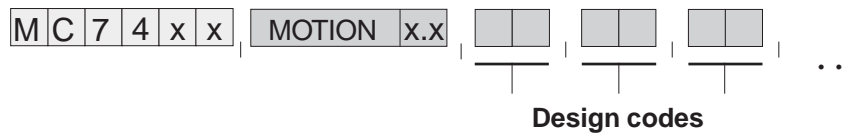

The design codes are separated by a comma and can be written one after the other in any order.

## Example

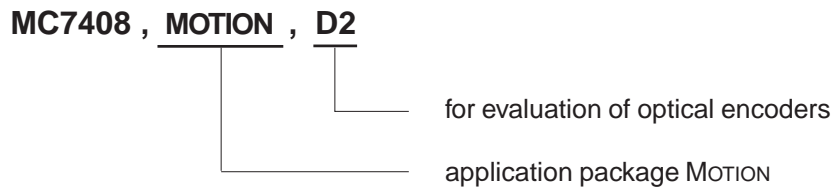

1) The version number indicates the technical version of the application package. If the number is not quoted in the order, we will deliver the current version.

## CHAPTER 2 POSSIBLE VERSIONS OF MC7000 MOTION

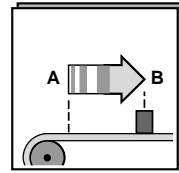
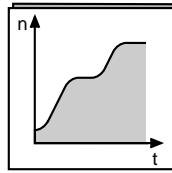

**BASIC**

**MOTION**

Type of interface location	Version code	Brief description
Encoder interface 1	Standard	Encoder interface for analysis of resolvers
	D2	Encoder interface for analyzing the latest model of optical encoders, with incremental sin/cos outputs and additional absolute position information as a single-turn or multi-turn variant
Bus-Interface	Standard	Without bus interface
	C11	CAN bus interface (CAN) with connection system Sub-D 25-pole; for 2 x 9-pole connections use terminal module EKL300 (see chapter 5 Accessories)  The CAN bus interface is also to be used as a connection for the PROFIBUS-DP via the PROFIBUS-DP gateway CP-DP1 (see section 5, "Accessories").
	C15	CANopen with connection via two 9-pin Sub-D connectors. <b>Caution!</b> Version C15 excludes use of version AH7.
Brake chopper version	Standard for MC7402 to MC7416	Brake chopper power electronics with braking resistor in the heat sink
	Standard for MC7432 to MC7464	Brake chopper power electronics (c.d.f. 100 %) to the direct connection of an external braking resistor
	BR3 for MC7402 to MC7416	Brake chopper power electronics (c.d.f. 100 %) to the direct connection of an external braking resistor
Supply of control unit	Standard	With own supply of the control unit (without external 24 V supply)
	SN2	External 24 V supply of the control unit
Control of holding brake	Standard	With relay output for controlling a holding brake
	HB1	With additional output for controlling a holding brake (+ 24 V, max. 2 A), with short circuit and cable fracture monitoring, <b>Caution:</b> Not possible for MC7432 and MC7464!
Application hardware 2	Standard	Without application hardware 2
	AH7	With 2 additional analog outputs, output signal $\pm 10$ V, resolution 12 bit, with connection system Sub-D 9-pole <b>Caution!</b> Version AH7 excludes use of version C15.

There may be only one version at each assignment point.

**Note:** Installation of the DRIVEMANAGER operating software (chapter 4) is necessary for commissioning of the MOTION application package

# CHAPTER 2 ACCESSORIES FOR THE MC7000

## Accessories for servo controller retrofit

Order description	Brief description
KP100	multifunctional control unit <b>KEYPAD</b> for operation of the servo controller and frequency inverter, also refer to chapter 5 Accessories
ZSC	<b>SMARTCARD</b> without data content, for storing and transfer of device settings on other MC7000 servocontrollers
0808.ZSC, xxx-xx-xxxx	<b>SMARTCARD</b> for adapting the MC7000 servocontroller to motors in the ASx and PSx ranges upto software version 1.65
0808.ZDK, xxx-xx-xxxx	Diskettes for adapting the MC7000 servocontroller to motors in the ASx and PSx ranges from software version 1.65

## SMARTCARD or diskette for servomotors

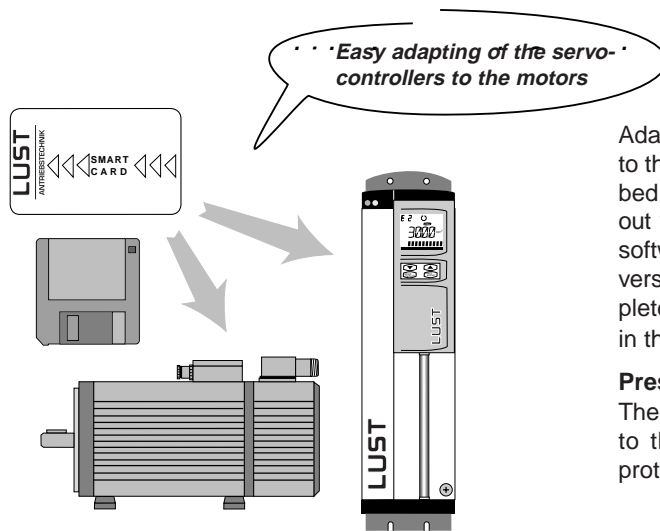

Adaptation of the MC7000 servocontroller to the ASx and PSx motor ranges described in this specification booklet is carried out via a **SMARTCARD** with models up to software 1.65 or via diskette with newer versions. All motor parameters and complete controller dimensioning are stored in these formats

### Presetting the SMARTCARD:

The maximum installation torque is limited to the motor's rated value in order to protect the installation.

## Order designation SMARTCARD

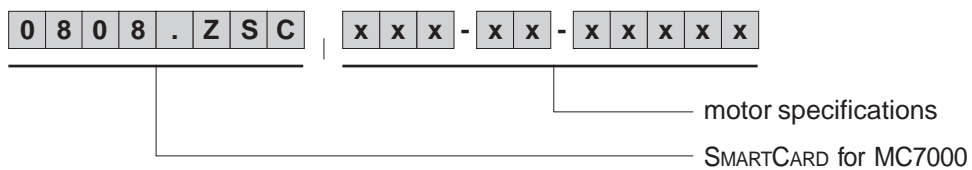

## Example for servomotor PSM-11-20R83-012

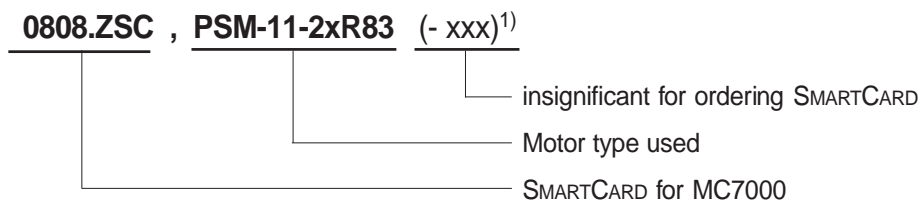

<sup>1)</sup> x = specification insignificant, places need not be given

**Note:** The **SMARTCARD** is write protected for security reasons. Please order a separate **SMARTCARD ZSC** not containing data for storing remaining device settings. The **DRIVEMANAGER** from version 1.0 is necessary in order to read the information on the controller diskette. The content of supply already contains the disk set with motor data sets for PSM motors with R8 and G5 encoders and also for ASM motors with R2, G1 or G5 encoders.

# CHAPTER 3 SYNCHRONOUS AND ASYNCHRONOUS SERVOMOTOR SERIES

## Introduction

The synchronous and asynchronous Servomotors are designed to a uniform pattern for best results, especially for the MASTERCONTROL MC6000 and MC7000 Servocontroller in mind.

From a design point of view the Servomotors differ basically in their rotor principle:

- squirrel-cage rotor in ASx asynchronous Servomotors
- permanent magnet rotor in PSx synchronous Servomotors

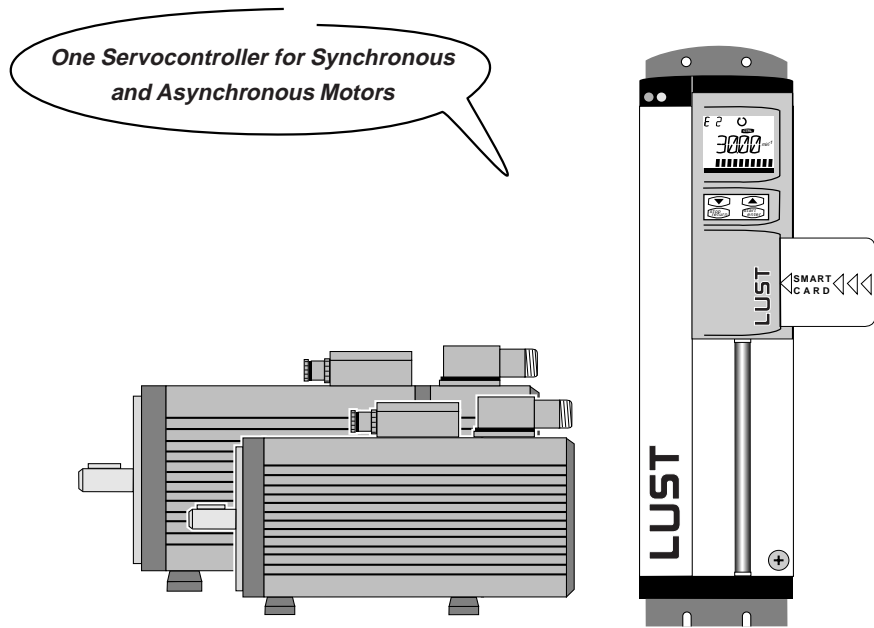

## Advantages

Features of the asynchronous ASx Servomotors	Features of the synchronous PSX Servomotors
most cost effective solution for applications in which the larger physical size is acceptable	compact design with no rotor losses
large speed range with constant maximum power output	low moment of inertia of rotor so excellent dynamic response
maintenance-friendly	low maintenance (brushless)

# CHAPTER 3 ORDERING ASx AND PSx SERVOMOTORS

## Introduction

The specific Servomotor model is indicated by the order designation. Each design code has a particular meaning, refer to Servomotor design codes. Design codes are also used for non-listed Servomotors.

Only one design option can be ordered per code CHAPTER, (eg voltage, encoder system etc).

## Order/type designation

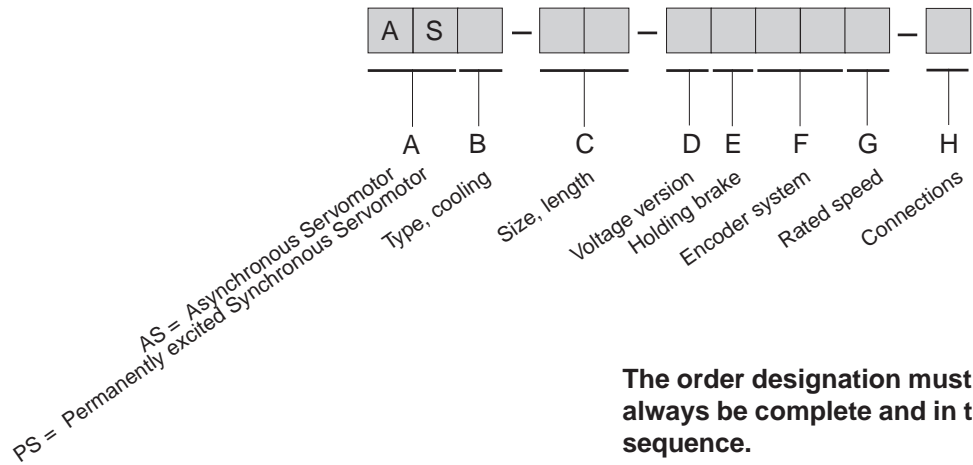

## Example

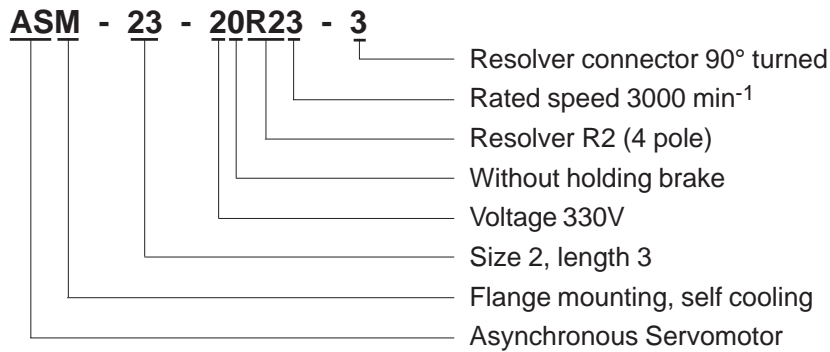

## Design code for options and customer-specific version

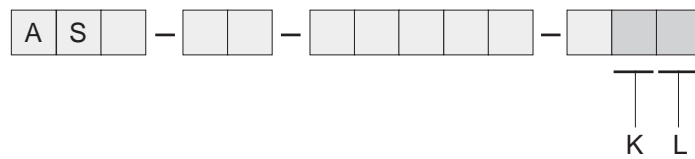

**Code CHAPTERS K and L are only used where there is a deviation from the standard version. See table "Servomotor design codes".**

# CHAPTER 3 SERVOMOTOR DESIGN CODES

	Code CHAPTER	Design Code	Description Motor Type	
<b>Type, Cooling</b>	B	M	Flange with self cooling	ASx-1x to 3x, PSx-Mx to 2x
		F	Flange with forced cooling	ASx-1x to 3x, PSx-1x to 2x
		H	Flange, foot with self cooling	ASx-1x to 4x, PSx-1x to 2x
		V	Flange, foot with forced cooling	ASx-1x to 4x, PSx-1x to 2x
<b>Size, Length</b>	C	Mx	Installation 55, 4 units long	PSM-Mx
		Nx	Installation 72, 3 units long	PSM-Nx
		0x	Installation 92, 4 units long	PSM-0x
		1x	Installation 110, 5 units long	ASx-1x, PSx-1x
		2x	Installation 140, 5 units long	ASx-2x, PSx-2x
		3x	Installation 190, 4 units long	ASx-3x
		4x	Installation 260, 3 units long	ASx-4x
<b>Voltage Version</b>	D	2	Rated voltage of motors 330V	All
<b>Holding Brake</b>	E	0	Without holding brake	All
		1	With permanently excited holding brake	All (Observe max speed)
<b>Encoder System</b>	F	00	Without encoder system	All
		R1	Resolver (2 pole)	All
		R2	Resolver (4-pole), preferred type for ASx	All ASx
		R8	Resolver (6-pole), preferred type for PSx	All PSx
		G1	Incremental encoder with sin/cos outputs	All ASx
		G3	Incremental encoder with sin/cos outputs as multi turn encodersix 0x	All ASx and PSx from size 0x
		G5	Incremental encoder with sin/cos outputs as single turn encoder <sup>1)</sup>	All ASx and PSx from size 0x
		K1	Resolver (2 pole), with mounting flange <sup>2)</sup>	All ASM, ASH, PSM, PSH
		K2	Resolver (4 pole), with mounting flange <sup>2)</sup>	All ASM, ASH
K8	Resolver (6 pole), with mounting flange <sup>2)</sup>	All PSM, PSH		

<sup>1)</sup> The new encoder type G5 replaces type G2. It is electrically and mechanically compatible, however another SMARTCARD is necessary.

<sup>2)</sup> For mounting a second encoder, eg (Heidenhain ROD426 or Stegmann DG60). The coupling is not included.

## CHAPTER 3 SERVOMOTOR DESIGN CODES

Code CHAPTER	Design Code	Description	Motor Type
Rated Speed  G	1	Rated speed 1500 min <sup>-1</sup>	Please observe the technical specifications of the Servomotors.
	2	Rated speed 2000 min <sup>-1</sup>	
	3	Rated speed 3000 min <sup>-1</sup>	
	4	Rated speed 4000 min <sup>-1</sup>	
	6	Rated speed 6000 min <sup>-1</sup>	

Connections  H	0	Power connection: terminal box Resolver connector: plug-in, outlet straight Encoder connector: plug-in, outlet straight or 90°	All from size 0x
	3	Power connection: terminal box Resolver connector: plug-in, outlet 90° with encoder choose design code 0	All from Size 0x with resolver
	2	Power connector: plug-in, outlet straight Resolver connector: plug-in, outlet straight Encoder connector: plug-in, outlet straight or 90°	PSx-Mx, PSx-Nx, PSx-0x, PSx-1x and ASx-1x
	4	Power connector: plug-in, outlet 90° Resolver connector: plug-in, outlet 90° Encoder connector: plug-in, outlet straight or 90°	PSx-Mx, PSx-Nx, PSx-0x, PSx-1x and ASx-1x
	5	Power connector: plug-in, outlet 90° Resolver connector: plug-in, outlet straight Encoder connector: plug-in, outlet straight	

**Notes:**

- In all encoders G1, G3 and G5 the connector can be directed either straight or at 90°.
- For matching power connectors and for cable see CHAPTER 5 Accessories.

Options and customer-specific versions  K	0	Standard, shaft end A side with feather key	All
	1	Shaft end A side without feather key	All
	2	With radial shaft seal IP65	All (Observe maximum speed)
	4	Design code 1 and 2	All (Observe maximum speed)

Options and customer-specific versions  L	0	Standard model	All
	1	Vibration to ISO 2373 R	All ASx
	2	Vibration to ISO 2373 S	All PSx
	3	Radial and axial run-out to DIN 42955 R	All
	4	Design code 1 and 3	All ASx
	5	Design code 2 and 3	All PSx

**General Technical Specifications**

Features \ Type	ASx Asynchronous Servomotors	PSx Synchronous Servomotors
Motor type	Asynchronous motor	Permanently excited synchronous motor
Magnet	-	Neodymium-iron-boron
Type (DIN 42948)	IM B35, IM B5, V1, V3	
Protection (DIN 40050)	IP65, Shaft Seal IP64 (Option IP65)	
Insulation Class	Insulation Class F to VDE0530 Windings over-temperature $\Delta t = 105$ , coolant temperature $t_u = +40$ °C	
Cooling	Self cooling (IC 0041) IP65 Forced cooling (IC 0641) IP44, 54	
Finish	RAL 9005 (black)	
Shaft end on the A (D) side	Cylindrical shaft end DIN 748, feather key and feather key groove DIN 6885, clearance k6 <sup>1)</sup>	
Flange dimension	DIN 42948 and IEC 72	
Eccentricity, concentricity and radial run-out DIN 42955	Tolerance N (normal) R (reduced) to order	
Vibration level ISO 2373	Step N, R available as option	Step R, S available as option
Thermal monitoring of motor	PTC Thermistor in Stator Windings	
Torque loading	<p>In order to eliminate the risk of thermal overload of motors the effective torque load must not be greater than the rated torque of the Servomotor</p> $M_{\text{eff}} = \sqrt{\frac{\sum M_n^2 \times t_n}{t_{\text{ges}}}} \quad M_{\text{eff}} \leq M_N$	
Maximum pulse torque	Typically 2 to 5 times rated torque depending on controller allocation. 3 to 5 times the rated torque is only permissible for 0.2 s maximum only.	
Bearing life	The average life is 20,000 hours under rated conditions ( $M_{\text{max}} \leq M_N$ ).	
Connections for motor, thermistor and holding brake	Threaded bolts in terminal box, connectors to order	
Encoder system connection	Signal Connector (no mating connector)	

**Connection**

<sup>1)</sup> For the motor types PSM-Nx is the clearance j6.



## CHAPTER 3 PREFERRED TYPES OF SERVOMOTORS

From the wide range of design options for synchronous and asynchronous motors, we have selected the most common here and specified them as preferred types.

### Use of preferred motors

Benefits:

- High availability based on module stocking
- Fixed delivery period of **maximum** 3 weeks for batch sizes up to 10 (motors with custom design options 6 to 8 weeks)

### Design and properties

- Resolver type encoder system
- Flange with self-cooling
- Without holding brake
- Plug-in power supply for synchronous servomotors
- Asynchronous motor with terminal box
- Large speed setting range on asynchronous machines
- Low moments of rotor inertia, producing optimum dynamics



### Technical data of the preferred types

Self-cooling	$M_0$ [Nm]	$M_N$ [Nm]	$P_N$ [kW]	$I_0$ [A]	$I_N$ [A]	$n_N, n_{max}$ [rpm]	$J_L$ [kgcm <sup>2</sup> ]	$m$ [kg]
PSM-M4-20R86-4	1	0.8	0.5	1.6	1.7	6000	0.45	1.8
PSM-N4-20R84-4	0.65	0.6	0.25	0.9	0.9	4000	0.22	1.5
PSM-N6-20R84-4	2.3	2.0	0.83	2.4	2.0	4000	0.57	2.9
PSM-03-20R83-4	2.8	2.3	0.72	1.8	1.5	3000	5.3	4.2
PSM-04-20R83-4	4.8	4.1	1.3	3.7	3.2	3000	7.4	5.3
PSM -13-20R83-4	7.5	5.6	1.7	5.1	3.8	3000	11.7	10.1
PSM-23-20R83-0	15.5	11.2	3.5	10.1	7.3	3000	28	15.5

ASM-12-20R23-0	2	1.7	0.54	2.1	1.8	3000/12000	3.7	7.5
ASM-22-20R23-0	5.6	4.7	1.5	4.7	3.9	3000/12000	14.4	13.2
ASM-25-20R22-0	15	13	2.7	7.7	6.6	2000/8000	38.4	24
ASM-32-20R21-0	20	17	2.7	8.2	6.8	1500/8000	90	33
ASM-34-20R21-0	42	35	5.5	15.1	12.6	1500/8000	209	56.6
ASM-43-20R21-0	85	70	11	37	30.4	1500/8000	960	135

# CHAPTER 3

# SELECTED SYSTEM COMPONENTS FOR THE PREFERRED TYPES

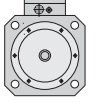
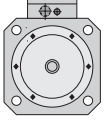
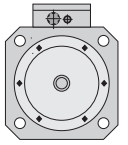
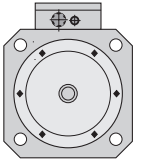
Installation window [mm]		Preferred type	Drive controller <sup>3)</sup>	Peak torque of drive package	Acceleration time <sup>1)</sup>	Mains filter <sup>2)</sup>	Line choke <sup>2)</sup> (recommended)	Motor cable <sup>2)</sup> (only up to size 1)	Braking resistors internal/external
		Servomotor	Drive controller <sup>3)</sup>	M <sub>max</sub> [Nm]	t <sub>a</sub> [ms]				
<input type="checkbox"/> 55		PSM-M4-20R86-4	MC7402 MC7404	1.9 3.2	15 9	internal	DND 6	KM1-KS005	internal
<input type="checkbox"/> 70		PSM-N4-20R84-4 PSM-N6-20R84-4	MC7402 MC7402 MC7404	2.4 4 8	4 6 3	internal internal internal	DND 6 DND 6 DND 6	KM1-KS005 KM1-KS005	internal internal internal
<input type="checkbox"/> 92		PSM-03-20R83-4 PSM-04-20R83-4	MC7402 MC7404	6.1 9.2 10.3 16.4	28 19 23 15	internal internal internal NFD 10.3	DND 6 DND 6 DND 6 DND 14	KM1-N005 KM1-N005	internal internal internal internal
<input type="checkbox"/> 110		ASM-12-20R23-0 PSM-13-20R83-4	MC7402 MC7404	3.8 6.8 11.8 22.4	31 17 32 17	internal internal internal NFD 10.3	DND 6 DND 6 DND 6 DND 14	KM1-N005 KM1-N005	internal internal internal internal
<input type="checkbox"/> 140		ASM-22-20R23-0 PSM-23-20R83-0 ASM-25-20R22-0	MC7404 MC7408 MC7408 MC7412 MC7416 MC7408 MC7412	8.8 16.7 24.5 36.8 44.8 31.5 47.3	26 17 36 24 20 26 17	internal NFD10.3 NFD 10.3 NFD 25.1 NFD 25.1 NFD 10.3 NFD 25.1	DND 6 DND 14 DND 14 DND 18 DND 24 DND 14 DND 18	Terminal box Terminal box Terminal box	internal internal RHK 90 RHK 42 RHK 42 RHK 90 RHK 42
<input type="checkbox"/> 190		ASM-32-20R21-0 ASM-34-20R21-0	MC7408 MC7412 MC7416 MC7412 MC7416 MC7432	40 60 68 66.7 88.9 140	36 24 21 50 37 24	NFD 10.3 NFD 25.1 NFD 25.1 NFD 25.1 NFD 25.1 NFD 50.1	DND 14 DND 18 DND 24 DND 18 DND 24 DND 45	Terminal box Terminal box	RHK 90 RHK 42 RHK 42 RHK 42 RHK 42 RHK 15
<input type="checkbox"/> 260		ASM 43-20R21-0	MC7432 MC7464	147.4 221.1	103 69	NFD 50.1 NFD 80.0	DND 45 DND 75	Terminal box	RHK 15 RHK 15

1) Acceleration with peak torque, no load, from standstill to nominal speed  
 2) For further information see section 5. "Accessories".  
 3) Speed-controlled applications: Application package BASIC (see section 2)  
 elektron. Getriebe, Schrittmotorinterface: Application package MOTION (see section 2)  
 Einachs-Positioniersystem: Application package PosMod (see separate data specification)

# CHAPTER 3 TYPICAL TORQUE-SPEED GRAPH OF SERVOMOTORS

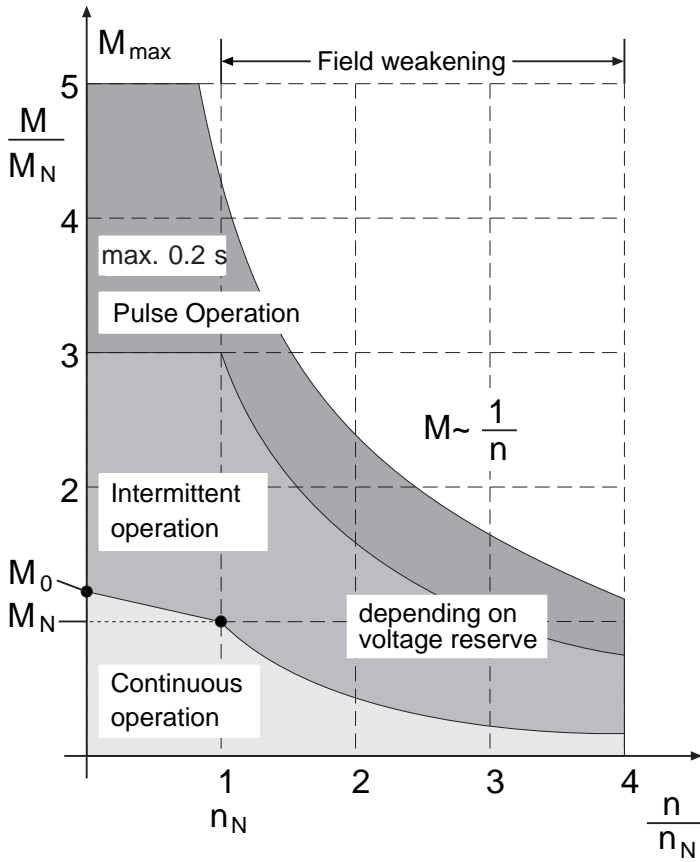

M-n Graph for asynchronous motors

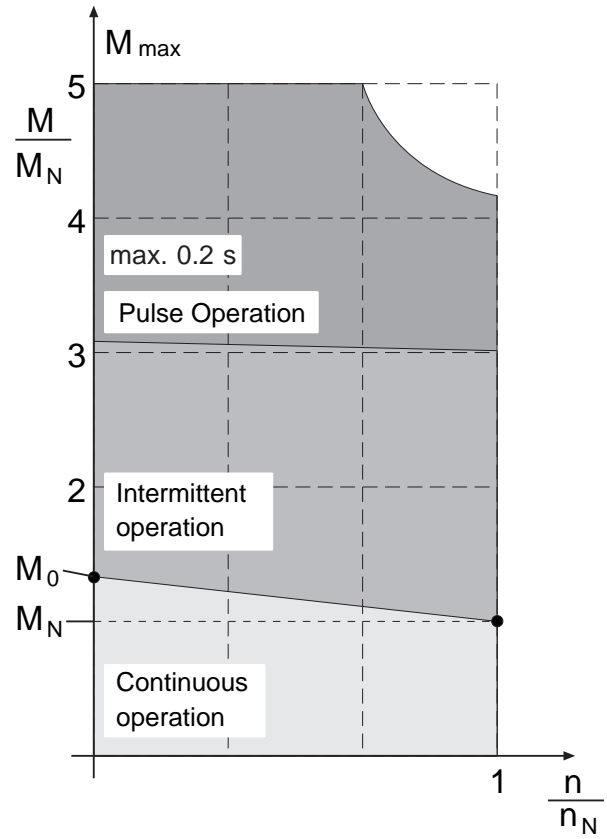

M-n Graph for synchronous motors

Term	Explanation
$M_0$ Static torque	Thermal limit torque of motor when stationary. This torque can be provided by the motor for any length of time.
$I_0$ Static current	Effective value of motor winding current which is required to generate the rated torque.
$M_N$ Rated torque	Thermal torque limit of motor at rated speed $n_N$ .
$I_N$ Rated current	Effective value of motor winding current required to generate the rated torque.
$P_N$ Rated power	Continuous power of motor at rated working point ( $M_N, n_N$ ) at rated current $I_N$ and rated voltage $U_N$ .
$M_{max}, I_{max}$ Limit curve	Motors can be loaded maximum 5 times the rated current
Field weakening area	The maximum peak torque output in the field weakening area depends on the voltage reserve. Typical torque characteristics are proportional to the function $1/f$ or $1/n$ .

# CHAPTER 3 TECHNICAL SPECIFICATIONS OF ASx-xx ASYNCHRONOUS SERVOMOTORS

Self cooling	$M_0$ [Nm]	$M_N$ [Nm]	$P_N$ [kW]	$I_0$ [A]	$I_N$ [A]	$n_N$ [min <sup>-1</sup> ]	$J_L$ [kgcm <sup>2</sup> ]	m [kg]	$n_{max}$ [min <sup>-1</sup> ]
ASM (H)-11-2xxx3	1.5	1.3	0.41	1.6	1.4	3000	2.8	6.5	12000
ASM (H)-12-2xxx3	2	1.7	0.54	2.1	1.8	3000	3.7	7.5	12000
ASM (H)-13-2xxx3	2.7	2.3	0.72	2.74	2.3	3000	4.7	8.5	12000
ASM (H)-14-2xxx3	4.2	3.5	1.1	4	3.3	3000	6.5	10.2	12000
ASM (H)-15-2xxx3	5.2	4.7	1.5	5.4	4.5	3000	8.9	12.8	12000
ASM (H)-21-2xxx3	4.2	3.5	1.1	3.6	3	3000	10.9	10.8	12000
ASM (H)-22-2xxx3	5.6	4.7	1.5	4.7	3.9	3000	14.4	13.2	12000
ASM (H)-23-2xxx3	8.4	7	2.2	6.7	5.6	3000	21.5	16.2	10000
ASM (H)-24-2xxx2	12	10	2.1	6.4	5.3	2000	29.8	20.3	10000
ASM (H)-25-2xxx2	15	13	2.7	7.7	6.6	2000	38.4	24	8000
ASM (H)-31-2xxx1	15.5	13	2.1	6.2	5.2	1500	70	29.8	8000
ASM (H)-32-2xxx1	20	17	2.7	8.2	6.8	1500	90	33	8000
ASM (H)-33-2xxx1	27.5	23	3.6	10.3	8.7	1500	130	41.5	8000
ASM (H)-34-2xxx1	42	35	5.5	15.1	12.6	1500	209	56.6	8000
ASH-41-2xxx1	47	40	6.3	21	17.9	1500	450	87	8000
ASH-42-2xxx1	70	60	9.4	30	25.5	1500	740	113	8000
ASH-43-2xxx1	85	70	11	37	30.4	1500	960	135	8000

Forced Cooling	$M_0$ [Nm]	$M_N$ [Nm]	$P_N$ [kW]	$I_0$ [A]	$I_N$ [A]	$n_N$ [min <sup>-1</sup> ]	$J_L$ [kgcm <sup>2</sup> ]	m [kg]	$n_{max}$ [min <sup>-1</sup> ]
ASF (V)-11-2xxx3	2	1.7	0.54	2.1	1.8	3000	2.8	7.5	12000
ASF (V)-12-2xxx3	2.7	2.3	0.72	2.8	2.4	3000	3.7	8.6	12000
ASF (V)-13-2xxx3	3.6	3	0.94	3.54	2.9	3000	4.7	9.7	12000
ASF (V)-14-2xxx3	5.6	4.7	1.5	5.1	4.3	3000	6.5	12.5	12000
ASF (V)-15-2xxx3	7.7	6.5	2	7.3	6.2	3000	8.9	14.2	12000
ASF (V)-21-2xxx3	5.6	4.7	1.5	4.6	3.9	3000	10.9	13.8	12000
ASF (V)-22-2xxx3	8.4	6.5	2	6.5	5	3000	14.4	16.2	12000
ASF (V)-23-2xxx3	12	10	3.1	8.9	7.4	3000	21.5	19.2	10000
ASF (V)-24-2xxx2	15.5	13	2.7	8	6.7	2000	29.8	23.3	10000
ASF (V)-25-2xxx2	19.7	16.5	3.4	9.8	8.2	2000	38.4	27	8000
ASF (V)-31-2xxx1	21.5	18	2.8	8.4	7	1500	70	33.8	8000
ASF (V)-32-2xxx1	27.5	23	3.6	10.6	8.9	1500	90	37.5	8000
ASF (V)-33-2xxx1	38	32	5	13.8	11.6	1500	130	46.5	8000
ASF (V)-34-2xxx1	56	47	7.4	18.4	15.4	1500	209	62.1	8000
ASV-41-2xxx1	83	70	11	33	27.5	1500	450	95	8000
ASV-42-2xxx1	140	118	18.5	50	42	1500	740	121	8000
ASV-43-2xxx1	170	143	22.5	61	51	1500	960	145	8000

In the sizes highlighted in gray there are preferred types, see page 3-7.

## Abbreviations:

$M_0$  Static torque  
 $M_N$  Rated torque  
 $P_N$  Rated power  
 $I_0$  Static current  
 $I_N$  Rated current  
 $n_N$  Rated speed  
 $n_{max}$  Maximum speed

$J_L$  Rotor moment of inertia without holding brake  
m Mass (weight) excluding holding brake

# CHAPTER 3 TECHNICAL SPECIFICATIONS OF PSx-xx SYNCHRONOUS SERVOMOTORS

Self Cooling	$M_0$ [Nm]	$M_N$ [Nm]	$P_N$ [kW]	$I_0$ [A]	$I_N$ [A]	$n_N, n_{max}$ [min <sup>-1</sup> ]	$J_L$ [kgcm <sup>2</sup> ]	$m$ [kg]
PSM-M1-2xxx2	0.34	0.32	0.067	0.4	0.4	2000	0.17	1
PSM-M1-2xxx6	0.34	0.32	0.2	0.85	0.9	6000	0.17	1
PSM-M2-2xxx6	0.5	0.48	0.3	1	1.1	6000	0.24	1.2
PSM-M3-2xxx2	0.65	0.6	0.125	0.55	0.58	2000	0.31	1.4
PSM-M3-2xxx6	0.65	0.6	0.375	1.2	1.3	6000	0.31	1.4
PSM-M4-2xxx2	1	0.9	0.19	0.65	0.7	2000	0.45	1.8
PSM-M4-2xxx6	1	0.8	0.5	1.6	1.7	6000	0.45	1.8
PSM-N4-2xxx4	0.65	0.6	0.25	0.9	0.9	4000	0.22	1.5
PSM-N4-2xxx6	0.65	0.5	0.31	1.3	1.2	6000	0.22	1.5
PSM-N5-2xxx4	1.5	1.3	0.54	1.6	1.4	4000	0.36	2.1
PSM-N5-2xxx6	1.5	1.0	0.62	2.4	2.1	6000	0.36	2.1
PSM-N6-2xxx4	2.3	2.0	0.83	2.4	2.0	4000	0.57	2.9
PSM-N6-2xxx6	2.3	1.5	0.94	3.5	3.0	6000	0.57	2.9
PSM-01-2xxx3	0.95	0.8	0.25	0.7	0.6	3000	1.1	3.1
PSM-01-2xxx4	0.95	0.75	0.31	0.8	0.65	4000	1.1	3.1
PSM-01-2xxx6	0.95	0.6	0.6	1.1	0.7	6000	1.1	3.1
PSM-02-2xxx3	1.8	1.5	0.47	1.5	1.2	3000	3.2	3.9
PSM-02-2xxx4	1.8	1.4	0.59	1.6	1.15	4000	3.2	3.9
PSM-02-2xxx6	1.8	1.2	0.75	2.7	1.8	6000	3.2	3.9
PSM-03-2xxx3	2.8	2.3	0.72	1.8	1.5	3000	5.3	4.2
PSM-03-2xxx4	2.8	2.2	0.92	2.8	2.2	4000	5.3	4.2
PSM-03-2xxx6	2.8	1.8	1.1	4.5	2.9	6000	5.3	4.2
PSM-04-2xxx3	4.8	4.1	1.3	3.7	3.2	3000	7.4	5.3
PSM-04-2xxx4	4.8	3.9	1.6	5	4.1	4000	7.4	5.3
PSM-04-2xxx6	4.8	2.3	1.4	6.7	3.3	6000	7.4	5.3
PSM (H)-11-2xxx3	3.4	3.2	1	2.6	2.4	3000	5.6	6.5
PSM (H)-11-2xxx4	3.4	3	1.2	3.4	3	4000	5.6	6.5
PSM (H)-11-2xxx6	3.4	2.1	1.3	5	3.1	6000	5.6	6.5
PSM (H)-12-2xxx3	5.6	4.5	1.4	3.9	3.1	3000	8.6	8.3
PSM (H)-12-2xxx4	5.6	4.1	1.7	5.1	3.7	4000	8.6	8.3
PSM (H)-12-2xxx6	5.6	3.2	2	8.2	4.7	6000	8.6	8.3
PSM (H)-13-2xxx3	7.5	5.6	1.7	5.1	3.8	3000	11.7	10.1
PSM (H)-13-2xxx4	7.5	5.1	2.1	7.2	4.9	4000	11.7	10.1
PSM (H)-13-2xxx6	7.5	4.1	2.6	10.1	5.5	6000	11.7	10.1
PSM (H)-14-2xxx3	9.6	6.6	2.1	6.4	4.4	3000	14.8	11.8
PSM (H)-14-2xxx4	9.6	5.7	2.4	8.9	5.3	4000	14.8	11.8
PSM (H)-21-2xxx2	8.4	7	1.5	3.7	3.1	2000	12.5	10.2
PSM (H)-21-2xxx3	8.4	6.5	2	5.8	4.5	3000	12.5	10.2
PSM (H)-21-2xxx4	8.4	5.2	2.2	7.7	4.8	4000	12.5	10.2
PSM (H)-22-2xxx2	12	11	2.3	4.8	4.4	2000	21	12.3
PSM (H)-22-2xxx3	12	10	3.1	7.7	6.4	3000	21	12.3
PSM (H)-22-2xxx4	12	7.6	3.2	10.3	6.5	4000	21	12.3
PSM (H)-23-2xxx2	15.5	13	2.7	7.3	6.1	2000	28	15.5
PSM (H)-23-2xxx3	15.5	11.2	3.5	10.1	7.3	3000	28	15.5
PSM (H)-23-2xxx4	15.5	8.4	3.5	12.9	7	4000	28	15.5
PSM (H)-24-2xxx2	20.5	17	3.5	9	7.5	2000	41	20.4
PSM (H)-24-2xxx3	20.5	13	4.1	13.1	8.3	3000	41	20.4

In the sizes highlighted in gray there are preferred types, see page 3-7.

# CHAPTER 3 TECHNICAL SPECIFICATIONS OF PSx-xx SYNCHRONOUS SERVOMOTORS

Forced Cooling	$M_0$ [Nm]	$M_N$ [Nm]	$P_N$ [kW]	$I_0$ [A]	$I_N$ [A]	$n_N, n_{max}$ [min <sup>-1</sup> ]	$J_L$ [kgcm <sup>2</sup> ]	$m$ [kg]
PSF (V)-11-2xxx3	4.7	4.5	1.4	3.4	3.4	3000	5.6	7.3
PSF (V)-11-2xxx4	4.7	4.2	1.7	4.7	4.2	4000	5.6	7.3
PSF (V)-11-2xxx6	4.7	3	1.9	6.9	4.4	6000	5.6	7.3
PSF (V)-12-2xxx3	7.7	6.2	1.9	5.4	4.3	3000	8.6	9.1
PSF (V)-12-2xxx4	7.7	5.7	2.4	6.9	5.1	4000	8.6	9.1
PSF (V)-12-2xxx6	7.7	4.4	2.8	11.4	6.5	6000	8.6	9.1
PSF (V)-13-2xxx3	10.1	7.6	2.4	6.9	5.2	3000	11.7	10.9
PSF (V)-13-2xxx4	10.1	6.9	2.9	9.7	6.6	4000	11.7	10.9
PSF (V)-13-2xxx6	10.1	5.5	3.5	13.6	7.4	6000	11.7	10.9
PSF (V)-14-2xxx3	12.5	8.6	2.7	8.3	5.7	3000	14.7	12.7
PSF (V)-14-2xxx4	12.5	7.4	3.1	11.7	6.9	4000	14.74	12.7
PSF (V)-21-2xxx2	12.3	10.2	2.1	5.4	4.5	2000	12.5	13.2
PSF (V)-21-2xxx3	12.3	9.5	3	8.5	6.6	3000	12.5	13.2
PSF (V)-21-2xxx4	12.3	7.3	3.1	11.3	6.7	4000	12.5	13.2
PSF (V)-22-2xxx2	17.6	16	3.3	7	6.4	2000	21	15.3
PSF (V)-22-2xxx3	17.6	14.6	4.6	11.2	9.3	3000	21	15.3
PSF (V)-22-2xxx4	17.6	10.7	4.5	15	9.1	4000	21	15.3
PSF (V)-23-2xxx2	22.7	19	4	10.6	8.9	2000	28	18.5
PSF (V)-23-2xxx3	22.7	16.4	5.1	14.8	10.9	3000	28	18.5
PSF (V)-23-2xxx4	22.7	11.8	4.9	18.8	9.8	4000	28	18.5
PSF (V)-24-2xxx2	30	25	5.2	12.2	10.3	2000	41	23.4
PSF (V)-24-2xxx3	30	21	5.6	18.4	12.9	3000	41	23.4

## Abbreviations:

$M_0$  Static torque  
 $M_N$  Rated torque  
 $P_N$  Rated power  
 $I_0$  Static current  
 $I_N$  Rated current  
 $n_N$  Rated speed  
 $n_{max}$  Maximum speed

$J_L$  Rotor moment of inertia without holding brake  
 $m$  Mass (weight) excluding holding brake

## Warning!

In the case of **small motor sizes** (such as PSx motors sizes M, N and 0 or motors of other manufacturers) **with MC6000 Servocontrollers** thermal monitoring by the motor PTC is inadequate for dynamic operation with overload. In such cases the overall design should be checked with LUST to avoid the motor being destroyed.

However, the **MC7000 Servocontrollers** are designed for operating small motors. The I<sup>2</sup> x t - protection switches off if the motor is overloaded.

# CHAPTER 3 DIMENSIONS OF SERVOMOTORS

Connection with connector at 90°

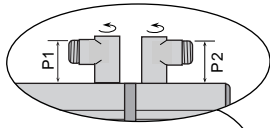

Connection with connector straight

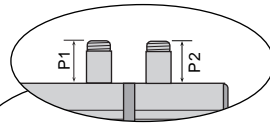

Flange with self cooling  
ASM-xx  
PSM-xx

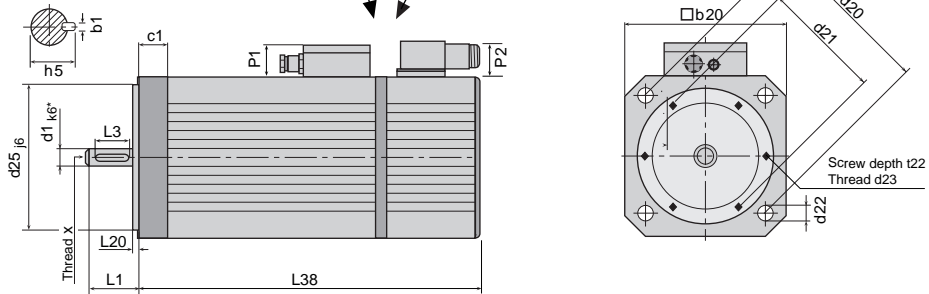

Flange/foot with self cooling  
ASH-xx  
PSH-xx

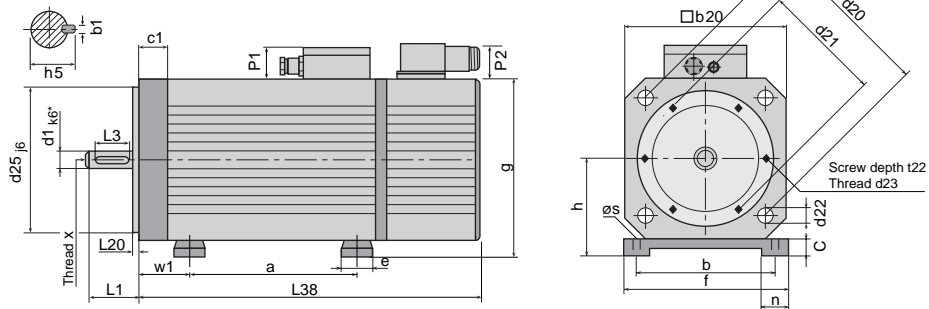

Flange with forced cooling  
ASF-xx  
PSF-xx

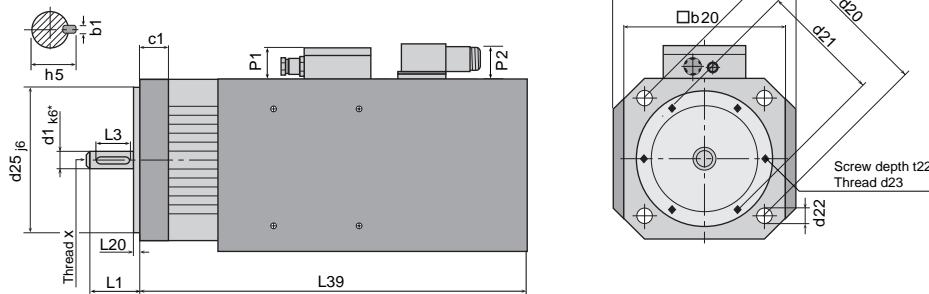

Flange/foot with forced cooling  
ASV-xx  
PSV-xx

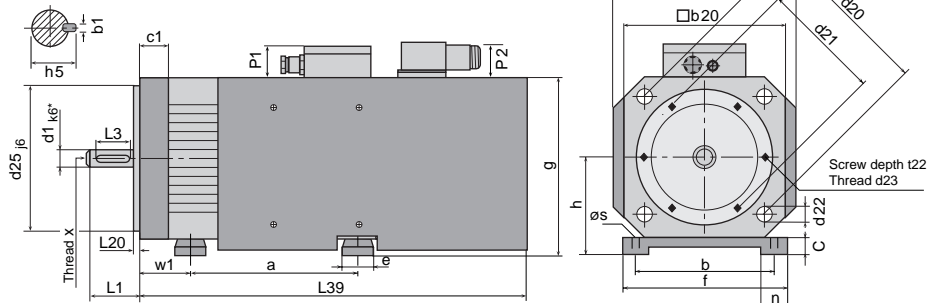

\* **Exception:** For the motor types PSM-Nx is the clearance of dimension  $d1_{j6}$  (DIN / ISO standard)!

# CHAPTER 3 DIMENSIONS OF SHAFT, FLANGE AND FOOT

See Page 3-15 for more dimensions ↗

		Shaft						Flange										Foot									
Type	Size Length	b1	d1	h5	L1	L3	x	b20	c1	d20	d21	d22	d23	d25	L20	t22	a		a		b	c	e	f	n	s	w1
																	Type AS	Type PS	Type AS	Type PS							
																	No Br.	With Br.	No Br.	With Br.							
PS	M1																										
	M2	3	9	10.2	20	12	M3	55	11	63	-	5.8	-	40	2.5	-	-	-	-	-	-	-	-	-	-	-	-
	M3																										
	M4																										
PS	N4																										
	N5	4	11	12.5	23	18	M4	70	14	75	-	5.3	-	60	2.5	-	-	-	-	-	-	-	-	-	-	-	-
	N6																										
PS	01																										
	02	5	14	16	30	22	M4	92	8	100	-	7	-	80	3	-	-	-	-	-	-	-	-	-	-	-	-
	03																										
	04																										
AS	11																110	120	75	75							
	a. 12																130	140	105	105							
PS	13	6	19	21.5	40	32	M6	110	10	115	-	9	-	95	3	-	150	160	135	135	100	8	30	120	25	7	63
	14																180	190	165	165							
AS	15																230	240	-	-							
AS	21																110	155	110	155							
	a. 22																140	185	140	185							
PS	23	8	24	27	50	32	M8	140	17	165	110	11	M8	130	3.5	18	170	215	170	215	125	10	30	150	25	10	50
	24																215	260	215	260							
AS	25																260	305	-	-							
AS	31																145	200	-	-							
	32	10	32	35	58	50	M12	190	22	215	140	14	M10	180	4	25	170	225	-	-	190	17	40	215	27,5	12	70
	33																215	270	-	-							
	34																310	365	-	-							
AS	41																245	245	-	-							
	42	12	42	45	110	90	M16	260	18	300	-	18	-	250	5	-	335	335	-	-	216	18	40	270	65	12	89
	43																405	405	-	-							

All dimensions in mm.

**Abbreviations:**

- AS Asynchronous Servomotor Series
- PS Synchronous Servomotor Series
- Br. Permanently excited single disk holding brake
- GX Incremental encoder (sin/cos), variants G1, G3, G5
- RX Resolver, variants R1, R2, R8, K1, K2, K8



# CHAPTER 3 DIMENSIONS OF SERVOMOTORS

Repetition identical with page 3-10

Connection with connector at 90°

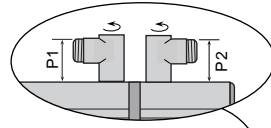

Connection with connector straight

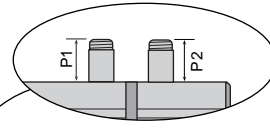

Flange with self cooling  
ASM-xx  
PSM-xx

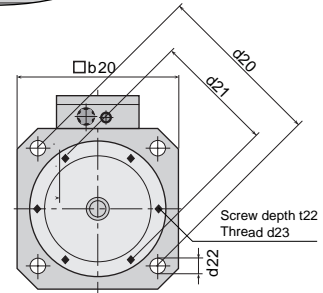
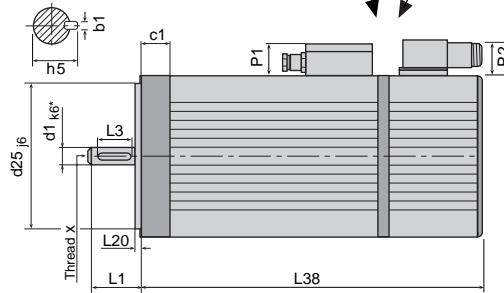

Flange/foot with self cooling  
ASH-xx  
PSH-xx

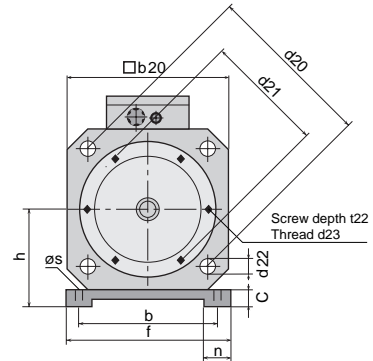
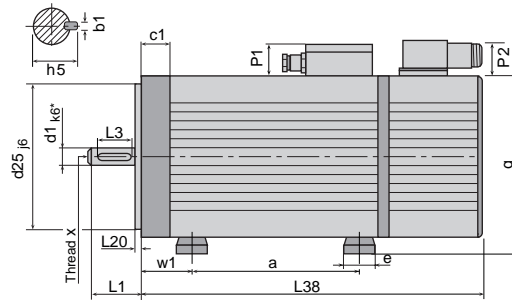

Flange with forced cooling  
ASF-xx  
PSF-xx

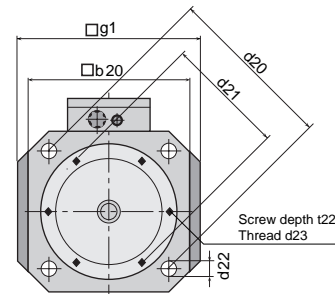
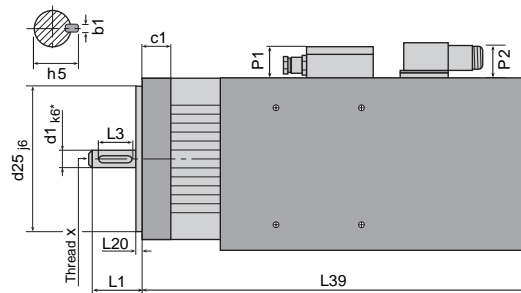

Flange/foot with forced cooling  
ASV-xx  
PSV-xx

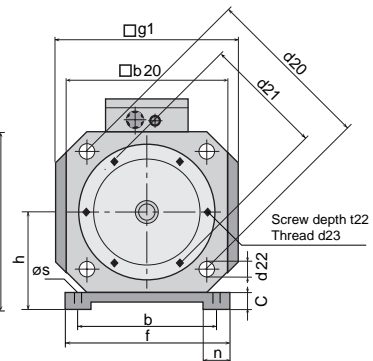
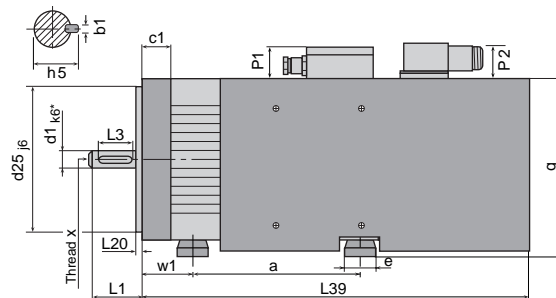

\* **Exception:** For the motor types PSM-Nx is the clearance of dimension  $d1_{j6}$  (DIN / ISO standard)!

# CHAPTER 3 DIMENSIONS FOR MOTORS WITH SELF COOLING AND FORCED COOLING

↔ See Page 3-13 for more dimensions

		Motor (Self Cooling)											Forced Cooling											
Type	Size Length	b20 □	g	h	L38 for Type AS				L38 for Type PS				g1	L39 for Type AS				L39 for Type PS						
					No Br.	With Br.	No Br.	With Br.	No Br.	With Br.	No Br.	With Br.		No Br.	With Br.	No Br.	With Br.	No Br.	With Br.					
					GX	GX	RX	RX	GX	RX	GX	RX		GX	GX	RX	RX	RX	RX	GX	GX			
PS	M1	55	-	-	-	-	-	-	-	121	-	145	-	-	-	-	-	-	-	-	-	-	-	
	M2				-	-	-	-	-	133	-	157		-	-	-	-	-	-	-	-	-	-	-
	M3				-	-	-	-	-	145	-	169		-	-	-	-	-	-	-	-	-	-	-
	M4				-	-	-	-	-	170	-	194		-	-	-	-	-	-	-	-	-	-	-
PS	N4	70	-	-	-	-	-	-	-	135	-	163	-	-	-	-	-	-	-	-	-	-	-	
	N5				-	-	-	-	-	159	-	187		-	-	-	-	-	-	-	-	-	-	
	N6				-	-	-	-	-	195	-	223		-	-	-	-	-	-	-	-	-	-	-
PS	01	92	-	-	-	-	-	-	-	156	-	202	-	-	-	-	-	-	-	-	-	-	-	
	02				-	-	-	-	-	180	-	226		-	-	-	-	-	-	-	-	-	-	
	03				-	-	-	-	-	214	-	260		-	-	-	-	-	-	-	-	-	-	
	04				-	-	-	-	-	248	-	294		-	-	-	-	-	-	-	-	-	-	-
AS	11	110	118	63	286	294	254	293	246	216	254	224	123	358	366	315	354	273	281	318	326			
	a.				12	301	309	269	308	276	246	284		254	373	381	330	369	303	311	348	356		
PS	13				321	329	289	328	306	272	314	284		393	401	350	389	333	341	378	386			
	14				356	364	324	368	336	306	344	314		428	436	385	424	363	371	408	416			
AS	15				401	409	369	408	-	-	-	-	473	481	430	469	-	-	-	-				
AS	21	140	150	80	293	339	259	309	261	231	306	276	157	379	425	334	384	305	350	347	392			
	a.				22	313	359	279	329	291	261	336		306	399	445	354	404	335	480	377	422		
PS	23				348	394	314	364	321	291	366	336		434	480	389	439	365	410	407	452			
	24				393	439	359	409	366	336	411	381		479	525	434	484	410	455	452	497			
AS	25				438	484	404	454	-	-	-	-	524	570	479	529	-	-	-	-				
AS	31	190	207	112	343	399	316	372	-	-	-	-	203	442	498	404	460	-	-	-	-			
	32				367	423	340	396	-	-	-	-		466	522	428	484	-	-	-	-			
	33				414	470	387	443	-	-	-	-		512	569	475	531	-	-	-	-			
	34				509	565	482	538	-	-	-	-		608	664	570	626	-	-	-	-			
AS	41	260	269	132	449	449	416	416	-	-	-	-	273	542	542	509	509	-	-	-	-			
	42				539	539	506	506	-	-	-	-		632	632	596	596	-	-	-	-			
	43				609	609	576	576	-	-	-	-		702	702	666	666	-	-	-	-			

All dimensions in mm.

**Abbreviations:**

- AS Asynchronous Servomotor Series
- PS Synchronous Servomotor Series
- Br. Permanently excited single disk holding brake
- GX Incremental encoder (sin/cos), variants G1, G3, G5
- RX Resolver, variants R1, R2, R8, K1, K2, K8

# CHAPTER 3

# MOUNTING FLANGE, POWER AND ENCODER CONNECTIONS

Mounting flange

For installation of a second encoder, (eg Heidenhain ROD426 or Stegmann DG60) for models K1, K2, K8. The coupling is not included as standard (see CHAPTER 5 Accessories).

For motors PSx-Mx and PSx-Nx (fixing with screws)

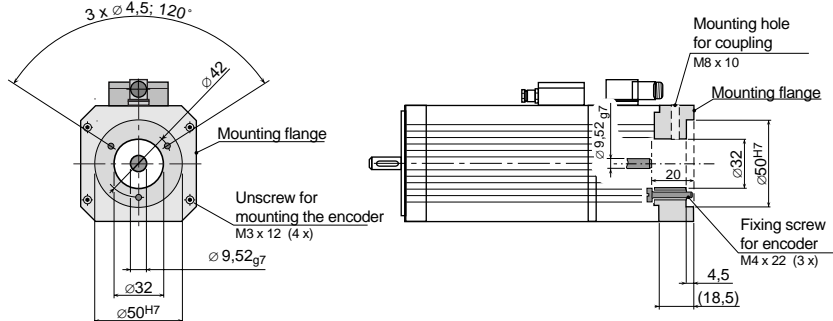

For motors ASx- und PSx-0x bis -4x (fixing with clamps)

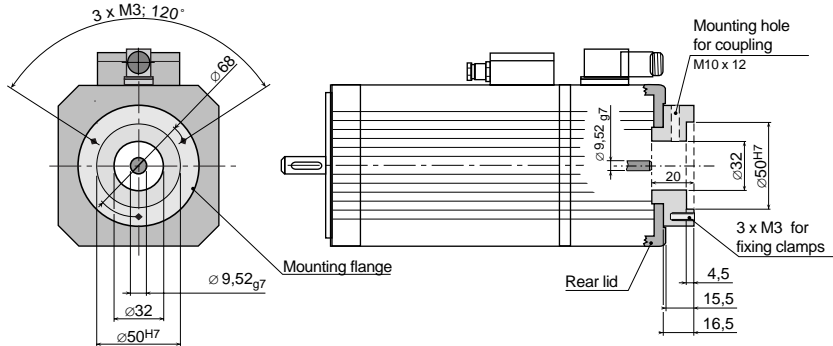

Power connection using terminal box

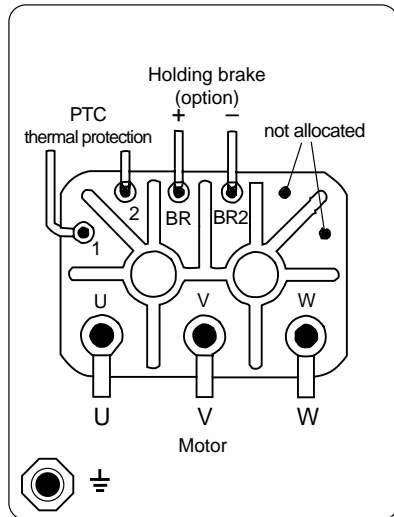

Eyebolt size:

Type	Size	Power connection	PTC and Brake
PSx	0	M4	M3
ASx,	1	M4	M3
PSx	2	M4	M3
ASx	3	M6	M3
	4	M6	M3

Power connector

Socket

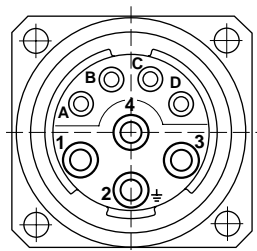

For matching plugs and ready made cables see CHAPTER 5 Accessoires.

Contact No.	Allocation
1	U
2	PE
3	W
4	V
A	Brake +
B	Brake -
C	PTC
D	PTC

# CHAPTER 3 MOUNTING FLANGE, POWER AND ENCODER CONNECTIONS

Power connection via terminal box

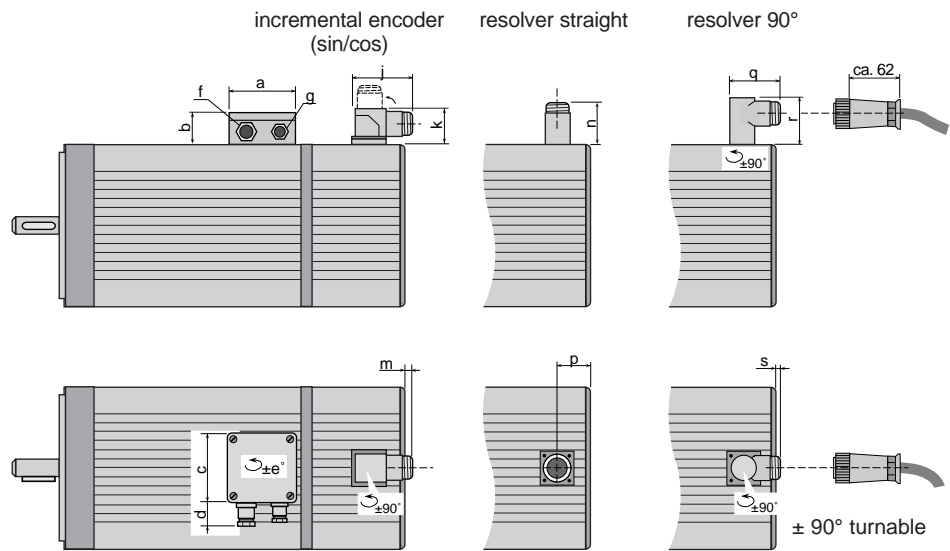

Power connector, output straight or 90°

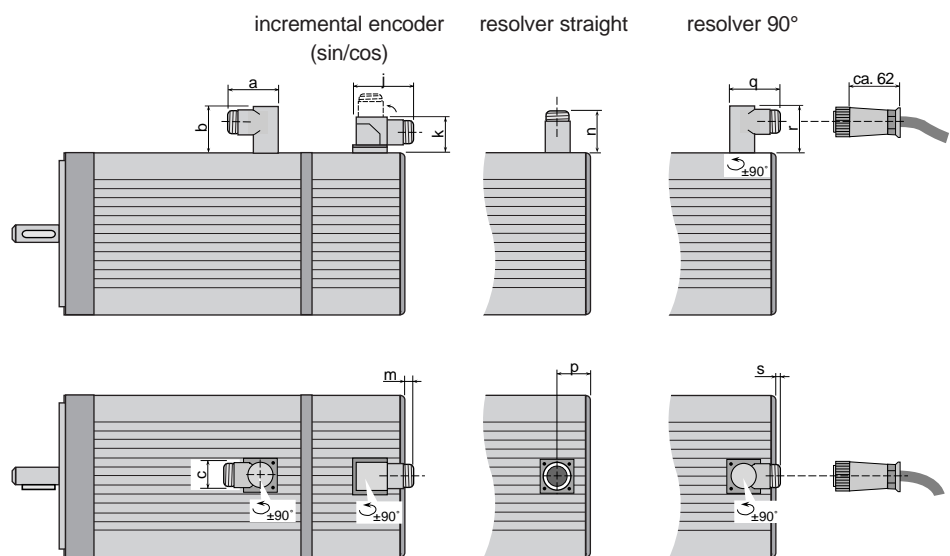

Dimensions

Motor			Power connector							Encoder connector							
Connection	Type	Size	a	b	c	d	e	f	g	j	k	m	n	p	q	r	s
Terminal box	PSx	0	98	37	64	21	180°	PG11	PG13,5 <sup>1)</sup>	73	39	14	29	24	45	32	8
	ASx,	1	98	37	64	21	180°	PG11	PG13,5 <sup>1)</sup>	73	39	11	29	29	45	32	3
	PSx											11	29	29	45	32	3
	ASx	3	123	71	123	25 <sup>2)</sup>	90°	PG21	PG16	73	39	11	29	34	45	32	-2
	PSx											-4	29	29	45	32	3
Mains power connector	PSx	M	47	32	25					-	-	-	29	17	45	32	15
		N	47	32	25					-	-	-	29	17	45	32	16
		0	47	32	25					73	39	36	29	17	45	32	8
	ASx, PSx	1	47	32	25					73	39	39	29	17	45	32	3

<sup>1)</sup> From 1996; <sup>2)</sup> As supplied, cable bushings point towards motor shaft.

# CHAPTER 3 PERMISSIBLE AXIAL AND RADIAL LOADS

The following tables show the maximum permissible radial loads ( $F_{Rm}$ ) at the point 1/2 and maximum permissible axial loads  $F_{Am}$  assuming a service life of 20000 hours.

A radial load which is not in the middle of the shaft end can simply be re-calculated to take account of the different leverage effect.

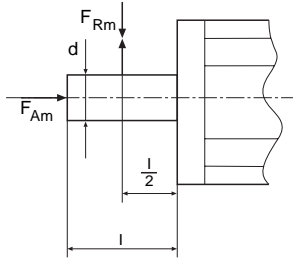

B5, B35

V1

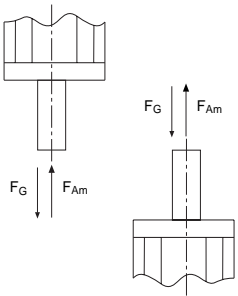

V3

Size	Radial load $F_{Rm}$ [N] at speed $n$ [ $\text{min}^{-1}$ ]					Axial load $F_{Am}$ [N] at speed $n$ [ $\text{min}^{-1}$ ]					$F_G$ [N]
	1500	2000	3000	6000	8000	1500	2000	3000	6000	8000	
ASx-11											9
ASx-12	800	750	640	500	430	650	600	500	370	320	12
ASx-13											15
ASx-14											22
ASx-15	800	750	580	420	230	550	500	440	290	210	30
ASx-21											17
ASx-22	1300	1200	1020	790	660	980	890	770	560	470	24
ASx-23											36
ASx-24											52
ASx-25	1220	1140	950	680	500	850	790	600	440	360	67
ASx-31											57
ASx-32	2760	2500	2100	1660	1450	2170	1900	1500	1160	1000	75
ASx-33											108
ASx-34											177
ASx-41	3750	3450	2750	2200	1800	3100	2700	2200	1650	1400	175
ASx-42											300
ASx-43	3550	3200	2450	1900	1300	2790	2400	1950	1400	1200	390

Size	Radial Load $F_{Rm}$ [N] at Speed $n$ [ $\text{min}^{-1}$ ]				Axial Load $F_{Am}$ [N] at Speed $n$ [ $\text{min}^{-1}$ ]				$F_G$ [N]
	2000	3000	4000	6000	2000	3000	4000	6000	
PSx-M1									1
PSx-M2	310	260	240	210	250	200	170	140	2
PSx-M3									3
PSx-M4									4
PSx-N1									2
PSx-N2	330	280	250	220	260	210	180	150	4
PSx-N3									6
PSx-N4									2
PSx-N5	400	340	300	270	310	260	220	180	4
PSx-N6									6
PSx-01									3
PSx-02	470	400	350	320	380	310	260	220	9
PSx-03									14
PSx-04	460	370	330	260	350	280	240	200	20
PSx-11									10
PSx-12	720	640	550	490	590	500	420	350	17
PSx-13									23
PSx-14									30
PSx-21									17
PSx-22	1100	1000	850	760	900	770	650	560	30
PSx-23									40
PSx-24									60

In vertical installations the permissible axial loads  $F_{Am}$  apply for the upward load direction. In the case of downward load they are reduced by  $F_G$ .

# CHAPTER 3 TECHNICAL SPECIFICATIONS: SHAPE AND SHAFT SEAL IP65

## Arrangement

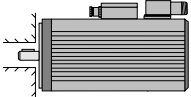
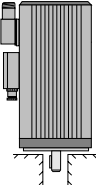
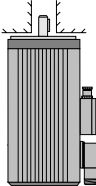
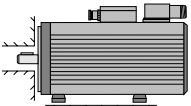
Shape		Description	
Drawing	Code	Shaft	Fixing or Mounting
	B5	Free shaft end	Flange installation Access from casing side
	V1	Free shaft end at bottom	Flange installation at bottom Access from casing side
	V3	Free shaft-end at top	Flange installation top Access form casing side
	B35	Free shaft-end	Mounting on sub-structure with additional flange Access from casing side

## Shaft seal IP65 (Option see Code CHAPTER K)

Size	Lubrication	Maximum speed with oil lubrication [min <sup>-1</sup> ]	Maximum speed with grease Lubrication [min <sup>-1</sup> ]
ASx-1x		12000	3500
ASx-2x		10500	3500
ASx-3x		9500	2500
ASx-4x		8000	2500
PSx-Mx		9000	6000
PSx-N1 - N3		9000	4500
PSx-N4 - N6		9000	6000
PSx-0x		9500	3500
PSx-1x		12000	3500
PSx-2x		10500	3500

Adequate lubrication is essential for reliability. Excessive speed causes the destruction of seal lips.

## CHAPTER 3

# TECHNICAL SPECIFICATIONS: SELF COOLING AND FORCED COOLING

### Cooling

The motor specific power data and torque data refer to

- operating temperature -5 °C to 40 °C
- operating temperature (coolant temperature) 40 °C related to none insulated installation and that part of the motor heat loss will be conducted through the fixing flange of the mounting location.

### Minimum size of mounting flange

Size	Mounting flange	Location of mounting flange	Mounting flange material
	ASx-1x	230 x 150 x 15	steel
	ASx-2x	300 x 300 x 20	steel
	ASx-3x	300 x 300 x 20	steel
	ASx-4x	380 x 310 x 20	steel
	PSx-Mx	200 x 100 x 10	steel
	PSx-Nx	230 x 150 x 15	steel
	PSx-0x	230 x 150 x 15	steel
	PSx-1x	230 x 150 x 15	steel
	PSx-2x	300 x 300 x 20	steel

If the motor is installed thermally insulated from its mounting, the permissible rated torque must be reduced by 5 - 15%.

### Altitude and coolant average temperature

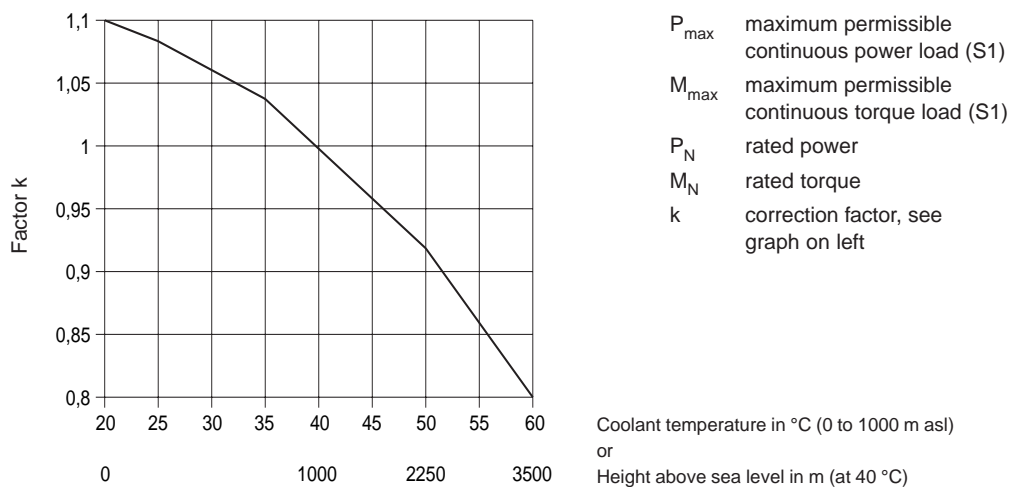

$$P_{max} = k * P_N$$

$$M_{max} = k * M_N$$

# CHAPTER 3

## TECHNICAL SPECIFICATIONS: SELF COOLING AND FORCED COOLING

### Forced cooling

Size	Voltage [V]	Mains Frequency [Hz]	Rated Current [A]	Protection
ASF(V)-1x	1 x 230 +6%/-10%	48 ... 62	0.1	IP54
ASF(V)-2x	1 x 230 +6%/-10%	48 ... 62	0.18	IP54
ASF(V)-3x	3 x 400 +6%/-10%	48 ... 62	0.15	IP54
ASV-4x	3 x 400 +6%/-10%	48 ... 62	0.21	IP54
PSM-Mx	-	-	-	-
PSM-Nx	-	-	-	-
PSM-0x	-	-	-	-
PSF(V)-1x	1 x 230 +6%/-10%	48 ... 62	0.1	IP54
PSF(V)-2x	1 x 230 +6%/-10%	48 ... 62	0.18	IP54

Air is drawn into the B side by axial fans and ejected through the A side. The mating connector for the fan connection is supplied.

### Connection arrangement Fan connector (view of socket contacts)

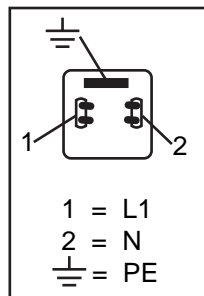

Connection for ASF(V)-1x to ASF(V)-2x  
and  
PSF(V)-1x to PSF(V)-2x

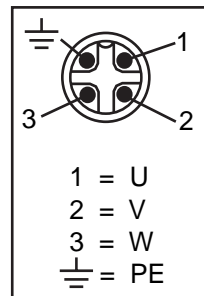

Connection for ASF(V)-3x and ASV-4x



## CHAPTER 3

# TECHNICAL SPECIFICATIONS: HOLDING BRAKE

The zero backlash permanently excited single disk holding brake works on a fail-safe basis which in practical terms means that the brake works when no voltage is applied.

The holding brake is switched on and off normally only when the motor is stationary. If the holding brake is to be used as an Emergency Stop brake, the permitted service life must be observed.

### Technical specifications

Size	$M_H$ [Nm]	$I_N$ [A]	$U_N$ [V]	$n_{max}$ [min <sup>-1</sup> ]	$m$ [kg]	$W_L$ [10 <sup>6</sup> Ws]	$J_B$ [kgcm <sup>2</sup> ]
ASx-1x	8	0.75	24 ± 10%	8000	0.65	4	0.55
ASx-2x	25	0.84	24 ± 10%	6000	1.2	7.5	4.5
ASx-3x	80	1.5	24 ± 10%	6000	3.2	20	16
ASx-4x	160	2.2	24 ± 10%	6000	6.7	60	50
PSx-Mx	1.2	0.34	24 ± 10%	12000	0.2	0.15	0.07
PSx-Nx	2.5	0.50	24 ± 10%	10000	0.3	2	0.38
PSx-0x	5	0.67	24 ± 10%	10000	0.6	4	1.06
PSx-1x	8	0.75	24 ± 10%	8000	0.65	4	0.55
PSx-2x	25	0.84	24 ± 10%	6000	1.2	7.5	4.5

Abbreviations:

$M_H$  adhesion

$I_N$  exciter current

$n_{max}$  maximum speed (unbraked)

$U_N$  DC voltage for fan

$m$  mass (weight)

$W_L$  permissible service life switching cycles

$J_B$  moment of inertia of the holding brake

### Protection circuit

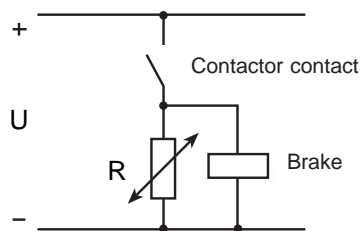

Suggested circuit for brake protection

As a consequence of the inductivity of the holding brakes there is a voltage peak spike which occurs when the exciter current is switched off: this peak can be over 1000 V. To avoid this peak voltage a protection suppressor circuit with a varistor should be used (recommended type Q69-X3022).

### MC7000, HB1

Output for driving a +24V-holding brake:

- short circuit proof
- monitoring open circuits (< 8 mA)
- monitoring overcurrents (> 2 A)
- internal protection diode (no varistor needed)

## CHAPTER 4 PC USER SOFTWARE DRIVEMANAGER

### General

The user software DRIVEMANAGER is used to simplify the commissioning, control and operation of the servocontroller MASTERCONTROL MC6000/MC7000. The DRIVEMANAGER has the following features:

- convenient parameter editor with clear text display
- status display for monitoring the operation-related parameter values; direct control of the servocontroller is possible
- convenient Digital-Scope for recording step responses (e.g. rotational speed or torque curve) for the easy tuning of the controller
- storage and transmission of data sets
- operation of networked drives via a serial interface (LUSTBus)

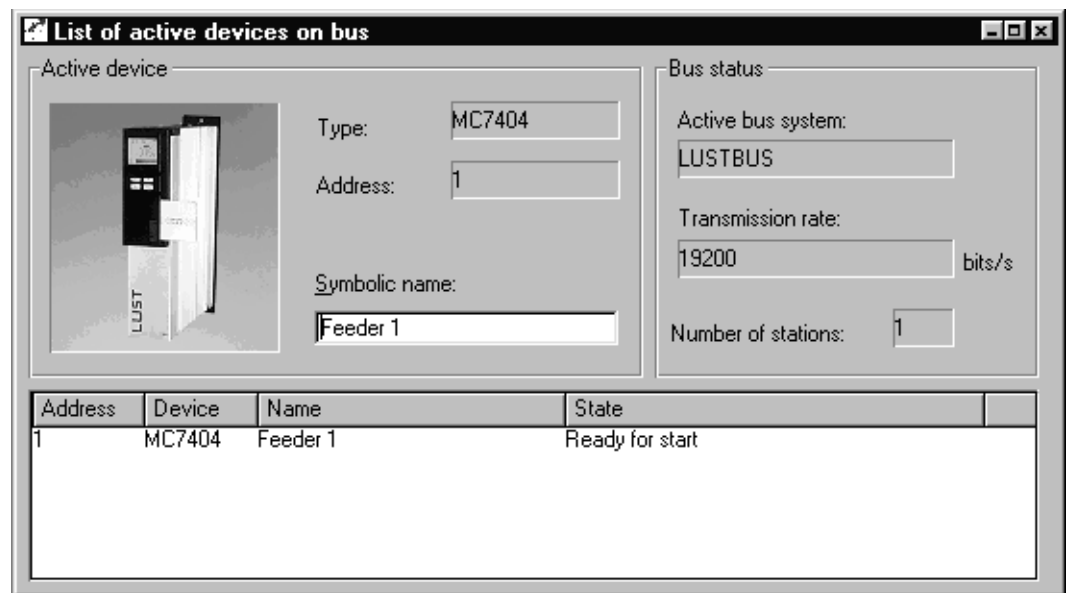

*The device list shows all the devices connected at the bus*

The DRIVEMANAGER can also be used for editing parameters and to control the SMARTDRIVE VF1000 frequency inverter.

# CHAPTER 4 PC USER SOFTWARE DRIVEMANAGER

**Simple commissioning** Using the user software DRIVEMANAGER and the application packages BASIC and MOTION it is possible to commission the servocontroller MASTERCONTROL MC7000, assisted by graphic displays.

Select the operation mode suitable for your application (e.g. reference generation over  $\pm 10$  V) and the DRIVEMANAGER automatically loads a preset data set in the servocontroller. You can adapt the inputs, outputs and other settings as required. The controller is tuned by changing two parameters.

## Selecting the mode reference generation over $\pm 10$ V

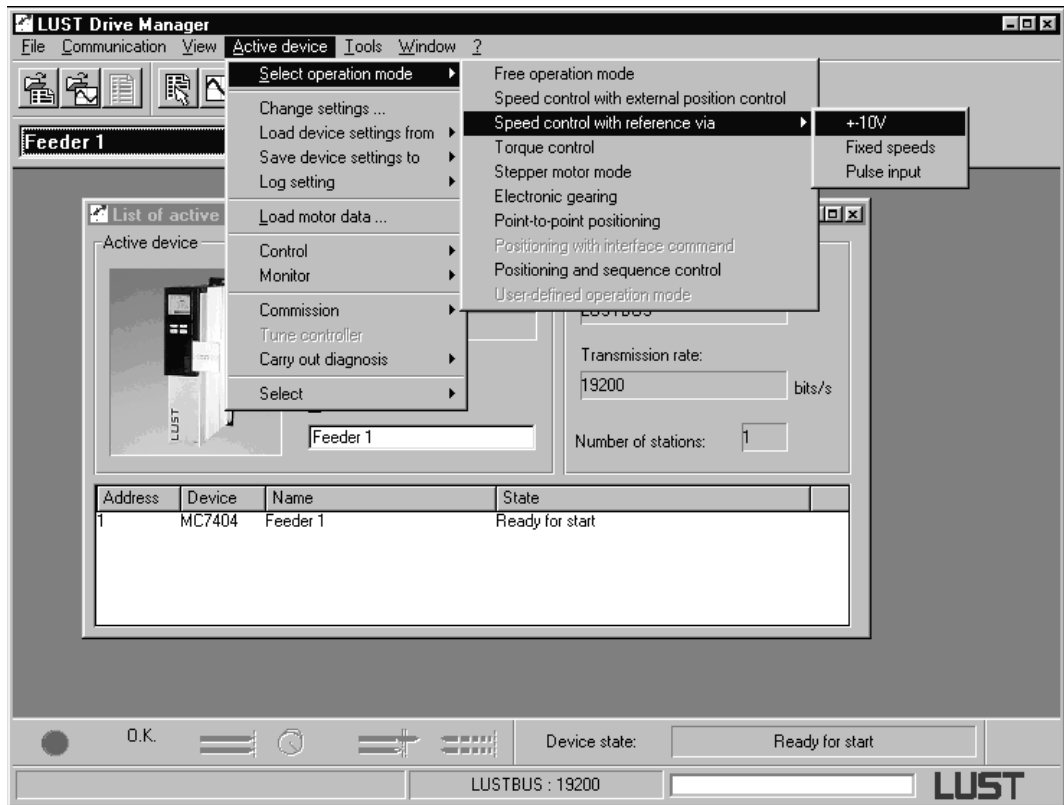

Step one –  
Select the operation mode  
for a servodrive

The function is assigned to  
the inputs and outputs by  
special mode-dependent  
operating masks

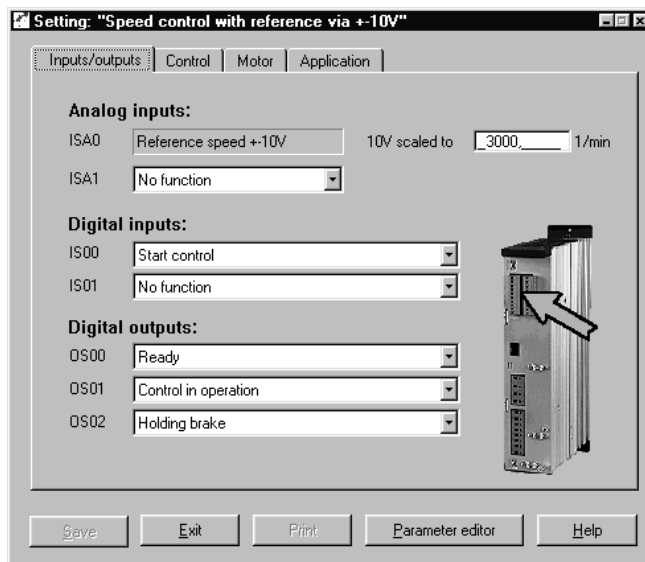

# CHAPTER 4 ORDER DETAILS FOR PC USER SOFTWARE

## DRIVEMANAGER

**Languages** You can choose between German or English when you install the user software.

**Order notes** The PC user software can be ordered in two versions. The versions differ in the installed software licenses:

**Order / type designation**

DRIVEMANAGER TEST

Contains the full scope of functions and is intended for test and demo purposes. The runtime is limited to 180 days from installation.

DRIVEMANAGER

Contains the full scope of functions. The runtime is unlimited. The software license permits simultaneous use on any number of workstations.

**Scope of supply** The following are included in the scope of supply:

- 5 disks for installing the user software DRIVEMANAGER
- User Manual DRIVEMANAGER
- 2 floppy disks with motor data sets

**Hardware and software requirements** The following hardware and software is required for using the DRIVEMANAGER :

- a PC with an 80486 or more powerful processor
- Microsoft® Windows®95 or Windows®NT (in preparation)
- main memory (RAM) with at least 8 MB, 16 MB is recommended
- a buffered serial interface

**Note:** The interface converter cable LBSKK200 (KPRS232 for VF1000) must be used to connect the servocontroller to the PC. The order information is given on the next page.

# CHAPTER 4 Accessories for DRIVEMANAGER

## Interface converter cable LB SKK200

For the operation of a single servocontroller:

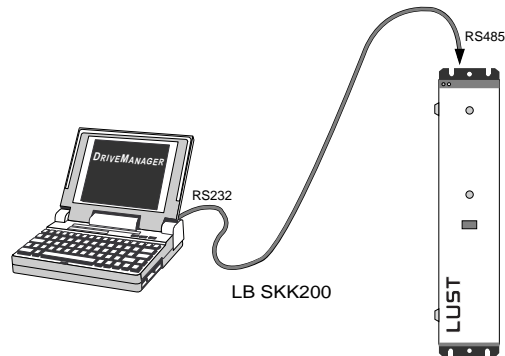

The cable converts the signals of the fail-safe RS485 interface of the servocontroller to the RS232 level of the PC.

## T-coupler LB TK100

For the operation of several networked servocontrollers:

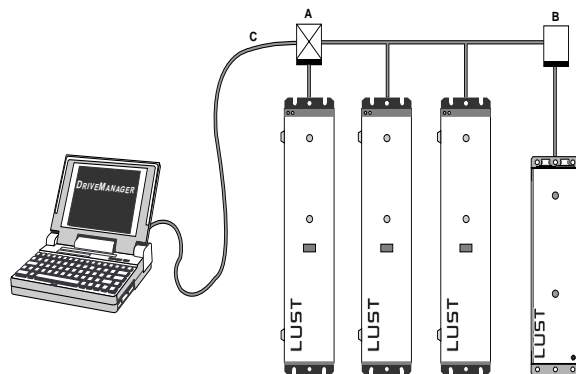

A LB TK100-01 RS232/RS485

B LB TK100-00 RS485/RS485 required only for VF1000S or line lengths > 1000 m

C Standard cable RS232 9-pole m/f

## Order designation

Order des.	Brief explanation
LB SKK200	Interface converter cable for converting from RS485 to RS232
LB TK100-01	T-coupler with isolation (RS232/RS485)
LB TK100-00	T-coupler with isolation (RS485/RS485)

# CHAPTER 5 ACCESSORIES FOR MASTERDRIVE SERVODRIVES

## Overview:

### Accessories for mounting externally

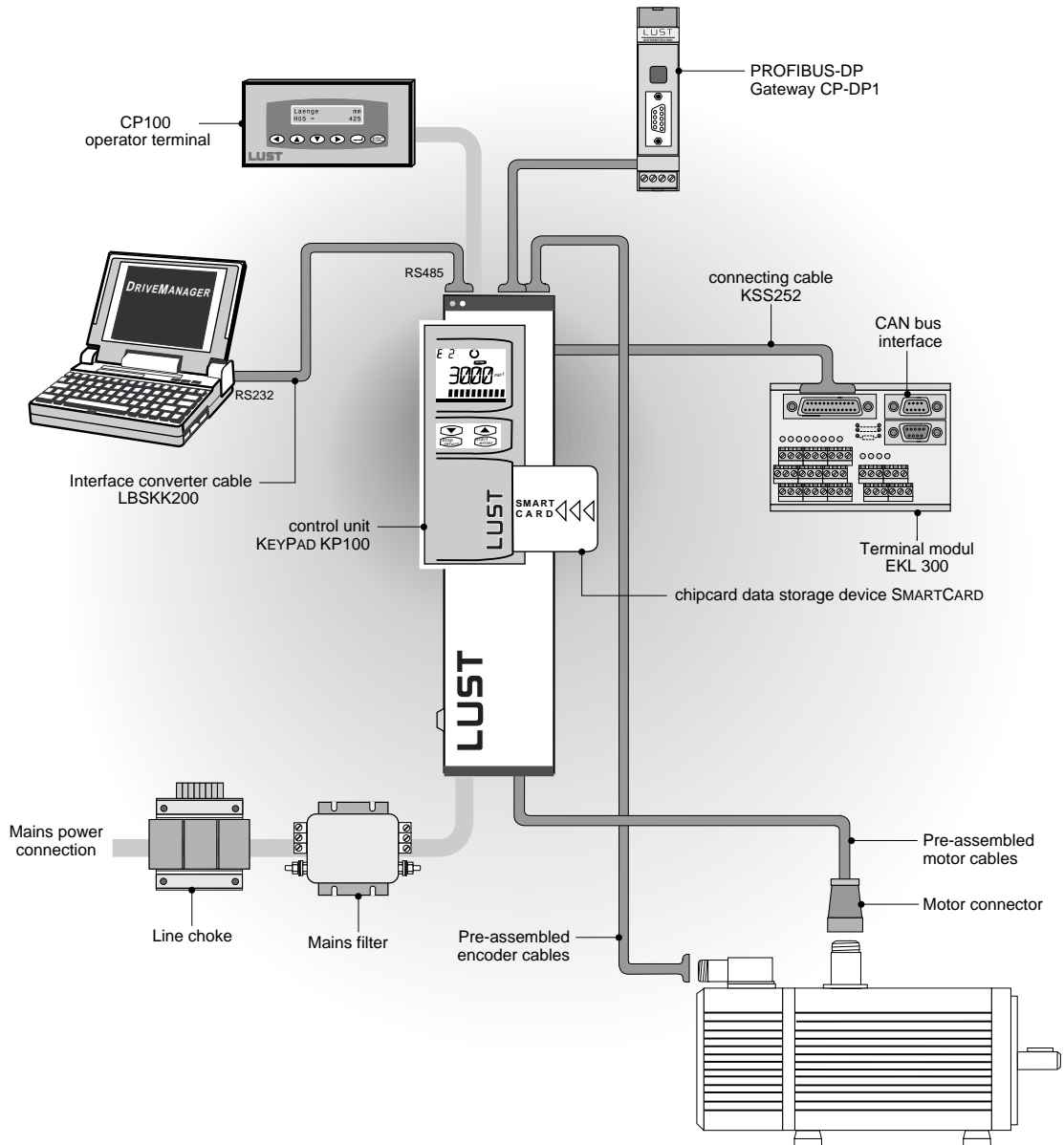

## CHAPTER 5 MAINS FILTERS

The RFI filters for limit curve A are only for industrial, filters for limit curve B of the EMC Directives are also suited for domestic purpose.

The listed filters are suited for 10 m motor cable length. Please ask us for filters for longer cables!

### Technical Specifications

Controller type	Orderdes.	Cable length	Limit curve	Rated current	Leakage current	connections [mm <sup>2</sup> ]
MC7402	NFD10.3	50 m	class B	10 A	< 116 mA	0.2 ... 4
MC7404	NFD10.3	50 m	class B	10 A	< 116 mA	0.2 ... 4
MC7408	NFD10.3	50 m	class A	10 A	< 116 mA	0.2 ... 4
MC7408	NFD10.4	100 m	class B	10 A	< 24 mA	0.2 ... 4
MC7412	NFD25.1	100 m	class A/B*	25 A	< 127 mA	0.2 ... 4
MC7416	NFD25.1	100 m 25 m	class A class B	25 A	< 127 mA	0.2 ... 4
MC7432	NFD50.1	100 m 25 m	class A class B	50 A	< 140 mA	0.5 ... 16
MC7464	NFD80.0	100 m 50 m	class A class B	80 A	< 305 mA	10 ... 25

\* reached through a further use of a mains choke type DNDxx

Nominal voltage: 3 x 480 V AC ± 10 %.

The data applies to the switching frequency of 8 kHz.

### Dimensions

NFD10.3, NFD10.4

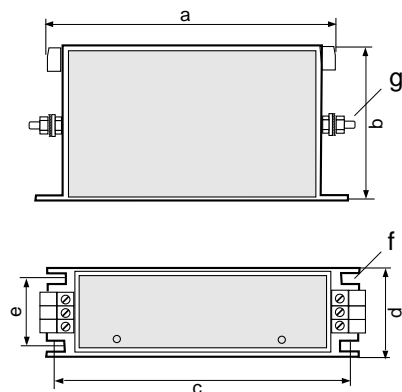

NFD16.2, NFD25.1, NFD50.1, NFD80.0

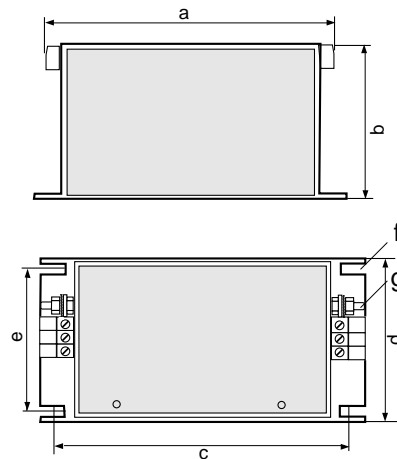

### Table of dimensions

Orderdes.	a	b	c	d	e	Ø f	g
NFD10.3	240	95	230	45	36	Ø 4.5	M5
NFD16.2	255	95	245	73	64	Ø 4.5	M5
NFD25.1	255	95	245	73	64	Ø 4.7	M5
NFD35.0	255	95	245	73	64	Ø 4.7	M5
NFD50.1	290	100	275	90	76	Ø 7	M5
NFD80.0	325	107	310	150	105	Ø 7	M8

All dimensions in mm.

# CHAPTER 5 LINE CHOKES

Line chokes for reducing power supply disturbances such as harmonics and commutation notches.

**Note:** Line chokes are **not** required for compliance with the EMC Directives.

## Technical Data

Controller	Order Designation	Eff. rated Current at 40°C [A]	Power Loss [W]	Inductivity [mH]	Weight [kg]	Terminal [mm <sup>2</sup> ]
MC7402 and MC7404	DND6	6	18	4.8	1.6	4
MC7408	DND14	14	39	1.9	3.8	4
MC7412	DND18	18	51	1.6	3.8	4
MC7416	DND24	24	54	1.2	3.8	4
MC7432	DND45	45	96	0.58	6.5	16
MC7464	DND75	75	108	0.39	9.7	35

Rated voltage: 3 x 380 ... 415 V, other voltages on request

Short circuit voltage  $U_k$ : 4 %

Insulation class: T40/B to VDE0550 / 0532

## Dimensions

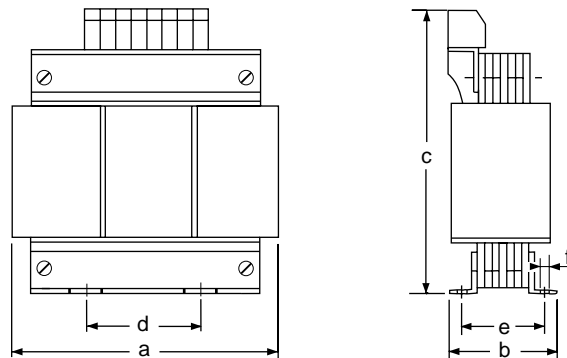

## Table of dimensions

Type	a	b	c	d	e	Ø f
DND6	100	60	105	60	44	4.8
DND14	150	67	167	113	49	5.8
DND18	150	67	167	113	49	5.8
DND24	150	67	190	113	49	5.8
DND45	180	76	195	136	57	7.0
DND75	180	96	195	136	77	7.0

All dimensions in mm.



# CHAPTER 5 CONTROL UNIT KEYPAD KP100

## Control unit KEYPAD KP100

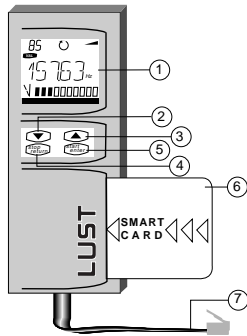

No.	Description	Function
1	LCD display	140 segments, green/red illumination
2	Arrow button up	Move back (scroll) within the menu structure
3	Arrow button down	Move forward (scroll) within the menu structure
4	Stop/Return button	Stop (Menu CTRL), abort or leave selected menu
5	Start/Enter button	Start (Menu CTRL), acknowledge or select menu
6	SMARTCARD	Data memory chip card, unit setting storage (not included)
7	Connecting cable	Max. length 0.35 m

Dimensions: H x W x D  
158 x 62 x 21 [mm]

## SMARTCARD – Data memory chip card

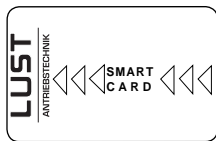

All device settings of the Servocontrollers can be saved on the SMARTCARD. They can be easily transferred to other Servocontrollers.

The SMARTCARD is also used for easy matching of the MASTERCONTROL Servocontrollers to the Servomotor series ASx and PSx featured in this Databook. Choosing the motor-specific SMARTCARD see section 2.

## Order designation

Order designation	Brief description
KP100	KEYPAD multifunction control unit to operate the servocontrollers and frequency inverters
ZSC	SMARTCARD without data, to save and transfer device settings to other servocontrollers

# CHAPTER 5 OPERATOR TERMINAL CP100

## Operator control and monitoring with operator terminal

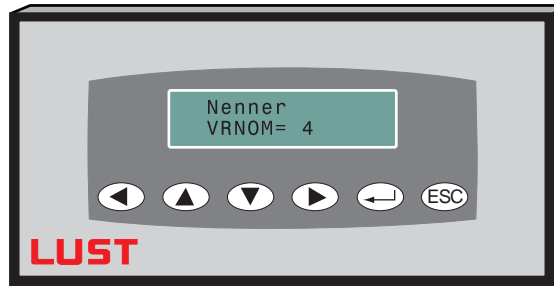

## Properties

Properties	Explanation
LCD display	2 x 16 characters
Suitable for	MC7000 BASIC and MOTION, all modes
Supply	18 V - 30 V, 150 mA, external
Interface	RS485 (simultaneous operation of DRIVEMANAGER and CP100 not possible)
Dimensions H x W x D	72 x 144 x 70 [mm]

The operator terminal is used to input parameters or custom variables, as well as for status display.

The functions include:

- Servocontroller parameters
- Transmission ratio (electronic gearing mode)
- Speed, speed and acceleration (point-to-point positioning mode)

On the operator terminal up to 15 parameters can be displayed and edited. The parameters are selected by way of an input screen within the DRIVEMANAGER user software.



## Order designation

Order designation	Brief description
CP100	Operator terminal to input parameters or custom variables. Available from March 1999.

# CHAPTER 5 ACCESSORIES FOR PROFIBUS-DP

## PROFIBUS-DP Gateway

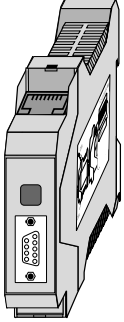
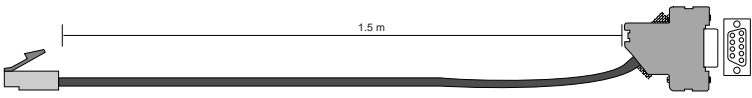
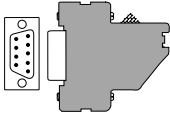
Order designation: CP-DP1

Device	Accessories supplied	
	Gateway cable  8-pin Western plug on 9-pin D-Sub socket	
	Bus termination plug 	Floppy disk with GSD files 

## Technical data

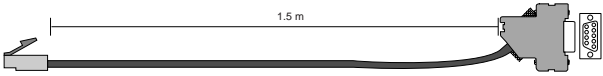
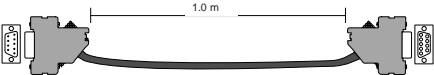
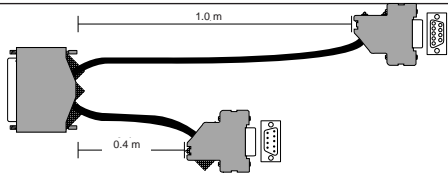
Suitable for servocontroller MC7000	MC7000 BASIC, C11 MC7000 MOTION, C11 MC7000 PosMOD, C11
Hardware/protokoll	DIN 19245 part 1 + part 3 or EN 50170 volume 2
Transfer rate	9.6 KB to 12 MB, adjustable
Transmission range	12000 m to 100 m depending on transfer rate
Stations per gateway	Max. 10 stations
Gateway cable	 Supplied with gateway
Lust system cable I MC7000 MOTION	 Supplied with device
Lust system cable II MC7000 BASIC	
Floppy disk with GSD- and ASCII files	Supplied with gateway
Bus termination plug	Supplied with gateway
PPO (Parameter Process data Objects)	PPO types 1 and 3 are supported
Power supply	24 V DC $\pm$ 20 %
Current consumption	1.2 A DC $\pm$ 10 %
Mounting type	35 mm standard profile rail
Dimensions	22.5 x 99 x 119 mm (WxHxD)
Ambient temperature	0 - 50 °C non-condensing

# CHAPTER 5 WIRING ACCESSORIES

## Wiring example MC7000 BASIC, C11

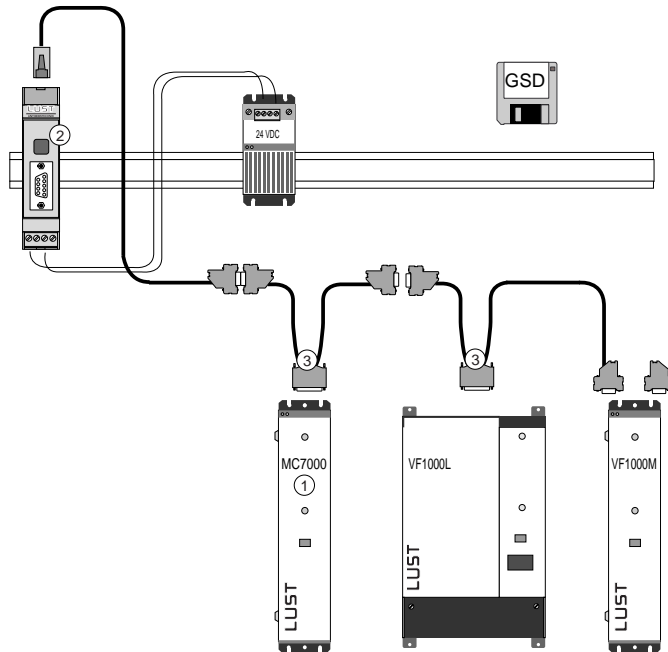

**Required components:**

- 1 Servocontroller MC7000 MOTION, C11
- 2 PROFIBUS-DP Gateway CP-DP1
- 3 Lust system cable II

## Wiring example MC7000 MOTION, C11

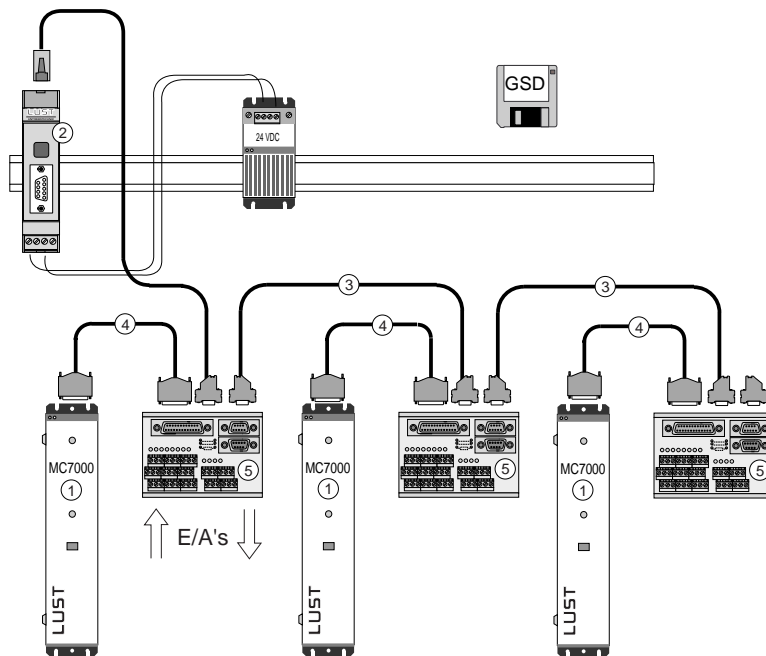

**Required components:**

- 1 Servocontroller MC7000 MOTION, C11
- 2 PROFIBUS-DP Gateway CP-DP1
- 3 Lust system cable I
- 4 Connecting cable KSS252
- 5 Terminal module EKL300

# CHAPTER 5 EXTERNAL MODULES FOR SERVOCONTROLLERS

## Accessories for external installation

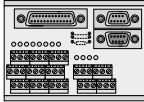
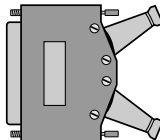
Order Designation	Description	Servocontroller
<p data-bbox="422 387 507 409">EKL300</p> 	<p data-bbox="566 387 1204 488">Terminal module for forced wiring of application hardware. For MC74xx Servocontrollers with CAN-Bus interface and also for bus connection using 2 x 9 pin Sub-D connector. Excluding KSS252 cable.</p> <ul data-bbox="566 499 1204 638" style="list-style-type: none"> <li>• 3-wire technology (signal, +24v and ground) for easy connection of initiators</li> <li>• maximum load on outputs: 50 mA (AH1 and AH6), 500 mA (AH2) short circuit proof</li> <li>• Z rail installation, dimension w x h x d = 113 x 78 x 72 mm</li> </ul> <p data-bbox="566 645 1204 701"><b>Note:</b> Please order the Cable to link Servocontroller and EKL300 terminal module as a separate position.</p>	<p data-bbox="1257 387 1412 409">MC7000,..., C11</p>
<p data-bbox="422 728 507 750">KSS252</p>	<p data-bbox="566 728 1109 779">Cable to link Servocontroller and EKL300 terminal module Cable length 1.8m.</p>	<p data-bbox="1321 728 1348 750">all</p>
<p data-bbox="402 810 526 833">SC-KSG185</p>	<p data-bbox="566 810 1173 891">Connector with metallized housing. For wiring the CAN-Bus line at the 25 pin Sub-D connector of the MC7000. With protection against bending and with cable stress reduction.</p> <p data-bbox="566 913 1189 936">The cable connector can also be used to wire the PROFIBUS-DP.</p> <p data-bbox="646 981 798 1081">Manufacturer: ERNI, KSG185 series, 25-pin male</p> 	<p data-bbox="1257 810 1412 833">MC7000,..., C11</p>

# CHAPTER 5 READY-MADE ENCODER CABLES

We recommend for compliance to the EMC directives: Mains filter, screened control and motor cable, **original encoder cable** and effective grounding for high frequencies.

## Order/type designation

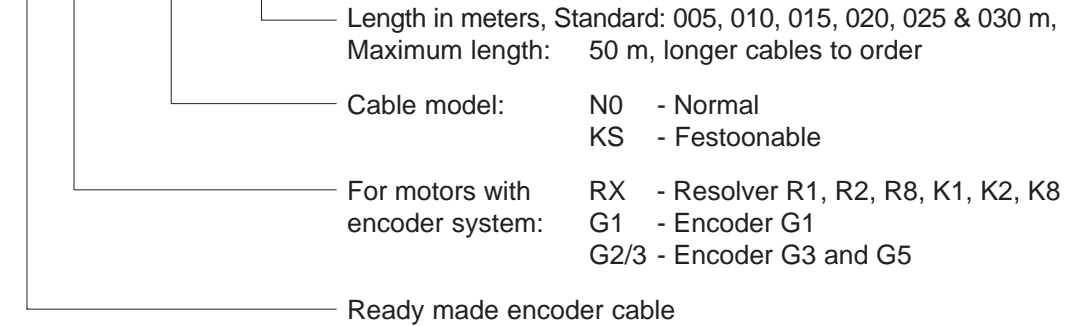

## Example

**KRX - N0 005**

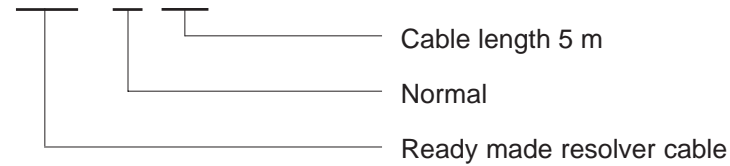

## Technical data

	Unit	KRX-N0xxx	KRX-KSxxx	KG1-KSxxx	KG2/3-KSxxx
Servocontroller type		all (not for design code D2)		MC6000, D2 MC7000, D2	
Motors with encoder system		R1, R2, R8, K1, K2, K8		G1	G3, G5
Festoonable		no	yes	yes	
Minimum bending radius:					
fixed installation	mm	60	60	40	
flexible use	mm	not permissible	120	100	
Temperature range:					
fixed installation	°C	- 30 ... + 70	- 10 ... + 70	- 35 ... + 80	
flexible use	°C	not permissible	- 10 ... + 70	- 10 ... + 80	
Cable diameter approx.	mm	9.9	9.4	8.0	
Outer sheath material		PVC	PUR	PUR	
Resistance		flame retardant	flame retardant, resistant to moisture and	resistant to oil, moisture and microbes (VDE0472)	

# CHAPTER 5 READY-MADE MOTOR CABLES

We recommend the ready-made screened motor cables for compliance to the EMC directives.

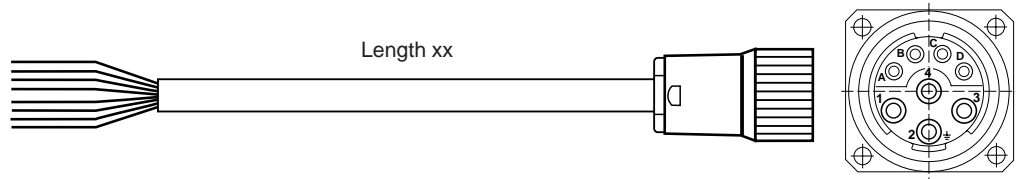

## Order/type designation



Length in meters, Standard: 005, 010, 015, 020, 025 & 030 m, Maximum length: 50 m, longer cables to order

Cable model: N0 - Normal  
KS - Festoonable

Type 1 and 2: For connection of PTC and holding brake 4 x 1.5 mm<sup>2</sup> + 2 x (2 x 0.25 mm<sup>2</sup>) with complete screening and crimped contacts

Motor Cable

## Example

**KM1 - N0 005**

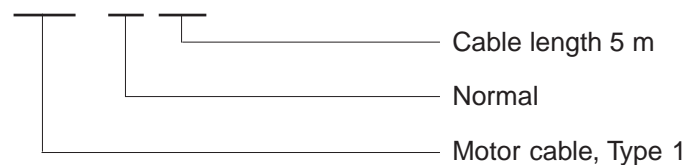

## Technical data

	Unit	KM1-N0xxx	KM1-KSxxx	KM2-KSxxx
Festoonable		no	yes	
Motor types		Motors up to 16 A rated current with mains connector		
Minimum bending radius:: fixed installation flexible use	mm mm	65 -	30 100	60 120
Temperaturbereich: fixed installation flexible use	°C °C	- 30 ... + 80 -	- 50 ... + 90 - 50 ... + 90	- 50 ... + 90 - 50 ... + 90
Cable diameter approx.	mm	12.5	10	12.5
Outer sheath material		PVC	PUR	PUR
Resistance		flame retardant	flame retardant resistant to moisture and microbes	flame retardant VDE0472- 804/A
designations of wires		U = black V = blue W = brown		U = 1 V = 2 W = 3

# CHAPTER 5 MOTOR ACCESSORIES

**Motor connector** Connector for motors with power connector (straight or 90° angled )

**Order/type designation** **SM - LPNA 08B NNNN 170**



Manufacturers: Interconnectron, Munich

With accessories: 4 power and 4 signal contacts, for soldering (only suitable for fixed cabling); cable clamping  $\varnothing$  12 mm, installation plan

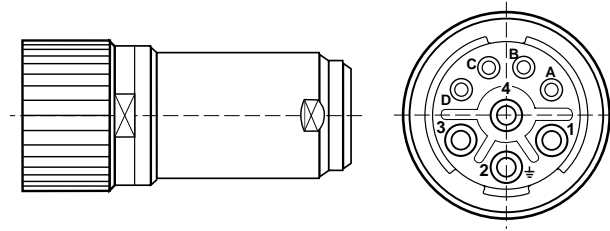

**Please note:**

Only crimped contacts are permissible for flexible installation, (eg festoonable cables) as repeated movement fractures the cable at the soldered joint.

**Resolver connector** Connector for motors with Resolver

**Order/type designation** **SG - SPNA 12B NNNN 169**

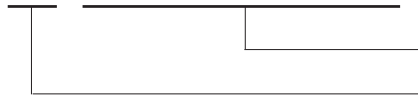

Manufacturers: Interconnectron, Munich

With accessories: 12 signal contacts, for soldering (only suitable for fixed cabling); cable clamping  $\varnothing$  12 mm, installation plan

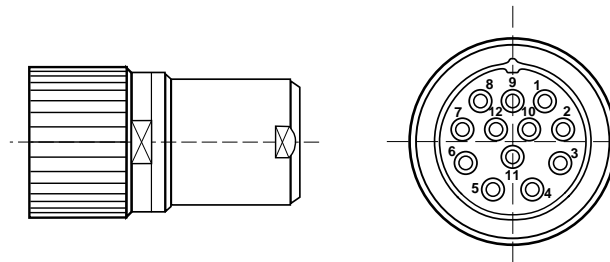

**Please note:**

Only crimped contacts are permissible for flexible installation, (eg festoonable cables) as repeated movement fractures the cable at the soldered joint.

**Coupling** for motors with mounting flange (design code K1, K2, K8)

**Order/type designation** **FK - BSK 33 02 33**

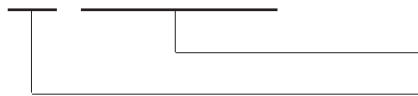

Manufacturers: Bäuerle, St. Georgen (Germany)

Coupling,

Dimensions (D1 / D2 / L): 9.52 <sup>(3/8)</sup> / 6 / 22 mm

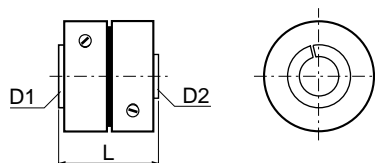



## CHAPTER 5 USER INFORMATION

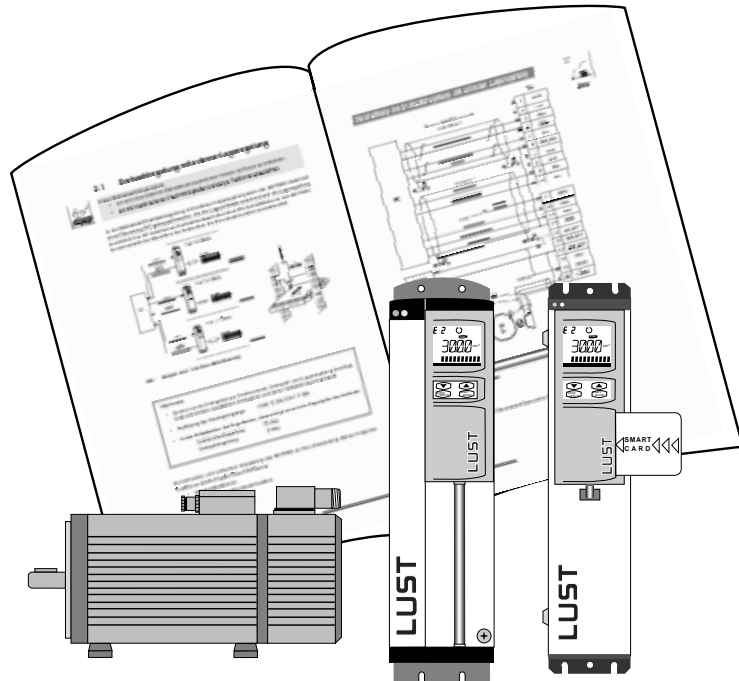

### Servocontroller

Series	Order-No.	Language	Description
MC6000	0792.00B.0	German	Operation manual
	0792.20B.0	English	Operation manual
	0792.04B.2	German/ English	Version description AH4 (12 Bit analog output)
	0792.02B.0	German/ English	Retro-fitting of accessory

MC7000	0808.02B.2	German	Operation manual, BASIC/MOTION
	0808.22B.0	English	Operation manual, BASIC/MOTION
	0808.00B.1	German	Operation manual for MC7402 + MC7404 up to software revision 1.65
	0808.21B.0	English	Operation manual for MC7402 + MC7404 up to software revision 1.65
	0808.03B.2	German/ English	Version description AH7 (12 Bit analog output)
	0808.07B.0 27	German English	Operation manual, PosMod
	0808.08B.0 28	German English	Reference manual, PosMod
	0808.09B.0 29	German English	Programming manual, PosMod

## CHAPTER 5 USER INFORMATION

### Accessory

Series	Order-No.	Language	Description
KEYPAD KP100	A021.02B.0	German	Operation manual KEYPAD
	A021.21B.0	English	Operation manual KEYPAD
DRIVEMANAGER	0842.01B.2	German/ English	User manual for PC software package DRIVEMANAGER

### Non-product-specific information sources

for Series	Order-No.	Language	Description
MC6000/7000	A040.02B.0	German	LUSTBUS data transmission protocol
MC6000/7000	A040.22B.0	English	LUSTBUS data transmission protocol
MC6000/7000	A047.02B.0	German	CAN-Bus data transmission protocol
MC6000/7000	A047.22B.0	English	CAN-Bus data transmission protocol
MC6000	0718.50B.0	German	INTERBUS-S data transmission protocol
MC6000	0718.51B.0	English	INTERBUS-S data transmission protocol
MC6000/7000	0792.50B.0	German	Installation manual for net-working with LUSTBUS and CAN-Bus
MC6000/7000	0792.51B.0	English	Installation manual for net-working with LUSTBUS and CAN-Bus
MC6000/7000	0792.06B.0	German	Description of parameters

