

be in motion be in motion

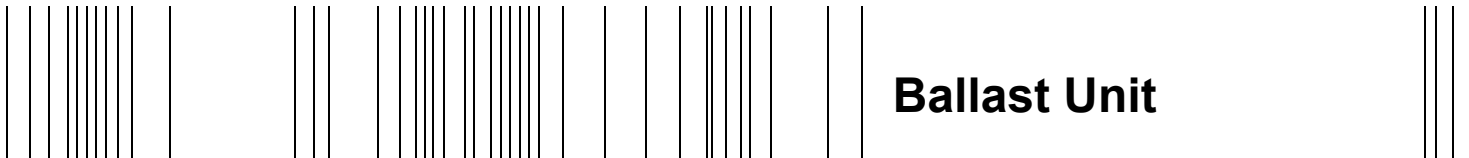

POWER CONVERSION EQUIPMENT



Ballast Unit

BUB 622

Manual

| | |
|----------|-------------|
| E | 5.96146.05a |
|----------|-------------|



BAUMÜLLER

| | |
|--------------|--|
| Title | Manual |
| Product | Ballast Unit, BUB 622 |
| Version | 5.96146.05a |
| Status | 2004-12-28 |
| Copyright | <p>These operating instructions may be copied by the owner in any quantity but only for internal use. For other purposes these operating instructions and extracts thereof must not be copied or reproduced.</p> <p>Use and disclosure of information contained in these operating instructions are not permitted.</p> <p>Designations and company marks contained in these operating instructions may be brand names, the use of which by third parties for their own purposes may violate the rights of the holders.</p> |
| Obligatory | <p>These operating instructions are part of the equipment/machine. These operating instructions must be available to the operator at all times and must be in a legible condition. If the equipment/machine is sold or moved to a different location these operating instructions must be passed on by the owner together with the equipment/machine.</p> <p>After any sale of the equipment/machine this original and all copies must be handed over to the buyer. After disposal or any other end of use this original and all copies must be destroyed.</p> <p>When the present operating instructions are handed over, corresponding sets of operating instructions of a previous version are automatically invalidated. Please notice that specifications/data/information are current values according to the printing date. These statements are not legally binding according to the measurement, computation and calculations.</p> <p>Baumüller Nürnberg GmbH reserves the right, in developing its products further, to change the technical specifications and the handling of the products concerned without prior notice.</p> <p>No liability can be accepted concerning the correctness of the operating instructions unless otherwise specified in the General Conditions of Sale and Delivery.</p> |
| Manufacturer | <p>Baumüller Nürnberg GmbH Ostendstr. 80 - 90 D-90482 Nürnberg Germany Tel. +49 9 11 54 32 - 0 Fax: +49 9 11 54 32 - 1 30 www.baumueller.de</p> |

TABLE OF CONTENTS

1 Safety Notes 5

2 Technical Data 9

 2.1 General information 9

 2.1.1 Description of Function 9

 2.1.2 Block Diagram 10

 2.2 Electrical Data 11

 2.3 Type key 12

3 Transportation, Unpacking 13

4 Mounting 15

 4.1 Dimensions 16

 4.2 Assembly Information 18

 4.3 Fastening 18

5 Installation 19

 5.1 Security information 19

 5.2 EMC information 20

 5.3 Connection diagram 26

 5.3.1 Connection to BUM 62 27

 5.3.2 Connection to BUM 63 28

 5.3.3 Connection to BUM 64 (2 units V. 1-4, max. 1 unit V. 5) 29

 5.4 Pin Assignments 31

6 Commissioning 33

 6.1 Danger information 33

 6.2 Flow diagram 35

 6.3 Operation 36

 6.4 Messages and Warnings 37

 6.5 Select the ballast resistor 38

7 Maintenance 41

 7.1 Maintenance Information 41

 7.2 Disposal 42

8 Appendix 43

 8.1 Declaration by Manufacturer 43

 8.2 Declaration of Conformity 44

 8.3 General Conditions of Sale and Delivery 45

 8.4 Index 48

ABBREVIATIONS

| | |
|------|-------------------------------|
| AC | Alternating current |
| AM | Asynchronous motor |
| BMS | Baumüller Modular System |
| BUB | Baumüller Ballast Unit |
| BUC | Baumüller Feed/Feed back Unit |
| BUG | Baumüller Power Supply Unit |
| BUM | Baumüller Mono Power Unit |
| BUS | Baumüller Servo Power Unit |
| DC | Direct current |
| EMC | Electromagnetic compatibility |
| EN | European norm |
| HS | Main contactor |
| NN | Height above Sea Level |
| PELV | Protected low voltage |
| SELV | Secure low voltage |
| SM | Synchronous motor |
| ZK | Intermediate circuit |

1 SAFETY NOTES

Introductory remarks

During operation, the principles on which the converter and motor work, lead to leakage currents to earth which are dissipated by use of the specified protective earth connections which may result in a current-operated e.l.c.b. on the input side blowing prematurely.

A DC component in the fault current may occur in the event of a short-circuit to frame or earth fault which could make triggering of the higher-level current-operated e.l.c.b. more difficult or even impossible.

Connection of the current controller to the mains using only the current-operated e.l.c.b. is prohibited (preliminary standard EN 50178 / VDE 0160 / 11.94, sections 5.2.11 and 5.3.2.1).

The units are protected against direct contact by being installed into common switching cabinets which meet the minimum protection requirements according to pr EN 50178 / VDE 0160 / 11.94, section 5.2.4.

Sheets of plastic covering the control electronics, the power stage and the device connection, additionally prevent accidental contact during commissioning and casual use of control elements located close to the equipment.

(DIN VDE 0106 Part 100, Accident Prevention Regulation VBG4 "Electrical Systems and Equipment). The protective measures and safety regulations according to DIN/VDE are binding for personal security.

Neglecting to fit PE connections on the equipment or the motor will result in serious personal injury and/or considerable damage of property.

General information

These operating instructions contain the information required for the application as directed of the products described herein. The document is intended for specially trained, skilled personnel who are well-versed in all warnings and maintenance activities. The units are manufactured using the state-of-the-art technology and are safe in operation. They can be installed safely, commissioned and function without problems if the safety information below is observed.



DANGER

When operating this electrical unit, some parts of the equipment always carry dangerous voltage.

Ignoring these safety instructions and warnings may result in death, serious personal injury and/or damage of property.

Only qualified personnel who are familiar with the safety information, mounting, operation and maintenance instructions may carry out work on this unit.

Danger information

One the one hand, the information below is for your own personal safety and on the other to prevent damage to the described products or units connected to it.

In the context of the operating instructions and the information on the products themselves, the terms used have the following meanings:



DANGER

This means that **death, severe personal injury or considerable property damage will occur**, unless appropriate safety measures are taken.



WARNING

This means that **death, severe personal injury or considerable property damage may occur**, unless appropriate safety measures are taken.

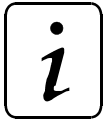

NOTE

This draws your attention to **important information** about the product, handling of the product or to a particular section of the documentation.

Qualified personnel

Qualified personnel in the sense of the safety-relevant information in this document or on the products themselves, qualified personnel are considered to be persons who are familiar with setting up, mounting, commissioning and operating the product and who have qualifications appropriate to their activities.

- Trained or instructed or authorised to commission, ground and mark circuits and equipment in accordance with recognized safety standards.
- Trained or instructed in accordance with recognized safety standards in the care and use of appropriate safety equipment.

Application as directed



WARNING

You may only use the unit/system for the purposes specified in the operating instructions and in conjunction with the third-party equipment and components recommended or authorised by BAUMÜLLER NÜRNBERG Electronic GmbH&Co.

For safety reasons, you must not change or add components on/to the unit. The operator must report immediately any changes that occur which adversely affect the safety of the unit/system.

Voltage test

BAUMÜLLER carries out a voltage test according to prEN 50178 / VDE 0160 /11.94, Section 9.4.5 for each unit.

Subsequent high-voltage tests must only be carried out by BAUMÜLLER NÜRNBERG GmbH.



WARNING

If you want to carry out high-voltage tests for complete switch cabinet installations, disconnect all cables from BAUMÜLLER units prior to the test.

2 Technical Data

2.1 General information

The ballast unit **BUB 622** is specially designed for the operation with power units BUM 62, 63, 64. The ballast resistor is connected external and therefore the resistance can be adapted to the drive's operational conditions.

In case of dynamic braking three-phase motors feed-back power and increase the intermediate circuit voltage. This energy has to be dissipated, because it is a danger to the power unit.

If a BUB 622 is used while braking, the energy from the intermediate circuit of the unit will be switched to the ballast resistor and converted in heat there.

By a parallel connection of several units BUB 622 (not BUB 622 version 5, see below) the maximum ballast current can be increased. Units BUM 64 need 2 ballast units BUB 622 version 1 to 4 (not BUB 622 version 5) on principle.

The BUB is supplied from the intermediate circuit and therefore is independent of external power supplies. Extensive monitoring equipment guarantees secure operation.

To meet safety demands it is also possible to rapidly discharge the DC link by use of a control input.

Characteristics

- Internal power supply which supplies the control electronic and makes the unit independent of external low voltage supply.
- By parallel connection (not version 5) the whole ballast power can be increased. The several ballast units are loaded equally.



NOTE

BUB 622 of version 5 cannot be switched in parallel, because there is no synchronous switching circuit built in. If you intend to use two or more BUB 622 units to dissipate the feed-back energy, use versions 1 to 4.

- The devices can be lined up next to the BUM 62,63,64 series.
- The power unit is protected against short circuit, overload and over temperature.

2.1.1 Description of function

Basically the BUB 622 unit consists of power supply, controller electronic and a power switch. If the controller electronic detects high intermediate circuit voltage, the power driver stage will trigger the power switch (IGBT). The surplus energy will be converted into heat. If the intermediate circuit voltage is lower than the switch-off threshold, the power switch will disconnect the ballast resistor.

An internal symmetry circuit (not realized in version 5) makes it possible to connect several ballast units (of versions 1 to 4; not version 5) in parallel.

Temperature, ballast current and switching interval are measured and monitored regularly. If a threshold is exceeded, an error will be generated and the „ready for use“ signal is cancelled. The internal power supply is supplied by the intermediate circuit of the connected unit and therefore is independent of external power supply.

2.1.2 Block diagram

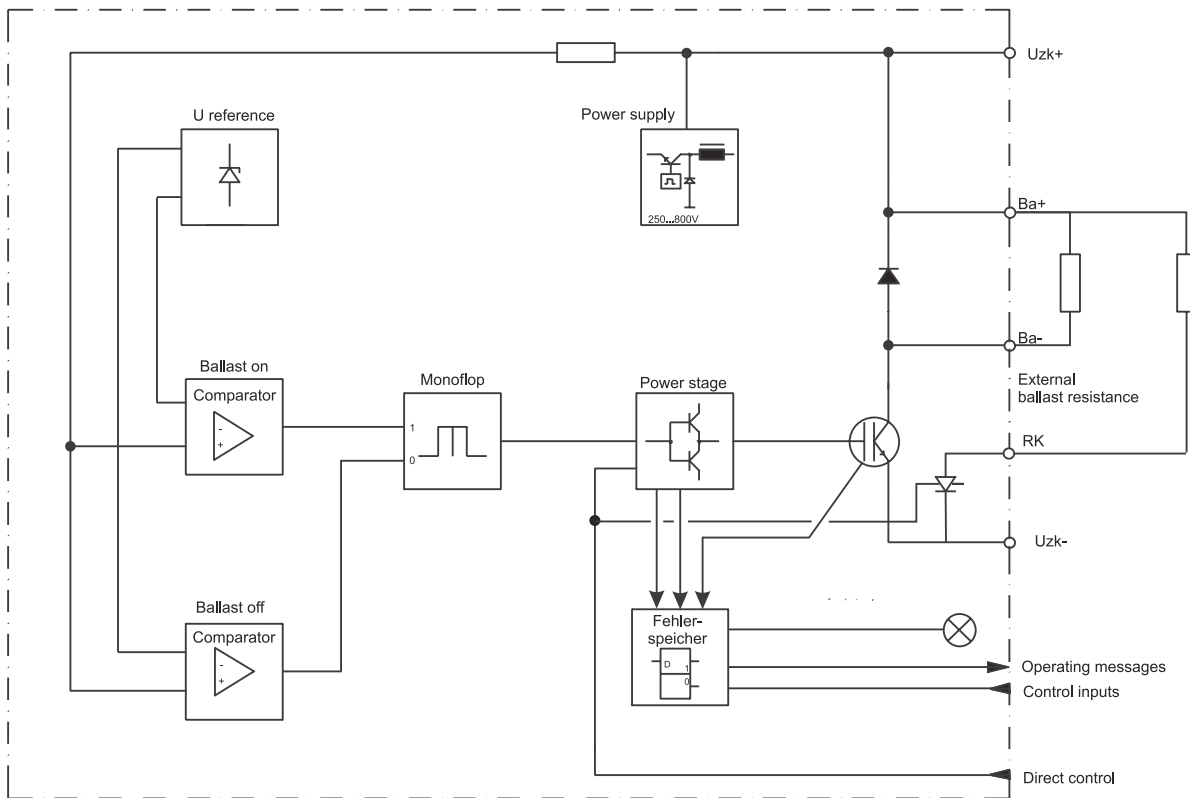

2.2 Electrical data

| Type | BUB 622-100-54-E-xx1 to BUB 622-100-54-E-xx4 | BUB 622-100-54-E-xx5 (version 5) ⁵⁾ |
|---|---|---|
| Connection voltage | 250...800 V _{DC} | |
| Nominal intermediate circuit voltage | 540 V _{DC} | |
| Max. ballast current | 100 A | |
| Max. ballast power | 75 kW | |
| Operation mode ⁴⁾ | S3 25% 90 s | |
| Electronic power supply consumption | 10 W | |
| Ballast switching-threshold on (BST-on) | 760 V _{DC} ±20V | 785 V _{DC} |
| Ballast switching-threshold off (BST-off) | 730 V _{DC} | 765 V _{DC} |
| External ballast resistance R _B ¹⁾ Power ballast resistance | ≥ 7.5 Ω Power on demand up to nominal power | |
| Cross-section of cable ²⁾ | 16 mm ² | |
| Rapid discharge of DC link Discharge peak current External discharging resistor Power of discharging resistor Max. cycle time Max. brakeable rotating mass Max. capacity of DC link | 800 A ≥ 1 Ω max. 1000 W 5 min. (timeout between 2 rapid discharge cycles must be at least 5 minutes) J = 1000 kgcm ² c = 20000 μF | |
| Ambient operational temperature range T _B ³⁾ | 0...45 °C (with power reduction 55 °C) | |
| Coolant temperature range T _K ³⁾ | 0...45 °C (with power reduction 55 °C) | |
| Max. site altitude w/o power reduction | 1000 m above MSL | |
| Power reduction | 1,5 % / 100 m above 1000 m | |
| Degree of protection | IP20 | |
| Relative humidity | 15 %...85 % no condensation | |
| Storage temperature range | 25 °C...+70 °C | |
| Dimensions (W x H x D) | 99 x 360 x 280 mm | |
| Weight | 7.5 kg | |

1. A minimum resistance value of lower than 7.5 Ω is not permitted. Otherwise you run the risk of malfunction or even damage of the appliances.
2. Recommended minimum cross-section at nominal current.
3. Power reduction of 3% / K above 45 °C.
4. When overload monitoring is not active: 120 s / 10 min. cycle.
5. Version 5 cannot be switched in parallel because it is not equipped with synchronous switching circuit.

2.3 Type key

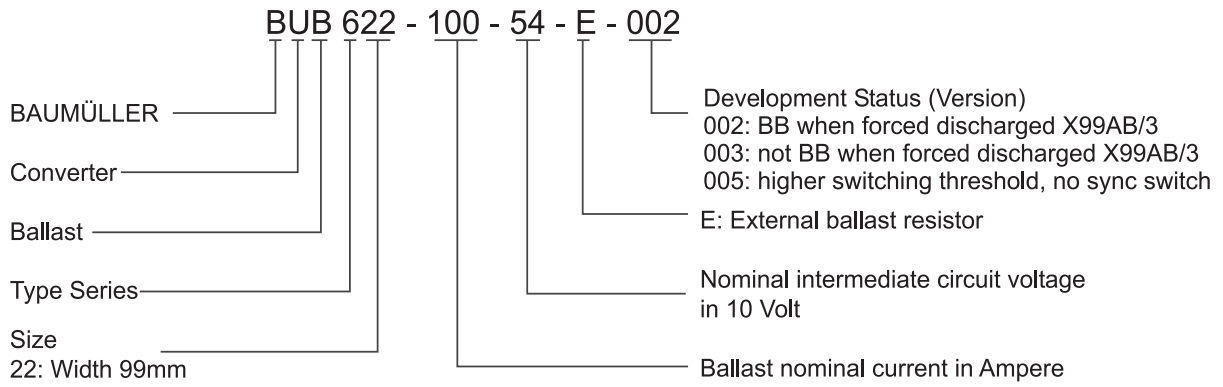

3 TRANSPORTATION, UNPACKING

The units are packed at the factory in accordance with the order.

You should avoid bumping or dropping the package while in transport, e.g. when lowering the unit.

Start assembly after unpacking and checking that the equipment is complete and undamaged.

The equipment is packed in cardboard, corrugated sheeting and/or wooden packaging that you should dispose of in accordance with local regulations.

Immediately report any damage that has occurred in transport.



DANGER

If the unit was damaged in transit, a qualified person must check, repair and test it before it may be connected.

Ignoring this information can result in death, serious personal injury or considerable damage of property.

4 MOUNTING



WARNING

The user is responsible for the mounting of the unit described, the motor, and the other devices according to the respective safety regulations (e.g. EN, DIN, VDE) and all other relevant national or local regulations concerning the conductor dimensioning and protection, grounding, disconnectors, over-current protection, etc.

Ensure that there is no blockage of cooling air flow in and out of the appliance and that there is enough space above and below the equipment to prevent overheating.

Sheets of plastic on the devices that cover the electrical connections act as additional guards preventing accidental contact at commissioning and in the case of casual use of control elements located close to the appliance (DIN VDE 0106 Part 100, Accident Prevention Regulation VBG4 „Electrical Systems and Equipment“).

4.1 Dimensions

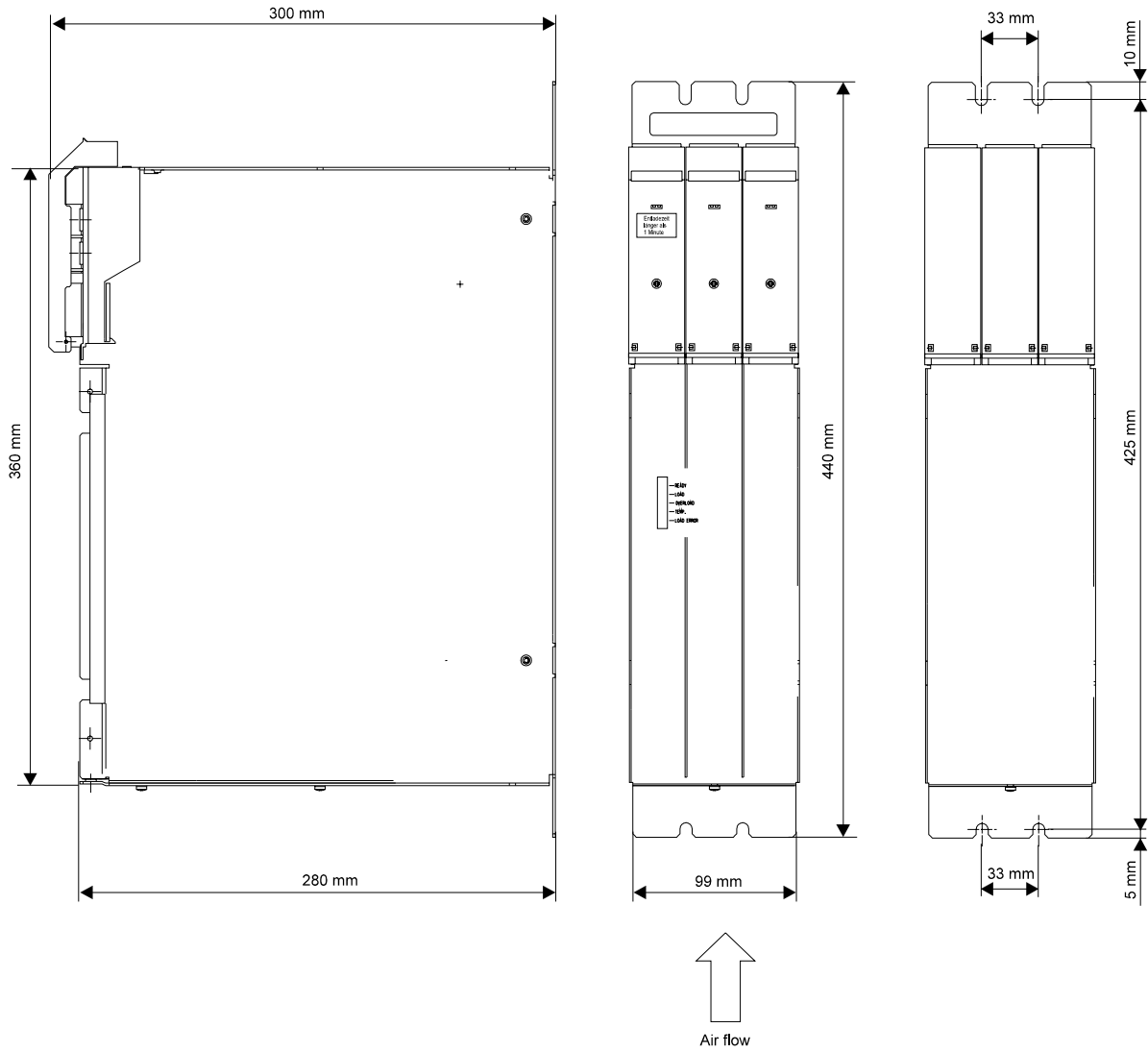

Drilling template to attach the ballast unit with units BUM 62, 63, 64

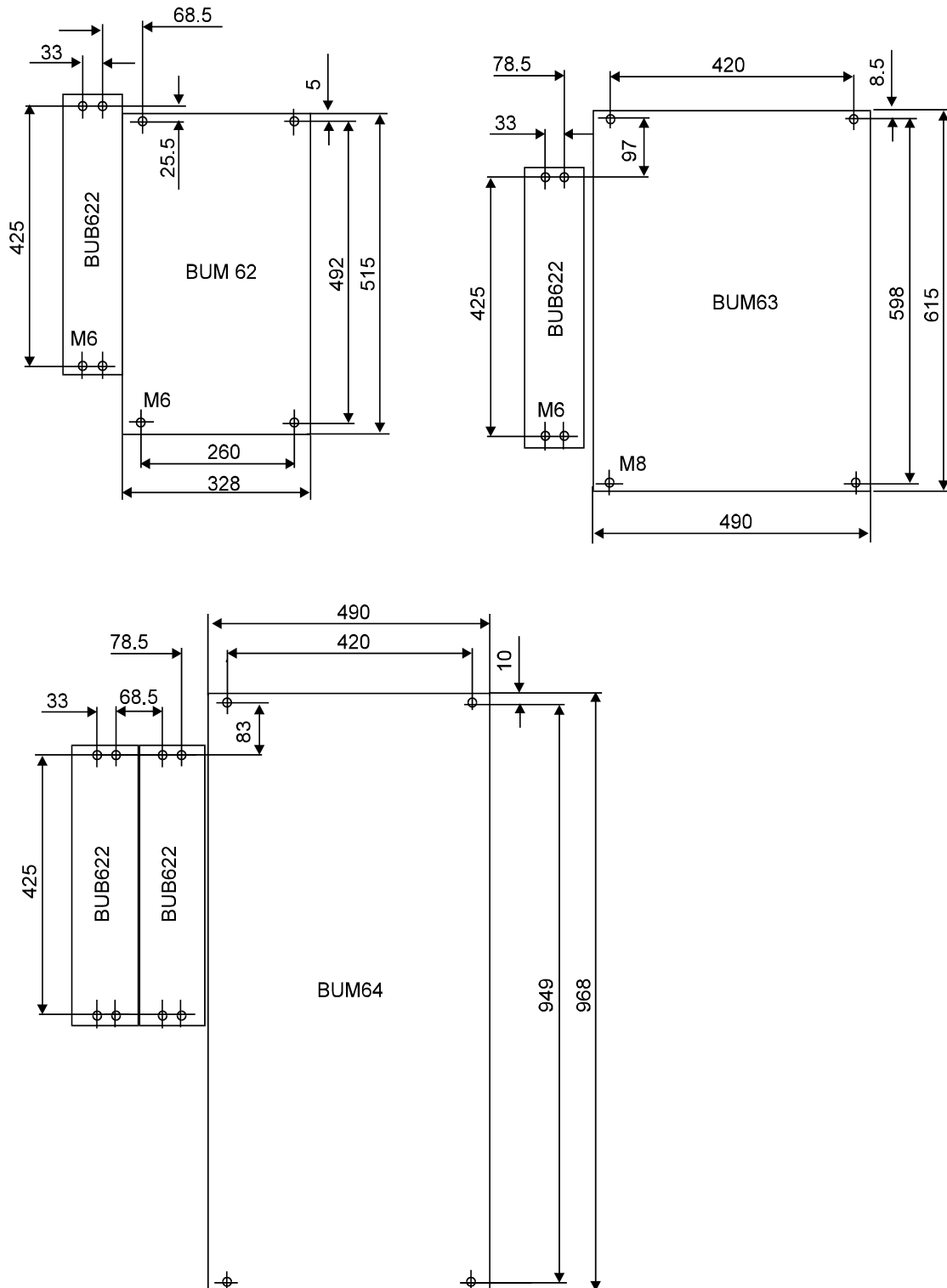

4.2 Assembly information

- The ballast unit BUB 622 meet protective system IP20. Install the units vertically in a switching cabinet.
Mount the unit BUB 622 next to the power units. Connect the ballast unit using the supplied connecting rails on the front rails of the unit.
The connection between ballast resistors and power unit must be as short as possible.
Connection look EMC information.



DANGER

Longer rails as the supplied connecting rails are not allowed, since otherwise there is a risk of destroying the device!



WARNING

It is crucial to comply with the ventilation measures listed below. Ignoring these measures can lead to the device overheating.

- Ventilation must be in the specified direction from the bottom to the top.
- Ensure that the flow of air is not obstructed.
- There must be a minimum clearance above and below the devices of 100 mm and you must ensure that there is enough cooling air that can circulate freely!
- The temperature of the coolant 50 mm below the devices may be up to 45 °C. At higher temperature (up to a maximum of 55 °C), you must reduce the power of the devices by 3% per degree Celsius.
- Do not locate any additional sources of heat above or below the devices.
- You must avoid degrees of contamination 3 and 4 according to provisional standard EN 50178:1994 Section 5.2.15.2. The devices are suitable for use in enclosed workshops (VDE 0558 Part 1a, Sections 5.4.3.2.1 and 5.4.3.2.2).
- The live parts take more than one minute to discharge.
- Relative damp < 85%. No fog or water is allowed to seep into the device. No dust should be get into the unit. The unit must be protected against aggressive gas and liquids.

4.3 Fastening

Fasten the unit via the back panel in the switching cabinet.

With devices that are mounted next to one another, the back panels must be in contact with one another.

5 INSTALLATION

5.1 Security information



WARNING

This appliance conducts dangerously high voltages and has dangerous rotating parts (fans). Ignoring the safety- and warning information may result in death, severe personal injury or damage of property.

The machine operator is responsible for mounting the power unit, the motor, the transformer and any other equipment in accordance with respective safety regulations (e.g. DIN, VDE); In Addition, you must ensure that all other relevant national and local regulations are met with regard to cable dimensioning and protection, grounding, disconnectors, overcurrent protection, etc.

Variable-speed drives are to be operated in applications that correspond to valid EN specifications only.



DANGER

The intermediate circuit carries voltage! Use supplied plastic cover!

Be particularly careful before touching the drive shaft directly or indirectly with your hands. This is only allowed when the system is deenergized and the drive is stationary.

Basicly, safety devices must never be deactivated!

5.2 EMC information

General information about converters

Modern semiconductor technologies such as MCTs and IGBTs are intended to minimize the power loss in the converter by switching more rapidly and, with this, to continually reduce the size of the power section. As a result, when running converters you must meet specific conditions to avoid electromagnetic influences caused by switching operations.

Disturbances can occur due to:

- capacitive fault currents caused by high rates of voltage rise when bipolar transistors and IGBTs switch.
- high currents and high rates of current rise in the motor lines. The disturbance energy bound in magnetic fields reaches frequencies of between a few Hertz and about 30 MHz. Due to the high rates of current rise, additional electromagnetic fields occur with frequencies of up to approximately 600 MHz.
- high clock rates and fast logic circuits (electromagnetic field/16 MHz...1 GHz).
- system perturbation and harmonics caused by commutations and non-sinusoidal network loading, in particular with line-commutated converters (100 Hz... 20 kHz).

German EMC Law (EMVG)

This converter complies with Paragraph 5, Section 5, Sentence 3 of the German EMC Law (EMVG) dated 09.11.92.

„Devices that are exclusively manufactured or stocked as vendor parts or spare parts for further processing by industrial companies or craftsmen or by other specialists in the field of electromagnetic compatibility do not need to comply with the protective requirements of Paragraph 4, Section 1, nor do they need EU conformity certification and marking, assuming that the devices in question cannot be run automatically.“

This refers to the fact that EMC is heavily dependent on the individual subassemblies and components in the switching cabinet. With regard to the total costs of the machine, it is preferable to troubleshoot an entire system rather than each of its individual components.

The information on the next few pages is intended to allow you to configure your system on the basis of the latest knowledge in the field of EMC and to comply with legal regulations.

Measures for ensuring EMC

To ensure EMC, you must observe the configuration information below.

Cabling

- To suppress radiated disturbance outside the converter, you should screen **all** the connected cables. Also observe the topics in the section entitled „Screening“.

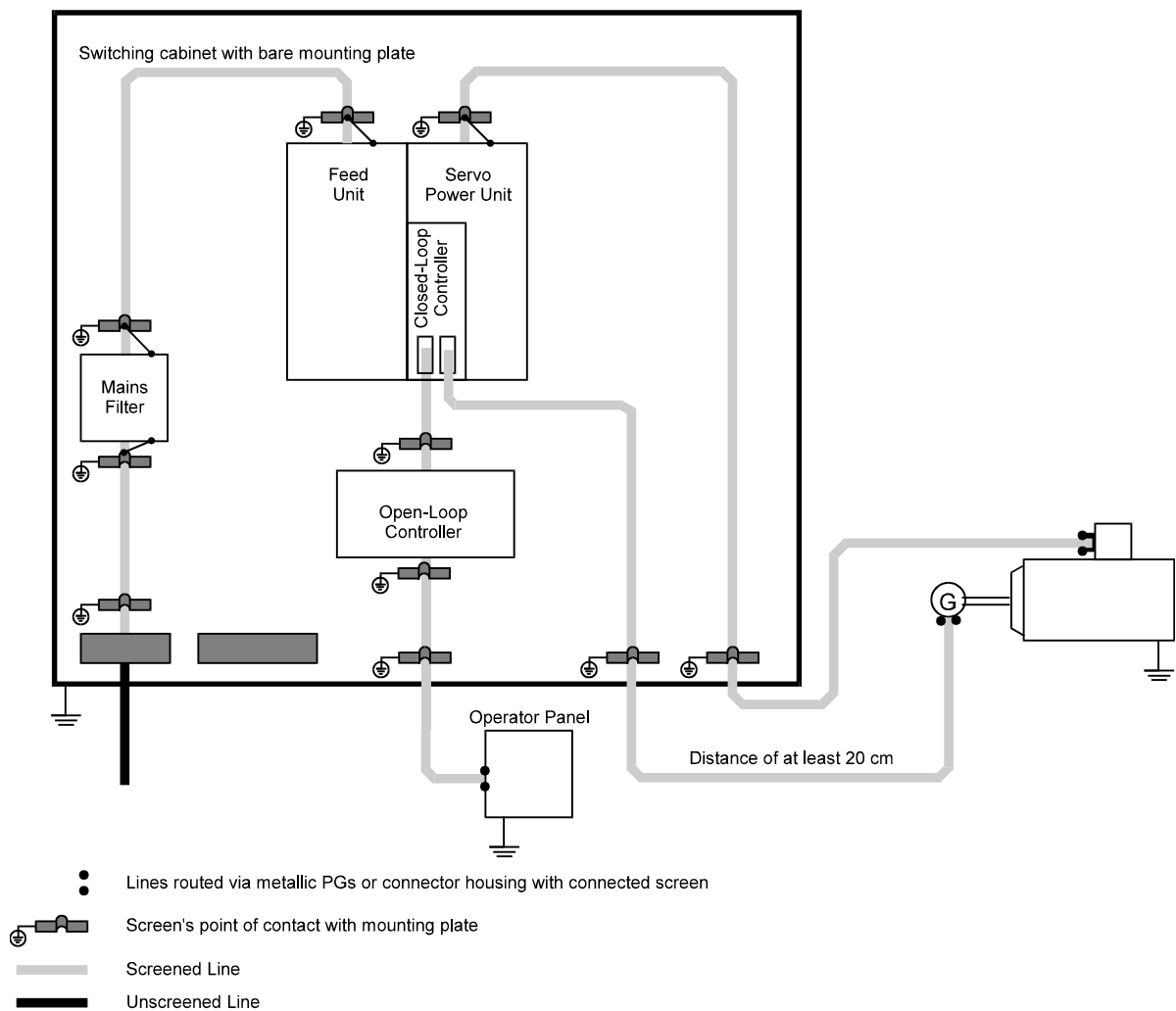

Installation

- You achieve the lowest possible effective antenna height by routing the cable directly on the ground of the metallic rack.

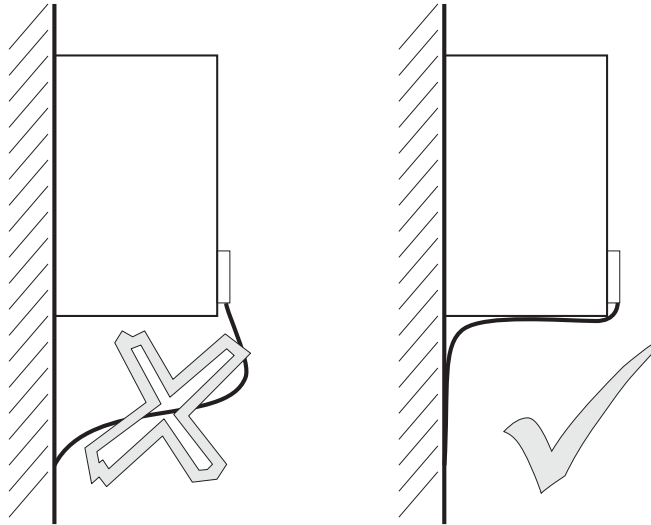

- You should route all lines as close as possible to the conductors of the ground system to reduce the effective loop area for magnetic coupling.

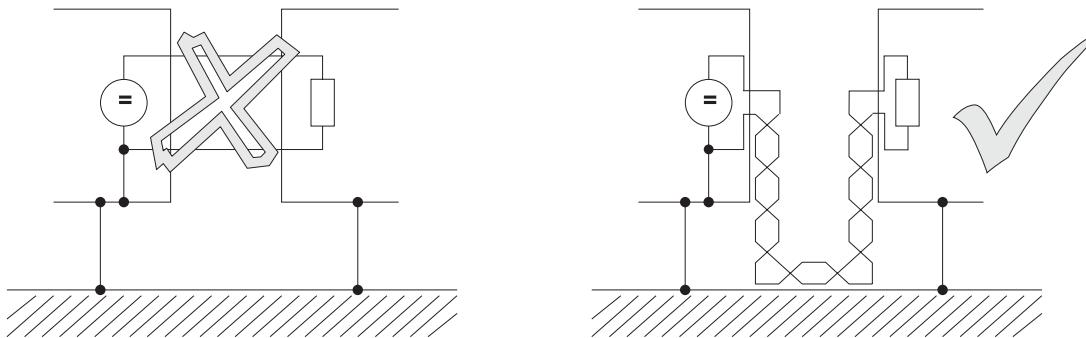

- When parallel-routing signal and control lines across power cables, the conductors must be at least 20 cm apart.
- Lines of different EMC categories should only cross at an angle of 90°.
- In the case of symmetrical signal transfer (e.g. differential amplifier inputs for the speed specified value), twist the conductors of each pair of wires together and twist the pairs of wires together.
- The converter to ground plate earth connection should be as short as possible (less than 30 cm). Use large cross-sections (more than 10 mm).
- Sources of interference such as fuses, transformers and chokes and modules that are sensitive to interference like μ Ps, bus systems, etc. should be located at least 20 cm away from the converter and its cabling.
- Avoid reserve loops on overlong cables.
- You **must** ground reserve lines at both ends (this has an additional screening effect, avoids capacitively coupled, dangerous touch voltages).

Grounding

- From an EMC point of view, classical star grounding is no longer adequate for reducing the influence of disturbances at relatively high frequencies that occur as a result of converter operation. Better results can be achieved by a reference surface that must be linked to the devices' frame grounds over a wide area (e.g. a bare, metallic mounting plate and parts of the housing).
- If it is not possible to use a broad reference place, it is sensible to mount the main equipotential busbar directly next to the converter, since this device generates the greatest potential jumps, compared with the other components in the switching cabinet, due to the steep switching edges (the ground connection should be less than 30 cm long if possible).
- Route all earth conductors and screens as closely as possible above the frame ground to prevent earth circuits.
- If it is possible to earth the controller reference voltage, make this connection with cabling that has as large a cross-section as possible and is less than 30 cm long.
- Remove insulating layers, such as varnish, adhesives, etc., from the frame ground connections. If necessary, use DIN 6798 serrated lock washers or similar to ensure a permanent, conductive contact. To prevent corrosion of frame ground connections, use suitable pairs of metals (electrochemical displacement series), and keep conductive electrolytes away from the connection by means of a protective coating (e.g. grease).
- Always connect screens at both ends to the frame ground; the connection should be over a wide area and conductive. This is the only way to suppress the effects of magnetic or high-frequency noise interference fields. If there are problems with earth circuits (e.g. double earth fault of the specified value conductor screen), the receive side should be galvanically connected and the transmit side capacitively connected.
- When routing cable screens through panels that separate different EMC areas, the cables must be in contact with the panel.
- Cables that are routed through the outer panels of screening housing without special measures (e.g. filtering), can have an adverse effect on the screening capability of the housing. For this reason, you must make a conductive connection of the cable screens to the screening outer panel at the point at which the cable enters the housing.
- The distance of the last screen contact point to the exit from the cabinet must be as short as possible.

Screening

- The screen is effective against magnetic fields if it is connected to frame ground at both ends.

With electrical fields, the screen is effective when it is connected to frame ground at one end.

However, in the case of (electrical or magnetic) fields with high frequencies (depending on the length of the line), you must always connect the screen at both ends due to the linkage (electromagnetic field).

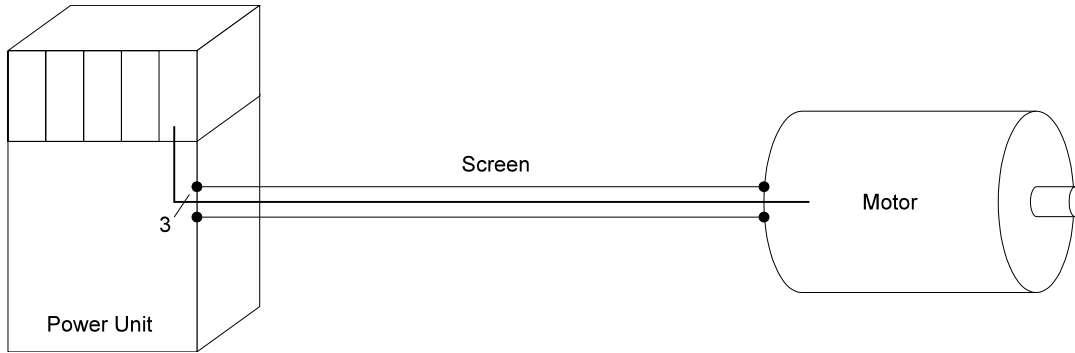

Connecting the screen to frame ground at both ends ensures that the conductor does not leave the screening „system housing“.

- Frame-grounding of conductor screens on both sides does not entirely rule out the influence of earth circuits (potential differences on the frame ground system). However, this is very rare if you carry out the measures described in the previous sections entitled „Cabling“ and „Grounding“.

You can also make a capacitive RF connection of a screen to frame ground. This prevents low-frequency interference due to earth circuits.

Screened cables that pass through different EMC areas must not be separated at terminals, since screen damping would otherwise be considerably reduced. The cables should be routed to the next module without interruption.

- Make the screen connection low-impedance and over a wide surface area. Cable tails that are only three centimeters long (1 cm of wire = 10 nH) reduce the screening effect in the megahertz range by up to 30 dB!

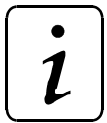

NOTE

The braided screen must have a coverage of at least 85%.

The following lines have particularly high levels of interference potential:

- the motor line
- the line to the external ballast resistors
- the line between the mains filter and the converter

- Suggestion for screen connection

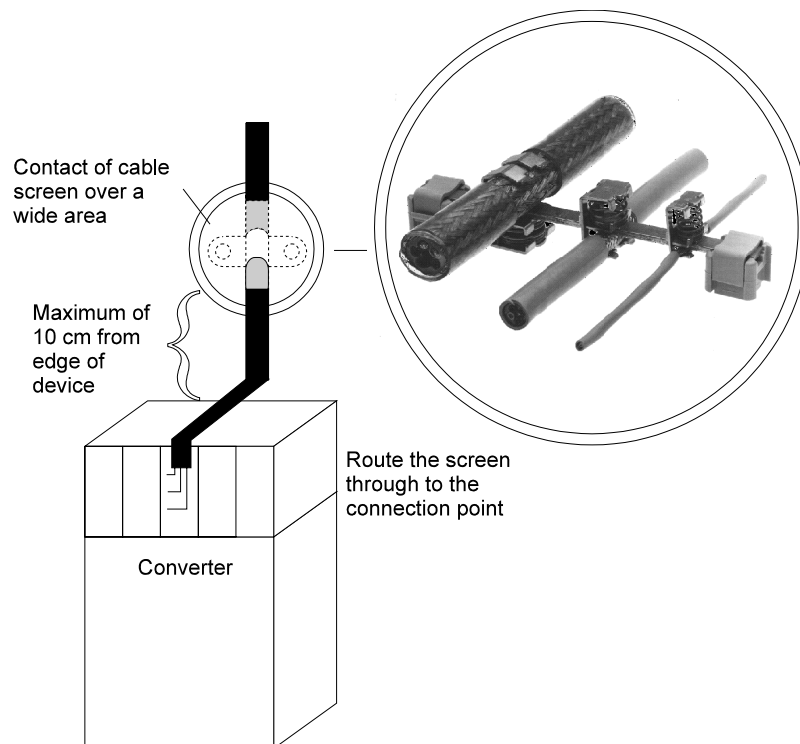

Filtering

No filters are needed for the converter to function. However, under some circumstances, filters may be needed on the input or the output side to comply with EMC regulations.

If you have any queries about filter design, please ask for the description entitled Baumüller Filters for Network Applications, BFN.

Filter mounting

- Mount the filter directly next to the converter. With lines that are more than 30 cm long, you must screen the mains line between the converter and the filter (frame-ground on both sides).
- Physically separate the filter's input and output lines by more than 30 cm.
- Make a broad connection between the filter housing and frame ground.

Discharge currents

Due to the principle of operation, parasitic capacities in the filter, the mains unit, the motor cable and the motor winding cause discharge currents of around 100 mA and higher.

This means that converters with earth leakage circuit-breakers may be incompatible!

In this context, you should observe the safety information in provisional standard EN 50178:1994 Section 5.2.11.2.

5.3 Connection diagram

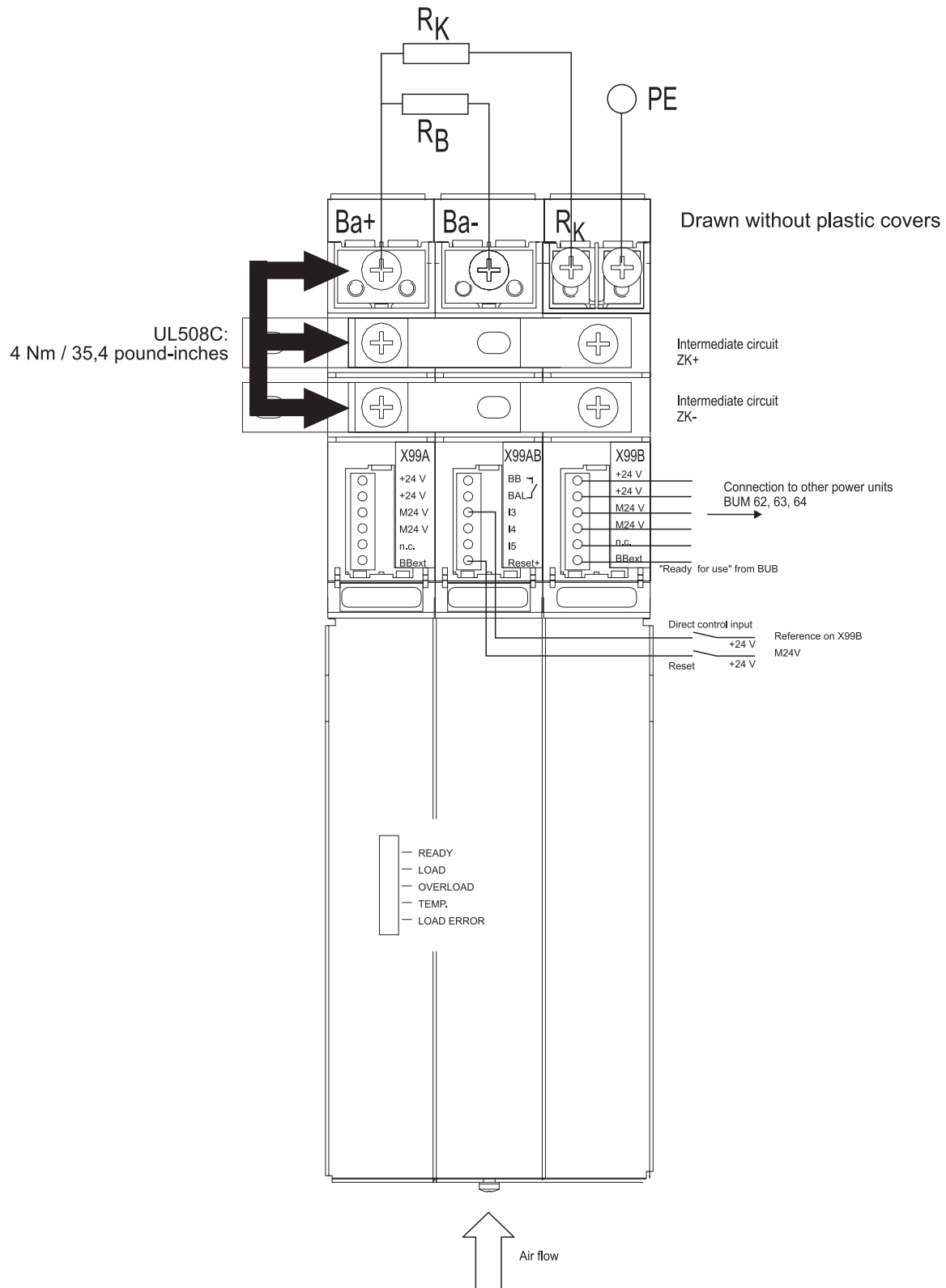

5.3.1 Connection to BUM 62

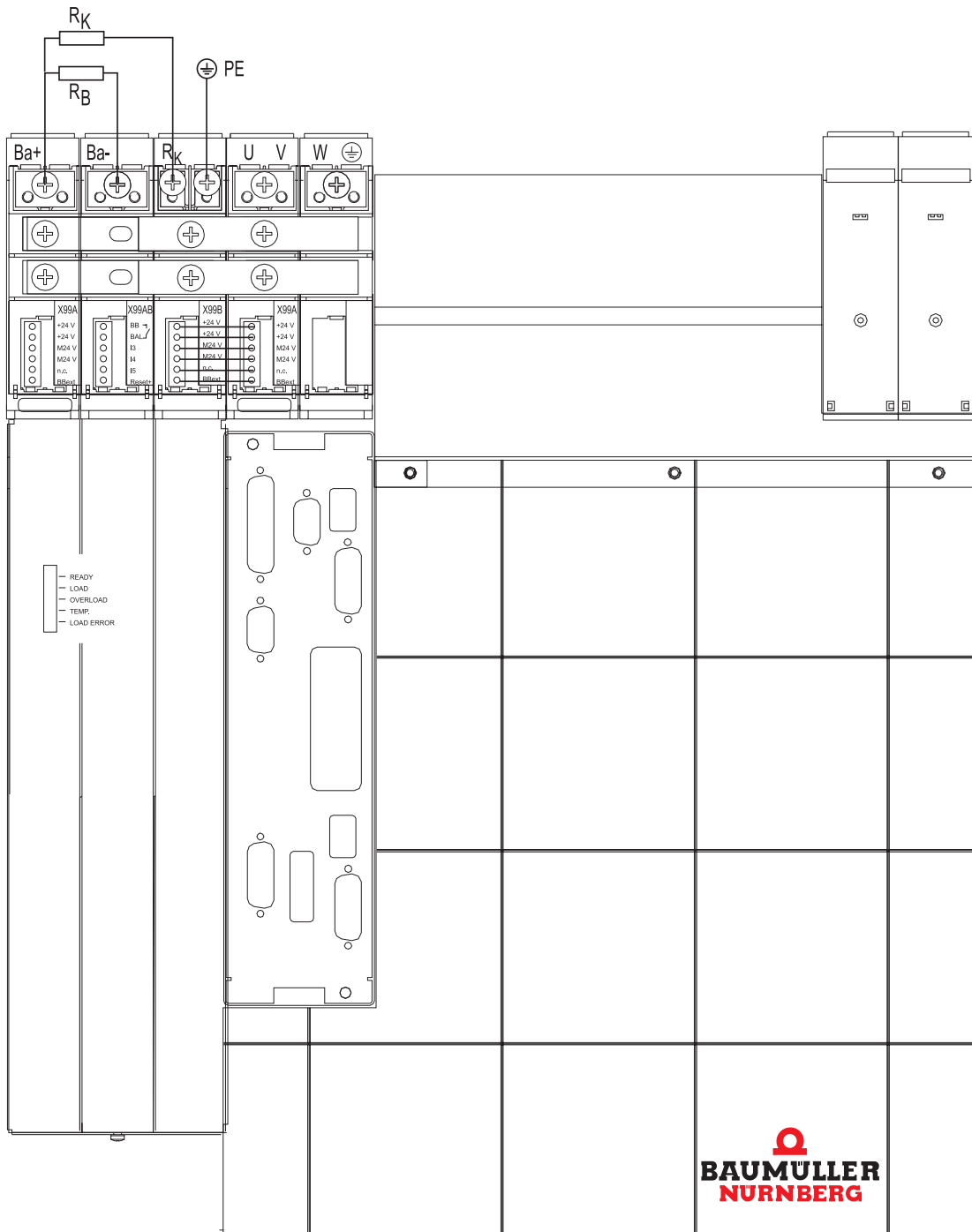

5.3.2 Connection to BUM 63

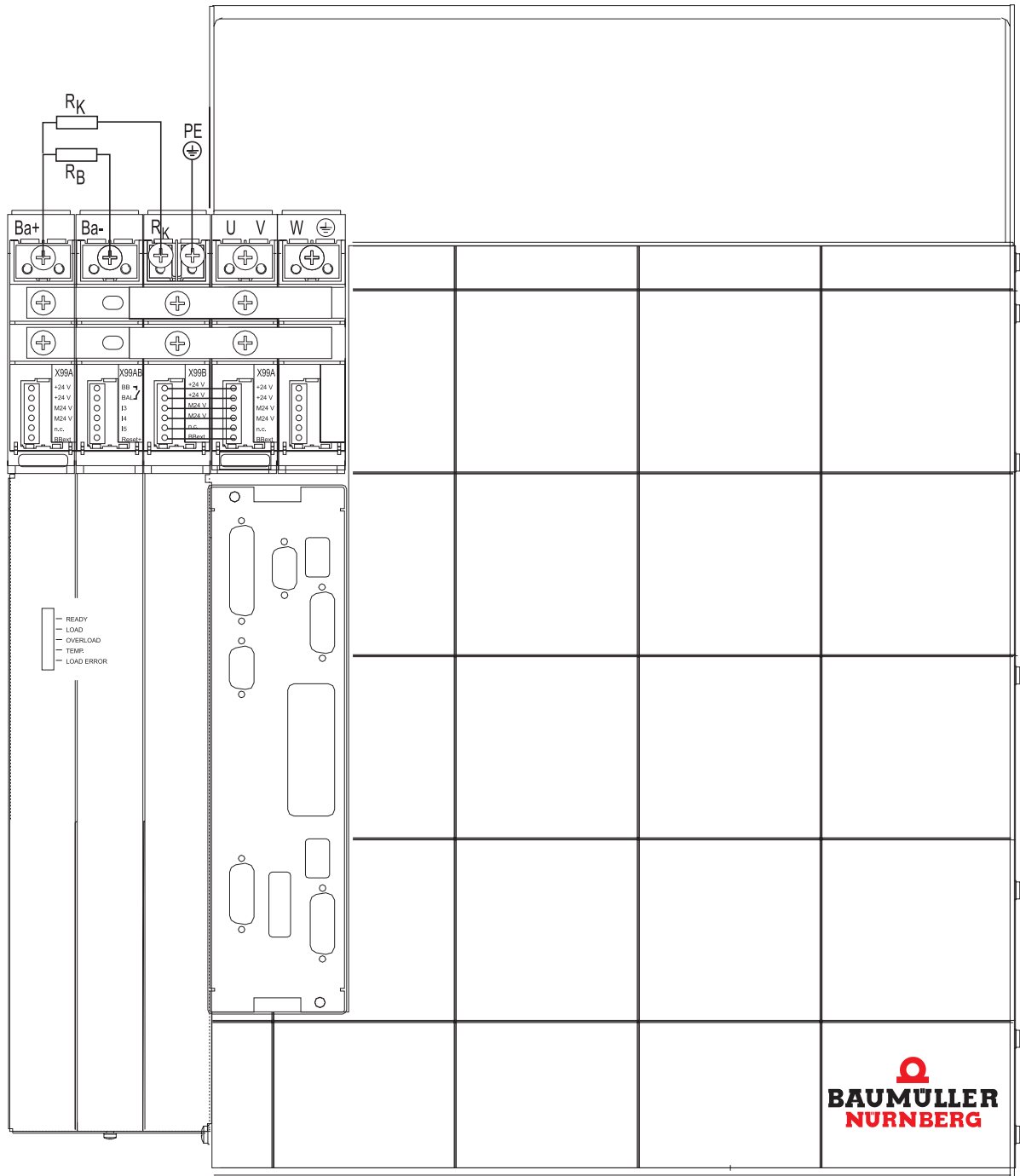

5.3.3 Connection to BUM 64 (2 units V. 1-4, max. 1 unit V. 5)

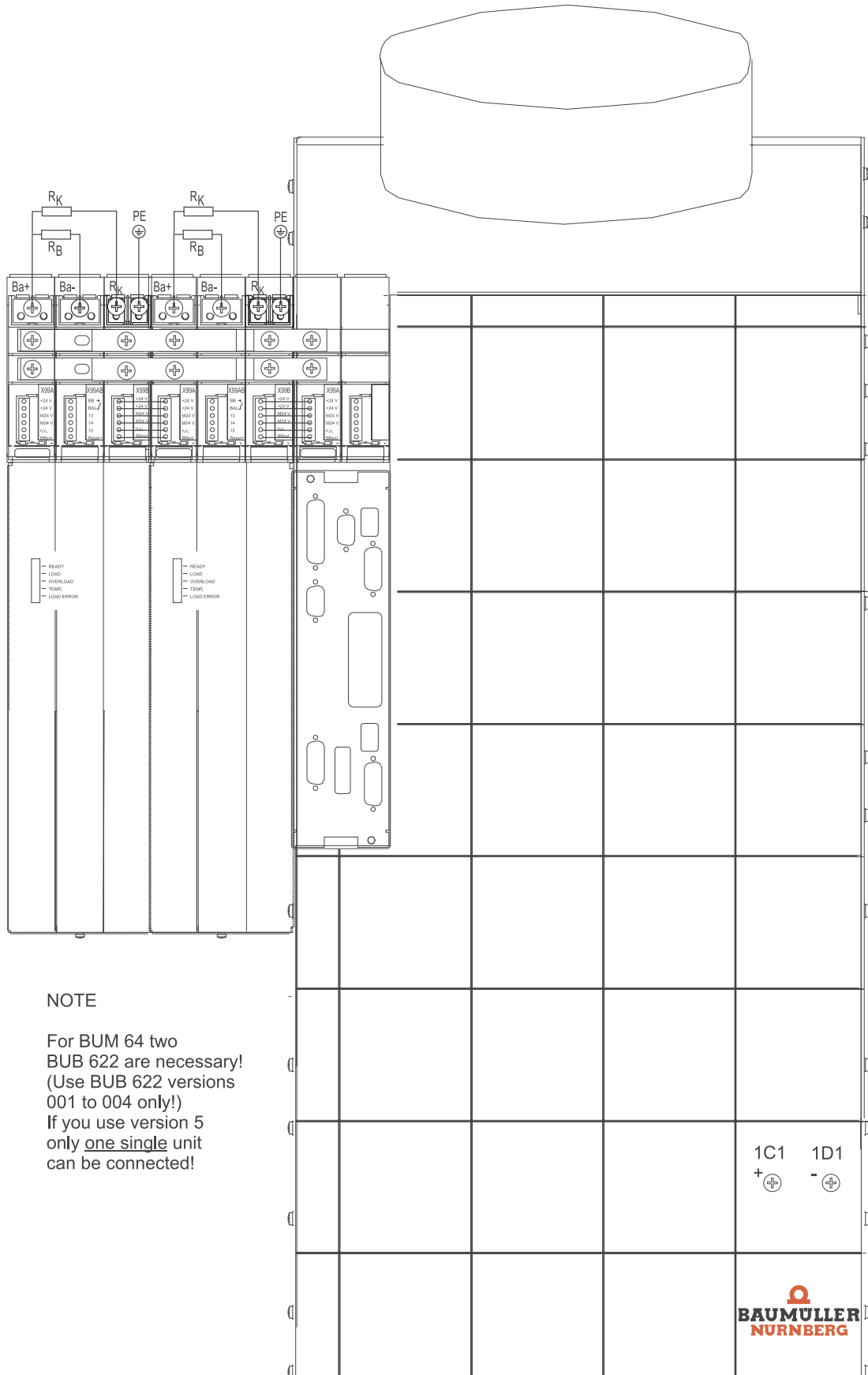

NOTE

For BUM 64 two BUB 622 are necessary!
 (Use BUB 622 versions 001 to 004 only!)
 If you use version 5 only one single unit can be connected!

Connection information

Power terminals

- Ba+, Ba- Ballast resistor connection
The maximum switch-on time and the load cycles of the connected ballast resistor must not be exceeded. Otherwise you run the risk of thermal damage. In any case take care of sufficient ventilation. At no time the resistance value must be lower than 7.5Ω as specified in the technical data.
Type of fastening screw: M6
If UL508C has to be observed: Use $60^\circ\text{C} / 75^\circ\text{C}$ copper conductors only (UL508C, Nov 27, 1996, Tab. 39.2).
Nominal tightening torque of the terminal screws: 4 Nm resp. 35.4 pound-inches.
- Rk Connection of DC link rapid discharge resistor
Never use a resistor with a value below 1Ω .
Type of fastening screw: M6
If UL508C has to be observed: Use $60^\circ\text{C} / 75^\circ\text{C}$ copper conductors only (UL508C, Nov 27, 1996, Tab. 39.2).
Nominal tightening torque of the terminal screws: 4 Nm resp. 35.4 pound-inches.
- Zk+, Zk- Intermediate circuit connection of further power unit BUM 62, 63, 64 and to other units up to a total output of 36 kW inclusive the ballast units.
If UL508C has to be observed: Use $60^\circ\text{C} / 75^\circ\text{C}$ copper conductors only (UL508C, Nov 27, 1996, Tab. 39.2).
Nominal tightening torque of the terminal screws: 4 Nm resp. 35.4 pound-inches.



NOTE

If 2 ballast units (not BUB 622 version 5) are connected to the power unit, no further units can be connected to the intermediate circuit bars, because of the risk of a terminal overload.

Connect the power units and the BUB with the supplied current bars.

Type of fastening screw = M6



DANGER

The intermediate circuit and the terminals for the ballast resistor **conduct mains potential!** Use the supplied covers.

- PE Protective earth connection
 Type of fastening screw = M6
If UL508C has to be observed: Use 60 °C/75 ° C copper conductors only (UL508C, Nov 27, 1996, Tab. 39.2).
 Nominal tightening torque of the terminal screws: 4 Nm resp. 35.4 pound-inches.

Control terminals

Plug-in connectors

The control terminals are secure separated from the mains potential (according to pr EN 50178). To ensure this for the total length of your application, all control voltages connected from outside must be PELV or SELV.

5.4 Pin assignments

- All control voltages connected to the unit must be PELV or SELV.
- Plug-in connector X99A/X99B

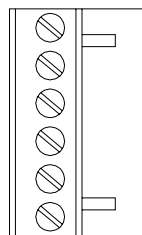

The topmost terminal is terminal no.1

| Terminal no. | Assignment |
|--------------|---|
| 1, 2 | + 24 V (PELV) required to transmit and reset the operational messages or to supply the BUS connection of further units both terminals are internally connected use both terminals if current >10 A |
| 3, 4 | Ground 24 V DC (PELV) required to transmit and reset the operation messages or to supply the BUS connection of further units both terminals are internally connected use both terminals if current >10 A |
| 5 | Reserve |
| 6 | BB _{BAL} „Ready for use“ signal to the power unit |

The terminals of both connectors are internally subsequent connected to each other (X99A/1 with X99B/1 etc.). Due to the connection of X99A to the X99B of the next unit in the chain, the system can execute the signals as a bus connection.

Installation

Cable length of the connection: 44 mm.

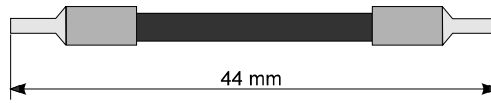

WARNING

The permissible maximum current of 10 A per terminal connection must not be exceeded, otherwise there is a risk of damaging the devices. With higher current requirements, there must be several, separate current feeds.

- Plug-in connector X99AB

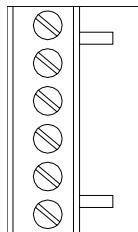

The topmost terminal is terminal no.1

| Terminal no. | Assignment |
|--------------|--|
| 1, 2 | <p>BB_{BAL} external</p> <p>relay output: Ready-for-use ballast unit 24 V, 10 mA - 1 A maximum potential against electronic ground maximum 60 V DC</p> |
| 3 | <p>I3 compulsion switch of ballast resistor and rapid discharge of DC link</p> <p>If this terminal is activated the ballast resistor will be switched on independent of the intermediate voltage (high active +24 V DC, 10 mA)</p> |
| 4 | <p>I4</p> <p>further option</p> |
| 5 | <p>I5</p> <p>If this terminal is activated the overload monitoring will be deactivated (high active +24 V DC, 10 mA), see „messages and warnings“</p> |
| 6 | <p>Reset +</p> <p>Input to reset the messages of the ballast unit (High active +24 V DC, 10 mA)</p> |

6 COMMISSIONING

6.1 Danger information



WARNING

This device carries dangerous voltages and contains dangerous rotating parts (fans). Ignoring the safety- and warning information may result in death, severe personal injury and/or damage of property

The user is responsible for the mounting of the converter, the motor, the mains choke and the other devices according to the safety regulations (e.g. DIN, VDE) and all other relevant national or local regulations concerning the conductor dimensioning and protection, grounding, disconnectors, overcurrent protection, etc.

The protective measures and safety regulations according to DIN/VDE are binding for personal security. If there are no PE connections on the unit, the commutation choke or the motor, personal injury may be caused since the surface may carry hazardous voltage.

During operation, the principles on which the converter and motor work, lead to leakage currents to earth which are dissipated by use of specified protective earth connections and which may result in a current-operated e.l.c.b. on the input side blowing prematurely.

A DC component in the fault current may occur in the event of a short-circuit to frame or earth fault which makes a triggering of the higher-level current-operated e.l.c.b. more difficult or even impossible. Carry out PE connection according to DIN EN 60204 / VDE 0113 Part 1 / 06.93, Section 8.2.2. considering prEN 50178 / VDE 0160/11.94, Sections 5.3.2.1 and 8.3.4.4.

Before commissioning, check whether the plastic covers over the live parts (power terminals) are in place.

When an error occurs, the drive is de-energized and the motor coasts to stop. This fact must be taken into account particularly for hoist and lifting drives.



WARNING

Prior to connecting the drive, carefully check all higher-level safety equipment for perfect functioning, in order to avoid personal injury.

Malfunction of the drive

During the initial commissioning, a faulty or uncontrolled movement of the driven machine elements cannot be excluded. Therefore, proceed with particular care.

Protection against contact according to Paragraph 4 Section 4 VBG 4

Protection against direct contact comprises all measures against danger which can result from touching the active parts of electrical equipment.

Sheets of plastic covering the control electronics, the power section and the device connection, additionally prevent accidental contact during commissioning and casual use of control elements located close to the equipment.

(DIN VDE 0106 Part 100, Accident Prevention Regulation VBG4 "Electrical Systems and Equipment).

Switching cabinets must have emergency-stop devices which can be used to switch off all voltages that could cause dangerous situations. This does not include equipment which, if switched off, would cause another dangerous situation. The releasing element for the emergency stop facility must be arranged in such a way that it can easily be reached in case of danger. When performing works which are considerably more dangerous than usual, the presence of an additional person is required.

The operator must ensure that unauthorized persons do not work on the machine.

The operator must report immediately any changes occurred that affect the safety of the unit/system.

When demounting safety equipment during commissioning, repair and maintenance, ensure that the machine is taken out of commission in accordance with applicable regulations. Remount and check the safety equipment immediately after completing commissioning, repair and maintenance works.

6.2 Flow diagram

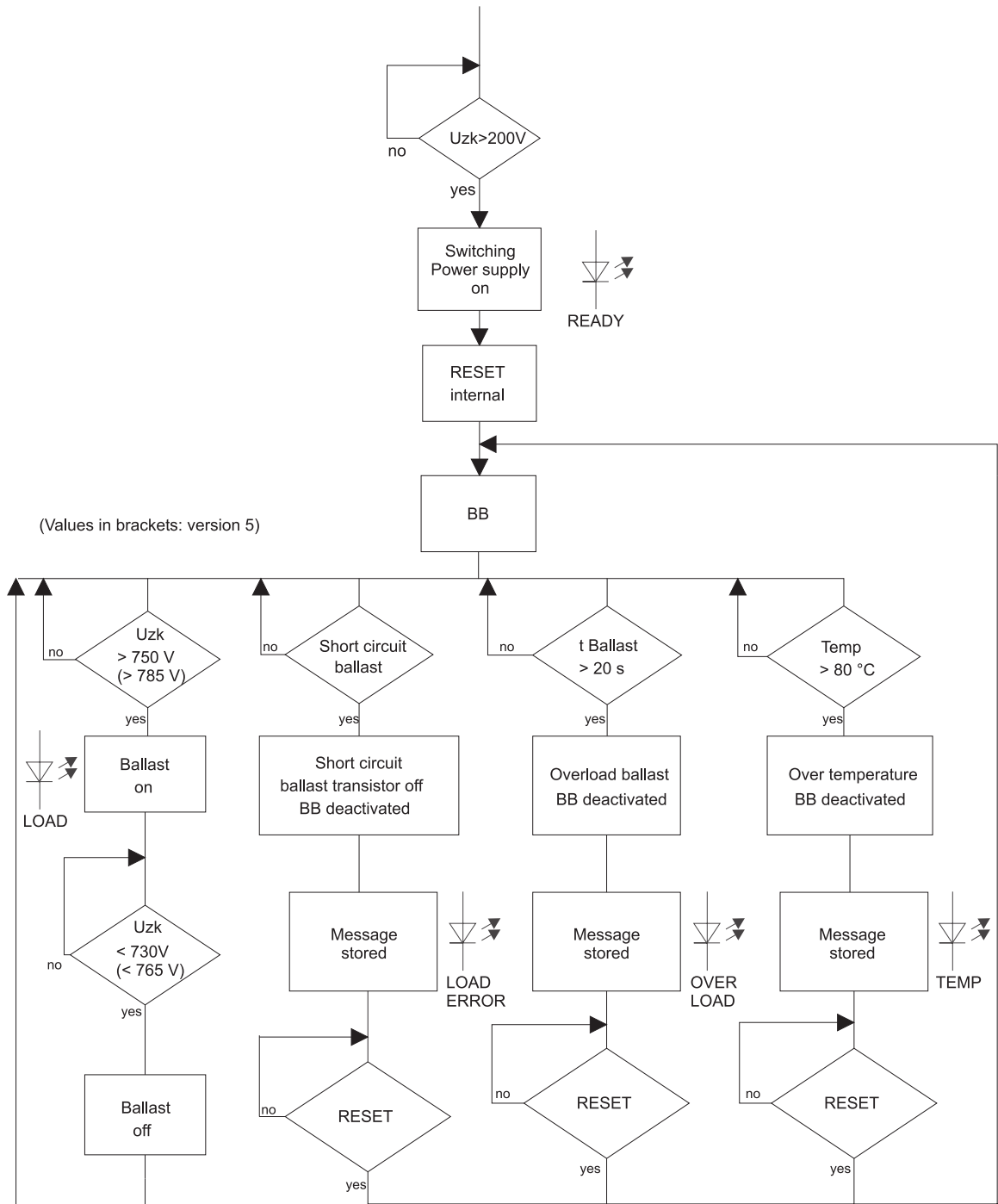

6.3 Operation

RESET

Resets operational messages stored by the ballast unit

- Connect RESET input at connector X99AB with +24V
- Power-ON-reset by restart of the system



WARNING

Messages that are still pending cannot be cleared.

Compulsive turn-on of ballast resistor

- I 3 - connect input at connector X99AB with +24V

If the input I3 is connected with +24 V, the ballast resistor is switched on independent of the intermediate circuit voltage.

Using this function e.g. the intermediate circuit can be discharged rapidly. Because the internal power supply is switched off at ca. 50 V intermediate circuit voltage, this function works only up to this voltage.



WARNING

This input is not monitored by another monitoring function (except of LOAD ERROR) and can damage the ballast unit or the ballast resistor in case of false activation.

Switch off the overload message (OVERLOAD)

- I 5 - connect input at connector X99AB with +24V

The factory-set overload message is switched off.



WARNING

False activation or wiring can damage the ballast unit or the ballast resistor.

6.4 Messages and warnings

On the front side of the unit you will find 5 LED's, displaying the following operation and error messages.

| LED | Function / cause |
|------------|--|
| READY | Intermediate circuit voltage is available ($U_{ZK} > 200 \text{ V}$) If no message is active, the „ready for use“ signal will be sent to the power unit. |
| LOAD | The ballast resistor is switched on The drive feed back energy to the intermediate circuit. If the intermediate circuit reaches 750 V (785 V for version 5), the ballast resistor will be switched on an if the voltage is below 730 V (765 V for version 5) the resistor will be switched off. |
| OVERLOAD | The on period is related to the whole period too long The external „ready for use“ is taken away and the message is stored. (standard setting: ca. 20 s on period ballast in case of a whole period of 90 s) The monitoring can be switched off by terminal I5. |
| TEMP | The coolant temperature is too high ($>85^{\circ}\text{C}$) The external „ready for use“ is taken away and the message is stored. |
| LOAD ERROR | An overcurrent is detected because of a wrong dimensioned or damaged ballast resistor. External and internal „ready for use“ is taken away and the message is stored. |



NOTE

The messages OVERLOAD and TEMP erase the „ready-for-use“ signal, the ballast function remains active.

The message LOAD ERROR erases the „ready-for-use“ signal and switches off the ballast resistor.

| Function outputs | Function / cause |
|-----------------------|---|
| BB _{BAL} | The relay „ready-for-use“ will close the contact (X99AB, terminal 1,2), if no message (OVERLOAD, TEMP., LOAD ERROR) is active. This contact is freely disposable. |
| BB _{ext} | The terminal (X99a,X99B terminal 6) will be high (+24 V), if no message (OVERLOAD, TEMP., LOAD ERROR) is active. This message is interpreted by the connected power unit and must not be used otherwise. |

6.5 Select the ballast resistor

The kinetic energy at braking leads to a charge of the intermediate circuit capacitor. The feed back energy depends on the speed and the moment of inertia of the drive.

$$W_K = \frac{1}{2} \cdot (J_M + J_L) \cdot \left[\left(\frac{n_1}{9,55} \right)^2 - \left(\frac{n_2}{9,55} \right)^2 \right] \quad [\text{Ws}]$$

The following energy can be stored in the intermediate circuit of the converter.

BUM 62: $W_{el} \approx 135 \text{ Ws}$ (range of validity: $U_{\text{mains}} = 400 \text{ V}$, $U_{\text{zk max}} = 750 \text{ V}$)

BUM 63: $W_{el} \approx 190 \text{ Ws}$

BUM 64: $W_{el} \approx 380 \text{ Ws}$

If more electric energy is fed back to the intermediate circuit capacitor, a ballast unit will be needed.

The surplus energy, which must be converted in the ballast is:

$$W_{\text{ballast}} = W_K - W_{el} \quad [\text{Ws}]$$

The maximum ballast power should be at least equal to the motor power.

That results in the following resistance value:

$$R_{\text{ballast}} \approx \frac{(\text{BST on})^2}{P_{\text{drive}}} \quad [\Omega] \quad (\text{BST on} = \text{Ballast switching-threshold on, see Electrical data on page 11})$$



WARNING

The maximum permissible rated ballast load is 100 A per unit. That results in a resistance value of $[R_{\text{ballast}}]$ equal to 7.5 Ohm. To avoid damage of the ballast unit, the resistor must **not** be lower than 7.5 Ohm.

To convert the power of an unit BUM 64, it is necessary to connect 2 (not version 5) ballast units parallel (see Connection Diagram). Because the braking energy is converted in 2 ballast units and each resistor converts only half of energy, for the calculation of the resistance value $[R_{\text{ballast}}]$ is equal to half of the drive power $[P_{\text{drive}}]$.

Stress cycle ballast resistor

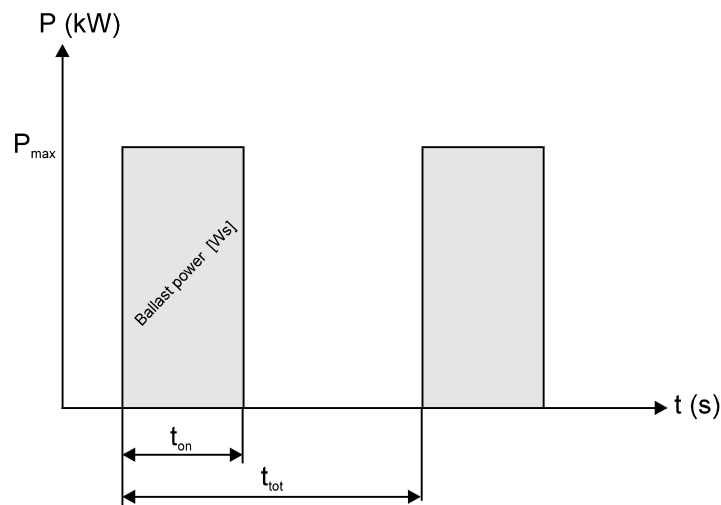

For the selection of braking resistors following formulas are valid:

$$\bar{P} = \frac{P_{\max} \cdot t_{\text{on}}}{t_{\text{tot}}} \quad [\text{W}] \quad \text{Validity: } t_{\text{on}} < 1 \text{ s}$$

$$P_{\max} = \frac{(\text{BST on})^2}{R_{\text{ballast}}} \quad [\text{W}] \quad (\text{BST on} = \text{Ballast switching-threshold on, see Electrical data on page 11})$$

The switch-on time t_{on} of the ballast is calculated by:

$$t = \frac{W_{\text{ballast}}}{P_{\max}} \quad [\text{s}]$$

Terms:

| | | | |
|----------------------|---|---|--------------|
| J_M | = | Mass moment of inertia | [kgm] |
| J_L | = | Mass moment of inertia load | [kgm] |
| n_1 | = | Speed before braking | [rpm] |
| n_2 | = | Speed after braking | [rpm] |
| W_k | = | Kinetic energy | [Ws] |
| W_{el} | = | Energy stored in the intermediate circuit capacitor | [Ws] |
| R_{ballast} | = | Ballast resistance | [Ω] |
| P_{drive} | = | Drive's power on shaft | [W] |
| \bar{P} | = | AVG | [W] |
| P_{\max} | = | Maximum ballast power | [W] |
| W_{ballast} | = | Energy converted in the ballast resistor | [Ws] |
| t_{on} | = | On period ballast resistor | [s] |
| t_{tot} | = | Total cycle time ballast | [s] |

7 MAINTENANCE



WARNING

This unit conducts dangerous voltages and has dangerous rotating parts (fans). Ignoring the safety and warning information may result in death, severe personal injury or property damage.

Only carry out maintenance jobs when the unit is deenergized.

Do not begin to work on the power section and the intermediate circuit until you have made sure that the unit is not carrying potential or voltage (remanent charge).

When dismantling safety devices during commissioning, repair and maintenance work, you must ensure that the machine has been taken out of commission exactly as specified. You must remount and check the safety equipment immediately after completing commissioning, repair and maintenance work.

After carrying out any work involving intervention in the machine – regardless of whether this involves the motor, the actual value acquisition or the power converter – the owner must carry out acceptance testing and document it chronologically in the machine log. Failure to do this may result in the owner being faced with consequences relating to liability legislation.

7.1 Maintenance information

The units supplied are maintenance-free.

Prohibition of unauthorized modifications

For safety reasons, unauthorized additions or modifications to the drive are not allowed.

7.2 Disposal

Basically, the equipment consists of the following components and materials:

| Component | Material |
|---|---|
| Housing | Sheet-steel, aluminium |
| Chokes | Copper, transformer magnetic sheet-steel |
| Various spacers, housing of current converter and unit fan, etc. | Plastic |
| PCBs on which all the open- and closed-loop electronics are mounted | Base material: Epoxy-resin fibreglass woven material, copper-coated on both sides and plated-through, various electronic components such as condensers, resistors, relays, semiconductors, etc. |

For technical reasons, electronic components might need to contain dangerous materials, so you should not open them.

If the components are used correctly, there is no hazard for human beings or for the environment.

In case of fire, dangerous compounds may result or hazardous materials may be released.

Do not open electronic modules. The inner insulation used e.g. in divers power semiconductors contains beryllium oxide. If opened, the beryllium oxide vapor is regarded as dangerous to health.

You must dispose of or recycle equipment or components according to national regulations as well as any applicable local or regional ordinances.

8 APPENDIX

8.1 Declaration by Manufacturer

HERSTELLERERKLÄRUNG IN SINNE DER EG-MASCHINENRICHTLINIE 89/392/EWG, ANHANG IIB

Manufacturer Declaration in Accordance with the EC-Machine Guidelines 89/392/EEC, Appendix II B

Hiermit erklären wir, dass es sich bei dieser Lieferung um die nachfolgend bezeichnete Maschinenkomponente handelt und dass ihre Inbetriebnahme solange untersagt ist, bis festgestellt wurde, dass die Maschine, in die diese Komponente eingebaut ist, den Bestimmungen der EG-Maschinenrichtlinie 89/392/EWG, Anhang II B entspricht.

We herewith declare that this delivery includes the following specified machine component and that its putting into operation is prohibited until the declaration is made that the machine, in which this component is built in, complies with the regulations of the EC-machine guideline 89/392/EWG, appendix II B.

Bezeichnung der Maschinenkomponente:
Specification of the machine component:

Typenbezeichnung:
Type:

Ballast Unit BUB 622

BUB 622 - 100 - 54 - E

Nürnberg, 28.12.2004

Hersteller-Unterschrift:

Signature of the Manufacturer:

 11/11/2005

Andreas Baumüller

Geschäftsleitung
Head Division



ppa. Dr. Peter Heidrich

Entwicklungsleiter
Head of Development

8.2 Declaration of Conformity

**KONFORMITÄTSERKLÄRUNG
IM SINNE DER
EG-NIEDERSpannungsRichtlinie 73/23/EWG**

EG Declaration of conformity of equipment regarding low voltage directive 73/23/EWG

Bezeichnung der Maschinenkomponente:

Typenbezeichnung:

Specification of the machine component:

Type:

Ballast-Einheit BUB 622

BUB 622 - 100 - 54 - E

Die Übereinstimmung des bezeichneten Produkts mit den Vorschriften der Richtlinie wird nachgewiesen durch die Einhaltung folgender Normen:

Conformity of the signficated product with the guidelines will be proved by following rules:

EN 50178: 1994 (VDE 0160/11.94)

"Ausrüstung von Starkstromanlagen mit elektronischen Betriebsmitteln"

EN 50178: 1994 (VDE 0160/11.94)

"Equipment of power installation concerned electronic operating materials"

Nürnberg, den 28.12.2004

Hersteller-Unterschrift:

Signature of the Manufacturer:

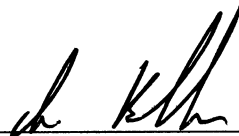

Andreas Baumüller
Geschäftsleitung
Head Division

11/1/2005



ppa. Dr. Peter Heidrich
Entwicklungsleiter
Head of Development

8.3 General Conditions of Sale and Delivery

1. Obligation and Conclusion of Contract

- a) Deliveries of goods and provision of services shall be effected exclusively based on these trading conditions. They are an essential component of the contracts for delivery and shall be considered as having been accepted by the placing of an order. In the case of constant business relations, they also apply for the future contracts.
- b) Agreements diverging from the contract and verbal collateral agreements shall only be binding if they have been confirmed in writing by Baumüller Nürnberg GmbH (hereinafter referred to as Baumüller). Diverging trading conditions on the behalf of the purchaser shall be without obligation, even where these have not been expressly objected to. These General Conditions of Sale and Delivery shall be considered as having been accepted by the purchaser at the latest when the delivery is accepted.
- c) In as far as deliveries of goods are subject to separate external obligations in accordance with the Law Concerning Foreign Trade and Payments with respect to the Federal Office for Economics, the purchaser has to observe the relevant conditions at his/her own responsibility.

2. Price and Offers

Offers are subject to confirmation, not binding and apply subject to material supply possibilities. Supplements and amendments require written confirmation. Prices are ex works and are subject to confirmation. Invoicing takes place in accordance with the prices valid on the date of delivery.

3. Extent of Delivery and Delivery Time

- a) Specified delivery periods/dates are without obligation, in as far as nothing else to the contrary has been expressly agreed upon in writing. Delivery periods do not commence until the purchaser has fulfilled all duties of co-operation, in particular regarding details of performance. In the event that the agreed deposits for orders are delayed, then the delivery time shall be extended accordingly.
- b) The purchaser is entitled, in particular in the event of a delay in delivery of longer than 3 months, to set an appropriate period of grace and after its expiry, to withdraw from the order. Claims to compensation due to non-fulfilment or delay shall be excluded, in as far as Baumüller is not responsible for intent or gross negligence.
- c) Baumüller is entitled at any time to effect partial deliveries and partial services, as well as to invoice these accordingly

4. Delivery Problems

- a) Delays/preventions in the delivery of goods or the provision of services due to force majeure entitle Baumüller to delay the production and delivery by the duration of the obstruction plus an appropriate period of time or to withdraw in part or in whole from the order.
- b) Industrial disputes or other circumstances which substantially impede or render impossible the delivery, such as, in particular, disturbances in the operating processes, problems in procuring materials, official directives also apply as force majeure, irrespective of

whether they arise with regard to Baumüller or suppliers.c) In these cases, Items 4 a), b), the purchaser shall have no claim to compensation due to non-fulfilment or delay of the delivery.

5. Packaging

Items for sale and delivery items are packaged and transport insurance policies are taken out according to the instructions of and at a cost to the purchaser. Upon demand, the packaging material has to be returned without delay, free of freight charges and expenses.

6. Dispatch and Passing of Risk

Deliveries shall be made ex works. The dispatch shall be effected at a cost to and at the risk of the recipient of the service/the purchaser. The risk passes to the recipient of the delivery/purchaser as soon as the delivery items leave the works. This shall apply at the latest, from the transferral of the delivery items to the person carrying out the transport, forwarding agent or carrier.

7. Warranty

In the event that a delivery item is defective, Baumüller shall deliver an additional replacement or make a subsequent improvement at its own choice. Multiple subsequent improvements are permissible. Other warranty claims on the behalf of the purchaser, in particular also due to direct or indirect consequential damage are excluded. The pre-condition for any warranty is the normal contractual use of the delivery items. In the event of the utilisation of warranty services, the motor, the replacement part or the device has to be sent in free of freight charges, packaging costs or customs duties after prior co-ordination with Baumüller. Baumüller is exempted from any warranty if the party ordering returns the goods complained about without prior co-ordination or contrary to agreement. Warranty claims expire one month after rejection of a defect on which notice is given, in as far as the purchaser remains silent in this respect.

8. Notification of Defects

- a) The purchaser shall examine the subject matter of the contract and delivery items immediately and give notice of any defects without delay, however, no later than 7 days after receipt of the delivery. In case of non-obvious defects notice has to be given in writing without delay after their discovery, however, no later than 6 months from the point of delivery. In the event that the purchaser does not give notice of any defects in writing within this period of time, then the subject matter of the contract shall be considered as having been approved.
- b) The purchaser shall allow Baumüller a suitable inspection of defects of which notice is given and shall place all necessary/requested technical information, in particular, inspection records and test reports at Baumüller's disposal. In the event that the purchaser fails to do so, then the delivery items shall be considered as not having been complained about and as being approved. In the event that the purchaser alters the delivery items, then he/she shall lose his/her warranty claims.
- c) In the event of an established material defect or performance defect, Baumüller can eliminate the defect or supply a replacement. The purchaser can demand

rescission or a reduction after the expiry of an appropriately set period of grace. Further claims on the behalf of the purchaser, in particular to the reimbursement of dismantling costs or installation costs are excluded. The same applies to damages which do not affect the delivery item itself.

- d) Natural wear and tear and damage which arises after the transferral of risk, in particular also due to incorrect or negligent handling, excessive demands or other unsuitable use not in conformity with the contract are excluded from the warranty. The same applies in particular for defects which are attributable to atmospheric discharges, overvoltages and chemical influences.
- e) If no case of warranty is in existence or in the event that this subsequently turns out to be the case, the purchaser shall remunerate the utilisation or the use of an item or of a right, as well as services provided and expenses to an appropriate amount. Baumüller is entitled to a right of control as referred to in §§ 315 ff. BGB [German Civil Code].

9. Liability

Contractual or legal claims on the behalf of the purchaser against Baumüller are limited to intent and gross negligence. This does not apply in as far as claims from the ProdHaftG [Product Liability Act] have been enforced. Baumüller shall only be held liable to the amount of the damage foreseeable in accordance with the purpose of the contract. Material damage which exceeds the value of a delivery/service is not foreseeable in this sense. The liability is limited in terms of amount to the remuneration contractually owed.

10. Payments

- a) Invoices are payable at the time agreed in the contract, at the latest within 30 days after the invoice date, in cash and without deductions. The purchaser can only offset with claims which are final and absolute or undisputed. The same applies to the exercising of rights of retention.
- b) In the event of a delay in payment on the behalf of the purchaser, interest to the rate of 4 % above the respective minimum lending rate of the German Federal Bank, however at least 10 % has to be paid without separate proof being required.
- c) Failure to comply with the terms of payment or circumstances which endanger the credit worthiness of the purchaser result in all claims immediately becoming due. In these cases, deliveries shall only be made against payment in advance.
- d) Cash payments, bank transfers or cheque and bill payments shall not be considered as payment/fulfilment of the obligation before the amount due for payment has been irrevocably received by Baumüller or credited to Baumüller's account.
- e) Payments have to be made directly to Baumüller. The field staff are not entitled to accept payments or to issue extensions or waivers without separate written authority.

11. Reservation of Ownership

- a) The ownership of delivery items remains reserved up to the fulfilment of all existing claims against the purchaser from the business relation. Any bundling with other items shall be effected by the purchaser for Baumüller. Then, the entire product shall be considered as reserved goods.
- b) The purchaser is entitled to sell the reserved goods in orderly business transactions. All claims to which the purchaser is entitled from this sale or other legal grounds shall be assigned by him/her in advance to Baumüller. Baumüller shall accept the assignment. In the event that the reserved goods are bundled or sold with other items

standing in the possession of third parties, then the assignment shall only apply to the amount of the invoice value of the reserved goods. The purchaser is authorised to collect these assigned claims. Upon request, he/she has to make notice of the assignment to the debtor.c)The purchaser shall inform Baumüller without delay of impending and enforced access on the behalf of third parties to the reserved goods or to the assigned claims. The purchaser shall bear the costs incurred by this.

- d) The authorisation on the behalf of the purchaser to dispose of the reserved goods and to collect assigned claims expires in the event that the terms of payment are not complied with, in particular, also in the case of bill and cheque protests. In this case, Baumüller is entitled to take possession of the reserved goods. The purchaser bears the costs incurred by this. The taking back of goods shall only represent a withdrawal from the contract when this is expressly stated.
- e) In the event that the value of the securities granted exceeds the secured claims in terms of amount by more than 20 %, then Baumüller shall renounce the securities exceeding this value.

12. Drawings and Documentation

Baumüller is entitled to the exclusive property right and copyright to cost estimates, drawings and all other documentation. These documents may not be made accessible to third parties without prior written consent. In the event that a contract is not concluded, not implemented or otherwise ended, then all documents have to be returned immediately and unsolicited. There shall be no right to retention to these documents.

13. Copyright (in particular Software / Licence)

- a) Baumüller is exclusively entitled to all rights to the software/edited versions, in particular property rights and copyrights to the relinquished software, in particular for the controlling of machines, systems and installations.
- b) Baumüller grants the purchaser/buyer the non-exclusive, non-transferable right to use the relinquished software in the framework of the contractual purpose at the contractually intended location/on the places in existence at the time of purchase (single licence). The software shall only be used on the associated purchased contractual item. Any use extending beyond this is prohibited. In the event of a use extending beyond this, Baumüller shall have the rights referred to in Items 14 c), 14 d).
- c) It is prohibited to make copies of the relinquished software, whether in whole or in part, in as far as the making of copies of the machine-readable material in the framework of the required data backup or as copies for internal company use has not separately been agreed upon with prior written consent from Baumüller. Processing of the relinquished software, in particular by means of alteration, translation or by bundling with other programs shall only be permitted after prior written consent from Baumüller. Protection notices from Baumüller on/in the software may not be removed and also have to be adopted onto copies and edited versions. Copies produced contrary to this condition shall come under the possession and copyright of Baumüller. Baumüller can prohibit the use of such copies and elect to demand the immediate surrender or complete destruction with proof of this destruction.
- d) The buyer is not permitted to extend the licence in terms of location/work places/machines/machine types or to grant rights of utilisation or grant sub-licences. The extension of the licence shall be permitted by Baumüller exclusively against a separate remuneration which has to be agreed

upon in writing.

14. Applicable Law

The law of the Federal Republic of Germany is authoritative for all rights and obligations from and in connection with this contract. The regulations of the UN Sales Convention (CISG) are excluded.

15. Place of Performance and Place of Jurisdiction

The place of performance for delivery and payment is the seat of Baumüller. The place of jurisdiction for all disputes from and in connection with this contract, in particular also for cheque and bill liabilities is the seat of Baumüller.

16. Miscellaneous

In the event that individual or several conditions of these Conditions of Sale and Delivery should be or become ineffective in part or in whole, then the validity of the remaining conditions shall remain unaffected by this. The parties shall complement/replace the ineffective or incomplete condition with an appropriate regulation which most extensively corresponds to the economic purpose of the contractually desired regulation. The same applies for the case of the presence of a gap in the regulations.

For the case that acceptance and installation are also agreed upon, then the following conditions, Items 18 and 19 shall also apply:

17. Acceptance

- a) The inspection of the delivery items ready for acceptance shall take place in the Baumüller works. The purchaser shall bear the costs of this inspection. In the event that the purchaser fails to perform the inspection, then the delivery items shall be considered as having been delivered in conformity with the contract when they leave the works.
- b) The purchaser is obliged to take delivery of goods and services from Baumüller without delay. Immaterial defects do not entitle the purchaser to refuse the acceptance.
- c) In the event that the purchaser does not declare within 7 days after notification of the readiness for acceptance on the behalf of Baumüller or after receipt of the contractual service in writing and with exact, examinable specification of reasons that he/she refuses the acceptance, then the acceptance shall be considered as having been declared and the orderly performance of the contract as having

been ascertained.

- d) The agreed service shall be considered as having been accepted when the item delivered has been put into operation by the purchaser himself/herself or upon his/her instructions by third parties beyond the functional test required to carry out the acceptance. This also applies in the event that the purchaser refuses the functional test/the acceptance without sufficient cause.
- e) Experts to be designated by both parties shall take part in the acceptance inspection. The result of the functional test shall be entered in a record to be signed by the purchaser in consideration of the technical specifications.

18. Erection and Installation

Erection and installation shall only be effected in the case of express agreement at the following further conditions:

- a) The purchaser makes required workers and material available at his/her own expense.
- b) Before the commencement of installation works the purchaser shall make available unsolicited all required specifications, in particular concerning the location of power lines which have been laid such that they are hidden and similar installations, as well as the required static specifications.
- c) Before the commencement of the erection/installation, the delivery items required for the commencement of works have to be on site and all preliminary works progressed to the extent that the erection/installation can immediately begin and be completely carried out without interruption.
- d) In the event that the erection, installation or putting into operation is delayed due to circumstances for which Baumüller is not responsible, then the purchaser shall bear the costs for idle time and journeys required on the behalf of the installation personnel.
- e) The installation personnel working time has to be certified weekly by the purchaser. The purchaser shall present to the installation personnel a written certification regarding the ending of the erection/installation without delay.
- f) Baumüller shall not be held liable for the installation personnel works, in as far as the works are not connected to the delivery and the erection or installation.
- g) Trial runs on systems not supplied by Baumüller shall not be carried out by the installation personnel.

8.4 Index

A

| | |
|----------------------|----|
| Appendix | 43 |
| Assembly Information | 18 |

B

| | |
|------------------|----|
| Ballast resistor | 38 |
| BB | 31 |
| Block Diagram | 10 |

C

| | |
|---------------------------------|----|
| Cabling | 21 |
| Characteristics | 9 |
| Commissioning | 33 |
| Compulsive turn-on | 36 |
| Conditions of Sale and Delivery | 45 |
| Connection Diagram | 26 |
| Connection Information | 30 |
| Connection to BUM 62 | 27 |
| Connection to BUM 63 | 28 |
| Connection to BUM 64 | 29 |
| Control Terminals | 31 |
| Coolant temperature range | 11 |
| Cross-section of cable | 11 |

D

| | |
|-----------------------------|----|
| Declaration by Manufacturer | 43 |
| Declaration of Conformity | 44 |
| Degree of protection | 11 |
| Description of Function | 9 |
| Dimensions | 16 |
| Discharge Currents | 25 |
| Disposal | 42 |

E

| | |
|-----------------|----|
| Electrical Data | 11 |
| EMC Information | 20 |

F

| | |
|-----------------|----|
| Fastening | 18 |
| Filter Assembly | 25 |
| Filtering | 25 |
| Flow Diagram | 35 |

G

| | |
|-----------|----|
| Grounding | 23 |
|-----------|----|

I

| | |
|---------------------------------|----|
| Installation | 19 |
| Intermediate circuit connection | 30 |

M

| | |
|---------------------------|----|
| Maintenance | 41 |
| Maintenance information | 41 |
| Max. ballast power | 11 |
| Measures for Ensuring EMC | 21 |
| Messages | 37 |
| Minimum cross-section | 11 |
| Mounting | 15 |

O

| | |
|------------------|----|
| Operation | 36 |
| Overload message | 36 |

P

| | |
|-------------------|--------|
| Pin Assignments | 31 |
| Plug-in connector | 31, 32 |

| | |
|-----------------|----|
| Power terminals | 30 |
|-----------------|----|

R

| | |
|-------|----|
| RESET | 36 |
|-------|----|

S

| | |
|---------------------------|----|
| Safety notes | 5 |
| Screening | 24 |
| Security information | 19 |
| Site altitude | 11 |
| Storage temperature range | 11 |

T

| | |
|-----------------------|----|
| Technical Data | 9 |
| Transportation | 13 |
| Transportation damage | 13 |
| Type Code | 12 |

U

| | |
|-----------|----|
| Unpacking | 13 |
|-----------|----|

W

| | |
|----------|----|
| Warnings | 37 |
| Weight | 11 |

be in motion

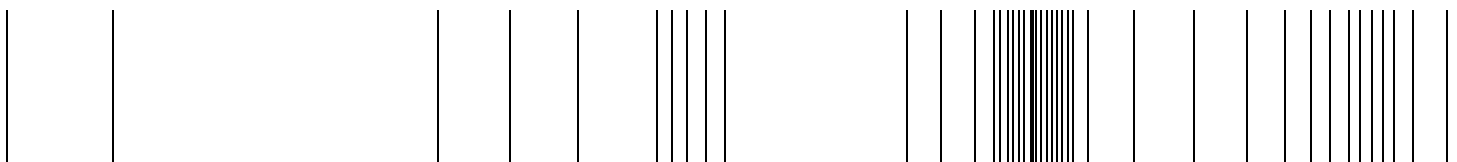

Baumüller Nürnberg GmbH Ostendstraße 80-90 90482 Nürnberg T: +49(0)911-5432-0 F: +49(0)911-5432-130 www.baumueller.de

All information given in this manual is customer information, subject to change without notice. We reserve the right to further develop and actualize our products continuously using our permanent revision service. Please notice, that specifications/data/information are current values according to the printing date. These statements are not legally binding according to the measurement, computation and calculations. Before you make any information given in this manual to the basis of your own calculations and/or applications, please make sure that you have the latest edition of the information in hand. No liability can be accepted concerning the correctness of the information.