

(I)GSU 14B

Ultrasonic Label Fork

en 03-2010/07 50109234



Dimensioned drawing

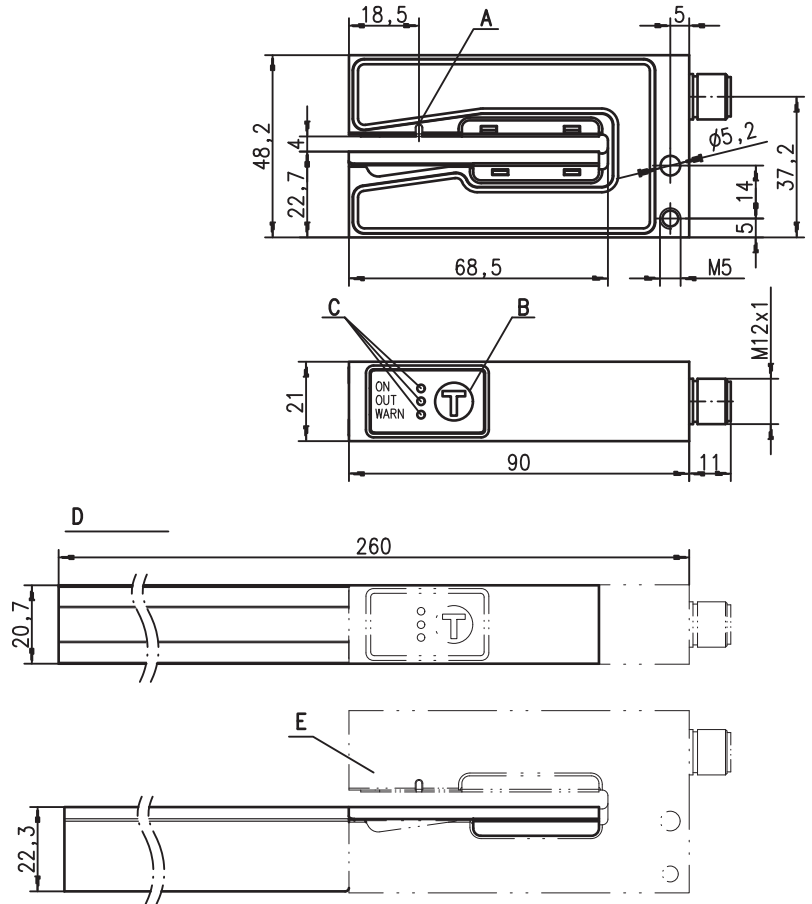

- A Sensor marker (center of label tape)
- B Teach-in button
- C Indicator diodes (ON, OUT, WARN)
- D View with extended carriage mounted
- E Sensor

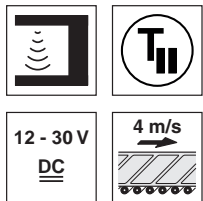

4mm

- Ultrasonic forked sensor for universal application
- Large mouth width, hence also suitable for booklets or fan-fold flyers
- Basic version GSU 14B comparable with the previous model GSU 14

IGSU 14B only:

- **NEW** – *easyTeach* function: press button - dispense labels - done!
- **NEW** – ALC function (Auto Level Control): highest performance reserve through autonomous online optimization of the switching threshold
- **NEW** – Warning output for indicating teach or function errors
- **NEW** – Easy adjustment via lockable teach button or teach input

Electrical connection

GSU 14B/66.3-S12

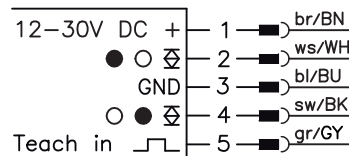

GSU 14B/66D.3-S12

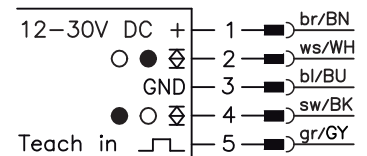

IGSU 14B/6.3-S12

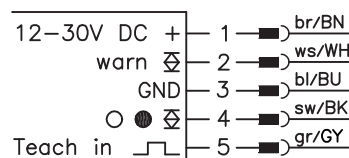

IGSU 14B/6D.3-S12

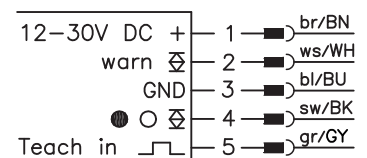

Accessories:

(available separately)

- Carriage short (Part No. 501 09580)
As replacement for the series part.
- Extended carriage (Part No. 501 09579)
For better guiding of oversized labels.
The rail can be shortened at any point.
- M12 connectors (KD ...)
- Cable with M12 connector (K-D...)

We reserve the right to make changes • DS_IGSU_14B_en.fm



Specifications

Physical data

Mouth width	4 mm
Mouth depth	68 mm
Label length	≥ 5 mm
Label width	≥ 10 mm
Label gap	≥ 2 mm
Conveyor speed	≤ 240 m/min (4 m/s)
Conveyor speed with teach-in	≤ 50 m/min (0.83 m/s)
Typ. response time	≤ 200 μs
Repeatability ¹⁾	± 0.2 mm
Delay before start-up	≤ 300 ms acc. to IEC 60947-5-2

Electrical data

Operating voltage U_B	12 VDC (-5%) ... 30 VDC (incl. residual ripple)
Residual ripple	≤ 15% of U_B
Open-circuit current	≤ mA
Switching output ²⁾	.../66 2 push-pull switching outputs pin 4: PNP light switching, NPN dark switching pin 2: PNP dark switching, NPN light switching
	.../66D 2 push-pull switching outputs pin 4: PNP dark switching, NPN light switching pin 2: PNP light switching, NPN dark switching
	.../6 1 push-pull switching output pin 4: PNP light switching, NPN dark switching
	.../6D 1 push-pull switching output pin 4: PNP dark switching, NPN light switching
Warning output ²⁾	1 push-pull switching output pin 2: active low (normal operation high, event case low) light/dark switching, adjustable
Function switching output IGSU	≥ ($U_B - 2V$) ≤ 2V
Signal voltage high/low	≤ 100 mA
Output current	≤ 0.5 μF
Capacitive load	

Indicators

Green LED	ready
Green LED, flashing	teach-in activated
Yellow LED	switching point in the label gap
Red LED	teaching error / function error

Mechanical data

Housing	aluminum, anodized
Color	red/black
Weight	160 g
Connection type	M 12 connector, 5-pin

Environmental data

Ambient temp. (operation/storage)	0 °C ... +60 °C / -40 °C ... +70 °C
Protective circuit ³⁾	1, 2
VDE safety class	III
Protection class	IP 65
Standards applied	IEC 60947-5-2

Options

Teach-in input

Active/not active	≥ 8V / ≤ 2V
Input resistance	15 kΩ

- 1) Depending on conveyor speed, label length and spacing between labels
 2) The push-pull switching outputs must not be connected in parallel
 3) 1=polarity reversal protection, 2=short-circuit protection for all outputs

Marking on the sensor

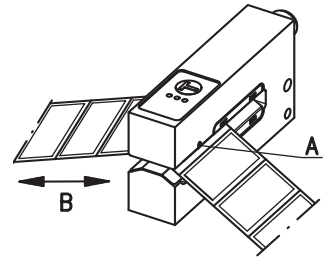

- A Label center position
 B Label run

Remarks

Approved purpose:

The ultrasonic label forks are ultrasonic sensors for contactless detection of the gap between two consecutive labels on a carrier tape.

This product may only be used by qualified personnel and must only be used for the approved purpose. This sensor is not a safety sensor and is not to be used for the protection of persons.

- To achieve high repeatability, the label tape must be slightly under tension.
- Align the label tape according to the sensor's marker "Label center position" (see also marking on sensor).
- The label material used determines the achievable precision and the reliability of gap detection!
- Light switching: signal in the label gap.
- Dark switching: signal on the label.

Order guide

Selection table		GSU 14B/66.3-S12 Part No. 50109498	GSU 14B/66D.3-S12 Part No. 50109499	GSU 14B/66D.31-S12 Part No. 50111929	IGSU 14B/6.3-S12 Part No. 50109276	IGSU 14B/6.31-S12 Part No. 50111931	IGSU 14B/6D.3-S12 Part No. 50109277
Order code →							
Equipment ↓							
Switching output (presetting)	light switching (signal in the label gap)	●			●	●	
	dark switching (signal on the label)		●	●			●
Connection	M 12 connector, 5-pin	●	●	●	●	●	●
Function characteristics	comparable predecessor model GSU 14	●	●	●			
	with warning output, <i>easyTeach</i> and ALC function				●	●	●
Carriage	short	●	●		●		●
	long			●		●	

Comparison of device versions

Basic functions	GSU 14B (Basic)	IGSU 14B (Advanced)
Directly comparable to GSU 14	✓	-
Universal application (paper, transparent foil, metalized foil)	✓	✓
Suitable for booklets and fan-fold flyers	✓	✓
Maximum conveyor speed up to 240m/min (4m/s)	✓	✓
Typ. response time ≤ 200µs	✓	✓
1 adjustable switching output (light or dark switching function)	-	✓
2 switching outputs	✓	-
Special functions		
Manual teach-in	✓	-
<i>easyTeach</i>	-	✓
Online optimization of the switching threshold by ALC (<u>a</u> t <u>l</u> evel <u>c</u> ontrol)	-	✓
Warning display on the device	✓	✓
Warning output for indicating teach or function errors	-	✓

Overview of operating structure for GSU 14B

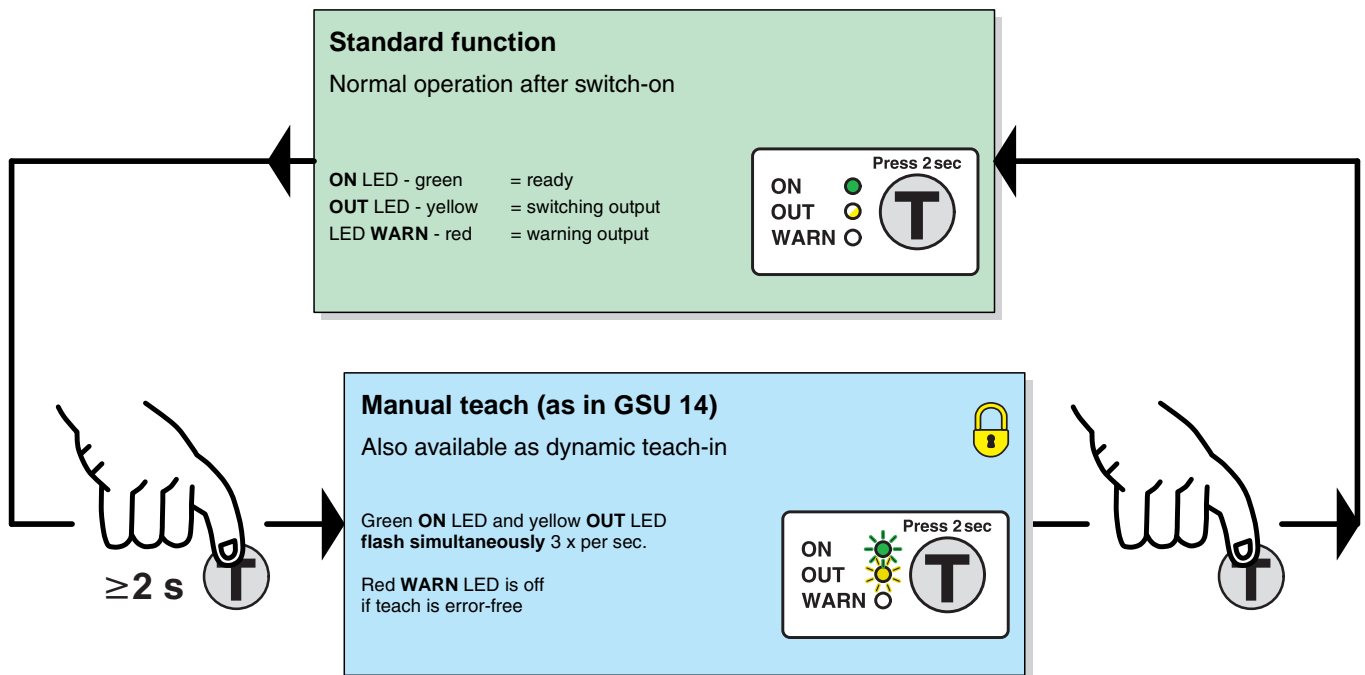

 = function lockable through constant application of U_B on the teach input

Standard function of GSU 14B and IGSU 14B

During operation the sensor is always in this function. The sensor detects label gaps with high precision and speed. This is indicated by the yellow LED and the switching output.

Indicators:

ON LED - green	(I)GSU 14B	Constantly ON when operating voltage is applied.
OUT LED - yellow	(I)GSU 14B	Indicates the switching signal. LED is ON if the sensor detects label gaps. The display is independent of the output setting.
WARN LED - continuous red light	GSU 14B	OFF: error-free operation. ON: teaching error caused by unfavorable label material.
	IGSU 14B	OFF: error-free operation. ON: teaching error caused by unfavorable label material, ALC function outside of the control window.
WARN LED - flashing red	GSU 14B	Short-circuit at the switching output. The output is switched to tri-state until the error is rectified.
	IGSU 14B	Short-circuit at the switching output and/or warning output. All outputs are switched to tri-state until the error is rectified.

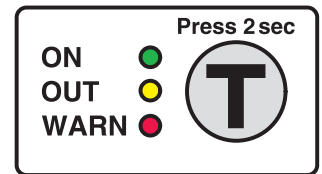

Operation

The teach button must be pressed for at least 2 seconds to operate the device. The button can be electrically disabled to prevent accidental operation.

Sensor setting (Teach-In) via teach button for GSU 14B

Manual teach while label tape is passing through (dynamic)

Preparation: Insert label tape into the sensor.

- Press the teach button until green and yellow LEDs flash simultaneously.
- Release teach button.
- Advance the label tape through the sensor.
- Press the button briefly once more to terminate the teach event, the sensor goes into standard mode.

3 ... 7 label gaps should be advanced through the sensor in order to achieve stable switching points.

If the teach event is faulty (e.g. unfavorable material combination, uneven transport, jittering during transport), the red LED illuminates. Repeat the teach event. If the fault cannot be rectified, the label material cannot be detected with the GSU 14B.

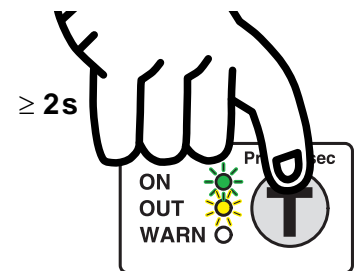

The **green** and the **yellow** LEDs flash **simultaneously** approx. 3x per sec.

Sensor setting (Teach-In) via teach input for GSU 14B

Manual teach while label tape is passing through (dynamic)

Preparation: Insert the label tape in the correct position in the sensor (align the middle of the tape to the sensor marking).

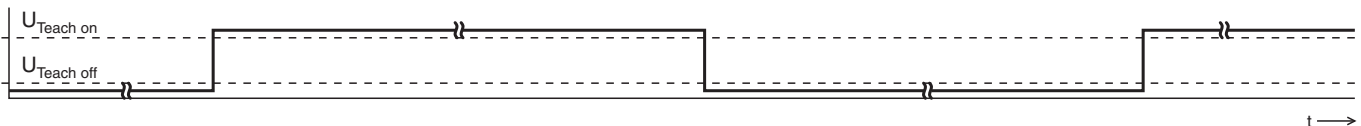

After switching on the supply voltage and after the delay before start-up has concluded ($\leq 300\text{ms}$), the teach button on the device can be operated.	High level on the teach-in input triggers the teach event. Advance 3 ... 7 labels through the sensor. Sensor remains in teach as long as the high signal is applied.	The edge transition (1 -> 0) terminates the teach event. The sensor is in normal operation again.	A rising edge triggers a new teach event.
	At the same time the teach button is disabled with the first rising edge (0 -> 1). Attention: The button remains disabled as long as voltage is supplied to the sensor (until the sensor is switched off).	The button remains disabled until the sensor is switched off.	The button remains disabled until the sensor is switched off.

The red LED illuminates if a teaching error occurs (e.g. the label cannot be reliably detected due to insufficient signals).

Regardless of the state, the green LED illuminates upon conclusion of the teach event; the yellow LED indicates the current switching state.

Overview of operating structure for IGSU 14B

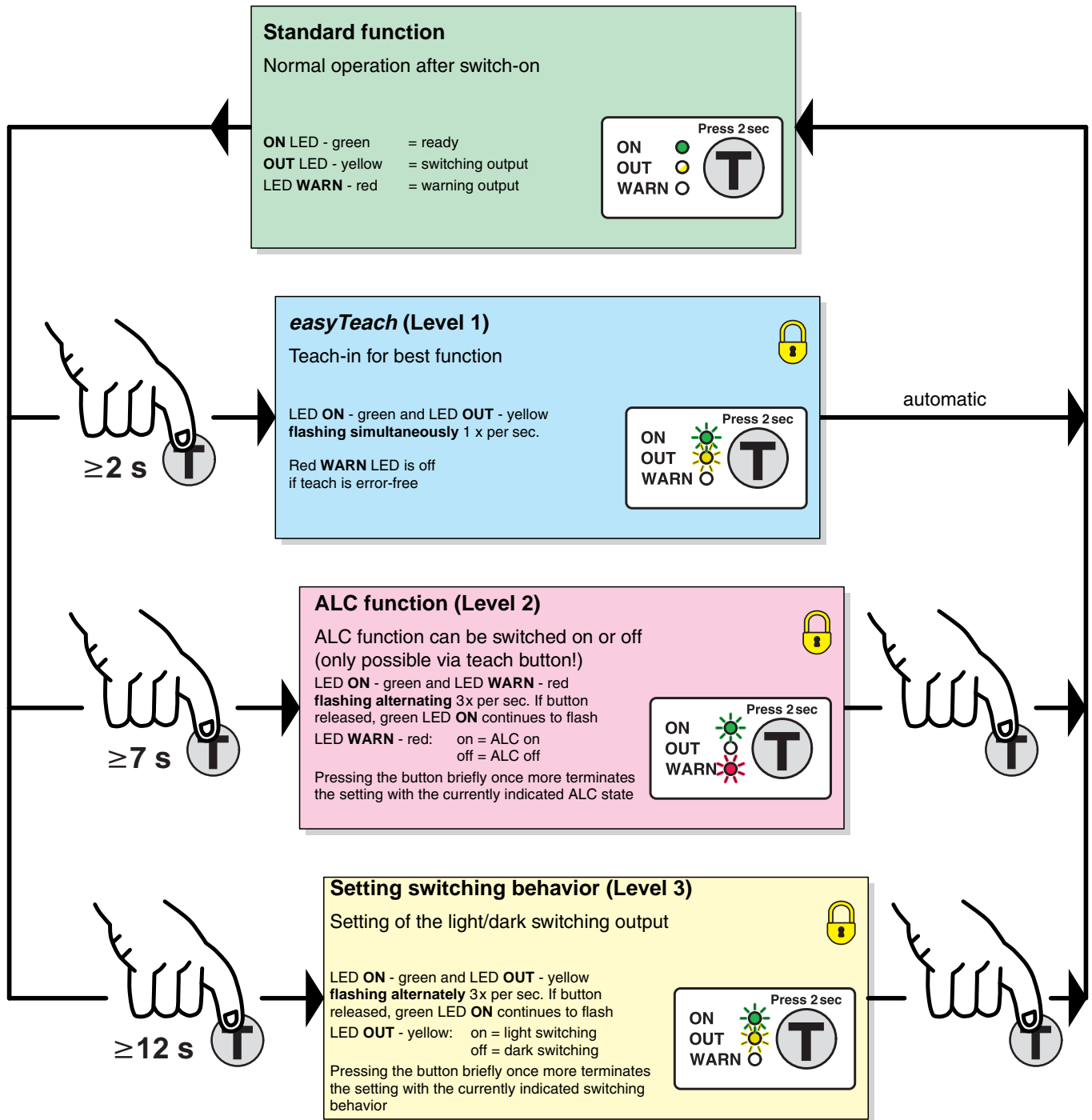

= function lockable through constant application of U_B on the teach input

Sensor setting (Teach-In) via Teach button for IGSU 14B

easy Teach while the label tape is passing through

Preparation: Insert label tape into the sensor.

- Press the teach button until green and yellow LEDs flash simultaneously.
- Release teach button.
- Advance the label tape through the sensor at a max. speed of 50 m/min. The sensor indicates the tape transport by faster simultaneous flashing of the green and yellow LED.
- Finished.

If sufficient teach values are determined, the sensor automatically terminates the teach event and goes into standard mode. The transport of the label tape can be stopped immediately. The number of labels to be transported is always based on the material combination: from experience, the value is between 2 and 10 labels.

If the teach event is faulty (e.g. unfavorable material combination, uneven transport, jittering during transport), the red LED illuminates and the warning output is activated. Repeat the teach event. If the fault cannot be rectified, the label material cannot be detected with the IGSU 14B.

Adjusting the ALC function for IGSU 14B

- Press the teach button until green and red LEDs flash alternately.
- Release the teach button - the green LED continues to flash, the red LED alternates slowly between ON and OFF.
- Red LED ON = ALC function on
Red LED OFF = ALC function off.
- Pressing the button briefly once more terminates the setting with the currently indicated ALC state.
- Finished.

Attention: This function can only be executed with the teach button!

About ALC function (Auto Level Control):

In each teach event, the current signal values in the sensor are digitally determined, resulting in the optimum switching threshold being calculated for maximum performance reserve. All values are saved and are non-volatile, retaining their validity as long as the dynamic parameters of the system remain unchanged and the material is not changed.

Signal changes can result each time the roll is changed, even with labels that are apparently the same. This is caused, for example, by material variations (material thickness, homogeneity, etc.) which affect the acoustic impedance of the system. Even changes of the dynamic parameters (e.g. tape tension, middle position, jitter, etc.) can have a negative affect on the performance reserve of the sensor.

When the ALC function is switched on, the sensor now automatically corrects the switching threshold in such a way that the maximum performance reserve is always available during operation - the sensor works absolutely reliably and free of errors.

When changing to another type of label, however, a new adjustment must generally be carried out by carrying out a new teach-in event.

Warning output

The warning output is activated if the red LED on the device is illuminated. This is the case for the following states:

- Teaching error (see description)
- "ALC function faulty" error (control limit reached: clean device, align and reteach)

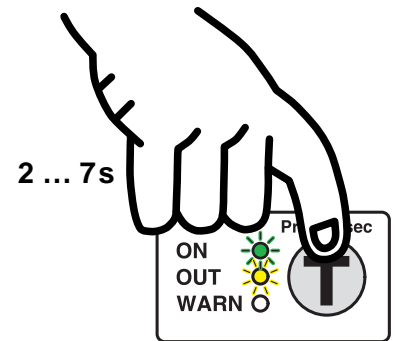

The **green** and the **yellow** LEDs flash **simultaneously** approx. 1x per sec.

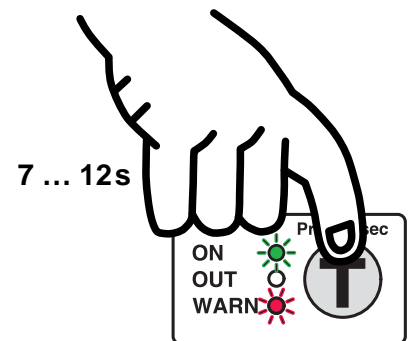

The **green** and the **red** LEDs flash **alternately** approx. 3x per sec.

Adjusting the switching behavior of the switching output (light/dark switching) for IGSU 14B

- Press the teach button until green and yellow LEDs flash alternately.
- Release the teach button - the green LED continues to flash, the yellow LED alternates slowly between ON and OFF.
- yellow LED ON = output switches on light
yellow LED OFF = output switches on dark.
- Pressing the button briefly once more terminates the setting with the currently indicated switching behavior.
- Finished.

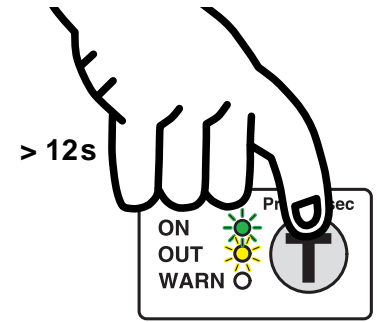

The **green** and the **yellow** LEDs flash alternately approx. 3x per sec.

Sensor setting (Teach-In) via teach input for IGSU 14B



The following description applies to PNP switching logic!

U_{Teach} not connected	Internal pull-down resistor pulls the input down to zero	Teach button can be operated; all functions adjustable
$U_{Teach\ low} \leq 2V$	Low level	Teach button can be operated; all functions adjustable
$U_{Teach\ high} \geq (U_B - 2V)$	High level	Teach button disabled; button has no function
$U_{Teach} > 2V \dots < (U_B - 2V)$	Not permitted	Level not defined; current state is retained

The device setting is stored in a fail-safe way. A reconfiguration following voltage interruption or switch-off is thus not required.

easyTeach while label tape is passing through

Preparation: Insert the label tape in the correct position in the sensor (align the middle of the tape to the sensor marking).

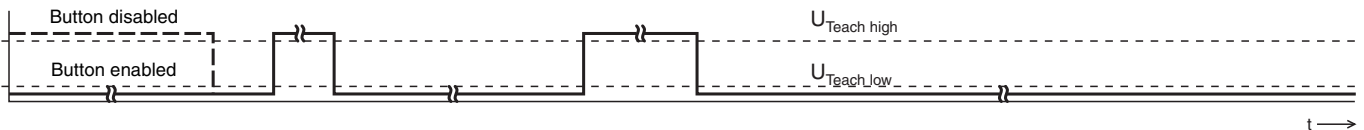

After switching on the supply voltage and after the delay before start-up has concluded ($\leq 300ms$), the teach button on the device can be operated.	2 x 4 ... 100ms Only if the teach button was disabled before the teach. The teach button is disabled after the 1st edge transition.	easyTeach: $t_{Teach} = 4 \dots 900ms$	4 ... 100ms	Teach event starts: The green and yellow LEDs flash simultaneously approx. 1x per second. Advance labels at a tape running speed of max. 50m/min through the sensor until the teach event is automatically terminated by the sensor, i.e. the LEDs no longer flash. The number of labels which must be transported depends on the carrier and label material. During the event, the button on the device is disabled, it can be operated again after this.
---	--	--	-------------	--

The red LED illuminates if a teaching error occurs (e.g. the label cannot be reliably detected due to insufficient signals).

Regardless of the state, the green LED illuminates upon conclusion of the teach event; the yellow LED indicates the current switching state.

Adjusting the switching behavior of the switching output – light/dark switching

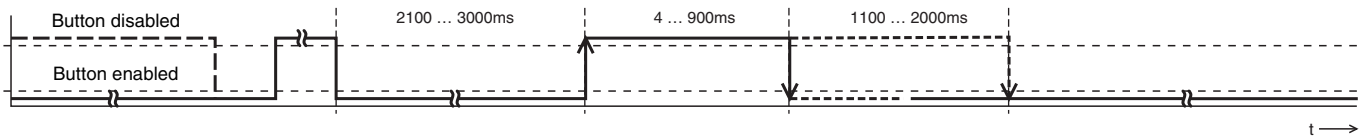

After switching on the supply voltage and after the delay before start-up has concluded ($\leq 300\text{ms}$), the teach button on the device can be operated.	2 x 4 ... 100ms The teach button is disabled after the 1st edge transition. The teach button is disabled after the 1st edge transition.	Teach switching output: $t_{\text{Teach}} = 2100 \dots 3000\text{ms}$	Switching output light switching (4 ... 900ms) Switching output dark switching (1100 ... 2000ms)	The teach button is enabled again.
--	--	---	---	------------------------------------

Notices for integrating the sensor in a control concept

If the sensor is taught externally via a control, it may be necessary to receive acknowledgment from the sensor with respect to its current teach state. Use the following chart for this purpose:

Operating mode	Reaction from sensor
Dispensing mode	Dynamic output signal: alternates between gap and label
Teach	Static output signal: the state prior to the teach event is frozen (output in tri-state)
Teach OK	Output signal is dynamic again – warning output not active
Teach faulty	Output signal is dynamic again – warning output active; repeat teach event if necessary

Locking the teach button via the teach input



GSU 14B:

The teach button is disabled with the **first rising edge** (0 -> 1) on the teach input.

Attention: The button remains disabled until the sensor is switched free of voltage (disabled).

IGSU 14B:

A **static high signal** ($\geq 4\text{ms}$) on the teach input locks the teach button on the device if required so that no manual operation is possible (e.g. protection against erroneous operation or manipulation).

If the teach input is not connected or if there is a static low signal, the button is enabled and can be operated freely.

