

# COMBITEST Test System



## Features

- Fail-safe sequential disconnection of current, voltage and trip circuits when the test-plug handle is inserted.
- Latching feature when the test-plug handle is withdrawn allowing the relay to stabilize with service values before the trip circuits are restored. This prevents inadvertent tripping.
- Complete isolation of secondary instrument transformer circuits.
- Trip-block plug which isolates a trip circuit without interrupting other circuits, allowing the trip output to be monitored, and also provides visual indication of an isolated trip circuit.
- Block-plug handle which disconnects all circuits routed through the test switch.
- Ammeter test-plug with local automatic short-circuiting device in case of inadvertent opening of a CT circuit.
- Auxiliary station power supply made available for test equipment.
- Extension bases which facilitate measurement and adjustment of plug-in module circuits.

## Application

The COMBITEST system for testing of protection relays is built up around the RTXP 8, RTXP 18 or RTXP 24 test switches. The test switch can also be used for other testing needs not directly associated with relays, such as for switchboards or voltmeters.

The test switch may be used where testing would otherwise require disconnection of the instrument transformer's secondary or control wiring. It may also be used to advantage in the testing of other complete relay systems, even when each individual relay has its own test switch.

When the test-plug handle is inserted into the test switch, preparations for testing are automatically carried out in the proper sequence, i.e. blocking of tripping circuits, short-circuiting of CT's, opening of voltage circuits, making relay terminals available for secondary injection.

The test-plug handle may be connected to any type of test equipment or instrument. When a number of protection relays of the same type are tested, the test-plug handle need to be moved only from the test switch of one relay to the test switch of the other, without altering previously made connections. If different types of relays are to be tested, it is a simple matter to change the connections on the test-plug handle and the relay testing set.

## Design

The COMBITEST system comprises of the test switch RTXP, the test-plug handle RTXH and the block-plug handle, RTXF. These are designed in three different versions equipped with either 8, 18 or 24 contacts.

Together with the test leads, the trip-block plug RTXB, and an ammeter test-plug RTXM, the COMBITEST forms a complete system for the fast and safe testing of protection relays.

## Test switch

The test switch, RTXP, is built up in a light beige housing containing a number of contact units. The contact units are of two basic types. One type is for trip circuits and designed to open first and close last when the test handle is inserted respectively pulled out. The other type is used for all other circuit functions, current, voltage and auxiliary power. If the housing is not fully equipped with contact units, unused space is occupied by dummies of the same shape as the contact units.

Each test circuit contains two similar, adjacent contact units with the exception of the units for dc supply voltage. An additional shorting bar, which is mounted within portions of the test switch, provides the necessary short-circuiting of the current transformer circuits when the test-plug handle is inserted. All contact units have space for a marking symbol on the front, indicating the significance of it.

The connections are done directly to 20 A COMBIFLEX terminals at the rear of the test switch. The signalling contact on RTXP 24 has 10 A terminals.

The test switches are available with different contact arrangements (see ordering table).

The contact units have guiding slots fitting the guides of the test pins, to prevent incorrect insertion of the test-plug handle. The available contact arrangements and marking symbols are shown in the ordering table.



Figure 1: Test switch, RTXP 8

## Test switch RTXP 8

The test switch RTXP 8 contains eight contacts. It occupies one seat in the COMBIFLEX system with dimensions 2U and 6C (see Figure 1).

An adapter is used for mounting of the RTXP 8 in a 4U rack assembly. This allows one RX 1 terminal base to be mounted under the RTXP 8 (see Figure 2).

## Test switch RTXP 18

The test switch RTXP 18 contains maximum 18 contact units and occupies two seats in the COMBIFLEX system with dimensions of 4U and 6C. It mounts rigidly to the COMBIFLEX apparatus bars.

The contact blocks are numbered consecutively on the left-hand side with markings 1-18, from top to bottom. Similar markings are arranged on the right-hand side of the contact block for the function. As standard the contact block for + is placed at the top (position 1) and the contact block for - at the bottom (position 18) of the housing.

The front of the test switch has a door with two face labels having space for the test device and the protection relay data. Space is also provided for order specific text. On the back of the door there is a label showing the type and location of the contacts and bypassing bars used in the test switch.

## Test switch RTXP 24

The test switch RTXP 24 consists of two housings screwed together with the base to one unit. Each housing contains a maximum of 12 contact units. Further, one contact for the signalling of a test under progress, is located on the top right-hand housing. The test switch occupies the front space of 3 U 12 C.

It mounts rigidly to any standard European rack system and it can also be installed in RHGS, RHGP and RHGX cases and in RHGT equipment frames.

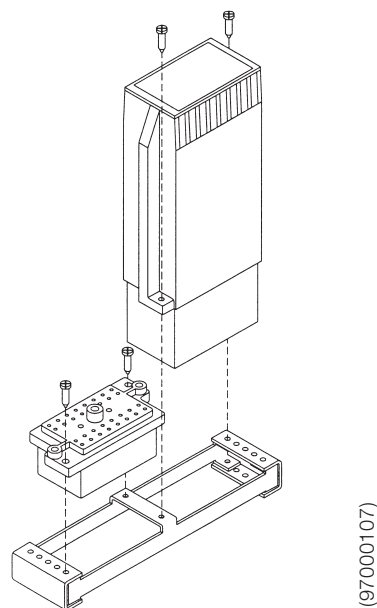

Figure 2: The assembly of RTXP 8 and terminal base RX 1 with the 4U adapter

The contact units are arranged in two vertical rows and are consecutively numbered with markings 1-12 on the left-hand row and 13-24 on the right-hand row. Similar markings indicating the functions are arranged on the outer sides of the two rows of contact units. Contact units of positive and negative dc auxiliary supply have fixed positions and are placed in the left-hand row top (+ position 1) respectively bottom (- position 12) of the housing.

The normally open contact for signalling is closed when the test-plug handle is inserted. The block-plug will not close the contact.

The front of the test switch has two doors, each with a label. The left-hand label has space for protective relay data and test specified by the customer. On the right-hand label the type, ordering number and symbol of the test switch are shown.

### Test-plug handle

The test-plug handle, RTXH, is fitted with banana-plug sockets for use with 4 mm banana plugs. Test leads are used to connect between the banana-plug socket on test-plug handle and the relay testing set. Plugs for positive and negative dc auxiliary voltage maintain circuit continuity when inserted into the test switch. The other plugs are test plugs which disconnect the primary circuits (connected to the A-side of the test switch) from the relay (connected to the B-side of the test switch) and connect it to the test leads. To prevent unwanted tripping when the handle is withdrawn, latches on the handle secure it in the half withdrawn position. In this position, all voltages and currents are restored to the relay and any reenergizing transients are given a chance to decay before the trip circuits are restored. When the latches are released, the handle can be completely withdrawn from the test switch, restoring the trip circuits to the relay.

### Test-plug handle RTXH 8

The test-plug handle RTXH 8, should be used for the testing of relays equipped with test switch RTXP 8. It has 8 plugs,

each plug has two banana-plug sockets for connection of test leads. Plus and minus auxiliary DC voltage is not intended to be brought out via the RTXH 8 contacts. This allows all 8 pins to be used for test signals.

### Test-plug handle RTXH 18

The test-plug handle, RTXH 18, should be used for the testing of relays equipped with test switch RTXP 18. It has 18 plugs, each plug has two banana-plug sockets for connection of test leads. The plugs in position 1 and 18 are for positive and negative dc auxiliary voltage respectively.

### Test-plug handle RTXH 24

The test-plug handle, RTXH 24, should be used for the testing of relays equipped with test switch RTXP 24. It has 24 plugs, arranged in two vertical rows and each plug has two banana-plug sockets for connection of test leads. The plugs in position 1 and 12 are for positive and negative dc auxiliary voltage respectively. The signalling contact is closed by the top right-hand guide of the test-plug handle.

### Test leads

Red and black test leads are available in two types. One type has a cross section of 2.5 mm<sup>2</sup> and is 2.0 m long with a 4 mm banana-plug in each end. The other type has a cross section of 1.0 mm<sup>2</sup> and is 2.0 m long with a 10 A COMBIFLEX terminal pin in one end and a 4 mm banana-plug in the other.

### Trip-block plug

The trip-block plug, RTX B, is a short red plug, which can open a trip-type contact only. It cannot cause any switching action if it is inadvertently plugged into a wrong position. It can also be used for measurement purposes in trip circuits. The plug is red to draw attention to the fact that blocking has been carried out. The door of the COMBIFLEX equipment frame can be closed while the plug remains inserted in the test switch.



Figure 3: Test switch, RTXP 18



Figure 4: Test switch, RTXP 24



Figure 5: Test-plug handle, RTXH 24

### Ammeter test-plug

The ammeter test-plug RTXM is thinner than the other plugs so that when inserted into a current position it connects the meter in series with the circuit, but does not open the switch far enough to cause the current shorting bars to be contacted. This plug is equipped with a local overvoltage protection which short-circuits the current circuit in case of an inadvertent opening of the CT. At approximately 100 V the overvoltage protection is shortcircuiting. A neon lamp in the overvoltage protection indicates the short-circuiting.

The overvoltage protection can withstand a continuous current of 5 A. At very high current during a short time, up to 125 A during 1 s, the voltage between the connection leads is limited to a harmless level. Permanent short-circuiting in the overvoltage protection can be the consequence of such a high current. The plug shall be replaced by a new plug after a

### Methods of use: plugs and contacts

Test switch includes:



(xx04000330)

Contact unit for current and voltage circuits



(xx04000331)

Contact unit for trip circuits



(RTXF\_24.eps)

Figure 6: Block-plug handle, RTX 24

very high current through the overvoltage protection.

The plug has 1 black and 1 red lead, 2.0 m in length with a 2.5 mm<sup>2</sup> cross-section. The free ends are fitted with 4 mm banana-type plugs. The plug is to be inserted with the red lead connected to the relay side.

### Block-plug handle

The block-plug handles, RTX 8, 18 and 24, consist of 8, 18 and 24 test-plugs respectively, clipped together. This device completely blocks the relay by disconnecting all circuits routed through the test switch, including the dc power supply. The signalling contact in RTXP 24 is not activated when the block-plug handle is inserted. When the block-plug handle is inserted, the door of a COMBIFLEX equipment frame can be closed.

Test-plug handle includes:

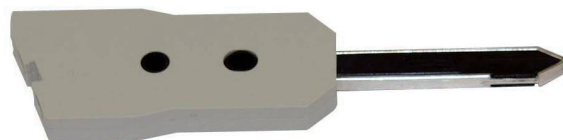

(xx04000332)

dc supply plug; 2 plugs for + and – dc auxiliary voltage supply to the test equipment. Not sold separately.

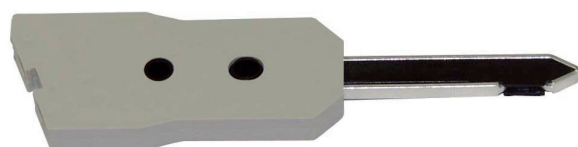

(xx04000333)

16 or 22 test-plugs, for RTXP 18 or RTXP 24 respectively, which disconnect the relay and connect it to the test leads. Not sold separately.

Normal position

Test position

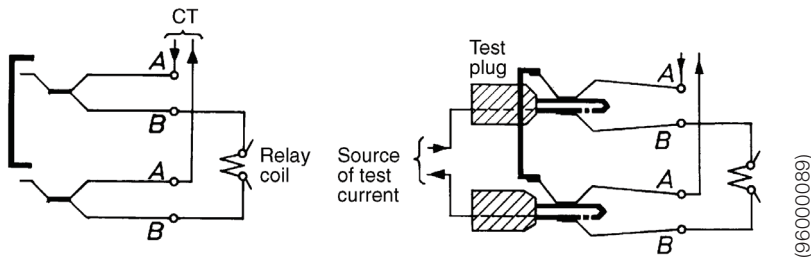

Current testing of relay

### Loose plugs

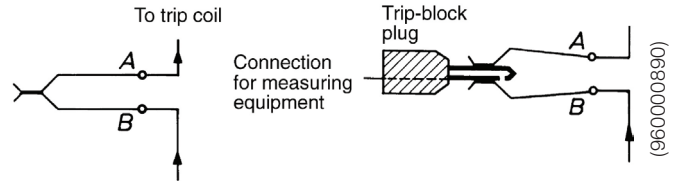
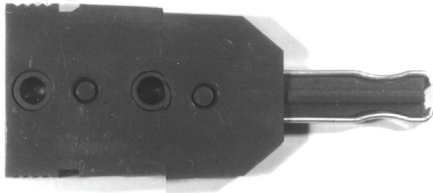

### Trip-block plug

The trip-block plug RTXB is short and is used separately for blocking trip circuits. It can also be used for measurement purposes in trip circuits.

Interruption or blocking of a dc circuit or for time measurement of trip pulses etc.

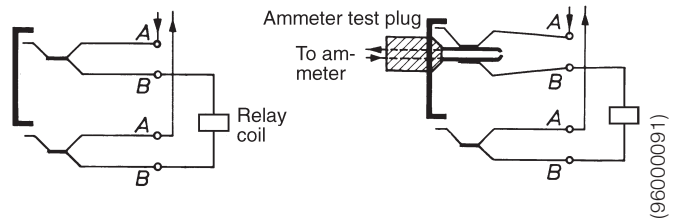

### Ammeter test-plug

The ammeter test-plug RTXM is used separately for service current measurement. It incorporates an overvoltage protection.

Load current measurement

### Extension bases

The extension bases consist of a plug-in plate and a terminal base between which are connected leads with combination pin-sockets.

The 1-seat extension base can also be used for 2, 2H- and 4-seat relay modules, but then with 2 or 4 mounted side-by-side. The 2H seat extension base can also be used for a 4-seat relay module.

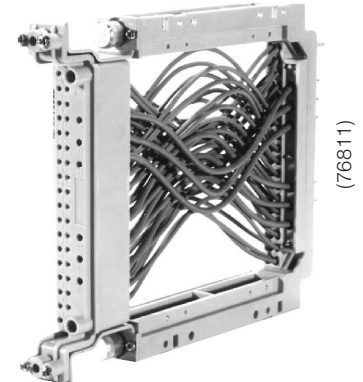
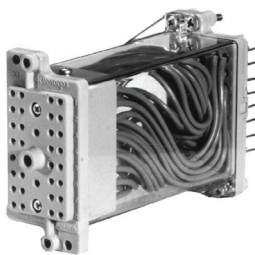

## Technical data

Technical data			
Test voltage	2.5 kV		
Highest system voltage	600 V dc, 500 V ac		
Current-carrying capacity	Test contacts:	continuous	20 A
		for 1 second	500 A
	Signalling contact:	continuous	10 A
		for 1 second	150 A

### Short-circuiting connector

Short-circuiting connectors type RTXK are supplied with ac current relay modules. The connector is fastened to the terminal base of the relay module with screws and allows the module to be withdrawn from its terminal base without the secondary circuit of the CT being opened. In this way, individual relay modules can be changed, tested, or adjusted separately.

Note: Before an undercurrent relay, which is normally energized, is withdrawn, the trip circuit must first be blocked, either directly, by removing the output relay, or by inserting an RTXB trip-block plug into the test switch.

## Ordering

When ordering the test switch, specify:

- Type
- Quantity
- Ordering No.
- Desired wording on the face label
- Function designation symbol with location (contact position) and Symbol No. of each one of these

### Wording on the face labels:

RTXP 8	text on label	max 14 lines	15 characters/line
RTXP 18	text on upper label	max 15 lines	15 characters/line
RTXP 18	text on lower label	max 16 lines	15 characters/line
RTXP 24	text on left-hand label	max 11 lines	15 characters/line

## Ordering example:

### Test switch RTXP 18

unmarked	on position 9-12, 14, 15	symbol 1
+	on position 1	symbol 2
-	on position 18	symbol 3
1L1	on position 3-4	symbol 4
1L2	on position 5-6	symbol 5
1L3	on position 7-8	symbol 6
□	on position 2, 13	symbol 65
⊙	on position 16-17	symbol 66

When ordering other test parts, specify:

- Description
- Quantity
- Ordering No.

Test switch RTXP 18

### Contact functions



Blocking of trip circuit



Short-circuiting of current circuit



Opening of voltage circuit

(96000092)

**RTXP 8**

**Ordering No.**  
RK 926 002

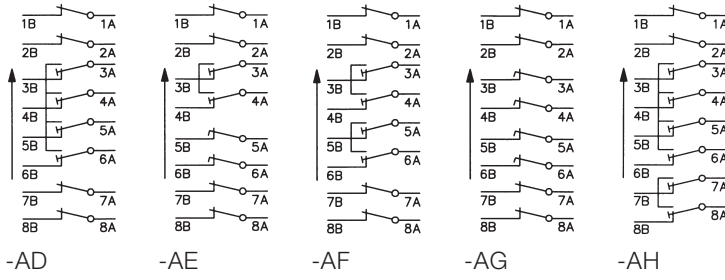

Other standard variants available on request (see References).

**RTXP 18**

**Ordering No.**  
RK 926 115

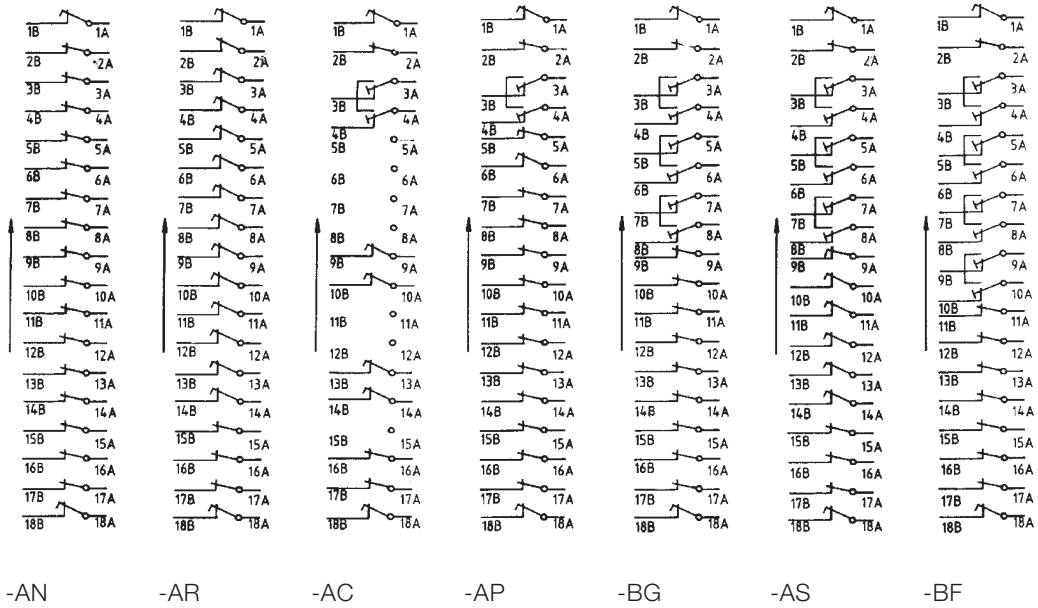

(rk926115-xx)

**Ordering No.**  
RK 926 115

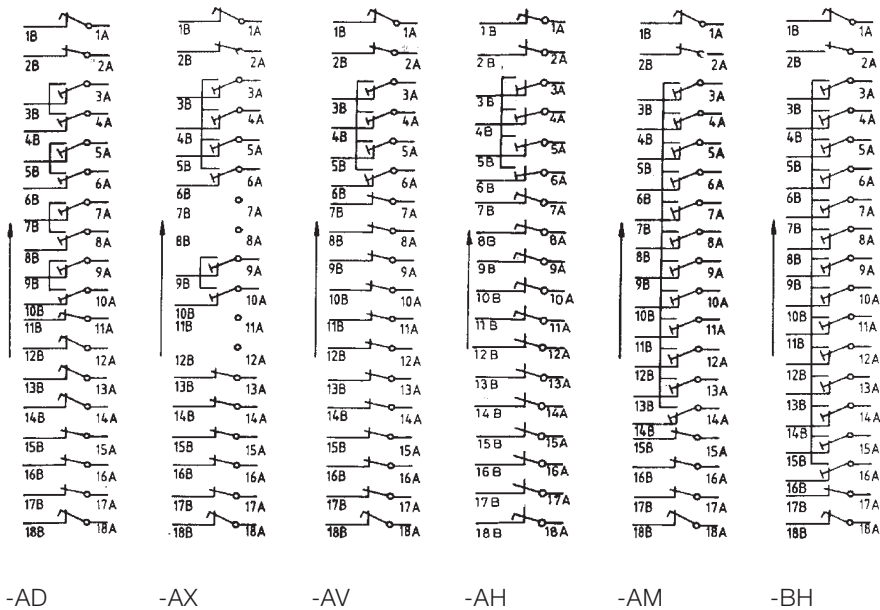

(rk926115-xx)

Other standard variants available on request (see References).



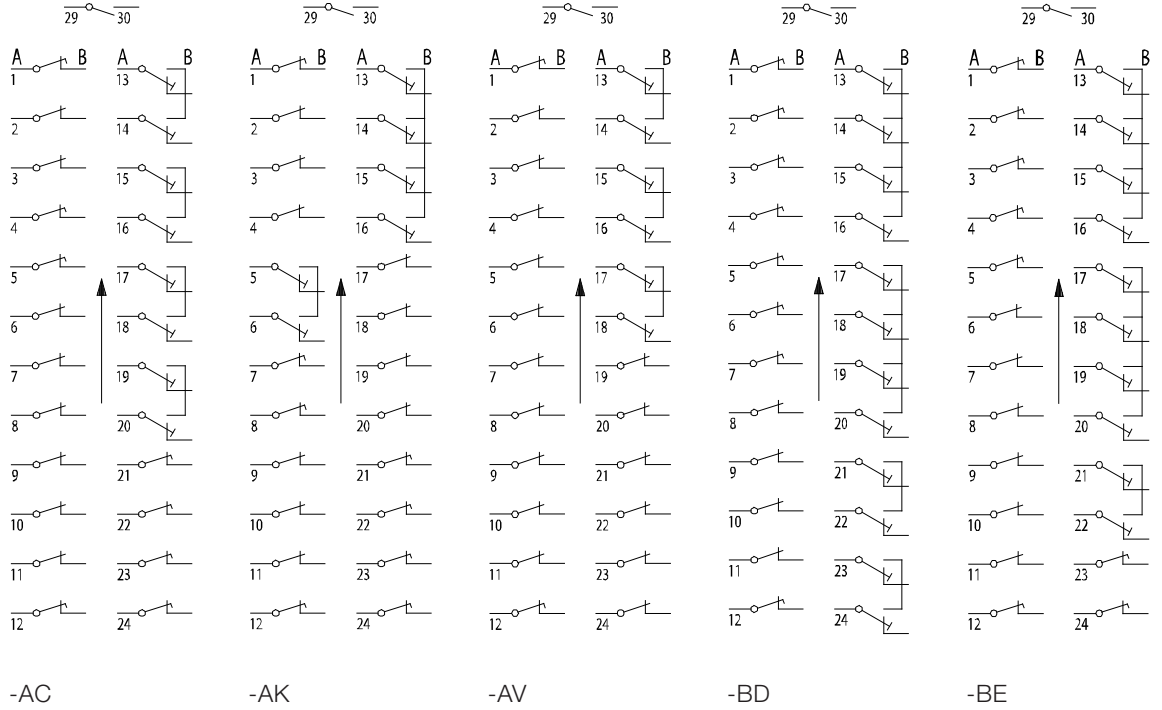

Ordering No.  
RK 926 315

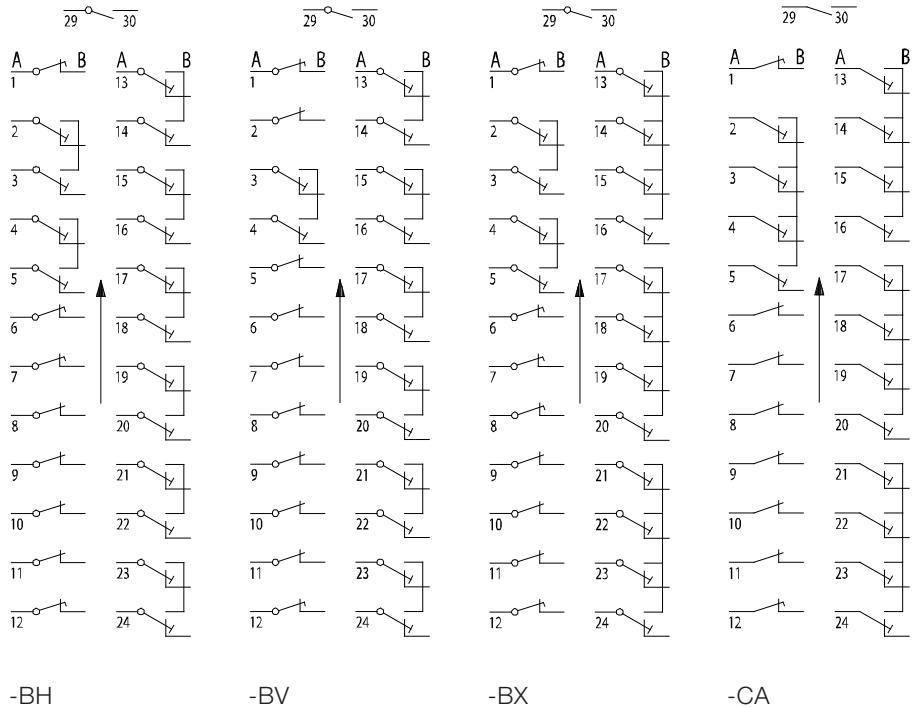

Ordering No.  
RK 926 315

Other standard variants available on request (see References).

## Function description symbols

For marking of the test switch on delivery

Symbol	Significance	Symbol No.	No of labels on a sheet
Unmarked		1	20
+	Positive terminal	2	8
-	Negative terminal	3	8
+/~	Positive terminal or ac voltage	60	1
-/~	Negative terminal or ac voltage	61	1
~	Ac voltage	71	2
IL1	Phase current in each respective phase	4	15
IL2		5	15
IL3		6	15
IN	Neutral current	8	25
I	Current	10	5
$I_d$	Differential current	19	2
$I_{dL1}$	Differential current in each respective phase	20	2
$I_{dL2}$		21	2
$I_{dL3}$		22	2
UL1	Voltages in three-phase systems with neutral	23	10
UL2		24	10
UL3		25	10
UN		27	5
U	Voltage	29	5
$U_1$	Voltages in different stages or levels	30	1
$U_2$		31	1
$U_3$		32	1
□	Various: e.g. signal + outgoing blocking	65	9
⊙	Tripping	66	15
⊕	Closing	67	3
↑•	Raise	68	1
↓•	Lower	69	1
◇	Influence of external factors e.g. blocking or deblocking	70	5

## For loose delivery

Set of 20 sheets (150x64 mm), each with 200 adhesive labels according to the table above.

1MRK 000 132-53

IN	-	IL1	IL2	IL3	UL2	⊙	
IN	-	UN	UL3	UL3	UL2	U	
IN	□	UN	UL3	UL3	UL2	U	
IN	□	UN	UL3	UL3	UL2	U	
IN	□	UN	UL3	UL3	UL2	U	
IN	□	UN	UL3	UL3	UL2	U	
I	IN	□	↑	↓	$U_1$	⊕	◇
I	IN	□	$I_d$	$I_d$	$U_2$	⊕	◇
I	IN	□	$I_{dL1}$	$I_{dL1}$	$U_3$	⊕	◇
I	IN	□	$I_{dL2}$	$I_{dL3}$	~	+/~	◇

(xx04000335)

## Accessories

Description		Ordering No.
Test-plug handle	RTXH 8	RK 926 011-BE
	RTXH 18	RK 926 011-BC
	RTXH 24	RK 926 016-AA
Block-plug handle	RTXF 8	RK 926 007-AC
	RTXF 18	RK 926 007-AB
	RTXF 24	RK 926 016-AB
Extensions bases with terminal base	RX 1	RK 924 035-AA
	RX 2H	RK 924 035-AB
	RXY	5371 069-A
Trip-block plug, RTXB		RK 926 005-AC
Ammeter test-plug RTX M		RK 926 006-AB
Test leads <sup>1)</sup> 2.5 mm <sup>2</sup> , length 2.0 m, banana plugs in both ends	Black	2639 0605-1
	Red	2639 0605-2
Test lead 10 A COMBIFLEX <sup>1)</sup> 1.0 mm <sup>2</sup> , length 2.0 m, banana plug in one end and a 10 A pin in the other	Black	2639 0180-B
	Red	2639 0181-B
Mounting kit for RTXP 24 in 4U rack assembly		1MRK 000 020-BT
Adapter for mounting RTXP 8 in 4U rack assembly		1MRK 000 316-19
A tool box containing some of the accessories above and in addition tools and parts that are useful when testing protection relays and systems belonging to the COMBIFLEX family.		See connection and installation components catalogue.

<sup>1)</sup> Banana plugs are touch safe according to IEC Class II.

## References

Connection and installation components 1MRK 513 003-BEN

Relay mounting systems 1MRK 514 001-BEN

Diagrams for RTXP 8 1MRK001024-AA

Diagrams for RTXP 18 1MRK001024-BA

Diagrams for RTXP 24 1MRK001024-CA

# Contact us

## **ABB AB**

### **Substation Automation Products**

721 59 Västerås, Sweden

Phone: +46 (0) 21 32 50 00

[www.abb.com/substationautomation](http://www.abb.com/substationautomation)

## **ABB Limited**

Plot no. 4A, 5 & 6, II Phase

Peenya Industrial Area

Bangalore - 560 058.

India

Phone: +91 80 2294 9632

Facsimile: + 91 80 2294 9188

### **Note:**

We reserve the right to make technical changes or modify the contents of this document without prior notice. ABB AB does not accept any responsibility whatsoever for potential errors or possible lack of information in this document.

We reserve all rights in this document and in the subject matter and illustrations contained herein. Any reproduction, disclosure to third parties or utilization of its contents – in whole or in part – is forbidden without prior written consent of ABB AB.

© Copyright 2013 ABB.

All rights reserved.