

# User's Manual

High-speed, High-accuracy, Color Vision System

## *CV-700 Series*



## Preface

This instruction manual describes the setting procedures, adjustment, preparation, operation procedures, and precautions for the High-speed, High-accuracy, Color Vision System CV-700(P) Series. Before starting operation, please read this manual carefully to get the most from your CV-700(P) Series. Keep this manual handy for future reference. Please make sure that the end users are provided with this manual.

## Symbols

The following symbols are used for the list of precautions to ensure safety and to prevent personal injury and/or property damage when using the CV-700(P) Series. The following symbols alert you to important messages. Be sure to read these messages carefully.



Failure to follow instructions may lead to death or serious injury.



Failure to follow instructions may lead to injury.



Failure to follow instructions may lead to product damage. (product malfunctions, etc.)

**Important:**

Provides important precautions and restrictions on proper operation.

**Note:**

Provides additional information on proper operation.

**Tips**

Provides useful information on proper operation.

*Reference:*

Provides reference pages.

## General precautions

1. No part of this manual may be reprinted or reproduced in any form or by any means without the prior written permission of KEYENCE CORPORATION.
  2. The content of this manual is subject to change without notice.
  3. KEYENCE has thoroughly checked and reviewed this manual. Please contact the sales office listed at the end of this manual if you have any questions or comments regarding this manual, or if you find an error.
  4. KEYENCE assumes no liability for damages resulting from the use of the information in this manual, item 3 above notwithstanding.
  5. KEYENCE will replace any incomplete or incorrectly collated manual.
- Windows is a registered trademark of Microsoft Corporation of America.
  - CompactFlash™ is a registered trademark of SanDisk Corporation of America.
  - All company names and product names in this manual are registered trademarks or trademarks of their respective owners.

# Safety Precautions

## General precautions

- At startup and during operation, be sure to monitor the functions and performance of the CV-701(P)/751(P).
- We recommend that you take substantial safety measures to avoid any damage in the event of a problem.
- Do not modify the CV-701(P)/751(P) or use it in any way other than as described in the specifications. Its functions and performance are not guaranteed under said conditions.
- When the CV-701(P)/751(P) is used in combination with other instruments, its functions and performance may be degraded, depending on the operating conditions and surrounding environment.
- Do not use the CV-701(P)/751(P) for the purpose of protecting the human body.
- Do not expose the CV-701(P)/751(P) and peripheral devices to sudden temperature change, as this may cause condensation.

## Precautions



**Do not use the CV-701(P)/751(P) with a voltage other than 24 VDC, as this may cause fire, electric shock or equipment failure.**

- Do not disassemble or modify the CV-701(P)/751(P). This may cause fire or electric shock.



### ■ Usage

- Be sure to turn off the power to the CV-701(P)/751(P) and any connected devices before connecting or disconnecting the cables. Otherwise, the camera and connected devices may be damaged.
- Do not turn off the power while setting a parameter. Otherwise, the settings may be partially or completely lost.
- Do not block the ventilation slots on the CV-701(P) and peripheral devices. A rise in inner temperature may cause equipment failure.
- Note: The CV-701(P)/751(P) conforms to CE regulations in Europe; however, please make sure to keep the wiring for the power and the I/O within 30 m. Otherwise, it will not conform to EN61326-1.



#### ■ Proper environment and conditions

To use the CV-701(P)/751(P) properly and safely, do not install the CV-701(P)/751(P) in locations with the following conditions. Use of this equipment in an improper environment may cause fire, electric shock, or equipment failure.

- Locations with high humidity, a large amount of dust, or poor ventilation
- Locations where the temperature rises excessively due to direct sunlight, etc.
- Locations where corrosive or flammable gas exists
- Locations where the CV-701(P)/751(P) is directly subjected to vibration or impact
- Locations where water, oil or chemicals may splash the CV-701(P)/751(P)
- Locate the cables as far as possible from high-voltage lines and power lines. Otherwise, generated noise may cause a malfunction or equipment failure.
- The CV-701(P)/751(P) and peripheral devices are precision machines. Avoid any vibration or impact to these devices.
- Locations where static electricity is easily built up

#### ■ When abnormal conditions are encountered

If the following conditions are encountered, immediately turn off the power. Continuing to use the CV-701(P)/751(P) under abnormal conditions may cause fire, electric shock or equipment failure.

Contact your nearest KEYENCE sales office for repairs.

- When water or foreign matter enters the controller.
- When the CV-701(P)/751(P) is dropped or the housing is damaged.
- When the controller produces smoke or an abnormal smell.

#### Note 1: Maintenance

Do not wipe the CV-701(P)/751(P) with a damp cloth or a cloth moistened with benzene, thinner, or alcohol. This may cause discoloration or deformation of the unit. If there is a large amount of dust or dirt on the CV-701(P)/751(P), remove it using a tightly squeezed cloth moistened with a dilute solution of a neutral detergent, and then wipe the unit with a soft and dry cloth.

#### Note 2: Camera

The CV-701(P)/751(P) uses a specially designed camera. A commercially available camera should not be substituted. (However, any commercially available C-mount lens can be used.)

## Symbols

The following symbols are used in this manual to represent the menu items and keys.

Symbol	Description
[ ]	Menu item. Select from display.
[ ]	Switches and keys.

# How This Manual is Organized

## Chapter 1 Overview

Describes the package contents check and the features and applications of the CV-701(P)/751(P).

## Chapter 2 Preparation

Describes how to connect and mount the CV-701(P)/751(P), how to select lenses, and gives information about illumination.

## Chapter 3 Mode Selection

Explains the types and details of the measurement modes.

## Chapter 4 Setting Procedure

Describes how to use panel keys or the remote control console to set the CV-701(P)/751(P). It covers everything from basic settings to the advanced settings.

## Chapter 5 Operation

This chapter describes RUN mode and the controls available during RUN mode operation.

## Chapter 6 I/O Timing and Analog Output

Explains the input/output timing and analog output.

## Chapter 7 CompactFlash Memory

Explains how to use CompactFlash memory with the CV-701(P)/751(P).

## Chapter 8 RS-232C Interface

Describes the connection between the CV-701(P)/751(P) and a personal computer, and the RS-232C communication used to operate the CV-701(P)/751(P) with a personal computer.

## Chapter 9 Specifications

Describes the specifications and dimensions.

## Appendices

Describes typical troubleshooting procedures, a list of optional parts.

## WARRANTIES

1

2

3

4

5

6

7

8

9

Appendices

WARRANTIES

---

# Contents

Preface .....	i
Safety Precautions .....	ii
How This Manual is Organized .....	iv
Contents .....	v
Menu Hierarchy .....	viii
Special Features .....	ix

## Chapter 1

### Overview

---

1.1 Checking the Package Contents .....	2
1.2 Part Names and Functions .....	3
1.2.1 Part Names and functions of a basic system .....	3

## Chapter 2

### Preparation

---

2.1 Mounting and Connection .....	6
2.1.1 Mounting the controller .....	6
2.1.2 Mounting the camera .....	8
2.1.3 Selecting a lens .....	9
2.1.4 Cable connection and wiring .....	11
2.1.5 Checking the connection .....	13
2.2 Illumination .....	15

## Chapter 3

### Preparation

---

3.1 Measurement Modes and Typical Applications .....	18
3.1.1 "ARE/CON" (Area continuous) .....	18
3.1.2 "INS/TRG" (Inspection trigger) .....	19
3.1.3 "INS+POS" (Inspection + position) .....	22
3.1.4 "ABS.POS" (Absolute position) .....	23
3.1.5 "REL.POS" Mode .....	25
3.2 Selecting the Measurement Mode by Application .....	27

## Chapter 4

### Setting Procedure

---

4.1 Names and Functions of Control Keys and Monitor Screen .....	32
4.1.1 Controller .....	32
4.1.2 Screen page layout .....	34
4.2 Preparations .....	35
4.2.1 Preparations before settings .....	35
4.3 Basic Settings .....	36
4.3.1 Basic setting procedures .....	36
4.3.2 Using two cameras .....	42
4.4 "AREA" Mode Basic Settings .....	57
4.4.1 "AREA" mode .....	57
4.4.2 Initial menu screen .....	58
4.4.3 Basic setting flow .....	59
4.5 "AREA" Mode Advanced Settings .....	65
4.5.1 "AREA/CON" menu .....	65
4.5.2 Advanced color settings .....	69
4.6 "INS" Mode Basic Settings .....	70

4.6.1	“INS” Mode	70
4.6.2	Initial menu screen	72
4.6.3	Basic setting flow	73
4.6.4	Basic setting procedure for the measurement mode	75
4.6.5	Basic setting procedure for COUNT	80
4.6.6	Basic setting procedure for the POINT (Point sensor) mode	84
4.6.7	Basic setting procedure for the STAIN mode	87
4.6.8	Basic setting procedure for the GRAVITY mode	91
<b>4.7</b>	<b>“INS” Mode Advanced Settings</b>	<b>96</b>
4.7.1	“INS/TRG” menu	96
4.7.2	Sensitivity adjustment for edge detection	100
4.7.3	Adjustment for the COUNT and GRAVITY modes	101
4.7.4	Advanced COUNT setting	102
4.7.5	Adjusting the color extraction	103
<b>4.8</b>	<b>“INS+POS” Mode Basic Settings</b>	<b>106</b>
4.8.1	Initial menu screen	106
4.8.2	Basic setting flow	107
4.8.3	“INS+POS” menu	108
<b>4.9</b>	<b>“Position Detection” Mode Basic Settings</b>	<b>109</b>
4.9.1	Initial menu screen	110
4.9.2	Basic setting flow	111
<b>4.10</b>	<b>“Position Detection” Advanced Settings</b>	<b>118</b>
4.10.1	“ABS.POS” Menu	118
4.10.2	“REL.POS” Menu	124
4.10.3	Advanced position adjustment setting (Pattern search)	125
4.10.4	Advanced position adjustment setting (Edge detection)	127
4.10.5	Advanced position adjustment (Tolerance setting)	129
4.10.6	Sensitivity adjustment for edge detection	130
4.10.7	Adjusting the color extraction	131
<b>4.11</b>	<b>Optional Settings</b>	<b>134</b>
4.11.1	Saving the running images	134
4.11.2	Illumination adjustment function	136
4.11.3	Unit conversion	137
<b>4.12</b>	<b>Operation Check of the Setting Status</b>	<b>140</b>
4.12.1	Saving the setting status	140
4.12.2	Comparing with the saved setting status	141
<b>4.13</b>	<b>Initialization</b>	<b>142</b>
4.13.1	Initialization of all settings	142
4.13.2	Initialization by program number	142
<b>4.14</b>	<b>Input/Output Operation in PROGRAM Mode</b>	<b>143</b>
<b>4.15</b>	<b>Environmental Settings</b>	<b>144</b>
4.15.1	Changing the environmental settings	144
4.15.2	Environmental setting list	145
4.15.3	Useful functions	146

## Chapter 5

### Operation

5.1	Entering RUN Mode	152
5.2	Controls Available in RUN Mode	153

## Chapter 6

### I/O Timing and Analog Output

6.1	I/O Terminal Names and Functions	156
6.2	Input/Output Timing Diagrams	160
6.3	I/O Circuit	165
6.4	Analog Output	166

6.4.1 Analog output terminals .....	166
6.4.2 Changing analog output settings .....	166
6.4.3 Scaling the analog output .....	167

## Chapter 7 CompactFlash Memory

<b>7.1 Mounting and Dismounting the CompactFlash Memory</b> .....	172
7.1.1 Mounting the CompactFlash memory .....	172
7.1.2 Dismounting the CompactFlash memory .....	172
<b>7.2 Reading of Data to a Personal Computer</b> .....	173
<b>7.3 How to Use CompactFlash Memory</b> .....	174
7.3.1 Parameter descriptions .....	174
7.3.2 Saving the setting in CompactFlash memory .....	175

## Chapter 8 RS-232C Interface

<b>8.1 Overview</b> .....	180
8.1.1 Specifications .....	180
<b>8.2 Connection</b> .....	181
<b>8.3 Commands and Data Formats</b> .....	182
8.3.1 Commands in PROGRAM mode .....	182
8.3.2 Commands for CompactFlash memory .....	187
8.3.3 Commands in RUN mode .....	188
8.3.4 Output data format .....	189
8.3.5 Command list .....	193
8.3.6 Applications of RS-232C communication setting .....	194

## Chapter 9 Specifications

<b>9.1 Specifications</b> .....	196
<b>9.2 Dimensions</b> .....	198

## Appendices

<b>Appendix A General Troubleshooting</b> .....	206
<b>Appendix B Optional Parts List</b> .....	208
<b>Appendix C Index</b> .....	210
<b>Appendix D Sample Sheets for Setup Menu</b> .....	213
<b>Appendix E Sample Sheets for Testing</b> .....	215

## WARRANTIES

<b>WARRANTIES AND DISCLAIMERS</b> .....	217
---	-----



# Menu Hierarchy

The following is the layered structure of the menu of the CV-701(P)/751(P). Parameters vary slightly depending on the measurement.

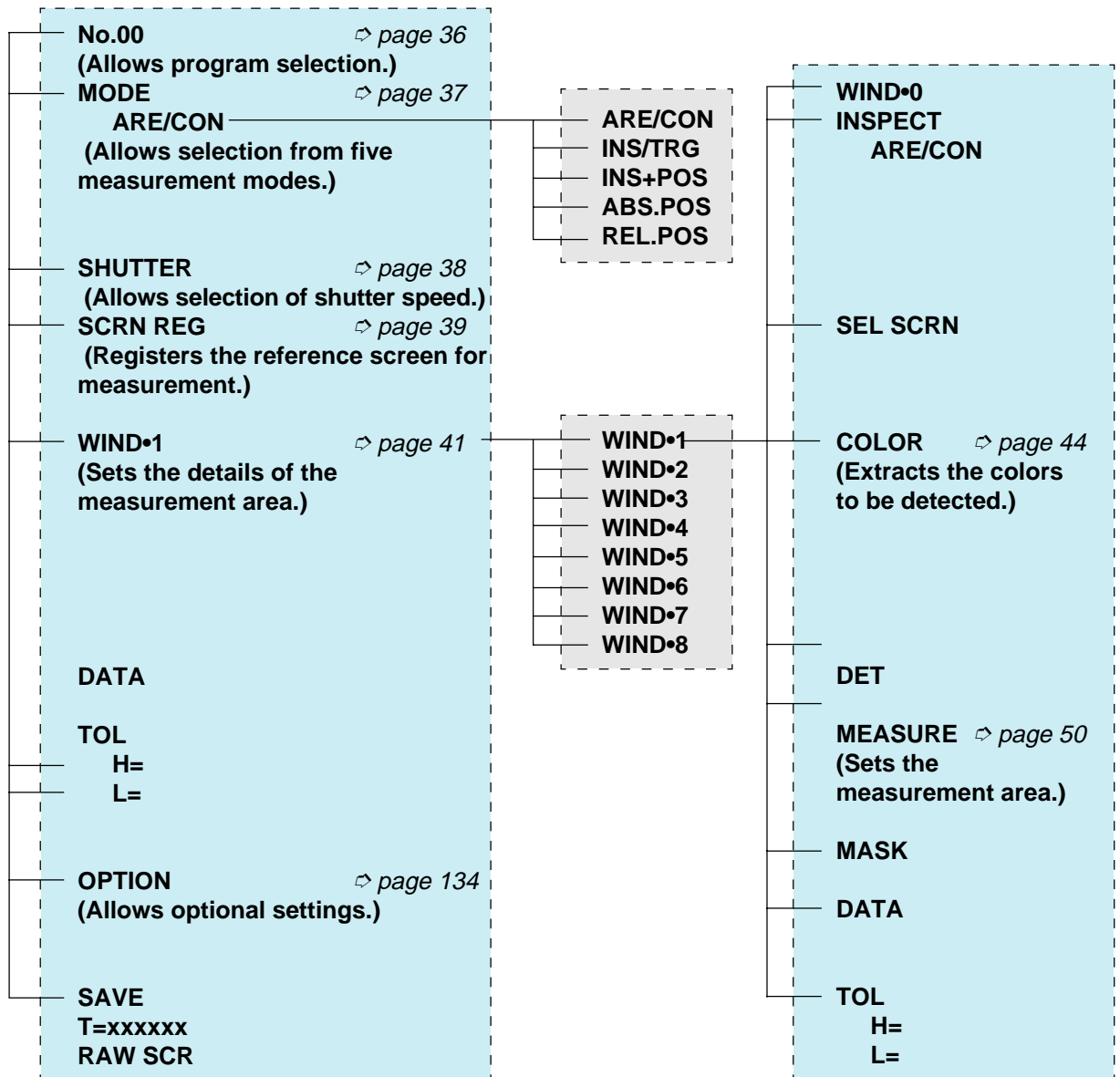

## Special Features

### Implements the highest detection power possible with the KEYENCE pioneered “Color gradation processing” (Patent pending).

- **Reliably detects only the designated colors.**

Enables the reliable extraction of targets that are hard to differentiate with conventional monochromatic processing. (e.g. differentiation of yellow on white, dark blue from black, and gold plate from silver plate, etc.)

A change of background colors does not require a change of settings, because the CV-701(P)/751(P) detects the registered colors exclusively.

- **Shadows on the target surface do not cause malfunctions.**

Detection is unstable with conventional monochromatic processing, which detects the brightness of the target, because it is affected by shadows given by the shape of the targets and by the varied illumination distributions. Color concentration processing enhances stability dramatically because detection is based on the color differences.

#### ■ Operating principals

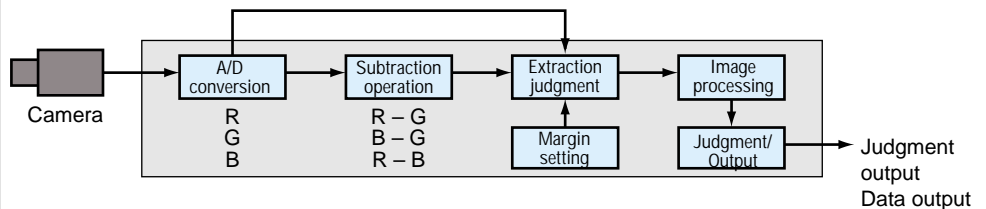

The CV-701(P)/751(P) converts the color signal of the image captured by the camera into R/G/B/ digital data using an A/D converting circuit.

It obtains the data of R-G, G-B, R-B based on the converted digital data. The measurement area for the color extraction is set based on six parameters. The [AREA] mode (color binary conversion processing) operates detection by judging whether the measured values are within or outside the color extraction area. The colors within the color extraction area are of the maximum gradation level (255 levels of gray) with color concentration processing.

The CV-701(P)/751(P) operates gray processing by converting the color data into a monochromatic image so that the level is reduced as the color falls outside the area.

This processing method realizes stable detection for colors with different values but with the same hue, and for colors without a hue such as white, black, and gray.

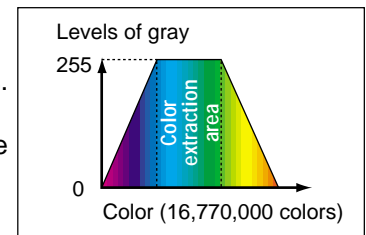

### Simple operation for highly sophisticated image processing functions. Saves boot-up time dramatically.

- **Simple “click extraction”:** Simply place and click the cursor on the color area to be detected to set the colors for extraction. No complicated parameter settings are necessary.

Setting is simple enough for first-time use for sophisticated image processing.

### Loaded with special features

- **The screen-saving function allows you to go back and check a former detection screen.**
- **The CompactFlash memory comes standard with the CV-701(P)/751(P). Back up of the detection hysteresis and multiple programs, and copying between controllers can be operated easily without using a personal computer.**
- **The measurement result can be output in analog voltage (0 to 4 V).**

# Chapter 1

---

## Overview

This section describes the package contents check and the features and applications of the CV-701(P)/751(P).

<b>1.1</b>	<b>Checking the Package Contents</b>	2
<b>1.2</b>	<b>Part Names and Functions</b>	3
1.2.1	Part Names and functions of a basic system	3

# 1.1 Checking the Package Contents



1

The CV-701(P)/751(P) packages include the following parts and equipment. Check that all parts and equipment are included in the packages.

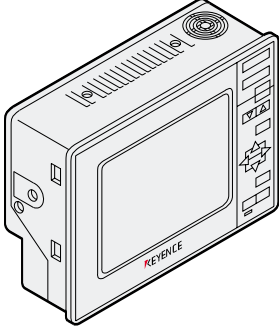
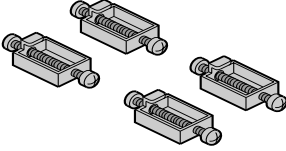
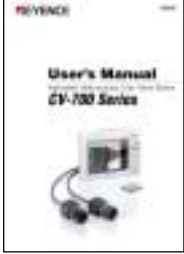
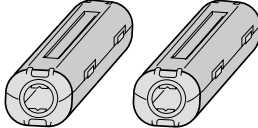



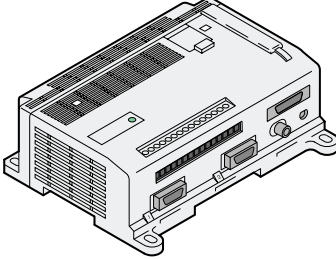
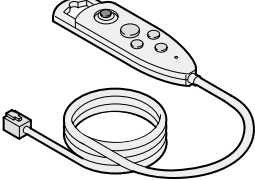

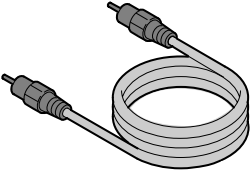
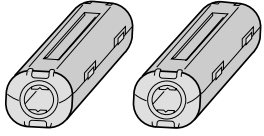
### ■ CV-751(P)

<p>Controller (CV-751(P)): 1</p> 	<p>Panel-mounting brackets: 4</p> 	<p>Users' manual: 1</p> 
	<p>Ferrite cores: 2</p> 	

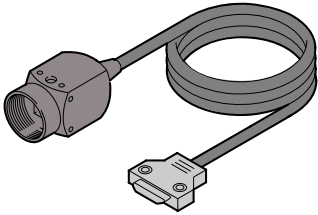
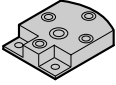
### ■ CV-701(P)

<p>Controller (CV-701(P)): 1</p> 	<p>Remote control console: 1</p> 	<p>Users' manual: 1</p> 
	<p>Monitor cable (RCA-RCA): 1</p> 	<p>Ferrite cores: 2</p> 

### ■ CV-070

<p>Camera (CV-070): 1</p> 	<p>Plastic fitting: 1</p> 	<p>Mounting bracket: 1</p> 
	<p>M3 x 6 screws (2)</p> 	
	<p>Washer (2)</p> 	
	<p>M3 x 6 plastic screws (2)</p> 	
	<p>Plastic washer (2)</p> 	

## 1.2 Part Names and Functions

This section describes the part names and functions of the CV-701(P)/751(P) and an example of a complete system.

### 1.2.1 Part Names and functions of a basic system

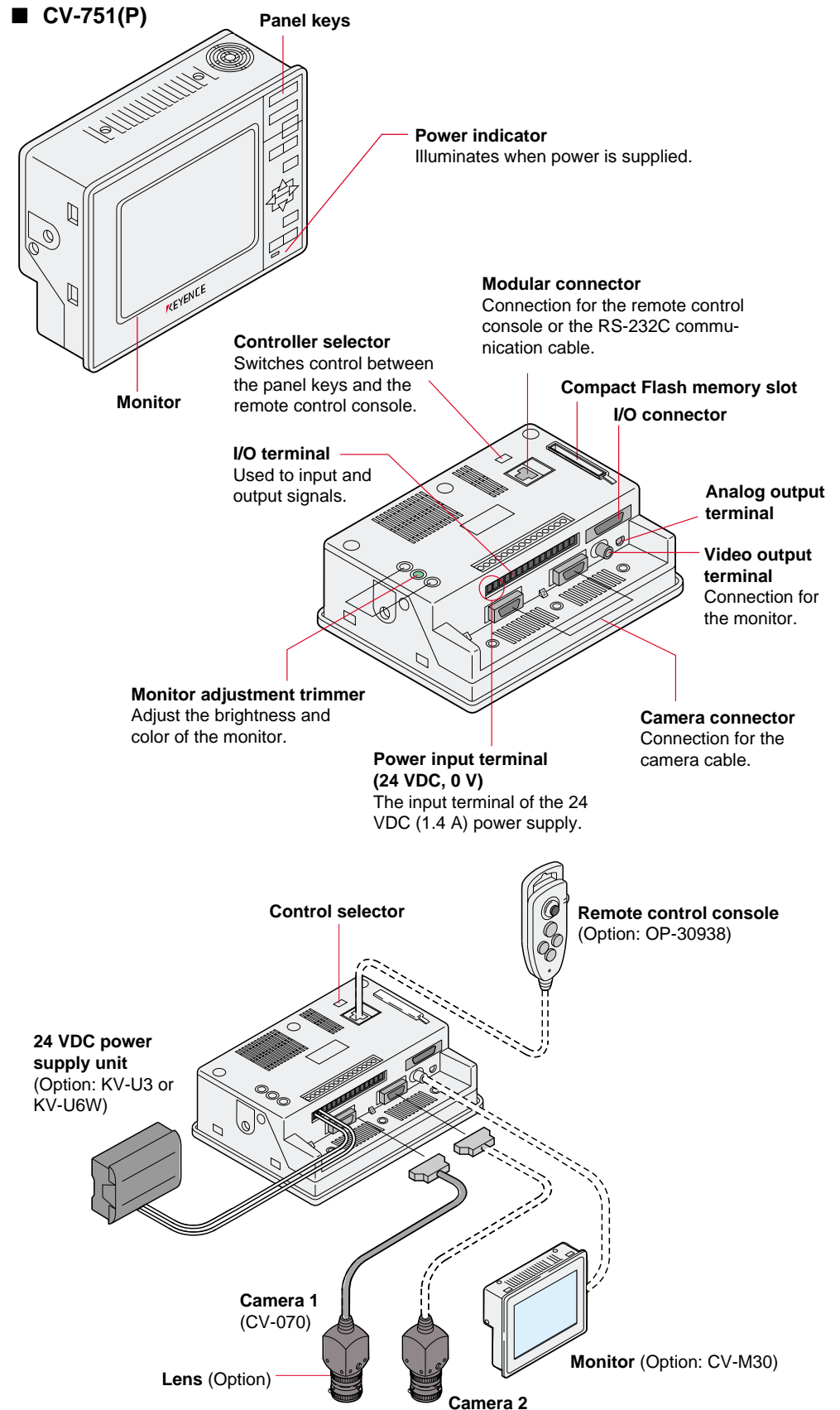

■ CV-701(P)

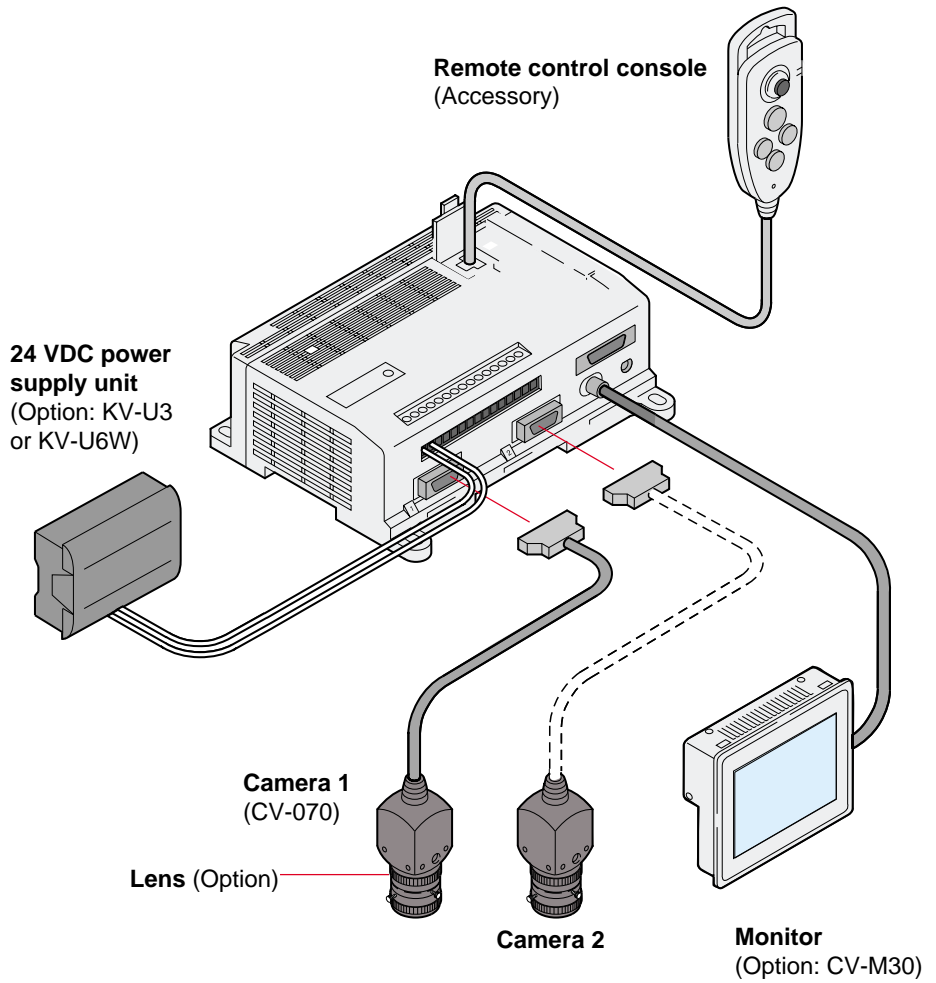
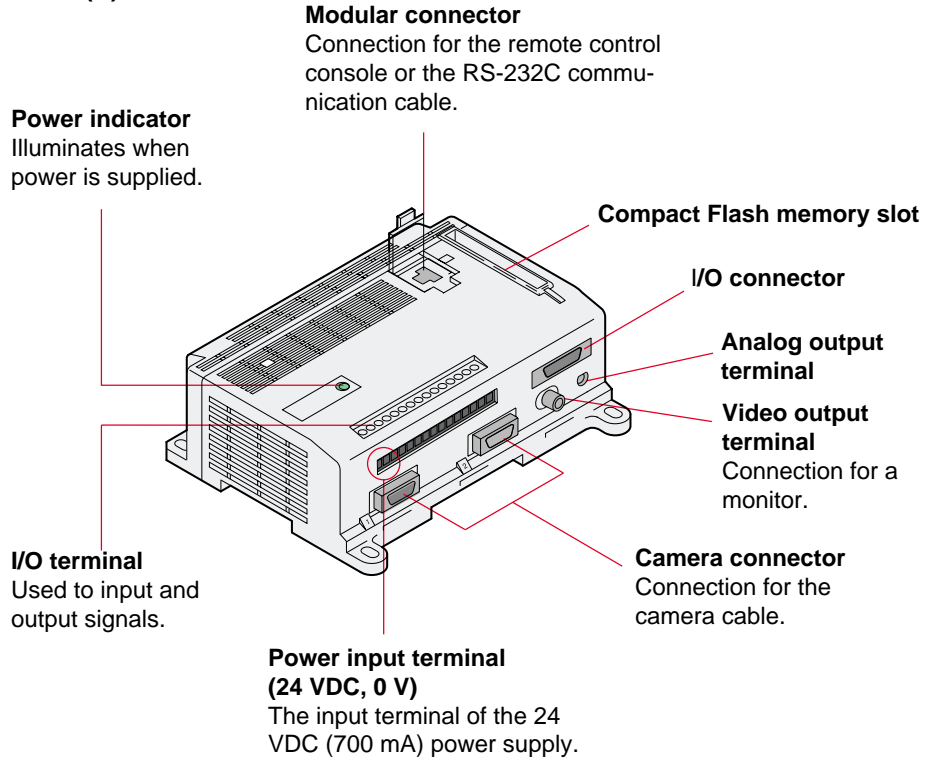

# Chapter 2

---

## Preparation

This section describes how to connect and mount the CV-701(P)/751(P), how to select a lens, and gives information about illumination.

<b>2.1</b>	<b>Mounting and Connection</b> .....	6
2.1.1	Mounting the controller .....	6
2.1.2	Mounting the camera .....	8
2.1.3	Selecting a lens .....	9
2.1.4	Cable connection and wiring .....	11
2.1.5	Checking the connection .....	13
<b>2.2</b>	<b>Illumination</b> .....	15

## 2.1 Mounting and Connection

This section describes how to mount the controller and camera, connect cables, and select a lens.

### 2.1.1 Mounting the controller

#### CV-751(P) (Built-in-monitor type)

##### ■ Panel mounting

1. Insert the controller from the front side of the panel.
2. Attach the resin caps to the mounting brackets.
3. Fit the mounting brackets into the four mounting slots on the side of the controller. Tighten the screws with a Philips screwdriver.

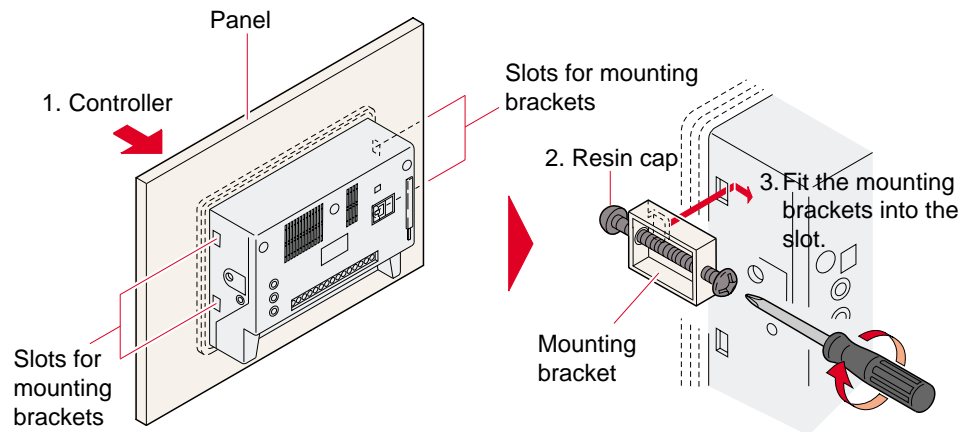

**CAUTION**

*Excessive tightening of the mounting bracket screw may deform the controller housing. Limit the tightening torque to a maximum of 0.4 N•m.*

##### ■ Mounting to the stand (Option: OP-35481)

Contents: Stand: 1, M4 x / 8 screw (3)

1. Fix the stand to a panel with two M6 screws.
2. Insert the controller into the stand.
3. Fix the controller to the stand from both sides with the two supplied M4 screws.

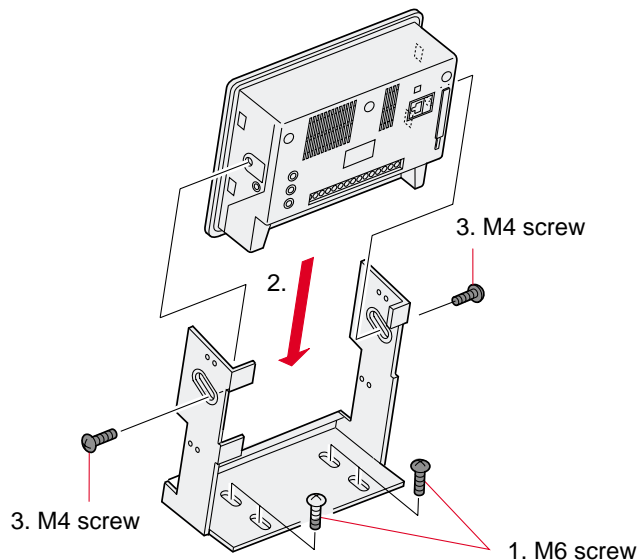



- Fix the controller with the supplied M4 screw as required.

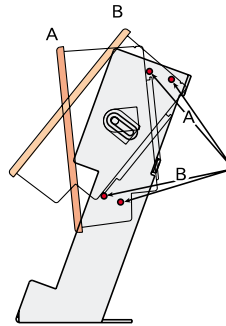

Fix the controller with the supplied M4 screw according to the desired angle.



- **Do not place the controller upside down.**
- **Do not block the ventilation slots. High temperature inside the controller may cause malfunctions.**

## CV-701(P)

### ■ DIN rail mounting

The controller is designed to be mounted to a DIN rail. To mount or dismount the controller, move the claw at the bottom of the controller in the direction of the arrow.

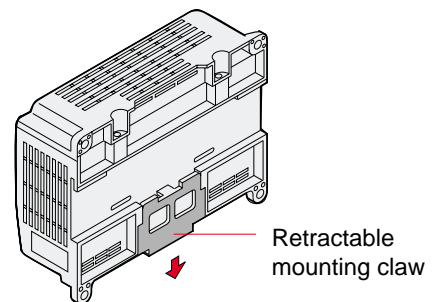

### ■ Screw mounting

Mount the controller using four M4 screws for the four holes on the controller.

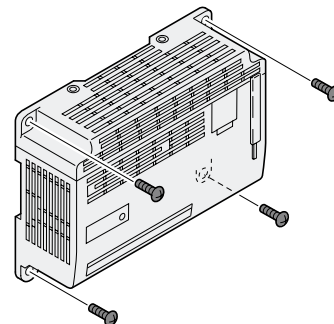

### ■ Mounting position

- Mount the controller with the front facing the operator, facing up, or vertically with the front facing the operator.

Horizontally with front facing the operator:

Correct

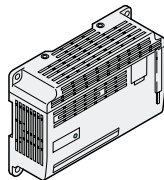

With front facing up:

Correct

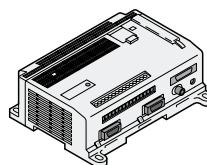

Vertically with front facing the operator:

Correct

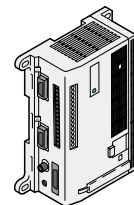

Upside down with front facing the operator:

Incorrect

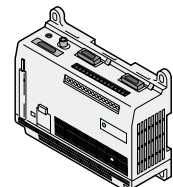

- Allow sufficient space (approx. 30 mm) for ventilation around the controller.



- **Do not place the controller upside down.**
- **Do not block the ventilation slots. High temperature inside the controller may cause malfunctions.**

## 2.1.2 Mounting the camera

### 1. Mount a lens to the camera.

Select a lens based on the target size and the distance between the lens and the target. ↪ See the next page.

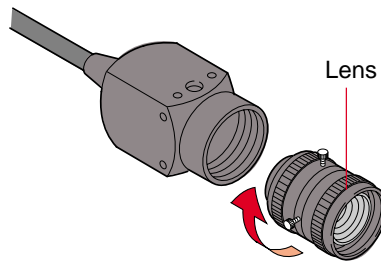

### 2. Secure the camera.

Secure the camera using the supplied screws and plastic fitting.

The plastic fitting has three screw holes;  
1. Screw holes for tripod (1/4-20 UNC),  
2. M3 screw holes, 3. M4 screw holes.  
Use the appropriate ones to secure the camera.

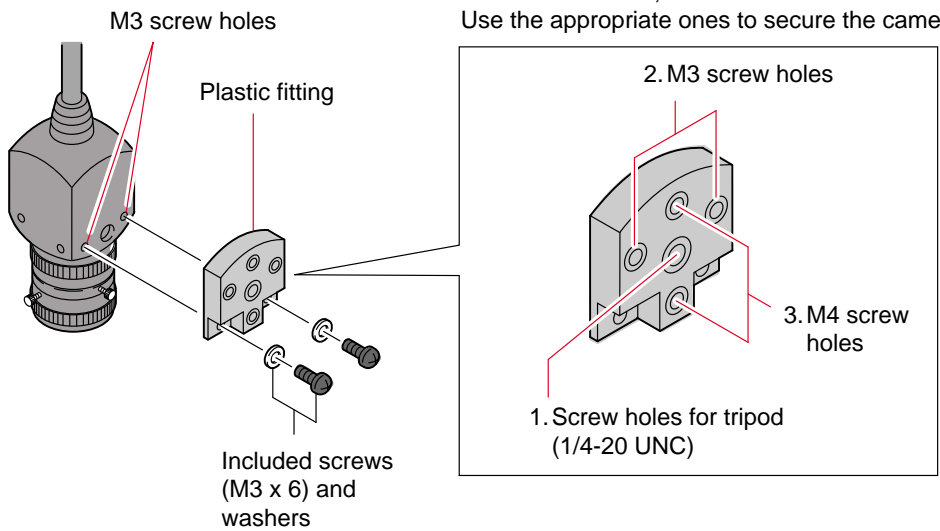

**Provide insulation upon mounting. Otherwise, the camera may suffer internal damage.**

### 2.1.3 Selecting a lens

Select a lens based on the target distance (field of view: Y) and the distance between the lens and the target (working distance). Refer to the chart below to select the lens best suited for your application.

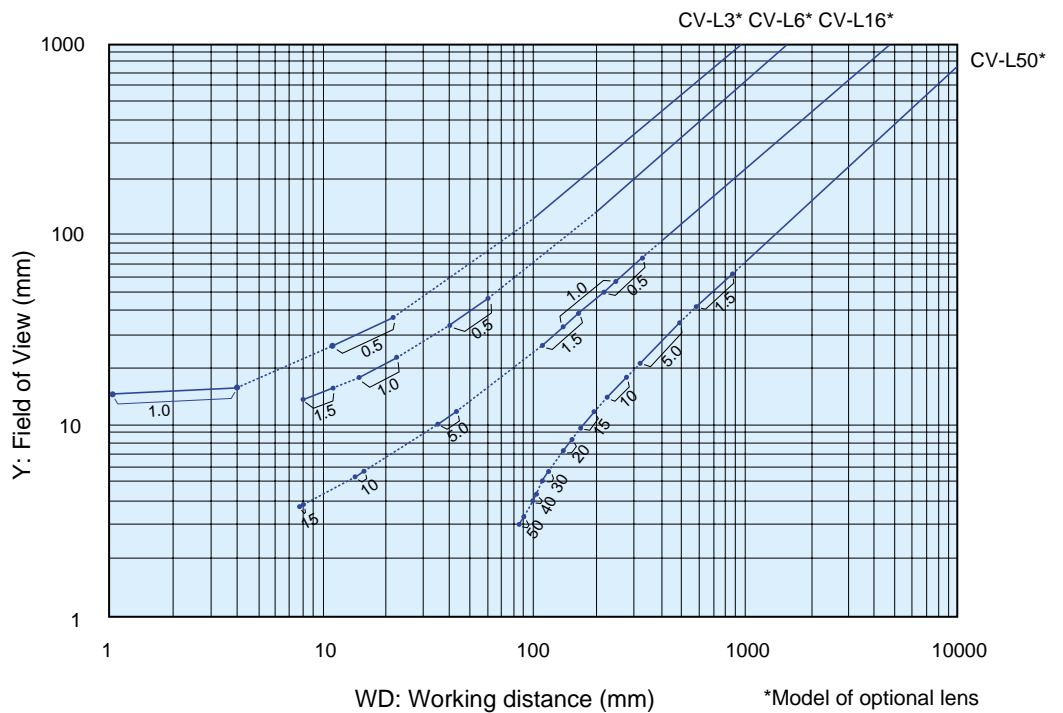
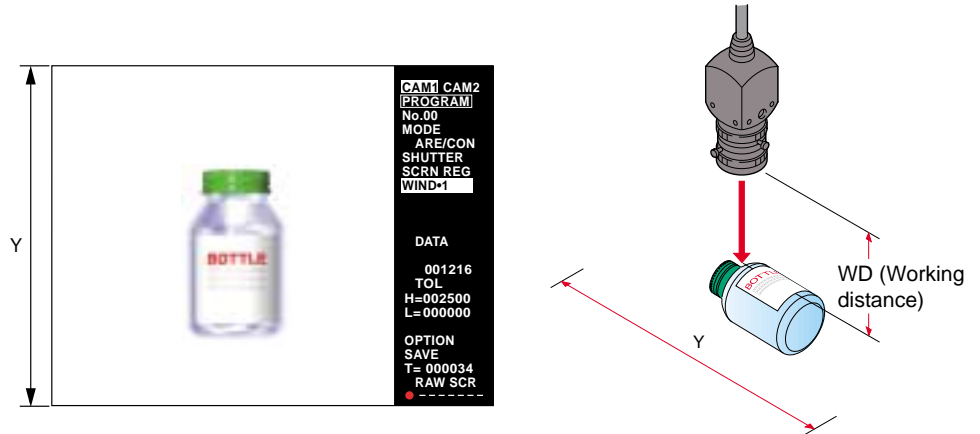

- The line between the dots (●-●) indicates the range provided by a close-up adapter. The close-up adapter is placed between the lens and the camera.

#### ■ How to read the chart

Using the CV-L16 with a working distance of 400 mm provides a field of view of approximately 90 mm. Combining the CV-L50 with a 5 mm close-up adapter provides a field of view of approximately 30 mm. The values in the chart serve as a guide. Adjustment may be necessary upon mounting.

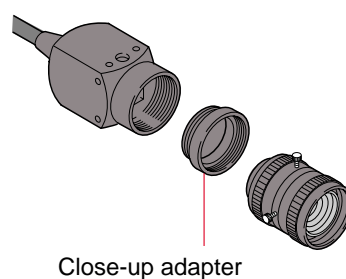

**Note:** When an external monitor is connected, some monitors may not show the frame of the screen. Although this does not affect measurement, use an under-scanning type monitor if you need to see right to the corners of the screen.



Over-scanning type monitor



Under-scanning type monitor

## 2.1.4 Cable connection and wiring



**CAUTION**

- *Be sure to turn off the controller before connecting the cables. If you connect the cables while the controller is turned on, the camera or peripheral device may be damaged.*
- *The CV-701(P)/751(P) conforms to CE regulations in Europe; however, please make sure to keep the wiring for the power and the I/O within 30 m. Otherwise, it will not conform to EN61326-1.*

### 1. Insert the connector for the camera cable.

When using only 1 camera, insert the connector for camera one into the camera 1 slot only.

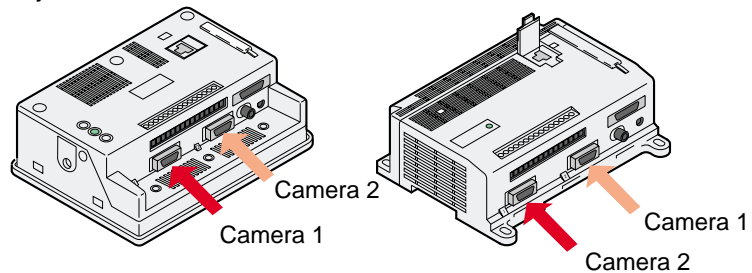

### 2. Insert the modular connector for the remote control console cable.

With the CV-751(P), insert the modular connector only when using the optional remote control console. When using the console, slide the control selector to the right.

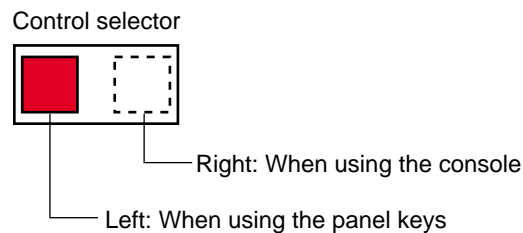

### 3. Insert the video output terminal (RCA connector) for the monitor cable.

With the CV-751(P), insert the RCA connector only when using an external monitor.

### 4. Connect the cable for the power supply unit.

- Connect the cable for the 24 VDC power supply unit to the controller's input/output terminals 1 and 2.
- Use a Philips screwdriver to connect the cable to the terminal. Do not turn on the power until the mounting procedure is complete.

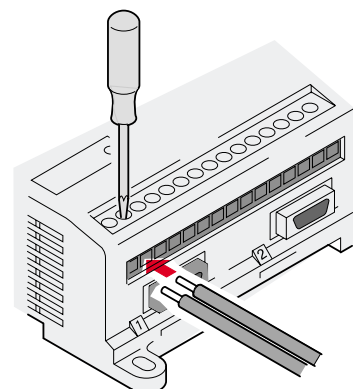
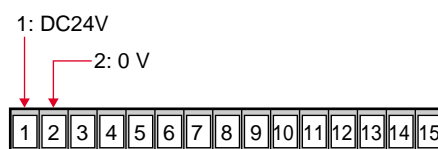

■ CV-751(P)

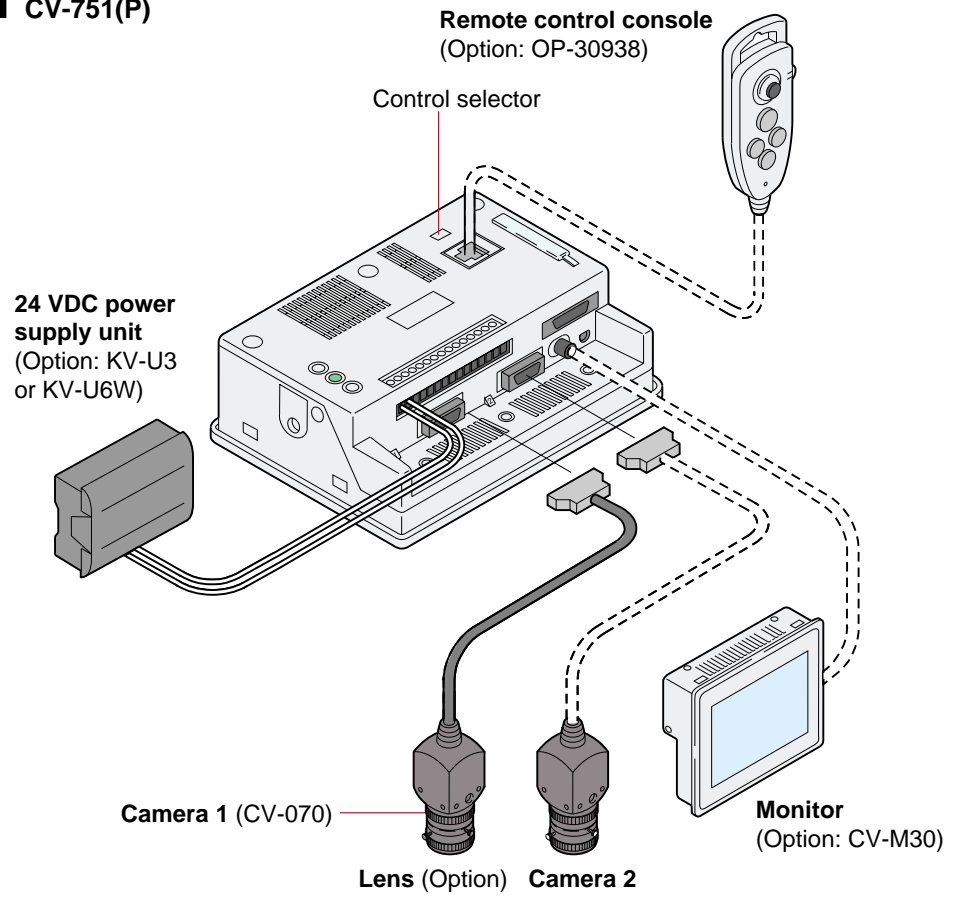

■ CV-701(P)

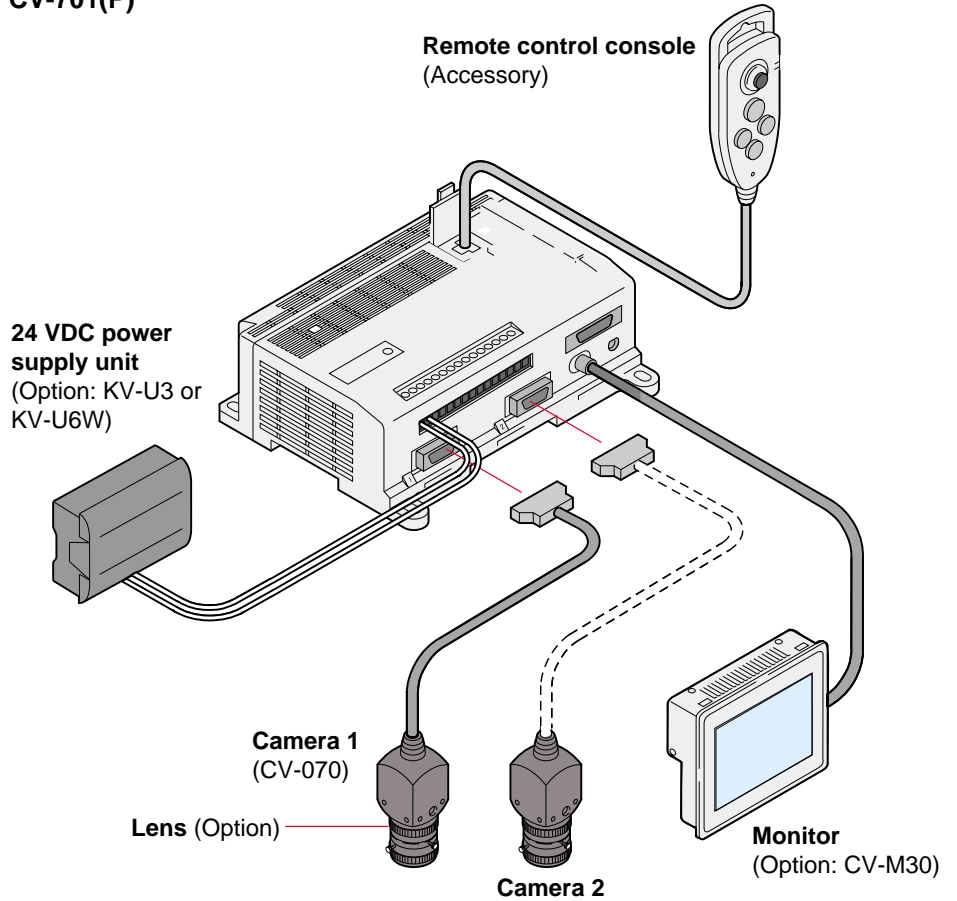

## 2.1.5 Checking the connection

### 1. Turn on the power.

Turn on the connected 24 VDC power supply.

### 2. Check the monitor.

- A raw (unprocessed) screen is displayed.
- When two cameras are connected, the image from camera 1 is displayed.
- ◊ See page 42 to display the image from camera 2.



- \* A raw screen is a screen that is seen through the camera without any processing.

### 3. Adjust the diaphragm and focus of the lens.

- 1) Turn the diaphragm ring and focus ring to adjust the diaphragm and focus while watching the monitor.
- 2) After the adjustment is complete, secure the lock screws to lock the rings.

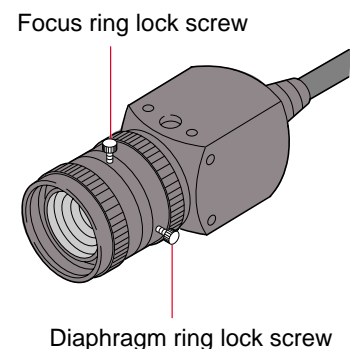

#### ● Diaphragm adjustment

Adjust the diaphragm so that the target can be easily distinguished from the background.

#### ● Focus adjustment

Adjust the focus until the target contour becomes clear.

#### Note: Check the following items if nothing appears on the monitor.

- Is the proper type of 24 VDC power supply (CV-751(P): 1.4 A, CV-701(P): 700 mA) used? Are the “+24 V” and “0 V” power supply terminals properly connected?
- Is the camera cable properly connected?
- Are the cables for the remote control console and monitor properly connected? (with the CV-701(P) only)
- Is the lens cap removed?
- Is the lens diaphragm opened wide enough?
- Is the monitor turned on?
- Is the video input terminal for the monitor properly connected?

#### 4. Adjust the monitor. (with the CV-751(P) only)

The monitor for the CV-751(P) is factory-adjusted so that adjustment is unnecessary under normal conditions. If you need to make adjustments due to ambient light or the viewing angle, follow the procedure below.

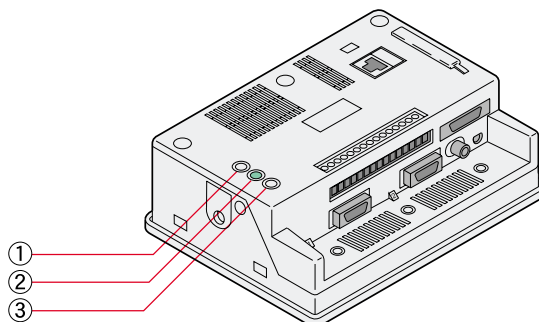

\* The initial setting is for setting all trimmers to the middle position.

1) Adjust the color depth using the COLOR adjustment trimmer.

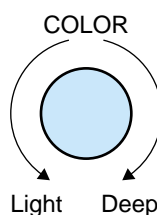

2) Adjust the hue using the HUE adjustment trimmer.

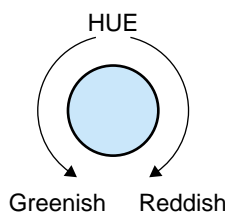

3) Adjust the brightness using the BRIGHT adjustment trimmer.

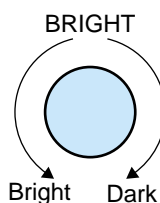

#### 5. Adjust the time and date.

The CV-701(P)/751(P) comes standard with a built-in clock function. The time and date on the clock are used when writing the data on the CompactFlash memory, etc.

Adjust the time and date using the [CLOCK] on the configuration menu.

☞ See page 149.

**Note 1:** The secondary battery for backing up the clock function is not factory-charged.

The battery can be fully charged by applying power to the controller for 24 hours.

**Note 2:** With the power off, the time between battery recharges is approximately two months (at a temperature of 25 °C (77°F)). When it becomes low in capacity, the date and time are reset to the initial setting. (00 YEAR 01 MON 01 DAY 00 MIN 00 SEC)



## 2.2 Illumination

Use illumination for more stable detection.

If you install the CV-701(P)/751(P) in a location with the following conditions, detection may not be accurate. Change the location or use the specially designed illuminator.

- Locations directly exposed to sunlight
- Locations in which the ambient light varies greatly depending on the time of day
- Locations in which the illumination level changes according to the movement of a machine or people

### Illuminator

#### ■ Ring lamp

Mount the ring lamp around the lens to illuminate the target evenly. The ring lamp is available as an option. (CV-R11)

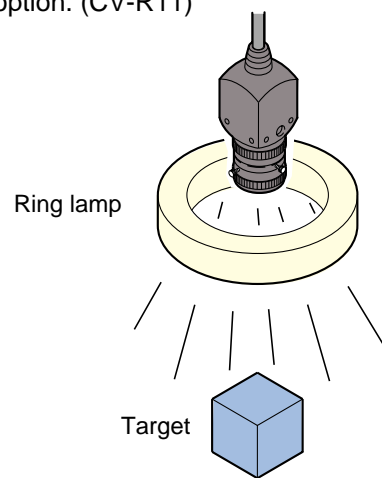

---

**Note:** The illumination lamp has a recommended service life. When the light intensity changes, detection errors may result. Replace the lamp before this problem occurs.

---

### White balance

Adjust the white balance when discoloration occurs in the target image after the lens and illumination are adjusted.

◇ See page 148.

## MEMO

2

# Chapter 3

---

## Mode Selection

The CV-701(P)/751(P) features five measurement methods called “measurement modes”.

This section describes the functions and applications of each mode. A list of applications and modes is provided to help simple mode selection.

<b>3.1</b>	<b>Measurement Modes and Typical Applications</b>	18
3.1.1	“ARE/CON” (Area continuous)	18
3.1.2	“INS/TRG” (Inspection trigger)	19
3.1.3	“INS+POS” (Inspection position)	22
3.1.4	“ABS.POS” (Absolute position)	23
3.1.5	“REL.POS” Mode	25
<b>3.2</b>	<b>Selecting the Measurement Mode by Application</b>	27

## 3.1 Measurement Modes and Typical Applications

The CV-701(P)/751(P) features five measurement modes: "ARE/CON" (Area continuous), "INS/TRG" (Inspection trigger), "INS+POS" (Inspection + position), "ABS.POS" (Absolute position), and "REL.POS" (Relative position). This section gives an overview and describes the typical application of each mode.

### 3.1.1 "ARE/CON" (Area continuous)

Use "ARE/CON" mode to continuously measure the area in the window for selected color data.

⇒ See "4.4 "AREA" Mode Basic Settings" on page 57 for the setting procedure.

3

#### Functions

- Extracts the selected color data of the window.
- Sets a window and measures the area of the selected color data and the background color of the window.
- Up to eight windows can be drawn for a single program. The measured data and detection result for each window are output sequentially.

Sample: Detection for the number of pixels

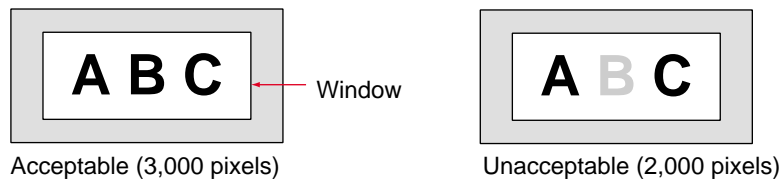

#### Typical applications

Use the "AREA" mode for detection of the presence or absence of a target, a missing target, and for the shape or area of a target.

##### Detecting a chip on building plywood

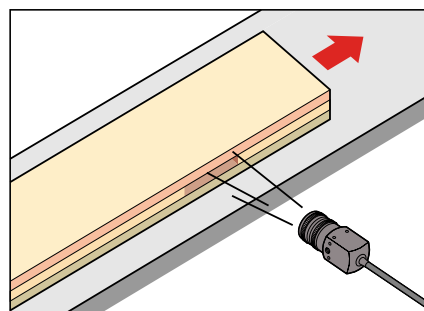

##### Checking the application quantity of the magnetic substance on magnetic films

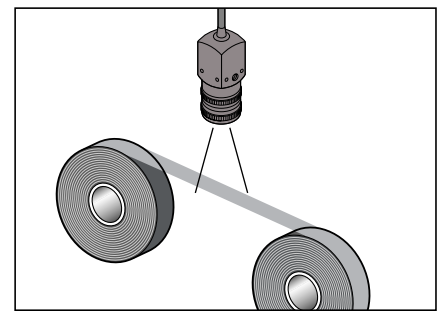

##### Detecting uneven coating on an optical disk surface

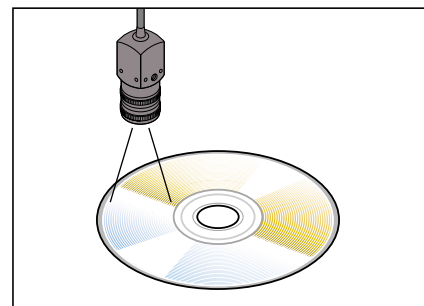

##### Detecting uneven curtain coating in the resist process of a PC board

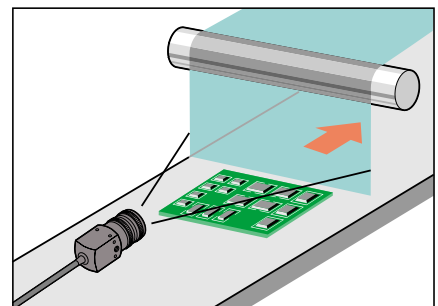

**Tips****Basic Unit of Area: “Pixel”**

The sensing element CCD of the camera forms a square grid pattern, and each minute area corresponds with a pixel. Each pixel recognizes R, G, and B as a 256-level brightness signal.

“AREA” mode allows you to set a window on a desired part of an image on the monitor screen and count the number of pixels matching the selected color data. You can detect the area of a target, whether it is small or large, and the presence or absence of a target.

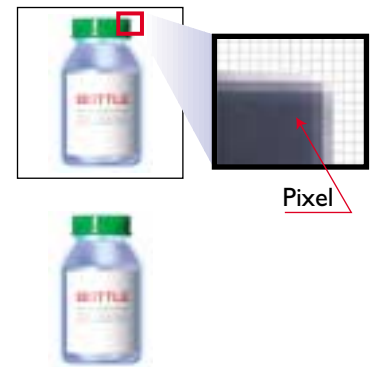

### 3.1.2 “INS/TRG” (Inspection trigger)

Use “INS/TRG” mode to measure the selected color data in the window at every trigger input.

⇒ See “4.6 “INS” Mode Basic Settings” on page 70 for setting procedure.

## Functions

- Selects the measurement parameter by the inspection mode.
- The following ten inspection mode types can be selected from the inspection mode.
- Setting an inspection mode for each window allows for multiple detections with one target.

### AREA

Detects the presence or absence of a target, whether it is small or large, a missing target, and the area of a target as with “ARE/CON” mode.

### OUTER (Outer edge)

Measures the distance between the outermost edges in the window.

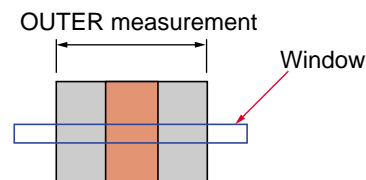

### INNER (Inner edge)

Measures the distance between the innermost edges in the window.

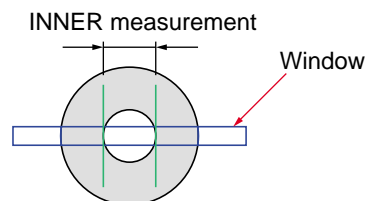

### GAP

Measures the distance between the odd-numbered edges and the even-numbered edges counted from the left (in horizontal scanning) or top (in vertical scanning) of the window. The maximum, minimum, and average values can be obtained.

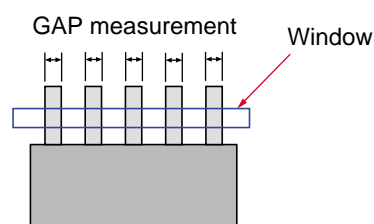

**PITCH**

Measures the pitch values to obtain the maximum, minimum, and average values.

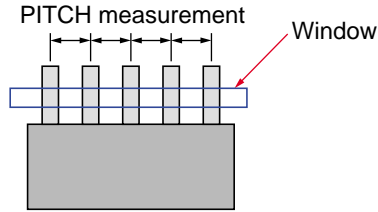

**EDGE NO (Edge count)**

Use this mode to count the number of pins.

Counts the number of edges in the window. (Specify the edge with [WH → BL] or [BL → WH].)

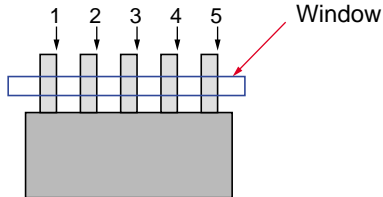

**COUNT**

Counts the number of clusters of extracted colors in the window. Up to 256 clusters can be counted.

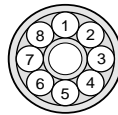

**POINT (Point sensor)**

Detects the presence or absence of the extracted colors of the set point. Up to 8 points can be detected in a window.



**STAIN**

Use this mode to detect stains and defects. The four types that can be used for a window: square, circle, ring, and arc.



**GRAVITY**

Detects the center of gravity and the angle of principal axis (the longitudinal angle) of a target.

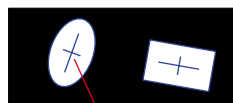

GRAVITY center

3

## Typical applications

### Detecting missing products in a packaging process

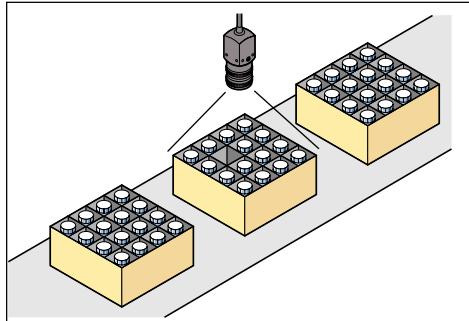

**AREA**

Determines if there are any products missing in each carton.

### Measuring paper sheet width

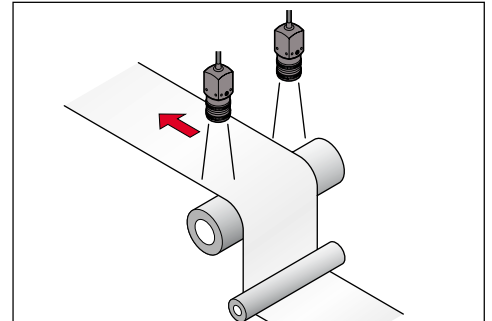

**OUTER**

Measures the width of a paper sheet with two cameras after the slitting process.

### Measuring lead pitch

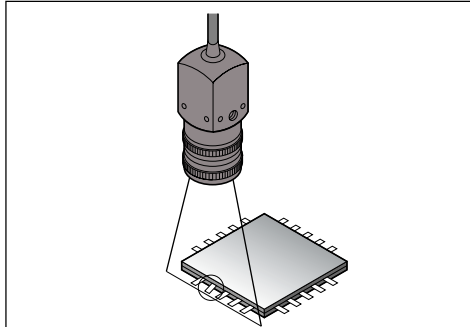

**PITCH**

Inspects the bend in IC leads.

### Detecting missing cables

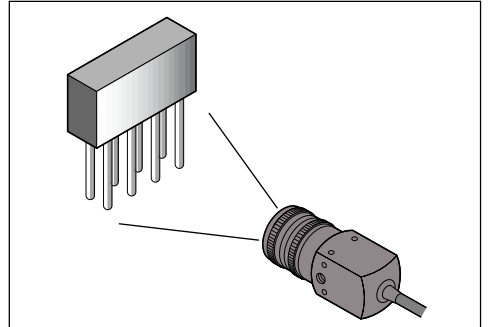

**EDGE NO**

Counts the number of cables wired to connectors.

### Detecting missing balls of bearings

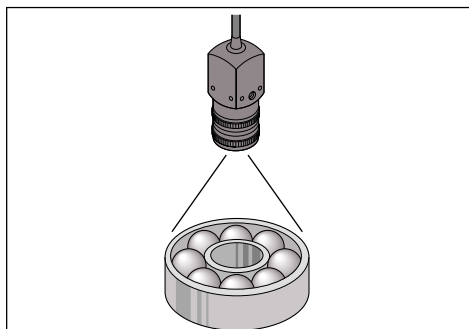

**COUNT**

Counts the number of balls to determine if any are missing.

### Lighting inspection of an LCD

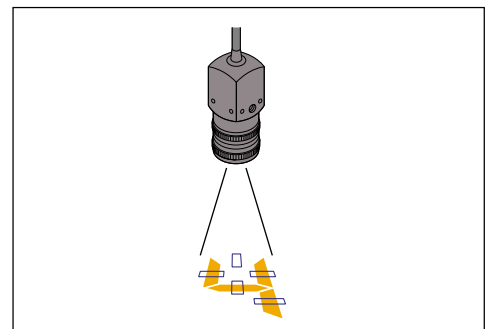

**POINT**

Inspects unlit segments of LCD displays.

**Detecting the stains or pinholes on sheet material**

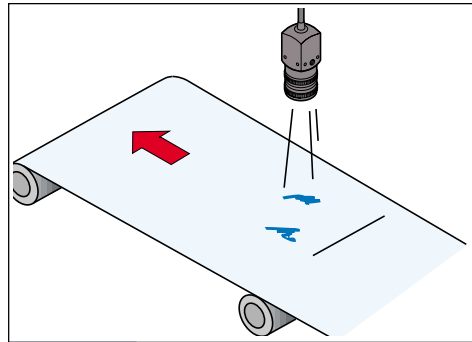

**STAIN**

Detects any stains or pinholes on sheet material.

**Detecting the center of gravity of alignment marks**

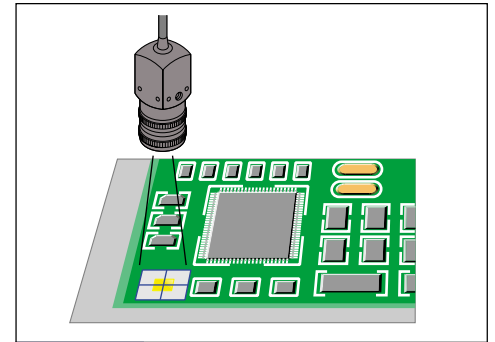

**GRAVITY**

Detects the center of gravity of alignment marks.

**Tips**

**Unit Conversion Function**

The CV-701(P)/751(P) processes an image and obtains data with the number of pixels. For example, measuring a target with an outer size of 3.25 mm may give 65.0 pixels. The unit conversion function converts the number of pixels into other units such as mm.

↪ See page 137.

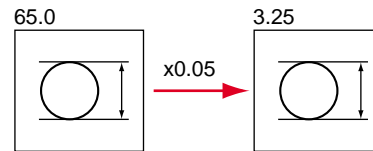

**3.1.3 “INS+POS” (Inspection + position)**

Use the “INS+POS” mode to adjust the position and angle of the window. Use this mode for trigger detection when the “INS/TRG” mode can’t be used because the position of the target is not constant.

↪ See “4.6 “INS” Mode Basic Settings” on page 70 and “4.9 “Position Detection” Mode Basic Settings” on page 109 for the setting procedure.

**Position adjustment**

Use this function when detection cannot be operated at the same position in a window because the position of a target is not constant in field operation. Using the position adjustment function allows the inspection window to adhere to the motion of targets.

The position adjustment, like the “ABS.POS” mode, uses either “pattern search” or “edge detection” to recognize the distinctive image and edge of a target. It then adjusts the inspection window to adhere to the target. This function allows the CV-701(P)/751(P) to constantly detect the same position of targets regardless of the movement of targets. Also, the rotation adjustment function allows the CV-701(P)/751(P) to automatically tilt the inspection window when the target makes a rotating movement.

**REG SCR (Registered screen)**

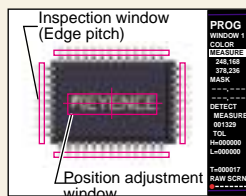

**Without position adjustment**

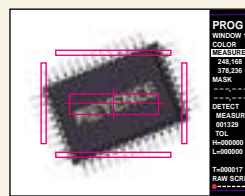

**With position adjustment**

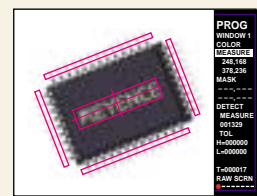



## Functions

- Inspects every trigger input.
- Inspection functions are similar to those of “INS/TRG” mode.
- The position adjustment function is the same as “ABS.POS”.

## Typical applications

Use this mode when the position of a target is not constant for applications described in the “INS/TRG” section.

⇒ See page 21.

### 3.1.4 “ABS.POS” (Absolute position)

Use the “ABS.POS” mode to detect the position and angle of the target, and judge the result with the position adjustment function.

⇒ See “4.9 “Position Detection” Mode Basic Settings” on page 109 for the setting procedures.

## Functions

- Detects the position and angle of a target.
- “Pattern search” and “edge detection” can be selected for the measurement mode.
- Detects up to four windows, which can be drawn to measure the position of four points simultaneously.
- The judgment, coordinates, angle, and correlation ratio can be output.
- The camera can be set to trigger mode only.

#### ■ Position detection method

##### Pattern Search

Register a screen as a reference that includes the position of the pattern to be searched, and save the pattern to the pattern window. The saved pattern window is searched through the arbitrary-set search window from the upper-left corner to the lower-right corner for the position of the most similar pattern.

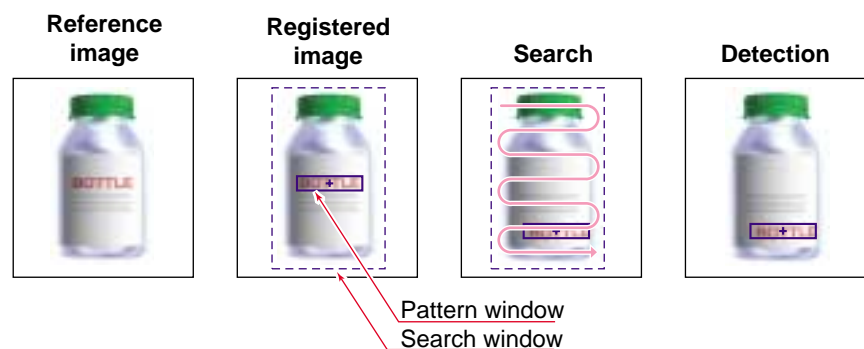

3

### Edge Detection

Register a screen as a reference that includes the position of the pattern to be searched, and register an X window and Y window as illustrated. The windows are searched for points to show a change in color to be recognized as the edge, and then the X- and Y- coordinates of the edge are detected. Position detection of the X-coordinate alone using the X window is also available.

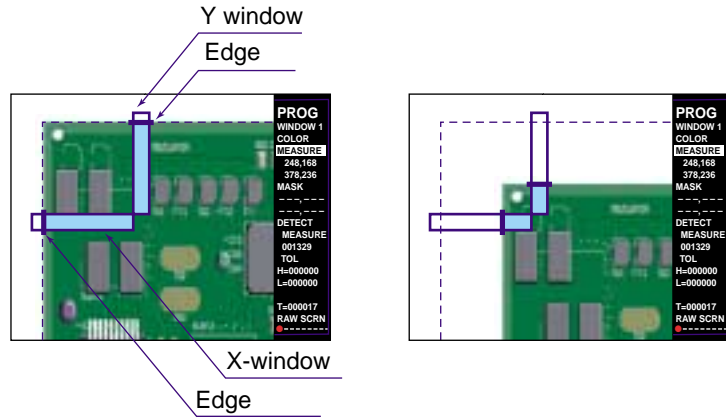

### Typical application

Detecting the misalignment of an IC chip to lead frames

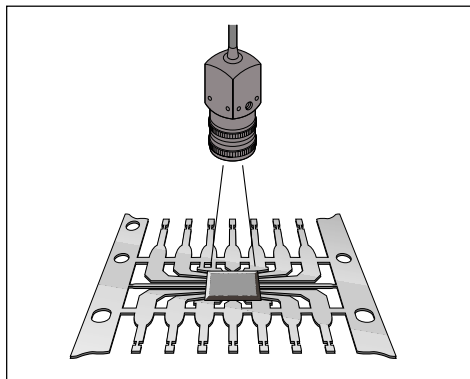

Positioning of a PC board

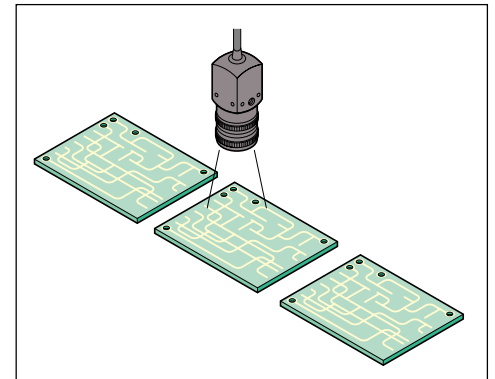

Controlling robotic handling

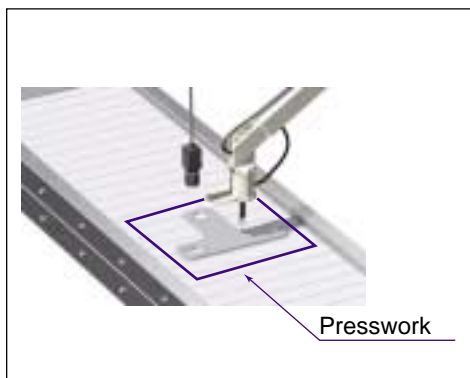

Positioning of glass substrate

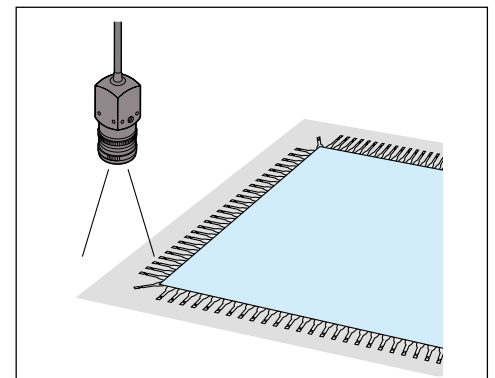

### 3.1.5 “REL.POS” Mode

Use the “REL.POS” mode to detect the position and angle of two or more targets, and judge the result with the position adjustment function.

⇒ See “4.9 “Position Detection” Mode Basic Settings” on page 109 for the setting procedures.

#### Functions

- Detects the position of two or more targets, measures the distance between the two points, and judges the result.
- “Pattern search” and “edge detection” can be selected for the measurement mode.
- The relative distance between up to three measurement windows and one reference window can be measured simultaneously.
- The positions of the search window, pattern window (when pattern search is used), and X/Y windows (when edge search is used) are adjusted (X, Y, and  $\theta$ ) according to the detection result of the reference window position.
- The judgment, coordinates, angle, and correlation ratio can be output.
- The camera can be set to trigger mode only.

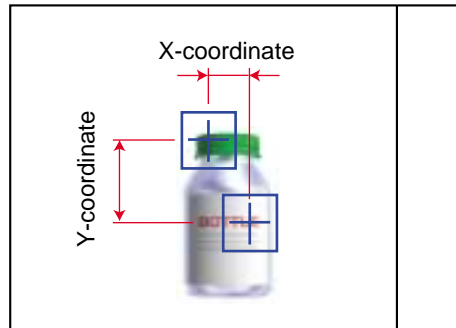

#### Typical applications

##### Detecting misaligned labels and loose caps

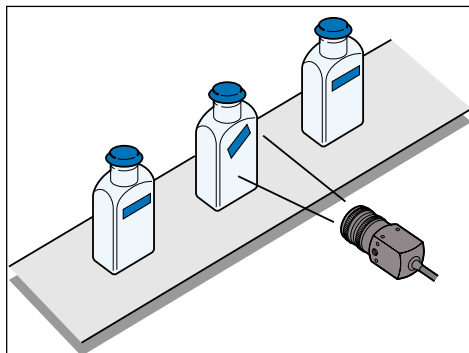

Detects simultaneously the position and angle of labels and loose caps.

##### Detecting the relative position of a PC board and IC

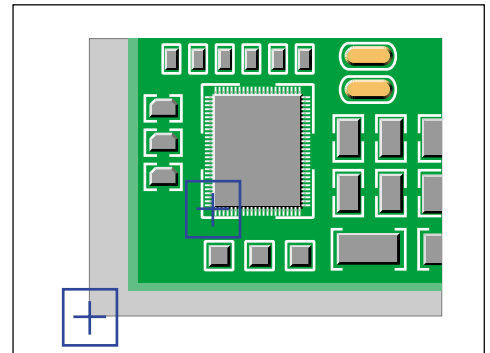

Detects the correlation between the edge of a PC board and IC

**Detecting electrodes of lithium-ion batteries**

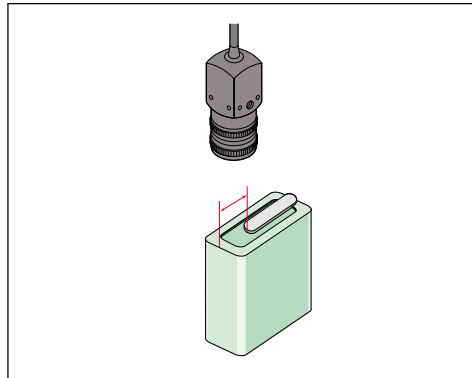

Detects the position of an electrode using the edge of the battery as the reference.

**Detecting the molding position of laminated film**

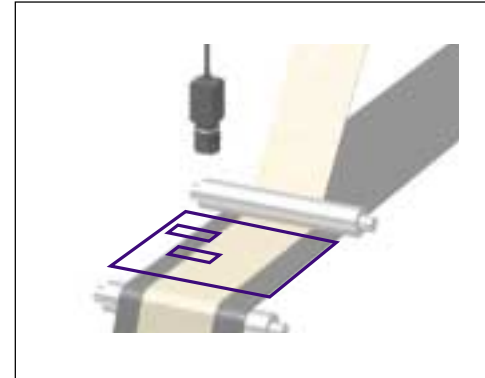

Detects the molding and width of laminated films using two X-edges.

**Tips**

Use "REL.POS" mode to measure the relative position of [REF WND] and [REL I/2/3]. Use "REF WIND" to detect the rotation angle. "WIND I/2/3" will be tilted by the amount of the angle deviation for detection.



Use [REL.POS] mode to measure the relative position of [REF WND] and [REL\_I/2/3].

## 3.2 Selecting the Measurement Mode by Application

Inspection items and checkpoints are listed below. Refer to the following chart to select the measurement mode best suited for your application.

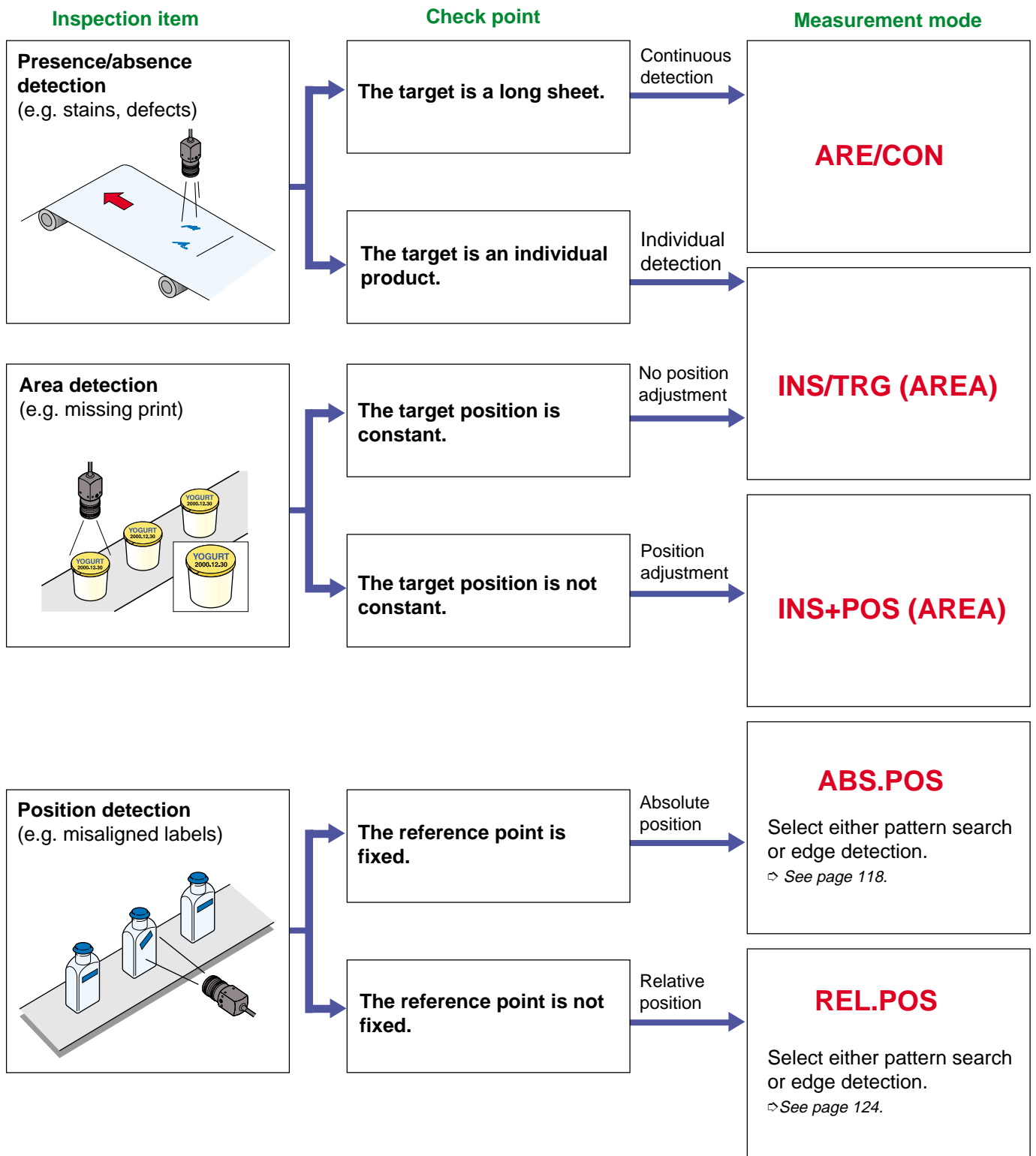

Inspection item

Check point

Measurement mode

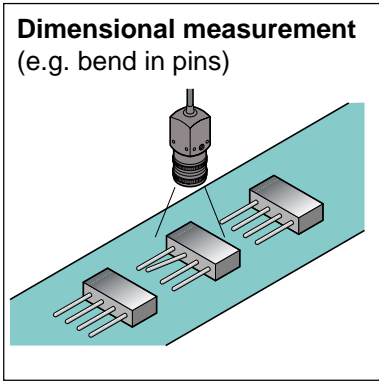

**The target position is constant.**

No position adjustment

**INS/TRG**  
Select from the following modes.  
☞ See page 70 for details.

- OUTER
- INNER
- PITCH
- GAP

**The target position is not constant.**

Position adjustment

**INS+POS**  
Select from the following modes.  
☞ See page 106 for details.

- OUTER
- INNER
- PITCH
- GAP

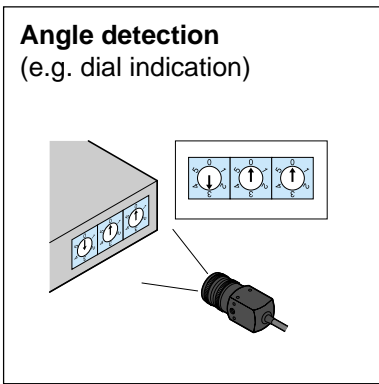

**ABS.POS**  
**(Angle adjustment)**

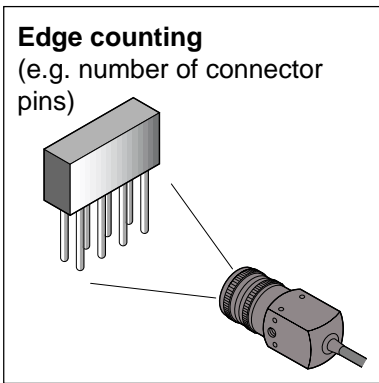

**The target position is constant.**

No position adjustment

**INS/TRG**  
**(EDGE NO)**

**The target position is not constant.**

Position adjustment

**INS+POS**  
**(EDGE NO)**

3

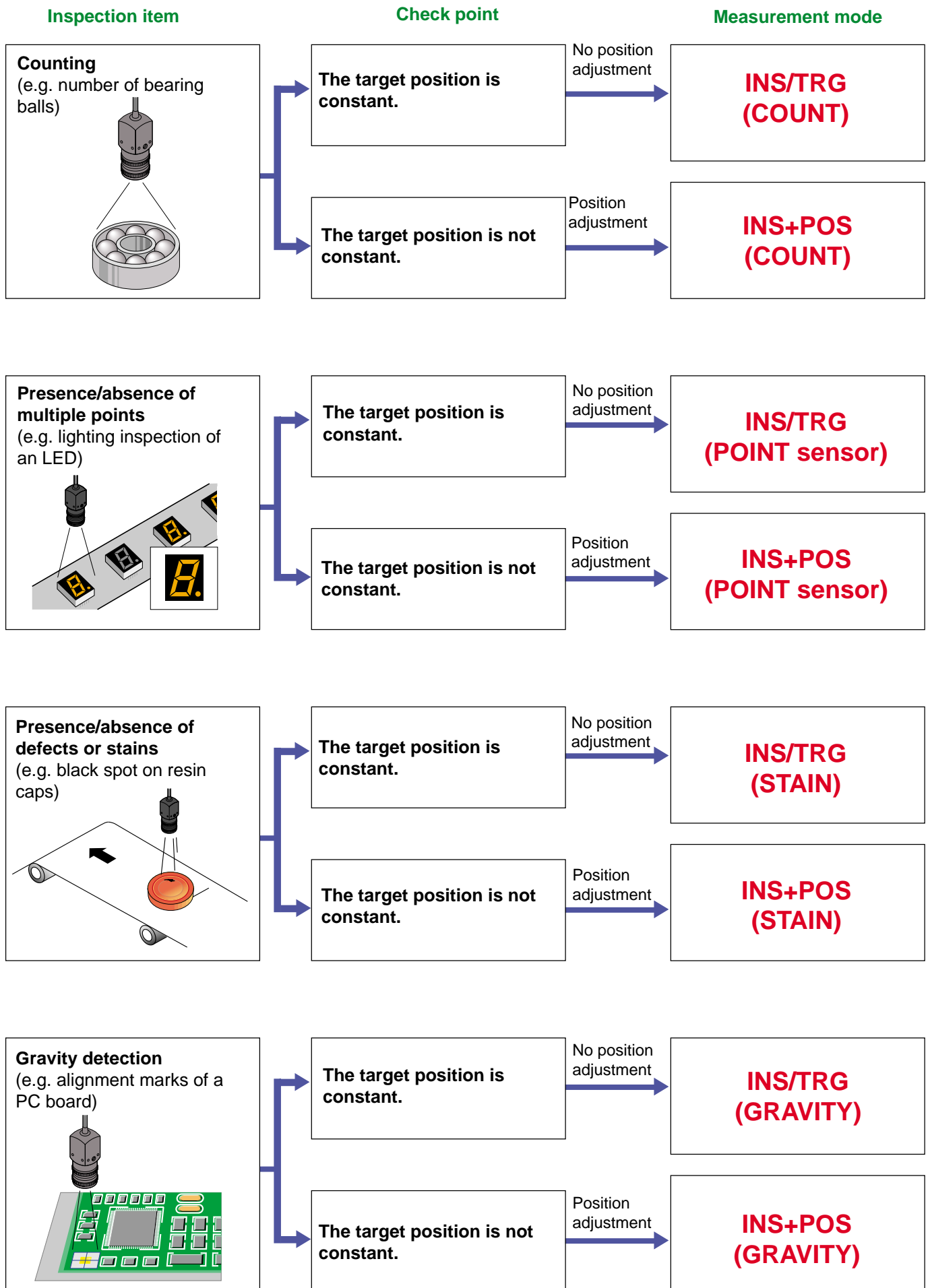

3

# MEMO

3



# Chapter 4

---

## Setting Procedure

This section describes how to use the panel keys or the remote control console to set the CV-701(P)/751(P). It covers everything from basic settings to the advanced settings.

<b>4.1</b>	<b>Names and Functions of Control Keys and Monitor Screen</b> .....	32
<b>4.2</b>	<b>Preparations</b> .....	35
<b>4.3</b>	<b>Basic Settings</b> .....	36
<b>4.4</b>	<b>“AREA” Mode Basic Settings</b> .....	57
<b>4.5</b>	<b>“AREA” Mode Advanced Settings</b> .....	65
<b>4.6</b>	<b>“INS” Mode Basic Settings</b> .....	70
<b>4.7</b>	<b>“INS” Mode Advanced Settings</b> .....	96
<b>4.8</b>	<b>“INS+POS” Mode Basic Settings</b> .....	106
<b>4.9</b>	<b>“Position Detection” Mode Basic Settings</b> .....	109
<b>4.10</b>	<b>“Position Detection” Advanced Settings</b> .....	118
<b>4.11</b>	<b>Optional Settings</b> .....	134
<b>4.12</b>	<b>Operation Check of the Setting Status</b> .....	140
<b>4.13</b>	<b>Initialization</b> .....	142
<b>4.14</b>	<b>Input/Output Operation in PROGRAM Mode</b> .....	143
<b>4.15</b>	<b>Environmental Settings</b> .....	144

## 4.1 Names and Functions of Control Keys and Monitor Screen

Set each parameter using the panel keys or the remote control console.

### 4.1.1 Controller

#### Panel keys (CV-751(P))

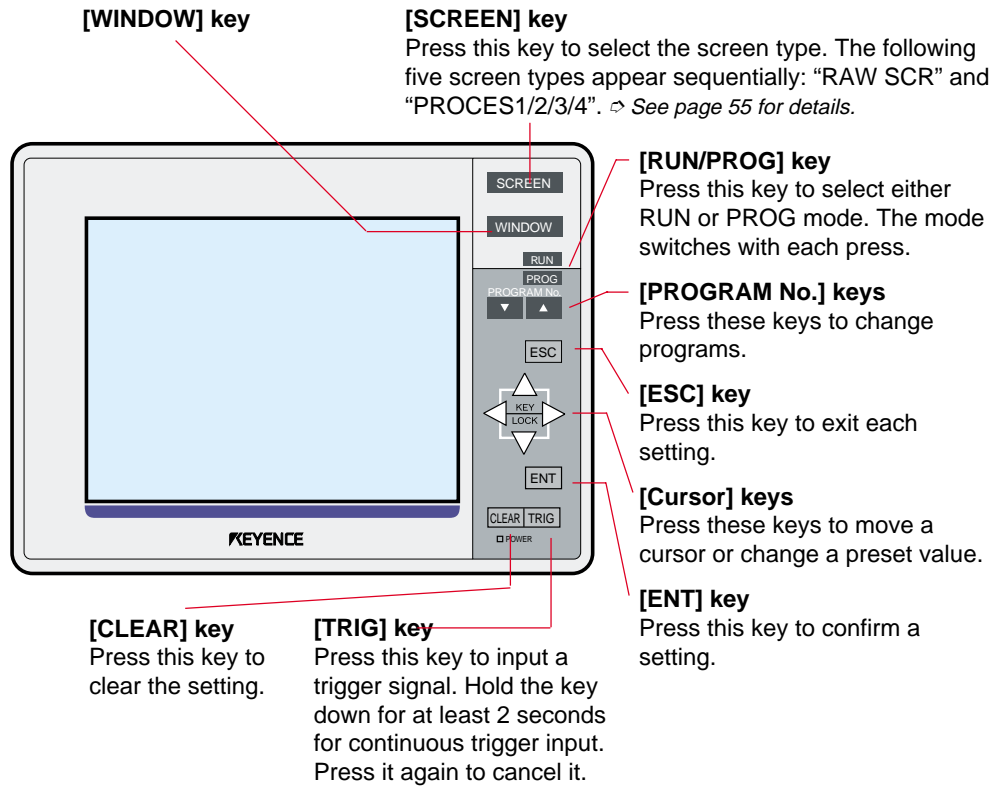

#### ■ How to use the cursor keys

The cursor keys include four keys: "▲, ▼, ◀, and ▶". Use these keys for the following purposes.

- To move through menu items.
- To enter the "TOL" (tolerance) value.
- To move the arrow cursor on the monitor.
- To change the size of a window or move a window.
- To lock the panel key operation temporarily. (Hold down the "◀ and ▶" keys simultaneously for at least 2 seconds to lock the panel keys. Hold them down again for at least 2 seconds to cancel.)

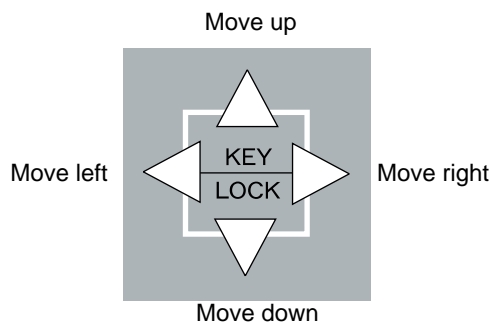

## Remote control console (CV-701(P)/751(P))

**Tips**

The remote control console is optional with the CV-751(P). (OP-30938)

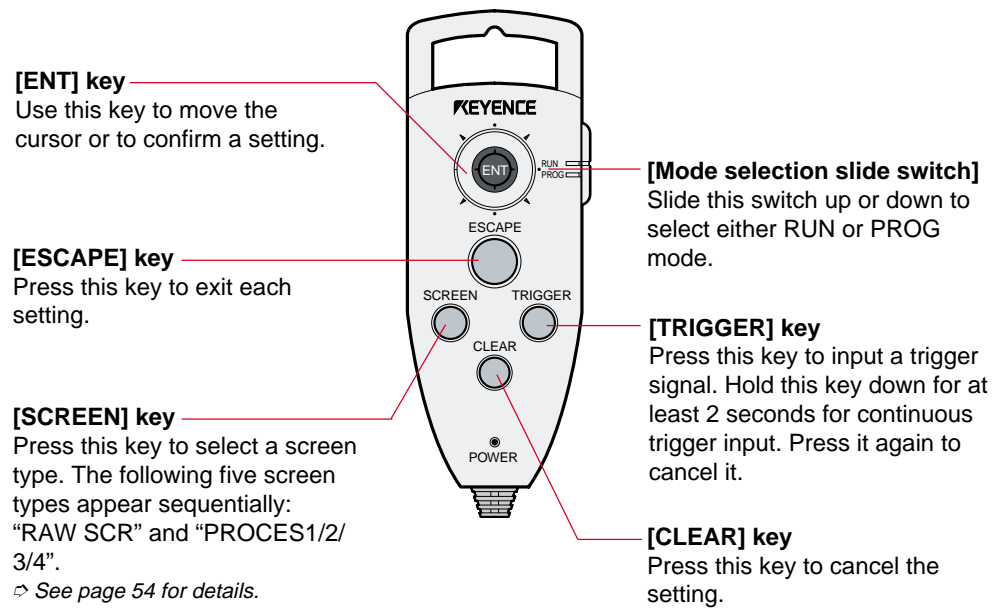

### ■ How to use the ENT key

#### ● Press the center of the key

- To select a menu item.
- To confirm a setting.

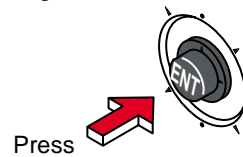

#### ● Move the key to the direction of an arrow

The key can be moved up, down, right, left, and diagonally. Move the key for the following purpose.

- To move through menu items.
- To enter values such as "TOL" (tolerance).
- To move the arrow cursor on the monitor.
- To change the size of a window or to move a window.

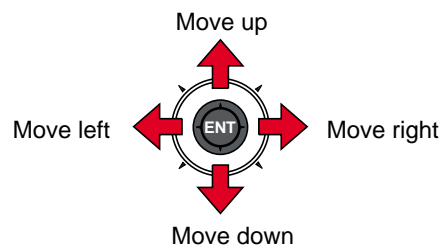

### 4.1.2 Screen page layout

The cursor position is displayed as highlighted on the menu screen. The menu screen has a layered structure. Use the following keys to move through the layers. For the layered structure of menu items, refer to the “Parameters” sections for each measurement mode.

- **With the panel keys**  
Use the [ENT] key, [Cursor] keys, and [ESCAPE] key.
- **With the remote control console**  
Use the [ENT] key and [ESCAPE] key.
- **Screen page layout**

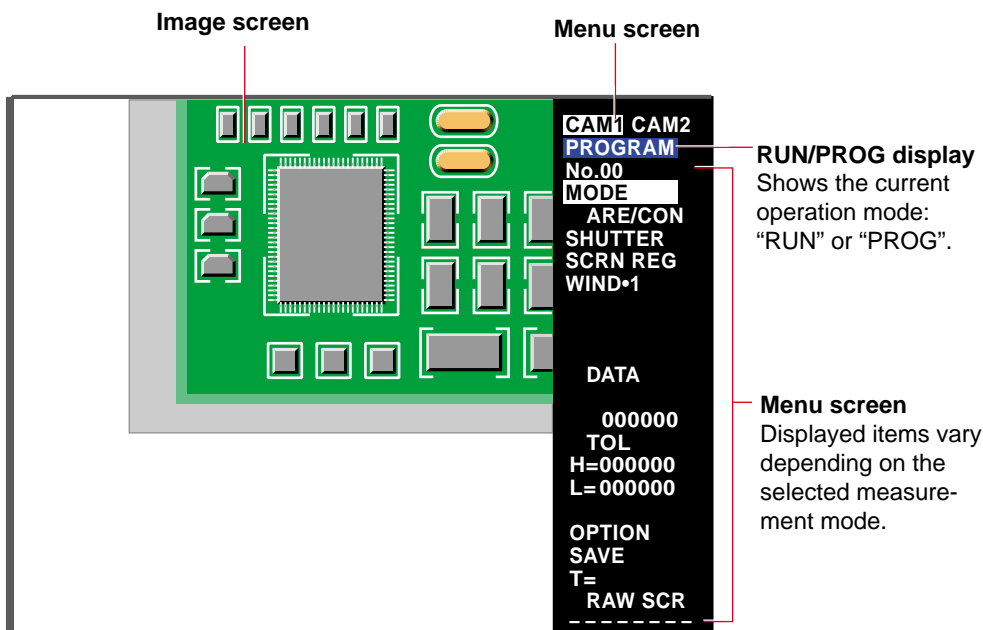

The menu screen above is displayed when [ARE/CON] is selected from the [MODE] menu.

## 4.2 Preparations

This section describes the preparations before settings.

### 4.2.1 Preparations before settings

#### Preparations before turning on the power

Check the cable connections.  
⇒ See page 11.

#### Preparations for turning on the power

**1. Turn on the power.**

An unprocessed screen will be displayed on the monitor.

**2. Aim the camera at a target and adjust the lens and illumination.**

⇒ See page 13.

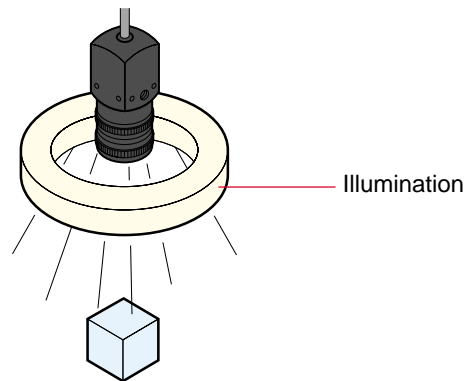

## 4.3 Basic Settings

This section describes the common settings for each mode. Be sure to read all instructions carefully.

### 4.3.1 Basic setting procedures

This section describes the setting procedures, basic information for changing settings, and how to perform the major functions.

#### Selecting the program number

Select a program number before changing the settings. The CV-701(P)/751(P) can save up to 16 measurement parameters. Each measurement parameter is called a "Program No.". By saving two or more parameters in advance, selection can be performed with a shift of program numbers upon target changeover. To save the previous settings, select an unused program number.

**Note:** When two cameras are connected, the available program numbers are limited to 00 through 07.

**Tips**

Use a CompactFlash memory (↔ page 171) or RS-232C communication function (↔ page 179) to save more than sixteen sets of parameters to a personal computer.

#### ■ Panel keys

Press the PROGRAM number keys to select the program number. Pressing the "▲" key increases the number, and pressing the "▼" key decreases the number.

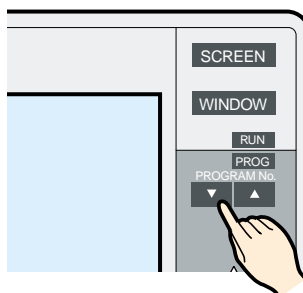

#### ■ Remote control console

1. Place the cursor on [No.].

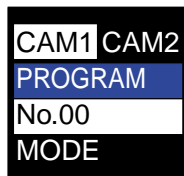

2. Press the [ENT] key to display the program number selection menu.
3. Move the [ENT] key up or down to place the cursor on the desired number.

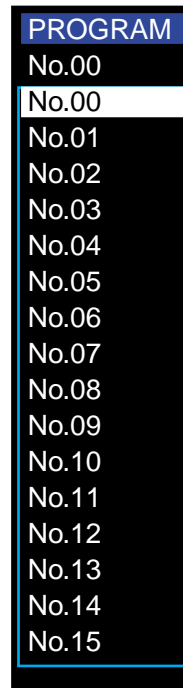

4. Press the [ENT] key to confirm the selection.

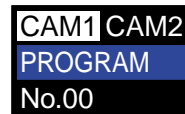

#### Tips

- A program number with “●” indicates that the number is already being used.
- Selecting the program number can also be done by using the input terminal in RUN mode.

## Setting the measurement mode

The CV-701(P)/751(P) allows you to select a measurement mode best suited for the application from the following five measurement modes: “ARE/CON”, “INS/TRG”, “INS+POS”, “ABS.POS”, and “REL.POS”. For an overview of each measurement mode, see “Mode Selection” (⇒ See page 17).

1. Place the cursor on [MODE].

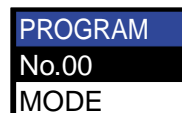

2. Press the [ENT] key to display the mode selection menu.
3. Press the [ENT] key up or down to place the cursor on the desired mode.

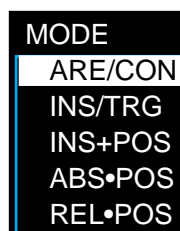

4. Press the [ENT] key to confirm the selection.

The cursor will move onto [SHUTTER].



**Tips**

To change a set measurement mode, place the cursor on “Y” and press the [ENT] key when the message <ERASE SETTINGS N/Y> appears on the screen.

### Selecting a shutter speed

Select a shutter speed according to the speed of the target movement. When the screen is too bright or too dark, the brightness of the screen is adjusted by changing the shutter speed. Select a shutter speed from 11 settings: 1/30 through 1/10000 of a second.

1. Place the cursor on [SHUTTER] and press the [ENT] key to display the shutter menu.



2. Place the cursor on the desired shutter speed and press the [ENT] key to confirm the selection.

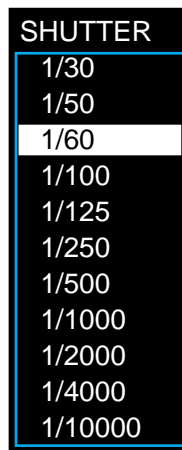

**Tips**

- When the image on the screen is blurred because the target moves too quickly, select a faster shutter speed.
- Be sure to readjust the lens after changing the shutter speed, because the brightness has been changed.



## Register a screen

Save the image to be registered on the memory. Set measurement parameters based on the reference image.

1. Place the cursor on [SCRN REG] and press the [ENT] key to display the camera selection menu.

```
SHUTTER
SCRN REG
WIND•1
```

2. Press the [ENT] key when using only one camera. The message <REGISTER SCREEN N/Y> appears on the monitor screen. (When two cameras are connected, select one camera to be registered.)

☞ See page 42.

```
SHUTTER
SCRN REG
CAM1
```

3. Move the [ENT] key to the right to select “Y”. To cancel the screen registration, press the [ENT] key while “N” is highlighted.



### Tips

Pressing the [TRIGGER] key while “Y” is highlighted updates the screen image.

4. Press the [ENT] key. The message <CHANGE POS N/Y> appears on the screen. Move the [ENT] key to the left to select “N”, and go to step 5.

When using the position adjustment function in “INS+POS” or “ABS.POS” mode, go to the next step in the bracket.



### Tips

- The position can be changed when using the position adjustment function. If the target is projected at an angle on the screen, it can be adjusted to the proper position.
- In position detection, angle detection or angle adjustment operation, the origin point is specified with the registered screen. Therefore, adjust the position and angle of the target on the registered screen to determine the origin point.

## Position and angle setting procedure

1. The position of the target can be changed when the target is projected at an angle on the screen while the message <CHANGE POS N/Y> appears on the screen. Move the [ENT] key to the right to select “Y”. When the target is projected as straight, select “N” and press the [ENT] key.



2. When “Y” is selected, the message <ARROW KEY MOVE> appears on the screen. You can scroll the screen horizontally or vertically. Adjust the position and press the [ENT] key.



- **With the panel keys**

Scroll the screen by pressing the [Cursor] keys.

- **With the remote control console**

Scroll the screen by moving the [ENT] key.

3. The message <UP/DOWN ROTATE> appears on the screen. Adjust the angle of the target so that the pattern to be searched is projected as straight in a horizontal or vertical position, and press the [ENT] key.



- **With the panel keys**

Adjust the angle by pressing the cursor keys.

[▲]: Rotates the target counterclockwise.

[▼]: Rotate the target clockwise.

- **With the remote control console**

Adjust the angle by pressing the [ENT] keys.

[▲]: Rotates the target counterclockwise.

[▼]: Rotate the target clockwise.

- The message <ARROW KEY MOVE > appears again on the screen. Read-just the position if necessary.
- Press the [ESCAPE] key to exit the position change operation.

The message <REGISTER POS N/Y> appears on the screen.



- Press the [ENT] key. The message <REGISTERING> appears on the screen. Registration is complete when the message disappears. To cancel the position change operation, select “N” and press the [ENT] key to go back to step 1.



- Press the [ENT] key. The message <REGISTERING> appears on the screen, and the image is saved in the memory. When registration is complete, the screen returns to the main menu.

## Select a window number

Set different targets, measurement parameters, and result values for each window. Select window numbers when measuring two or more points with one measurement mode.

- Place the cursor on [WIND•1] and press the [ENT] key. The window menu appears.



- Place the cursor on the desired window number, and press the [ENT] key. (Window 1 is selected here.) The selected window menu appears.

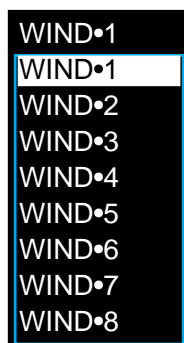

**Tips** A window number shown with “●” indicates that the number is already being used.

### 4.3.2 Using two cameras

#### Selecting a camera image

When two cameras are connected, the screen registration should be done for each camera.

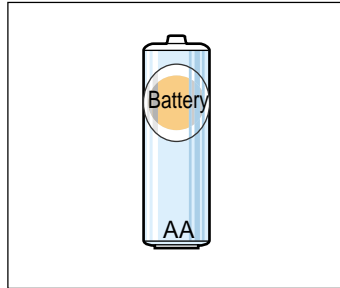

Camera 1

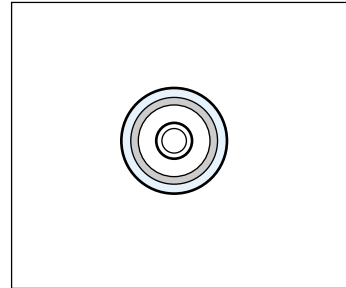

Camera 2

**Note 1:** When two cameras are connected, the available program numbers are limited to 00 through 07.

**Note 2:** When the vertical/horizontal split screen (1/2) is selected, both screens of the two cameras should be registered.

1. Place the cursor on [SCRN REG] and press the [ENT] key.



2. Place the cursor on the camera to be selected, and press the [ENT] key.

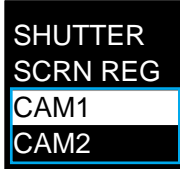

#### Select a window

When two cameras are connected, you can select one of the registered screens to set a window.

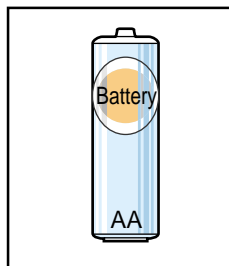

Camera 1

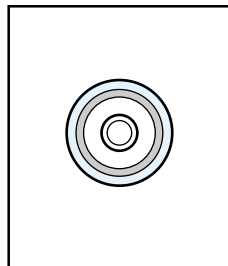

Camera 2

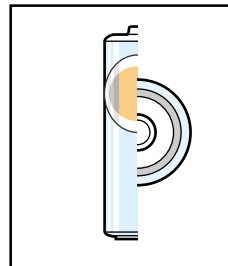

Camera 1 | 2

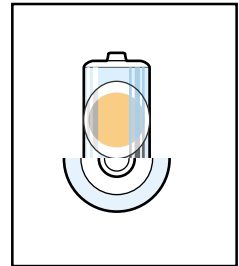

Camera 1/2

1. Place the cursor on [SEL SCRΝ] and press the [ENT] key.

```

WIND•1
SEL SCRΝ
COLOR
  
```

2. Place the cursor on one of the four registered screens and press the [ENT] key.

```

SEL SCRΝ
CAM1
CAM2
CAM1/2
CAM1I2
  
```

**Note 1:** In the “INS+POS” (Inspection+ position) mode, select the screen that is used for “POS ADJ” (Position adjustment) for WIND•1 (Window 1). When “CAM1I2” or “CAM1/2” is selected in “WIND•1”, position adjustment is operated by using the image from Camera 1.

**Note 2:** In the “INS+POS” mode, “POS ADJ1” uses the image from Camera 1, and “POS ADJ2” uses the image from Camera 2 for position adjustment.

## Selecting an Inspection Mode (“INS/TRG” and “INS+POS” modes only)

The “INS/TRG” and “INS+POS” modes offer 10 inspection modes. You can select different inspection methods for each window. The inspection method is referred to as “INSPECT” mode. (⇒ See page 74 for the menu hierarchy.)

1. Place the cursor on [INSPECT] and press the [ENT] key. The inspection mode menu appears on the screen.

```

WIND•1
INSPECT
AREA
  
```

2. Place the cursor on the inspection mode to be selected, and press the [ENT] key. The AREA mode is confirmed.

```

INSPECT
AREA
OUTER
INNER
GAP
PITCH
EDGE No
COUNT
POINT
STAIN
GRAVITY
  
```

## Selecting Colors

The CV-701(P)/751(P) measures registered patterns by measuring the “color” of the area.

Define the target objects that are to be measured.

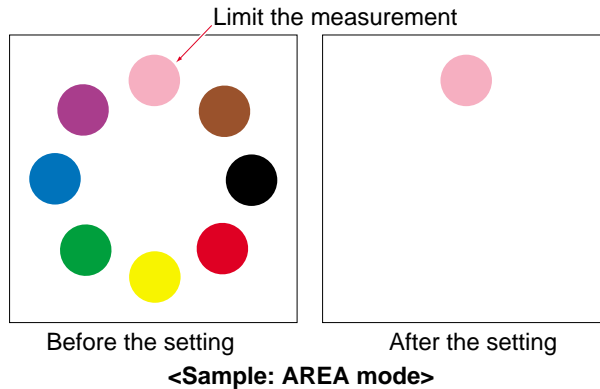

1. Place the cursor on [COLOR] and press the [ENT] key. The menu is switched to the color setting menu.

Refer to the chart below to select [CLR TYPE] (Color type) if necessary.

Use this setting when copying color extraction settings of other windows, or when the color density extraction is not extracted properly. Place the cursor on the desired color type and press the [ENT] key. The color type is selected.

Setting	Description
COLOR	Displayed with AREA and POINT modes. Processes color-binary conversion.
COLOR1	Extracts the target color to process the color density. Select COLOR1 for most operations.
COLOR2	Select COLOR2 if the color is not extracted properly with COLOR1. (When both the target and background are dark colors.)
GRAY	Select this mode when the targets are similar colors or black and white. Converts the brightness/darkness into monochromatic images.
POS ADJ *	Appears when "INS+POS" mode is selected. Copies the set color data when a position adjustment window is set. (When it is not set, the window names are shown in red color.)
WIND1/2/3/4/5/6/7/8	Copies the set color data when a window is selected. (When it is not set, the window names are shown in red color.)

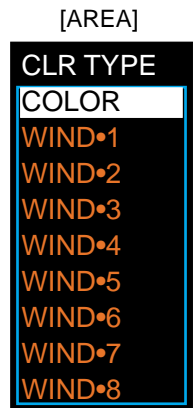

\* Go to page 49 when selecting this color type.

**Tips**

The color data can easily be set by copying the color data from one window to another. The processing speed is reduced when, by selecting the already extracted colors from previous windows, the same color data is used for all windows.

2. Place the cursor on [SELECT] and press the [ENT] key. An arrow cursor appears on the screen.



3. Move the arrow to the position of the color to be extracted by using the [ENT] key.





4. Press the [ENT] key. The highlighted area is extracted. Extend the extraction area by repeatedly pressing the [ENT] key. To optimize the detection, repeat the color extraction procedure until the images shown in the sample below appear.

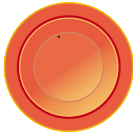

<Sample: AREA mode>

Inspection mode	
<b>AREA/POINT mode</b>	Extract the color until the desired area of extraction is shown clearly. The extracted color is shown in colors.
Raw image	Extracted image
	(COLOR)
<b>EDGE mode (OUTER/ INNER/PITCH/GAP/ EDGE NO/SEARCH)</b>	Extract the color until the edge (the boundary between the area of extracted color and the rest) becomes clear. The extracted color is shown in white.
Raw image	Extracted image
	(COLOR1)
<b>COUNT/GRAVITY mode</b>	Extract the color until the clusters of extracted colors become isolated from the background.
Raw image	Extracted image
	(COLOR2)

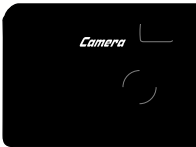
Inspection mode	
<b>STAIN mode</b>	Extract the color until the defects and stains become isolated.
Raw image	Extracted image   (COLOR1)
<b>PATT</b>	Extract the color until the whole image to be searched becomes isolated.
Raw image	Extracted image   (COLOR1)

\* When "PROCES2" is displayed (except AREA and POINT modes), the 255th level is shown in yellow. Be sure that the yellow color is not displayed except in the target area.

**Tips**

- When some areas of the target color have not been extracted, move the cursor to the non-extracted area and press the [ENT] key.
- To go back to the previous step, press the [CLEAR] key. The extraction procedures go back to the previous step by the number of times you press the key (9 times max.).

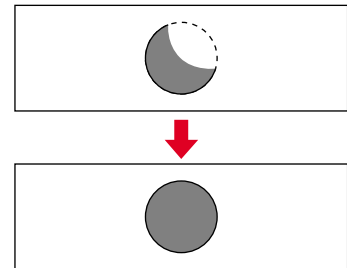

**5. Press the [ESCAPE] key. The cursor returns to [SELECT].**

**Tips**

When detecting the same color for two or more windows simultaneously, color data can easily be set by copying data.



### ■ Zoom in on the image

You can zoom in on the image for easy color extraction.

1. Press the [TRIGGER] key upon [SELECT]. The zoom function is enabled.

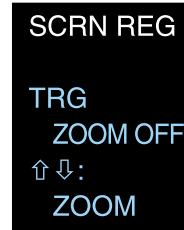

2. Every time the [ENT] key is pressed upward, the image is zoomed in. Every time the [ENT] key is pressed downward, the image is zoomed out. Select the desired image size.
3. Press the [TRIGGER] key. The zoom function is canceled and you can continue operation with the [SELECT] menu with the selected image size.

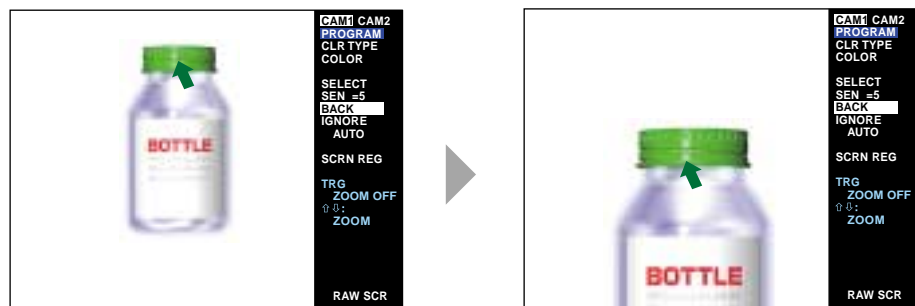

## Auto Color Extraction

The [AUTO] mode stabilizes the color extraction against the color variation of targets and the fluctuation of illumination. Setting the [AUTO] function after color extraction is recommended.

1. Place the cursor on [AUTO] and press the [ENT] key repeatedly. The color selected with [SELECT] is extracted. To cancel, press [CLEAR]. The extraction procedures go back to the previous step by the number of times you press the key (9 times max.).



2. Press the [ESCAPE] key. The cursor returns to [COLOR].

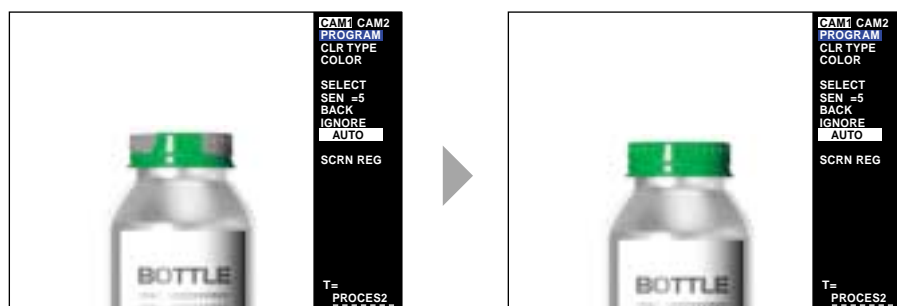

## Adjust the [SEN] (Color sensitivity)

The range of selection is 0 to 9. (5 is the initial value).

- Select the color sensitivity for color extraction with **[SELECT]**.
- Smaller numbers indicate higher identifying sensitivity for colors. Color extraction can be operated in stages with **[SELECT]**.
- Larger numbers indicate lower identifying sensitivity for colors. Use this setting for approximate color extraction when a target has a limited number of colors.

### 1. Place the cursor on [SEN] in the color menu and press the [ENT] key.

The cursor moves to the number.

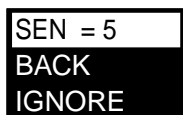

### 2. Select a number with the [ENT] key.

- **With the panel keys**  
Press “▲” or “▼” cursor.
- **With the remote control console**  
Press the [ENT] key up or down.

Pressing the [ENT] key up increases the number, and pressing the [ENT] key down reduces the number.



### 3. Press the [ENT] key.

The [SEN] is confirmed.

## Ignore an unwanted extracted color

Set to ignore unwanted colors from the extracted colors.

### 1. Place the cursor on [IGNORE] and press the [ENT] key.

An arrow cursor appears on the screen.



### 2. Move the arrow cursor to the unwanted color using the [ENT] key.



3. Press the [ENT] key. The color of the arrow-selected area will not be extracted.



#### ■ Clear the color extraction

You can clear the extracted color data and resume the setting from the beginning.

1. Place the cursor on [SELECT] or [AUTO] by using the [ENT] key or [ESCAPE] key.
2. Hold down the [CLEAR] key for at least two seconds. The message <ERASE SETTINGS N/Y> appears on the screen.
3. Press the [ENT] key to the right to select "Y".
4. Press the [ENT] key. The selected color data is cleared.



## Screen coordinates

The monitor screen defines the upper left corner as the reference point and is composed of more than 240,000 pixels: 508 pixels in the X-axis direction and 480 pixels in the Y-axis direction.

The tolerance and position are presented using pixels as the units.

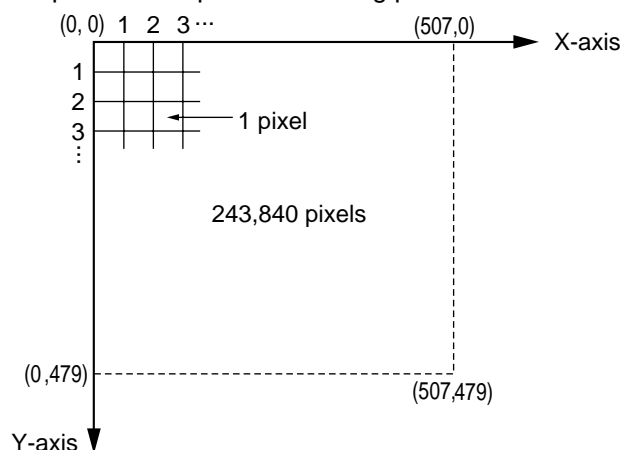

A pixel is a basic unit in image processing. The length and area are presented in pixels.

## Drawing a window

The measurement range on the screen is called a window. The shape of the window can be selected from a square (SQR), a circle (CIRC), a free square (F.SQR), a ring (RING), or an arc (ARC).

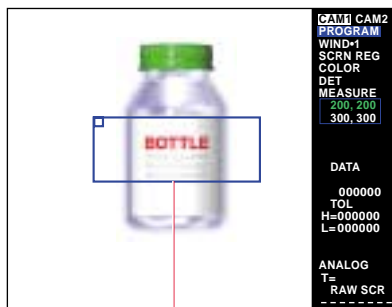

Square window

**Tips**

The available window shapes vary depending on the measurement mode.

### ■ Setting a window

Set a window by the following procedures. (Description is given with the AREA mode as a sample.)

1. Place the cursor on **[MEASURE]** and press the **[ENT]** key. The window shape select menu appears.



2. Select a window shape from **[SQR]** (square), **[CIRC]** (circle), and **[F.SQR]** (free square).

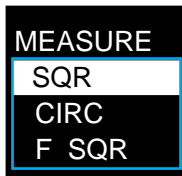

3. Press the **[ENT]** key. A window appears on the screen. The screen below is the window when **[SQR]** is selected.

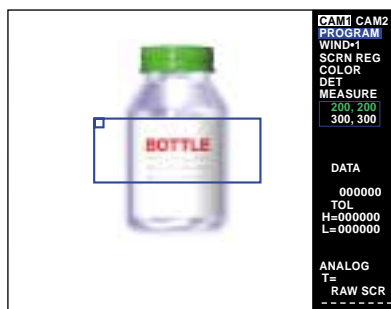

4. Draw a window. The drawing procedure for each window shape is described in the following section.



### ● Drawing a square [SQR] window

1. With the cursor placed on point A, move it in the desired direction. Point A moves in this direction to change the shape or size of the window.
2. Press the [ENT] key to set the position of point A.
3. With a cursor placed on point C, move it in the desired direction. Point C moves in this direction to change the shape or size of the window.
4. Press the [ENT] key to set the position of point C.
5. With the cursor placed on a corner of the window, move it in the desired direction. The window moves in this direction. Pressing the [ENT] key repeats the steps above.
6. After setting the size and position of the window, press the [ESCAPE] key to complete the drawing of a window.

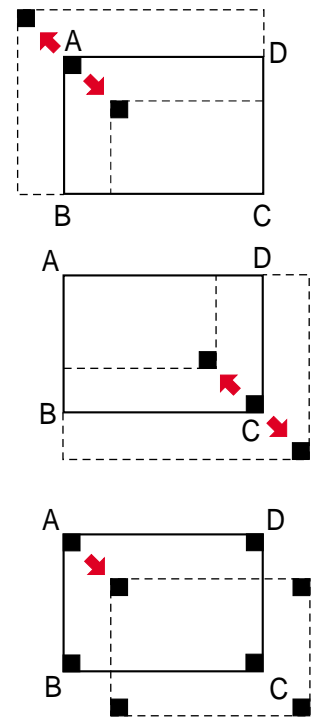

### ● Drawing a circular [CIRC] window

1. With the cursor placed on point A, move it up or down to move point A in the desired direction.
2. Press the [ENT] key to set the position of point A.
3. With the cursor placed inside the window, move it in the desired direction to move the window. Pressing the [ENT] key repeats the steps above.
4. After setting the size and position of the window, press the [ESCAPE] key to complete the drawing of the window.

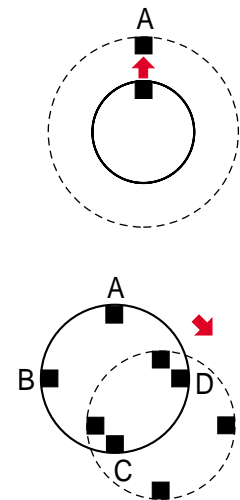

### ● Drawing a free square [F.SQR] window

1. With the cursor placed on point A, move it in the desired direction. Point A moves in this direction to change the shape or size of the window.
2. Press the [ENT] key to set the position of point A.
3. Set the positions of points B, C, and D using the same procedure above.
4. With the cursor placed on the corner of the window, move it in the desired direction. The window moves in this direction. Pressing the [ENT] key repeats the steps above.

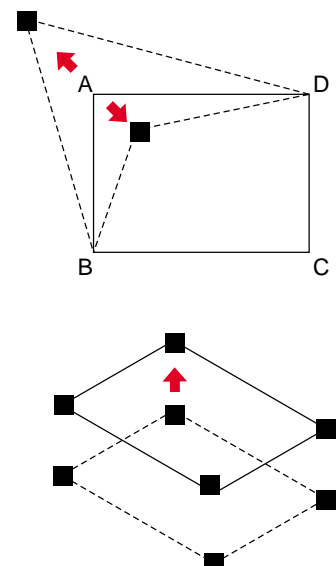

- After setting the size and position of the window, press the [ESCAPE] to complete the drawing of the window.

● **Drawing a ring [RING] window**

This window is available only when “STAIN” is selected for the measurement mode.

- With the cursor placed on point A, move it in the desired direction. Point A moves in this direction to change the shape or size of the window.
- Press the [ENT] key to set the position of point A.
- With the cursor placed on point B, move it in the desired direction. Point B moves in this direction to change the shape or size of the window.
- Press the [ENT] key to set the position of point B.
- With the cursor placed inside the window, move it in the desired direction. The window moves in this direction. Pressing the [ENT] key repeats the steps above.
- After setting the size and position of the window, press the [ESCAPE] key to complete the drawing of the window.

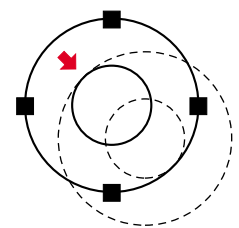
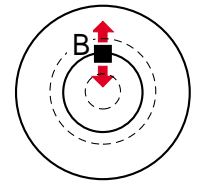
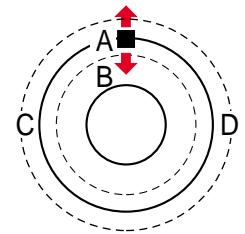

● **Drawing an arc [ARC] window**

This window is available only when “STAIN” is selected for the measurement mode.

- With the cursor placed on point A, move it in the desired direction. Point A moves in this direction to change the shape or size of the window.
- Press the [ENT] key to set the position of point A.
- With the cursor placed on point B, move it in the desired direction. Point B moves in this direction to change the shape or size of the window.
- Press the [ENT] key to set the position of point B.
- With the cursor placed inside the window, move it in the desired direction. The window moves in this direction. Pressing the [ENT] key repeats the steps above.
- After setting the size and position of the window, press the [ESCAPE] key to complete the drawing of the window.

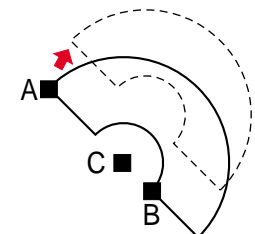
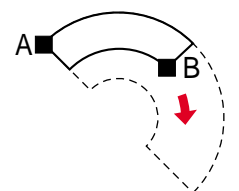
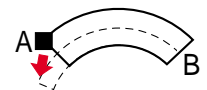

### ● Cursor movement by pressing the [ENT] key

Every time the [ENT] key is pressed, the window drawing mode changes as shown below.

When drawing a square window

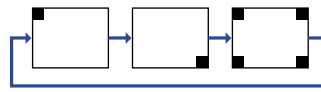

When drawing a circular window

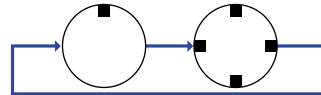

When drawing a free square

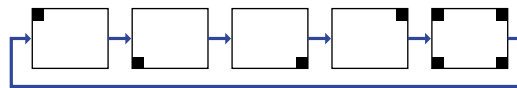

When drawing a ring

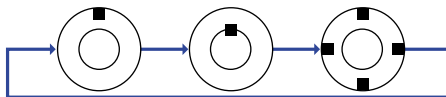

When drawing an arc



#### Tips

#### To change the window shape

Selecting SQR, CIRC, F.SQR, RING, or ARC is available only when the window is not drawn. To change the shape to another selection (square, circle, free square, ring, or arc) after drawing a window, clear the current window. To clear the current window, place the cursor on **[MEASURE]** and hold the [CLEAR] key down for at least two seconds. The message <ERASE SETTINGS N/Y> appears on the screen. Place the cursor on “Y” and press the [ENT] key.

### ● Window coordinate value display

The coordinate values of a window are displayed with numerical values. Use the values to check or save the setting.

Square window

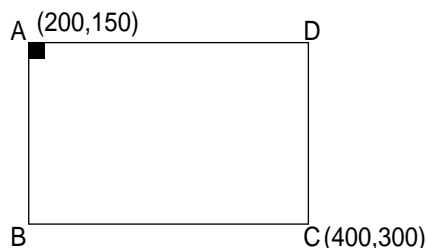

MEASURE

200, 150  
400, 300

Upper line: Coordinates of point A (X, Y)  
Lower line: Coordinates of point C (X, Y)

Circular window

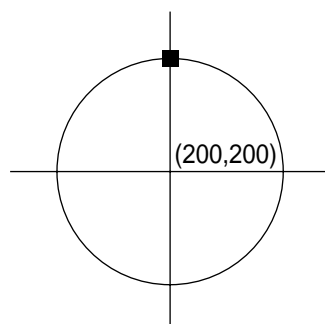

MEASURE

X=+00200  
Y=+00200  
R= 00100

X: X-coordinate of the circle center  
Y: Y-coordinate of the circle center  
R: Radius

Free square window

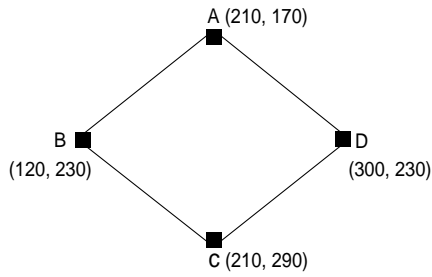

```
MEASURE
210, 170
120, 230
210, 290
300, 230
```

- 1st line: Coordinates of point A (X, Y)
- 2nd line: Coordinates of points B (X, Y)
- 3rd line: Coordinates of points C (X, Y)
- 4th line: Coordinates of points D (X, Y)

Ring window

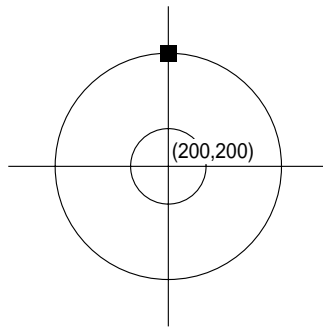

```
MEASURE
X=+00200
Y=+00200
ER=00100
IR=00050
```

- X: X-coordinate of the circle center
- Y: Y-coordinate of the circle center
- ER: Radius of external circle
- IR: Radius of internal circle

Arc window

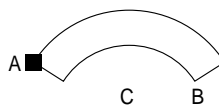

```
MEASURE
200, 200
100, 100
250, 150
```

- 1st line: Coordinate of point C (X, Y)
- 2nd line: Coordinate of point A (X, Y)
- 3rd line: Coordinate of point B (X, Y)

4



## Screen Selection

There are five types of screens: "RAW SCR" and "PROCES1/2/3/4". Use the "PROCES1/2/3/4" to check the settings or operation.

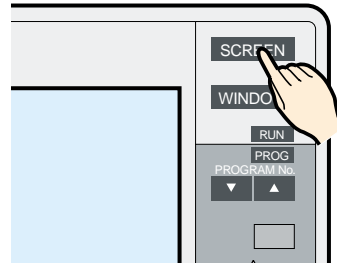

### ■ Selecting the screen

Every time the [SCREEN] key is pressed, the screen changes to the next type in sequence.

Some screens may not appear depending on the selected menu.

### ■ AREA and POINT

RAW SCR (raw screen)

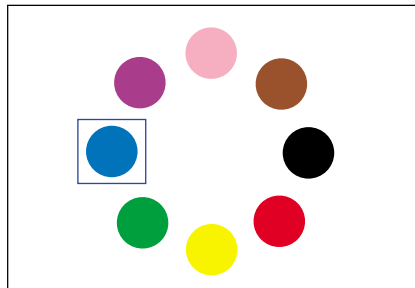

Shows a window frame on a raw screen

PROCES1 (processed screen 1)

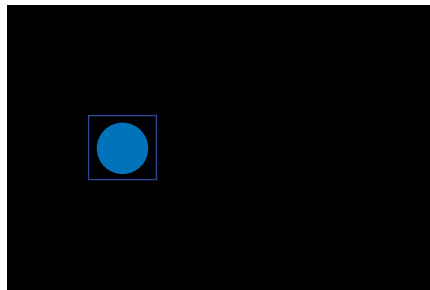

Converts the whole screen into a color binary image using the binary level of the selected window.

PROCES2 (processed screen 2)

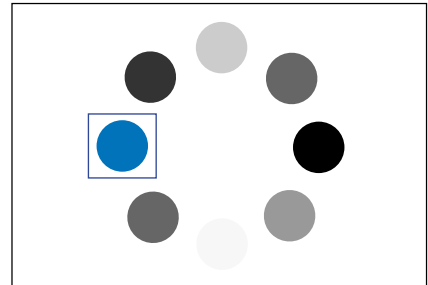

Converts the whole screen into a binary image using the binary level of the selected window. Colors other than the extracted color are shown in gray.

PROCES3 (processed screen 3)

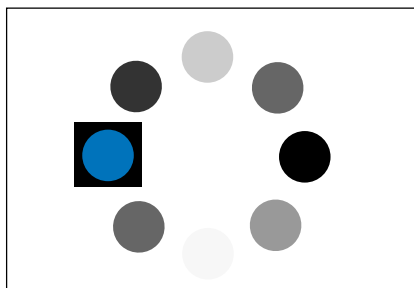

Converts only the inside of the selected window into a binary image using the binary level of each window respectively. The area outside the window is shown in gray.

PROCES4 (processed screen 4)

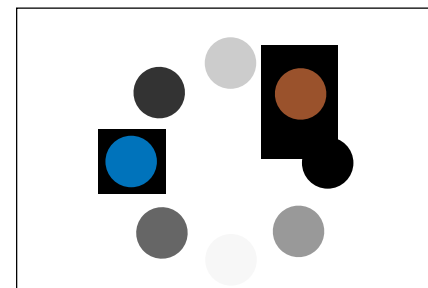

Converts the inside of each window into a binary image using the binary level of each window respectively. The area outside the windows is shown in gray.

■ Other (EDGE, COUNT, STAIN, and GRAVITY)

RAW SCR (raw screen)

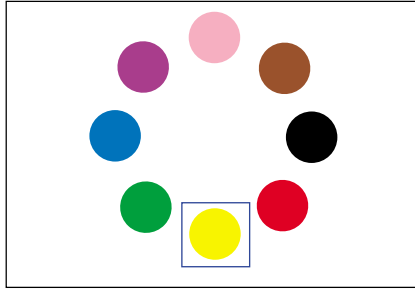

Shows a window frame on a raw screen.

PROCES1 (processed screen 1)

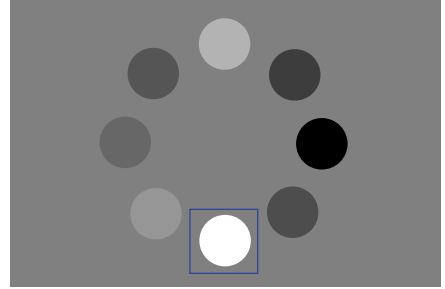

Display in color density or gray

PROCES2 (processed screen 2)

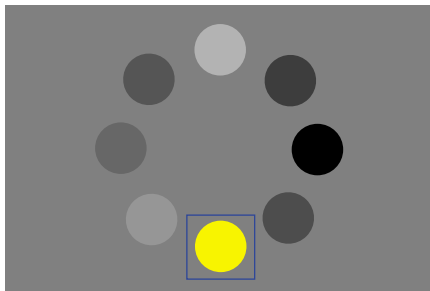

The 255 levels are shown in yellow on the gradation display.

PROCES3 (processed screen 3. COUNT and GRAVITY modes only)

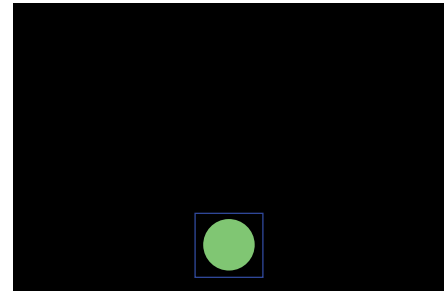

Display only extracted colors in green on the gradation screen.

4

## 4.4 “AREA” Mode Basic Settings

Set the “AREA” mode from “ARE/CON” mode for continuous detection, and select “AREA” from “INS/TRG” for detection using the trigger signal input. This section describes the basic setting procedures using the “ARE/CON” (Area continuous) mode.

### 4.4.1 “AREA” mode

#### ■ Difference between “ARE/CON” (Area continuous) and “INS/TRG” (Inspection trigger)

“ARE/CON” detects a target continuously. “INS/TRG” can be used for area detection, but it detects a target only when a trigger signal is input. Both modes are set using the same procedure.

#### ■ Resolution of image

The images picked up with the CV-701(P)/751(P) are composed of the primary colors R (red), G (green), and B (blue), and each color has 256 color levels from 0 through 255. For example, a color with R=200, G=50, B=40 is a reddish color, and a color with R=150, G=150, B=150 is white. The data of R-G, G-B, and R-B are obtained based on the R, G, B data, and the area is set for the six parameters to operate color extraction. The color screen processes an image by 16,770,000 resolutions compared to the monochromatic gray mode that processes colors from white to black with 256 levels. This color mode enables target differentiations that cannot be distinguished with a black and white mode.

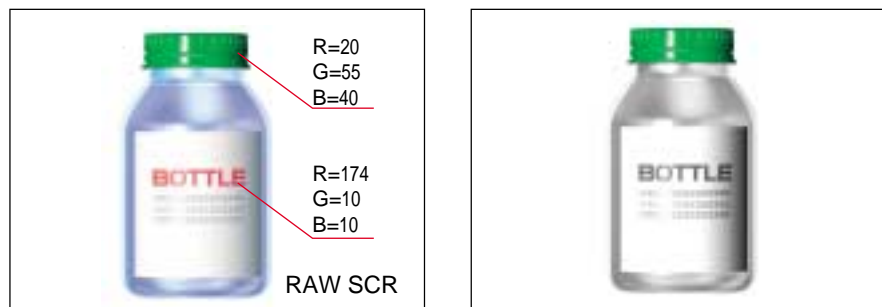

#### ■ Counting pixels

The CV-701(P)/751(P) counts the pixels of extracted colors in the MEASURE window and displays the number of pixels. You can set a tolerance (upper/lower limits) for the number of pixels to differentiate targets between acceptable and unacceptable. This enables detection of the presence or absence of components and the size of a target.

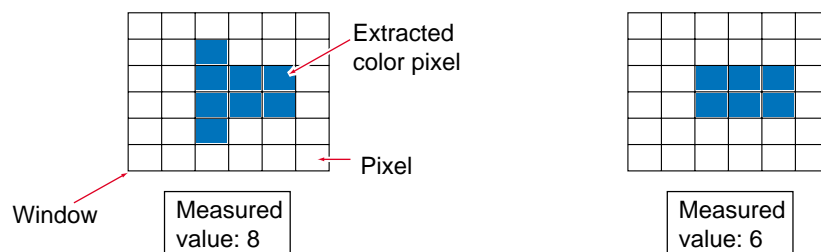

#### Tips

If the position or angle of the target is not constant on the screen, use the position adjustment function. Select “INS+POS” (Inspection + position) in the mode selection.

☞ See “Basic Setting Flow” on page 107.

### 4.4.2 Initial menu screen

The following menu appears after “ARE/CON” is selected.

**Program No.**  
Up to 16 programs (Nos. 00 to 15) can be registered.

**Shutter speed**  
Changes shutter speed.

**Window**  
Sets a window for detection.

**Processing time**  
Displays the processing time for each screen. (Units: ms)

**Detection result**  
The indicator shows the detection result for each window (8 windows max.). The lamp farthest to the left represents window 1, and the lamp farthest to the right represents window 8.

- (Green): Within tolerance
- (Red): Out of tolerance
- (White): No detection
- : The window has not been determined.

**CAM1 CAM2**  
**PROGRAM**  
No.00  
**MODE**  
ARE/CON  
SHUTTER  
SCRN REG  
WIND\*1

**Mode**  
Allows selection from five measurement modes.

**Screen registration**  
Registers the image for setting.

**Measured value**  
Displays the measured value of the window. (Units: pixels)

**Tolerance**  
Sets the allowable range of the detection results. (Units: pixels)

**Option**  
Sets the illumination adjustment

**SAVE**  
Saves the settings.

**Screen selection**  
Shows the current screen type. (Raw screen, Processed screen 1/2/3/4)

**DATA**  
000000

**TOL**  
H=000000  
L=000000

**OPTION**  
SAVE  
T=

**RAW SCR**  
● ● ● ● ● ● ● ●

### 4.4.3 Basic setting flow

The “AREA” mode can be set by the following two procedures.

- Select the “ARE/CON” measurement mode.
- Select the “AREA” inspection mode from the window menu of the “INS/TRG” measurement mode.

#### “ARE/CON”

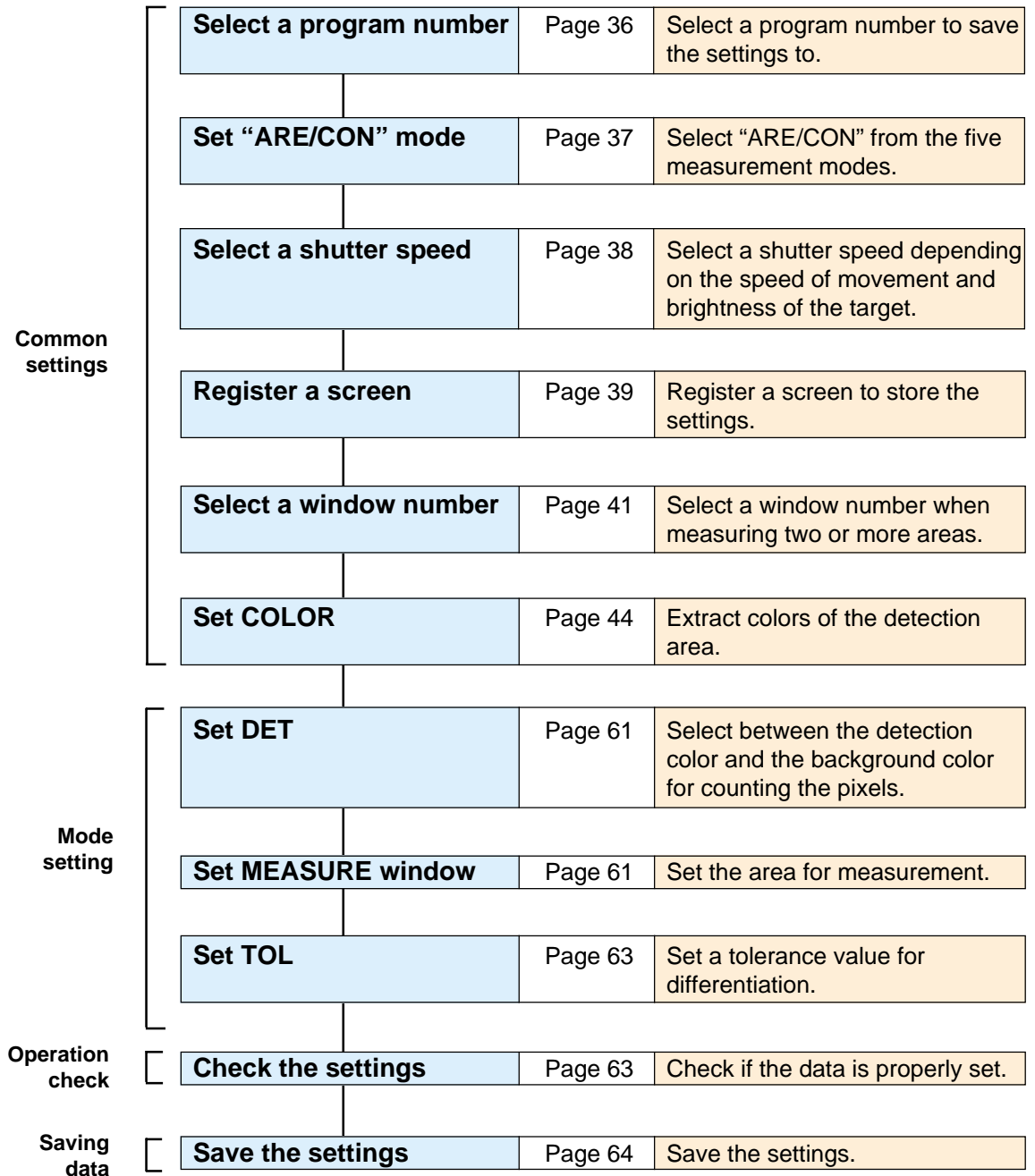

⇒ For the common settings, refer to “4.3 Basic Settings: Basic setting procedures” on page 36.

## Setting parameters

The parameters in bold type are described in the basic setting procedures.

- ⇒ See "4.5 "AREA" Mode Advanced Settings" on page 65 for other parameters.
- ⇒ See "Basic Settings" on page 36 for the parameters in bold.

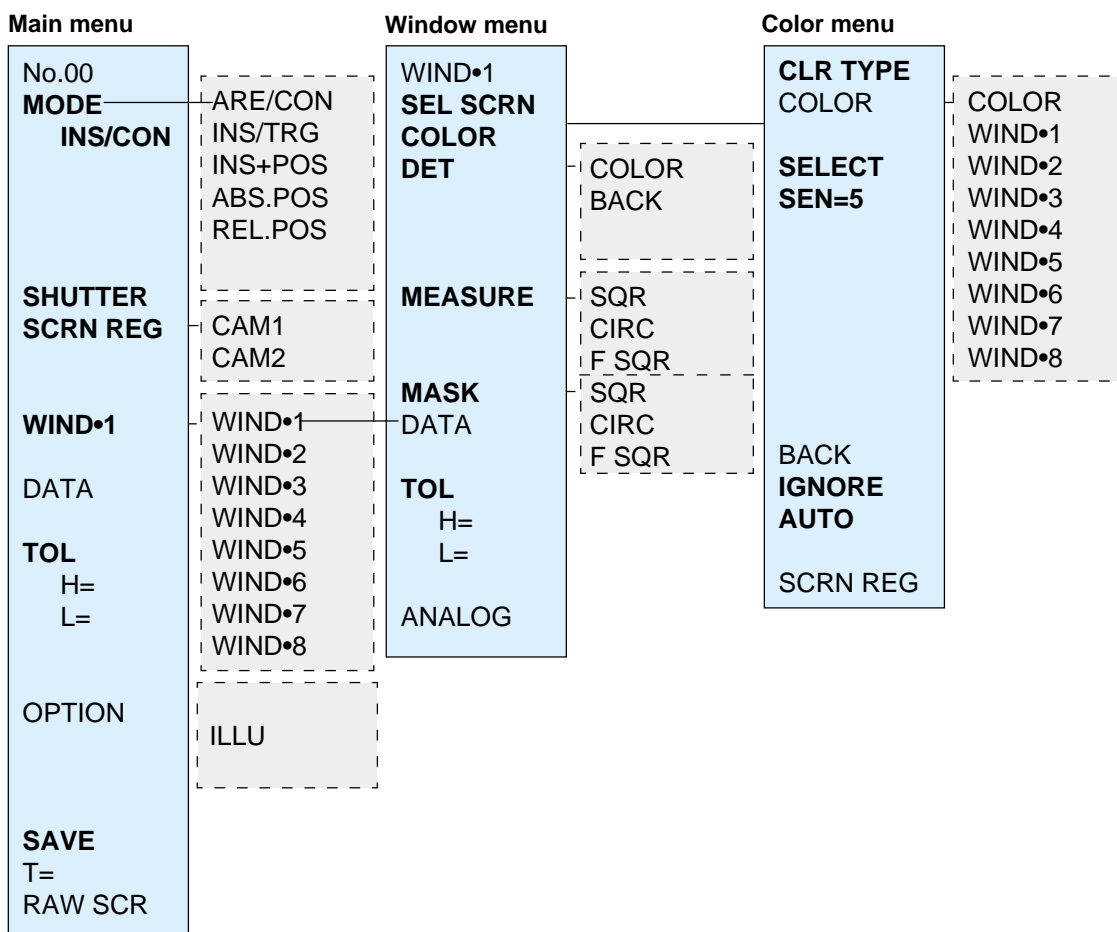

### ■ Screen type sequence

Pressing the [SCREEN] key shows the following sequence.

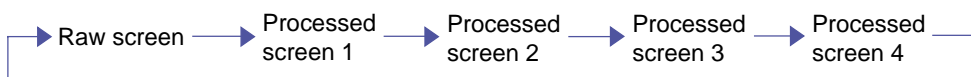

## Basic setting procedure

1. First follow the “Basic setting procedures” (⇨ *page 36*) to set the parameters to the color settings.

### 2. Set [DET] (Detection)

Select whether to count the color pixels (extracted color) in the window or the background pixels.

- 1) Place the cursor on **[DET]** and press the **[ENT]** key. The detection menu appears.



- 2) Select **[COLOR]** or **[BACK]** with the cursor.

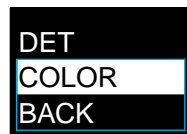

- 3) Press the **[ENT]** key to confirm the selection.

### 3. Set [MEASURE] (Measurement window)

Specify the range of the image (window) for measurement.

- 1) Place the cursor on **[MEASURE]** and press the **[ENT]** key. The window selection menu appears.



- 2) Select the shape of the window from **[SQR]** (square), **[CIRC]** (circle), and **[F SQR]** (free square).

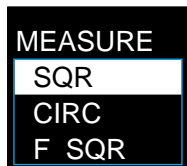

- 3) Press the **[ENT]** key. A frame appears on the screen. The screen below shows the frame when **[SQR]** is selected.

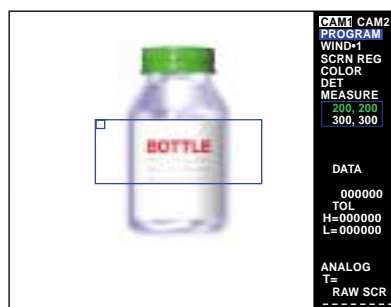

4) Move the cursor to enclose the desired area for measurement.

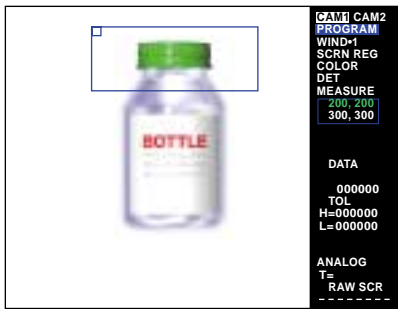

The window drawing mode changes as follows every time the [ENT] key is pressed.

Square window

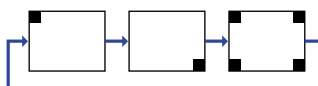

Circular window

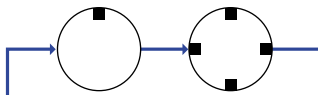

Free square window

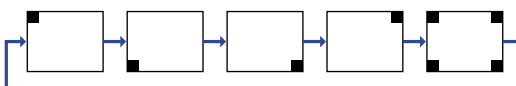

**Tips**

**To change the window shape**

Selecting SQR, CIRC, or F SQR is available only when the window is not drawn. To change the shape to another selection (square, circle, or free square) after drawing the window, clear the current window.

To clear the current window, place the cursor on **[MEASURE]** and hold down the **[CLEAR]** key for at least two seconds. The message <ERASE SETTINGS N/Y> appears on the monitor screen. Select “Y” and press the **[ENT]** key.

5) After setting the size and position of the window, press the **[ESCAPE]** key to exit the **[MEASURE]** setting.

**■ Mask window**

When a mask window (**[MASK]**) is overlapped with a measurement window, the area inside of the mask window is omitted from the measurement. Draw a mask window using the same procedure as for a measurement window.

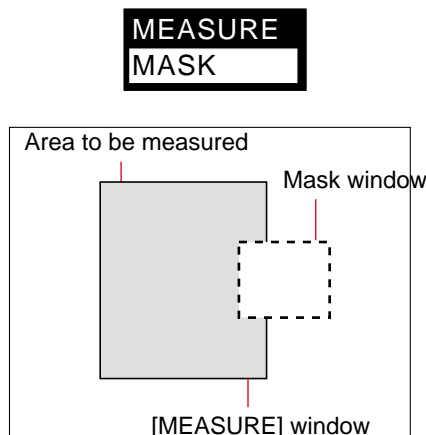



#### 4. Set [TOL] (Tolerance)

Set the upper limit “H=” and the lower limit “L=” of the tolerance. The units are pixels. The measured values within the tolerance will be acceptable; the values outside of the tolerance will be unacceptable.

- 1) First, set the upper limit.

Place the cursor on **[H=000000]** under **[TOL]** and press the [ENT] key. “0” for the first digit is shown highlighted. You can enter a numerical value.

```
TOL
H=000000
L=000000
```

- 2) Move the cursor left or right to select the digit to be changed.

```
TOL
H=000000
L=000000
```

```
TOL
H=000000
L=000000
```

- 3) Change the value.

```
TOL
H=000500
L=000000
```

- **With the panel keys**

Press the “▲” cursor key repeatedly.

- **With the remote control console**

Move the [ENT] key up repeatedly. The value increments by one from “0”, and after “9” the second digit is incremented.

When the “▼” cursor key is pressed or the [ENT] key is moved down, the value decrements by one to 0.

- 4) Press the [ENT] key to confirm the input value.

- 5) Place the cursor on **[L=000000]** (lower limit) under **[TOL]** and change the value using the same procedure as for the upper limit.

```
TOL
H=000000
L=000000
```

#### Tips

- When you cannot determine the tolerance value, refer to the measurement value displayed in the “Operation check after changing the settings” described in the following pages.
- The upper limit cannot be smaller than the lower limit.

The setting for WIND•1 is complete.

You can set up to eight windows for a single program number.

To set several windows, select another window number and repeat the above procedures.

### Operation check after changing the settings

1. Press the [ESCAPE] key to return to the initial menu screen.

When the initial menu screen is displayed, trigger signals are input continuously and the measured value is displayed.

```
DATA
Measured value — 001216
```

**2. Check the detection result indicator.**

- Green: Acceptable (The measured value is within the tolerance range.)
- Red: Unacceptable (The measured value is outside of the tolerance range.)
- White: No detection (The trigger signal is not input.)



**Note 1:** When **[INS/TRG]** (Inspection + position) is selected, the measured value is displayed at the time of a trigger input. Press the **[TRIGGER]** key to input the trigger signal. The detection result indicator is white before the first trigger input.

**Note 2:** When **[ARE/CON]** is selected, “DATA” (Measured value) is retained while the **[TRIGGER]** key is pressed.

**Tips**

Use the “illumination adjustment function” when the measured value is not stable because of the unstable luminous intensity.

➤ See page 136 for the setting procedure.

4

**Saving the settings**

Save the setting data. The following three methods can be used to save the data.

- **Press the [RUN/PROG] panel key or slide the mode selection slide switch on the remote control console up.**

When the CV-701(P)/751(P) enters **[RUN]** mode, the message **<REGISTER SET>** appears on the screen and the settings are saved in the internal memory.

- **Select [SAVE] in the menu screen.**

When the **[ENT]** key is pressed, the message **<REGISTER SET>** appears on the screen and the settings are saved in the internal memory.



- **Save the data in CompactFlash memory (Optional)**

➤ See “Chapter 7 CompactFlash Memory” on page 171 for the procedure.

**Note 1:** Do not turn the power off until the message “REGISTER SET” disappears.

**Note 2:** If the power is turned off before saving the settings, the setting data will be lost.

## 4.5 “AREA” Mode Advanced Settings

### 4.5.1 “AREA/CON” menu

#### AREA menu screen structure

The following is the layered structure of the parameters for the “ARE/CON” mode. The details of the parameters in 1. Main menu, 2. Window menu, and 3. Color menu are explained on the following pages.

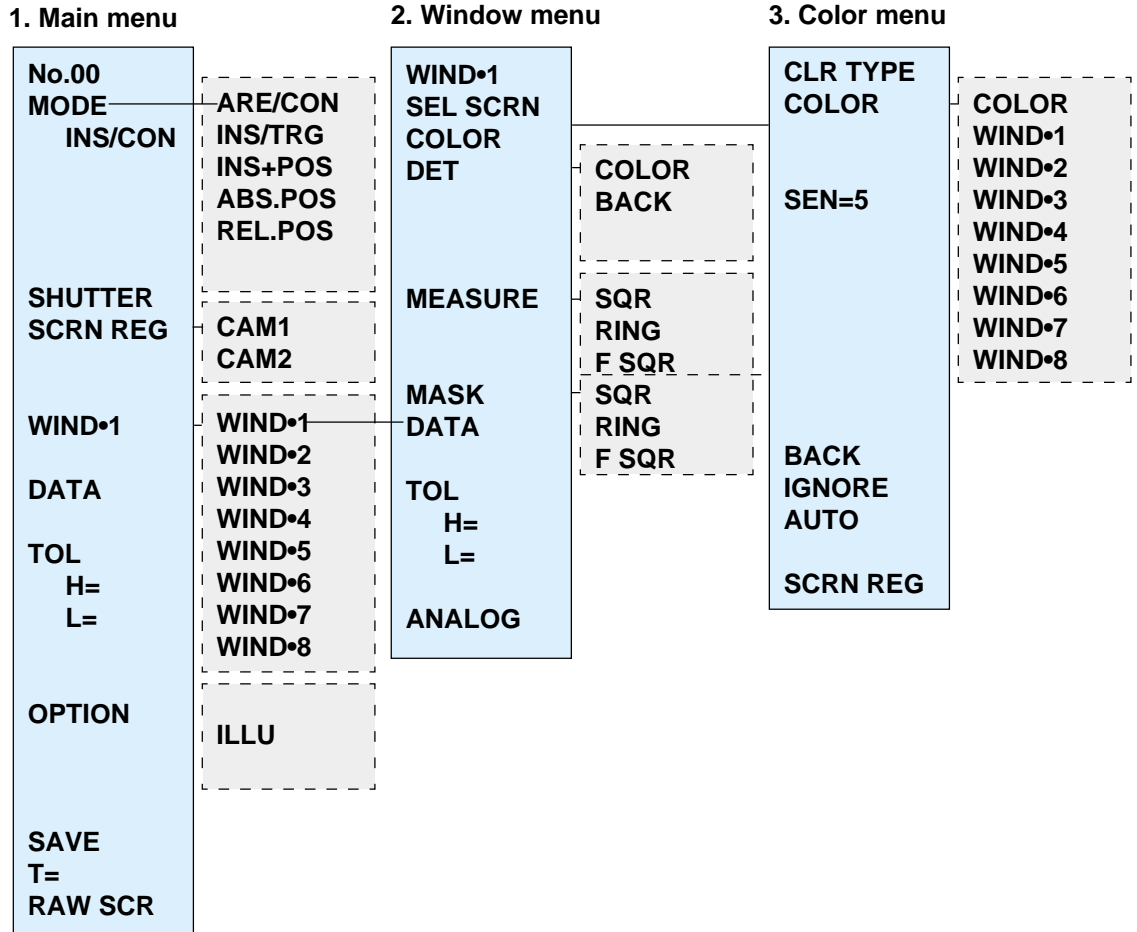

## Menu parameters

### 1. Main menu

“\*” indicates the initial setting value.

Parameter	Setting	Description	Function
PROGRAM	00* to 15	Program No. for the setting	Change the program No. to set several settings.
MODE			
SHUTTER	1/30 to 1/10000 (1/60*)	Shutter speed	Select a faster shutter speed when detecting a fast-moving target.
SCRN REG	N/Y	Register the reference screen.	Save a target image in the memory.
WIND• 1	To sub menu (For the details, refer to “2.”).	Set a measurement window and the color of a target.	Set details for detection.
DATA		Measured value display	Check the measured value.
TOL	H=000000 L=000000	Set the upper limit “H” and the lower limit “L” .	Set the measured data. (Units: pixels)
OPTION	To sub menu (For the details, refer to the respective sections).	Set the illumination adjustment function.	Set optional settings.
SAVE		Save the setting data.	Save the setting data in the memory.
T=000000		Processing time display	Check the processing time.
RAW SCR	RAW SCR*	The actual image captured by the camera.	Check the unprocessed image.
	PROCES1	Processed image for detection.	Check the detection condition.
	PROCES2	Processed image for detection.	Check the detection condition.
	PROCES3	Processed image for detection.	Check the detection condition.
	PROCES4	Processed image for detection.	Check the detection condition.

## 2. Window menu

“\*\*” indicates the initial setting value.

Parameter	Setting	Description	Function
WIND• 1	WIND• 1* to 8	Window No.	Change the window No. to set several windows.
SEL SCRΝ	CAM1*	Select the camera image for the screen registration.	When two cameras are connected.
	CAM2		
	CAM1 2		
	CAM1/2		
COLOR	To sub menu (For the details, refer to “3.”).	Set the colors to be extracted.	Extract colors for detection.
DET	COLOR*	Using the cursor, select the pixels to be extracted in colors on the screen.	Count pixels in the extracted color.
	BACK	Using the cursor, select the pixels to be extracted in the background on the screen.	Count pixels in the background.
MEASURE	SQR	Draw a square, circle or free square window on the screen.	Set the range to be measured.
	RING		
	F SQR		
MASK	SQR	Draw a square, circle or free square window on the screen.	Set the range not to be measured.
	RING		
	F SQR		
DATA		Measured value display	Check the measured value.
TOL	H=000000 L=000000	Set the upper limit “H” and the lower limit “L”.	Set the tolerance to judge whether the measured value is acceptable or unacceptable. (Units: pixels)
ANALOG	DATA H ANALOG H DATA L ANALOG L	Set the scaling value for analog output. ⇒ See page 166 for the setting procedure.	Output the measured value with the desired output voltage.

### 3. Color menu

“\*” indicates the initial setting value.

Parameter	Setting	Description	Function
CLR TYPE	COLOR*	Select the color extraction settings.	Change the extraction methods or copy the settings of other windows.
	WIND• 1 to 8		
SELECT		Move the cursor on the screen to select the colors to be extracted.	Extract the colors.
SEN	0 to 9 (5*)	Using the cursor, set the sensitivity for color range when selecting the extraction colors.	Change the color range to be extracted in one operation.
BACK	BL*	Set the background color.	When the detected image is not clear.
	WH		
IGNORE		Select colors not to be extracted.	Omit selected colors from those extracted.
AUTO		Automatically extend the range for color extraction.	Stabilize the color extraction.
SCRN REG	N/Y	Register the reference image.	Save the target image in the memory.

## 4.5.2 Advanced color settings

When the color extraction is not shown clearly, follow the procedure below to adjust the settings.

```

SEN =5
BACK
IGNORE
AUTO
  
```

### [BACK] (Background)

Set the background color to white or black for [PROCES1] set by the [PROGRAM] key. (The initial setting: [BL] (black)).

1. Place the cursor on [BACK] under [COLOR] and press the [ENT] key.

The cursor moves to [BL] or [WH].

```

SEN =5
BACK
IGNORE
  
```

2. Move the [ENT] key up or down to select [BL] or [WH].

```

BACK
BLACK
WHITE
  
```

3. Press the [ENT] key to confirm the selection.

The screen below the [PROCES1] screen with the background of [BL] or [WH].

[BL] (Black) background



[WH] (White) background

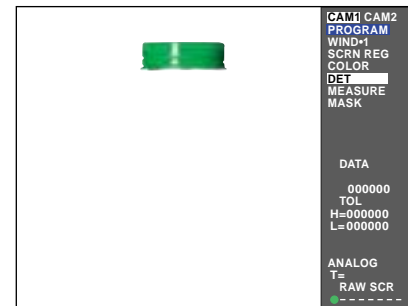

## 4.6 “INS” Mode Basic Settings

This section describes the basic settings using the “INS” (Inspection) mode.

### 4.6.1 “INS” Mode

In addition to the “AREA” detection described in the previous section, the “INS/TRG” (Inspection trigger) mode offers the following nine measurement modes. **Select the mode according to the application.**

- **OUTER (Outer edge)**

Measures the distance between the outermost edges in the window.

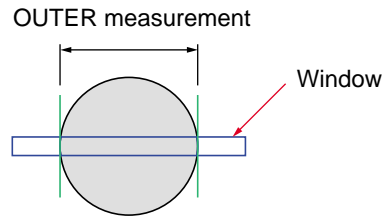

- **INNER (Inner edge)**

Measures the distance between the innermost edges in the window.

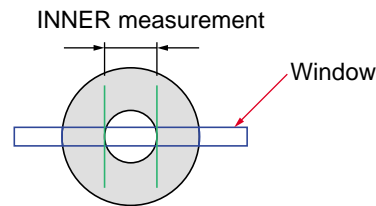

- **GAP**

Measures the distance between the odd-numbered edges and the even-numbered edges counted from the left (in horizontal scanning) or top (in vertical scanning) of the window. The maximum, minimum, and average values can be obtained.

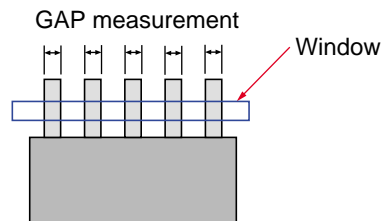

- **PITCH**

Measures the pitch values to obtain the maximum, minimum, and average values.

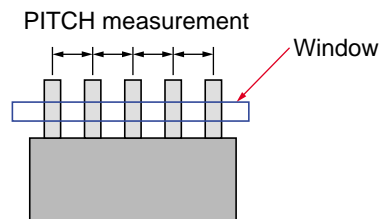



### ● EDGE NO (Edge count)

Counts the number of edges in the window

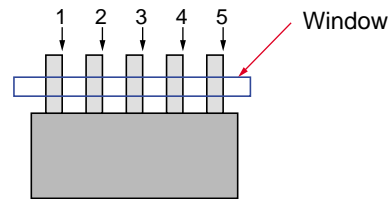

#### Tips

An edge is a point at which the brightness changes from bright to dark or from dark to bright on the color concentration screen.

### ● COUNT

Counts the number of clusters of extracted colors in the window. Up to 256 clusters can be counted.

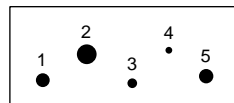

### ● POINT (Point sensor)

Detects the presence or absence of the extracted colors of the set point. Up to 8 points can be detected in a window.



### ● STAIN

Detects stains and defects in the window.

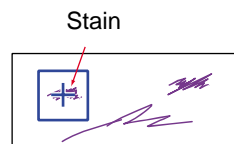

### ● GRAVITY

Detects the center of gravity and the angle of principal axis of a cluster of the extracted color.

The principal axis is the longitudinal angle of the cluster.

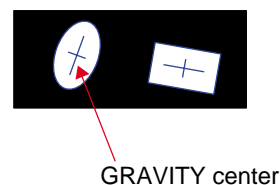

### 4.6.2 Initial menu screen

The following menu appears after “INS/TRG” is selected.

The screenshot shows a menu with the following text: CAM1 CAM2, PROGRAM, No.00, MODE, INS/TRG, SHUTTER, SCR N REG, WIND•1, INSPECT AREA, DATA 000000, TOL H=000000 L=000000, OPTION SAVE, T=, RAW SCR. At the bottom, there are four indicators: a green dot, a red dot, a white circle, and a dash.

**Program No.**  
Up to 16 programs (Nos. 00 to 15) can be registered.

**Shutter speed**  
Changes shutter speed.

**Window**  
Sets a window for detection.

**Mode**  
Allows selection from five measurement modes.

**Screen registration**  
Registers the image for setting.

**Measured value**  
Displays the measured value of the window. (Units: pixels)

**Tolerance**  
Sets the allowable range of the detection results. (Units: pixels)

**Option**  
Sets the stored screen, illumination adjustment, and data conversion

**SAVE**  
Saves the settings.

**Screen selection**  
Shows the current screen type. (Raw screen, Processed screen 1/2/3/4)

**Processing time**  
Displays the processing time for each screen. (Units: ms)

**Detection result**  
The indicator shows the detection result for each window (8 windows max.). The light farthest to the left represents window 1, and the light farthest to the right represents window 8.

- (Green): Within tolerance
- (Red): Outside of tolerance
- (White): No detection
- : The window has not been determined.

### 4.6.3 Basic setting flow

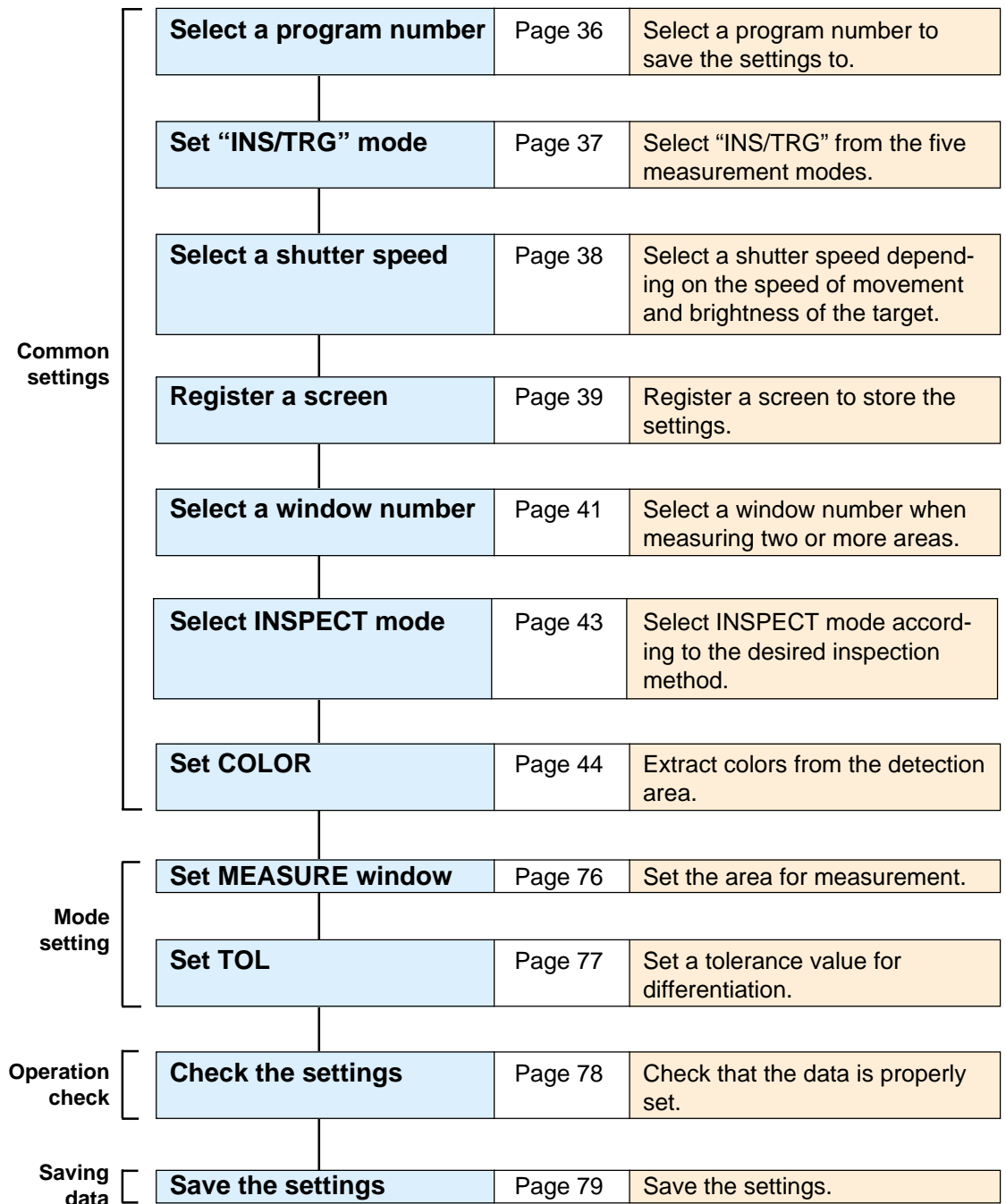

⇒ For common settings, refer to "4.3 Basic Settings: Basic setting procedures" on page 36.

## Setting parameters

The parameters in bold type are described in the basic setting procedures.

- ▷ See "4.7 "INS" Mode Advanced Settings" on page 96 for other parameters.
- ▷ See "Basic Settings" on page 36 for the parameters in bold.

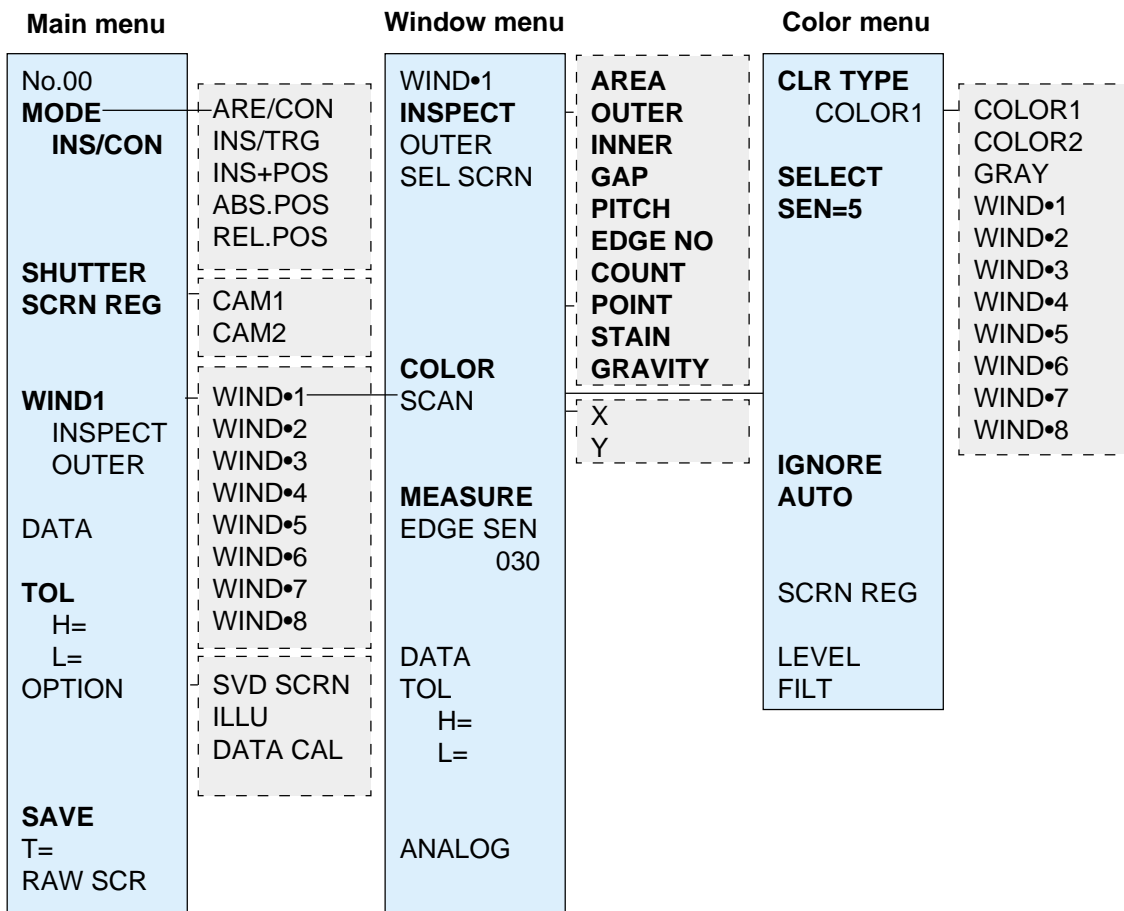

### ■ Screen type sequence

Pressing the [SCREEN] key shows the following sequence.

- When AREA or COUNT is selected

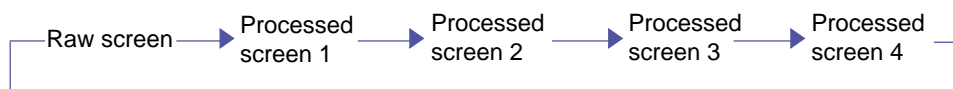

- \* When OUTER, INNER, GAP, PITCH, EDGE NO, or STAIN is selected

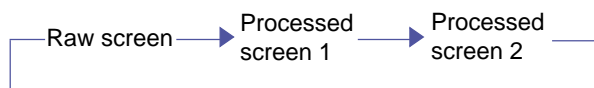

- \* When COUNT or GRAVITY is selected

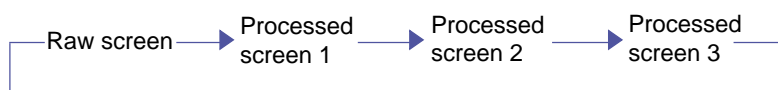

#### 4.6.4 Basic setting procedure for the measurement mode

You can select a measurement mode best suited for your application from the following five modes: [OUTER], [INNER], [GAP], [PITCH], and [EDGE NO].

1. First follow the “Basic setting procedures” (⇨ page 36) to set the parameters to the color settings.

2. Select the edge type and scanning direction for measurement.

- 1) Place the cursor on [SCAN] and press the [ENT] key. The [SCAN] menu appears.



- 2) Select the scanning direction with the cursor.

[X]: Scan in the horizontal direction on the screen.

[Y]: Scan in the vertical direction on the screen.

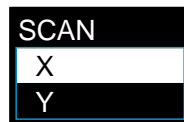

- 3) Press the [ENT] key to confirm the selection.

● When [INSPECT] is set to [EDGE NO]

Place the cursor on [SCAN] and press the [ENT] key. The edge menu appears.



Place the cursor on the desired option and press the [ENT] key.

- [BL → WH]: Count the edge at which the image changes from dark to bright when scanned from the left or top of the color screen.
- [WH → BL]: Count the edge at which the image changes from bright to dark when scanned from the left or top of the color screen.



### 3. Set [MEASURE] (Measurement window)

Specify the size of the window used for measurement. (Example: Setting for OUTER mode)



- 1) Place the cursor on [MEASURE] and press the [ENT] key. A frame appears on the screen.

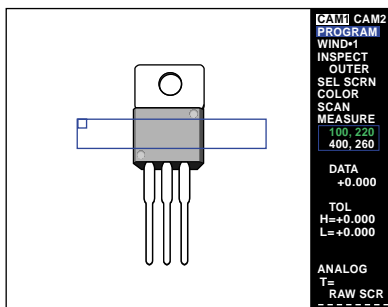

- 2) Move the cursor to enclose the desired area for measurement.

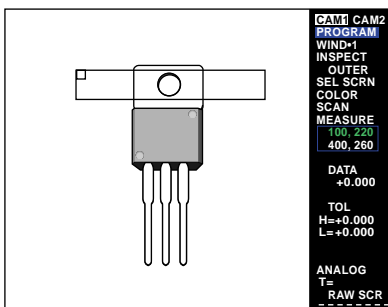

The window drawing mode changes as shown below every time the [ENT] key is pressed.

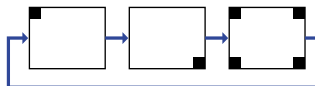

- 3) After setting the size and position of the window, press the [ESCAPE] key to exit the [MEASURE] setting.

#### 4. Set [TOL] (Tolerance)

Set the upper limit "H=" and the lower limit "L=" of the tolerance.

- 1) First, set the upper limit. Place the cursor on **[H=0.000]** under **[TOL]** and press the [ENT] key. The first digit, "0", is shown as highlighted. You can enter a numerical value.

```
TOL
H=+0.000
L=+0.000
```

- 2) Change the value.

```
TOL
H=+0.000
L=+0.000
```

- **With the panel keys**

Press the "▲" cursor key repeatedly.

```
TOL
H=+0.000
L=+0.000
```

- **With the remote control console**

Move the [ENT] key up repeatedly. The value increments by one from "0". After "9", the second digit is incremented.

```
TOL
H=+150.0
L=+0.000
```

When the "▼" cursor key is pressed or the [ENT] key is moved down, the value decrements by one to 0.

- 3) Press the [ENT] key to confirm the input value.
- 4) Place the cursor on **[L=000000]** (lower limit) under **[TOL]** and change the value for the lower limit using the same procedure as for the upper limit.

```
TOL
H=+150.0
L=+0.000
```

#### Tips

- When you cannot determine the tolerance value, refer to the measurement value displayed in "Operation check after changing the settings" described in the following pages.
- The upper limit cannot be smaller than the lower limit.

The setting for WIND•1 is complete.

You can set up to eight windows for a single program number.

To set several windows, select another window number and repeat the above procedure.

## Operation check after changing the settings

1. Press the [ESCAPE] key to return to the initial menu screen.
2. Press the [TRIGGER] key.
  - When [INSPECT] mode is set to [OUTER] or [INNER], the screen shows two lines indicating the detected edges. (The illustration below shows the screen for [OUTER].)

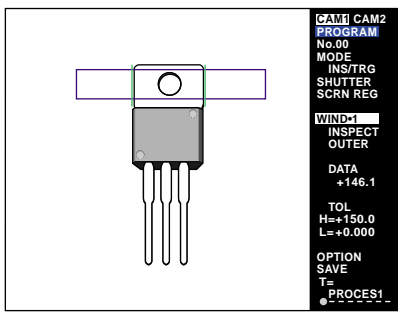

- When [INSPECT] mode is set to [GAP] or [PITCH], the screen shows all detected edges. (The illustration below shows the screen for [PITCH].)

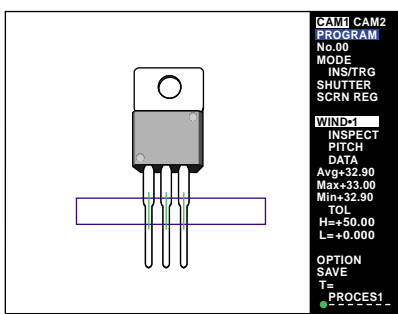

- When [INSPECT] is set to [EDGE NO], the screen shows all detected edges.

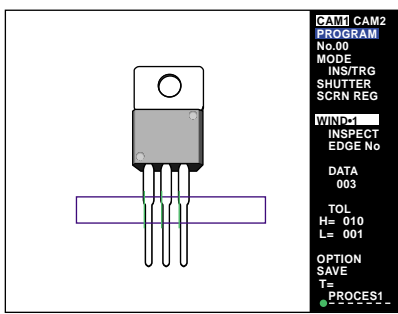

**Tips** When edge detection is unstable, adjust the detection sensitivity to optimize the detection. (↪ See page 100.)



### 3. Check the detection result indicator.

Green: Acceptable (The measured value is within the tolerance range.)

Red: Unacceptable (The measured value is outside of the tolerance range.)

White: No detection (The trigger signal is not input.)

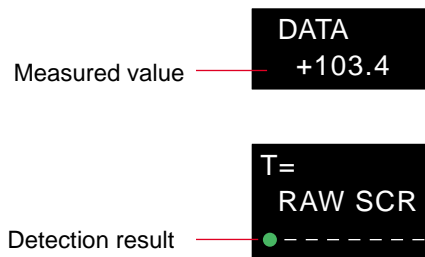

## Saving the settings

Save the setting data. The following three method can be used to save data.

- Press the [RUN/PROG] panel key for at least two seconds or slide the mode selection slide switch on the remote control console up.**  
 When the CV-701(P)/751(P) enters [RUN] mode, the message <REGISTER SET> appears on the screen and the settings are saved in the internal memory.
- Select [SAVE] in the menu screen.**  
 When the [ENT] key is pressed, the message "REGISTER SET" appears on the screen and the settings are saved in the internal memory.

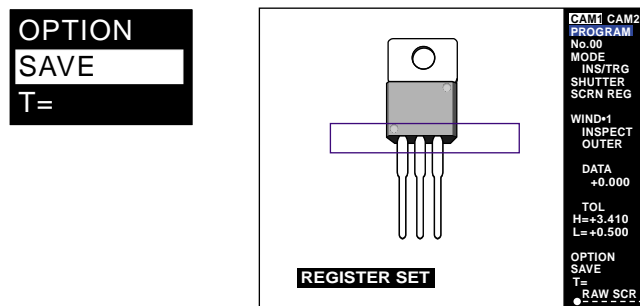

- Save the data in CompactFlash memory (Optional)**

☞ See "Chapter 7 CompactFlash Memory" on page 171 for the procedure.

**Note 1:** Do not turn the power off until the message "REGISTER SET" disappears.

**Note 2:** If the power is turned off before saving the settings, the setting data will be lost.

### 4.6.5 Basic setting procedure for COUNT

Count the number of targets in the measured area. One cluster of extracted color is counted as one target. Measurement is operated for the entire area inside the window. This section describes the basic setting procedure for the "COUNT" mode.

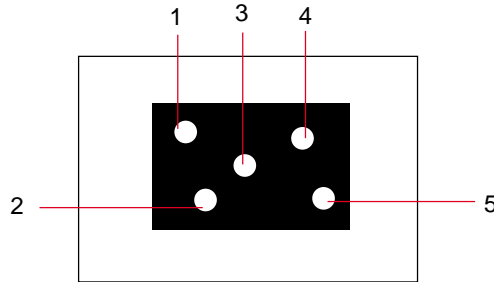

1. First follow the "Basic setting procedures" (⇒ page 36) to set the parameters to the color settings.

2. Set [MEASURE] (Measurement window)

Specify the size of the window used for measurement.

- 1) Place the cursor on [MEASURE] and press the [ENT] key. The window selection menu appears.
- 2) Select the shape of the window from [SQR] (square) or [CIRC] (circular).

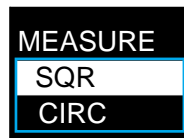

3) Press the [ENT] key. A frame appears on the screen. The screen below shows the frame when [CIRC] is selected.

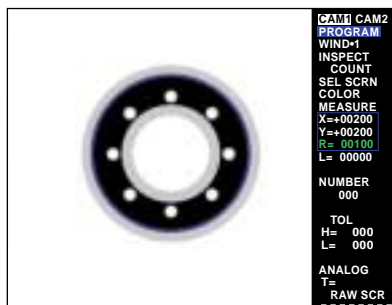

4) Move the cursor to enclose the desired area for measurement.

**Note:** Up to 256 targets can be counted in one MEASURE window. To count more targets, set two or more windows.

5) The window drawing mode changes as follows every time the [ENT] key is pressed.

Square window

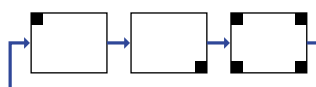

Circular window

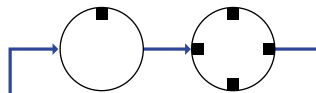

**Tips****To change the window shape**

Selecting SQR or CIRC is available only when the window is not drawn. To change the shape to another selection (square or circle) after drawing the window, clear the current window. To clear, move cursor to **[MEASURE]** and hold **[CLEAR]** key for at least 2 seconds.

- 6) After setting the size and position of the window, press the **[ESCAPE]** key to exit the **[MEASURE]** setting.

**■ Mask window**

When a mask window (**[MASK]**) is overlapped with a measurement window, the area inside of the mask window is omitted from the measurement. Draw a mask window using the same procedure as for a measurement window.

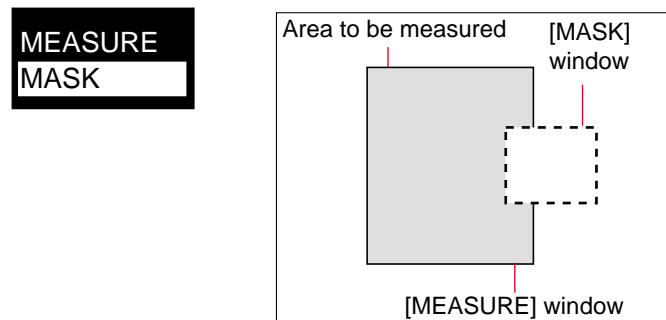
**3. Set [TOL] (Tolerance)**

Set the upper limit "H=" and the lower limit "L=" of the tolerance. The unit is the number of targets counted.

- 1) First, set the upper limit.

Place the cursor on **[H=000]** under **[TOL]** and press the **[ENT]** key. The first digit, "0", is shown as highlighted. You can enter a numerical value.

```
TOL
H= 000
L= 000
```

- 2) Move the cursor to the left or right to select the digit to be changed.

```
TOL
H= 000
L= 000
```

- 3) Change the value.

- **With the panel keys**  
Press the “▲” cursor key repeatedly.
- **With the remote control console**  
Move the [ENT] key up repeatedly. The value increments by one from “0”. After “9”, the second digit is incremented.  
When the “▼” cursor key is pressed or the [ENT] key is moved down, the value decrements by one to 0.

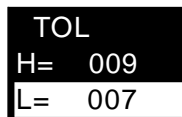

- 4) Press the [ENT] key to confirm the input value.
- 5) Place the cursor on [L=000] (lower limit) under [TOL], and change the value for the lower limit using the same procedure as for the upper limit.

The basic setting for the COUNT mode is completed.

### Operation check after changing the settings

1. Press the [ESCAPE] key to return to the initial menu screen.
2. Press the [TRIGGER] key.
  - Cursor for all the counted targets appear on the screen.

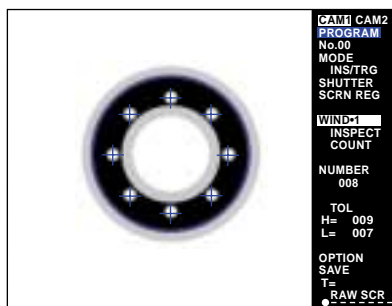

**Tips**

- You can omit the undesired noise and/or stains in the window from counting by using “AREAFILT” (Area filter). (⇒ page 101)
- “FILTER” is also available for the setting. (⇒ page 103)

### 3. Check the detection result indicator.

Green: Acceptable (The measured value is within the tolerance range.)  
 Red: Unacceptable (The measured value is outside of the tolerance range.)  
 White: No detection (The trigger signal is not input.)

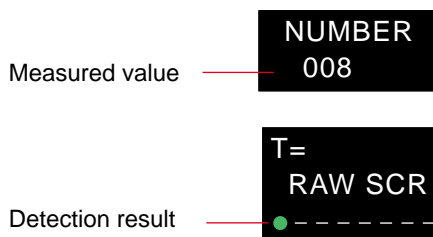

## Saving the settings

Save the setting data. The following three method can be used to save the data.

- **Press the [RUN/PROG] panel key for at least two seconds or slide the mode selection slide switch on the remote control console up.**

When the CV-701(P)/751(P) enters [RUN] mode, the message <REGISTER SET> appears on the screen and the settings are saved in the internal memory.

- **Select [SAVE] on the menu screen.**

When the [ENT] key is pressed, the message “REGISTER SET” appears on the screen and the settings are saved in the internal memory.

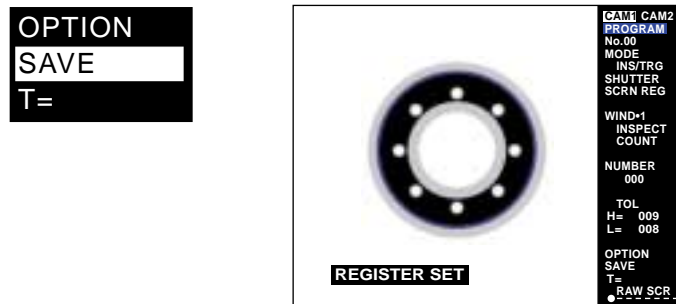

- **Save the data in CompactFlash memory (Optional)**

☞ See “Chapter 7 CompactFlash Memory” on page 171 for the procedure.

**Note 1:** Do not turn the power off until the message “REGISTER SET” disappears.

**Note 2:** If the power is turned off before saving the settings, the setting data will be lost.

### 4.6.6 Basic setting procedure for the POINT (Point sensor) mode

Detects the presence or absence of a target. Judges by the presence or absence of the extracted color at the set points. Up to eight points can be measured with a window.

This section describes the basic setting procedure for "POINT" mode.

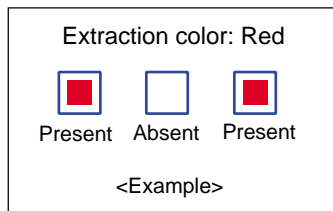

1. First follow the "Basic setting procedures" (⇒ page 36) to set the parameters to the color settings.

2. Set the size for measurement.

Set the size of the measurement point.

- 1) Place the cursor on [SIZE]. Select a size best suited for the area to be detected. Select the size from 4/8/16 pixels.



- 2) Press the [ENT] key. The size menu appears.
- 3) Move the cursor to select a desired size and press the [ENT] key to confirm the selection.

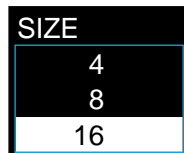

3. Select the measurement points

Set up to eight points to be measured. (Up to 64 points can be measured with eight windows.)

- 1) Place the cursor on [POINT].



- 2) Press the [ENT] key. The SEL POINT (Point selection) menu appears.

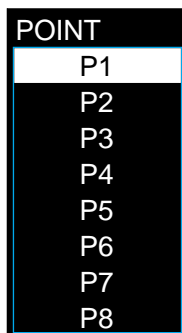

#### Tips

A point with "●" indicates that the point is already being used.

- 3) Move the cursor to determine a desired point and press the [ENT] key. A point frame is displayed in red on the screen.

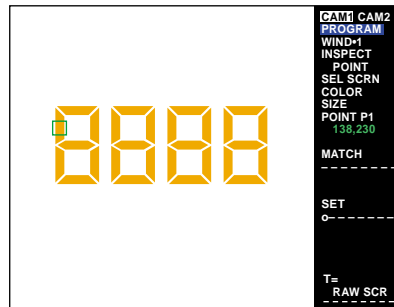

- 4) Move the point frame to a desired point for detection, and press the [ENT] key to confirm the setting.

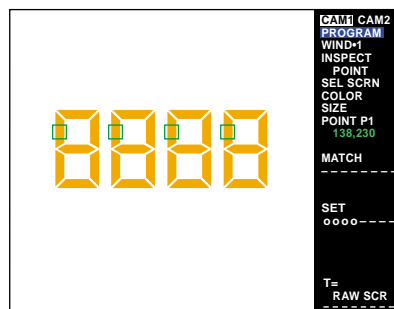

- 5) Repeat the procedure (steps 3 and 4) to set all points.

#### 4. Set the presence/absence

Set the acceptable/unacceptable judgment from the presence/absence of the extracted colors within the point frames.

The display farthest to the left indicates the result of P1, and the display farthest to the right indicates the result of P8.

Present: ○      Absent: x      No detection: –

The displays in green indicate that the presence/absence settings match the result. The displays in red indicate that the settings do not match the result.



- 1) Place the cursor on [SET] and press the [ENT] key.

The setting parameter for P1 is highlighted, and the setting becomes available.



2) Move the cursor to select the desired point.



3) Change the setting.

Press the [▲]/ [▼] panel keys or move the [ENT] key up and down on the remote control console to change the setting.

4) Press the [ENT] key.

The cursor returns to [SET]. Repeat the above procedure (steps 1 to 3) to change two or more point settings.

The basic setting for the POINT mode is complete.

**Note:** The detection result output is an OR output based on the MATCH results of P1 to P8.

4

### Operation check after changing the settings

1. Press the [ESCAPE] key to return to the initial menu screen.
2. Press the [TRIGGER] key.

- [MATCH] displays the measurement result for each point. (Green: acceptable, Red: unacceptable.)



**Tips**

Change "BACK" settings (background color) when the color extraction is not shown clearly. (⇒ page 102)

### Saving the settings

Save the setting data. The following three can be used to save the data.

- **Press the [RUN/PROG] panel key for at least two seconds or slide the mode selection slide switch on the remote control console up.**  
When the CV-701(P)/751(P) enters [RUN] mode, the message <REGISTER SET> appears on the screen and the settings are saved in the internal memory.
- **Select [SAVE] on the menu screen.**  
When the [ENT] key is pressed, the message "REGISTER SET" appears on the screen and the settings are saved in the internal memory.

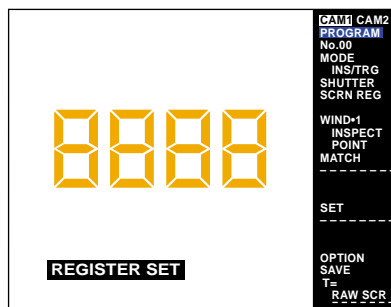

- **Save the data in CompactFlash memory (Optional)**  
⇒ See "Chapter 7 CompactFlash Memory" on page 171 for the procedure.

**Note 1:** Do not turn the power off until the message "REGISTER SET" disappears.

**Note 2:** If the power is turned off before saving the settings, the setting data will be lost.



## 4.6.7 Basic setting procedure for the STAIN mode

Use the STAIN mode to detect stains in the window.  
Select a window shape from circle, square, circumference, and arc.

- 1) Set a small area in the window. The small area is called a "segment". The average brightness is measured for each segment. (Change the size of segments with [SIZE].)

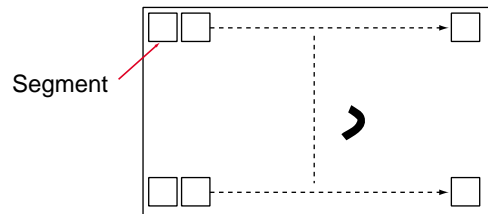

- 2) Measure all of the segments for brightness differentials between adjacent segments. The maximum differential in the window is measured.
- 3) When the measured value exceeds the set level, the stain is judged as unacceptable (defective).

This section describes the basic setting procedure for the STAIN mode.

**1. First follow the "Basic setting procedures" (⇨ page 36) to set the parameters to the color settings.**

**2. Set [MEASURE] (Measurement window)**

Specify the size of the window used for measurement.

- 1) Place the cursor on [MEASURE] and press the [ENT] key. The window selection menu appears.
- 2) Select the shape of the window from [SQR] (square), [CIRC] (circle), [RING] (circumference), and [ARC] (arc).



- 3) Press the [ENT] key. A frame appears on the screen. The screen below shows the frame when [CIRC] is selected.

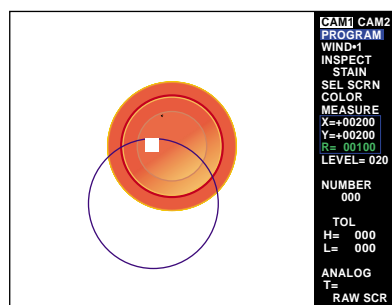

4) Move the cursor to enclose the desired area for measurement.

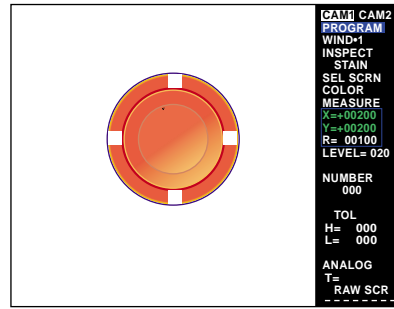

5) The window drawing mode changes as follows every time the [ENT] key is pressed.

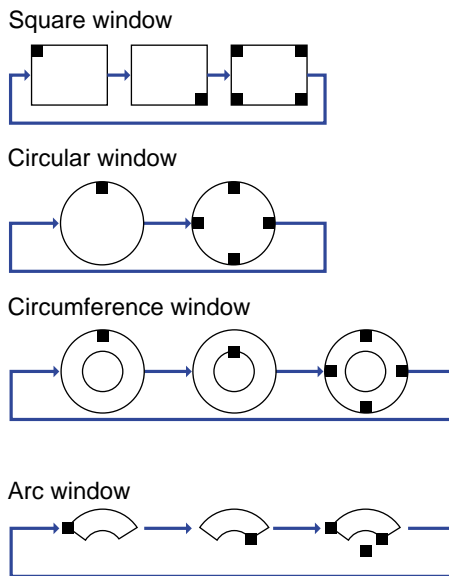

**Tips**

**To change the window shape**

Selecting SQR, CIRC, RING or ARC is available only when the window is not drawn. To change the shape to another selection (square, circle, circumference or arc) after drawing the window, clear the current window. To clear, move cursor to **[MEASURE]** and hold **[CLEAR]** for at least 2 seconds.

6) After setting the size and position of the window, press the [ESCAPE] key to exit the **[MEASURE]** setting.

**3. Set the segment size**

Select a value to change the sensitivity for stain detection. The smaller values offer more sensitivity for small stains.

Smaller	←	Value	→	Greater
Higher	←	Sensitivity	→	Lower

**Tips**

Enhancing the sensitivity extends the processing time and makes it difficult for the system to respond to high-speed production lines. Eliminate wasted time and select optimal values.

The size is the area in the measurement window to be detected in sequence.

1) Place the cursor on **[SIZE]** and press the [ENT] key.

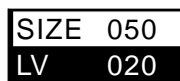

## 2) Change the values.

Move the cursor keys or the [ENT] key up and down to change the values.

```
SIZE 050
LV 020
```

## 3) Press the [ENT] key to confirm the setting.

```
SIZE 030
LV 020
```

## 4. Select the level

When the measured values exceed the [LEVEL] value, the target is judged as unacceptable (defective). The measured value is the brightness differential of the detected areas.

## 1) Select the upper limit.

Place the cursor on [LV] and press the [ENT] key. The first digit is highlighted. You can input a numerical value for the first digit.

```
LV 020
```

## 2) Move the cursor to select the desired digit.

```
LV 020
```

## 3) Change the values.

Move the cursor keys or the [ENT] key up and down to change the values.

```
LV 090
```

## 4) Press the [ENT] key to confirm the LEVEL value.

The basic setting for the [STAIN] mode is completed.

## Operation check after changing the settings

## 1. Press the [ESCAPE] key to return to the initial screen.

## 2. Press the [TRIGGER] key.

The measurement cursor appears on the area with stains.

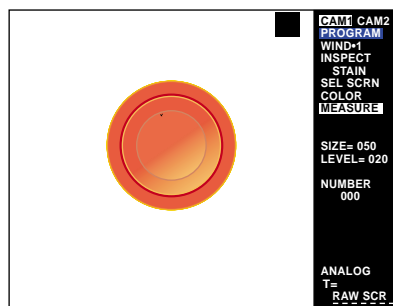

### Tips

- When stains and defects are not detected properly, go back to “Select the size” (⇒ page 88) to readjust the SIZE.
- When stains and defects are not extracted properly, use the filter function. (⇒ page 103)

**3. Check the detection result indicator.**

Green: Acceptable (The measured value is within the tolerance range.)  
 Red: Unacceptable (The measured value is outside of the tolerance range.)  
 White: No detection (The trigger signal is not input.)

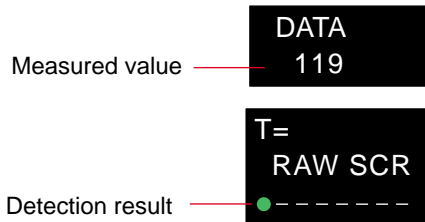

**Saving the settings**

Save the setting data. The following three can be used to save the data.

- **Press the [RUN/PROG] panel key for at least two seconds or slide the mode selection slide switch on the remote control console up.**  
 When the CV-701(P)/751(P) enters [RUN] mode, the message <REGISTER SET> appears on the screen and the settings are saved in the internal memory.
- **Select [SAVE] on the menu screen.**  
 When the [ENT] key is pressed, the message “REGISTER SET” appears on the screen and the settings are saved in the internal memory.

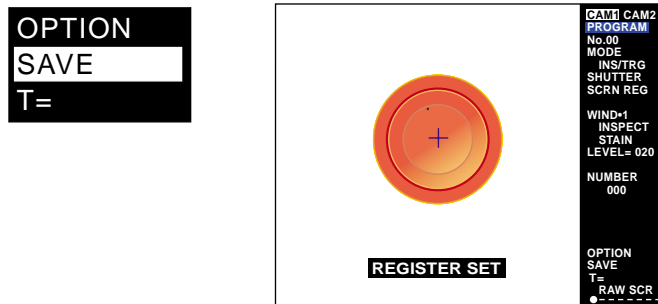

- **Save the data in CompactFlash memory (Optional)**  
 ☞ See “Chapter 7 CompactFlash Memory” on page 171 for the procedure.

**Note 1:** Do not turn the power off until the message “REGISTER SET” disappears.  
**Note 2:** If the power is turned off before saving the settings, the setting data will be lost.

### 4.6.8 Basic setting procedure for the GRAVITY mode

Use the “GRAVITY” mode to determine the center of gravity and the angle of principal axis for the extracted area in the binary-converted image data.

Center of gravity: A point at which the target object is supported to be kept in balance.

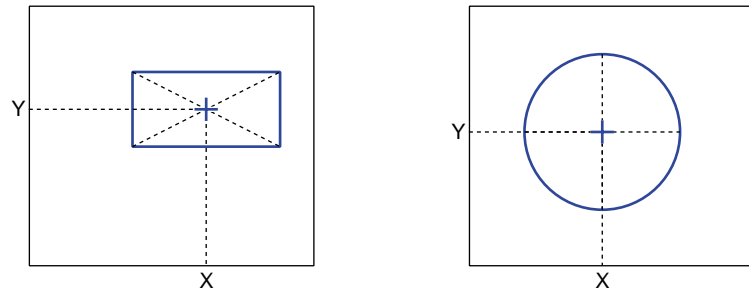

The X-/Y-coordinates of the center of gravity are determined on the screen.

Angle of principal axis: The longitudinal angle ( $\theta$ ) of a target.

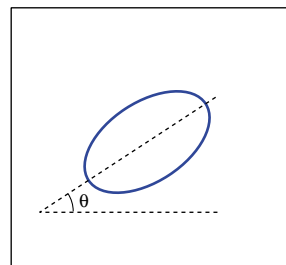

**Note:** According to the operation principles, detection will be unstable under the following conditions.

- When the cluster of extracted colors spreads across the MEASURE window.
- When two or more clusters with a similar size exist in the MEASURE window.
- When the principal axis is not determined. (e.g. square and circular objects)

This section describes the basic setting procedure for the [GRAVITY] mode.

**1. First follow the “Basic setting procedures” (⇨ page 36) to set the parameters to the color settings.**

**2. Set [MEASURE] (Measurement window)**

Specify the size of the window used for measurement.

- 1) Place the cursor on **[MEASURE]** and press the [ENT] key. The window selection menu appears.
- 2) Select the shape of the window from **[SQR]** (square) and **[CIRC]** (circular).

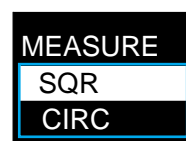

- 3) Press the [ENT] key. A frame appears on the screen. The screen below shows the frame when [SQR] is selected.



- 4) Move the cursor to enclose the desired area for measurement.



- 5) The window drawing mode changes as follows every time the [ENT] key is pressed.

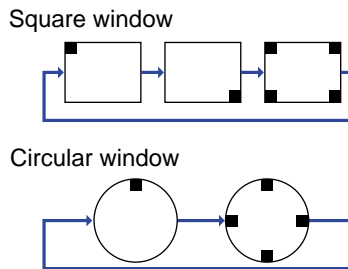

**Tips**

**To change the window shape**

Selecting SQR or CIRC is available only when the window is not drawn. To change the shape to another selection (square or circular) after drawing the window, clear the current window. To clear, move cursor to [MEASURE] and hold [CLEAR] for at least 2 seconds.

**Note 1:** When two or more targets enter the MEASURE window, the target with the greatest area is measured.

**Note 2:** Be sure the [MEASURE] window does not come into contact with the targets.

- 6) After setting the size and position of the window, press the [ESCAPE] key to exit the [MEASURE] setting.

### ■ Mask window

When a mask window (**[MASK]**) is overlapped with a measurement window, the area inside of the mask window is omitted from the measurement. Draw a mask window using the same procedure as for a measurement window.

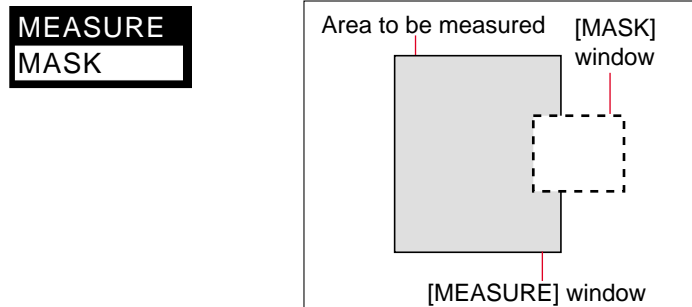

### 3. Set the TOL (Tolerance) of the coordinates

Set the allowable range (upper and lower limits) for the X and Y coordinates. Set the tolerance for each displayed value.

- 1) Place the cursor on **[TOL]** and press the **[ENT]** key. The **TOL** window appears.
- 2) Place the cursor on **[X=xxx]** under **[TOL]** and press the **[ENT]** key. The value for the first digit is shown as highlighted. You can enter a numerical value.

```
TOL
X=+0.000
  =+0.000
Y=+0.000
  =+0.000
```

- 3) Press the **[▲]/[▼]** cursor keys (panel key) or press the **[ENT]** key up or down to change the value.
  - When the **[ENT]** key is moved up repeatedly, the value increments by one from "0". After "9", the second digit is incremented.
  - The setting range is  $\pm 99999$ .

```
TOL
X=+0.000
  =+0.000
Y=+0.000
  =+0.000
```

- 4) Press the **[ENT]** key to confirm the tolerance value.

```
TOL
X=+50.00
  =+0.000
Y=+10.00
  =+0.000
```

### 4. Set the **[TOL]** of the angle

Set the allowable range (upper and lower limits) for the angle of the principal axis (the longitudinal angle of the cluster). The units are degrees.

- 1) Place the cursor on **[TOL]** and press the **[ENT]** key. The **TOL** window appears.

- Place the cursor on "ANG=180" (the upper limit of tolerance for the angle), and press the [ENT] key. The value for the first digit is shown as highlighted. You can enter a numerical value.

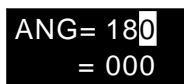

- Press the [▲]/[▼] cursor keys (panel key) or press the [ENT] key up or down to change the value.

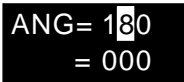

- Press the [ENT] key to confirm the tolerance value.
- Set the lower limit of the tolerance for the angle following the same procedure for the upper limit.

The basic setting for the GRAVITY mode is complete.

## Operation check after changing the settings

4

- Press the [ESCAPE] key to return to the initial menu screen.
- Press the [TRIGGER] key.
  - Cross-shaped cursors appear on the center of gravity in the orientation of the angle of the principal axis.

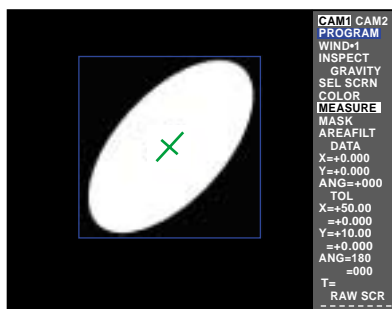

**Tips**

- You can omit the undesired noise and/or stains in the window from counting by using "AREAFILT" (Area filter). (⇨ page 101)
- "FILTER" is also available for the setting. (⇨ page 103)

### 3. Check the detection result indicator.

Green: Acceptable (The measured value is within the tolerance range.)  
 Red: Unacceptable (The measured value is outside of the tolerance range.)  
 White: No detection (The trigger signal is not input.)

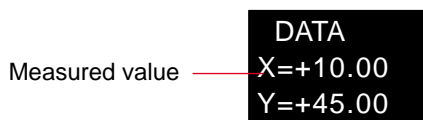



## Saving the settings

Save the setting data. The following three can be used to save the data.

- **Press the [RUN/PROG] panel key for at least two seconds or slide the mode selection slide switch on the remote control console up.**

When the CV-701(P)/751(P) enters [RUN] mode, the message <REGISTER SET> appears on the screen and the settings are saved in the internal memory.

- **Select [SAVE] on the menu screen.**

When the [ENT] key is pressed, the message “REGISTER SET” appears on the screen and the settings are saved in the internal memory.

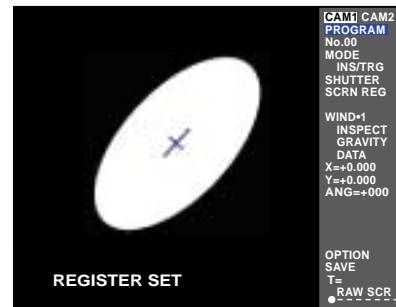

- **Save the data in CompactFlash memory (Optional)**

☞ See “Chapter 7 CompactFlash Memory” on page 171 for the procedure.

**Note 1:** Do not turn the power off until the message “REGISTER SET” disappears.

**Note 2:** If the power is turned off before saving the settings, the setting data will be lost.

## 4.7 “INS” Mode Advanced Settings

### 4.7.1 “INS/TRG” menu

#### Menu structure

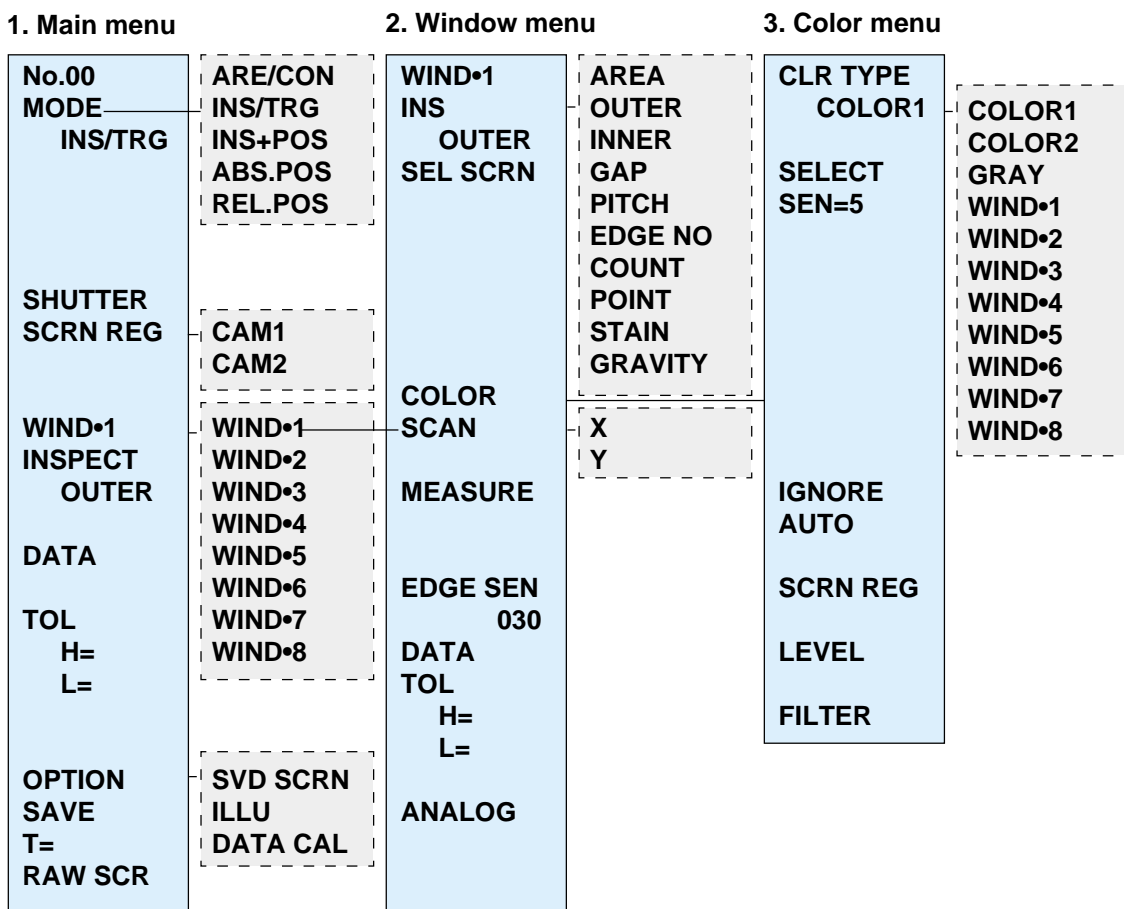

4

## 1. Main menu

\*\*\* indicates the initial setting value.

Parameter	Setting	Description	Function
PROGRAM	00* to 15	Program No. for the setting	Change the program No. to set several settings.
MODE			
SHUTTER	1/30 to 1/10000 (1/60*)	Shutter speed	Select a faster shutter speed when detecting a fast-moving target.
SCRN REG	N/Y	Register the reference screen.	Save a target image in the memory.
WIND• 1	To sub menu (Refer to “2.” for details).	Set the INS mode, target color, and detection window.	Set details for detection.
INSPECT		INS mode display	Check the INS mode for the selected window.
DATA		Measured value display	Check the measured value.
TOL	H=000000 L=000000	Set the upper limit “H” and the lower limit “L” .	Set the measured data. (Units: pixels)
OPTION	To sub menu (Refer to respective sections for details.)	Set the illumination adjustment function.	Set optional settings.
SAVE		Save the setting data.	Save the setting data in the memory.
T=000000		Processing time display	Check the processing time.
RAW SCR	RAW SCR*	The actual image captured by the camera.	Check the unprocessed image.
	PROCES1	Processed image for detection.	Check the detection condition.
	PROCES2	Processed image for detection.	Check the detection condition.
	PROCES3	Processed image for detection.	Check the detection condition.
	PROCES4	Processed image for detection.	Check the detection condition.



## 3. Color menu

“\*\*” indicates the initial setting value.

Parameter	Setting	Description	Function
CLR TYPE	COLOR	Select the color extraction settings.	Change the extraction methods or copy the settings of other windows.
	COLOR1		
	COLOR2		
	GRAY		
	WIND1 to 8		
	POS ADJ1 to 2		
SELECT		Move the cursor on the screen to select the colors to be extracted.	To extract the colors.
SEN	0 to 9 (5*)	Set the sensitivity for the color range when selecting the extraction colors by using the cursor.	Change the color range to be extracted in one operation.
BACK	BL*	Set the background color.	When the detected image is not clear.
	WH		
IGNORE		Select colors not to be extracted.	Omit selected colors from those extracted.
AUTO		Automatically extend the range for color extraction.	Stabilize the color extraction.
SCRN REG	N/Y	Register the reference image.	Save the target image in the memory.
LEVEL		Select a level for color extraction.	Manually select a level for color extraction.
FILTER	11 types	Select a filter. (↪ See page 103 for details.)	Omit the noise or optimize detection.

## 4.7.2 Sensitivity adjustment for edge detection

### Adjust the sensitivity for edge detection

When edge detection is unstable (e.g. some edges are not detected or unnecessary edges are detected), adjust the sensitivity to optimize detection.

1. Place the cursor on [EDGE SEN] (Edge sensitivity) in the window menu and press the [ENT] key.

The first digit is shown as highlighted.



2. Move the [ENT] key up or down to change the value for [EDGE SEN].

- The change in the value for [EDGE SEN] is reflected in the edge detection status on the monitor screen. Set the optimal sensitivity while watching the monitor.
- A larger value for [EDGE SEN] decreases the sensitivity, and a smaller value increases the sensitivity.

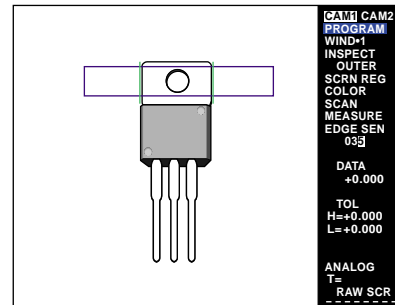

### 4.7.3 Adjustment for the COUNT and GRAVITY modes

#### Adjusting the [AREAFILT]

When unnecessary areas are detected with the [COUNT] or [GRAVITY] mode, adjust the area filter to detect only the clusters of desired size.

Select the upper and lower limit for the area filter.

[H=xxx] shows the upper limit, and [L=xxx] shows the lower limit.

Parameter	Description
H=xxx	Clusters with a greater number of pixels than "H" are not counted.
L=xxx	Clusters with a smaller number of pixels than "L" are not counted.

#### 1. Set the upper limit.

Place the cursor on [H=xxx] under [AREAFILT] in the window menu, and press the [ENT] key.

```
AREAFILT
H= 65535
L = 00100
```

#### 2. The first digit is shown as highlighted. Change the value for the upper limit of AREFILT by pressing [▲]/[▼] cursor keys.

```
AREAFILT
H= 65535
L = 00100
```

#### 3. Press the [ENT] key to confirm the setting.

Press the [TRIGGER] key after pressing the [ENT] key to check the detection status. Select the optimal value while watching the monitor.

```
AREAFILT
H= 03000
L = 00100
```

#### 4. Set the lower limit.

Place the cursor on [L=xxx] and follow the above procedure (1 to 3).

### 4.7.4 Advanced COLOR setting

When the color extraction is not shown clearly, adjust the setting with the menu as shown below.

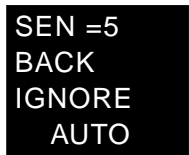

#### [BACK]

When [PROCES1] is selected with the [SCREEN] key, change the background color to white or black. (The initial setting is [BL] (Black).)

1. Place the cursor on [BACK] under [COLOR] menu and press the [ENT] key.

The cursor moves to [BL] or [WH].

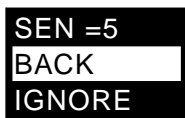

2. Press the [ENT] key up or down to select [BL] or [WH].

The screens below are the [PROCES1] screens with a [BL] or [WH] background.



[PROCES1] with a "BL" background

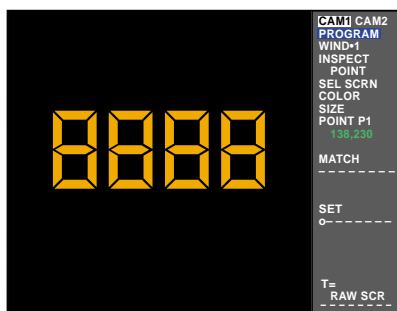

[PROCES1] with a "WH" background

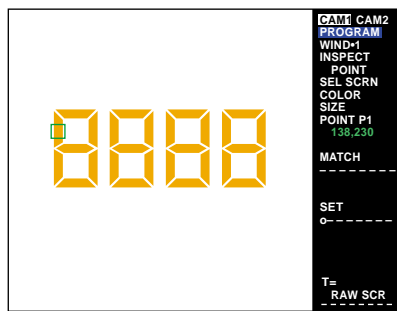



## 4.7.5 Adjusting the color extraction

### Using the filter function on the screen

Follow the procedure below to set advance processing (filter) to an image in order to omit noise on the screen or to optimize detection. Up to two filters can be set, and processing is operated following the order of selection.

- 1) Place the cursor on **[FILTER]** and press the [ENT] key.
- 2) Press the [▲]/[▼] cursor keys to select the desired filter.
- 3) Press the [ENT] key to select a filter function.



- \* To remove the filter, select the chosen filter to be canceled and press the [CLEAR] key.

Filter type	Description
EXPAND1	Translates each pixel on the screen into the level of the brightest pixel within the surrounding 3 x 3 area. Expands the extracted area to stabilize the processing of small and disconnected edges and clusters.
EXPAND2	Same processing as EXPAND1. Select EXPAND2 to operate the expansion processing twice.
SHRINK	Translates each pixel on the screen into the level of the darkest pixel within the surrounding 3 x 3 area. Effective in reducing small amounts of noise.
MEDIAN	Translates each pixel on the screen into the level of the fifth brightest pixel within the surrounding 3 x 3 area. Reduces the noise without affecting the size of the extraction range.
AVERAGE	Translates each pixel on the screen into the average brightness level within the surrounding 3 x 3 area. Because it finds the average from the maximum and minimum value of the brightness level, it is more effective in eliminating noise than the MEDIAN.
EDGE EM	Emphasizes the border between the dark and bright area of the image.
EDGE EX	Only displays the border between the dark and bright area of the image.
INVERT	Inverts the bright and dark area.
SHADING	Adjusts the varied luminous intensity in the window.
INT UP	Increases the intensity of the screen to adjust the visibility of the image.
TINT UP	Increases the tint of the screen to sharpen the color of the image.

Some combinations cannot be used simultaneously due to the types and sequence of the filters. One filter cannot be used two or more times.

**Basic concepts of the filter function**

<p>■ <b>EXPAND</b></p>	<p>■ <b>EDGE EX</b></p>
<p>■ <b>SHRINK</b></p>	<p>■ <b>INVERT</b></p>
<p>■ <b>MEDIAN</b></p> <p>The median</p>	<p>■ <b>SHADING</b></p>
<p>■ <b>AVERAGE</b></p>	<p>■ <b>INT UP</b></p>
<p>■ <b>EDGE EM</b></p>	<p>■ <b>TINT UP</b></p>

4) When the target colors are varied, for example when setting the [COLOR] for two or more targets, re-register the screen [SCRN REG] and repeat the color extraction process described in “Basic Settings” page 36.

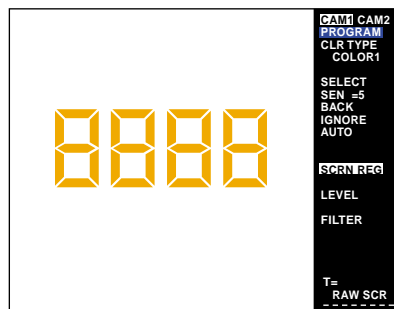

5) Press the [ESCAPE] key to register the color settings.

**Note:** The color setting interacts with the filter function. When the settings for one window are copied to another window using the method described on page 44, the filter type is copied accordingly.

## Setting the color extraction level

Do not use this function for normal operation. When the color is not extracted properly, display the histogram of the screen's color data to operate detailed color extraction.

The level setting function is available when using the color gradation processing feature.

### ■ LEVEL setting procedure

1. Display the color extraction menu.
2. Place the cursor on [LEVEL] and press the [ENT] key.

The histogram appears.

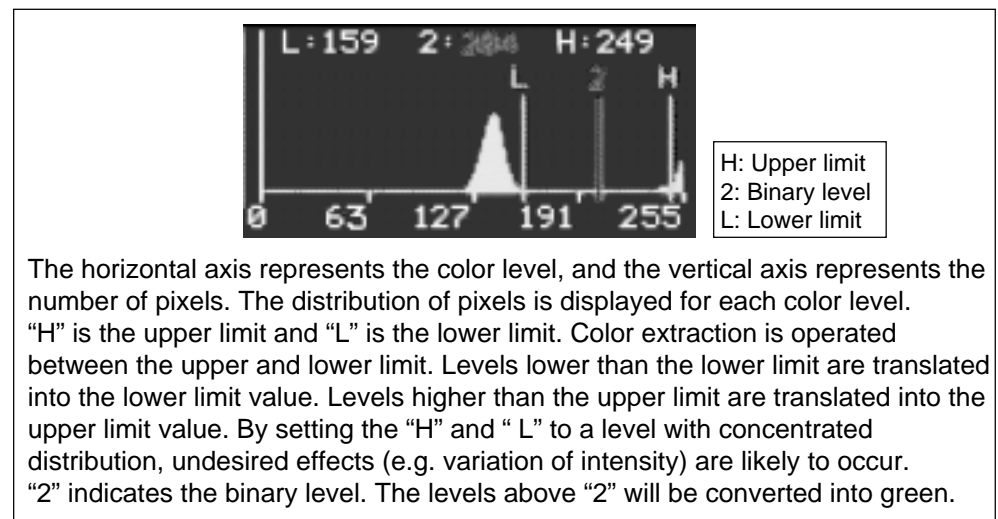

3. The setting range for [LEVEL] is shown in blue. Press the [◀]/[▶] cursor (panel key) or move the [ENT] key to the right and left to select the desired level.
4. Press the [ENT] key.

The selected level is shown in red.



5. Change the level into the desired level. Press the [◀]/[▶] cursor (panel key) or move the [ENT] key to the right and left to select the desired level.
6. Press the [ENT] key to confirm the level selection.

The level display returns to blue.



7. Repeat the above procedure (steps 3 to 6) to confirm the other levels.
8. Press the [ESCAPE] key to exit the level setting and return to the color extraction menu.



## 4.8 “INS+POS” Mode Basic Settings

This section describes the basic settings before setting the inspection and position adjustment modes. For details of the inspection mode, refer to “4.6 “INS” Mode Basic Settings” (↪ page 70). For details of position adjustment, refer to “4.9 Position Detection Mode Basic Settings” (↪ page 109).

### 4.8.1 Initial menu screen

The following menu appears after “INS+POS” is selected.

The screenshot shows a menu with the following items: CAM1 CAM2, PROGRAM, No.00, MODE, INS+POS, SHUTTER, SCR N REG, POS ADJ, WIND\*1, INSPECT AREA, DATA 000000, TOL H=000000 L=000000, OPTION, SAVE, T=, and RAW SCR. At the bottom, there are eight indicators: a green dot, a red dot, a white circle, and six dashes.

**Program No.**  
Up to 16 programs (Nos. 00 to 15) can be registered.

**Shutter speed**  
Changes shutter speed.

**POS ADJ**  
Sets parameters for position detection.

**Window**  
Sets a window for detection.

**Processing time**  
Displays the processing time for each screen. (Units: ms)

**Detection result**  
The indicator shows the detection result for each window (8 windows max.). The light farthest to the left represents window 1, and the light farthest to the right represents window 8.

● (Green): Within tolerance  
● (Red): Outside of tolerance  
○ (White): No detection  
-: The window has not been determined.

**Mode**  
Allows selection from five measurement modes.

**Screen registration**  
Registers the image for setting.

**Measured value**  
Displays the measured value of the window.

**Tolerance**  
Sets the allowable range of the detection results.

**Option**  
Sets the stored screen, illumination adjustment, and data conversion

**SAVE**  
Saves the settings

**Screen selection**  
Shows the current screen type. (Raw screen, Processed screen 1/2/3/4)

## 4.8.2 Basic setting flow

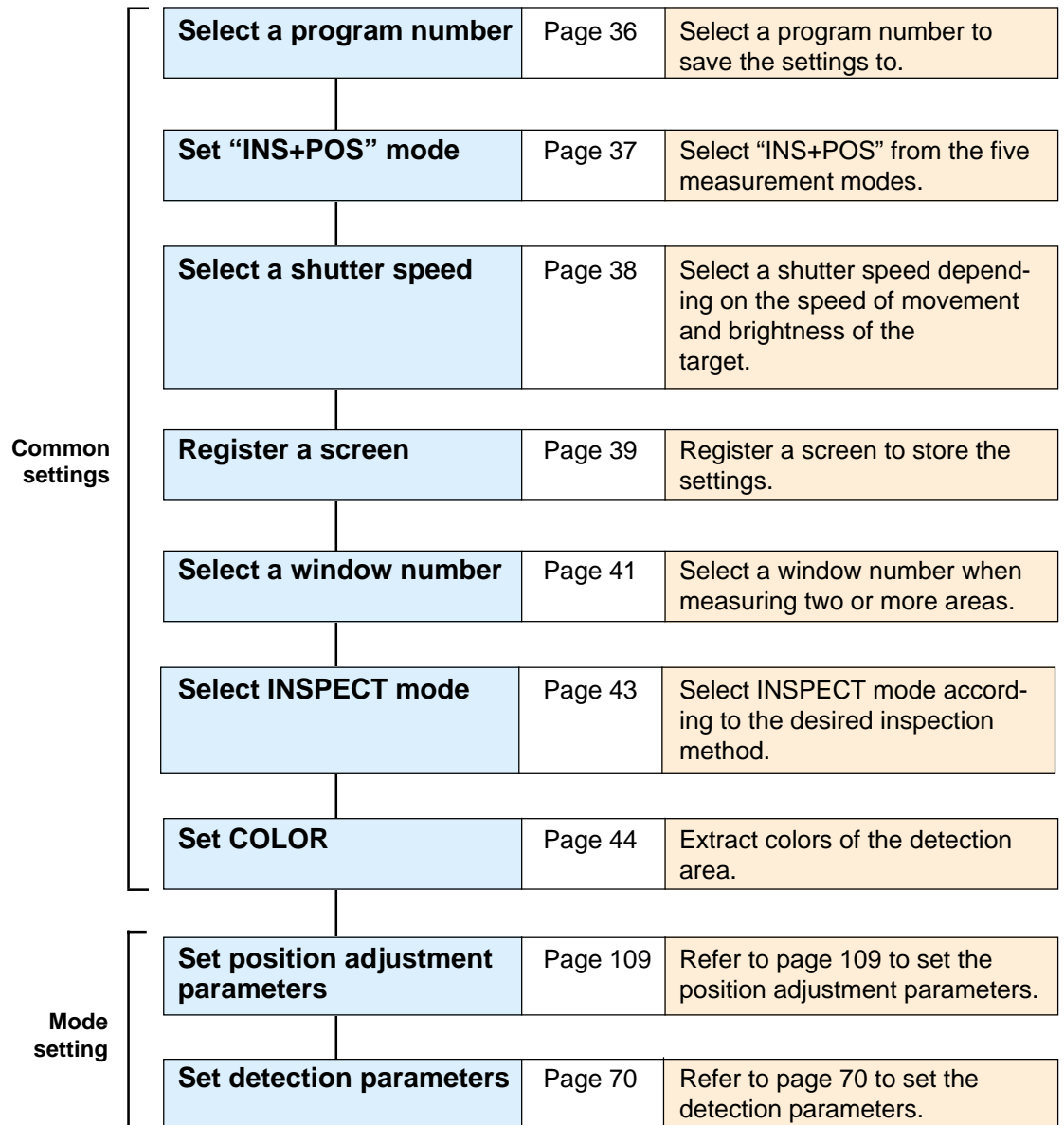

### 4.8.3 “INS+POS” menu

#### Menu structure

Main menu

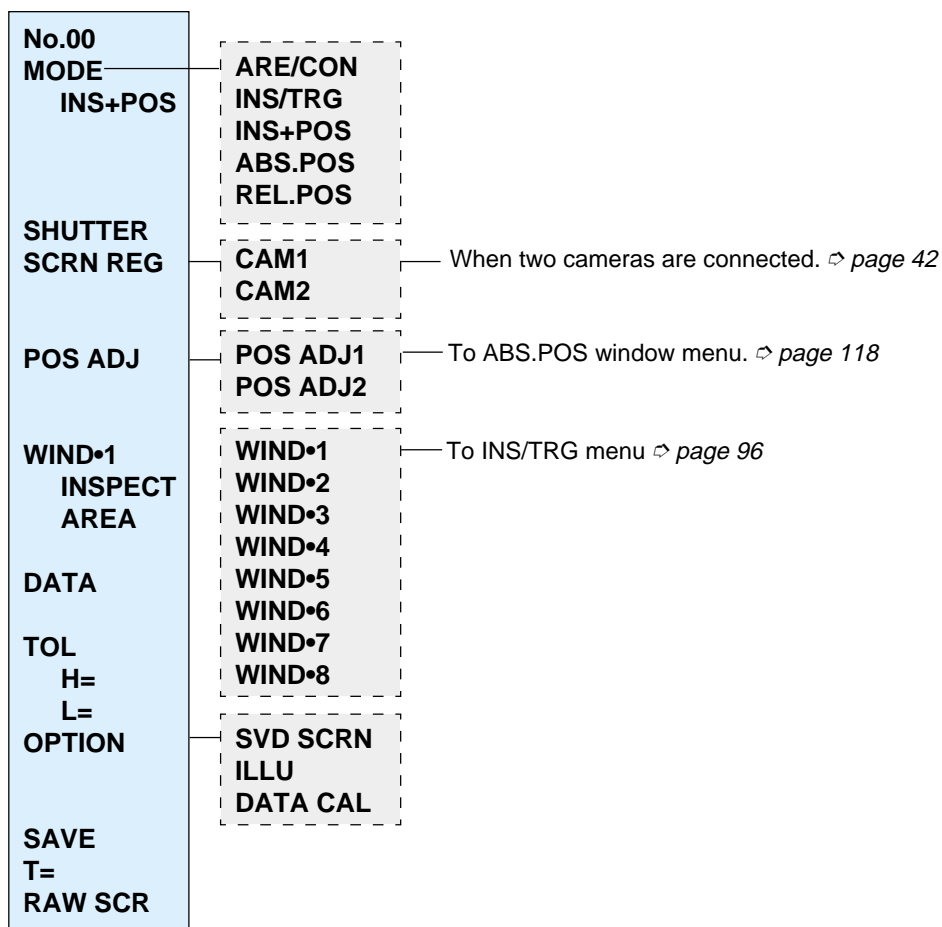

**Tips**

- The window menu is similar to the one for the “INS/TRG” mode.
- The POS ADJ menu is similar to the one for the “ABS.POS” mode.

## 4.9 “Position Detection” Mode Basic Settings

This section describes the basic settings to detect the position of a target using the “ABS.POS” (Absolute position) mode. The “REL.POS” (Relative position) and “INS+POS” (Inspection + position) modes are set using the same procedure.

### ■ Pattern search

The pattern search method searches a screen for a stored pattern and measures its position and angle.

It searches the pattern in horizontal, vertical, or rotating directions within the search range of the projected image to find the most similar pattern. It then measures its coordinates. The matching ratio of the detected pattern is displayed as the correlation ratio.

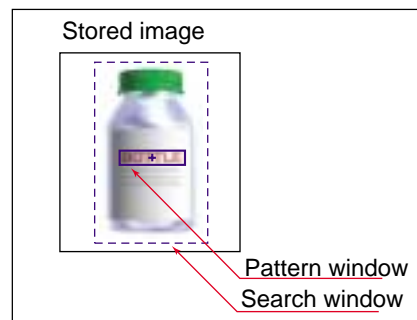

### ■ Edge detection

Using the edge detection method, two windows are set in the X- and Y-axis directions independently. The screen is scanned from left to right in the X window and from top to bottom in the Y window to find the coordinates of the first edge. You can select the edge to be detected at which the image changes from bright to dark, or the edge at which the image changes from dark to bright.

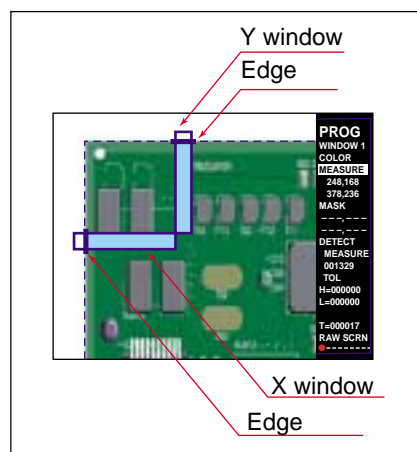

### 4.9.1 Initial menu screen

The following menu appears after the “ABS.POS” mode is selected.

The screenshot shows a menu screen with the following text and callouts:

- Program No.**: Up to 16 programs (Nos. 00 to 15) can be registered. (Callout to 'No.00')
- Shutter speed**: Changes shutter speed. (Callout to 'SHUTTER')
- Window**: Sets a window for detection. (Callout to 'WIND•1')
- Mode**: Allows selection from five measurement modes. (Callout to 'MODE ABS•POS')
- Screen registration**: Registers the image for setting. (Callout to 'SCRN REG')
- Search menu**: Displays the current search menu. (Callout to 'INSPECT PATT')
- Measured value**: Displays the measured value of the window. (X-/Y-coordinates, angle, correlation value) (Callout to 'DATA X=+0.000 Y=+0.000 ANG=+000 FIT= 00')
- Processing time**: Displays the processing time for each screen. (Units: ms) (Callout to 'OPTION T=')
- Option**: Sets the stored screen, illumination adjustment, and data conversion. (Callout to 'OPTION')
- Save**: Saves the settings. (Callout to 'SAVE')
- Screen selection**: Shows the current screen type. (Raw screen, Processed screen 1/2/3) (Callout to 'RAW SCR')
- Detection result**: The indicator shows the detection result for each window (4 windows max.). The light farthest to the left represents window 1, and the fourth light from the left represents window 4. (Callout to the indicator lights)

- (Green): Within tolerance
- (Red): Outside of tolerance
- (White): No detection
- : The window has not been determined.



## 4.9.2 Basic setting flow

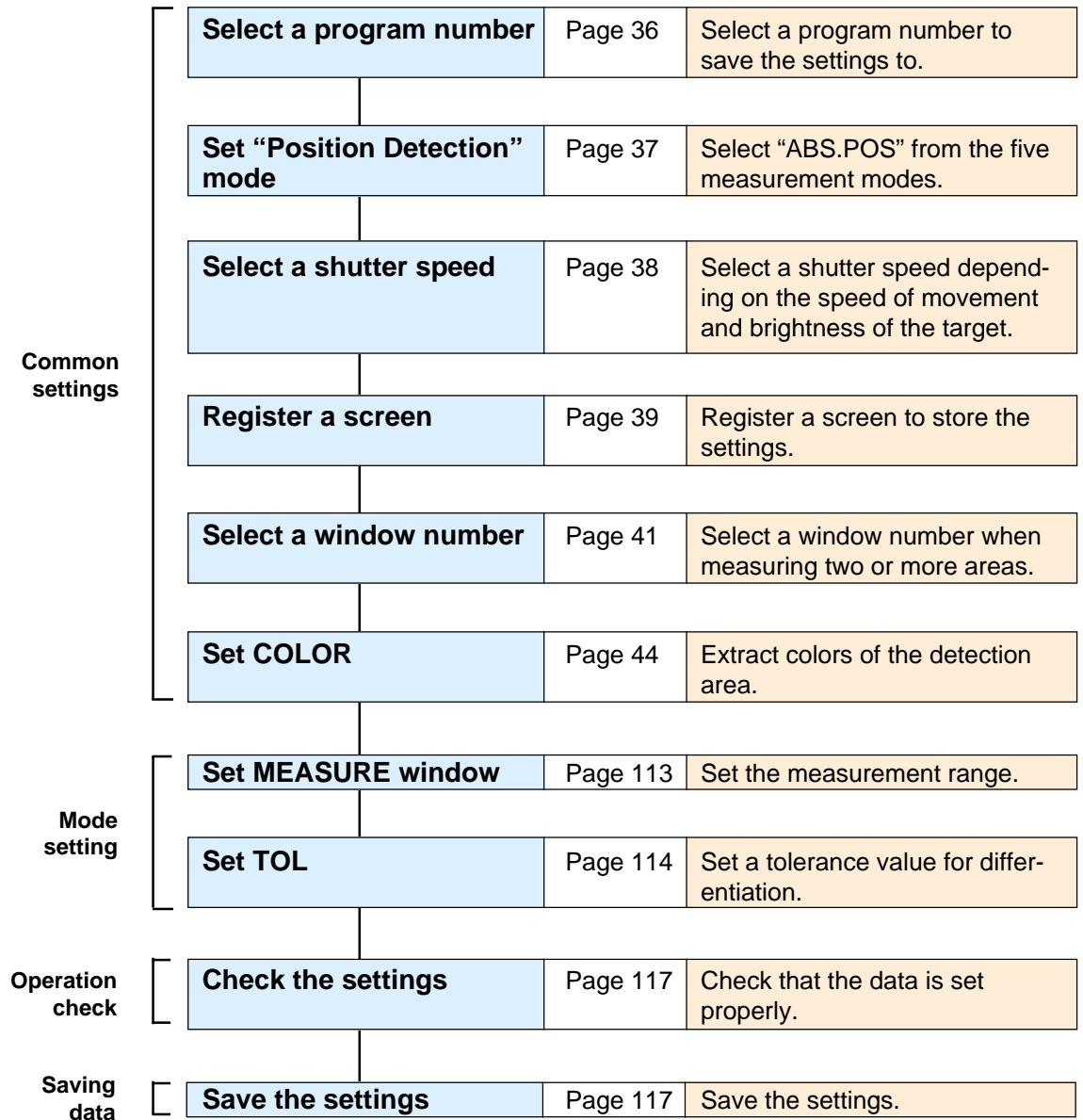

⇒ For common settings, refer to "4.3 Basic Settings: Basic setting procedures" on page 36.

## Setting parameters

The parameters in bold type are described in the basic setting procedures.

⇒ See “Basic Settings” on page 36 for the parameters in bold.

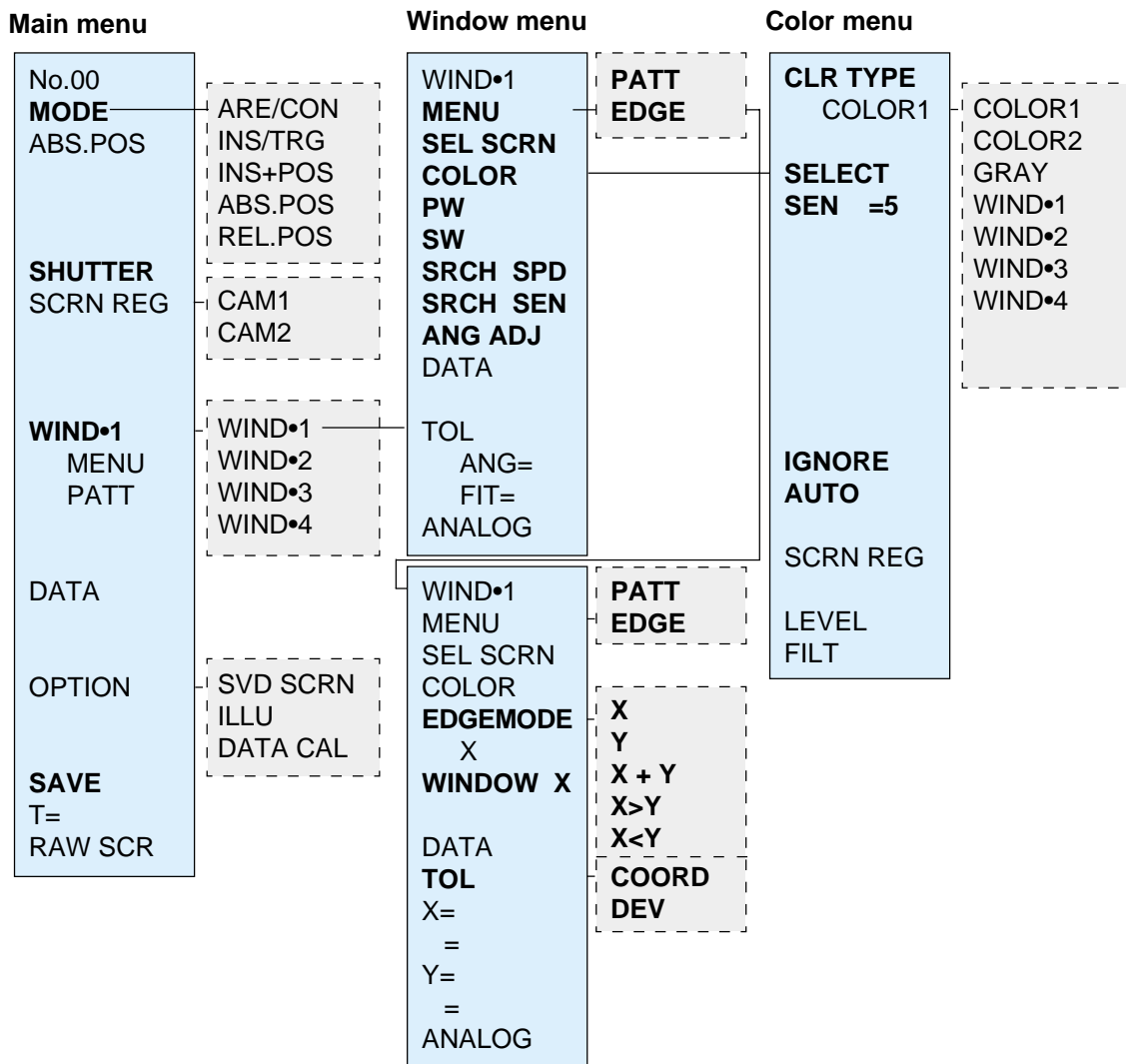

### ■ Screen type sequence

Pressing the [SCREEN] key shows the following sequence.



## Basic setting procedure

1. First follow the “Basic setting procedures” (⇒ page 36) to set the parameters to the color settings.
2. Set [PW] (pattern window).

Draw a window (range) on the screen to save the pattern of the target on the screen.

- 1) Place the cursor on [PW] and press the [ENT] key. A frame appears on the screen.



- 2) Adjust the window to fit around the desired pattern to be detected.



The window drawing mode changes as shown below every time the [ENT] key is pressed.



- 3) Press the [ESCAPE] key to exit the [PW] setting after setting the range and position of the window.

**Note:** When "GRAVITY1" or "GRAVITY2" is selected under "SRCH SEN", the maximum size of a pattern window is 256 x 256 pixels.

### 3. Set [SW] (Search window).

Draw a window (range) on the screen to search for the pattern saved in PW.

- 1) Place the cursor on [SW] and press the [ENT] key. A frame appears on the screen.



- 2) Adjust the window to fit around the area in which the selected pattern should be searched for.

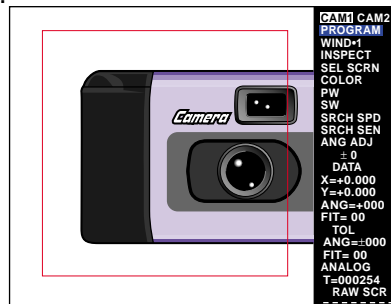

The window drawing mode changes as shown below every time the [ENT] key is pressed.

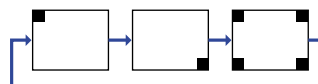

- 3) Press the [ESCAPE] key to exit the [SW] setting after setting the range and position of the window.

**Note 1:** The search window is drawn with a red line. The pattern window searches for the specified pattern within the search window. If a similar pattern exists near the specified pattern, narrow the search window to avoid detection errors.

**Note 2:** Narrowing the search window decreases the processing time.

■ **Window coordinate value display**

The window coordinate value is displayed using numerical values. Use the value to check or save the coordinate values.

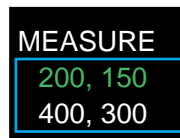
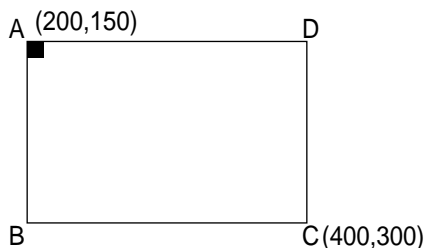

Upper line: Coordinates of point A (X, Y)  
Lower line: Coordinates of point C (X, Y)

**4. Adjust the angle.**

When position detection uses the pattern search, the angle of the target can be adjusted as necessary. The adjustable range is  $\pm 180^\circ$  maximum.

- 1) Place the cursor on **[ANG ADJ]** (Angle adjustment) and press the **[ENT]** key. The **[ANG ADJ]** menu appears on the screen.



- 2) Place the cursor on the desired angle for adjustment and press the **[ENT]** key.

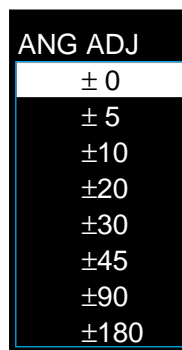

**Tips**

- The angle adjustment function is available only when the search menu is set to **[PATT]** (pattern).
- Increasing the range for angle adjustment increases the processing time. Avoid needless increases.

**5. Set the tolerance of the coordinates.**

Set the allowable range (upper and lower limits) for the X and Y coordinates. The values outside of the range are judged as unacceptable. The setting range is  $\pm 99999$ .

**Note:** When using the "REL.POS" (Relative position) setting, the tolerance for **[REF WND]** (Reference window) is specified with the absolute values. The tolerance for other windows is specified with the difference from the coordinates of **[REF WND]**.

- 1) Place the cursor on **[TOL]** and press the **[ENT]** key. The **[COORD]** and **[DEV]** selection menu appears.

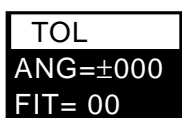

- [COORD]** : Use the median coordinate of the pattern window (X1, Y1) to display the measured value.
- [DEV]** : Use the difference from the median coordinate of the reference pattern window (registered screen) (dX, dY) to display the measured value.

- 2) Place the cursor on **[COORD]** and press the [ENT] key. The cursor moves to **[X=xxx]**.

```

TOL
COORD
X=+0.500
  =+0.000
Y=+0.500
  =+0.000

```

- 3) Press the [ENT] key.

The first digit, "0", is shown as highlighted. You can enter a numerical value.

```

TOL
COORD
X=+0.500
  =+0.000
Y=+0.500
  =+0.000

```

- 4) Move the cursor to the left or right and select the digit to be changed.
- 5) Press the [▲]/[▼] cursor key (panel key) or move the [ENT] key (remote control console) up or down repeatedly.

When the [▲] cursor key is pressed or the [ENT] key is moved up repeatedly, the value increments by one from "0". After "9", the second digit is incremented. The maximum value is "99999". When the [▼] cursor key is pressed or the [ENT] key is moved down repeatedly, the value decrements by one to "0".

```

TOL
COORD
X=+100.0
  =+0.000
Y=+0.500
  =+0.000

```

- 6) Press the [ENT] key to confirm the input value for the upper limit of the X-coordinate.
- 7) Move the cursor to the second line and set the lower limit with the same procedure.
- 8) Move the cursor to **[Y=xxx]** and input the upper and lower limits for the Y-coordinate with the above procedure (steps 2 to 6).

```

TOL
COORD
X=+100.0
  =+0.000
Y=+0.500
  =+0.000

```

**Note:** The selection menu of [COORD] and [DEV] is displayed only when the tolerance is not specified. To change the current setting, clear the preset tolerance value.

To clear the tolerance, place the cursor on [TOL] and hold down the [CLEAR] key for at least two seconds. When the confirmation message appears, select "Y".

#### 6. Set the tolerance of the angle adjustment.

You can set the tolerance for the angle measured by the angle adjustment. Values outside of the range are judged as unacceptable.

- 1) Place the cursor on [ANG=] under [TOL] and press the [ENT] key.

```
TOL
ANG=±000
FIT= 00
```

- 2) The value changes to the tolerance value. The first digit is shown as highlighted. Set the tolerance value with the [ENT] key.

```
TOL
ANG=±000
FIT= 00
```

- 3) Press the [ENT] key to confirm the setting.

#### Tips

- When the measured angle is within the tolerance range, the detected result is acceptable. When the measured angle is outside of the tolerance range, it is unacceptable.
- The tolerance is applied to both positive and negative values.
- The available values should be within the angle adjustment range.

#### 7. Set the tolerance of the correlation ratio.

Set the tolerance when comparing the matching rate of the saved pattern and the detected pattern. The correlation ratio is a value that indicates the matching rate between the saved pattern and the detected pattern. Theoretically, the value will be 100 if the patterns are identical. A measured value below the tolerance value is unacceptable. The setting range is 00 to 99.

- 1) Place the cursor on [FIT=] and press the [ENT] key. The first digit, "0", is shown as highlighted. You can enter a numerical value.

```
TOL
ANG=±000
FIT= 00
```

- 2) When the [▲] cursor key (panel key) is pressed or the [ENT] key (remote control console) is moved up repeatedly, the value increments by one. After "9", the second digit is incremented. The maximum value is 99. When the [▼] cursor key is pressed or the [ENT] key is moved down repeatedly, the value decrements by one to "0".

```
TOL
ANG=±000
FIT= 00
```

- 3) Press the [ENT] key to confirm the input value.

The setting of WIND•1 is complete. Up to four detection windows can be set under one program number. To set two or more windows, select a different window number and repeat the procedure described above.

## Operation check after changing the settings

1. Press the [ESCAPE] key to return to the initial menu screen.
2. Press the [TRIGGER] key.
3. Check the detection result indicator.

Green: Acceptable (The measured value is within the tolerance range.)  
 Red: Unacceptable (The measured value is outside of the tolerance range.)  
 White: No detection (The trigger signal is not input.)

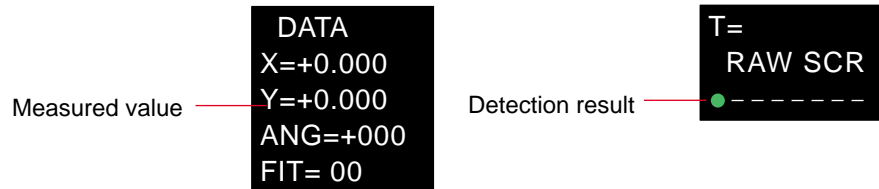

### Tips

When detection is not stable, refer to “Advanced position adjustment setting”.  
 ⇨ pages 127 to 129

## Saving the settings

Save the setting data. The following three can be used to save the data.

- **Press the [RUN/PROG] panel key for at least two seconds or slide the mode selection slide switch on the remote control console up.**  
 When the CV-701(P)/751(P) enters [RUN] mode, the message <REGISTER SET> appears on the screen and the settings are saved in the internal memory.
- **Select [SAVE] on the menu screen.**  
 When the [ENT] key is pressed, the message “REGISTER SET” appears on the screen and the settings are saved in the internal memory.

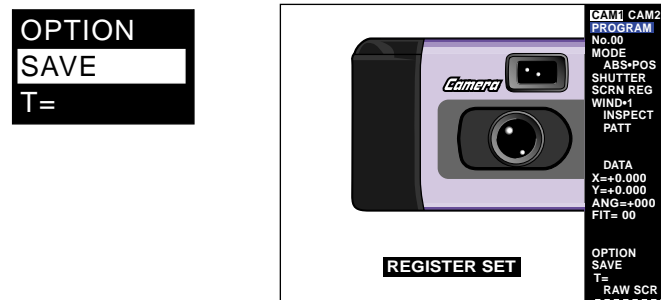

- **Save the data in CompactFlash memory (Optional)**

⇨ See “Chapter 7 CompactFlash Memory” on page 171 for the procedure.

**Note 1:** Do not turn the power off until the message “REGISTER SET” disappears.

**Note 2:** If the power is turned off before saving the settings, the setting data will be lost.

## 4.10 "Position Detection" Advanced Settings

### 4.10.1 "ABS.POS" Menu

#### Menu structure

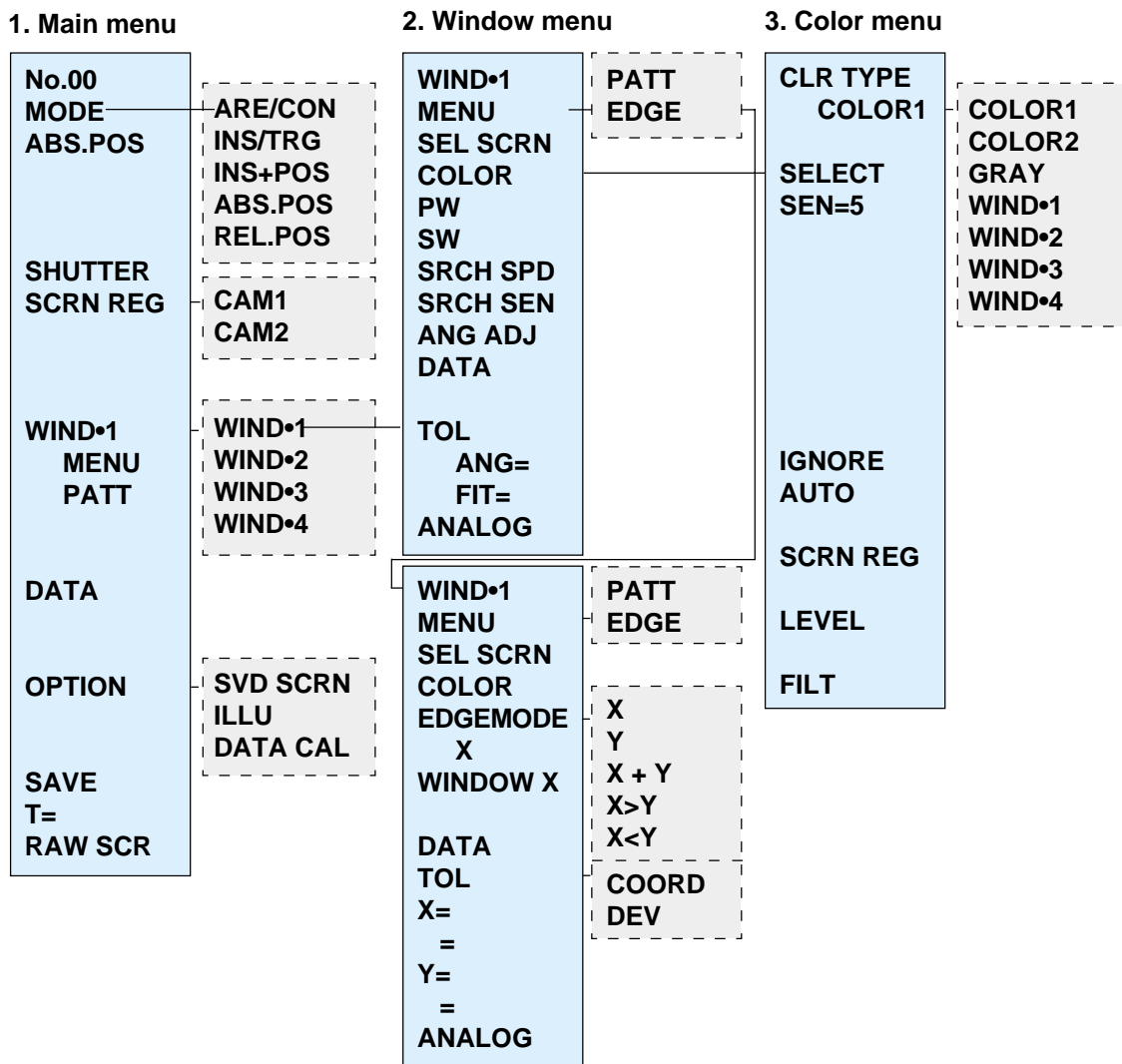



## 1. Main menu

“\*\*” indicates the initial setting value.

Parameter	Setting	Description	Function
PROGRAM	00* to 15	Program No. for the setting	Change the program No. to set several settings.
MODE			
SHUTTER	1/30 to 1/10000 (1/60*)	Shutter speed	Select a faster shutter speed when detecting a fast-moving target.
SCRN REG	N/Y	Register the reference screen.	Save a target image in the memory.
WIND• 1	To sub menu (Refer to “2.” for details).	Set a measurement window and the color of a target.	Set details for detection.
MEASURE		Measurement mode display	Check the measurement mode of the selected window.
DATA		Measured value display	Check the measured value.
ANG		Measured angle display	Check the measured angle.
FIT		Correlation ratio display	Check the correlation ratio.
OPTION	To sub menu (Refer to respective sections for details).	Set the illumination adjustment function, value conversion, and saved screen.	Set optional settings.
SAVE		Save the setting data.	Save the setting data in the memory.
T=000000		Processing time display	Check the processing time.
RAW SCR	RAW SCR*	The actual image captured by the camera.	Check the unprocessed image.
	PROCES1	Processed image for detection.	Check the detection condition.
	PROCES2	Processed image for detection.	Check the detection condition.

## 2. Window menu

\*\*\* indicates the initial setting value.

## ■ Pattern

Parameter	Setting	Description	Function
WIND• 1	WIND1* to 4	Window No.	Change the window No. to set several windows.
MENU (Search menu)	PATT*	Select the search method.	Use the pattern search method for position detection.
	EDGE		Use the edge detection method for position detection.
SEL SCRΝ	CAM1	Select the camera image for screen registration.	When two cameras are connected.
	CAM2		
	CAM1 2		
	CAM1/2		
COLOR	Refer to sub menu 3 "Color Menu" (page 123) for details.	Set the colors to be extracted.	Extract colors for detection.
PW		Set the size and position of the pattern window.	Set a target to be searched (detected).
SW		Set the size and position of the search window.	Set a range to be searched (detected).
SRCH SPD	FAST	Set the speed or resolution of the search. FAST: By 1 pixel NORMAL: By 1 pixel SUB PIX: By 0.1 pixel	Change the speed or resolution of the search.
	NORMAL*		
	SUB PIX		
SRCH SEN	GRAVITY1	Set the sensitivity of the search.	When the search is unstable.
	GRAVITY2		
	AUTO		
	FINE1		
	FINE2		
ANG ADJ	±0, ±5, ±10, ±20, ±30, ±45, ±90, ±180	Set the range for the angle adjustment.	To use the angle detection or angle adjustment.
DATA		Measured value display	Check the measured value.
ANG		Measured angle display.	Check the measured value.
FIT		Measured correlation ratio display.	Check the measured value.
TOL	COORD (Coordinate)		Use the absolute coordinates on the screen as the numerical value output.
	DEV (Deviation)		Use the deviation from the registered screen as the numerical value output.
COORD	X=0000	Set the tolerance for the distance of the X coordinate.	Set the tolerance for the X coordinate.
	=0000		
	Y=0000	Set the tolerance for the distance of the Y coordinate.	Set the tolerance for the Y coordinate.
	=0000		

Parameter	Setting	Description	Function
ANG		Set the tolerance for the angle.	Set the tolerance for the angle
FIT		Set the tolerance for the correlation ratio.	Set the tolerance for the correlation ratio.
ANALOG	DATA H ANALOG H DATA L ANALOG L	Set the scaling value for analog output.	Output the measured value with the desired output voltage.
T=000000		Processing time display	Check the processing time.
RAW SCR	RAW SCR*	The actual image captured by the camera.	Check the unprocessed image.
	PROCES1	Processed image for detection.	Check the detection condition.
	PROCES2	Processed image for detection.	Check the detection condition.

## ■ Edge

“\*” indicates the initial setting value.

Parameter	Setting	Description	Function
WIND•1	WIND•1* to 4	Window No.	Change the window No. to set several windows.
MENU (Search menu)	PATT*	Select the search method.	Use the pattern search method for position detection.
	EDGE		Use the edge detection method for position detection.
SEL SCRΝ	CAM1	Select the camera image for screen registration.	When two cameras are connected.
	CAM2		
	CAM1 2		
	CAM1/2		
COLOR	Refer to sub menu 3 "Color Menu" (page 123) for details.	Set the colors to be extracted.	Extract colors for detection.
EDGEMODE	X	Set the range to detect the edge in the X-axis direction.	Detect (adjust) the position of a pattern only in the X-axis direction.
	Y	Set the range to detect the edge in the Y-axis direction.	Detect (adjust) the position of a pattern only in the Y-axis direction.
	X+Y	Set the range to detect the edges in both the X- and Y-axis directions.	Detect (adjust) the position of a pattern in both the X- and Y-axis directions.
	X>Y	Set the range to detect the edges in both the X- and Y-axis directions.	Detect (adjust) the position of a pattern in both the X- and Y-axis directions by first using the edge in the X-axis direction.
	Y>X	Set the range to detect the edges in both the X- and Y-axis directions.	Detect (adjust) the position of a pattern in both the X- and Y-axis directions by first using the edge in the Y-axis direction.
WINDOW X	COORD SCAN EDGE SEN	Set the range, scanning direction, and detection sensitivity of the X window.	Set the X window for the edge search.
WINDOW Y	COORD SCAN EDGE SEN	Set the range, scanning direction, and detection sensitivity of the Y window.	Set the Y window for the edge search.
DATA		Measured value display	Check the measured value.
TOL	COORD (Coordinate)		Use the absolute coordinates on the screen as the numerical value output.
	DEV (Deviation)		Use the deviation from the registered screen as the numerical value output.

Parameter	Setting	Description	Function
COORD	X=0000	Set the tolerance for the distance of the X coordinate.	Set the tolerance for the X coordinate.
	=0000		
	Y=0000	Set the tolerance for the distance of the Y coordinate.	Set the tolerance for the Y coordinate.
	=0000		
ANALOG	DATA H ANALOG H DATA L ANALOG L	Set the scaling value for analog output.	Output the measured value with the desired output voltage.
T=000000		Processing time display	Check the processing time.
RAW SCR	RAW SCR*	The actual image captured by the camera.	Check the unprocessed image.
	PROCES1	Processed image for detection.	Check the detection condition.
	PROCES2	Processed image for detection.	Check the detection condition.
	PROCES3	Processed image for detection.	Check the detection condition.

### 3. Color menu

\*\*\* indicates the initial setting value.

Parameter	Setting	Description	Function
CLR TYPE	COLOR1	Select the color extraction settings.	Change the extraction methods or copy the settings of other windows.
	COLOR2		
	GRAY		
	WIND• 1 to 4		
SELECT		Move the cursor on the screen to select the colors to be extracted.	To extract the colors.
SEN	0 to 9 (5*)	Use the cursor to set the sensitivity for the color range when selecting the extraction colors.	Change the color range to be extracted in one operation.
IGNORE		Select colors not to be extracted.	Omit selected colors from those extracted.
AUTO		Automatically extend the range for color extraction.	Stabilize the color extraction.
SCRN REG	N/Y	Register the reference image.	Save the target image in the memory.
LEVEL		Select a level for color extraction.	Manually select a level for color extraction.
FILTER	11 types	Select a filter. (Reference: For details, see page 131.)	Omit the noise or optimize detection.

### 4.10.2 “REL.POS” Menu

#### Menu structure

The parameters of 2 and 3 are the same as the [ABS.POS] menu.

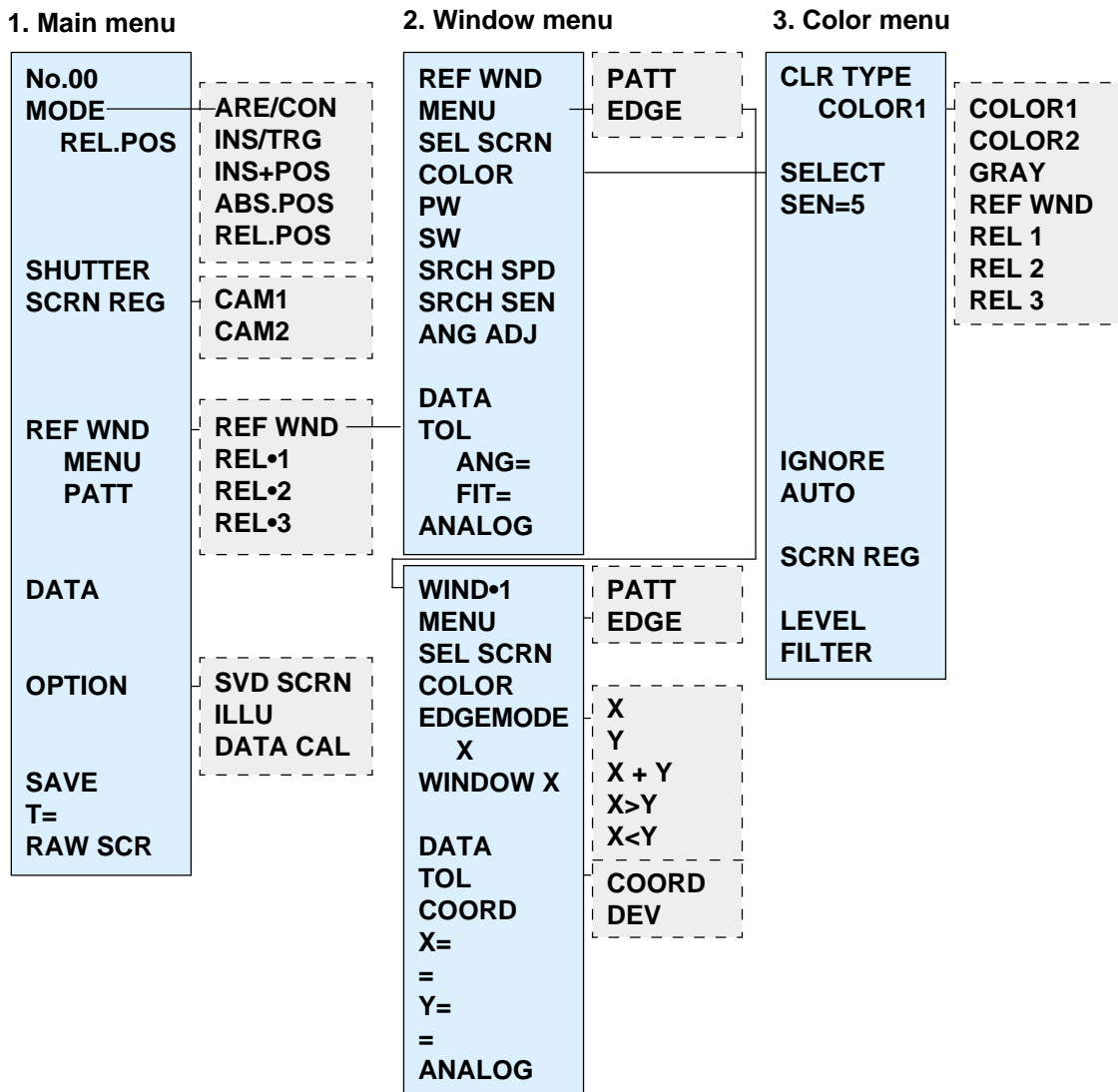

4

### 4.10.3 Advanced position adjustment setting (Pattern search)

This section describes the setting procedure for accurate position adjustment.

#### [SRCH SPD] (Search speed)

Set the speed and resolution of the search.

- The initial setting is **[NORMAL]**.
- The processing time becomes longer as the setting is changed from **[FAST]** to **[NORMAL]**, and then to **[SUB\_PIX]** (Sub pixel).
- The **[SUB\_PIX]** setting enables detection with a high resolution of 0.1 pixels.

1. Place the cursor on **[SRCH SPD]** in the window menu and press the **[ENT]** key.

The **[SRCH SPD]** (Search speed) menu appears.



2. Place the cursor on the desired option and press the **[ENT]** key to confirm the selection for **[SRCH SPD]**.

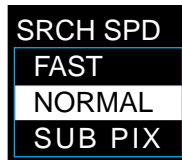

#### Tips

The processing time is displayed at the bottom of the menu screen (T=000000). Check the value after changing the setting.

#### [SRCH SEN] (Search sensitivity)

Change the sensitivity of the search when the search is unstable or fails.

- The initial setting is **[AUTO]**.
- The sensitivity of the search increases and the stability of detection enhances as the setting is changed from **[OBJT1]** to **[OBJT2]**, then to **[AUTO]**, **[FINE1]**, and **[FINE2]**.

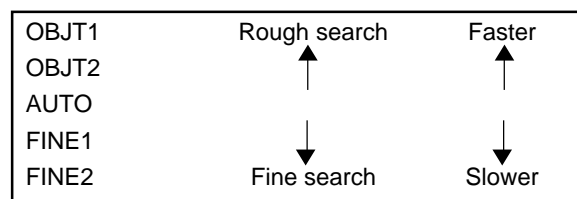

**Note 1:** When [OBJT1] or [OBJT2] is selected under [SRCH SEN], the maximum size of a pattern window is 256 x 256 pixels.

**[GRAVITY]** (Gravity) mode searches the image for the position of the center of gravity and its angle of principal axis of the binary-converted extracted color data (The horizontal axis of the screen and the longitudinal axis of the smallest ellipse enclosing a cluster of extracted colors form the angle of principal axis.) Binary conversion processing speeds the processing; however, detection will be unstable under the following conditions due to the operation principles.

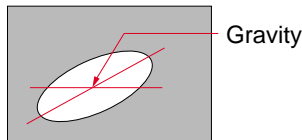

**Note 2:** When the cluster of extracted colors spreads across the MEASURE window.

**Note 3:** When two or more clusters with a similar size exist in the MEASURE window.

**Note 4:** When the principal axis is not determined. (e.g. square and circular objects)

1. Place the cursor on [SRCH SEN] in the window menu and press the [ENT] key.

[SRCH SEN] menu appears.



2. Place the cursor on the desired option and press the [ENT] key to confirm the selection for [SRCH SEN].

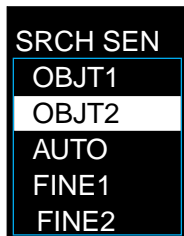

**Tips**

Increasing the SERCH SEN value slows the processing time. Do not set the sensitivity higher than it needs to be.



## 4.10.4 Advanced position adjustment setting (Edge detection)

### Selecting the edge detection mode

There are five modes for edge detection. In any mode, the screen is searched in the direction set with "SCAN" for edge detection.

1. Place the cursor on [MENU] in the window menu and press the [ENT] key.

The search menu appears.



2. Place the cursor on [EDGE] and press the [ENT] key.

The message <ERASE SETTINGS N/Y> appears on the screen. Place the cursor on "Y" and press the [ENT] key.

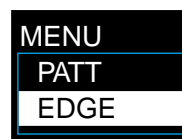

3. Place the cursor on [EDGEMODE] mode and press the [ENT] key.



4. Select the desired mode and press the [ENT] key.

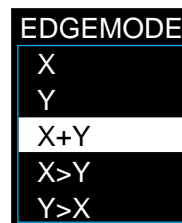

X: To adjust the position only in the X-axis direction.

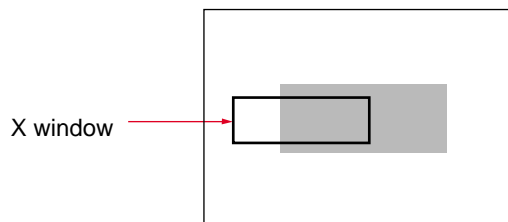

Y: To adjust the position only in the Y-axis direction.

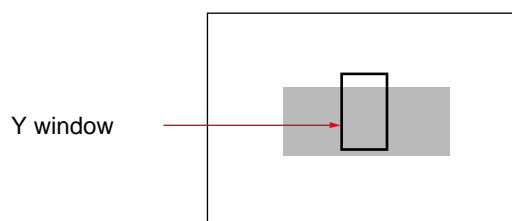

X+Y: To adjust the position in both X- and Y-axis directions.

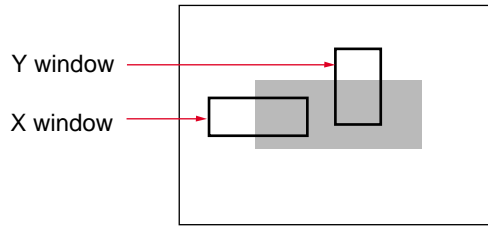

X>Y: To adjust the position in the X-axis direction first, and then adjust the position in the Y-axis direction.

Y>X: To adjust the position in the Y-axis direction first, and then adjust the position in the X-axis direction.

**Tips**

**Priority position adjustment**

- Example: X priority (X>Y) mode

When the X priority mode is selected, the X coordinate of the edge is searched in the X window. The result (the difference between the registered X coordinate value and the detected X coordinate value) is used to shift the Y window, and then the Y coordinate of the edge is searched.

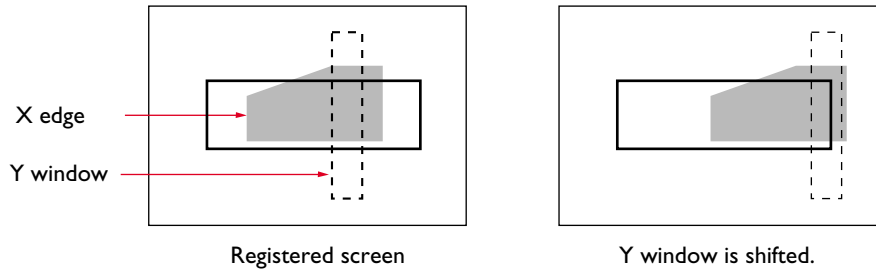

- When the preferred edge position is extremely different from the registered position and the shifted window disappears from the screen, the detection result is unacceptable regardless of the coordinate value.

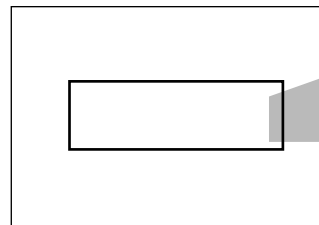

The Y window is shifted off the screen.

## WINDOW X and WINDOW Y settings

WINDOW X/WINDOW Y :

Set a window to search in the X-axis/Y-axis direction with **[COORD]**. The screen is searched in the horizontal/vertical direction. Set the direction of the edge search with **[SCAN]**. Use the **[▲]/[▼]** cursor to change the setting.

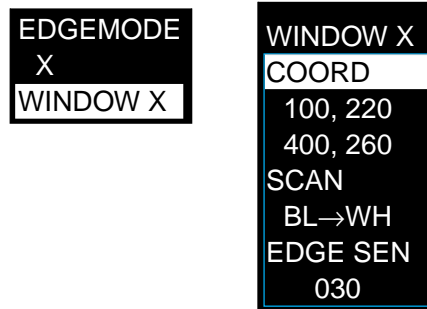

X window	Search direction	Y window	Search window
[BL] ← [WH]	Right to left	[BL] ← [WH]	Bottom to top
[WH] ← [BL]	Right to left	[WH] ← [BL]	Bottom to top
[WH] → [BL]	Left to right	[WH] → [BL]	Top to bottom
[BL] → [WH]	Left to right	[BL] → [WH]	Top to bottom

- **[EDGE SEN]**: Set the sensitivity of the edge detection.  
Setting range: 000 to 100 (Initial setting: 030)  
A smaller value increases the sensitivity so that edges are detected with a smaller difference in the brightness. Set the optimal sensitivity while watching the monitor.

### 4.10.5 Advanced position adjustment (Tolerance setting)

#### [TOL] (Tolerance)

Select the coordinates or the deviation to set the edge tolerance.

- |                |   |
|----------------|---|
| <b>[COORD]</b> | : Use the absolute coordinates to display the measured value and to set the tolerance.                                    |
| <b>[DEV]</b>   | : Use the difference from the reference value (registered screen) to display the measured value and to set the tolerance. |

1. Place the cursor on **[TOL]** in the window menu and press the **[ENT]** key.

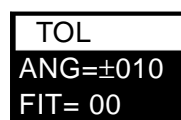

2. Place the cursor on **[COORD]** or **[DEV]** and press the **[ENT]** key.



### 4.10.6 Sensitivity adjustment for edge detection

#### Adjusting the sensitivity for edge detection

When detection is unstable (e.g. some edges are not detected or unnecessary edges are detected), adjust the sensitivity to optimize detection.

1. Place the cursor on [WINDOW X] in the window menu and press the [ENT] key.

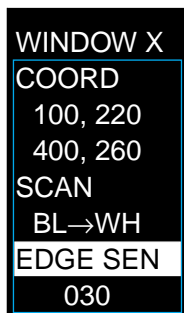

2. Place the cursor on [EDGE SEN] and press the [ENT] key.

The first digit of the sensitivity is shown as highlighted.



3. Change the value for the [EDGE SEN] using the [ENT] key.

- The change in the values for [EDGE SEN] is reflected in the edge detection status on the monitor screen. Set the optimal sensitivity while watching the monitor.
- A larger value decreases the sensitivity, and a smaller value increases the sensitivity.

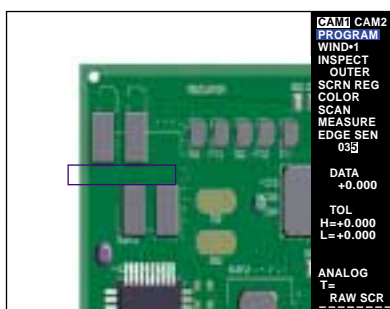

## 4.10.7 Adjusting the color extraction

### Using a filter function on the screen

Follow the procedure below to set advanced processing (filter) to an image in order to omit noise on the screen or to optimize detection. Up to two filters can be set, and processing is operated following the order of selection.

- 1) Place the cursor on **[FILTER]** and press the [ENT] key.
- 2) Press the [▲]/[▼] cursor keys to select the desired filter.
- 3) Press the [ENT] key to select a filter function.



- To remove the filter, select the chosen filter to be canceled and press the [CLEAR] key.

Filter type	Description
EXPAND1	Translates each pixel on the screen into the level of the brightest pixel within the surrounding 3 x 3 area. Expands the extracted area to stabilize the processing of small and disconnected edges and clusters.
EXPAND2	Same processing as EXPAND1. Select EXPAND2 to operate the expansion processing twice.
SHRINK	Translates each pixel on the screen into the level of the darkest pixel within the surrounding 3 x 3 area. Effective in reducing small amounts of noise.
MEDIAN	Translates each pixel on the screen into the level of the fifth brightest pixel within the surrounding 3 x 3 area. Reduces the noise without affecting the size of the extraction range.
AVERAGE	Translates each pixel on the screen into the average brightness level within the surrounding 3 x 3 area. Because it finds the average from the maximum and minimum value of the brightness level, it is more effective in eliminating noise than the MEDIAN.
EDGE EM	Emphasizes the border between the dark and bright area of the image.
EDGE EX	Only displays the border between the dark and bright area of the image
INVERT	Inverts the bright and dark area.
SHADING	Adjusts the varied luminous intensity in the window.
INT UP	Increases the intensity of the screen to adjust the visibility of the image.
TINT UP	Increases the tint of the screen to sharpen the color of the image.

Some combinations cannot be used simultaneously due to the types and sequence of the filters. One filter cannot be used two or more times.

Basic concepts of the filter function	
<p>■ EXPAND</p>	<p>■ EDGE EX</p>
<p>■ SHRINK</p>	<p>■ INVERT</p>
<p>■ MEDIAN</p> <p>The median</p>	<p>■ SHADING</p>
<p>■ AVERAGE</p>	<p>■ INT UP</p>
<p>■ EDGE EM</p>	<p>■ TINT UP</p>

- 4) When the target colors are varied, for example when setting the [COLOR] for two or more targets, re-register the screen [SCRN REG] and repeat the color extraction process described in “Basic Settings” page 36.
- 5) Press the [ESCAPE] key to register the color settings.

**Note:** The color setting interacts with the filter function. When the settings for one window are copied to another window using the method described on page 44, the filter type is copied accordingly.

## Setting the color extraction level

Do not use this function for normal operation. When the color is not extracted properly, display the histogram of the screen's color data to operate detailed color extraction.

This function is useful when a search is not functioning properly with [GRAVITY1/2] for [SERCH SEN] setting. If an area other than the desired area for the search is converted into a binary level, change the binary level to normalize the search.

### ■ [LEVEL] setting procedure

1. Display the color extraction menu.



**2. Place the cursor on [LEVEL] and press the [ENT] key.**

The histogram appears.

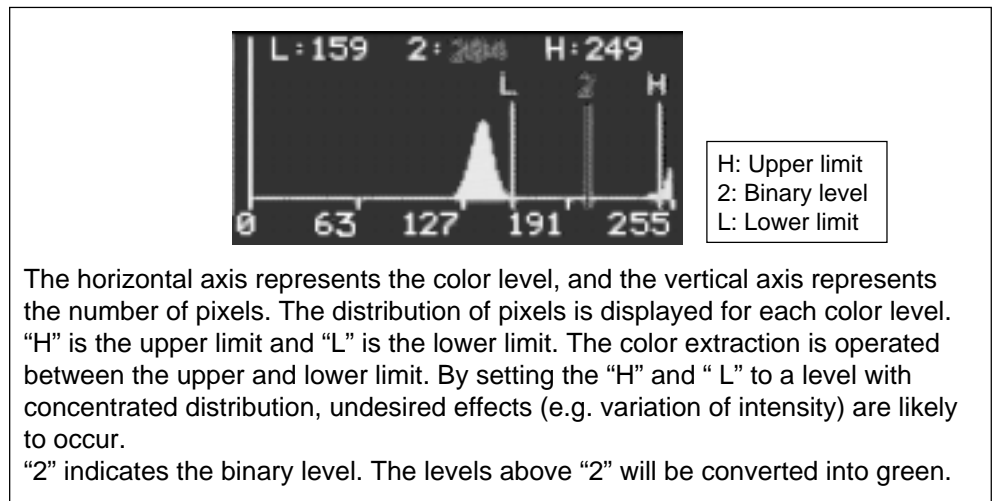

**3. The setting range for [LEVEL] is shown in blue. Press the [◀]/[▶] cursor (panel key) or move the [ENT] key to the right or left to select the desired level.**

**4. Press the [ENT] key.**

The selected level is shown in red.



**5. Change the level into the desired level. Press the [◀]/[▶] cursor (panel key) or move the [ENT] key to the right or left to select the desired level.**

**6. Press the [ENT] key to confirm the level selection.**

The level display returns to blue.



**7. Repeat the above procedure (steps 3 to 6) to confirm the other levels.**

**8. Press the [ESCAPE] key to exit the level setting and return to the color extraction menu.**



## 4.11 Optional Settings

### 4.11.1 Saving the running images

Up to eight captured images in the [RUN] mode can be saved for future readout. The read-out screen can be used for processing and checking the data. Use this function to check a screen with an unacceptable detection result in RUN mode at a later date.

**Note 1:** The screens under the “RUN” operation mode can be saved. The screens under the “PROGRAM” mode cannot be saved.

**Note 2:** When saving more than eight screens, the saved screens are over-written in sequence starting from the earliest data.

**Note 3:** The screens under “ARE/CON” mode cannot be saved.

**Note 4:** The processing speed slows down slightly when using the “SAVE SCR” function.

**Note 5:** Up to four screens can be saved for each camera when two cameras are connected.

**Note 6:** The data is saved in RAM inside the controller. The saved data will be lost when the power is turned off. To keep the record, save the data in the CompactFlash memory (↪ page 171).

**Note 7:** A saved screen cannot be used as a registered screen.

## Preparations

Advance setting is required to save the captured screen. Set the SAVE SCR parameters with the environmental setting menu.

1. Put the CV-701(P)/751(P) in [PROGRAM] mode.
2. Press the [ESCAPE] key for at least two seconds.

The environmental setting menu appears.

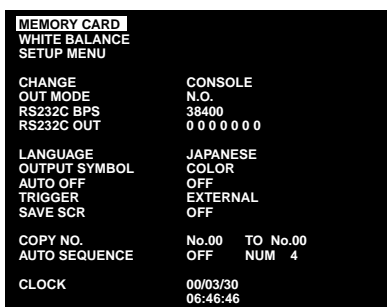

3. Place the cursor on [SAVE SCR] and press the [ENT] key.

The cursor goes to the item in the right column.



4. Change the settings using the [▲]/[▼] cursor key. Setting options are as follows:

OFF: The screens are not saved.

ALL: All captured screens are saved.

NG: Only unacceptable images are saved.



- **With the panel keys**  
Press the [▲] or [▼] cursor key.
  - **With the remote control console**  
Move the [ENT] key up or down.
5. Press the [ENT] key to confirm the setting.
  6. Press the [ESCAPE] key to return to the PROGRAM screen.

## Reading saved screens

1. Put the CV-701(P)/751(P) in “PROGRAM” mode.
2. Place the cursor on [OPTION] and press the [ENT] key.  
The option selection menu appears.

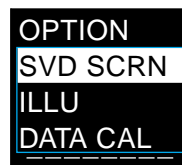

3. Place the cursor on [SVD SCRN] and press the [ENT] key.  
The cursor goes to [SCRN SEL].

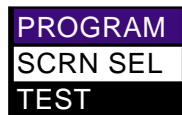

4. Press the [ENT] key.  
The list of saved screens appears. The list is in descending order from the last saving.

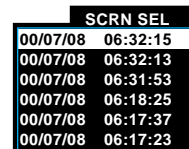

5. Select the desired saved screen for display.  
Placing the cursor on the desired option changes the screen display.

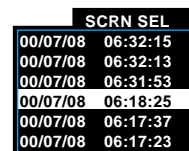

- **With the panel keys**  
Press the [▲] or [▼] cursor.
  - **With the remote control console**  
Move the [ENT] key up and down.
6. Press the [ENT] key to confirm the selection.  
To display the saved screen, press the [ESCAPE] key to return to the initial menu screen.  
To check the measured data with the saved screen, go to the next step.

7. Place the cursor on [TEST] and press the [ENT] key.

The measured data with the saved screen is displayed.



**Tips** The test mode of the saved screen does not output the detection results.

8. Press the [ENT] key to return to the initial menu screen.

### 4.11.2 Illumination adjustment function

The illumination adjustment function automatically adjusts the intensity of illumination. A variation in luminance over time does not affect the stability of the detection. The illumination adjustment function is available with all measurement modes; however, it cannot follow sporadic changes. The illumination for the first trigger input under the trigger mode is not adjusted.

#### Processing time of the illumination adjustment

- **“ARE/CON” mode**  
There is a delay of approx. 0.3 seconds before the illumination is adjusted; however, the total processing remains unchanged.
- **“INS/TRG” mode**  
The processing time remains unchanged.
- **“INS+POS”, “ABS.POS”, and “REL.POS” modes**  
The processing time remains unchanged.

1. Place the cursor on [OPTION] in the main menu and press the [ENT] key.

The option menu appears.

2. Place the cursor on [ILLU] and press the [ENT] key.

The cursor goes to [CAM1].

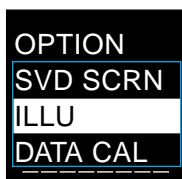

3. Place the cursor on [CAM1] or [CAM2] and press the [ENT] key.

The ON/OFF selection menu appears.



4. Place the cursor on [ON] and press the [ENT] key.

A window (frame) appears on the screen.

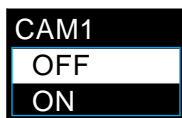

5. Move the [ENT] key to set a window with a constant luminance to a desired area outside of the target.



6. Press the [ENT] key.

The window position is confirmed.

7. Press the [ESCAPE] key to confirm the setting and exit the selection menu.

**Note:** Set the window for illumination adjustment to an area with medium brightness. Setting the window in areas with too much or too little luminance will saturate the illumination adjustment function with slight changes in brightness, leading to unstable detection.

### 4.11.3 Unit conversion

Converting a measured value

The measured value is normally displayed in units of pixels. When the data calculation is set, the value can be displayed in mm. The displayed value is converted based on the set conversion ratio.

#### Tips

The output from the terminal is an unconverted value.

1. Place the cursor on [OPTION] and press the [ENT] key. The option menu appears.
2. Place the cursor on [DATA CAL] and press the [ENT] key.

The data calculation menu appears.

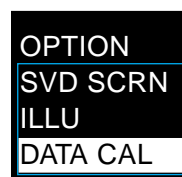

3. Set the conversion ratio.

The measured data is normally displayed in units of pixels. When a conversion ratio (multiple span) is set, the value can be displayed in mm. The conversion ratio can be specified from "0.01 times" through "100 times".

*Example* Number of pixels x Span = mm

- 1) Place the cursor on [MULTIPLY] and press the [ENT] key. The first digit, "0", is shown as highlighted. You can enter a numerical value.

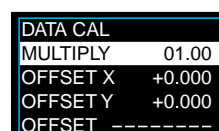

2) Move the [ENT] key to the right or left to select a digit to be changed.



3) Change the value.

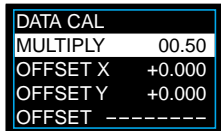

- **With the panel keys**

Press the [▲] cursor repeatedly.

- **With the remote control console**

Move the [ENT] key up repeatedly. The value increments by one, and after “9” the second digit is incremented. Pressing the [▼] cursor or moving the [ENT] key down decrements the value to “0”.

4) Press the [ENT] key.

The conversion ration is confirmed.

#### 4. Set the offset function.

When two areas are picked up with two cameras, the distance between the two areas is interpolated by the offset function to calculate the actual size. Set the offset values for both [OFFSET X] (X-axis direction) and [OFFSET Y] (Y-axis direction).

*Example* Number of pixels x Span + Offset = mm

1) Place the cursor on [OFFSET X] and press the [ENT] key. The first digit, “0”, is shown as highlighted. You can enter a numerical value.

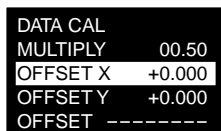

2) Move the [ENT] key to the right or left and select the digit to be changed.

3) Change the numerical value. The value increments by one, and after “9” the second digit is incremented. Pressing the [▲] cursor or moving the [ENT] key down decrements the value to “0”.



4) Press the [ENT] key.

The offset value for the X-axis direction is confirmed.

5) Place the cursor on [OFFSET Y] and repeat the above procedure.



**5. Set the enable/disable of the offset function.**

Set whether you want to enable or disable the offset function for each window.

○: Enabled

–: Disabled

- 1) Place the cursor on **[OFFSET]** and press the **[ENT]** key.
- 2) Move the **[ENT]** key to the right and left to select a desired window.
- 3) Change the setting with **[▲]/[▼]** cursor keys.
- 4) Press the **[ENT]** key.

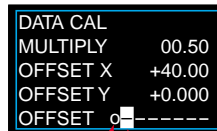

Window 1    Window 2

**6. Press the [ESCAPE] key.**

The data calculation function is set.

---

**Note 1:** The setting for MULTIPLY under DATA CAL is applied for all windows.

Select the enabled/disabled offset function for each window.

**Note 2:** The DATA CAL function is not activated when the INS mode is set to **[AREA]**, **[POINT]**, **[COUNT]**, **[STAIN]** or **[EDGE NO]**.

---

## 4.12 Operation Check of the Setting Status

The CV-701(P)/751(P) is able to save the state of focus, exposure and position after setting is complete. Use the saved data to compare and check with the initial condition when there is a change of target.

### 4.12.1 Saving the setting status

Save the focus and exposure under the current setting.

- 1. Prepare a test piece. Prepare a sheet of white paper with a rectangle filled in black.**

Make sure the length of the longitudinal side of the rectangle is about 1/4 of the field of view. You can set a desired aspect ratio.

- 2. Put the CV-701(P)/751(P) to "PROGRAM" mode.**

- 3. Hold down the [ESCAPE] key for at least two seconds.**

The environmental setting menu appears on the screen.

- 4. Place the cursor on [SETUP MENU] and press the [ENT] key.**

The setup menu appears on the screen.

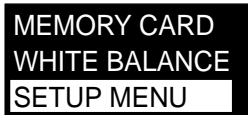

- 5. Place the test piece prepared in step 1 into the field of view. Make sure the black rectangle is in the center of the monitor screen. Place the test piece on a flat surface so that there is no curvature or warp of the piece.**

The screen updates every time the [TRIG] key is pressed.

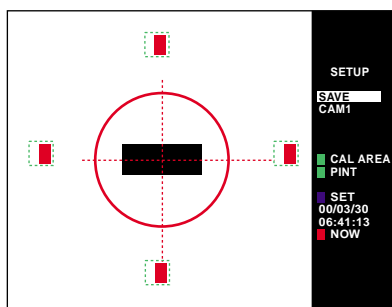

**Note:** Be sure the black rectangle does not cover the exposure bars on the four sides of the screen.

When CAM2 is set, place the cursor on [CAM1] and press the [ENT] key to select the camera.



6. Place the cursor on [SAVE] and press the [ENT] key.

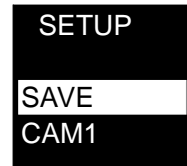

7. The saving of settings is completed.

Press the [ESCAPE] key to display the environmental setting menu.

### 4.12.2 Comparing with the saved setting status

Compare the saved setting status with the current setting status.

1. Put the CV-701(P)/751(P) into “PROGRAM” mode.

2. Hold down the [ESCAPE] key for at least two seconds.

The environmental setting menu appears on the screen.

3. Place the cursor on [SETUP MENU] and press the [ENT] key.

The setup menu appears on the screen.

4. Place the test piece prepared in step 1 of “Saving the setting status” on the previous page into the field of view. Make sure the black rectangle is in the center of the monitor screen. Place the test piece on a flat surface so that it will not have any R.

Make sure to use the same test piece used for the previous saving. The screen updates every time the [TRIG] key is pressed.

5. Compare the saved status and current status.

Check the screen for the exposure and focus status.

The blue lines indicate saved status, and the red lines indicate the current status.

The longer bar indicates an increased exposure to light.

The larger circle indicates a looser focus.

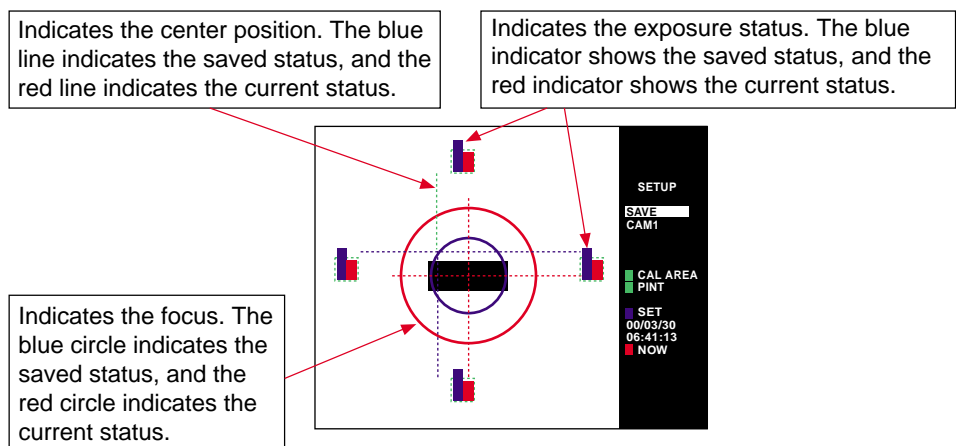

**Note:** Be sure the black rectangle does not cover the exposure bars on the four sides of the screen.

6. Adjust all of the settings so that they will agree with the saved status.

7. The operation check of the setting status is complete.

Press the [ESCAPE] key to display the environmental setting menu.

## 4.13 Initialization

Initialize the settings when you want to reset all of the settings or when the CV-701(P)/751(P) operates abnormally.

**Note 1:** Initialization clears all settings to the factory-set values.

**Note 2:** If you need to save the settings, save them in the CompactFlash memory, personal computer through the RS-232C, or take note of the necessary settings.

### 4.13.1 Initialization of all settings

1. Hold down the [CLEAR] key and turn on the power.

The message <INIT SETTING> appears on the screen and initialization starts.

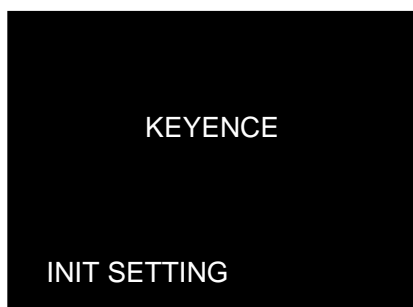

### 4.13.2 Initialization by program number

You can initialize the settings of one of the 16 programs from 0 to 15 by selecting the saved program number.

1. Use the [ENT] and [ESCAPE] keys to place the cursor on the [No.] of the program to be initialized.

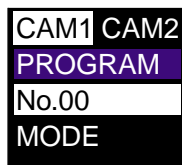

2. Hold down the [CLEAR] key for at least two seconds.

The message <ERASE SETTINGS N/Y> appears on the screen.

- To cancel initialization, select [N] and press the [ENT] key.
- To execute initialization, select [Y] and press the [ENT] key.

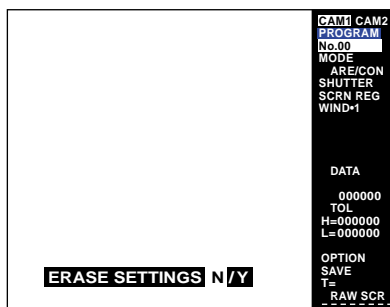



## 4.14 Input/Output Operation in PROGRAM Mode

Even in PROGRAM mode, the CV-701(P)/751(P) accepts a trigger input or provides a BUSY output so that the detection result and numerical value are displayed on the screen. A comparator output is not provided. Use the result and value as a test operation for adjustment.

The following table lists the input/output operations in PROGRAM mode.

I/O terminal/ connector	Signal name	Description	Status
Input terminal	TRG	Trigger input for timing signal	Enabled
Input connector	PST	Data output selection input	Disabled
	REC1/REC2	Screen registration input (Registers a screen at a TRG signal when this pin is short-circuited.)	Disabled
	C10 to C13	Program No. input 0 (LSB)	Disabled
	W10 to W12	Output window selection input	Disabled
	CONT	Starts continuous operation when the program is switched without an external trigger signal.	Disabled
Output terminal	W01 to W08	Window comparator output	Disabled
	WOR	OR output of W01 to W08	Disabled
	STO	Strobe signal output for output	Disabled
Output connector	BUSY	BUSY signal output	Enabled
	D.POLE	Position data signal output	Disabled
	D0 to D12	Data output	Disabled

**Note:** A trigger input is not accepted in PROGRAM mode during setting procedures such as drawing a window or setting values. A trigger input is accepted only when the [TRIGGER] key on the panel keys or the remote control console can be used.

## 4.15 Environmental Settings

The environmental settings include the display settings and external input settings. This section describes each environmental setting and the procedure for changing the settings.

### 4.15.1 Changing the environmental settings

You can set or check the following items in the environmental settings.

⇒ See page 145 for details.

1. Put the CV-701(P)/751(P) in “PROGRAM” mode.
2. Press the [ESCAPE] key for at least two seconds.

The environmental setting menu appears.

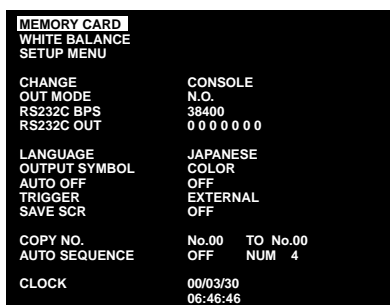

MEMORY CARD	
WHITE BALANCE	
SETUP MENU	
CHANGE	CONSOLE
OUT MODE	N.O.
RS232C BPS	38400
RS232C OUT	0 0 0 0 0 0
LANGUAGE	JAPANESE
OUTPUT SYMBOL	COLOR
AUTO OFF	OFF
TRIGGER	EXTERNAL
SAVE SCR	OFF
COPY NO.	No.00 TO No.00
AUTO SEQUENCE	OFF NUM 4
CLOCK	00/03/20
	06:46:46

3. Place the cursor on the desired item.
4. Press the [ENT] key.
 

The cursor goes to the item in the right column.
5. Change the setting.
  - **With the panel keys**  
Press the [▲]/[▼] cursor key.
  - **With the remote control console**  
Move the [ENT] key up or down.
6. Press the [ENT] key.
 

The setting is confirmed.
7. Press the [ESCAPE] key to return to the PROGRAM menu.

## 4.15.2 Environmental setting list

\*\*\* indicates the initial setting value.

Parameter	Setting	Description	Function
MEMORY CARD	To sub menu. ☞ See page 171 for details.	Save/read the settings and saved screen to/from the CompactFlash memory.	To save/readout the settings and saved screen to/from the CompactFlash memory.
WHITE BALANCE	To sub menu. ☞ See page 148 for details.	Adjust the white balance.	To adjust the white balance.
SETUP MENU	To sub menu. ☞ See page 140 for details.	Save/readout the settings of focus, exposure, and reference position.	To compare the settings.
CHANGE	CONSOLE*	Use the remote control console to change the program No.	To change the program No. with the remote control console.
	TERMINAL	Use the I/O connector to change the program No. or the output window.	To change the program No. or the output window by inputting an external signal to the I/O connector during RUN mode.
OUTMODE	N.O.*	Normally-open	To output when the detection result is outside of the tolerance range.
	N.C.	Normally-closed	To output when the detection result is within of the tolerance range.
RS-232C BPS	9,600/19,200/38,400*	Set the communication speed.	To change the communication speed. (No. of bits/sec.)
RS-232C OUT	0000000	Select the RS-232C output data.	To select the data type output by RS-232C.
LANGUAGE	JAPANESE*	Use the Japanese language.	To change the menu display to Japanese.
	ENGLISH	Use the English language.	To change the menu display to English.
OUTPUT SYMBOL	COLOR*	Displays the detection result with green, red, and white indicators.	When a color monitor is used.
	MONO	Displays the detection result with ○, x, ? and – symbols.	When a black-and-white monitor is used.
AUTO OFF	OFF*	Disable automatic backlight shut-off.	To turn on the backlight all the time.
	ON	Enable automatic backlight shut-off. (CV-751(P) only)	To turn off the backlight automatically. (Backlight operating life: 40,000 hrs.)
TRIGGER	EXTERNAL*	Execute detection at each trigger input.	To control detection with external trigger input.
	INTERNAL	Execute detection continuously without external trigger inputs by internally producing trigger signals from power-on.	To repeat detection without using external trigger signals in the trigger mode.
SAVE SCR	OFF*	No screens are saved.	To save a screen.
	ALL	Saves all screens regardless of the detection result.	
	NG	Saves the captured screen with an unacceptable detection result.	

Parameter	Setting	Description	Function
COPY NO.	Source program No. (00 to 15), Target program No. (00 to 15) ⇒ See page 146 for the setting.	Set the source and target program Nos. and select OK to copy.	To copy the settings of one program No. to another program No.
AUTO SEQUENCE	⇒ See page 147 for the setting.	OFF	Normal operation
		Set the program Nos. for sequential operation. (MODE1)	To execute several program Nos. sequentially with one trigger signal.
		Set the program Nos. for sequential operation. (MODE2)	To execute several program Nos. sequentially with one trigger signal. The position adjustment function and the starting No. use common data.
CLOCK	Calendar input	Input the present time and date.	To adjust the calendar.

### 4.15.3 Useful functions

#### Automatic backlight shut-off [AUTO OFF] (CV-751(P) only)

Turns off the backlight of the monitor automatically. To activate this function, place the cursor on [AUTO OFF] in the environmental setting menu and select "ON". (The backlight has an operating life of 40,000 hours.)

- The backlight is turned off under the following conditions:  
10 or more minutes have passed since the last key operation, detection of results outside of the tolerance range, or message appearances on the screen.
- The backlight is turned on again when one of the following occurs:  
Any key is pressed.  
A control signal is input from the external devices through RS-232C.  
The detection result goes outside of the tolerance range.  
A message appears on the screen.

#### Copying the program number [COPY NO.]

The settings of one program number can be copied to another program number.

**1. Place the cursor on [COPY NO.] and press the [ENT] key.**

The cursor goes to the source number field.

**2. Press the [▲]/[▼] cursor keys or move the [ENT] key up or down to select the source program number and press the [ENT] key.**

The cursor goes to the target number field.

**3. Press the [▲]/[▼] cursor keys or move the [ENT] key up or down to select the target program number and press the [ENT] key.**

The cursor goes to [OK?].

**4. Press the [ENT] key to copy the settings.**

When the [ESCAPE] key is pressed at any time during the procedure, the cursor returns to [COPY NO.].

## Sequential operation [AUTO SEQUENCE]

Executes the operations of several programs sequentially with one trigger signal by automatically switching the program numbers. The limitations below are placed on the first program number. Up to four programs starting from the first program number can be sequentially processed. (⇒ See page 164 for the timing diagrams).

**Note 1:** The first program number can be set with the I/O terminal/connector when [CHANGE] in the environmental setting menu is set to [TERMINAL].

**Note 2:** The CV-701(P)/751(P) bypasses the program number under [ARE/CON] mode and unused program numbers.

e.g.) When the number for [AUTO SEQUENCE] processing is set to 4 with the following settings, only program No. 0 will be processed.

No.0: [ABS. POS]  
No.1/2/3: [ARE/CON]

Setting parameters			
AUTO SEQUENCE	OFF	Num	2
	MODE1		3
	MODE2		4

The [Num] in the setting parameters indicates the number of programs to be processed sequentially.

<e.g.>

When the first program number is set to No.4 and [Num] is set to 2, program Nos. 4 and 5 are processed sequentially.

<Requirements for the first program number>

[Num]=2: The first program numbers can be selected from 2n (0, 2, 4, 6, 8, 12, 14) only.

[Num]=3/4: The first program numbers can be selected from 4n (0, 4, 8, 12) only.

**Note:** When the selected first program number does not satisfy the requirements, the [AUTO SEQUENCE] function is not activated and only the selected program number will be processed.

### Tips

When a trigger signal is input and the CV starts processing, the display is fixed to the screen of the first program number.

1. Set the program numbers in advance for sequential operation.
2. Place the cursor on [AUTO SEQUENCE] and press the [ENT] key.  
The cursor goes to [OFF].
3. Press the [▲]/[▼] cursor key to set the parameters for [AUTO SEQUENCE].

<b>MODE2</b>	Executes the operations of several programs sequentially at one trigger signal. Up to four programs can be processed. The position adjustment function uses the data of the first program number to process the other programs.
<b>MODE1</b>	Executes the operations of several programs sequentially at one trigger signal. (Up to four programs can be processed.)
<b>OFF</b>	Executes normal operation.

**Note:** When the AUTO SEQUENCE is set to MODE2, the CV processes programs of [INS+POS] mode.

4. Press the [ENT] key.  
The cursor goes to "2".
5. Press the [▲]/[▼] cursor key to select the value for [Num].
6. Press the [ENT] key and return to the environmental setting menu.

## Adjusting the white balance

Adjust the image using the actual illumination for detection so that white objects are projected in white. Adjustments of the white balance are required every time the targets and illumination are changed.

1. Place the cursor on [WHITE BALANCE] and press the [ENT] key.

The adjustment menu appears on the screen.

- A frame and message "REGISTER WHITE T" appears on the screen. Place a sheet of white paper in front of the camera.
- The screen updates with every trigger signal input.

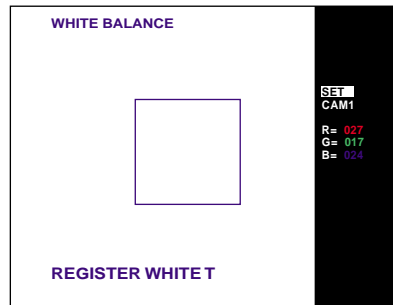

2. Place the cursor on [SET] and press the [ENT] key.

The white balance for camera 1 is adjusted.



3. Press the [ESCAPE] key to return to the environmental setting menu when only one camera is connected. When two cameras are connected, go to step 4.

4. Place the cursor on [CAM1] and press the [ENT] key.

[CAM2] is selected and the adjustment menu for camera 2 appears.

- A frame and message "REGISTER WHITE T" appears on the screen. Place a sheet of white paper in front of the camera.
- The screen updates with every trigger signal input.



5. Place the cursor on [SET] and press the [ENT] key.

The white balance for camera 2 is adjusted.



6. Press the [ESCAPE] key to return to the environmental setting menu.

## Adjusting the clock

Adjust the time and date of the clock built into the CV-701(P)/751(P).

### 1. Place the cursor on [CLOCK] and press the [ENT] key.

The digit of the year is shown as highlighted. You can adjust the setting.

The time and date are displayed as follows:

Year/Month/Date  
Hour/Minute/Second

```
COPY NO.
AUTO SEQUENCE
CLOCK
```

### 2. Move the cursor to the right and left to select the digit to be changed.

```
CLOCK 00/04/07
12:49:57
```

### 3. Press the [▲]/[▼] cursor key or move the [ENT] key up/down repeatedly.

```
CLOCK 00/07/07
12:49:57
```

- **With the panel keys**

Press the [▲] cursor key repeatedly.

- **With the remote control console**

Press the [ENT] key up repeatedly. The value increments, and after “9” the second digit is incremented. Every time the [▼] cursor key is pressed or the [ENT] key is held down, the value decrements to “0”.

### 4. Press the [ENT] key.

The setting is confirmed.

### 5. Press the [ESCAPE] key to return to the environmental setting menu.

---

**Note:** “Second” cannot be adjusted.

---

## Setting the RS-232C output data

Select the format of data to be output with RS-232C communication.

⇒ See page 182 for data formats.

RS-232C OUT 0 0 0 0 0 0 0 0

The numbers indicate (from the left):

Data 0: Output setting of judgment result	(0: OFF, 1: ON)
Data 1: Output setting of number of pixels	(0: OFF, 1: ON)
Data 2: Output setting of the measured value [INS] mode	(0: OFF, 1: ON)
Data 3: Output setting of X coordinate	(0: OFF, 1: ON)
Data 4: Output setting of Y coordinate	(0: OFF, 1: ON)
Data 5: Output setting of correlation ratio	(0: OFF, 1: ON)
Data 6: Output setting of rotation angle	(0: OFF, 1: ON)

All settings are factory-configured to 0.

#### Tips

### 1. Place the cursor on [RS-232C OUT] and press the [ENT] key.

The first digit is shown as highlighted. You can change the settings.

```
RS232C BPS 38400
RS232C OUT 0000000
```

### 2. Move the cursor to the right and left to select the digit to be set.

```
RS232C BPS 38400
RS232C OUT 1000000
```

3. Press the [▲]/[▼] cursor key or move the [ENT] key up or down to change the value.
4. Press the [ENT] key after setting all digits.

The CV returns to the environmental setting menu.



# Chapter 5

---

## Operation

This chapter describes RUN mode and the controls available during RUN mode operation.

<b>5.1</b>	<b>Entering RUN Mode .....</b>	<b>152</b>
<b>5.2</b>	<b>Controls Available in RUN Mode .....</b>	<b>153</b>

## 5.1 Entering RUN Mode

This section describes RUN mode. Before entering RUN mode, complete the settings described in “Chapter 4 Setting Procedure”.

### 1. Change the PROGRAM mode to RUN mode.

- **With the panel keys**

Hold down the [RUN/PROGRAM] key for at least two seconds.

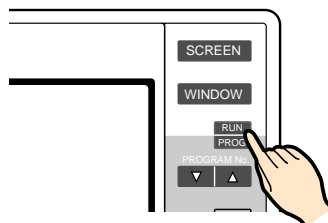

- **With the remote control console**

Use one of the following two methods to enter RUN mode.

- Slide up the mode selection switch to “RUN”.
- Unplug the remote control console from the controller.

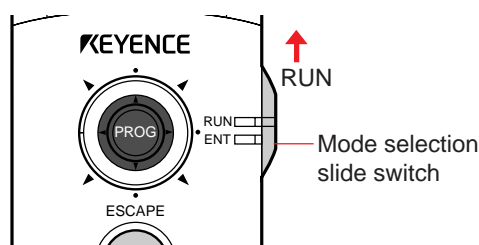

### 2. Once the CV-701(P)/751(P) enters RUN mode, [RUN] appears in the upper right of the screen.

- When “ARE/CON” mode is selected, the CV-701(P)/751(P) starts and continues detection, judgment, and displaying results.
- When a mode other than “ARE/CON” mode is selected, the CV-701(P)/751(P) starts detection, judgment, and displaying results every time a trigger signal is input.

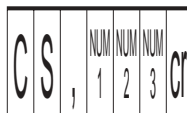

**Note:** Once the CV-701(P)/751(P) enters RUN mode, the setting operation from the remote control console or the panel keys is disabled. You can use only the [SCREEN], [TRIG], [PROGRAM No.], and [WINDOW] keys and the mode selection slide switch.

## Key-lock function (CV-751(P))

When the key-lock function is activated, the operation of all keys except for the [SCREEN] and [WINDOW] keys is disabled to prevent accidental key operation. Set the key-lock function in PROGRAM mode before entering RUN mode.

### ■ To set the key-lock function

Hold down the [◀] and [▶] cursor keys simultaneously for at least two seconds. When the function is activated, [KEY LOCK] appears at the bottom of the menu screen.

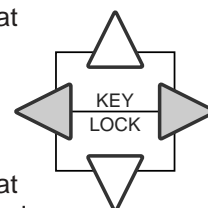

### ■ To cancel the key-lock function

Hold down the [◀] and [▶] cursor keys simultaneously for at least two seconds. The display [KEY LOCK] disappears and key operation is enabled.

## 5.2 Controls Available in RUN Mode

In RUN mode, the CV-701(P)/751(P) can be controlled using external signals through the I/O terminals and RS-232C.

Mode	How to enter the mode	Available operations	Reference page
RUN	Set CHANGE in the environmental setting menu to CONSOLE and then set the console's slide switch to "RUN".	Terminal/ connector  Judgment result/numerical value output Trigger (TRG) input Coordinate value X/Y selection (PST) (Only when pattern search or edge search in both the X and Y directions is set.)	156
	Unplug the remote control console from the controller.	Console  Trigger input Screen selection Window No. selection for display/data output RUN/PROGRAM selection	152
	Send the "R0cr" command when the CV is in communication mode.	RS-232C  Trigger input Data output	187
RUN (External control)	Set CHANGE in the environmental setting menu to CONSOLE and then set the console's slide switch to "RUN".	Terminal/ connector  Judgment result/numerical value output Trigger (TRG) input Coordinate value X/Y selection (PST) (Only when pattern search or edge search in both the X and Y directions is set.) Window No. selection for display/data output (Wlx)	156
	Unplug the remote control console from the controller.	Console  Trigger input Screen selection RUN/PROGRAM selection	152
	Send the "R0cr" command when the CV is in communication mode.	RS-232C  Trigger input Data output	187
Screen registration	Short-circuit the REC1 • REC2 and COM2 terminals when the CV is in RUN or RUN [EXT] mode.	Terminal/ connector  Screen registration (By short-circuiting the TRG and COM1 terminals.)	164
Communication	Send the "O0cr" command.	RS-232C  Reading/writing output setting Reading/writing setting data Reading/writing registered screen Reading/writing program number Screen registration Reading input screen Saving setting data	188

# MEMO

5

# Chapter 6

---

## I/O Timing and Analog Output

Explains the input/output timing and analog output.

<b>6.1</b>	<b>I/O Terminal Names and Functions</b> .....	156
<b>6.2</b>	<b>Input/Output Timing Diagrams</b> .....	160
<b>6.3</b>	<b>I/O Circuit</b> .....	165
<b>6.4</b>	<b>Analog Output</b> .....	166
6.4.1	Analog output terminals .....	166
6.4.2	Changing analog output settings .....	166
6.4.3	Scaling the analog output .....	167

## 6.1 I/O Terminal Names and Functions

This section describes the names and functions of I/O terminals/connectors and the position of analog output.

### The position of I/O terminals

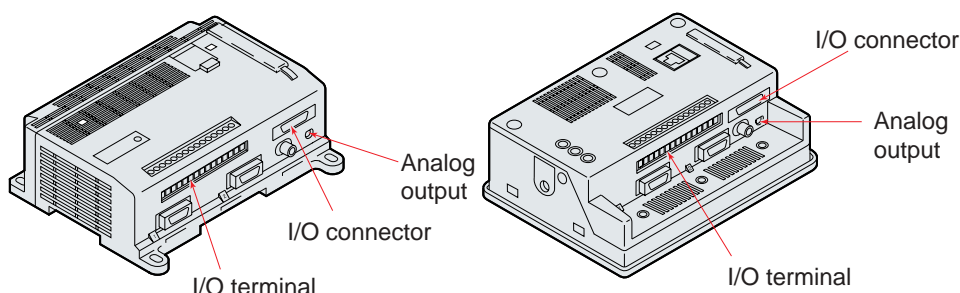

### Names and functions of I/O terminals and I/O connectors

- I/O terminal

Terminal No. (controller side)

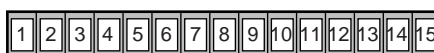

Terminal No.	Signal name	Description
1	24 VDC	24 VDC power supply input
2	0 V	0 V for power supply input
3	See the table below.	
4	TRG	Trigger input for timing signal
5	See the table below.	
6	See the table below.	
7	WO1	Window 1 comparator output
8	WO2	Window 2 comparator output
9	WO3	Window 3 comparator output
10	WO4	Window 4 comparator output
11	WO5	Window 5 comparator output
12	WO6	Window 6 comparator output
13	WO7	Window 7 comparator output
14	WO8	Window 8 comparator output
15	WOR	OR output of WO1 to WO8

#### NPN (CV-701/751)

3	COM1	Common signal (0 V) for inputs/outputs
5	STO	Strobe signal output for output
6	COM1	Common signal (0 V) for inputs/outputs

#### PNP (CV-701P/751P)

3	V1	Power supply for PNP output (5 to 24 V)
5	COM1	Common signal (0 V) for inputs/outputs
6	STO	Strobe signal output for output

COM1 terminals 3 and 6 are common.



**Terminal 0 V (for power supply input), COM1, and COM2 are common via a choke coil. Be sure that there is no potential difference among the three terminals.**

## ● I/O connector

Connector pin No. (controller side)

16	15	14	13	12	11	10	9	8	7	6	5	4	3	2	1
32	31	30	29	28	27	26	25	24	23	22	21	20	19	18	17

Pin No.	Signal name	Description	Cable color*
1		Input terminal (not to be used)	Brown
2	CI0	Program No. input 0 (LSB)	Red
3	CI1	Program No. input 1	Orange
4	CI2	Program No. input 2	Yellow
5	CI3	Program No. input 3 (MSB)	Green
6	COM2	Common signal (0 V) for inputs/outputs	Blue
7	COM2	Common signal (0 V) for inputs/outputs	Purple
8	D0	Data output 0 (LSB)	Gray
9	D1	Data output 1	White
10	D2	Data output 2	Black
11	D3	Data output 3	Brown
12	D4	Data output 4	Red
13	D5	Data output 5	Orange
14	D6	Data output 6	Yellow
15	D7	Data output 7	Green
16	D8	Data output 8	Blue
17	D9	Data output 9	Purple
18	D10	Data output 10	Gray
19	D11	Data output 11	White
20	D12	Data output 12 (MSB)	Black
21	P.POLE	Position data sign output (output upon negative signal)	Brown
22	See the table below.		
23	See the table below.		
24	PST	Data output selection input	Yellow
25	WI0	Display and output window selection input 0 (LSB)	Green
26	WI1	Display and output window selection input 1	Blue
27	WI2	Display and output window selection input 2	Purple
28	CONT	Continuous operation input (When a program is switched, continuous judgment starts without an external trigger signal.)	Gray
29	BUSY	BUSY signal output	White
30	REC1	Screen registration input Camera 1	Black
31	REC2	Screen registration input Camera 2	Brown
32		Unused terminal	Red

## NPN (CV-701/751)

22	COM2	Common signal (0 V) for inputs/outputs	Red
23	COM2	Common signal (0 V) for inputs/outputs	Orange

## PNP (CV-701P/751P)

22	—	Unused terminal	Red
23	—	Unused terminal	Orange

COM2 terminals 6, 7, 22, and 23 are common.

\* The colors represent the cable colors used in the special I/O cable (option: OP-35341).

Data outputs (D0 to D12) are 13-bit binary outputs (negative-true logic). D0 (LSB) to D12 (MSB) signals are in one-to-one correspondence with 1.2.4.8...4096, and they read data by doing sums of the terminals that are turned on.

**Tips**

For screen registration input TRG with the REC (1 and/or 2) input. Simultaneous inputs of REC 1/2 and CONT show the raw screen with a cross-shaped cursor in the center.

## Binary data input (Output window selection input)

Input			Window No.
W0	W1	W2	
OFF	OFF	OFF	1
ON	OFF	OFF	2
OFF	ON	OFF	3
ON	ON	OFF	4
OFF	OFF	ON	5
ON	OFF	ON	6
OFF	ON	ON	7
ON	ON	ON	8

## Binary data output format from D0 to D12

The format of binary data output varies depending on the measurement mode.

**Note:** The data output from the terminals is not binary-converted.

Mode	Sub-mode	PST Selection	Output data
AREA		Open	The last 13 bits of AREA measured data.
		Closed	The first 13 bits of AREA measured data.
EDGE	OUTER/ INNER	Open	Edge measurements
		Closed	Edge measurements
	GAP/PITCH	Open	Pitch average value
		Closed	Pitch average value
	EDGE NO	Open	Edge number
		Closed	Edge number
COUNT		Open	Count number
		Closed	Count number
POINT		Open	Dn <sup>1</sup> : Pn <sup>2</sup> . [OFF: background, ON: extraction color] <sup>3</sup> .
		Closed	The detection result of Dn <sup>1</sup> : Pn <sup>2</sup> . [OFF: x, ON: ○] <sup>3</sup> .
STAIN		Open	Measured data
		Closed	Measured data
GRAVITY		Open	X coordinate of the detected point
		Closed	Y coordinate of the detected point
PATT		Open	X coordinate of the detected point
		Closed	Y coordinate of the detected point
EDGE MODE		Open	X coordinate of the detected point
		Closed	Y coordinate of the detected point

1. The nth bit of output data
2. Point n
3. 1: ON/ 0: OFF
4. The decimal point is not output. (The ten-times value of the displayed value is output.)



## Point sensor (Supplemental)

The status of each point (extracted color/non-extracted color) is output when the PST terminal is open.

The detection result of each point is output when the PST terminal is short-circuited. (Turns ON when the results agree with the [SET] of each point.)

Point 1 to 8 output data corresponding to D0 to D7.

P1,	P2,	.....	P8
↓	↓		↓
D0,	D2	.....	D7

- **Analog output**

Use the special cable (OP-41420) for connection.

## 6.2 Input/Output Timing Diagrams

This section describes the timing diagrams in RUN mode for each measurement mode.

### ARE/CON timing

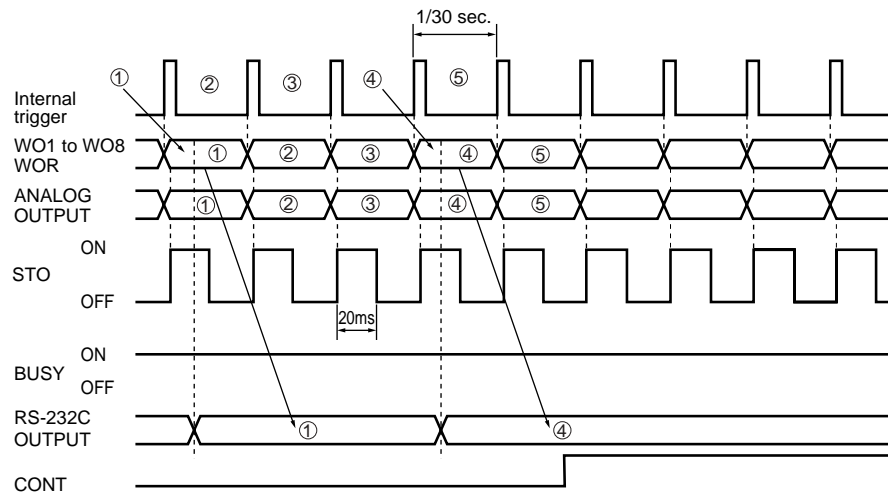

- The process is repeated every 1/30 of a second.
- The RS-232C output skips at a given interval. (The output cycle varies depending on the number of windows and the baud rate setting.)
- RS-232C data transmission is stopped when the CONT is short-circuited.

## INS/TRG and INS+POS timing

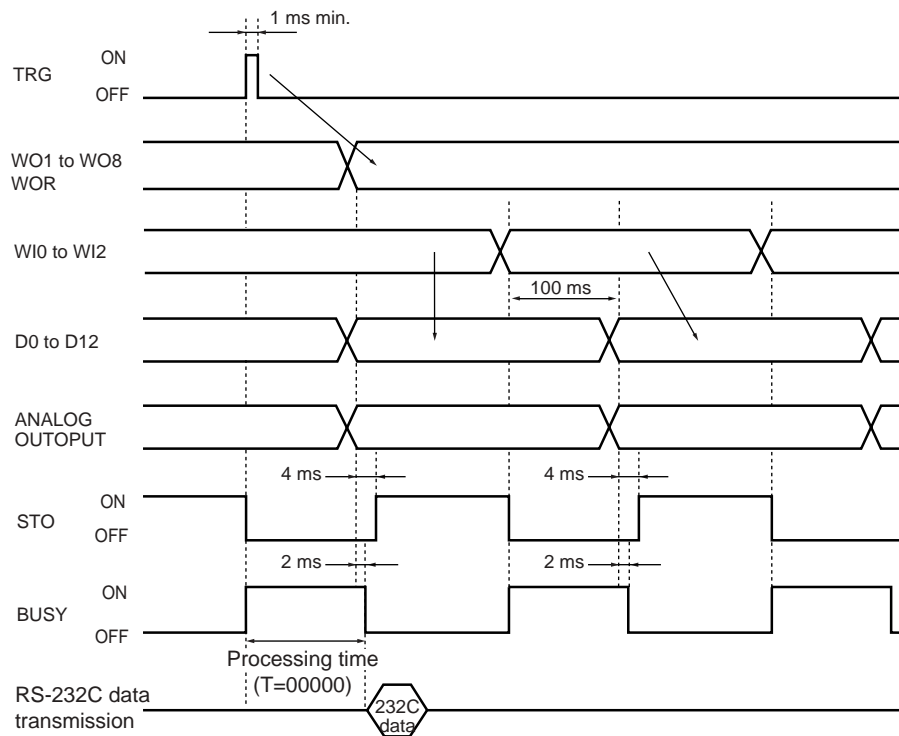

- At the moment of the TRG signal input, the STO output is turned off, and the BUSY output is turned on.
- When the TRG signal is input and the judgment result is determined, the outputs of WO1 to WO8 and WOR are provided, and the STO output is turned on. The previous judgment output is retained during the processing time. The RS-232C data transmission is also activated.
- The window data outputs (D0 to D12) show the data for the windows specified with the output window selection inputs (WI0 to WI2). The settings of WI0 to WI2 are effective even after the judgment result is determined. The STO output is turned off during the output window selection. Read the data while the STO output is on.
- To select windows using the WI0 to WI2 input signals, set "CHANGE" in the environmental setting menu to "TERMINAL".
- Limit the rising time variation of the binary data of WI0 to WI2 to 3 ms or less.
- The TRG input is accepted during RS-232C communication to start new processing. The RS-232C communication output is continued.
- The TRG input and the communication command are not accepted while the BUSY output is on.
- The STO output is turned off during the period between the first TRG input after power on, RUN mode selection or program number selection, and the determination of the judgment result.
- When the data transmission period of RS-232C communication is 33 ms or less, the period while the BUSY output is on or the processing time does not include RS-232C transmission time. It shifts to TRG waiting status after turning off the BUSY output at the end of the processing time. The transmission time varies with the number of windows, output settings (↔ See page 182), and the baud rate setting.

## ABS. POS and REL. POS timing

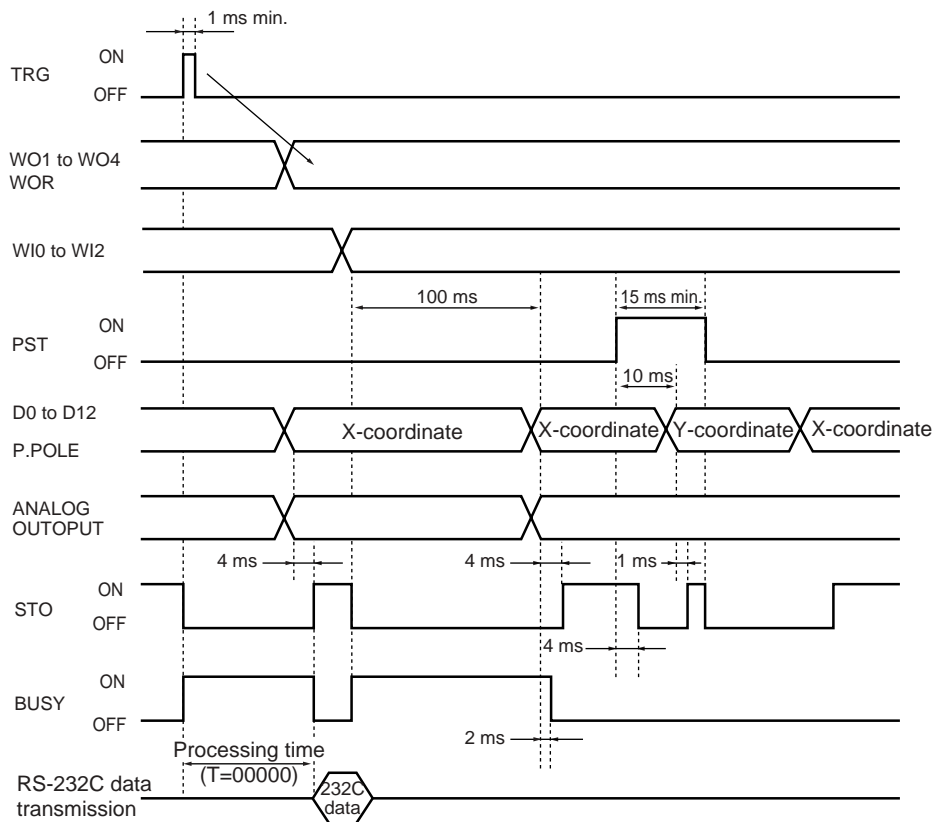

- When the TRG signal is input and the judgment result is determined, the outputs of WO1 and WOR are provided and the STO output is turned on. The previous judgment output is retained during the processing time.
- For the position data output, the X coordinate is output while the PST input is off, and the Y coordinate is output while the PST input is on. The PST input is effective after the judgment result is determined. While the X and Y coordinates are switched, the STO output is turned off. Read the data while the STO output is on.
- The STO output is turned off during the period between the first TRG input after power-on, RUN mode selection or program number selection, and the determination of the judgment result.

## Program number selection timing

### ● Continuous operation: OFF

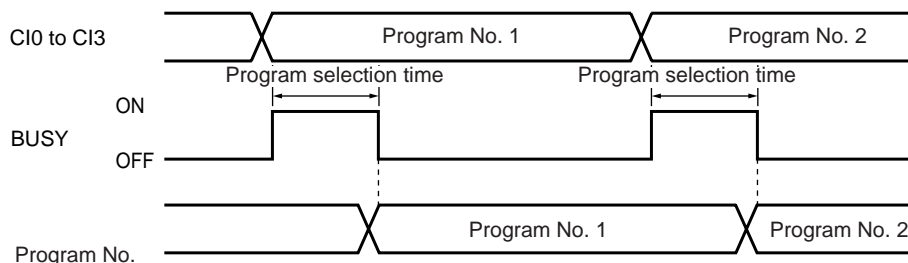

- To select a program number using the I/O terminal, set "CHANGE" in the environmental setting menu to "TERMINAL".
- The average program selection time is 230 ms. It depends on the settings.
- Limit the rising time variation of the binary data of a program number selection input to 3 ms or less.
- The CI0 to CI3 are level-locked.

## Continuous operation: ON

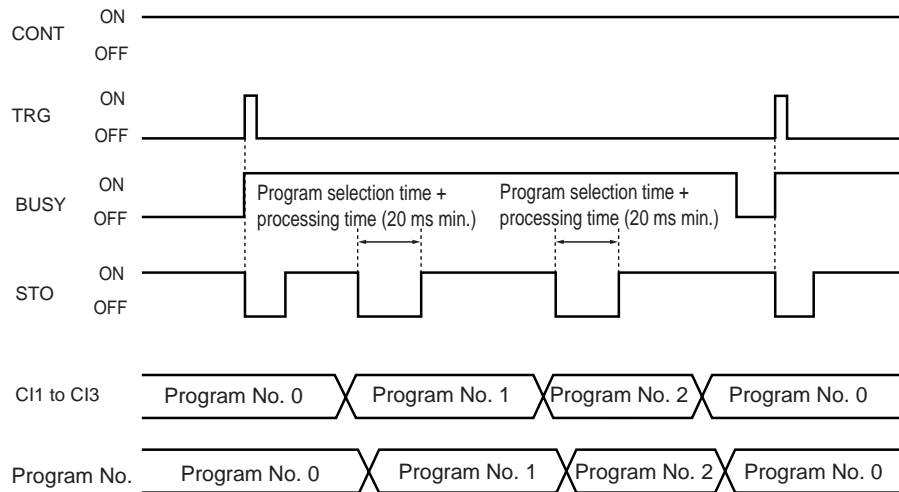

- When the program number is externally selected while the CONT input is on, the stored image is processed again with the new settings.
  - To turn on CONT input, set “CHANGE” in the environmental setting menu to “TERMINAL”.
  - The average program selection time is 230 ms. It depends on the settings.
  - Limit the rising time variation of the binary data of a program number selection input to 3 ms or less.
  - The C10 to C13 are level-locked.
  - The menu screen does not reflect continuous operation. Only the message “CONT” appears on the screen. The menu screen shows the measured value of the program number processed at the TRG input.
  - Continuous operation is completed when the program number returns to the number that was being processed when the TRG signal was input.
  - When CONT is off during operation, the display is changed to the program No. and continuous operation is terminated.
  - The WOR output is the OR output with all windows specified in continuous operation.
  - When CONT is input, the message “CONT” is shown at the bottom of the screen.
- \* The “AUTO SEQUENCE” mode is provided to process the operations of several preset programs sequentially by automatically switching the program numbers without any control of the I/O input.
- ☞ Refer to “Environmental Settings” on page 144 for details.

## Timing under AUTO SEQUENCE mode

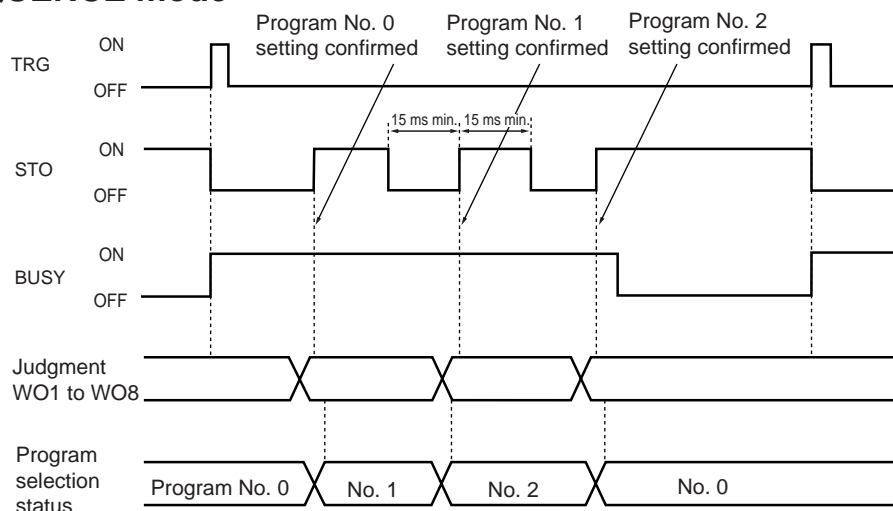

- At the moment the TRG input is turned on, the AUTO SEQUENCE mode starts processing. BUSY is turned on at the moment of TRG input, and it is turned off when the processing is completed.
- STO is turned off when TRG input is turned on, and it is turned on when the processing is completed and the judgment result is determined for each window.
- The judgment result varies with each program number. The previous judgment output is retained during processing.
- The total processing time is the period that BUSY is on.
- The WOR output is turned on when a window is judged as unacceptable in all of the settings.
- The characters “ATSQ” are shown at the bottom of the screen.

### ■ The processing of judgment result

- To judge one unacceptable result as “unacceptable”, check the common falling points of both WOR output and BUSY.
- If judgment results for each window of each program number are required, check the judgment output status with the PLC at every STO rising after the TRG (BUSY) rising. The number of STO risings after TRG input indicates the program number.

## Screen registration timing (RUN mode)

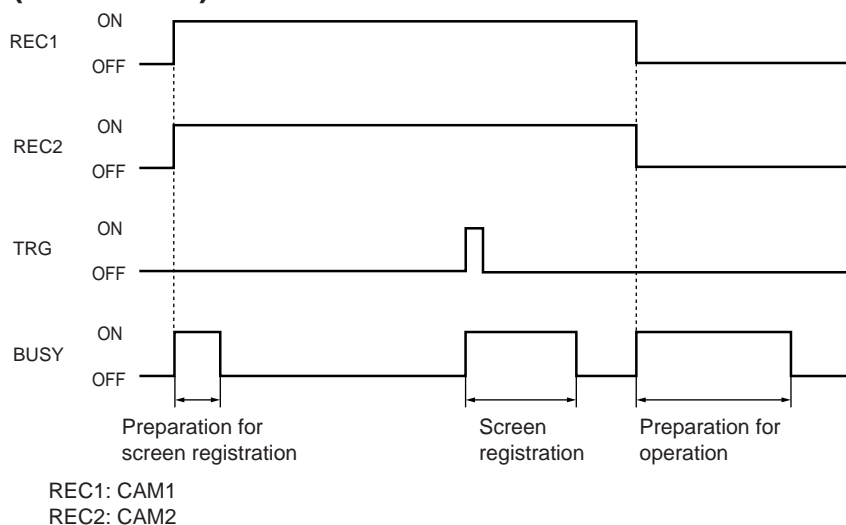

- When the CONT terminal is short-circuited while REC1/REC2 is short-circuited, the RAW SCREEN is displayed and the screen updates without TRG inputs. A cross-shaped cursor appears on the screen. During this period, the screen is not registered even when TRG signal is input.

## 6.3 I/O Circuit

This section describes specifications and circuit diagrams for each terminal.

### Input circuit diagram

#### NPN model

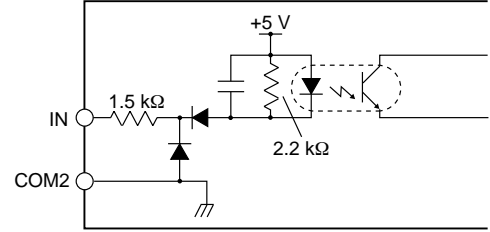
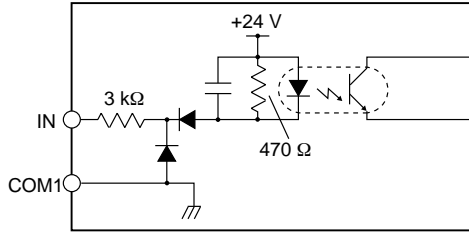

#### PNP model

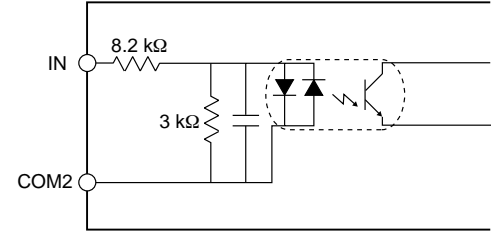
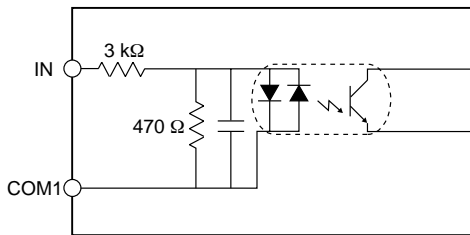

- Terminal name: TRG  
ON voltage: 10 V max. (PNP 10 V min.)  
ON current: 3 mA min.  
OFF voltage: 17 V min. (PNP 5 V max.)  
OFF current: 2 mA max. (PNP 1.5 mA max.)

- Terminal name: CI0 to CI3, PST, REC1 to 2, CONT, WI0 to WI2  
ON voltage: 1.5 V max. (PNP 10 V min.)  
ON current: 1.5 mA min.  
OFF voltage: 3 V min. (PNP 3 V max.)  
OFF current: 0.1 mA max.

### Output circuit diagram

#### NPN model

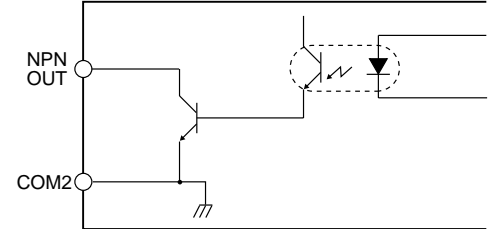
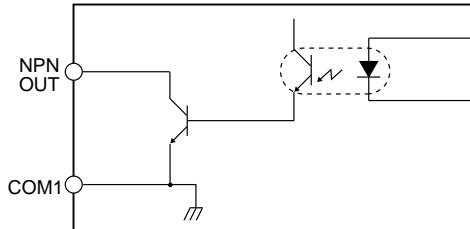

#### PNP model

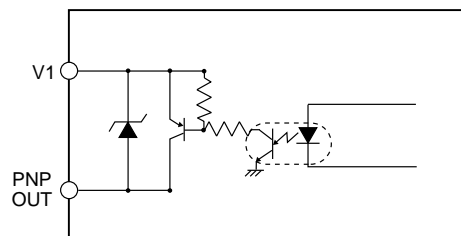

- Terminal name: STO, WO1 to WO8, WOR  
Maximum applied voltage: 30 V  
Maximum sink current: 50 mA  
Residual voltage: 1 V max.  
Leakage current: 0.1 mA max.

- Terminal name: D0 to D12, P.POLE, BUSY  
Maximum applied voltage: 30 V  
Maximum sink current: 10 mA  
Residual voltage: 1 V max.  
Leakage current: 0.1 mA max.



**Terminal 0 V (for power supply input), COM1, and COM2 are common via a choke coil. Be sure that there is no potential difference among the three terminals.**

## 6.4 Analog Output

### 6.4.1 Analog output terminals

#### ■ Connection

Connect the CV-701(P)/751(P) to the analog output device using a special cable (OP-41420).

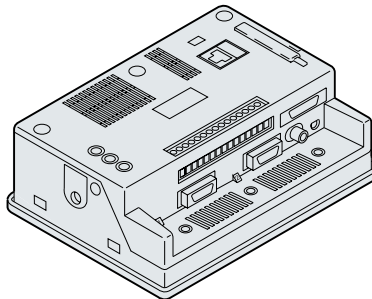

#### ■ Analog output

- Analog output bound: 0 to 4.095 V
- Analog output resolution: 12 bits
- Output impedance: 100  $\Omega$
- Analog output precision: 2 % of F.S.

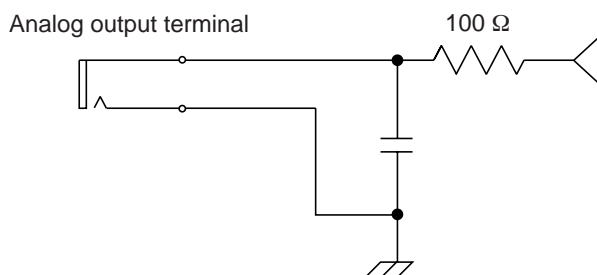

**CAUTION**

*GND for analog output, video output, and camera housing are common via a coil. Be sure that there is no potential difference among the three terminals.*

### 6.4.2 Changing analog output settings

The analog output of a measured value is available (output to a mini plug) in a range of 0 to 4 V. The analog output can be converted to an output voltage value by using a scaling method. The parameters of analog output can be set for each window. When the CV is in RUN mode, the voltage of the current measurement window is output.

#### **Tips**

- When the CV is operated with the initial settings, output voltage corresponds to the displayed measured value. For example, when “200.0” is displayed, the output voltage will be 2 V.
- When the CV is in PROGRAM mode, the output is always 0 V regardless of the displayed value.



### 6.4.3 Scaling the analog output

Set the scaling of analog output for each window.

This section describes a setting to output the "X" value of [ABS.POS] measurement mode.

1. Place the cursor on [WIND•1] in the main menu and press the [ENT] key.

The window selection menu appears.

```
SHUTTER
SCRN REG
WIND•1
```

2. Select a window to change the analog output setting and press the [ENT] key.

The window menu appears.

```
WIND•1
WIND•1
WIND•2
WIND•3
WIND•4
```

3. Place the cursor on [ANALOG] and press the [ENT] key.

The list of setting parameters appears.

```
FIT= 00
ANALOG
T=
```

4. Select a desired parameter to be output. Select [X] here.

```
FIT= 00
X
Y
ANG
FIT
```

5. Press the [ENT] key.

The scaling setting menu appears.

■ **Scaling method**

Set the monitor output value for the corresponding two desired points to perform scaling.

Before scaling

After scaling

SET

DATA H (400.0) →ANALOG H (2.000)

DATA L (0) →ANALOG L (0)

6. Set [DATA H]. Place the cursor on [DATA H] and press the [ENT] key.

The first digit is shown as highlighted. You can enter a numerical value.

```
ANALOG X
DATA H +4000.00
→ANALOG H 4.000
DATA L +0000.00
→ANALOG L 0.000
```

## 7. Move the [ENT] key to the right and left to select a digit to be changed.

ANALOG	X
DATA H	+4000.00
→ANALOG H	4.000
DATA L	+0000.00
→ANALOG L	0.000

## 8. Change the value.

## • With the panel keys

Press the [▲]/[▼] cursor key repeatedly.

## • With the remote control console

Press the [ENT] key up or down repeatedly.

When [▲] cursor is pressed repeatedly, the value increments by one from 0. After “9”, the second digit is incremented.

When [▼] cursor is pressed or the [ENT] key is pressed down repeatedly, the value decrements by one until it reaches 0. After “0”, the second digit is decremented.

## 9. Press the [ENT] key to confirm the setting.

ANALOG	X
DATA H	+4000.00
→ANALOG H	4.000
DATA L	+0000.00
→ANALOG L	0.000

## 10. Set [ANALOG H], [DATA L], and [ANALOG L] with the same procedure for [DATA H] described in steps 5 to 8.

ANALOG	X
DATA H	+4000.00
→ANALOG H	2.000
DATA L	+0000.00
→ANALOG L	0.000

## 11. Press the [ESCAPE] key after setting all of the parameters and return to the window menu.

The setting of analog output is complete.

**Note:** When there are two or more output parameters (e.g. X-/Y-coordinates), the parameter last set will be output. The “●” in step 3 indicates the current selection.

**Tips**

When INS mode is set to “GAP” or “PITCH”, the average of the measured value is output.

The setting of analog output can be changed for each window. To set several windows, select another window number and follow the above procedure (Steps 1 to 10).

		Output parameters
ARE/CON		Number of pixels
ARE/TRG, INS+POS	ARE	Measured value
	OUTER	Measured value
	INNER	Measured value
	GAP	Average of gap-pitch
	PITCH	Average of center-pitch
	EDGE NO	Number of edge
	COUNT	Number of count
	POINT	No output
	STAIN	Measured value
	GRAVITY	Measured value
ABS.POS, REL.POS	PATT	X-/Y-coordinates, detection angle, correlation ratio
	EDGE	X-/Y-coordinates

## MEMO

# Chapter 7

---

## CompactFlash Memory

This section describes how to use the CompactFlash memory with the CV-701(P)/751(P).

<b>7.1</b>	<b>Mounting and Dismounting the CompactFlash Memory</b> .....	172
7.1.1	Mounting the CompactFlash memory .....	172
7.1.2	Dismounting the CompactFlash memory .....	172
<b>7.2</b>	<b>Reading of Data to a Personal Computer</b> .....	173
<b>7.3</b>	<b>How to Use CompactFlash Memory</b> .....	174
7.3.1	Parameter descriptions .....	174
7.3.2	Saving the setting in CompactFlash memory .....	175

## 7.1 Mounting and Dismounting the CompactFlash Memory

CompactFlash memory can be used with the CV-701(P)/751(P). This section describes how to use the CompactFlash memory.

### 7.1.1 Mounting the CompactFlash memory

Insert a CompactFlash memory as illustrated.

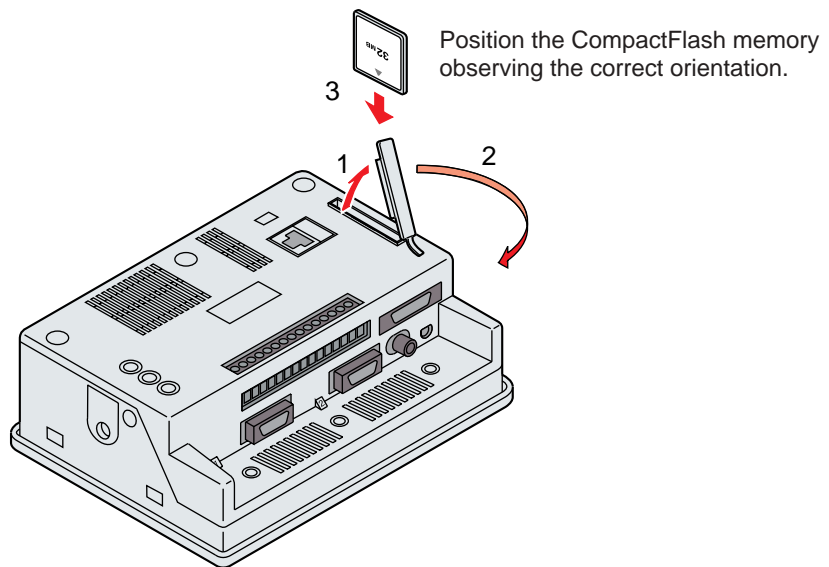

### 7.1.2 Dismounting the CompactFlash memory

Press the EJECT button to remove the CompactFlash memory from the CV-701(P)/751(P).

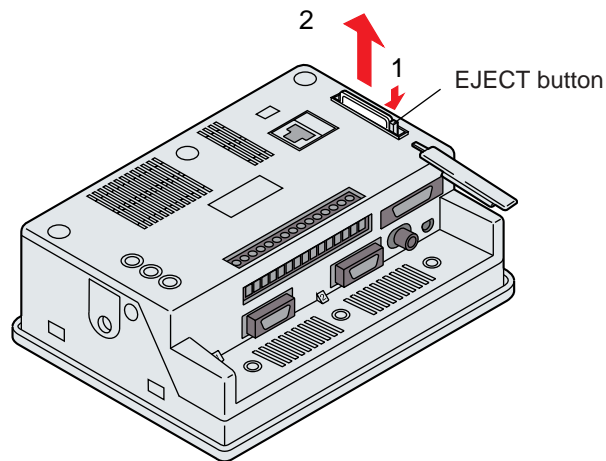

**CAUTION**

*Do not remove the CompactFlash memory while accessing it. Otherwise, the data and/or CompactFlash memory may be damaged.*

**Note:** Use KEYENCE optional NR-M32 CompactFlash memory.

## 7.2 Reading of Data to a Personal Computer

The data saved on a 32-MB CompactFlash memory (option: NR-M32) can be recorded on other media such as hard disks and CompactFlash memory, etc.

**1. Mount a 32-MB CompactFlash memory (option: NR-M32) to a PCMCIA adapter (option: C-A1), and then insert into a PC-card slot of a notebook personal computer.**

- \* When the CompactFlash memory is not recognized by the system, refer to the following procedures.

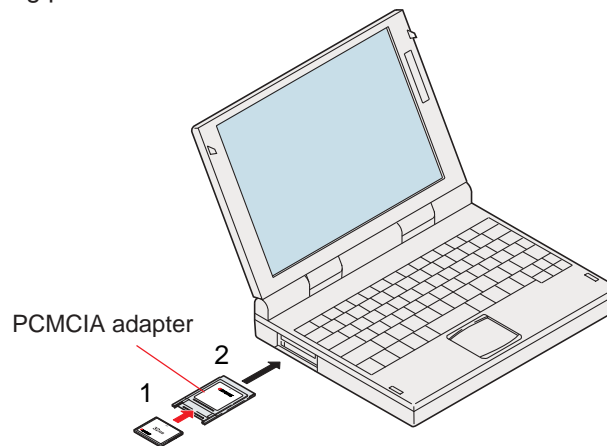

### ■ Recognition of a CompactFlash memory

A simple setup procedure is required when a CompactFlash memory is used for the first time. Follow the procedure shown below for the setup. (The display screen may vary slightly with the PC models and different versions of Windows.)

#### *Procedures*

1. When inserting a CompactFlash memory to the PC-card slot of a personal computer for the first time the display screen below will automatically appear.  
A driver file for CompactFlash memory comes standard with Windows. Additional devices such as FD are not required.
2. Click [Finish].  
The setup for the CompactFlash memory driver is complete.

**2. Open My Computer from the desktop and double-click on the icon named as “Nr\_m32\_8” for the CompactFlash memory drive. The saved data will be displayed.**

**3. When saving the data to different media, drag and drop the data to the desired media to copy them.**

#### **Tips**

Files with the extension “.bmp” can be opened with image processing software (Windows Accessory, Paint, etc.).

## 7.3 How to Use CompactFlash Memory

The following three types of data can be stored in CompactFlash memory.

- BASE SET: Environmental setting data
- WINDOW SET: Setting data
- SCREEN: Saved screen

Up to 16 setting data and registered screens and 8 **[SVD SCRN]** screens can be saved on the internal memory of the CV-701(P)/751(P). Use CompactFlash memory to save more settings and screens.

### Tips

The settings, registered screens and saved screens can be saved in a PC by using an RS-232C communication interface.

### 7.3.1 Parameter descriptions

#### FILE TYPE

Select a file type from the following three types. Select the desired file type to be set.

- BASE SET: Environmental setting data (1 KB)
- WINDOW SET: Setting data, registered screen (16 settings: approx. 4.2 MB)
- NG SCREEN: Saved screen

#### ACTION

Select the desired action to be executed from the following six items.

Select an item in **[ACTION]** and choose **[EXECUTE]**.

- SAVE : Save the selection of setting data, registered screens and save screens in CompactFlash memory.
- LOAD : Read the selection of setting data, registered screens and save screens from CompactFlash memory.
- DELETE : Delete the selected files from CompactFlash memory.
- SAVE BMP : Save the saved screen in CompactFlash memory in bitmap format.
- DELETE BMP : Delete saved screens in bitmap format from CompactFlash memory.
- UPDATE LIST : Update the list of files saved in CompactFlash memory.

---

**Note 1:** The CV processes the set of registered screens and setting data for 16 programs as a single unit. The program numbers are not processed individually in SAVE and LOAD operation.

**Note 2:** Save data in RAW format before saving files in bitmap format.

---

#### SELECT

Select the saved screen.

The display is shown only when **[NG SCREEN]** is selected in **[FILE TYPE]**.



## FILE NAME

The name of the file.

The format of a file name is as follows.

(File type)	(Number)	(Extension)
BS	000	DAT

The numerical values can be changed from 0 to 999.

The file type and extension are defined automatically.

“○” is shown next to the file name when the saved screen file is stored in bitmap form.

BS 000 .DAT	: Environmental setting data
WS 000 .CV7	: Setting data, registered screen data
NG 000 .RAW	: Saved screen data
NG 000 .BMP	: Saved screen data in bitmap format

## LABEL

The characters are set to the file as an identification label. Up to ten characters can be designated.

## EXECUTE

Press the [ENT] key to execute the actions set in the [ACTION] menu.

### 7.3.2 Saving the setting in CompactFlash memory

This section describes the procedure to save the settings in CompactFlash memory.

The procedure can be applied to the saving of other data.

#### 1. Display the environmental setting menu.

☞ Refer to page 144 to display the environmental setting menu.

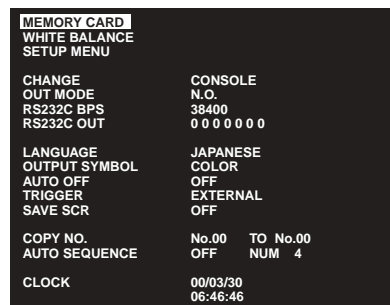

#### 2. Place the cursor on [MEMORY CARD] and press the [ENT] key.

#### 3. The CompactFlash memory menu is displayed.



#### 4. Change the file type settings. Place the cursor on [FILE TYPE] and press the [ENT] key.

The cursor moves to the right column automatically. You can change the setting.

**5. Change the file type.**

Select [WINDOW SET].

FILE TYPE ACTION	WINDOW SET. UPDATE LIST	
FILE NAME LABEL EXECUTE	BS000	.DAT

- **With the panel keys**

Press the [▲]/[▼] cursor keys.

- **With the remote control console**

Press the [ENT] key up or down.

**6. Press the [ENT] key to confirm the setting.****7. Set the [ACTION].**

Refer to steps 4 to 6 to select and confirm the [SAVE].

**8. Select the [FILE NAME]. Place the cursor on [FILE NAME] and press the [ENT] key.**

The cursor goes to the first digit of the [FILE NAME] automatically. You can change the numerical value.

FILE NAME	WS000	.CV7
LABEL		
EXECUTE		

**9. The numerical value of [WS000.CV7] for [FILE NAME] can be changed.****10. Move the cursor to the left or right to select the desired digit to be changed.****11. Change the numerical value.**

- **With the panel keys**

Press the [▲]/[▼] cursor keys repeatedly.

- **With the remote control console**

Press the [ENT] key up or down repeatedly.

The value increments by one from 0 every time the [▲] cursor is pressed.

After 9, the value returns to 0. When [▼] cursor is pressed or the [ENT] key is move down repeatedly, the value decrements by one to 0. After 0, the value returns to 9.

**12. Press the [ENT] key to confirm the [FILE NAME].****Tips**

When files are already stored in the CompactFlash memory, place the cursor on the file name in the list and press the [ENT] key to confirm the selection.

**13. Set the [LABEL]. Place the cursor on [LABEL] and press the [ENT] key.**

The keyboard menu appears on the screen.

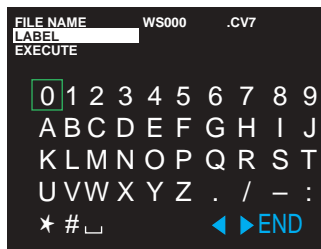
**14. A green frame appears on the “0” in the keyboard menu. Move the frame to the desired character to be set.**

- **With the panel keys**

Press the [▲][▼][◀][▶] cursor keys to move the frame in the desired direction.

- **With the remote control console**

Move the [ENT] key in the desired direction to move the frame in the respective direction.

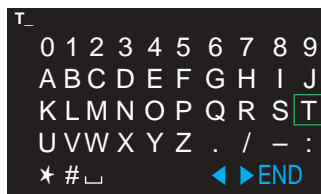
**15. Press the [ENT] key to input the character with the frame to [LABEL].**

Up to ten characters can be designated for the [LABEL]. The digits of the current selection are shown underlined in green. To alter the digit to be changed, select the [◀]/[▶] on the lower-right corner of the screen and press the [ENT] key. The underline moves to the right or left. Press [CLEAR] key to delete underlined characters.

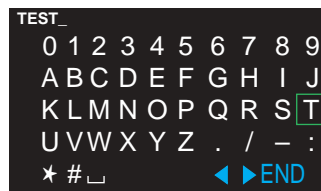
**16. After setting the [LABEL], move the frame to [END] on the lower-right corner of the keyboard menu and press the [ENT] key.****17. Check the defined settings and execute.**

Place the cursor on [EXECUTE] and press the [ENT] key.



**Note 1:** Make sure that the CompactFlash memory is inserted before the execution. When the CompactFlash memory card is not inserted before the execution, the error message “PLEASE INSERT CF CARD.” appears on the screen. Press the [ESCAPE] key to dismiss the error message. Insert the CompactFlash memory card and try the execution again.

**Note 2:** Do not insert/eject the CompactFlash memory during execution.

**18. After the settings are confirmed, press the [ESCAPE] key to return to the environmental setting menu.**

Press the [ESCAPE] key again to return to the setting menu.

## MEMO

# Chapter 8

---

## RS-232C Interface

This section describes the connection between the CV-701(P)/751(P) and a personal computer.

<b>8.1</b>	<b>Overview</b> .....	180
8.1.1	Specifications .....	180
<b>8.2</b>	<b>Connection</b> .....	181
<b>8.3</b>	<b>Commands and Data Formats</b> .....	182
8.3.1	Commands in PROGRAM mode .....	182
8.3.2	Commands for CompactFlash memory .....	187
8.3.3	Commands in RUN mode .....	188
8.3.4	Output data format .....	189
8.3.5	Command list .....	193
8.3.6	Applications of RS-232C communication setting .....	194

## 8.1 Overview

The CV-701(P)/751(P) features an RS-232C interface. This section describes the communication commands using RS-232C.

The communication function enables the following controls and data outputs:

- Select the operation mode (PROGRAM/RUN mode selection).
- Read and write programs.
- Register the screen.
- Read and write the registered screen.
- Read the input screen.
- Read and write the set values.
- Read the saved screen.
- Input trigger signals.
- Select the output data (judgment result, number of pixels, coordinates, correlation ratio, angle).
- Read the output data selection.
- Output data.
- Re-output data.
- Read and write the CompactFlash memory.

### 8.1.1 Specifications

Same as a modem that conforms to the EIA (Electronic Industries Association) RS-232C

<b>Duplex</b>	Full
<b>Synchronization</b>	Start/stop
<b>Data format</b>	ASCII
<b>Data length</b>	8 bits
<b>Stop bit length</b>	1 bit
<b>Parity check</b>	None
<b>Baud rate</b>	9600/19200/38400 bps
<b>Data delimiter</b>	CR
<b>X parameter</b>	Only with binary data-responses

⇒ Refer to page 143 for the baud rate adjustment.

⇒ Refer to page 182 for the commands and data formats.

## 8.2 Connection

### Connection with a PC

Connect the CV-701(P)/751(P) to a personal computer using a special cable OP-27221 (Cable length: 3 m)

■ Connection

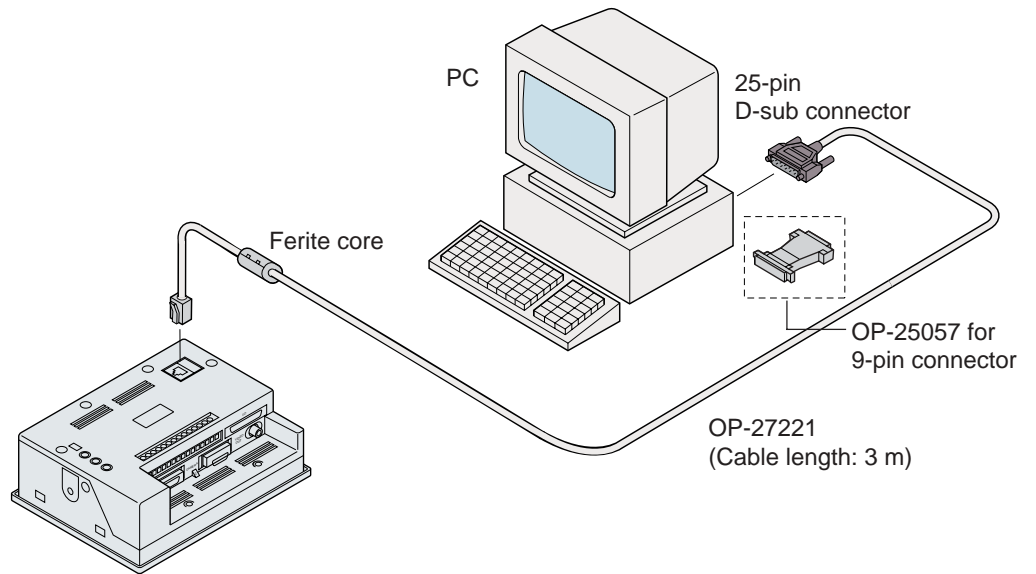

■ Pin assignment

■ Wiring (special cable)

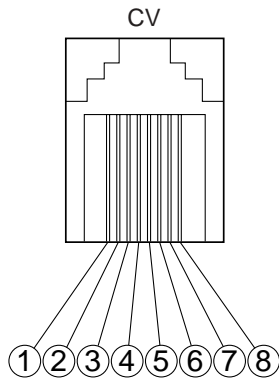

CV side		PC side		
		25-pin	9-pin	
SD (TXD)	②	②	③	SD (TXD)
RD (RXD)	③	③	②	RD (RXD)
SG (GND)	④	⑦	⑤	SG (GND)
		④	⑦	RS (RTS)
		⑤	⑧	CS (CTS)
		⑥	⑥	DR (DSR)
		⑧	①	CD (DCD)
		⑳	④	ER (DTR)

## 8.3 Commands and Data Formats

This section describes the commands and data formats used for RS-232C communication.

### 8.3.1 Commands in PROGRAM mode

Send "O0 [Cr]" to the CV-701(P)/751(P) to stop operation.

**Tips**

After writing data, send SS [Cr] to the CV-701(P)/751(P) to save the settings. If the power is turned off without saving the settings, the setting data will be lost.

● **Reading the program number**

The current program number is sent back to the PC.

Command 

P	R	cr
---	---	----

Response 

P	R	,	NUM 1	NUM 2	cr
---	---	---	----------	----------	----

NUM: Program No. (00 to 15)

● **Writing the program number**

The current program is changed to the number specified with the PC.

Command 

P	W	,	NUM 1	NUM 2	cr
---	---	---	----------	----------	----

Response 

P	W	cr
---	---	----

NUM: Program No. (00 to 15)

Error 

E	R	,	P	W	,	#1	#2	cr
---	---	---	---	---	---	----	----	----

● **Reading output settings**

The current output data selection (judgment result, number of pixels, measured value of edge detection, X coordinate, Y coordinate, correlation ratio, and rotation angle) is sent back to the PC. The initial settings for all data are 0.

Command 

A	R	cr
---	---	----

Response 

A	R	,	NUM 0	NUM 1	NUM 2	NUM 3	NUM 4	NUM 5	NUM 6	cr
---	---	---	----------	----------	----------	----------	----------	----------	----------	----

Data 0: Output setting of judgment result (0: OFF, 1: ON)

Data 1: Output setting of number of pixels (0: OFF, 1: ON)

Data 2: Output setting of the measured value of the INS mode (0: OFF, 1: ON)

Data 3: Output setting of X coordinate (0: OFF, 1: ON)

Data 4: Output setting of Y coordinate (0: OFF, 1: ON)

Data 5: Output setting of correlation ratio (0: OFF, 1: ON)

Data 6: Output setting of rotation angle (0: OFF, 1: ON)



### ● Writing output settings

Select the output data (judgment result, number of pixels, measured value of edge detection, X coordinate, Y coordinate, correlation ratio, and rotation angle). The writing of output settings can be set in the environmental setting menu.

⇒ See page 149.

Command 

A	W	,	NUM 0	NUM 1	NUM 2	NUM 3	NUM 4	NUM 5	NUM 6	cr
---	---	---	----------	----------	----------	----------	----------	----------	----------	----

Response 

A	W	cr
---	---	----

Error 

E	R	,	A	W	,	#1	#2	cr
---	---	---	---	---	---	----	----	----

### ● Reading the setting data

The setting data (all data except for the registered screen) for the current program number is sent back to the PC. The setting data can be saved in the PC.

Command 

S	R	cr
---	---	----

Response 

S	R	,	Data 0	Data 1	Data 2	...	Data 1238	Data 1238	Check- sum	cr
---	---	---	-----------	-----------	-----------	-----	--------------	--------------	---------------	----

Checksum range: Data 0 to Data 1239 (1240 data)

Data 0 to Data 1239: Binary data

Calculation is not necessary for the checksum.

### ● Writing the setting data

The setting data (all data except for the registered screen) is written to the current program number. The stored setting data can be written from the PC to the CV-701(P)/751(P). Be sure to save the data using the SS [Cr] command after writing.

Command 

S	W	,	Data 0	Data 1	Data 2	...	Data 1238	Data 1239	Check- sum	cr
---	---	---	-----------	-----------	-----------	-----	--------------	--------------	---------------	----

Response 

S	W	cr
---	---	----

Checksum range: Data 0 to Data 1239 (1240 data)

Data 0 to Data 1239: Binary data

Calculation is not necessary for the checksum.

Error 

E	R	,	S	W	,	#1	#2	cr
---	---	---	---	---	---	----	----	----

### ● Reading the environmental setting data

The environmental setting data for the current program number is sent back to the PC. The setting data can be saved in the PC.

Command 

S	A	cr
---	---	----

Response 

S	A	,	Data 0	Data 1	Data 2	...	Data 83	Check- sum	cr
---	---	---	-----------	-----------	-----------	-----	------------	---------------	----

Checksum range: Data 0 to Data 83

Data 0 to Data 83: Binary data

Calculation is not necessary for the checksum.

### ● Writing the environmental setting data

The environmental setting data is written to the current program number. The stored setting data can be written from the PC to the CV-701(P)/751(P). Be sure to save the data after writing.

Command 

S	B	,	Data 0	Data 1	Data 2	...	Data 83	Check-sum	cr
---	---	---	--------	--------	--------	-----	---------	-----------	----

Response 

S	B	cr
---	---	----

Checksum range: Data 0 to Data 83

Data 0 to Data 83: Binary data

Calculation is not necessary for the checksum.

Error 

E	R	,	S	B	,	#1	#2	cr
---	---	---	---	---	---	----	----	----

---

**Note:** The environmental setting includes the white balance adjustment. When setting two or more CVs, be sure to select the optimal white balance value for each CV.

---

### ● Reading the registered screen

The image data for the registered screen is sent back to the PC. Data for one line is sent in a single communication. To read the whole image, the transmission is repeated to read the data from line 0 to 485.

Command 

B	R	,	Cn	,	NUM 1	NUM 2	NUM 3	cr
---	---	---	----	---	-------	-------	-------	----

Response 

B	R	,	Data 0	Data 1	...	Data 510	Data 511	Check-sum	cr
---	---	---	--------	--------	-----	----------	----------	-----------	----

Checksum range: Data 0 to Data 511 (512 data)

Data 0 to Data 511: Binary data

Cn: Camera No.

NUM: Line No. (Line 0 to 485) of image data

Calculation is not necessary for the checksum.

### ● Writing the registered screen

The stored image data in the PC is written to the CV's registered screen. The screen registration is saved when writing of image data of LINE 0 to 485 is completed.

Command 

B	W	,	Cn	,	NUM 1	NUM 2	NUM 3	,	Data 0	Data 1	...
Data 510	Data 511	Check-sum	cr								

Response 

B	W	cr
---	---	----

Checksum range: Data 0 to Data 511 (512 data)

Data 0 to Data 511: Binary data

Cn: Camera No. (CAM1: 1, CAM2: 2)

NUM: Line No. (Line 0 to 485) of image data

Calculation is not necessary for the checksum.

### ● Reading the input screen

The stored image saved in the CV is sent back to the PC. Data for one line is sent in a single communication. To read the whole image, the transmission is repeated to read the data from line 0 to 485. This operation is enabled during the transmission with O0 [Cr].

Command 

B	I	,	Cn	,	NUM 1	NUM 2	NUM 3	cr
---	---	---	----	---	----------	----------	----------	----

Response 

B	I	,	Data 0	Data 1	...	Data 510	Data 511	Check- sum	cr
---	---	---	-----------	-----------	-----	-------------	-------------	---------------	----

Checksum range: Data 0 to Data 511 (512 data)

Data 0 to Data 511: Binary data

Cn: Camera No. (CAM1: 1, CAM2: 2)

NUM: Line No. (Line 0 to 485) of image data

Calculation is not necessary for the checksum.

**Note:** When incorrect commands are sent, the error message is sent back. The error message is defined as below.

E	R	,	△	△	,	#1	#2	cr
---	---	---	---	---	---	----	----	----

△: Command character

### ● Reading the saved screen

The stored image of the registered screen saved in the CV is sent back to the PC. Data for one line is sent in a single communication. To read the whole image, the transmission is repeated to read the data from line 0 to 485.

Command 

B	N	,	NUM 0	,	NUM 1	NUM 2	NUM 3	cr
---	---	---	----------	---	----------	----------	----------	----

Response 

B	N	,	Data 0	Data 1	...	Data 510	Data 511	Check- sum	cr
---	---	---	-----------	-----------	-----	-------------	-------------	---------------	----

Checksum range: Data 0 to Data 511 (512 data)

Data 0 to Data 511: Binary data

NUM0: Registered screen No., NUM1/2/3: Line No. of image data (Line 0 to 485)

Calculation is not necessary for the checksum.

### ● Reading the window number

The current window number is sent back to the PC.

Command 

U	R	cr
---	---	----

Response 

U	R	,	NUM 1	cr
---	---	---	----------	----

NUM: Window No. (1 to 8)

- **Writing the window number**

The current window number is changed to the number specified with the PC.

Command 

U	W	,	NUM 1	cr
---	---	---	----------	----

Response 

U	W	cr
---	---	----

NUM: Window No. (1 to 8)

- **Registering the screen**

Save the image captured with the camera as the registered screen.

Command 

D	NUM 1	cr
---	----------	----

Response 

D	NUM 1	cr
---	----------	----

NUM: 0=CAM1 and CAM2, 1=CAM1, 2=CAM2

- **Saving the setting data**

The setting data is saved in the CV's internal memory. When the power is turned off without sending this command, the setting data for RS-232C will be lost.

Command 

S	S	cr
---	---	----

Response 

S	S	cr
---	---	----

- **Changing to RUN mode**

The CV-701(P)/751(P) is switched to RUN mode.

Command 

R	0	cr
---	---	----

Response 

R	0	cr
---	---	----

### 8.3.2 Commands for CompactFlash memory

Send the commands to access the CompactFlash memory. The commands are available while the CV is in program mode with O0 [Cr].

- **Reading the setting data and registered screen**

Read the setting data and image data of the specified file from the CompactFlash memory. The 16 programs stored under the specified file are written to the CV, overwriting all current programs.

Command 

C	S	,	NUM 1	NUM 2	NUM 3	cr
---	---	---	----------	----------	----------	----

Response 

C	S	cr
---	---	----

NUM1 to NUM3: File No. in the CompactFlash memory

- **Reading the environmental setting data**

Read the environmental setting data into the CV from the CompactFlash memory.

Command 

C	C	,	NUM 1	NUM 2	NUM 3	cr
---	---	---	----------	----------	----------	----

Response 

C	C	cr
---	---	----

NUM1 to NUM3: File No. in the CompactFlash memory

---

**Note:** The environmental setting includes the white balance adjustment. When setting two or more CVs, be sure to select the optimal white balance value for each CV.

---

- **Reading setting data for one program**

Setting data for only one program is sent to the CV from the CompactFlash memory.

Command 

C	1	,	NUM 1	NUM 2	NUM 3	,	a1	a2	,	b1	b2	cr
---	---	---	----------	----------	----------	---	----	----	---	----	----	----

Response 

C	1	cr
---	---	----

NUM1 to NUM3: File No. in the CompactFlash memory

a1 to 2: Program No. to be read in the file, b1 to 2: Program No. where the read program will be written to the CV.

- **Writing the saved screen**

The image data of the saved screen is written on the CompactFlash memory.

Command 

C	N	cr
---	---	----

Response 

C	N	cr
---	---	----

When the CompactFlash memory is full, an error message will be sent.

---

**Important:** Make sure not to insert or eject the CompactFlash memory while access to the CompactFlash memory is made.

---

### 8.3.3 Commands in RUN mode

Send [R][0][Cr] to the CV-701(P)/751(P) to switch it to the RUN mode before using the following commands.

- **Trigger**

Input a trigger signal

Command 

T	1	cr
---	---	----

Response 

T	1	,	Numerical value data	cr
---	---	---	----------------------	----

T	G	,	Numerical value data	cr
---	---	---	----------------------	----

 (with external trigger)

(Numerical value data: Depends on the output data setting. Refer to the “Output data format” on page 189.)

- **Re-outputting data**

Output the latest processing result data again.

Command 

M	0	cr
---	---	----

Response 

M	0	,	Numerical value data	cr
---	---	---	----------------------	----

(Numerical value data: Depends on the output data setting. Refer to the “Output data format”.)

- **Stopping**

Stop the operation of the CV-701(P)/751(P)

Command 

O	0	cr
---	---	----

Response 

O	0	cr
---	---	----

### 8.3.4 Output data format

The data formats available with the AW commands are listed below. The available data for output is limited depending on the measurement mode.

Output item	Data format	PROGRAM mode																
	Normal mode	ARE/CON <sup>5.</sup>	INS/TRG										ABS. POS		REL. POS <sup>6.</sup>		INS+POS <sup>1.</sup>	
			AREA	OUTER	INNER	GAP	PITCH	EDGE NO.	COUNT	POINT <sup>8.</sup>	STAIN	GRAVITY	PATT	EDGE	PATT	EDGE		
<b>Judgment result</b>	0 (acceptable) 1 (unacceptable)	<input type="radio"/>	<input type="radio"/>	<input type="radio"/>	<input type="radio"/>	<input type="radio"/>	<input type="radio"/>	<input type="radio"/>	<input type="radio"/>	<input type="radio"/>	<input type="radio"/>	<input type="radio"/>	<input type="radio"/>	<input type="radio"/>	<input type="radio"/>	<input type="radio"/>	<input type="radio"/>	<input type="radio"/>
<b>No. of pixels</b>	000000 243840	<input type="radio"/>	<input type="radio"/>															
<b>INS<sup>7.</sup></b>				<input type="radio"/>	<input type="radio"/>	<input type="radio"/>	<input type="radio"/>	<input type="radio"/>	<input type="radio"/>	<input type="radio"/>	<input type="radio"/>	<input type="radio"/>						
<b>X coordinate<sup>2, 4.</sup></b>	±00000.000 ±99999.999												<input type="radio"/>	<input type="radio"/>	<input type="radio"/>	<input type="radio"/>		
<b>Y coordinate<sup>2, 4.</sup></b>	±00000.000 ±99999.999												<input type="radio"/>	<input type="radio"/>	<input type="radio"/>	<input type="radio"/>		
<b>Correlation ratio</b>	000 100												<input type="radio"/>		<input type="radio"/>			
<b>Rotation angle<sup>3.</sup></b>	-180 + 179											<input type="radio"/>	<input type="radio"/>		<input type="radio"/>			

- In the INS+POS mode, the output format of the INS measured data is the same as that for INS/TRG, and the format of the position adjustment is the same as that for ABS.POS.
- When the edge detection mode is set to either the X- or Y-axis direction only, the coordinate of the other axis is not output.
- The output is disabled when the rotation angle is not used.
- The coordinate output is fixed to "sign + five-digit integer + decimal point + three-digit fraction".
- The data output is stopped when the CONT input is short-circuited in the ARE/CON mode.
- REF WND (reference window) uses the absolute value for judgment or data output. The other windows use the difference from the REF WND.
- The output format for INSPECT output varies as follows depending on the measurement mode.
  - OUTER, INNER Measured dimension
  - GAP, PITCH Measured dimension (Maximum and minimum values)
  - EDGE NO Number of detected edge
  - COUNT Counted number
  - POINT Color extraction condition of each point
  - STAIN Measured value
  - GRAVITY Detected X and Y coordinates, angle of principal axis

<b>Measured dimension</b>	±00000.000 ±99999.999
<b>Number of edges</b>	±00000.000 ±99999.999
<b>Counted number</b>	±00000.000 ±99999.999

- Each digit represents the condition of color extraction as follows:  
0: Background color, 1: Detected color, 9: Unassigned  
(Example) 01019999

**Example**

To output the number of pixels in “Window 1” and “Window 2”:

1 2 3 4 5 6 , 0 0 1 0 0 0 cr

Window 1 has  
123,456 pixels.

Window 2 has  
1,000 pixels.

**Order of output data**

- WO1 processing → WO2 processing → ... → WO8 processing [cr]
- The judgment output and pixel output are given only for the windows with settings assigned.
- [,] is output as a separator between data.

**Example**

When WO1 and WO3 are set in “AREA” mode:

(1) If the output data is selected as [1][0][0][0][0][0][0] (the judgment output for WO1 to WO8), the output data is as follows.

1 , 0 cr

WO3:OK (Acceptable)  
WO1:NG (Unacceptable)

(2) If the output data is selected as [1][1][0][0][0][0][0] (the judgment and pixel output for WO1 to WO8), the output data is as follows.

1 , 1 2 3 4 5 , 0 , 0 0 1 0 0 0 cr

No. of pixels in WO1  
No. of pixels in WO3  
WO1:NG (Unacceptable)  
WO3:OK (Acceptable)

**Example**

When WO1 and WO2 are used in “ABS.POS” mode:

If the output data is selected as [0][0][0][1][1][1] (X and Y coordinates, correlation ratio, rotation angle):

+ 0 0 1 4 2 . 0 0 0 , - 0 0 3 6 3 . 0 0 0 , 0 9 2

X coordinate of WO1  
Y coordinate of WO1  
Correlation ratio of WO1

+ 0 0 5 , + 0 0 3 9 2 . 0 0 0 , + 0 0 5 0 . 0 0 0

Rotation angle of WO1  
X coordinate of WO2  
Y coordinate of WO2

0 8 9 , + 0 0 8 cr

Correlation ratio of WO2  
Rotation angle of WO2



Example

When WO1 and WO2 are used in "INS+POS" mode:

- (1) When AREA is set to WO1, and OUTER is set to WO2, and the X and Y coordinates are selected for PATT output in position adjustment.  
If the output data is selected as [1][1][1][1][1][0][0] (output of the judgment result, number of pixels, INS, and X and Y coordinates), and one camera is connected:

0	,	0	0	2	3	4	5	,	1	,	+	0	0	5	1	.	0	0	0	,
WO1:OK (Acceptable)		No. of pixels in WO1				WO2:NG (Unacceptable)		OUTER of WO2												

+	0	0	1	0	2	.	0	0	0	,	.	0	0	2	0	1	.	0	0	0	,
X coordinate of position adjustment										Y coordinate of position adjustment											

- (2) Output conditions are the same as that for (1). Two cameras are connected.  
WO1: CAM1, WO2: CAM2

0	,	0	0	2	3	4	5	,	1	,	+	0	0	5	1	.	0	0	0	,
WO1: OK (Acceptable)		No. of pixels in WO1				WO2: NG (Unacceptable)		OUTER of WO2												

+	0	0	1	0	2	.	0	0	0	,	+	0	0	2	0	1	.	0	0	0	,
X coordinate of position adjustment for CAM1										Y coordinate of position adjustment for CAM1											

+	0	0	3	0	5	.	0	0	0	,	0	0	2	8	.	0	0	0	,
X coordinate of position adjustment for CAM2										Y coordinate of position adjustment for CAM2									

Example

When AUTO SEQUENCE is activated:

If;

Two AREA windows are set to Program No. 0

One OUTER window is set to Program No. 1

X and Y coordinates of the ABS.POS window are set to Program No. 2

The output data is selected as [0][1][1][1][1][0][0] (Output of No. of pixels, INS, and X and Y coordinates):

0 0 1 0 0 3 , 0 0 2 5 0 0 cr

The measured value of Program No. 0

+ 0 0 0 9 0 . 0 0 0 cr

The measured value of Program No. 1

+ 0 0 1 5 0 . 5 0 0 , + 2 1 0 . 3 0 0 cr

The measured value of Program No. 2

When the AUTO SEQUENCE function is activated, the data is output sequentially with [cr] output for each program No.

## 8.3.5 Command list

## Commands in PROGRAM mode

Function	Command	Description
Read program No.	P R cr	Program No. is sent back to the PC.
Write program No.	P W , NUM <sub>1</sub> NUM <sub>2</sub> cr	Program No. is changed.
Read output setting.	A R cr	The current output data selection is sent back to the PC.
Write output setting.	A W , NUM <sub>0</sub> NUM <sub>1</sub> ... NUM <sub>6</sub> cr	The output data is selected.
Read settings.	S R cr	Setting is sent back to the PC.
Write settings.	S W , DATA <sub>0</sub> DATA <sub>1</sub> ... DATA <sub>1239</sub> Check-sum cr	Setting is written to the CV.
Read environmental setting.	S A cr	Environmental setting is sent back to the PC.
Write environmental setting.	S B , DATA <sub>0</sub> DATA <sub>1</sub> ... DATA <sub>75</sub> Check-sum cr	Environmental setting is written to the CV.
Read registered screen.	B R , Cn , NUM <sub>1</sub> NUM <sub>2</sub> NUM <sub>3</sub> cr	The image data for the registered screen is sent back to the PC.
Write registered screen.	B W , Cn , NUM <sub>1</sub> NUM <sub>2</sub> NUM <sub>3</sub> , DATA <sub>0</sub> ... DATA <sub>511</sub> Check-sum cr	The registered screen is written to the CV.
Read input screen.	B I , Cn , NUM <sub>1</sub> NUM <sub>2</sub> NUM <sub>3</sub> cr	The image in the CV memory is sent back to the PC.
Read saved screen.	B N , NUM <sub>0</sub> , NUM <sub>1</sub> NUM <sub>2</sub> NUM <sub>3</sub> cr	The image data for the saved screen is sent back to the PC.
Read window No.	U R cr	Window No. is sent back to the PC.
Write window No.	U W , NUM <sub>1</sub> cr	Window No. is changed.
Register screen.	D NUM <sub>1</sub> cr	A screen is registered.
Save settings.	S S cr	Settings are saved in the nonvolatile memory.
RUN	R 0 cr	The CV is set to RUN mode.

### Commands for CompactFlash memory

Function	Command	Description
Read setting data and registered screen.	C S , NUM 1 NUM 2 NUM 3 cr	Setting data and registered screen are read from the CompactFlash memory.
Read environmental setting.	C C , NUM 1 NUM 2 NUM 3 cr	Environmental settings are read from the CompactFlash memory.
Read settings for one program.	C 1 , NUM 1 NUM 2 NUM 3 , a1 a2 , b1 b2 cr	Settings for one program are read from the CompactFlash memory.
Write saved screen.	C N cr	The data for saved screen is saved in the CompactFlash memory.

### Commands in RUN mode

Function	Command	Description
Trigger	T 1 cr	A trigger signal is input.
Re-output data	M 0 cr	The latest data is output again.
Stop	O 0 cr	The operation is stopped.

### 8.3.6 Applications of RS-232C communication setting

This section describes the basic flow of the communication setting.

#### Communication settings with RS-232C

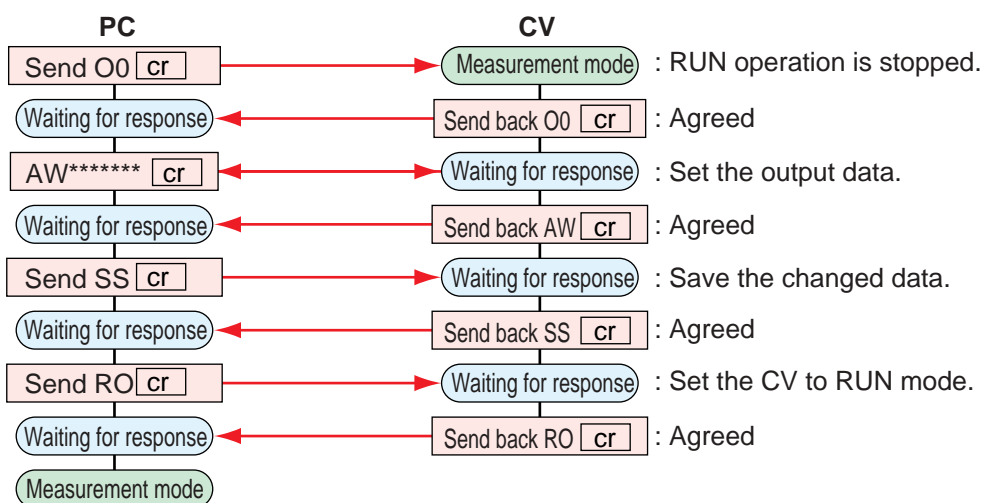

When a trigger signal is input, the measured results will be output with the RS-232C communication.

#### Output setting with the CV-701(P)/751(P)

⇒ Refer to page 149 to select the output data in the environmental setting menu.

When a trigger signal is input, the measured results will be output with the RS-232C communication.

Example

When WO1 and WO2 are used in "INS+POS" mode:

- (1) When AREA is set to WO1, and OUTER is set to WO2, and the X and Y coordinates are selected for PATT output in position adjustment. If the output data is selected as [1][1][1][1][1][0][0] (output of the judgment result, number of pixels, INS, and X and Y coordinates), and one camera is connected:

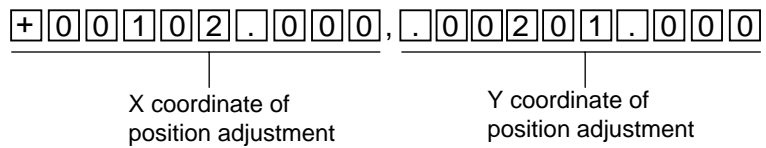
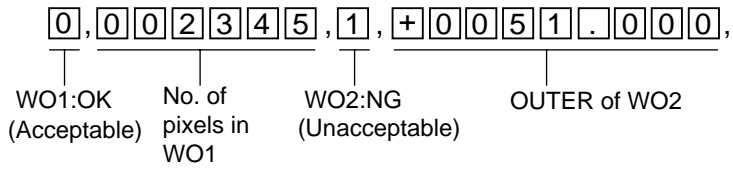

- (2) Output conditions are the same as that for (1). Two cameras are connected. WO1: CAM1, WO2: CAM2

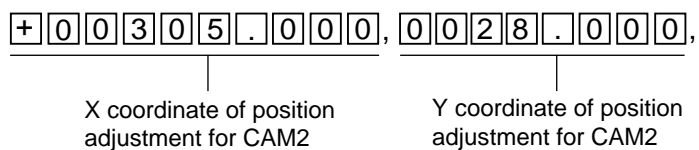
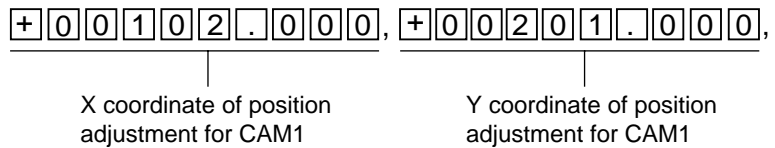
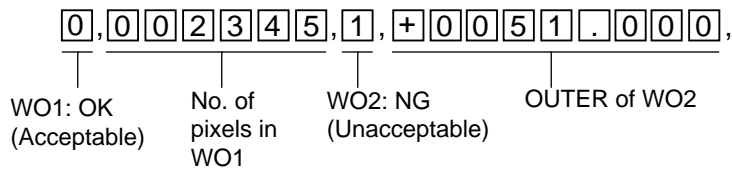

Example

When AUTO SEQUENCE is activated:

If;

Two AREA windows are set to Program No. 0

One OUTER window is set to Program No. 1

X and Y coordinates of the ABS.POS window are set to Program No. 2

The output data is selected as [0][1][1][1][1][0][0] (Output of No. of pixels, INS, and X and Y coordinates):

[0][0][1][0][0][3][,][0][0][2][5][0][0][cr]

The measured value of Program No. 0

+ [0][0][0][9][0][.][0][0][0][cr]

The measured value of Program No. 1

+ [0][0][1][5][0][.][5][0][0][,][+][2][1][0][.][3][0][0][cr]

The measured value of Program No. 2

When the AUTO SEQUENCE function is activated, the data is output sequentially with [cr] output for each program No.

## 8.3.5 Command list

## Commands in PROGRAM mode

Function	Command	Description
Read program No.	P R cr	Program No. is sent back to the PC.
Write program No.	P W , NUM <sub>1</sub> NUM <sub>2</sub> cr	Program No. is changed.
Read output setting.	A R cr	The current output data selection is sent back to the PC.
Write output setting.	A W , NUM <sub>0</sub> NUM <sub>1</sub> ... NUM <sub>6</sub> cr	The output data is selected.
Read settings.	S R cr	Setting is sent back to the PC.
Write settings.	S W , DATA <sub>0</sub> DATA <sub>1</sub> ... DATA <sub>1239</sub> Check-sum cr	Setting is written to the CV.
Read environmental setting.	S A cr	Environmental setting is sent back to the PC.
Write environmental setting.	S B , DATA <sub>0</sub> DATA <sub>1</sub> ... DATA <sub>75</sub> Check-sum cr	Environmental setting is written to the CV.
Read registered screen.	B R , Cn , NUM <sub>1</sub> NUM <sub>2</sub> NUM <sub>3</sub> cr	The image data for the registered screen is sent back to the PC.
Write registered screen.	B W , Cn , NUM <sub>1</sub> NUM <sub>2</sub> NUM <sub>3</sub> , DATA <sub>0</sub> ... DATA <sub>511</sub> Check-sum cr	The registered screen is written to the CV.
Read input screen.	B I , Cn , NUM <sub>1</sub> NUM <sub>2</sub> NUM <sub>3</sub> cr	The image in the CV memory is sent back to the PC.
Read saved screen.	B N , NUM <sub>0</sub> , NUM <sub>1</sub> NUM <sub>2</sub> NUM <sub>3</sub> cr	The image data for the saved screen is sent back to the PC.
Read window No.	U R cr	Window No. is sent back to the PC.
Write window No.	U W , NUM <sub>1</sub> cr	Window No. is changed.
Register screen.	D NUM <sub>1</sub> cr	A screen is registered.
Save settings.	S S cr	Settings are saved in the nonvolatile memory.
RUN	R 0 cr	The CV is set to RUN mode.

### Commands for CompactFlash memory

Function	Command	Description
Read setting data and registered screen.	C S , NUM 1 NUM 2 NUM 3 cr	Setting data and registered screen are read from the CompactFlash memory.
Read environmental setting.	C C , NUM 1 NUM 2 NUM 3 cr	Environmental settings are read from the CompactFlash memory.
Read settings for one program.	C 1 , NUM 1 NUM 2 NUM 3 , a1a2 , b1b2 cr	Settings for one program are read from the CompactFlash memory.
Write saved screen.	C N cr	The data for saved screen is saved in the CompactFlash memory.

### Commands in RUN mode

Function	Command	Description
Trigger	T 1 cr	A trigger signal is input.
Re-output data	M 0 cr	The latest data is output again.
Stop	O 0 cr	The operation is stopped.

### 8.3.6 Applications of RS-232C communication setting

This section describes the basic flow of the communication setting.

#### Communication settings with RS-232C

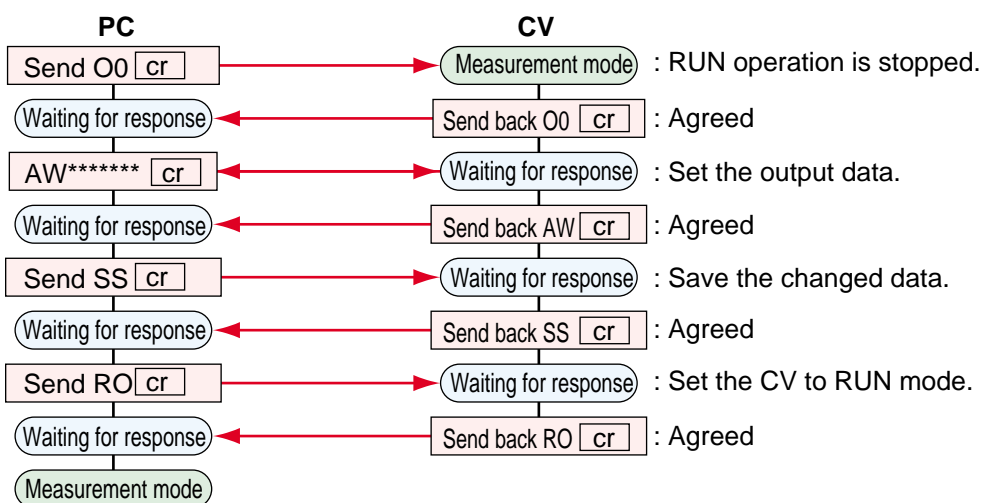

When a trigger signal is input, the measured results will be output with the RS-232C communication.

#### Output setting with the CV-701(P)/751(P)

⇨ Refer to page 149 to select the output data in the environmental setting menu.

When a trigger signal is input, the measured results will be output with the RS-232C communication.



# Chapter 9

---

## Specifications

This section describes the specifications and dimensions.

<b>9.1</b>	<b>Specifications</b> .....	196
<b>9.2</b>	<b>Dimensions</b> .....	198

## 9.1 Specifications

### Controller

Model		CV-751(P)	CV-701(P)	
No. of pixels		508 (H) x 480 (V): 240,000 pixels		
Process cycle		30 c/s (Varies depending on the setting.)		
Binary level		Color binary conversion processing by color extraction or color contrast processing		
Program registration		16 programs (8 programs when two cameras are used) Programs are externally selectable.		
No. of registered screens		16 screens (1 screen/program or 2 screens/program)		
Functions	Mode	Area sensor	8 max./program, Window shape: circle/square/free square	
		Absolute position detection	4/program, Window shape: square	
		Relative position detection	4/program, Window shape: square	
		Inspection mode	Width measurement	8/program, Window shape: square
			Pitch/gap measurement	8/program, Window shape: square
			Edge No. Count	8/program, Window shape: square
			Stain detection	8/program, Window shape: square/circle
		Point sensor	8/program, 8/window	
		Gravity measurement	8/program, Window shape: square/circle	
	Adjustment	Position adjustment	Color contrast search/line sensor/color binary gravity/principal axis angle, X-/Y-axis direction, rotation $\pm 180^\circ$	
		Illumination adjustment	1 illumination adjustment window/program (2/program when 2 cameras are used.)	
		Advance processing (FILTER function)	Expand/shrink/median/average/edge emphasis/edge extraction/shading/brightness up/tint up/invert	
		Data calculation	Unit conversion (pixel, mm, inch) + Offset	
	Screen Save		8 screens	
	Setting Help		Save parameter upon setting	
	Input	Camera input		2
		Control input	External trigger input	1 (Non-voltage input)
			Program selection	Data input (x4), 16 programs selectable (Non-voltage input)
			Continuous detection	Detection is continued without an external trigger when the program No. is changed while CONT input is on. (Non-voltage input)
Screen registration			2. Screens are registered by a trigger signal while REC input is on. (Non-voltage input)	
Window selection			Data input (x3), 8 windows selectable (Non-voltage input)	
LCD monitor	Panel	TFT 5.5 inch, full color	Not provided	
	Backlight	Cold cathode fluorescent tube (Life: 40,000 hrs)	Not provided	
Memory card		CompactFlash memory		
Video output		Conforming to NTSC system		
RS-232C interface		1 ch, numerical value output and control input/output (Baud rate: 38,400 bps max. selectable)		
Control output	NPN	NPN open-collector (x9), 50 mA max. (30 V max.)		
	PNP	PNP open-collector (x9), 50 mA max. (30 V max.)		
Numerical value output		Binary 13 bits, 10 mA max. (30 V max.)		
Analog output		0 to 4 V output, output impedance: 100 $\Omega$		
Display language		Japanese/English selectable		
Rating	Power supply voltage	24 VDC $\pm 10\%$		
	Current consumption	1.4 A	700 mA	
Environment	Ambient temperature	0 to +40° C (32 to +104° F)		
	Relative humidity	35 to 85%, No condensation		
Weight		Controller: Approx. 900 g	Controller: Approx. 400 g, Remote control console: Approx. 160 g	

## Camera

Model		CV-070
Image pickup element	System	Inter-line transfer type color CCD
	Reading	Progressive (all reading)
	Size	1/3 inch
	No. of pixels	350,000 pixels
	Pixel shape	Square-pixel/RGB filter
Electronic shutter		1/30, 1/50, 1/60, 1/100, 1/125, 1/250, 1/500, 1/1000, 1/2000, 1/4000, 1/10000 sec.
Lens mount method		C mount
Environment	Ambient temperature	0 to +40° C (32 to 104° F)
	Relative humidity	35 to 85%, No condensation
Weight		Camera: Approx. 310 g (including 3 m cable)

## 9.2 Dimensions

### Controller: CV-701(P)

Unit: mm

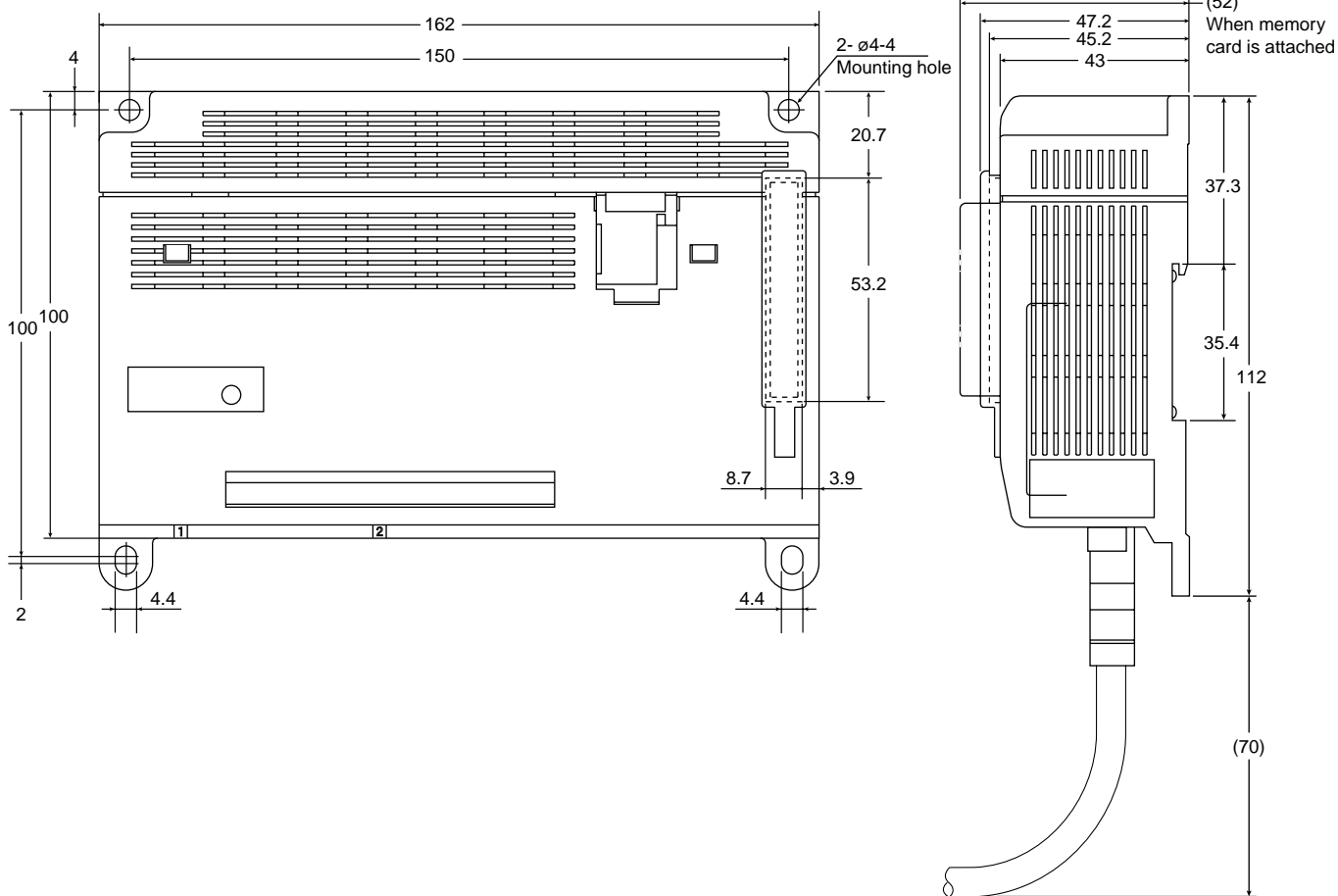

### Remote control console: OP-30938

Accessory: CV-701(P) only

Unit: mm

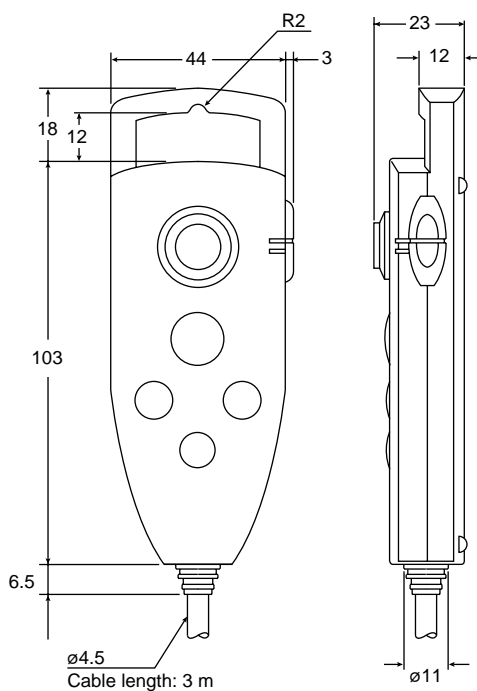

### Controller: CV-751(P)

Unit: mm

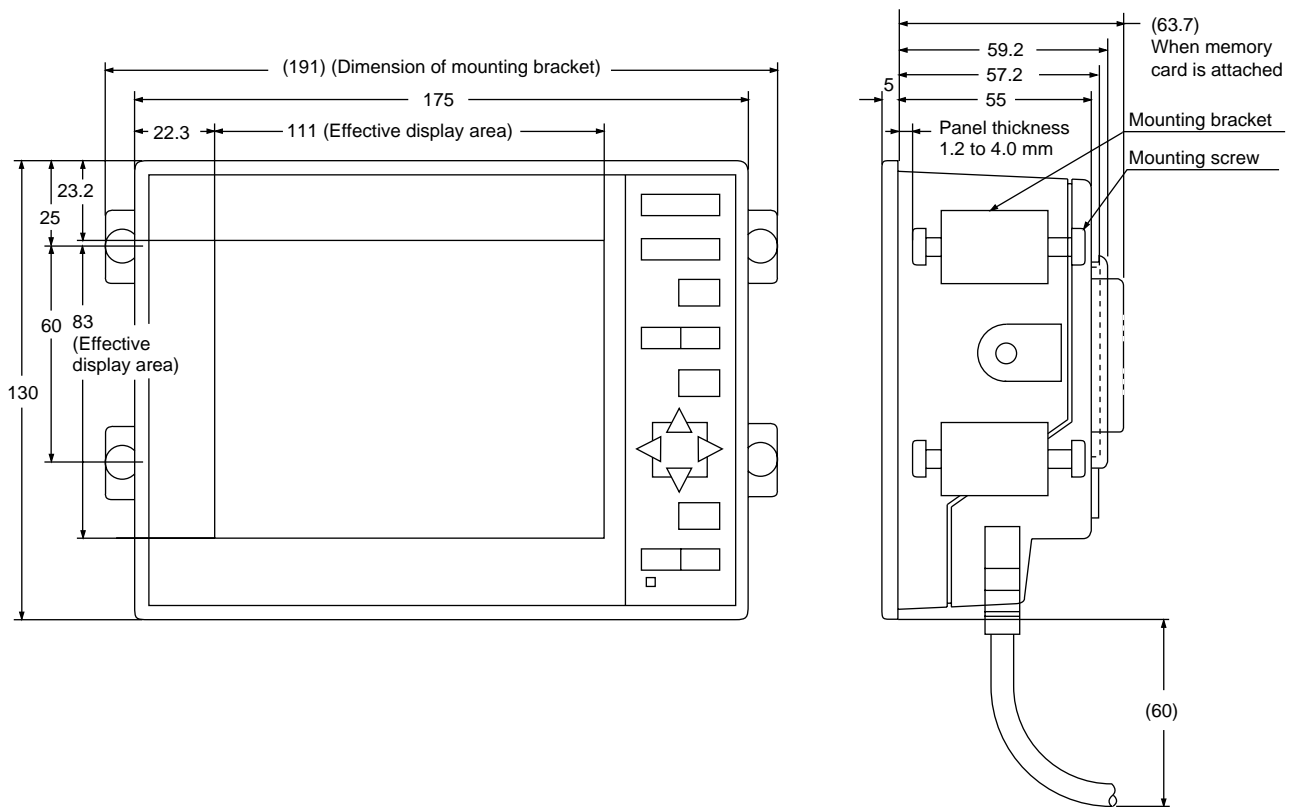

### Panel cutout for CV-751(P) controller

Unit: mm

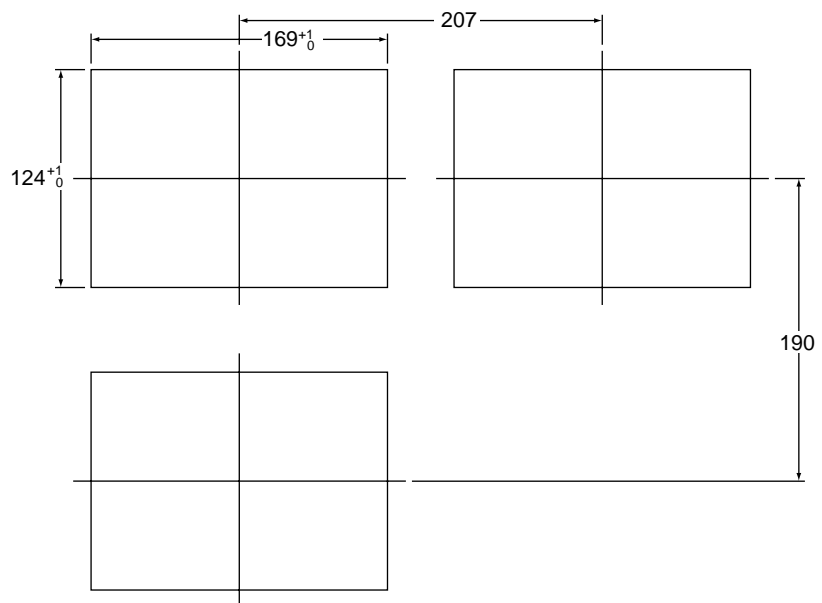

### Camera: CV-070

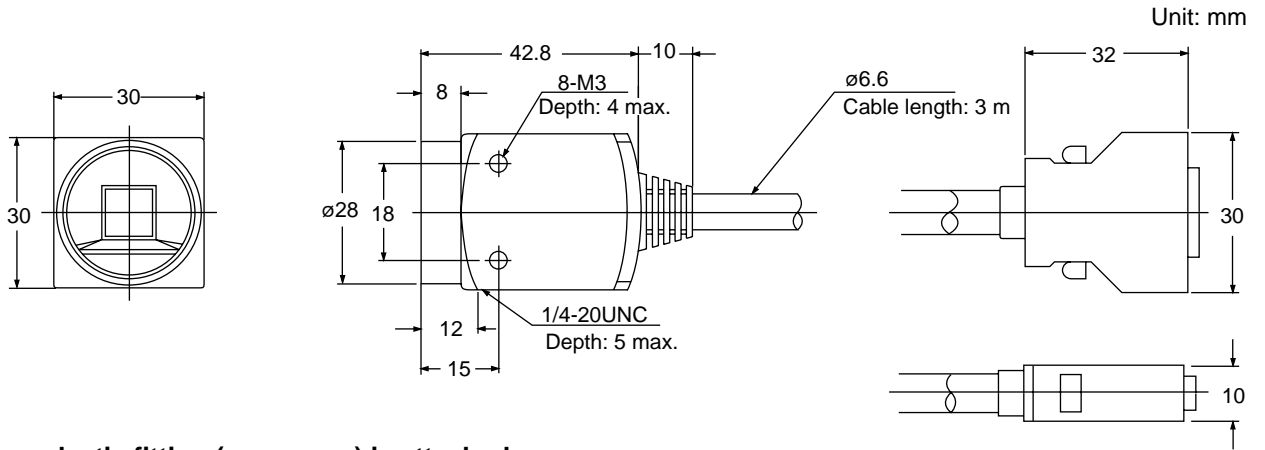

When plastic fitting (accessory) is attached.

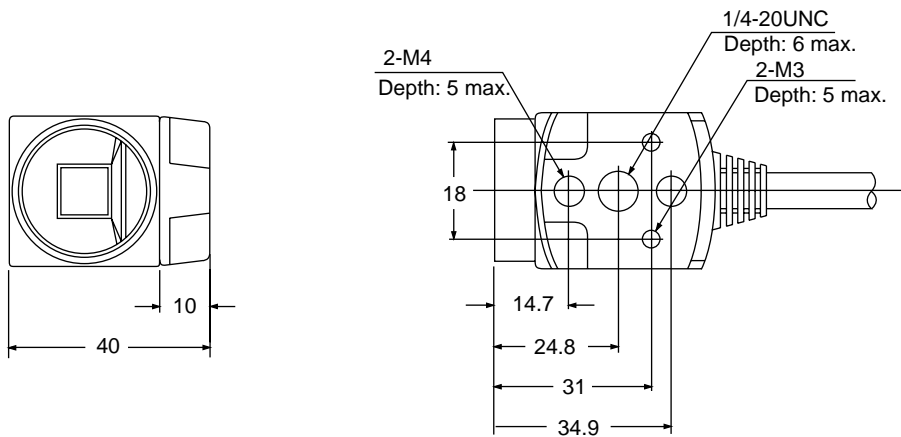

### Close-up adapters (Option: OP-35406)

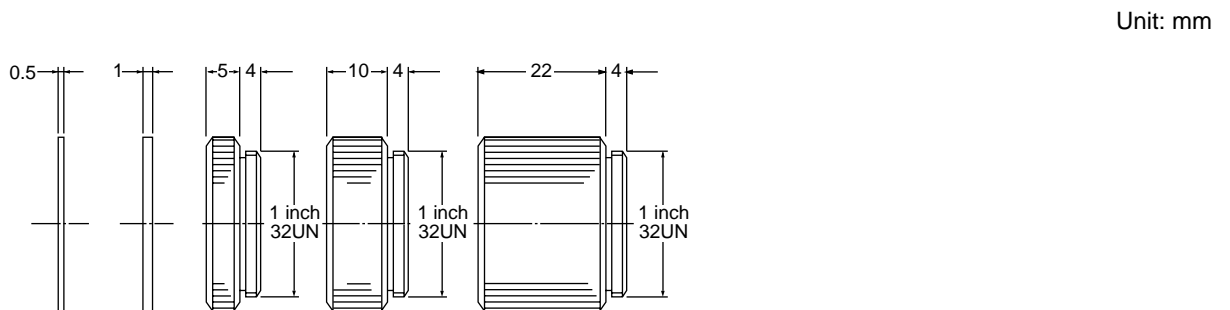

### Lens

#### 3.5 mm lens: CV-L3

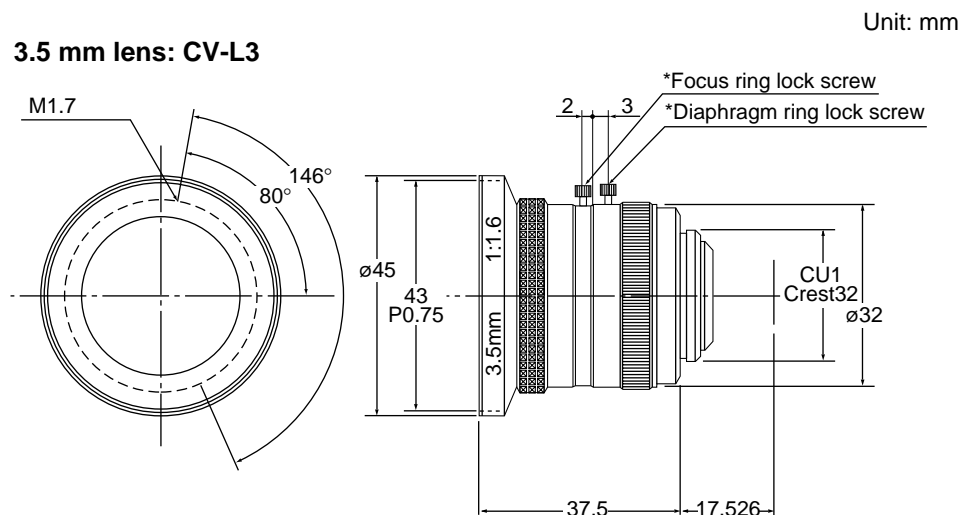

■ 6 mm lens: CV-L6

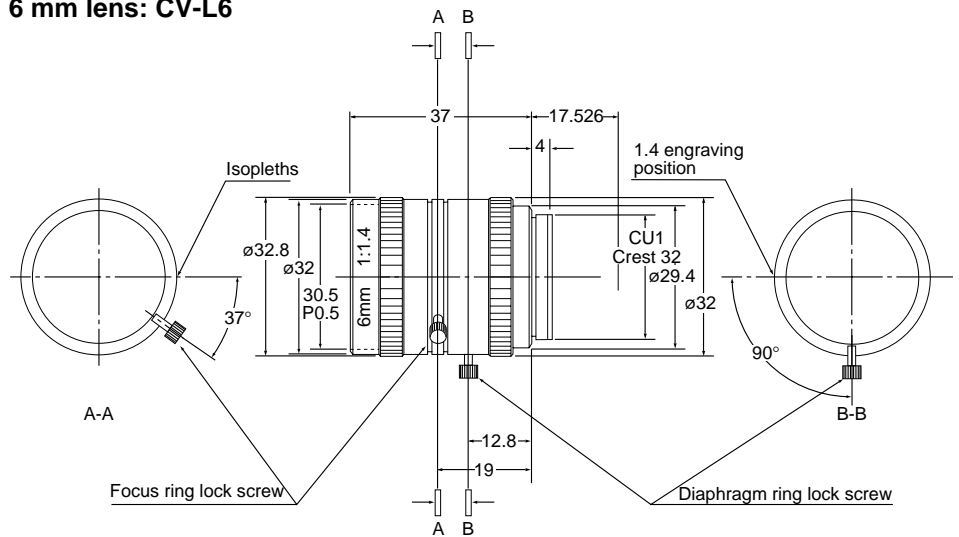

■ 16 mm lens: CV-L16

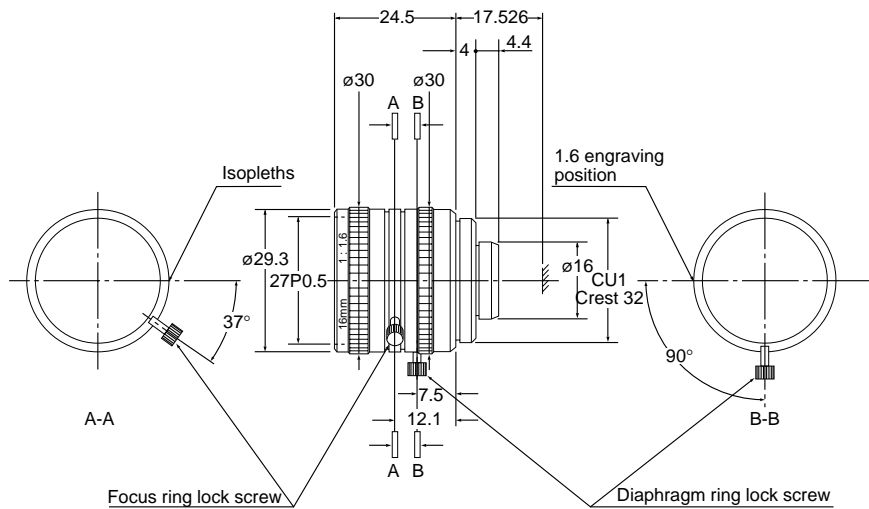

■ 50 mm lens: CV-L50

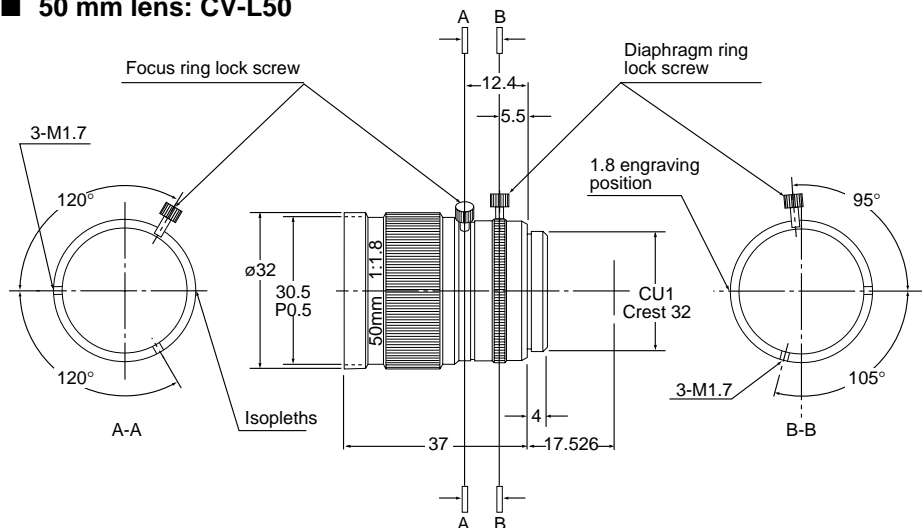

Model	CV-L3	CV-L6	CV-L16	CV-L50
Focal distance	3.5 mm	6 mm	16 mm	50 mm
Diaphragm	F1.6 to CLOSE	F1.4 to CLOSE	F1.6 to CLOSE	F1.8 to CLOSE
Point-blank range	0.1 m	0.2 m	0.4 m	1.0 m
Mount	C mount	C mount	C mount	C mount
Filter screw diameter	43.0 mm P0.75	30.5 mm P0.5	27.0 mm P0.5	30.5 mm P0.5
Weight	Approx. 90 g	Approx. 70 g	Approx. 44 g	Approx. 55 g

### TFT color monitor (Option: CV-M30)

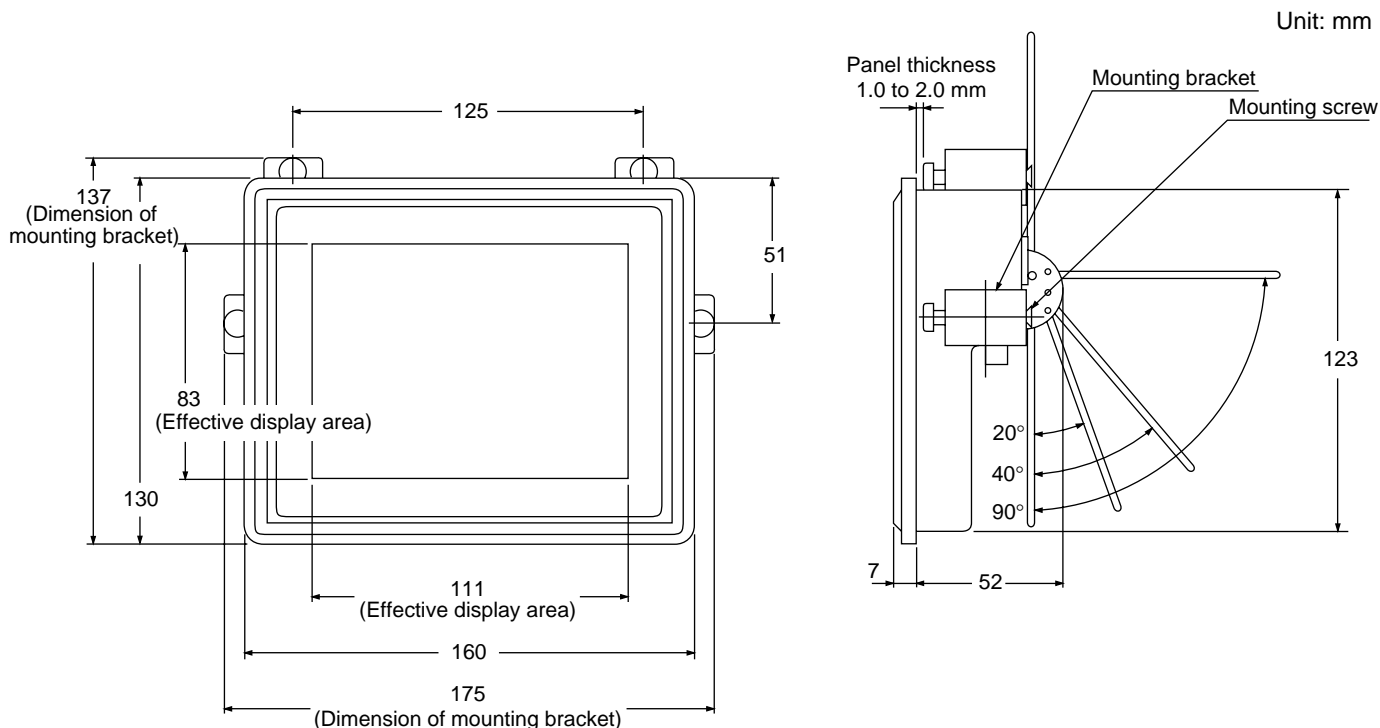

### Panel cutout for CV-M30 TFT color monitor

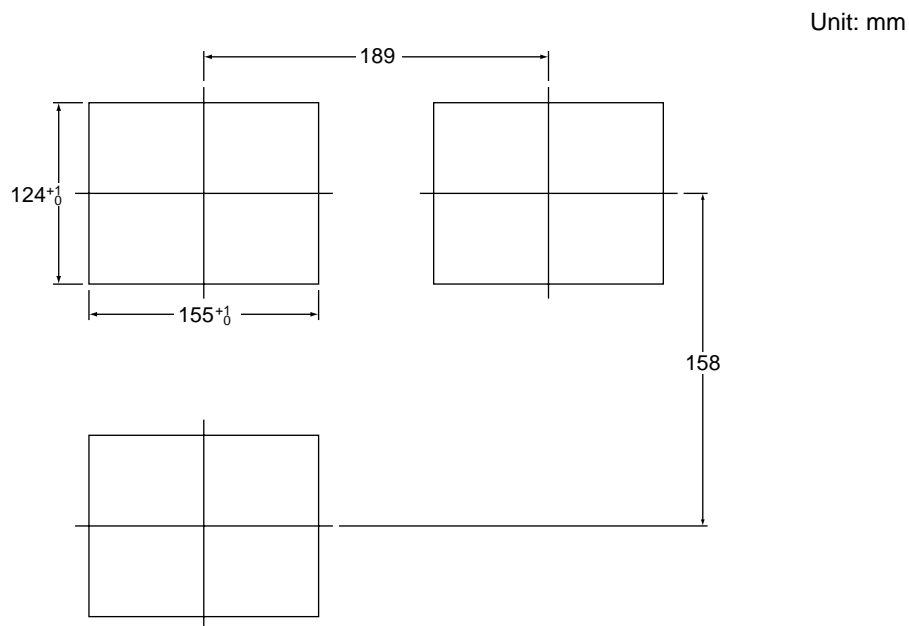

<b>LCD panel</b>	<b>Display screen size</b>	5.5 inch, 111.36 (H) x 85.52 (V) mm
	<b>Matrix size</b>	320 x 3 (H) x 240 (V)
	<b>Color</b>	Full color
	<b>Drive system</b>	TFT active matrix system
<b>Video input</b>		1.0 V p-p 75 Ω
<b>Rating</b>	<b>Power supply voltage</b>	24 VDC ± 10%
	<b>Current consumption</b>	700 mA max.
<b>Environment</b>	<b>Ambient temperature</b>	0 to +40° C (32 to +104° F)
	<b>Relative humidity</b>	35 to 85%, No condensation
<b>Weight</b>		Approx. 570 g



## Ring lamp (Option: CV-R11)

### ■ Illuminator

\* When mounting bracket (L) is attached. (Cable length: 2 m)

Unit: mm

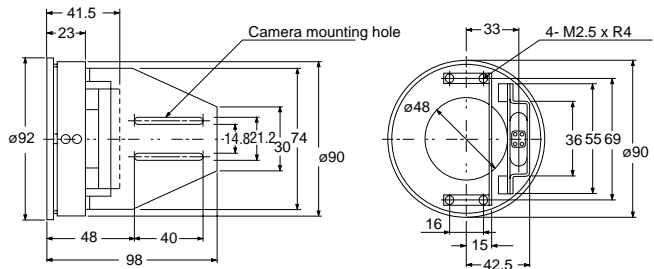

## Amplifier

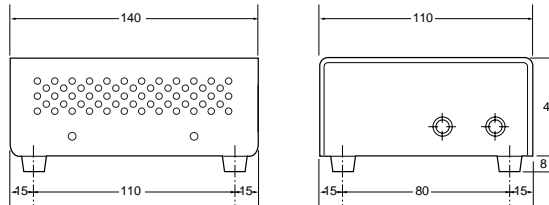

Unit: mm

## Mounting bracket (S)

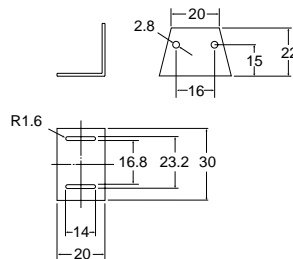

Unit: mm

<b>Lighting system</b>		Inverter type high-frequency light (25 to 35 kHz)
<b>Luminous color of lamp</b>		N-EX (daylight-balanced)
<b>Lamp dimensions</b>		Outer diameter: 80 mm, inner diameter: 56 mm.
<b>Average service life <sup>1</sup></b>		Approx. 2000 hrs. (Luminance deteriorates to 70%.)
<b>Initial average luminance <sup>2</sup></b>		800 lx $\pm$ 10% (250 mm below the lamp center)
<b>Luminance stability</b>		$\pm$ 1.5% for the variation of 100 VAC $\pm$ 10%
<b>Rating</b>	<b>Power supply voltage</b>	24 VDC $\pm$ 10% (50/60 Hz common)
	<b>Current consumption</b>	20 VA
<b>Environment</b>	<b>Ambient temperature</b>	+5 to +50° C (+41 to 122 ° F)
	<b>Relative humidity</b>	35 to 90%, No condensation
<b>Weight</b>	<b>Illuminator</b>	Approx. 150 g (including diffuser and mounting bracket)
	<b>Amplifier</b>	Approx. 650 g (including cable)

1. The average service life is the normal life expectancy of a lamp before the initial luminance deteriorates to 70%, with continuous use under an ambient temperature of 25° C (and in a vibration-free environment).

2. The initial average luminance is the luminance of a lamp in mint condition.

### Mounting stand for CV-751(P) (Option: OP-35481)

Unit: mm

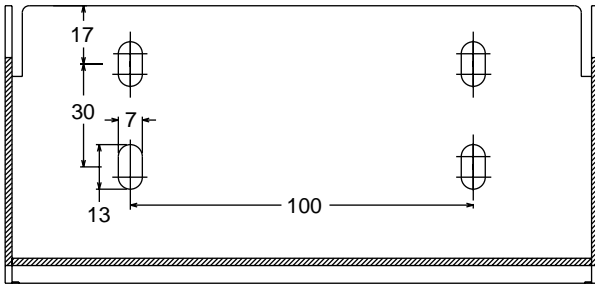

B-B Cross section

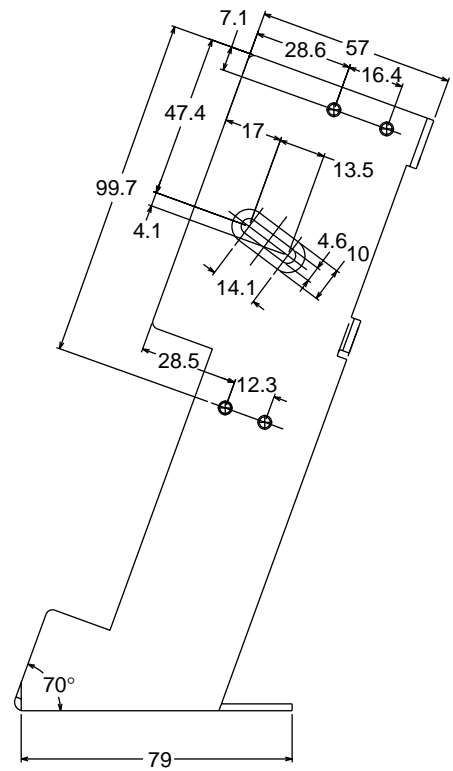
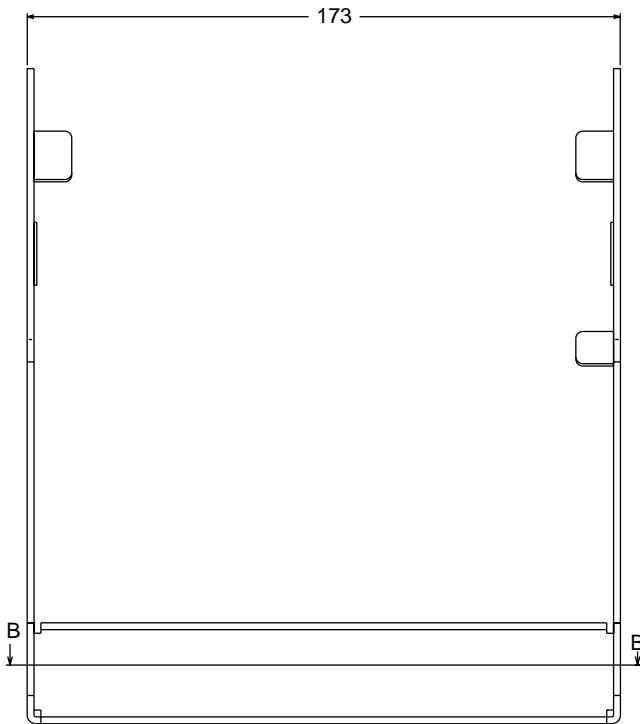

# Appendices

---

This section describes general troubleshooting procedures, a list of optional parts, and an index.

<b>Appendix A</b>	<b>General Troubleshooting</b> .....	206
<b>Appendix B</b>	<b>Optional Parts List</b> .....	208
<b>Appendix C</b>	<b>Index</b> .....	210
<b>Appendix D</b>	<b>Sample Sheets for Setup Menu</b> .....	213
<b>Appendix E</b>	<b>Sample Sheets for Testing</b> .....	215

## Appendix A General Troubleshooting

### Troubleshooting

Symptom	Probable Cause	Corrective action	Reference page
<b>Power supply does not turn on.</b>	The power cable is not connected correctly.	Connect the power cable correctly.	11
<b>No image appears on the monitor.</b>	The power supply exceeds the specific range.	Use the power supply within the specific range.	196
	The monitor cable is not connected correctly.	Turn off the power and then connect the monitor cable correctly.	12
	The lens cover is not removed.	Remove the lens cover.	–
	The lens diaphragm is not adjusted properly.	Adjust the lens diaphragm properly.	13
	The power supply is not turned on.	Turn on the power. Use the power supply within the specific range.	13
	The camera cable is not connected correctly.	Turn off the power and then connect the camera cable correctly.	12
	The monitor is not adjusted correctly.	Adjust the brightness, hue, etc.	14
<b>The menu appears, but no image appears. An abnormal image appears.</b>	The lens focus and diaphragm are not adjusted properly.	Adjust the focus and diaphragm.	13
	The shutter speed is not suitable.	Set the proper shutter speed.	*1
	The lens and CCD light-receiving surface are not clean.	Clean the lens and CCD light-receiving surface with an air duster.	–
<b>The remote control console does not operate.</b>	The remote control console is not connected correctly.	Turn off the power, and then connect the console correctly.	12
	The control selector is not set to the console.	Set the control selector to the console.	11
<b>RS-232C communication is disabled</b>	The communication cable is not connected correctly.	Turn off the power, and then connect the communication cable correctly.	181
	A proper communication cable is not used.	Check the wiring and connect a proper cable.	181
	The communication protocol is not set properly on the PC.	Change the communication protocol on the PC.	180
<b>Judgment result/numeric value is not output.</b>	The output unit is not connected correctly.	Refer to the output circuit and connect the output unit correctly.	165
	The CV-701(P)/751(P) is not set to RUN mode.	Slide the console slide switch to set RUN mode.	*2
	The tolerance is not set correctly.	Set the tolerance correctly.	*3
	The window does not enclose the target properly.	Retry the settings beginning from the screen registration. If targets deviate often, use the position adjustment function.	*4
	The illumination is not stable.	Use a stable illumination lamp designed for image processing.	15

Symptom	Probable Cause	Corrective action	Reference page
<b>The backlight turns off.</b>	The inner temperature is high.	Ensure that there is sufficient space for ventilation around the controller. Ensure that the cooling fan is working. Contact your nearest KEYENCE office if you find any abnormality.	7
<b>The power indicator illuminates red light.</b>			





- \*1. See page 38.
- \*2. See page 152.
- \*3. See pages 63, 77, 93, 114.
- \*4. See page 39.

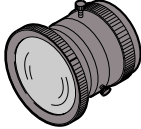
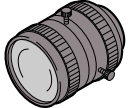

## Error messages

Message	Cause	Corrective action
<b>CAMERA CHANGED. INIT SETTING</b>	<ul style="list-style-type: none"> <li>• The camera connector is unplugged.</li> <li>• Another camera is connected.</li> </ul>	Turn off the power, check the camera connection, and then turn on the power again. To actually change the camera connection, press the [ENT] key to initialize the settings and set the camera again.
<b>USE CAM1</b>	Only Camera 2 is connected.	When using only one camera, turn off the power, connect to the CAM1, and then turn on the power again. When connecting two cameras, turn off the power, check the connection with CAM1, and then turn on the power again.
<b>INIT. SETTING</b>	The data in the internal memory is abnormal.	Press the [ENT] key to initialize the settings.
<b>CANNOT SET SCREE</b>	Internal damage occurred.	Contact your nearest KEYENCE office.

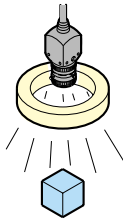
## Appendix B Optional Parts List

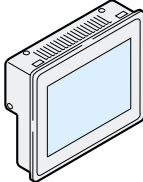
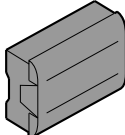
This section lists parts that allow you to maximize the function of the CV-701(P)/751(P).

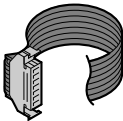
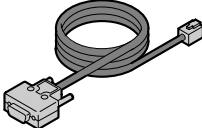
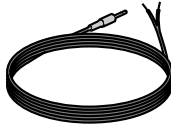
Product name	Model	Appearance	Description
3.5 mm lens	CV-L3		A wide-angle lens with a 3.5 mm focal length.
6 mm lens	CV-L6		A wide-angle lens with a 6 mm focal length.
16 mm lens	CV-L16		A standard lens with a 16 mm focal length.
50 mm lens	CV-L50		A telephoto lens with a 50 mm focal length.
Ring lamp	CV-R11		An 80 mm diameter ring lamp that offers inverter type higher frequency light. (Special polarizer is available. OP-35387)
Close-up adapter set	OP-35406		A set of 0.5, 1, 5, 10, and 22 mm close-up adapters.
TFT color monitor	CV-M30		A 5.5-inch, low profile color LCD monitor. Tabletop installation or panel mounting to a control panel is available.
Power supply	KV-U3* KV-U6W		A DC current power supply that provides 24 VDC, 1.4 A. (KV-U6W: 0.8 A) * KV-U3 is not available in Europe.

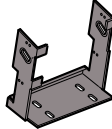
Product name	Model	Appearance	Description
I/O cable	OP-35341		Cable for the I/O connector. (cable length: 3 m)
RS-232C cable (D-sub 9-pin)	OP-35382		A special cable for RS-232C communication. (cable length: 3m)
RS-232C cable (D-sub 25-pin)	OP-25253		
Analog output cable	OP-41420		Cable to be connected to the analog output terminal. (cable length: 2 m)
CompactFlash memory	NR-M32		A 32-MB CompactFlash memory
PCMCIA adaptor	C-A1		An adaptor to place a CompactFlash memory to the PC card slot of a PC
Stand	OP-35481		Used when the CV-751(P) is not panel-mounted.

## Appendix C Index

This section provides a list of terms used in this manual in alphabetical order.

### Number

24 VDC power supply .....	3, 4, 11, 12, 156
24 VDC power supply input terminal .....	3, 4

### Alphabet

#### A

ABS. POS .....	23, 118
ACTION .....	174
ANG .....	114, 120
ARE/CON .....	18, 57, 65
AREA mode .....	18, 57
AREA mode/DATA .....	63
AREA mode/PROCES1 .....	66
AREA mode/PROCES2 .....	66
AREA mode/PROCES3 .....	66
AREA mode/PROCES4 .....	66
AREA mode/RAW SCRN .....	66
AREA mode/color menu .....	68
AREA mode/main menu .....	66
AREA mode/window menu .....	67
AREA/DET .....	61
AREA/MEASURE .....	61
AREA/TOL .....	62
AREAFILT .....	101
AUTO .....	47
AUTO OFF .....	146
AUTO SEQUENCE .....	147
AVERAGE .....	103
Analog output .....	166
Analog output terminal .....	3, 4, 166
Angle adjustment .....	114
Angle adjustment .....	114
Arc [ARC] window, drawing an .....	52

#### B

BACK .....	69, 102
BL → WH .....	129
BL ← WH .....	129
BRIGHT adjustment trimmer .....	14
Backlight .....	146
Basic setting procedures .....	36
Basic settings/CLR TYPE (Color type) .....	44
Basic settings/COLOR .....	44
Basic settings/COLOR1 .....	44
Basic settings/COLOR2 .....	44
Basic settings/Color extraction .....	44
Basic settings/GRAY .....	44
Basic settings/MODE selection .....	37

Basic settings/PROGRAM No. selection .....	36
Basic settings/SCRN REG .....	39
Basic settings/SEL SCRN .....	42
Basic settings/WIND1 .....	41
Binary conversion .....	ix

#### C

CALENDAR .....	149
CHANGE .....	145
CLEAR .....	49, 53
[CLEAR] key .....	32, 33
CLOCK .....	149
COLOR adjustment trimmer .....	14
Color extraction .....	44, 47, 48, 49, 69, 102, 105, 131, 132
COPY (Color setting) .....	44
COPY (Setting data) .....	146
COPY NO. ....	146
COUNT .....	20, 71, 80
COUNT/DATA .....	83
COUNT/MASK .....	81
COUNT/MEASURE .....	80
COUNT/TOL .....	81
COUNT/maximum number .....	80
COUNT/saving the settings .....	83
Camera .....	8, 13
Camera connector .....	3, 4
Circular [CIRC] window, drawing a .....	51
Circumference [RING] window, drawing a .....	52
Close-up adapter .....	9
Color gradation processing .....	ix
CompactFlash memory .....	171, 172
CompactFlash memory slot .....	3, 4
Control selector .....	3, 11
Correlation ratio .....	116
Cursor ([▲][▼][◀][▶]) keys .....	32
Cursor keys .....	32

#### D

DATA CAL .....	137
Data format .....	189
Dimensions .....	198

#### E

EDGE EM .....	103
EDGE EX .....	103
EDGE NO .....	20, 71, 75
EDGE SEN .....	100, 130
EDGE mode .....	127



[ENT] key ..... 32  
 [ESCAPE] key ..... 32, 33  
 EXECUTE ..... 175  
 EXPAND ..... 103  
 EXTERNAL ..... 145  
 Edge detection ..... 24, 109  
 Environmental setting ..... 144

**F**

FILE NAME ..... 175  
 FILE TYPE ..... 174  
 FILTER ..... 103, 131  
 FIT ..... 116, 120  
 Features ..... ix  
 Free square [F SQR] window, drawing a ..... 52

**G**

GRAVITY ..... 20, 71, 91  
 GRAVITY/MASK ..... 93  
 GRAVITY/MEASURE ..... 91  
 GRAVITY/TOL ..... 93  
 GRAVITY/TOL for angle ..... 93  
 GRAY ..... 44

**H**

HUE adjustment trimmer ..... 14

**I**

I/O connector ..... 3, 4, 156, 157  
 I/O terminal ..... 3, 4, 156  
 IGNORE ..... 48  
 INNER ..... 22, 70  
 INS mode ..... 70  
 INS+POS ..... 22, 106  
 INS/COLOR menu ..... 99  
 INS/DATA ..... 97  
 INS/FILTER ..... 103  
 INS/MEASURE ..... 76  
 INS/Main menu ..... 97  
 INS/PROCES1 ..... 97  
 INS/PROCES2 ..... 97  
 INS/PROCES3 ..... 97  
 INS/PROCES4 ..... 97  
 INS/RAW SCRN ..... 97  
 INS/TOL ..... 77  
 INS/TRG ..... 70  
 INS/TRG (AREA) ..... 57  
 INS/TRG (EDGE NO) ..... 71  
 INS/Window menu ..... 98  
 INT UP ..... 103  
 INTERNAL ..... 145

INVERT ..... 103  
 Illuminator ..... 15  
 Initialization ..... 142  
 Input circuit diagram ..... 165  
 Input/Output in [PROGRAM] mode ..... 143

**K**

Key-lock function ..... 152

**L**

LABEL ..... 175  
 LANGUAGE ..... 145  
 LEVEL ..... 105, 132  
 LEVEL (STAIN) ..... 89  
 LEVEL histogram ..... 105, 133  
 Lens ..... 3,4

**M**

MASK ..... 62, 81, 93  
 MEASURE ..... 61  
 MEDIAN ..... 103  
 MEMORYCARD ..... 175  
 MONITOR adjustment trimmer ..... 3  
 Mask window ..... 62, 81, 93  
 Menu hierarchy ..... viii  
 Menu screen ..... 34  
 Mode selection slide switch ..... 33  
 Modular connector ..... 3, 4  
 Monitor ..... 3  
 Monitor (CV-M30) ..... 4, 12  
 Monitor cable ..... 11

**N**

N.C. ..... 145  
 N.O ..... 145  
 No. .... 36

**O**

OBJT1/OBJT2 ..... 125  
 OFFSET ..... 138  
 OUT MODE ..... 145  
 OUTER ..... 19, 70  
 OUTPUT SYMBOL ..... 145  
 Optional parts ..... 208  
 Optional settings ..... 134  
 Output circuit diagram ..... 165  
 Over-scanning type monitor ..... 10

**P**

PITCH (Gap pitch) ..... 19, 70

POINT ..... 20, 71, 84  
 POINT/[MATCH] ..... 86  
 POINT/[SET] ..... 85  
 POINT/point ..... 84  
 POINT/size ..... 84  
 POINT: presence/absence setting ..... 85  
 POINT: saving the setting ..... 86  
 [PROGRAM No.] key ..... 32, 36  
 PW (Pattern window) ..... 112  
 Panel keys ..... 3, 32  
 Pixel ..... 19  
 Pixels, number of ..... 57  
 Position detection ..... 23, 109  
 Position detection/DATA ..... 119  
 Position detection/FILTER ..... 131  
 Position detection/PROCES1 ..... 119  
 Position detection/PROCES2 ..... 119  
 Position detection/RAW SCRN ..... 119  
 Position detection/color menu ..... 122  
 Position detection/main menu ..... 119  
 Position detection/window menu (EDGE) ..... 122  
 Position detection/window menu (PATT) ..... 120  
 Power indicator ..... 3, 4  
 Processing time display ..... 58, 72, 106, 110  
 Program No. .... 36

**R**

RAW SCRN ..... 55  
 REF WIND (Reference window) ..... 26  
 RS-232C BPS ..... 145  
 RS-232C OUT ..... 145, 149  
 RS-232C interface ..... 179  
 RUN external control ..... 153  
 RUN mode ..... 152  
 [RUN/PROGRAM] key ..... 32  
 Relative position detection ..... 25, 124  
 Remote control console ..... 3, 4, 12  
 Ring lamp ..... 15

**S**

SAVE ..... 64, 79, 117  
 SAVE SCR ..... 134  
 SCAN ..... 75  
 [SCREEN] key ..... 32, 33  
 SEN (Color sensitivity) ..... 48  
 SETUP MENU ..... 140  
 SHADING ..... 103  
 SHRINK ..... 103  
 SHUTTER ..... 38  
 SHUTTER speed ..... 38  
 SPAN ..... 137  
 SRCH SEN (Search sensitivity) ..... 125  
 SRCH SPD (Search speed) ..... 125

STAIN ..... 20, 71, 87  
 STAIN/LEVEL ..... 89  
 STAIN/MEASURE ..... 87  
 STAIN/SIZE ..... 88  
 SVD SCRN ..... 134  
 SW (Search window) ..... 113  
 Saving running image ..... 134  
 Screen registration ..... 39  
 Screen selection ..... 55  
 Screen selection display ..... 60, 74, 112  
 Square [SQR] window, drawing a ..... 51

**T**

TEST ..... 136  
 TINT UP ..... 103  
 TOL (AREA) ..... 62  
 TOL (COORD) ..... 114  
 TOL (DEV) ..... 116  
 TOL (INS) ..... 77  
 TRIGGER ..... 145  
 [TRIGGER] key ..... 32, 33  
 Tolerance display ..... 58, 72, 106  
 Tolerance for angle adjustment ..... 116  
 Two cameras ..... 42  
 Two cameras, connecting ..... 42

**U**

Under-scanning type monitor ..... 10  
 Unit conversion ..... 22, 137

**V**

Video output terminal ..... viii, ix

**W**

WHITE BALANCE ..... 148  
 WINDOW X ..... 129  
 WINDOW Y ..... 129  
 [WINDOW] key ..... 32  
 Window ..... 50  
 Window No. .... 41  
 Working distance ..... 8

**Z**

Zoom ..... 47

## Appendix D Sample Sheets for Setup Menu

### Sample sheets for setup menu

The adjusting procedures in SETUP menu (⇒ *page 140*) use a black rectangle placed in the field of view. Cut out this page and use it to adjust the settings. Cut out the rectangle according to the angle of the field of view.

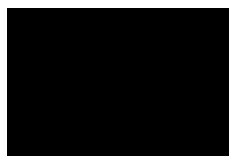
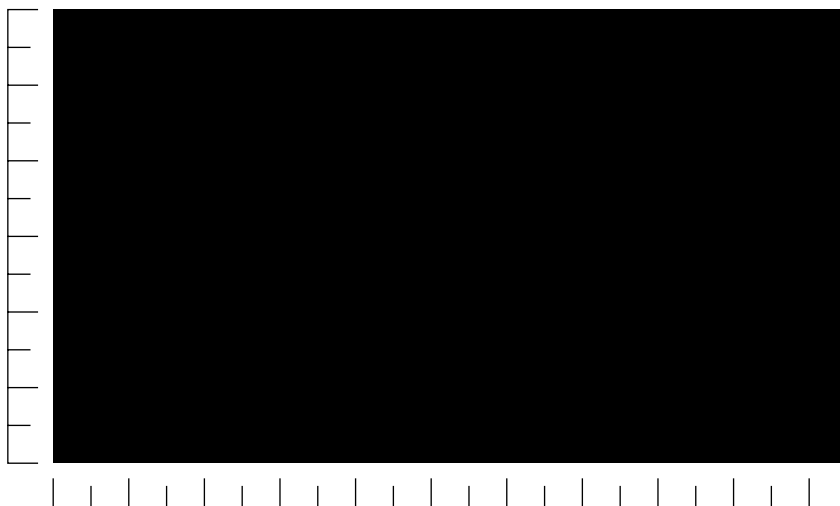

Tear-off line





## Appendix E Sample Sheets for Testing

The setting procedures in this manual use the following samples.  
Cut out this page and use them to practice changing the settings.



Tear-off Line



## WARRANTIES AND DISCLAIMERS

(1) KEYENCE warrants the Products to be free of defects in materials and workmanship for a period of one (1) year from the date of shipment. If any models or samples were shown to Buyer, such models or samples were used merely to illustrate the general type and quality of the Products and not to represent that the Products would necessarily conform to said models or samples. Any Products found to be defective must be shipped to KEYENCE with all shipping costs paid by Buyer or offered to KEYENCE for inspection and examination. Upon examination by KEYENCE, KEYENCE, at its sole option, will refund the purchase price of, or repair or replace at no charge any Products found to be defective. This warranty does not apply to any defects resulting from any action of Buyer, including but not limited to improper installation, improper interfacing, improper repair, unauthorized modification, misapplication and mishandling, such as exposure to excessive current, heat, coldness, moisture, vibration or outdoors air. Components which wear are not warranted.

(2) KEYENCE is pleased to offer suggestions on the use of its various Products. They are only suggestions, and it is Buyer's responsibility to ascertain the fitness of the Products for Buyer's intended use. KEYENCE will not be responsible for any damages that may result from the use of the Products.

(3) The Products and any samples ("Products/Samples") supplied to Buyer are not to be used internally in humans, for human transportation, as safety devices or fail-safe systems, unless their written specifications state otherwise. Should any Products/Samples be used in such a manner or misused in any way, KEYENCE assumes no responsibility, and additionally Buyer will indemnify KEYENCE and hold KEYENCE harmless from any liability or damage whatsoever arising out of any misuse of the Products/Samples.

(4) OTHER THAN AS STATED HEREIN, THE PRODUCTS/SAMPLES ARE PROVIDED WITH NO OTHER WARRANTIES WHATSOEVER. ALL EXPRESS, IMPLIED, AND STATUTORY WARRANTIES, INCLUDING, WITHOUT LIMITATION, THE WARRANTIES OF MERCHANTABILITY, FITNESS FOR A PARTICULAR PURPOSE, AND NON-INFRINGEMENT OF PROPRIETARY RIGHTS, ARE EXPRESSLY DISCLAIMED. IN NO EVENT SHALL KEYENCE AND ITS AFFILIATED ENTITIES BE LIABLE TO ANY PERSON OR ENTITY FOR ANY DIRECT, INDIRECT, INCIDENTAL, PUNITIVE, SPECIAL OR CONSEQUENTIAL DAMAGES (INCLUDING, WITHOUT LIMITATION, ANY DAMAGES RESULTING FROM LOSS OF USE, BUSINESS INTERRUPTION, LOSS OF INFORMATION, LOSS OR INACCURACY OF DATA, LOSS OF PROFITS, LOSS OF SAVINGS, THE COST OF PROCUREMENT OF SUBSTITUTED GOODS, SERVICES OR TECHNOLOGIES, OR FOR ANY MATTER ARISING OUT OF OR IN CONNECTION WITH THE USE OR INABILITY TO USE THE PRODUCTS, EVEN IF KEYENCE OR ONE OF ITS AFFILIATED ENTITIES WAS ADVISED OF A POSSIBLE THIRD PARTY'S CLAIM FOR DAMAGES OR ANY OTHER CLAIM AGAINST BUYER. In some jurisdictions, some of the foregoing warranty disclaimers or damage limitations may not apply.

**BUYER'S TRANSFER OBLIGATIONS:** If the Products/Samples purchased by Buyer are to be resold or delivered to a third party, Buyer must provide such third party with a copy of this document, all specifications, manuals, catalogs, leaflets and written information provided to Buyer pertaining to the Products/Samples.

Specifications are subject to change without notice.

---



**KEYENCE CORPORATION**

1-3-14, Higashi-Nakajima,  
Higashi-Yodogawa-ku,  
Osaka, 533-8555, Japan  
Phone: 81-6-6379-2211  
Fax: 81-6-6379-2131

**AFFILIATED COMPANIES**

**KEYENCE CORPORATION OF AMERICA**

Phone: 201-930-0100 Fax: 201-930-0099

**KEYENCE DEUTSCHLAND GmbH**

Phone: 06102-36 89-0 Fax: 06102-36 89-100

**KEYENCE (UK) LIMITED**

Phone: 01908-696900 Fax: 01908-696777

**KEYENCE FRANCE S.A.**

Phone: 01 47 92 76 76 Fax: 01 47 92 76 77

**KEYENCE SINGAPORE PTE LTD**

Phone: 392-1011 Fax: 392-5055

**KEYENCE (MALAYSIA) SDN BHD**

Phone: 03-252-2211 Fax: 03-252-2131

**KEYENCE (THAILAND) CO., LTD**

Phone: 02-369-2777 Fax: 02-369-2775

**KEYENCE TAIWAN CO., LTD**

Phone: 02-2627-3100 Fax: 02-2798-8925

**KEYENCE (HONG KONG) CO., LTD**

Phone: 3104-1010 Fax: 3104-1080

**KEYENCE INTERNATIONAL TRADING  
(SHANGHAI) CO., LTD.**

Phone: 021-68757500 Fax: 021-68757550

**KEYENCE KOREA CORPORATION**

Phone: 02-563-1270 Fax: 02-563-1271