

MELDAS DRIVE AMPLIFIER

MAINTENANCE MANUAL (II)

This Maintenance Manual covers the PU16, PU31 and PU71 power units as well as the TRA31, **TRA41** and **TRA61** transistor amplifiers which are used for the **MELDAS** numerical controller. Read through the instructions before use.

MELDAS DRIVE AMPLIFIER

MAINTENANCE MANUAL (II)

This Maintenance Manual covers the PU16, PU31 and PU71 power units as well as the TRA31, TRA41 and TRA61 transistor amplifiers which are used for the MELDAS numerical controller. Read through the instructions before use.

TABLE OF CONTENTS

1. FUNCTION	1
2. OUTLINE DIMENSIONS..	5
3. EXCHANGE METHOD AND HANDLING FOR THE TRANSISTOR AMPLIFIER	9
4. POWER UNIT SETTING	16
5. INSPECTION	
(1) Servo System Alarm Transmission Route	17
(2) Transistor Amplifier Inspection	18
(3) Power Unit Inspection	23

1. FUNCTION

The transistor amplifier amplifies the power by high frequency switching according to the pulse width modulation method for the error voltage (command voltage) by comparing the position detector output and the calculation result output from the logic card of the control unit in regard to the movement command.

(1) Drive Amplifier Composition

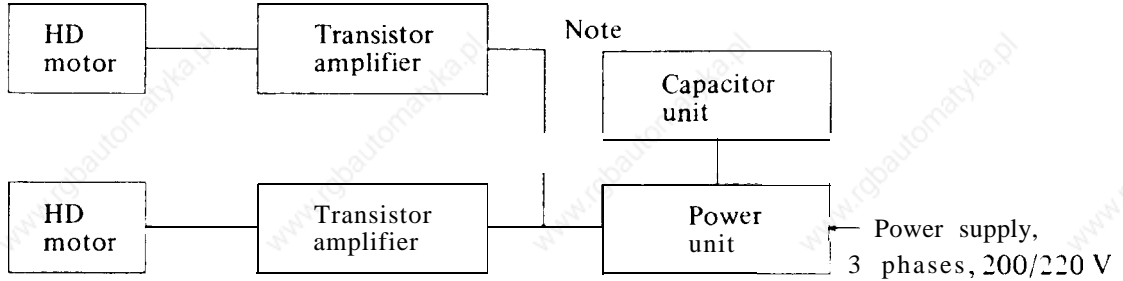

Note: The capacitor unit may be added or not according to the load inertia (JL) referred to the motor shaft.

(2) Power Unit Types

Power unit PU16 <input type="checkbox"/>	Transformer	3 PH 2.3 KVAMTR
	Rectifier unit	DU 30 <input type="checkbox"/>
	Capacitor unit	CU 15 <input type="checkbox"/>
Power unit PU31 <input type="checkbox"/>	Transformer	3 PH 3.8 KVAMTR
	Rectifier unit	DU 30 <input type="checkbox"/>
	Capacitor unit	CU 30 <input type="checkbox"/>
Power unit PU71 <input type="checkbox"/>	Transformer	3 PH 8.0 KVAMTR
	Rectifier unit	DU 70 <input type="checkbox"/>
	Capacitor unit	CU 30 <input type="checkbox"/>

(3) Block Diagram for the Drive Part (Transistor Amplifier)

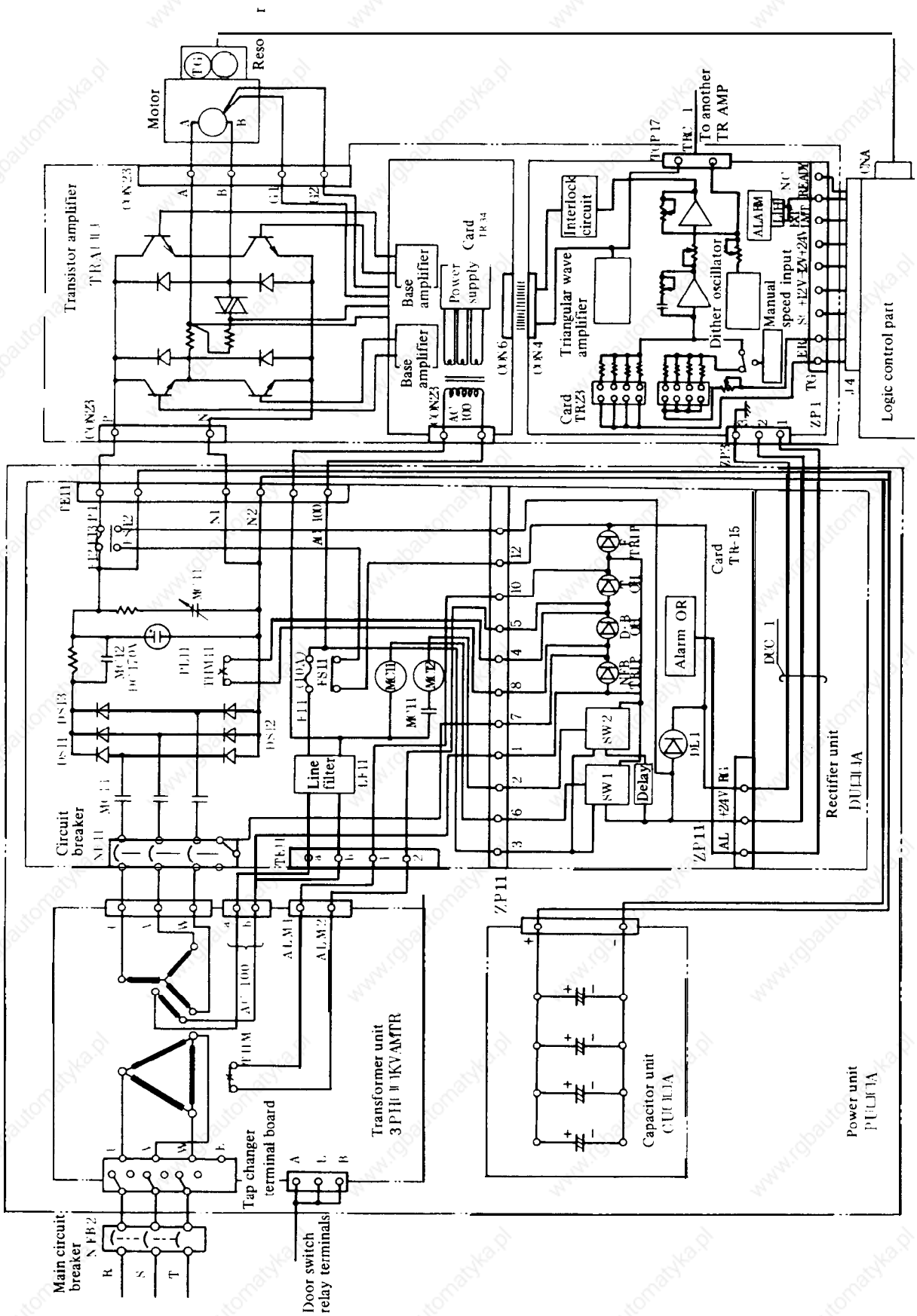

(4) Cable Connection Diagram

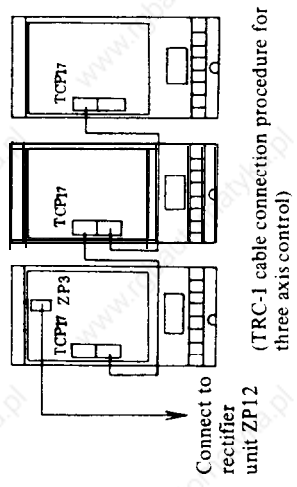
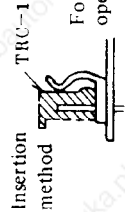
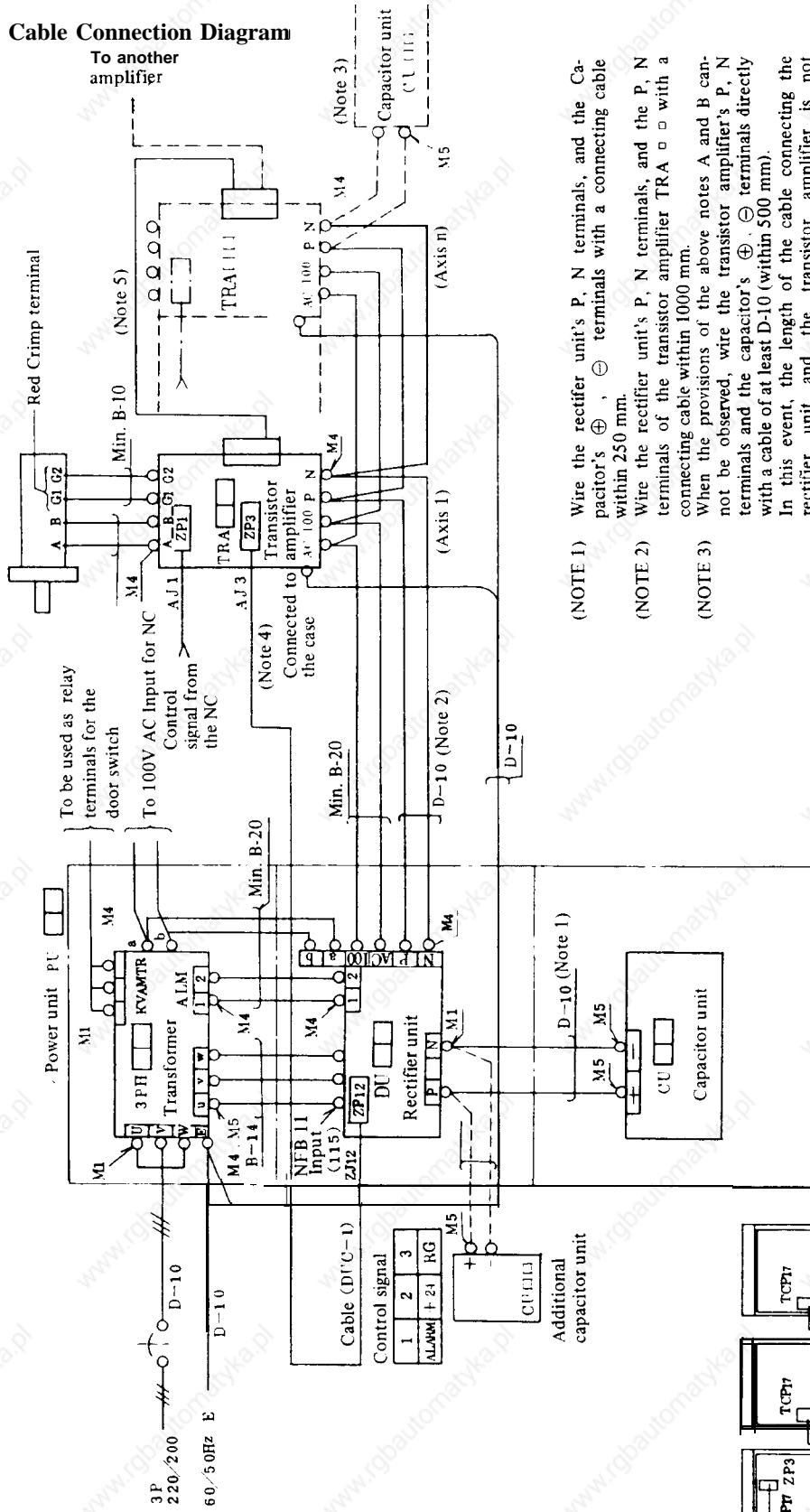

Transistor amplifier external connection diagram

- Note 1: Connect cable DUC-- 1 to connector ZP3 of the primary axis of the transistor amplifier from the rectifier unit (connection to the other axis amplifier is not required).
(Refer to transistor amplifier connection diagram, p. 9).
- Note 2: The cable connecting PN of the rectifier unit and the \oplus and \ominus terminals of the capacitor unit must be 250 mm, or less.
- Note 3: The cable connecting PN of the rectifier unit and PN of the transistor amplifier TRA□□ must be 1,000 mm, or less.
- Note 4: When above notes 2 and 3 cannot be observed, connect PN of the transistor amplifier and \oplus \ominus of the capacitor unit with wire of at least D-10 (max. 500 mm).
In this case, the connection length between the rectifier unit and the transistor amplifier TRA□ □ is not specified.
- Note 5: Refer to the table below for the designated wire ratings:

D - 10	Min. 5.3 mm ²
B - 14	Min. 2.0 mm ²
B - 20	Min. 0.5 mm ²

2. OUTLINE DIMENSIONS

(1) Transistor Amplifier

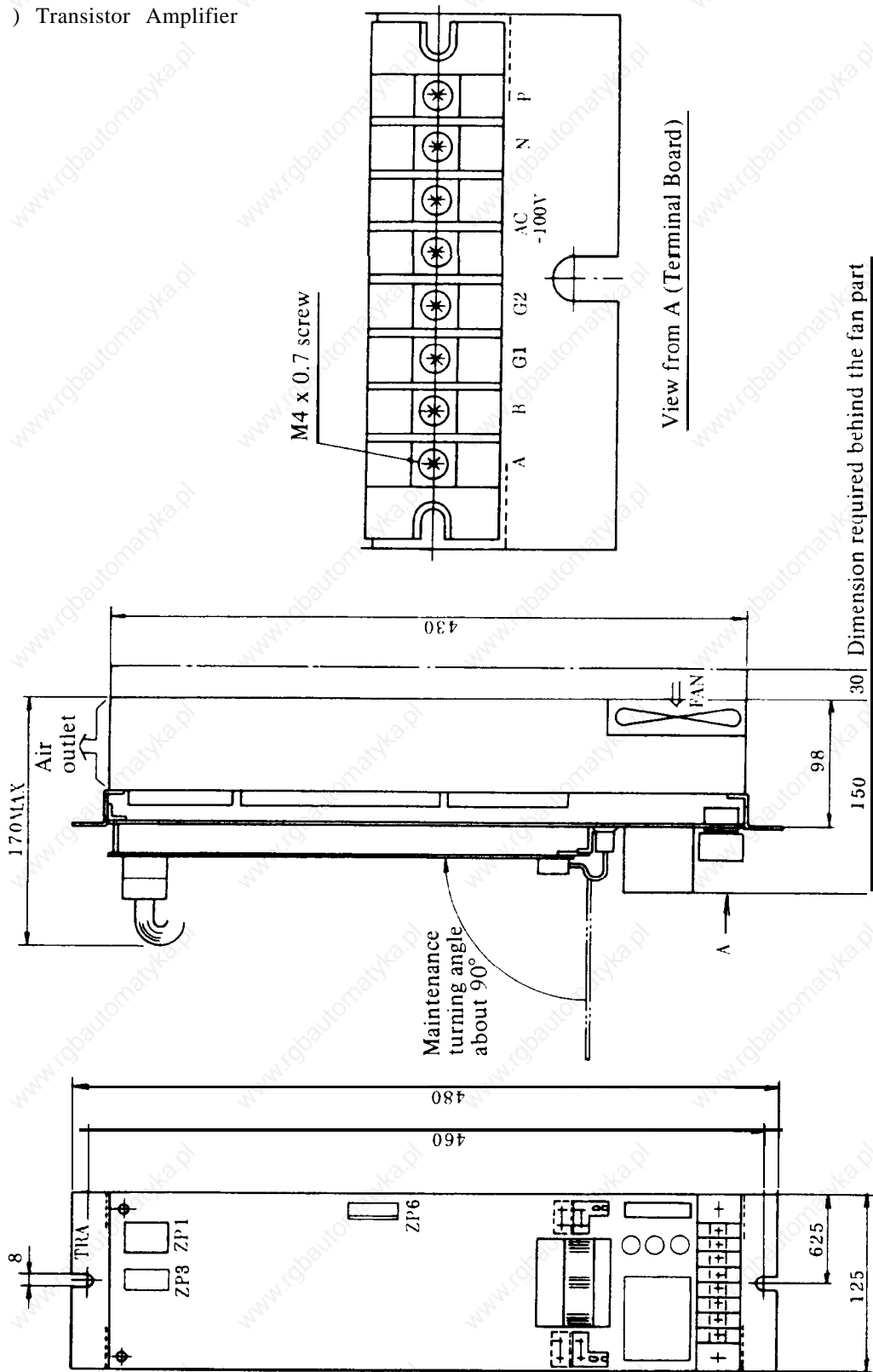

TRA 31, TRA 41, TRA 61 External Diagram

(2) Power Unit (PU16, PU31, PU71)

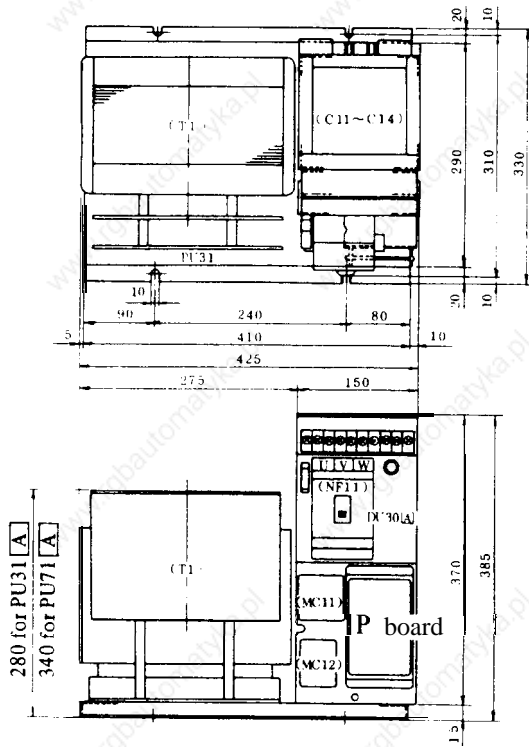

Power Unit Outline Diagram

Note:

The outline dimensions for power unit PU16 **A** are the same as for PU31 **A**, but C11 and C12 are not provided.

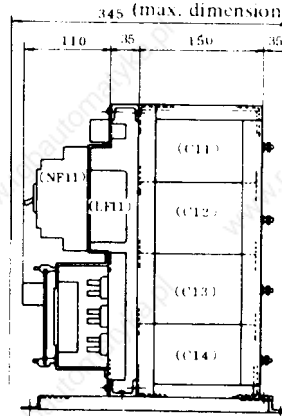

(3) Transformer

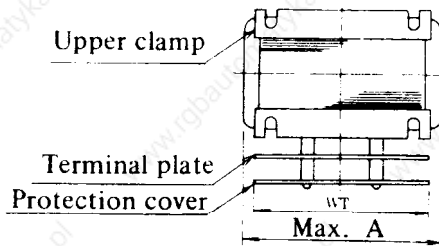

Note:

M4 x 0.7 screws are used for all connection terminals.

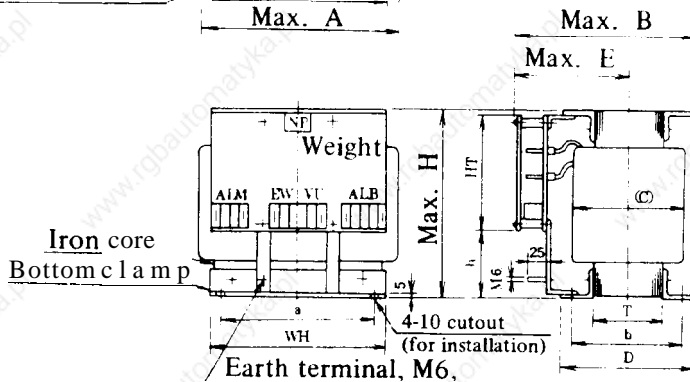

/connect the static electricity shield.

Type name	A	B	H	a	b	c	E	T	WT	WT	HIT	h	D	Primary terminal	Secondary terminal	ALB terminal	Weight	Remarks
3PH2.3KVAMTR	245	250	230	210	150	160	160	98	240	240	160	60	180	TS5 03P	M4 screw	TSS 03P	About 35 kg	
3PH3.8KVAMTR	270	250	265	210	150	160	160	98	240	240	160	95	180	TS5 03P	M4 screw	TSS 03P	About 48 kg	
3PH 8KVAMTR	270	250	325	210	150	160	160	98	240	240	160	150	180	TS5 03P	M4 screw	TSS 03P	About 63 kg	
3PH9KVAMTR-U	270	250	325	210	150	170	160	98	240	260	250	60	180	TS5 03P	M4 screw	TSS 03P	About 65 kg	

Transformer Outline Diagram

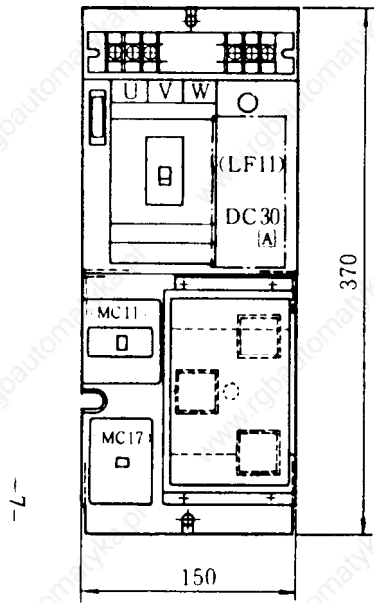

-7-

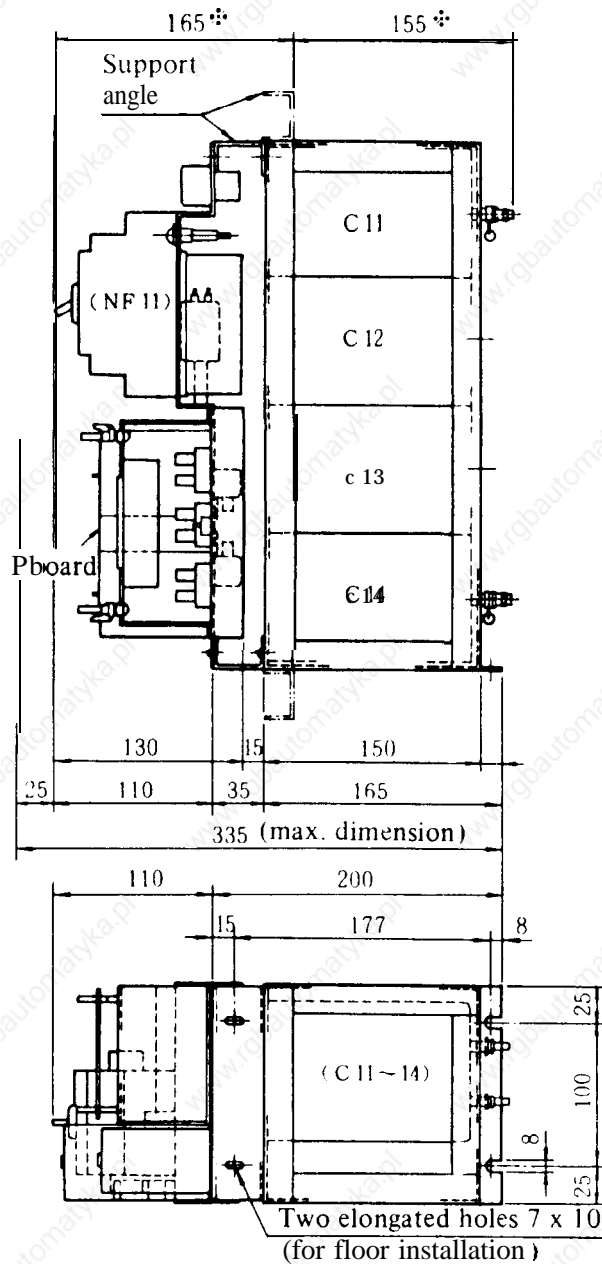

Capacitor/Rectifier Unit Outline Diagram

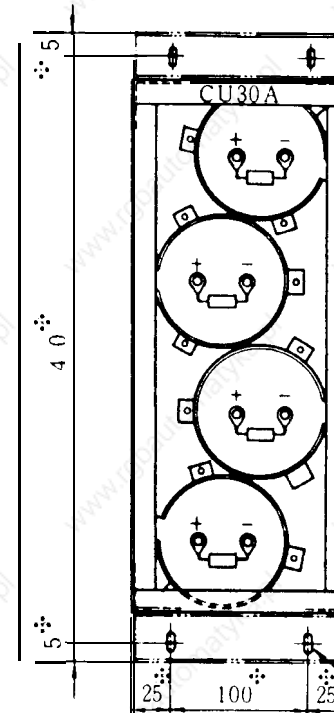

*Four oval-shapey holes 7 x 10 (for rack installation)

Note :

The unit is normally installed on the floor but it can also be installed on a rack by adding a support angle. In this case, order the support angle separately. The dimensions marked by * are the dimensions for rack installation. (The additional support angle is shown by a dotted line.)

	DU30+CU15	DU30+CU30	DU70+CU30
Weight	9.5 kg	12 kg	12.5 kg

(4) Capacitor/Rectifier Unit

(5) Rectifier Unit (DU30, DU70)

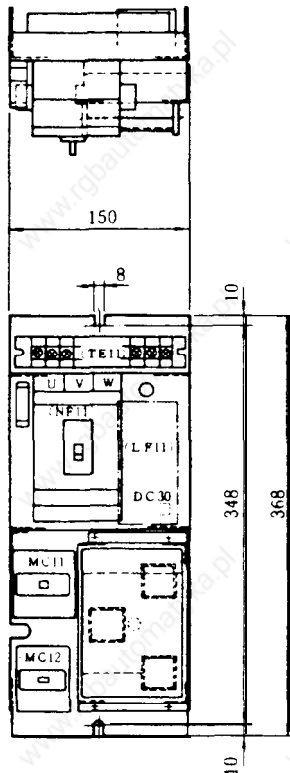

Note :

DU70A and DU30A have the same outline dimensions, but the internal installation parts differ slightly.

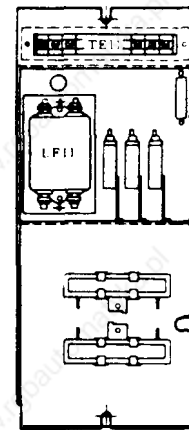
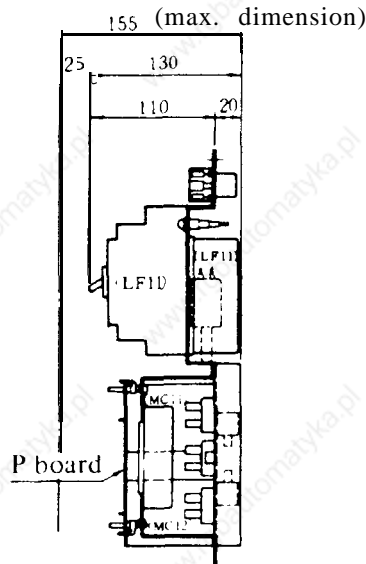

Rectifier Unit Outline Diagram

	DU30	DU70
Weight	4.5 kg	5.0 kg

(6) Capacitor Unit (CU15, CU30)

2 elongated holes
(for floor installation)

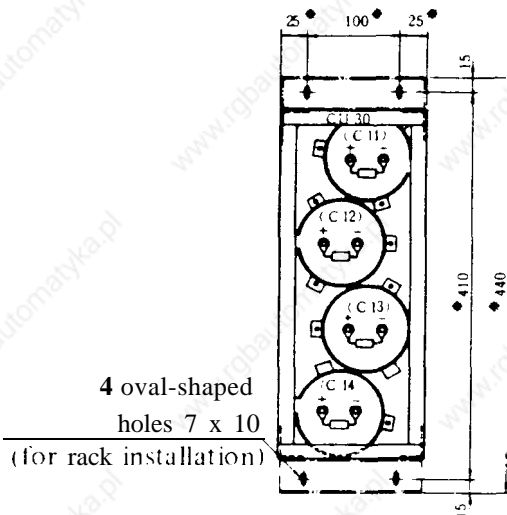
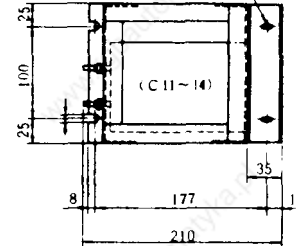

4 oval-shaped holes 7 x 10
(for rack installation)

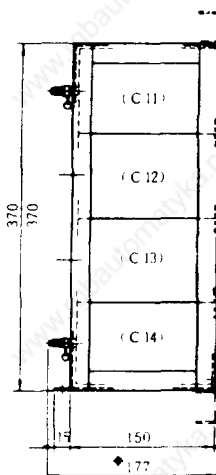

Notes:

- By changing the installation position of the support angle, floor as well as rack installation is possible. The dimensions marked by • indicate rack installation. (The support angle for rack installation is shown by dotted line.)
- CU15 **A** has the same external dimensions as CU30 **A**, but C11 and C12 are not provided.

Capacitor Unit Outline Diagram

	CU15	CU30
Weight	5 kg	7.5 kg

3. EXCHANGE METHOD AND HANDLING FOR THE TRANSISTOR AMPLIFIER

(1) Connecting the Transistor Amplifier

To power unit

[The terminal board CON23 is connected to the drive motor.
The unit body is installed to the rack by 2 set screws.]

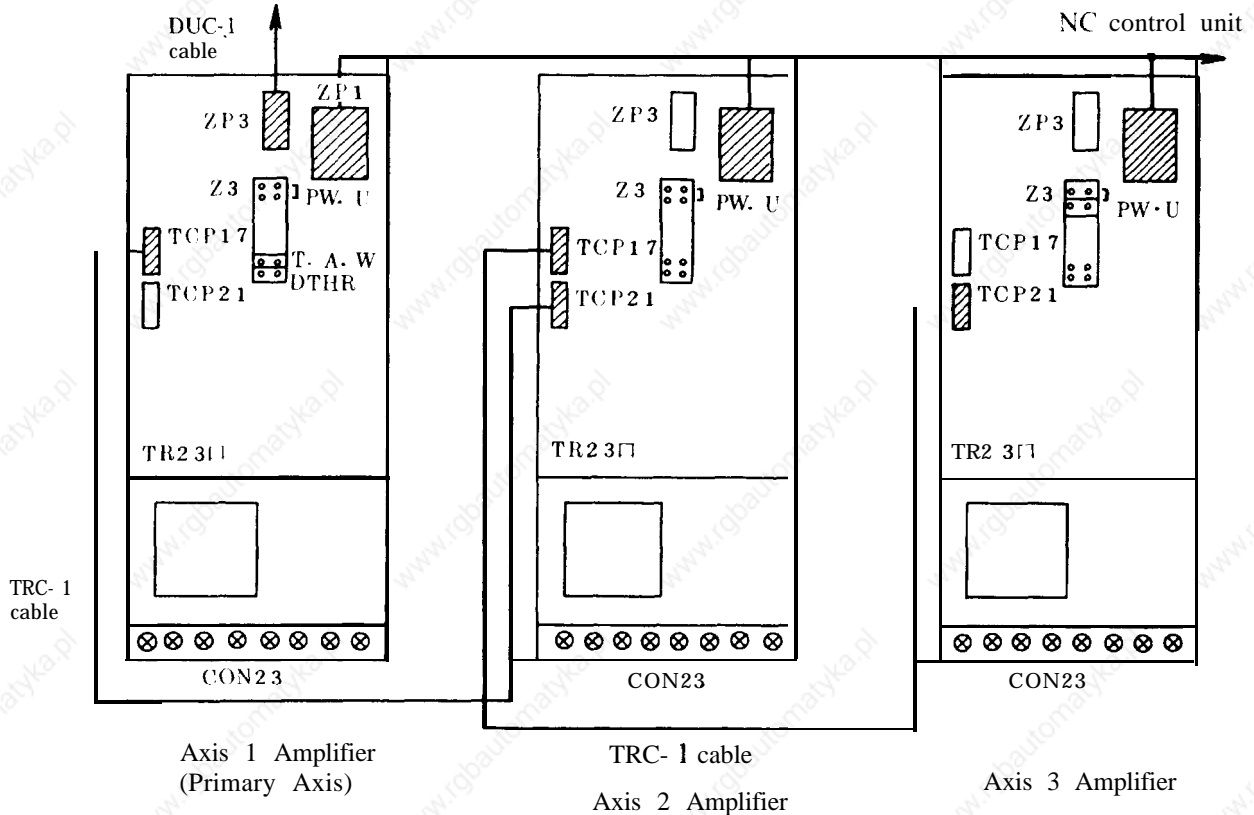

- ① Each control card (TR23 □) has two short-circuit bars on T.A.W. and DTHR of the setting plug (Z3). Remove these two short-circuit bars from all axes except one. By doing this, the triangular waves and dither frequency on each axis will be made uniform. REF: [In the above diagram, the short-circuit bars are shown in place on Axis 1 only, but exactly the same results will be obtained by leaving the bars in place on Axis 2, and removing them from Axes 1 and 3.]
- ② Connect the TRC-1 cable as shown in the above diagram as follows:
 1. Connect ZP3 (DUC-I cable) to the primary axis.
 2. Using the TRC-1 cable connect TCP 17-20 (upper connectors) of the primary axis to TCP 21~ 24 (lower connectors) of the other axis.
 3. Perform above operation #2 in accordance with the number of axes used.
 4. Remove the PW.U of the Z3 setting plug on all but the last axis.

- ③ If you use old style amplifiers together with new, take the following precautions:
1. Remove PW.U of the Z3 setting plug. (If it is left in, a short will occur between +24V and ground .)
 2. At this time, connect the DUC-I cable attached to ZP3 to the old style amplifier. (If it is connected to the new amplifier, the +24V electrical current will not be supplied to the power unit .)
(In this case, even during an Alarm, the current will not drop.)

④ Insertion method for cable TRC 1

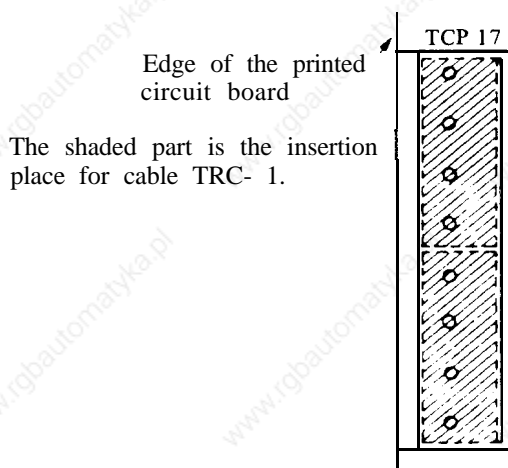
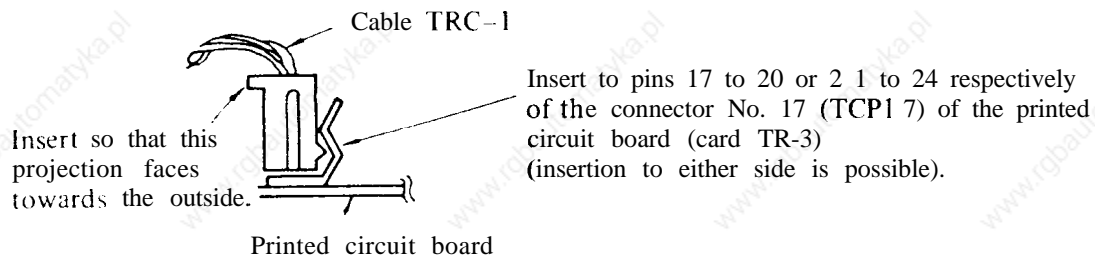

Note:

As the control card (TR23) has setting plugs and adjustment volumes, setting must be executed in case of card exchange.

(2) Handling Precautions

① Earth (E) and GND

- a. TR 23□ - 3 1 As there are three types of earth, take care that the different
 TR 23□ - 41 card: earth signals are not connected simultaneously to the earth
 TR 23□ - 61 of the synchroscope.

Correspondence between earth and check pins

	Signal check pin number	Corresponding earth terminal
Group 1	TCP1 ~ TCP3 6	TCP2 7 - TCP2 9
Group 2	TCPA (TCPB)	TCPB (TCPA)
Group 3	TCP C	TCP D

- b. TR 34□ card: As the earth differs for each check pin, execute synchroscope confirmation separately for each channel.
 Simultaneous observation of 2 channels is not possible (this can cause defects).

Correspondence between earth and check pins

	Signal check pin number	Corresponding earth terminal
Group 1	B 1	E 1
Group 2	B 2	E 2
Group 3	B 3	E 3
Group 4	B 4	E 4

- ② Pay sufficient attention to the wiring of P and N of the transistor amplifier and connect after confirmation to avoid wiring errors.

(3) General View of Circuit Board (control card TR23)

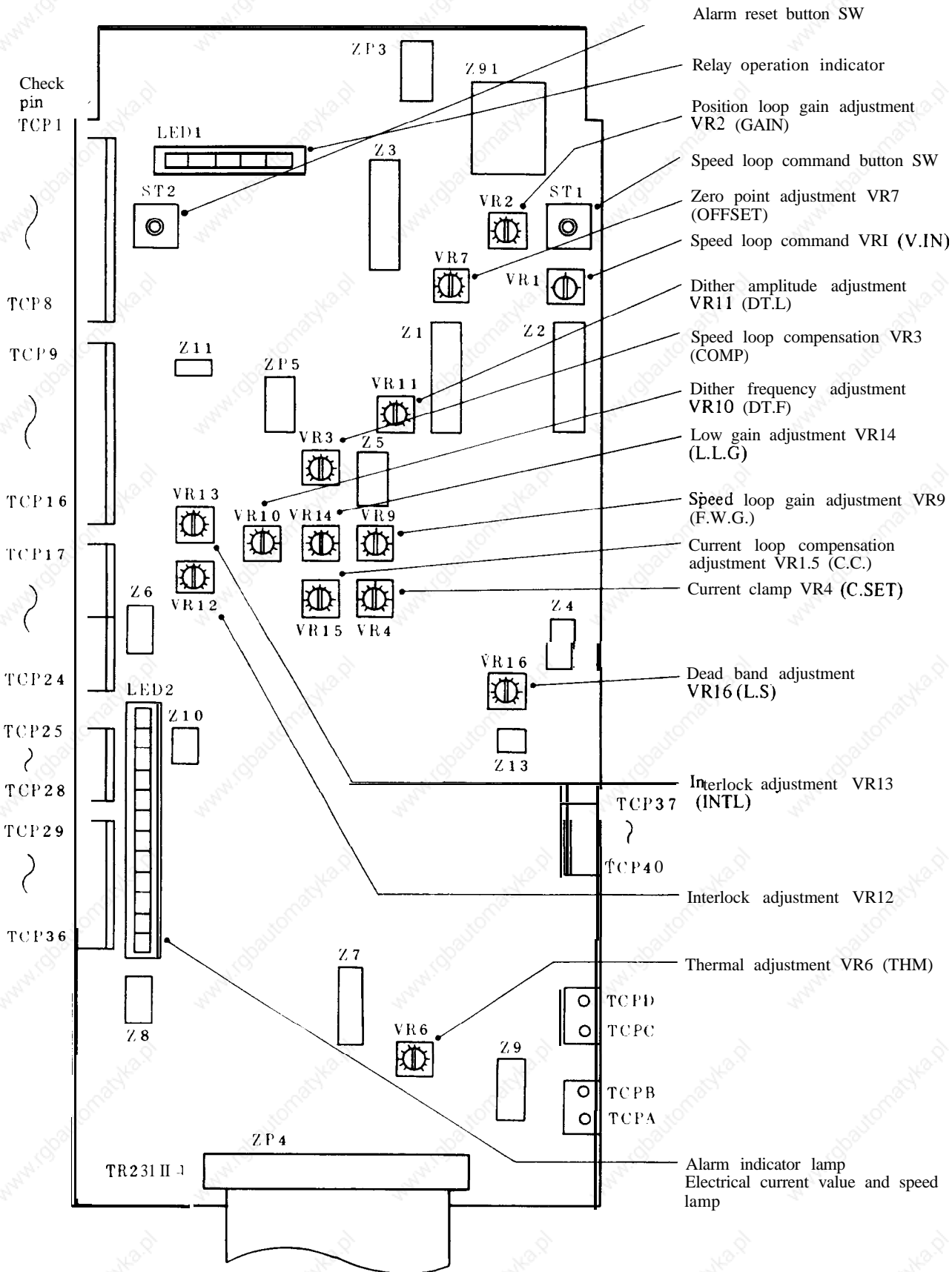

(4) Setting by Setting Plugs

As this setting has been set at the time of shipment according to the specifications of the machine manufacturer, no change is required.

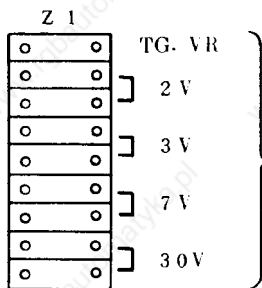
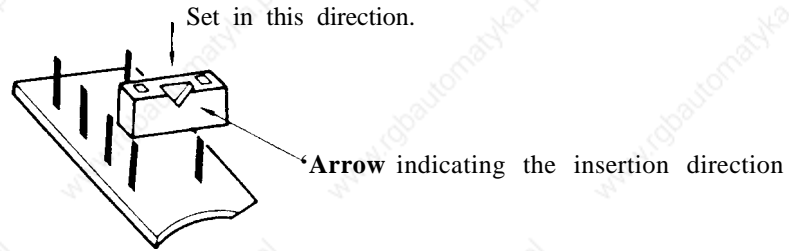

Setting according to the type of speed feedback **TG** (for **TG** feedback selection)

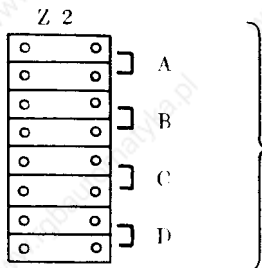

Setting according to the type of detector gear box (for position loop gain adjustment)

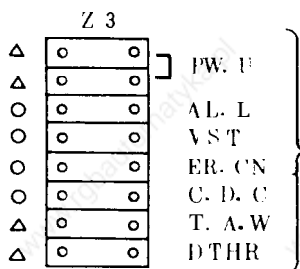

Setting to standard (○), and setting only one of multiple axes (△)

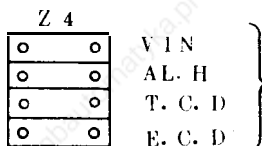

A setting which is normally not set

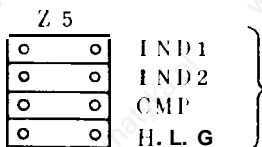

Setting in accordance with control loop characteristics

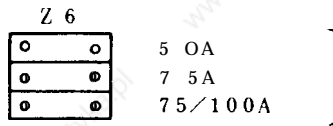

Setting in accordance with armature current

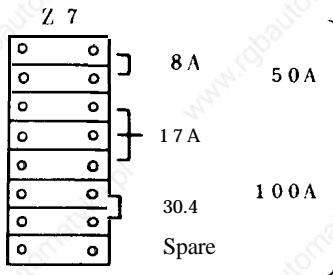

Setting in accordance with type of motor (For Electronic thermal current value setting)

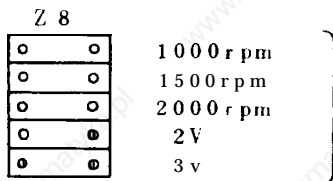

Setting in accordance with type of tachometer generator and maximum rpm utilized

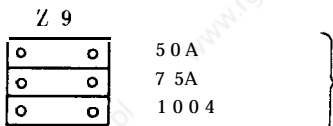

Setting in accordance with abnormal current detection level

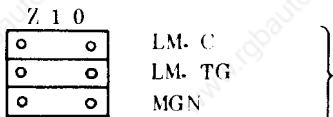

Level meter (LED 2) switching setting

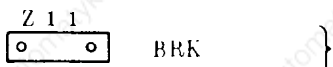

Removed when brake unit is added. (Normally refers to the setting plug)

Transistor amplifier and motor correspondence.

Transistor amplifier	Motor.		VR6 graduations	Z7 setting	Rating
	Former series.	Medium inertia series.			
TRA31	HD40	HD41	0	①, ②	8A
		HD81	2	③, ⑤	9A
	HD80	HD101	0	③, ④	14A
	HD100		0	②, ③, ⑦	17A
TRA41	HD40	HD41	10	④, ⑤	8A
		HD81	5	④, ⑤	9A
	HD80	HD101	3	④, ⑤	14A
	HD100	HD201	4	④, ⑦	17A
	HD200	HD301	0	③, ⑥	30A
	HD300				
TRA61		HD101	3	④, ⑤	14A
	HD100	HD201	4	0.0	17A
		HD301-13	2	⑥, ⑦	24A
TRA91	HD200	HD301H-12	0	③, ⑥	30A
	HD300				
TRA91		HD301H-13	0	③, ⑥, ⑦	36A

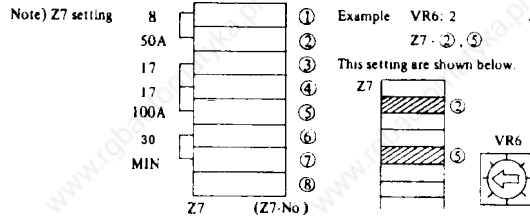

Note) HD301 shows HD301-12 (1000 rpm spc)

(5) Setting by Volume

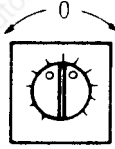
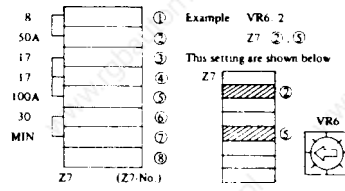
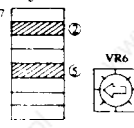
Volume No.	Name	Function	Setting																																																																													
1	Speed loop command volume	<p>Motor speed command at the time of speed loop operation.</p> 	<ul style="list-style-type: none"> Applies when V.IN (Z 4-1) setting plug is inserted. The motor can be turned by pushing V.CHECK (ST 1) pushbutton. <div style="border: 1px solid black; padding: 2px; display: inline-block;">Normally leave the V.IN out.</div> This volume normally is set to 5. (Do not touch this volume when a motor is installed on the machine.) 																																																																													
2	Position loop gain adjustment volume	Adjustment of the position loop gain	As this volume has been adjusted before shipment, do not change its setting.																																																																													
3	Speed loop compensation volume	<p>Adjustment of system response and stability. Turning the volume has the following results. Clockwise turning: The response is improved, but stability decreases. Counterclockwise turning: The response decreases, but stability is improved.</p>	<ul style="list-style-type: none"> Turn in stability direction (counterclockwise) when there are severe vibrations on the machine side. When the movement tends to overshoot, turn in direction of improved response (clockwise). <p>(Turning should be executed in steps of one half graduation. Large changes can cause hunting.)</p>																																																																													
4	Current clamp volume	<p>Maximum current flowing to motor is regulated by the amplifier</p> <p>T It A 6 1 9 0 A TR A 4 1 6 5 4 T R A 3 1 4 5 .A</p>	<p>Setting to the specified current value has been executed at the time of shipment. Do not change the setting of this volume, as this may cause transistor damage.</p>																																																																													
6	Thermal setting volume	<p>Setting is executed according to the rated current of the used motor. This volume specifies the ratio in regard to the setting position at setting plug Z7.</p>	<p>The settings for each motor are shown below.</p> <table border="1" data-bbox="948 1244 1442 1676"> <thead> <tr> <th rowspan="2">Transistor amplifier</th> <th colspan="2">Motor</th> <th rowspan="2">VR6 graduations</th> <th rowspan="2">Z7 setting</th> <th rowspan="2">Rating</th> </tr> <tr> <th>Former series</th> <th>Medium inertia series</th> </tr> </thead> <tbody> <tr> <td rowspan="4">TRA31</td> <td>HD40</td> <td>HD41</td> <td>0</td> <td>①, ②</td> <td>8A</td> </tr> <tr> <td>HD81</td> <td></td> <td>2</td> <td>②, ③</td> <td>9A</td> </tr> <tr> <td>HD80</td> <td>HD101</td> <td>0</td> <td>③, ④</td> <td>14A</td> </tr> <tr> <td>HD100</td> <td></td> <td>0</td> <td>②, ③, ④</td> <td>17A</td> </tr> <tr> <td rowspan="4">TRA41</td> <td>HD40</td> <td>HD41</td> <td>10</td> <td>④, ⑤</td> <td>8A</td> </tr> <tr> <td>HD81</td> <td></td> <td>5</td> <td>④, ⑤</td> <td>9A</td> </tr> <tr> <td>HD80</td> <td>HD101</td> <td>3</td> <td>④, ⑤</td> <td>14A</td> </tr> <tr> <td>HD100</td> <td>HD201 HD301</td> <td>4</td> <td>④, ⑤</td> <td>17A</td> </tr> <tr> <td rowspan="3">TRA61</td> <td>HD200 HD300</td> <td></td> <td>0</td> <td>④, ⑥</td> <td>30A</td> </tr> <tr> <td>HD100</td> <td>HD201 HD301</td> <td>3</td> <td>④, ⑤</td> <td>14A</td> </tr> <tr> <td></td> <td>HD301-13</td> <td>2</td> <td>④, ⑤</td> <td>17A</td> </tr> <tr> <td rowspan="2">TRA91</td> <td>HD200 HD300</td> <td>HD301H 12</td> <td>0</td> <td>③, ④</td> <td>30A</td> </tr> <tr> <td></td> <td>HD301H 13</td> <td>0</td> <td>③, ⑥, ⑦</td> <td>36A</td> </tr> </tbody> </table> <div data-bbox="948 1691 1442 1883"> <p>Note) Z7 setting</p>  <p>Example VR6 2 Z7 ②, ③</p> <p>This setting are shown below</p>  <p>Note) HD301 shows HD301 12 (1000 rpm spc)</p> </div>	Transistor amplifier	Motor		VR6 graduations	Z7 setting	Rating	Former series	Medium inertia series	TRA31	HD40	HD41	0	①, ②	8A	HD81		2	②, ③	9A	HD80	HD101	0	③, ④	14A	HD100		0	②, ③, ④	17A	TRA41	HD40	HD41	10	④, ⑤	8A	HD81		5	④, ⑤	9A	HD80	HD101	3	④, ⑤	14A	HD100	HD201 HD301	4	④, ⑤	17A	TRA61	HD200 HD300		0	④, ⑥	30A	HD100	HD201 HD301	3	④, ⑤	14A		HD301-13	2	④, ⑤	17A	TRA91	HD200 HD300	HD301H 12	0	③, ④	30A		HD301H 13	0	③, ⑥, ⑦	36A
Transistor amplifier	Motor		VR6 graduations		Z7 setting	Rating																																																																										
	Former series	Medium inertia series																																																																														
TRA31	HD40	HD41	0	①, ②	8A																																																																											
	HD81		2	②, ③	9A																																																																											
	HD80	HD101	0	③, ④	14A																																																																											
	HD100		0	②, ③, ④	17A																																																																											
TRA41	HD40	HD41	10	④, ⑤	8A																																																																											
	HD81		5	④, ⑤	9A																																																																											
	HD80	HD101	3	④, ⑤	14A																																																																											
	HD100	HD201 HD301	4	④, ⑤	17A																																																																											
TRA61	HD200 HD300		0	④, ⑥	30A																																																																											
	HD100	HD201 HD301	3	④, ⑤	14A																																																																											
		HD301-13	2	④, ⑤	17A																																																																											
TRA91	HD200 HD300	HD301H 12	0	③, ④	30A																																																																											
		HD301H 13	0	③, ⑥, ⑦	36A																																																																											

Volume No.	Function	Setting
7	Zero point adjustment volume Volume for fine adjustment of the droop near zero with a position loop established. (Readjust when the machine moves at the time of NC power supply ON.)	Adjust by turning the volume so that the droop with the operation panel of the NC side set to "POD" becomes close to zero.
9	Speed loop gain adjustment volume Volume in regard to servo rigidity. Turning of the volume has the following results. Turning in clockwise direction: Servo rigidity is increased, but excessive turning causes instability. Turning in counterclockwise direction: Servo rigidity is decreased, but stability is increased.	Control system and detection system response have been adjusted at the time of shipment.
10	Dither frequency adjustment volume Adjustment of the dither frequency.	Effective only for VR10 of the axis with DTHR inserted for setting Z4 , and the other axis also becomes the same frequency as this axis.
11	Dither amplitude adjustment volume Adjustment of the dither amplitude.	The amplitude is changed individually for each axis.
12	Interlock adjustment volume Perform interlock adjustment on transistors 1 and 2.	This has been adjusted at the time of shipping; do not change the volume graduations.
13	Interlock adjustment volume Perform interlock adjustment on transistors 3 and 4.	This has been adjusted at the time of shipping; do not change the volume graduations.
14	Low gain adjustment volume Perform servo rigidity adjustment at low speed.	Servo rigidity (stability) in all speed ranges can be adjusted with VR9 , but when you want to increase servo rigidity at low speed, turn in direction of CW. If it is turned too much, VR9 identical stability will be lost, and the motor axis will vibrate.
15	Current loop compensation adjustment volume Adjust the current loop response.	Normally, set on graduation 5.
16	Insensitivity-band range adjustment volume Adjust the current insensitivity band.	This has been adjusted at the time of shipping; do not change volume graduations.

4. POWER UNIT SETTING

Setting is executed by the short-circuit bar for the tap change over for 200/220 V AC of the transformer unit according to the input voltage.

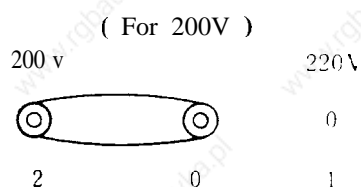
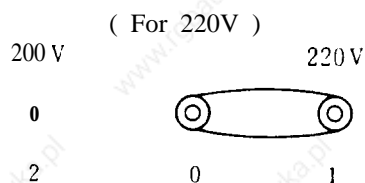

(1) Servo System Alarm Transmission Route
5. INSPECTION

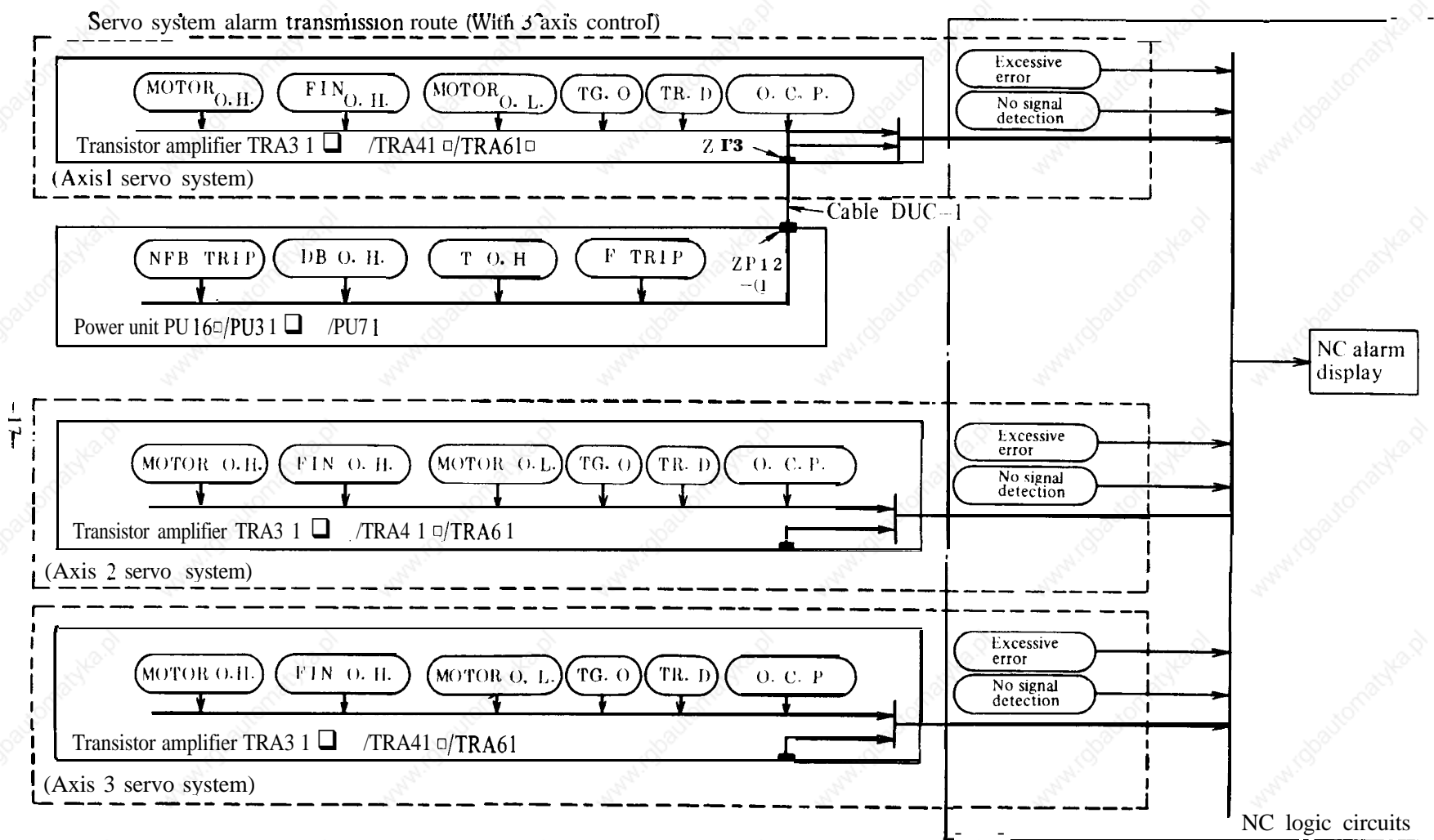

(NOTE 1): When the axis 1 transistor amplifier's ZP3 and the power unit's ZP1 2 are connected (by cable DUC-1).

(2) Transistor Amplifier Inspection

① Transistor amplifier indicator lamps (control card **TR 23** □)

1) Relay Indicator Lamps

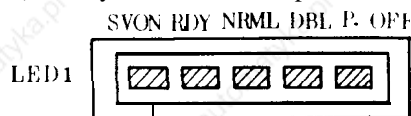

NAME	FUNCTION
SVON	Lights when servo is ON. Goes out when servo is OFF.
RDY	Lights when NC READY. Goes out with READY OFF.
NRML	Lights when NC Power is ON and conditions are normal. Goes out when there is an alarm.
DBL	Lights when dynamic brake signal is ON. Goes out when conditions return to normal.
P.OFF	Lights when POWER OFF signal is ON. Goes out when conditions return to normal.

2) Alarm Indicator Lamps

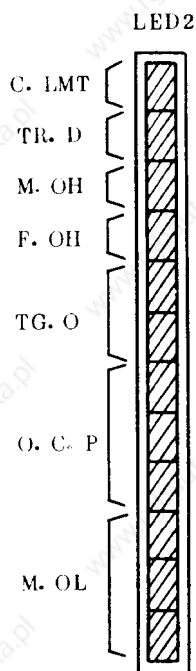

NAME	FUNCTION
C. LMT	Lights when current limiter circuit operates. Normally, does not light. (However; may light during sudden changes in use.)
TR. D	Lights under NC NOT READY condition and motor is overrun.
M. OH	Lights when motor overheats and the motor case exceeds a specified temperature (95°C). When the temperature drops below a specified temperature (70°C), the motor can be returned to READY condition by NC reset.
F. OH	Light when cooling fin temperature exceeds set temperature (80°C). When the temperature drops below a specified temperature (55°C), the motor can be returned to READY condition by the NC reset.
TG. O	Lights when the motor turns at a higher speed than the set rpm .
O. c. P.	Lights when higher than the designated electrical current flows into the transistor amplifier. When this indicator lights, it cannot be released without first turning power OFF and pushing the amplifier reset switch.
M. OL	Lights when motor is in condition of continuous overload. When this indicator lights, the alarm can be released either by decreasing the NC power, or after releasing the motor from the overloaded condition, by pushing the amplifier reset switch.

- 3) Electrical current value indicators and speed indicators (LED 2. These indicators, during driving indicate electrical current value and speed, and during alarm conditions they indicate the particular alarm condition .)

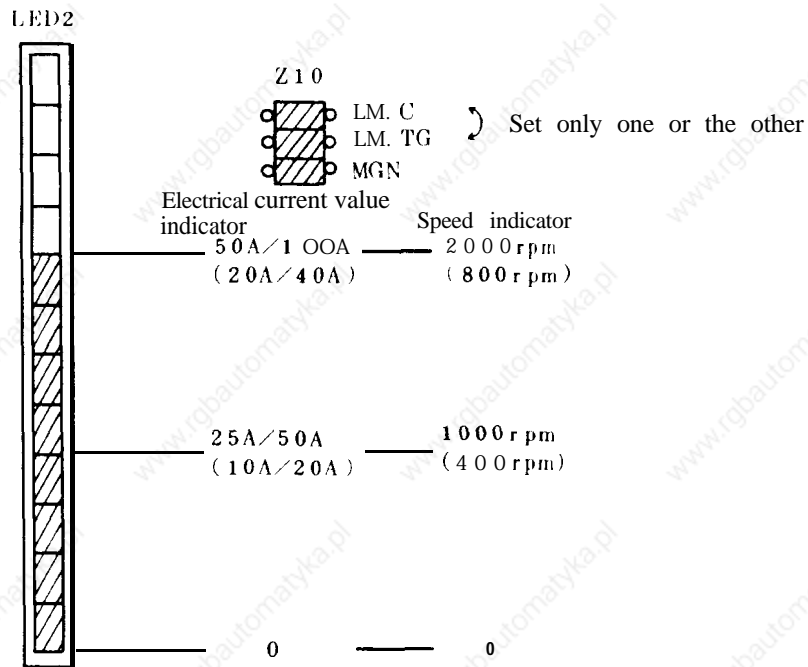

By indicating the LM.C of setting plug Z 10, the shaded (slanting lines) portion of the above diagram becomes a level meter for the electrical current value indicator.

- . With TR41/TR61, if the shaded portion is entirely lit, it corresponds to approximately 100A.
- . With TR3 1, if the shaded portion is entirely lit, it corresponds to approximately 50A.

By indicating both the LM.C and the MGN of setting plug Z10.

- . With TR41/TR61, if the shaded portion is entirely lit, it corresponds to approximately 40A.
- . With TR31, if the shaded portion is entirely lit, it corresponds to approximately 20A.

By indicating the LM.TG of setting plug Z10, the shaded (slanting lines) portion of the above diagram becomes a level meter for the speed indicator.



- . By indicating LM.TG, if the shaded portion is entirely lit, it corresponds to approximately 2000 rpm .
- By indicating LM.TG and MGN, if the shaded portion is entirely lit, it corresponds to approximately 800 rpm

② Transistor amplifier check pins and contents

As there are 3 types of check pins with different earth potential, handling must be executed with sufficient care.

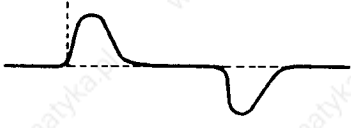
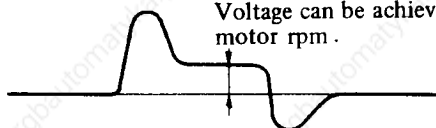
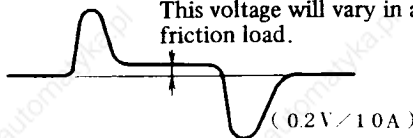
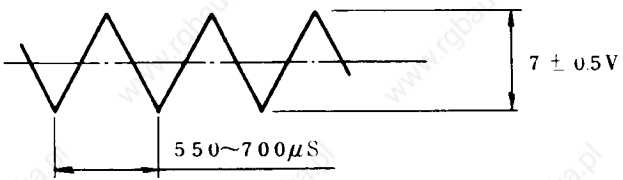
Group 1 (Simultaneous checking with other groups is not possible.)

Check pin	Signal name	Signal contents								
TCP1	TG signal	Speed feedback signal input (Positive voltage with counterclockwise running of the motor as seen from the load side)								
		<table border="1"> <tr> <td>Detector name</td> <td>RST-□X</td> <td>GB□□DU</td> <td>2GB-□AMZ</td> <td>TG with built-in Sanyo Superdrive Motor</td> </tr> <tr> <td>Output voltage</td> <td>2V 1000rpm</td> <td>7V 1000rpm</td> <td>3V 1000rpm</td> <td>30 ± 5% 1000 rpm</td> </tr> </table>	Detector name	RST-□X	GB□□DU	2GB-□AMZ	TG with built-in Sanyo Superdrive Motor	Output voltage	2V 1000rpm	7V 1000rpm
Detector name	RST-□X	GB□□DU	2GB-□AMZ	TG with built-in Sanyo Superdrive Motor						
Output voltage	2V 1000rpm	7V 1000rpm	3V 1000rpm	30 ± 5% 1000 rpm						
TCP2	ER signal	Input signal from the NC side (velocity command input) Note: Earthed with use of detector type RS-□X.								
TCP3	Velocity loop error signal	Output of the error signal of TG signal and ER signal. Velocity loop error signal 								
TCP4 TCP39	Current command signal	Approximately the same wave configuration as TCP3 can be obtained.								
TCP5	Comparator input signal	At times of acceleration or deceleration, the following kind of wave configuration will be observed.  <p>Voltage can be achieved in proportion to motor rpm.</p>								
TCP6 TCP37	Current feedback signal	At times of acceleration or deceleration, the following kind of wave configuration will be observed.  <p>This voltage will vary in accordance with friction load. (0.2V/1.0A)</p>								
TCP7	Step input signal	A speed loop step input signal will be observed. When VR1 is rotated, it will vary from +12V to -12V.								
TCP8	Triangular wave signal	Output of the waveform of the triangular wave oscillator 								

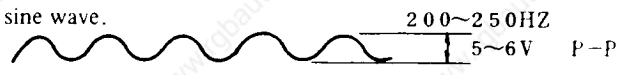
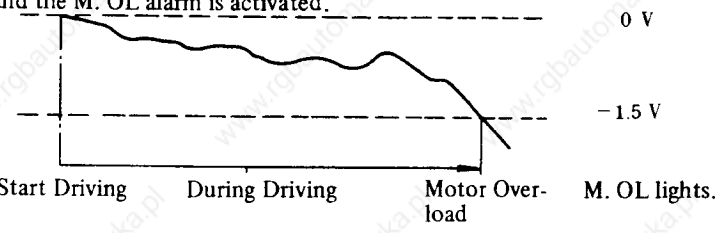
Check pin	Signal name	Signal contents
TCP15	Current absolute value signal	<p>The absolute value wave configuration of the motor armature current will be observed.</p> <p>TCP6 Current feedback TCP37 Signal  (0.2V/10A)</p> <p>TCP15 Current absolute value  <ul style="list-style-type: none"> TRA 31 (0.8V/10A) " 41 (1.6V/10A) " 61 (1.6V/10A) </p>
TCP17 TCP21	Dither reference signal	<p>Output of a sine wave.</p>  <p>200~250HZ 5~6V P-P</p>
TCP18 TCP19 TCP22 TCP23	Triangular wave signal	Triangular wave oscillator wave configuration is generated. (same as TCP8).
TCP20 TCP24	Power unit control circuit	Normally 24 V, when an alarm is signaled in any axis, it travels from that axis through ZP3, and all axes are opened as far as the axis connected with the DUC-1 cable.
TCP25	Electronic thermal current speed	Voltage after passing through time constant circuit.
TCP26	Motor load signal	<p>Motor load condition can be observed. At the time of driving it is 0 V, but during driving it becomes from 0~-1.5 V; if it drops below -1.5 V, it is seen as motor overload, and the M. OL alarm is activated.</p>  <p>0 V -1.5 V</p> <p>Start Driving During Driving Motor Over-load M. OL lights.</p>
TCP27 TCP28 TCP29 TCP38 TCP40	Earth signal	<p>This is the earth terminal for check terminals TCP1 to TCP36.</p> <div style="border: 1px dashed black; padding: 5px; width: fit-content; margin: 10px auto;"> <p>Do not observe other check pins with this earth.</p> </div>
TCP30	Transistor abnormality signal (TR.D)	If a tachometer generator signal is issued before the READY signal changes to H signal, it is seen as a transistor abnormality, and becomes an L signal. In this case, the TR. D alarm lights.
TCP31	Motor over-heating signal (M. OH)	When the motor overheats and the thermostat activates, it becomes an L signal. In this case, the M. OH alarm lights.
TCP32	Fan over-heating signal (F. OH)	When the cooling fan overheats and the thermostat activates, it becomes an L signal. In this case, the F. OH alarm lights.

Check pin	Signal name	Signal contents
TCP33	Excessive tachometer generator signal TG. OV	When the tachometer generator feedback signal exceeds the maximum number of rpms, it becomes an L signal. In this case, the TG. OV alarm lights.
TCP34	Motor overload detection signal	When the motor is overloaded, it becomes an L signal. In this case, the M. OL lights.
TCP35	Excessive current signal	When excessive DC current flows between the PN, this becomes an L signal. In this case, the O.C.P alarm lights.
TCP36	READY signal	When conditions are NC READY and the servo is ON, 24 V will come from the 0 V. In this case, the RDY lamp lights.

Group 2 (Simultaneous checking with other groups is not possible.)

Check pin	Signal name	Signal contents
TCPA	Armature current signal	The waveform of the motor armature current is obtained. The output level is 0.05 V per 10 A.
TCPB	Earth signal	This is the earth for the check terminal TCPA. <div style="border: 1px solid black; padding: 2px; width: fit-content; margin: 5px auto;">Do not observe other check pins with this earth.</div>

Group 3 (Simultaneous checking with other groups is not possible.)

Check pin	Signal name	Signal contents
TCPC	OCP input signal	Input signal of the OCP (overcurrent protection) circuit. The output level is 0.05 V per 10 A.
TCPD	Earth signal	This is the earth for check terminal TCPC. <div style="border: 1px solid black; padding: 2px; width: fit-content; margin: 5px auto;">Do not observe other check pins with this earth.</div>

(3) Power Unit Inspection

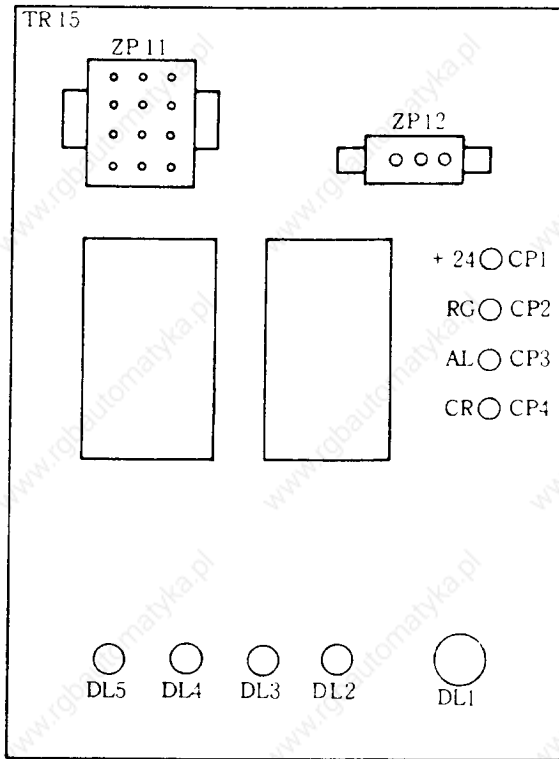

Fig. 5-2 Outline drawing for the control card (TR-15)

① Power unit operation display and alarm display lamps (control card TR-15)

	Name	Lamp	Display contents
Operation display	Pilot neon lamp	PL11	This lamp lights up with a DC voltage of the rectifier unit of about 80 V and goes out with a voltage of 40 to 50 V. <div style="border: 1px solid black; padding: 5px; margin-top: 5px;">While the lamp is lit, the capacitors are charged even when the power supply is switched off, so they must not be touched.</div>
		DL1 (green)	This lamp lights up when +24 V is supplied by cable DUC-1 (connector ZP) from the transistor amplifier.
Alarm display	NFB	DL2 (red)	This lamp lights up when the circuit breaker of the rectifier unit has been tripped or set to OFF. This becomes alarm for the axis to which the cable (DUC-1) is connected.
	DB	DL3 (red)	This lamp lights up when the temperature of the rectifier diode reaches the specified temperature. This becomes alarm for the axis to which the cable (DUC-1) is connected.
	TO. H	DL4 (red)	This lamp lights up when the transistor temperature reaches the specified temperature. This becomes alarm for the axis to which the cable (DUC-1) is connected.
	F TRIP	DL5 (red)	This lamp lights up when the alarm fuse for AC 100 V is blown. This becomes alarm for the axis to which the cable (DUC-1) is connected.

② Power unit check pins and contents

Check pin	Name	Signal contents
CP1	+24 V	When +24 V is supplied to the amplifier from the NC, DC +24 V is put out at the same time. DL1 (green) lights up at this time.
CP2	RG	Earth for CP1 to CP4
CP3	AL	This signal becomes L (normally open) at the time of alarm generation in the power unit. At this time, one of the lamps of DL2 to DL5 lights up.
CP4	CR	This is the signal for observation of the soft start circuit time constant. Magnetic contactor sequence operation is executed by means of this signal.