

SIEMENS

SIMATIC

S7-300 CPU 31xT

Manual

Preface

Product Overview

1

Operator controls and indicators

2

Setting up an S7-300 with a Technology CPU

3

Communication

4

Memory concept

5

Cycle and response times

6

Technical data

7

Appendix

A

Legal information

Warning notice system

This manual contains notices you have to observe in order to ensure your personal safety, as well as to prevent damage to property. The notices referring to your personal safety are highlighted in the manual by a safety alert symbol, notices referring only to property damage have no safety alert symbol. These notices shown below are graded according to the degree of danger.

⚠ DANGER
indicates that death or severe personal injury will result if proper precautions are not taken.
⚠ WARNING
indicates that death or severe personal injury may result if proper precautions are not taken.
⚠ CAUTION
with a safety alert symbol, indicates that minor personal injury can result if proper precautions are not taken.
CAUTION
without a safety alert symbol, indicates that property damage can result if proper precautions are not taken.
NOTICE
indicates that an unintended result or situation can occur if the corresponding information is not taken into account.

If more than one degree of danger is present, the warning notice representing the highest degree of danger will be used. A notice warning of injury to persons with a safety alert symbol may also include a warning relating to property damage.

Qualified Personnel

The product/system described in this documentation may be operated only by **personnel qualified** for the specific task in accordance with the relevant documentation for the specific task, in particular its warning notices and safety instructions. Qualified personnel are those who, based on their training and experience, are capable of identifying risks and avoiding potential hazards when working with these products/systems.

Proper use of Siemens products

Note the following:

⚠ WARNING
Siemens products may only be used for the applications described in the catalog and in the relevant technical documentation. If products and components from other manufacturers are used, these must be recommended or approved by Siemens. Proper transport, storage, installation, assembly, commissioning, operation and maintenance are required to ensure that the products operate safely and without any problems. The permissible ambient conditions must be adhered to. The information in the relevant documentation must be observed.

Trademarks

All names identified by ® are registered trademarks of the Siemens AG. The remaining trademarks in this publication may be trademarks whose use by third parties for their own purposes could violate the rights of the owner.

Disclaimer of Liability

We have reviewed the contents of this publication to ensure consistency with the hardware and software described. Since variance cannot be precluded entirely, we cannot guarantee full consistency. However, the information in this publication is reviewed regularly and any necessary corrections are included in subsequent editions.

Preface

Purpose of this manual

This manual contains essential information about the following:

- Installation
- Communication
- Memory concept
- Cycle and response times
- Technical specifications of the CPUs
- Switching to one of the CPUs discussed here

Scope of this manual

This manual describes the properties of the Technology CPU. It describes the differences of the Technology CPU compared to the following manuals:

- S7-300, CPU 31xC and 31x operating instructions: Configuration
- S7-300, CPU 31xC and 31x device manual: Technical specifications

These manuals are available on the DVD of the S7 Technology add-on package and on the Internet (<http://support.automation.siemens.com/WW/view/en/>).

Scope of the manual

CPU	Order number	As of firmware version
CPU 315T-2 DP	6ES7315-6TH13-0AB0	V2.7/4.1.5
CPU 317T-2 DP	6ES7317-6TK13-0AB0	V2.7/4.1.5

Note

The descriptions apply to all Technology CPU types, insofar as these are not explicitly specified.

The special features of the F-CPU's with integrated technology can be found as product information on the DVD of the "S7 Technology" add-on package and on the Internet (<http://support.automation.siemens.com/WW/view/en/11669702/133300>)

Note

We reserve the right to include a product information on the Internet (<http://support.automation.siemens.com>) containing the latest information on new modules or modules of a more recent version.

Changes in comparison to the previous version

- Expansion of the product series to include the fail-safe CPU 317TF-2 DP with integrated technology.
- The block library, S7 Technology V4.2, provides new functions:
 - Path interpolation
 - Pressure-controlled axes

Position in the documentation landscape

This manual is part of the SIMATIC S7 Technology add-on package. An overview of all manuals listed is available on the DVD of the S7 Technology add-on package under \Manuals\<languages>_manuals.pdf.

In addition to the S7 Technology documentation package, you require information from the "System software for S7-300/400 system and standard functions" reference manual. You can find the description on the Internet under contribution ID 15391120 (<http://support.automation.siemens.com/WW/view/en/15391120>) and in the STEP 7 online help.

Required basic knowledge

Knowledge required to understand this manual:

- General knowledge of automation engineering
- Knowledge of motion control
- Knowledge of STEP 7 basic software.

Required configuration tools

To configure the Technology CPU, you require STEP, Version V5.4 SP5 or higher and the S7 Technology add-on package, V4.2 or higher.

Standards and approvals

Chapter "General technical specifications" in the "S7-300 CPU 31xC und 31x: Technical specifications" provides information about standards and approvals.

Recycling and disposal

The devices described in this manual can be recycled due to their ecologically compatible components. For environment-friendly recycling and disposal of your old equipment, contact a certified disposal facility for electronic scrap.

Service & Support on the Internet

In addition to our documentation, we offer a comprehensive knowledge base online on the Internet (<http://support.automation.siemens.com>).

There you will find:

- Our newsletter containing up-to-date information on your products
- Up-to-date documents using the Search function in Service & Support
- A forum for global information exchange by users and specialists
- Your local representative for automation and drives in our contact database
- Information about on-site services, repairs, spare parts, and lots more
- Applications and tools for the optimized use of the SIMATIC S7.

Table of contents

	Preface	3
1	Product Overview	9
2	Operator controls and indicators	11
3	Setting up an S7-300 with a Technology CPU	15
	3.1 Overview	15
	3.2 S7-300 components	16
	3.3 Configuring	17
	3.3.1 Single-tier configuration	17
	3.3.2 Subnets	17
	3.4 Addressing	18
	3.5 Commissioning	19
	3.6 Operating system	19
	3.7 Status and error displays	20
4	Communication	23
	4.1 Interfaces	23
	4.1.1 Overview	23
	4.1.2 MPI/DP interface (X1)	23
	4.1.3 PROFIBUS DP(DRIVE) interface (X3)	25
	4.2 Communication services	27
	4.2.1 Overview	27
	4.2.2 S7 communication	28
	4.2.3 Routing	28
	4.2.4 Data consistency	31
	4.3 S7 connection as communication path	32
5	Memory concept	33
	5.1 Memory areas and retentive address areas	33
	5.1.1 Technology CPU memory areas	33
	5.1.2 Retentive address areas of the load memory, system memory and technology system data	34
	5.1.3 Retentive behavior	35
	5.1.4 Address areas of system memory	37
	5.2 Memory functions, reset and warm restart	39
	5.3 Technology data blocks	41
	5.4 Memory of the integrated technology of the CPU	42
6	Cycle and response times	45

7	Technical data	47
7.1	General technical data	47
7.1.1	Rated voltages of S7-300.....	47
7.1.2	Technical specifications of the Micro Memory Card	47
7.1.3	Standards and certifications.....	48
7.1.4	Electromagnetic compatibility	49
7.1.5	Shipping and storage conditions for modules and backup batteries	51
7.1.6	Mechanical and climatic environmental conditions for S7-300 operation.....	51
7.1.7	Specification of dielectric tests, protection class, degree of protection, and rated voltage of S7-300.....	54
7.1.8	Dimension drawing.....	55
7.2	Technical specifications of the CPU 315T-2 DP and 317T-2 DP	56
7.3	Technical specifications of the integrated technology of CPUs 31xT	69
7.4	Arrangement of integrated inputs/outputs for integrated technology.....	70
A	Appendix.....	71
A.1	Information for the Changeover to the Technology CPU.....	71
A.1.1	Scope	71
A.1.2	Changed behavior of certain SFCs.....	72
A.1.3	Interrupt events from distributed I/Os while the CPU status is in STOP	73
A.1.4	Runtimes that change while the program is running.....	74
A.1.5	Converting the diagnostic addresses of DP slaves	74
A.1.6	Reusing existing hardware configurations	75
A.1.7	Replacement of a Technology CPU.....	75
A.1.8	Using consistent data areas in the process image of a DP master	76
A.1.9	Load memory design for the Technology CPU	76
A.1.10	PG/OP functions	77
A.1.11	Routing for the CPU 31xC/31x as an intelligent slave	77
A.1.12	Altered retentive response with a Technology CPU	77
A.1.13	FMs/CPs with their own MPI address in a Technology CPU central configuration	78
	Glossary	79
	Index.....	93

Product Overview

Introduction

The current trend in the field of automation is toward PLC-integrated solutions. This also applies to technology and motion control applications.

Integrated technology of Technology CPU

With the Technology CPU, technology and motion control functions are integrated in one SIMATIC CPU.

The Technology CPU incorporates:

- SIMATIC CPU 31x-2 DP
- PLCopen-compliant motion control functions
- Technological configurations (technology objects, axis configurations, tools)

The Technology CPU is completely integrated in the SIMATIC family and thus in the TIA environment.

Field of application

The Technology CPU is especially suited to solving the following control tasks:

- Control tasks and technology requirements primarily relating to motion control in the SIMATIC S7-300
- Motion tasks for up to eight coupled axes or single axes
- Technological tasks, for example, gearing and camming, position-controlled positioning (operating modes: Absolute, relative, additive and superimposed), travel to fixed stop, probe-based print mark correction, position- or time-dependent cam control).

The Technology CPU is designed for use with flow machines, processing/assembly lines, flying shears, labeling equipment, drum feeds, or diverse axis kinematics (with path interpolation).

Typical configurations

The following figure shows typical configuration examples with the Technology CPU.

- The DP(DRIVE) interface is characteristic for the connection of the drive systems for the Technology CPU

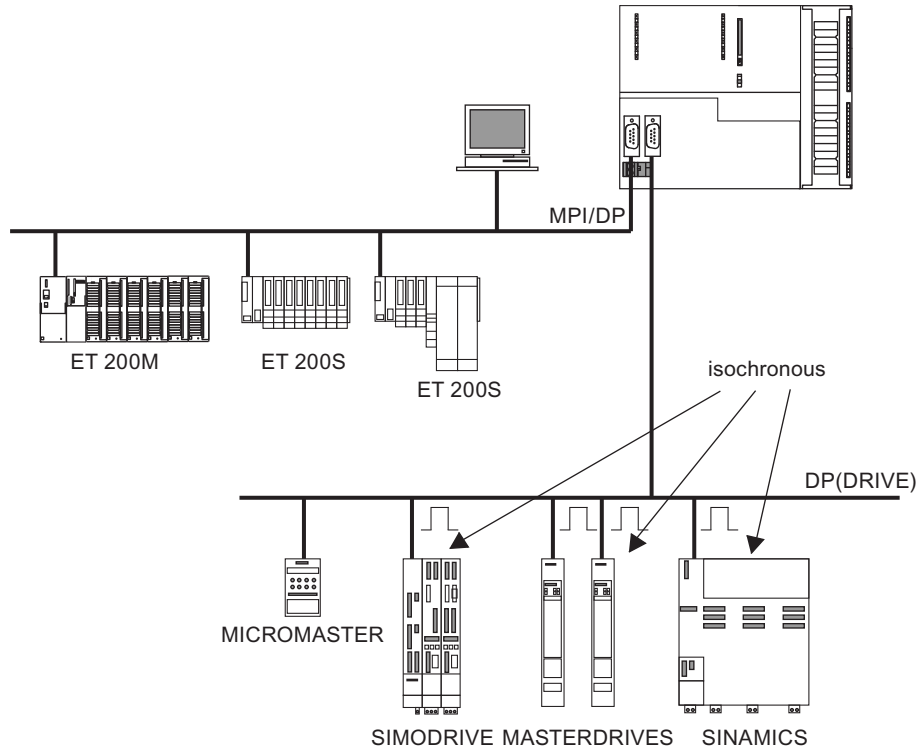

Figure 1-1 Typical configuration with the Technology CPU

Configuring and programming

For the configuration and programming of the Technology CPU, you require the *S7 Technology* add-on package, which is integrated after the installation in *STEP 7*.

STEP 7 HW Config is the tool used to configure all hardware components of the system (e.g. to create subnets on the two interfaces MPI / DP and DP(DRIVE)) including the drive equipment.

You will need optional package *S7-Technology* to parameterize the so-called "technology objects", e.g. axes, cams, output cams and probes.

The technology object data are stored in data blocks for use by the *STEP 7* user program.

S7 Technology also includes a library containing PLCopen-compliant standard function blocks, which are used to program the actual motion control tasks. You call these standard FBs in your *STEP 7* user program.

STEP 7 languages LAD, FBD and STL and all the required engineering tools, e.g. S7-SCL or S7-GRAPH are provided to enable you to create the *STEP 7* user program (incl. motion control tasks).

Operator controls and indicators

Operator controls and indicators of the CPU

The following figure shows the operator controls and displays on the Technology CPU.

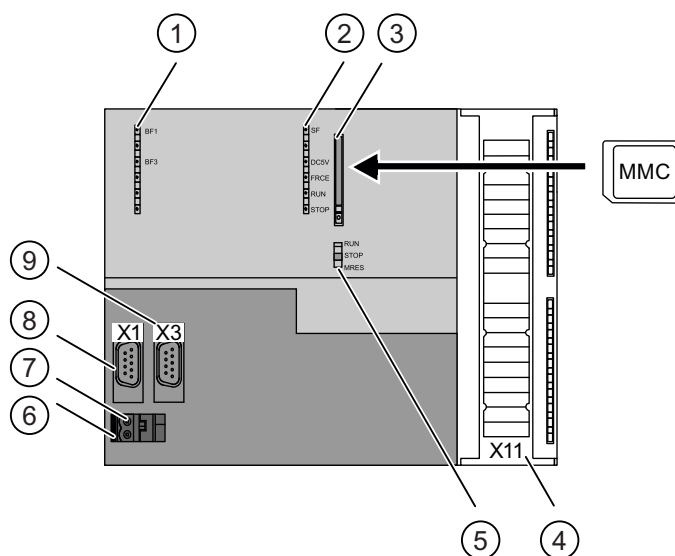

Figure 2-1 Operator controls and indicators of the Technology CPU

The number in the diagram	points to the following element on the Technology CPU
1	Bus error indicators
2	Status and error displays
3	Slot for the SIMATIC Micro Memory Card incl. the ejector
4	Connection of the integrated I/Os
5	Mode selector switch
6	Power supply connection
7	Grounding slide
8	Interface X1 MPI / DP
9	Interface X3 DP(DRIVE)

Integrated inputs and outputs for integrated technology

The technology CPU features 4 integrated digital inputs and 8 integrated digital outputs for technological functions, which you can configure using *S7T Config* (included in the *S7 Technology* add-on package). You use the integrated inputs and outputs for applications in which rapid technological processing is of prime importance.

The digital outputs are provided for high-speed camming functions. They can be programmed with technology functions in the STEP 7 user program. Digital inputs can be used with technology functions such as reference point acquisition (reference cam) as well as with technology functions in the STEP 7 user program.

If you wish to evaluate other inputs and outputs in the STEP 7 user program, they can be interconnected in the usual way by means of supplementary input/output modules.

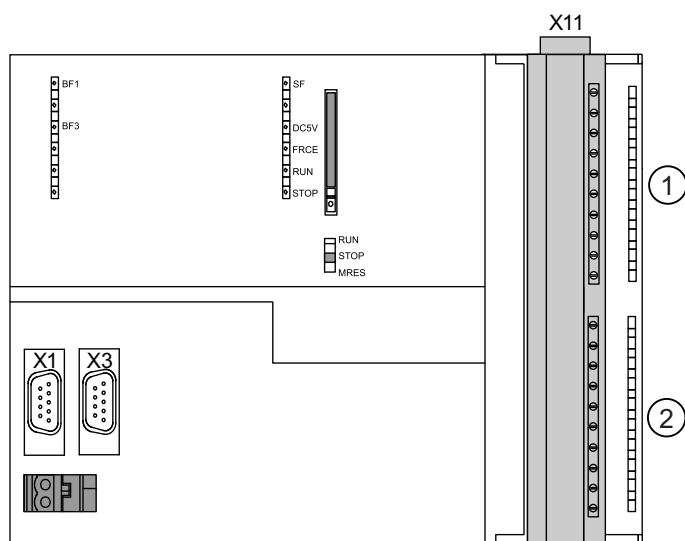

Figure 2-2 Integrated technology inputs and outputs on the Technology CPU with open front door

The number in the diagram	points to the following integrated I/Os
1	4 digital inputs
2	8 digital outputs

Slot for the SIMATIC Micro Memory Card

Memory module is a SIMATIC Micro Memory Card. This can be used as load memory and as a transportable data medium.

Note

The Technology CPU does not have an integrated load memory and therefore requires a SIMATIC Micro Memory Card for operation.

Mode selector switch

You can use the mode selector switch to set the current mode of the CPU.

Table 2- 1 Mode selector switch settings

Position	Meaning	Description
RUN	RUN mode	The CPU executes the user program.
STOP	STOP mode	The CPU does not execute a user program.
MRES	CPU memory reset	Mode selector switch position with pushbutton function for CPU memory reset. A CPU memory reset by means of mode selector switch requires a specific sequence of operation.

Power supply connection

Each CPU is equipped with a double-pole power supply socket. The connector with screw terminals is inserted into this socket when the CPU is delivered.

Status and error displays

The CPU is equipped with the following LEDs:

Table 2- 2 Status and error displays of the CPU

LED designation	Color	Meaning
SF	Red	Hardware or software error
BF1	Red	Bus error at interface (X1)
BF3	Red	Bus error at interface (X3)
5 VDC	Green	5V power supply for the CPU and the S7-300 bus
FRCE	Yellow	LED lights up: Active force job LED flashes at 2 Hz: Node flash test function (only CPUs with firmware V2.2.0 or higher)
RUN	Green	CPU in RUN. The LED flashes during STARTUP at a rate of 2 Hz, and in HOLD state at 0.5 Hz.
STOP	Yellow	CPU in STOP, or HOLD, or STARTUP. The LED flashes <ul style="list-style-type: none"> At 0.5 Hz on general reset request At 2 Hz during general reset At 2 Hz during shutdown (LED RUN lit).

Shutdown

What happens during shutdown?

1. The control of the Technology CPU is already in STOP mode during "shutdown". The outputs of the centralized and distributed I/Os on the MPI / DP are deactivated. The "STOP" LED flashes at 2 Hz. The "RUN" LED lights up.
2. The integrated inputs/outputs for integrated technology and the distributed I/Os on DP(DRIVE) are still active during shutdown.
3. The integrated technology of the Technology CPU shuts down the drives on PROFIBUS DP(DRIVE) in a controlled manner.
4. The integrated technology then also switches to STOP. The integrated inputs/outputs for integrated technology and the distributed I/Os on DP(DRIVE) are deactivated. The "STOP" LED lights up.

The maximum duration of shutdown depends on your configuration in S7T Config.



CAUTION

The distributed I/Os on DP(DRIVE) cannot be controlled from the user program during "shutdown". The outputs which can be controlled with technology function "MC_WritePeripherie" retain their last current setting.

Reference

Additional information

- about CPU operating modes can be found in the *STEP 7 Online Help*.
- for operating the mode selector switch for resetting, refer to the S7-300, CPU 31xC, and CPU 31x Operating Instructions: Configuration, section *Commissioning*
- for evaluating the LEDs in the event of an error / diagnostics, refer to the S7-300, CPU 31xC, and CPU 31x Operating Instructions: Configuration, section *Debugging functions, diagnostics and troubleshooting*.
- to use the SIMATIC MMCs and the memory concept refer to the section *Memory Concept*.

Setting up an S7-300 with a Technology CPU

3.1 Overview

This section

provides information that deviates from the operating instructions, S7-300, CPU 31xC and CPU 31x: Installation, or that that you will also require.

Note

When installing, commissioning and operating the S7-300 systems, observe the installation guidelines and safety instructions in the "Configuring", "Installing" and "Wiring" chapters of the "S7-300, CPU 31xC and CPU 31x: Installation" manual.

3.2 S7-300 components

Sample configuration of an S7-300:

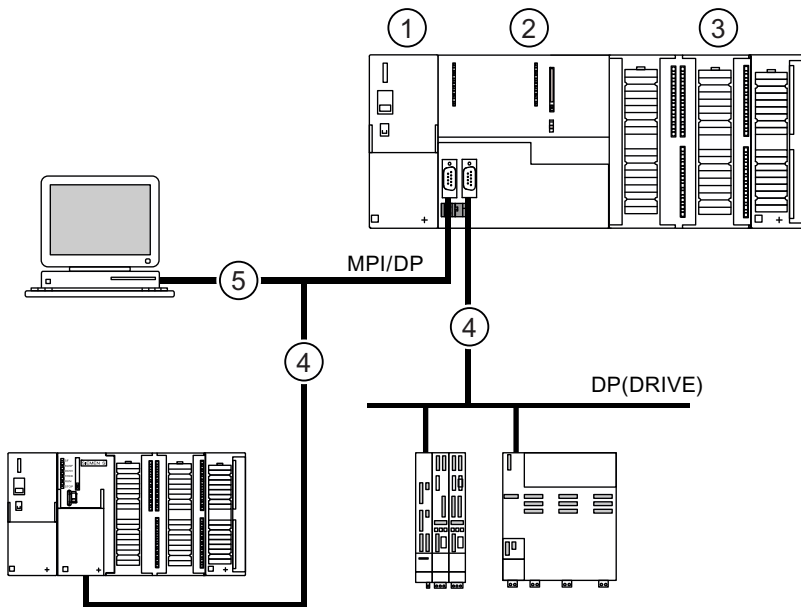

Table 3- 1 S7-300 components

The number in the diagram	points for the following component of an S7-300 system
(1)	Power supply (PS) module
(2)	Central processing unit (CPU)
(3)	Signal module (SM)
(4)	PROFIBUS cable
(5)	Cable for connecting a programming device (PG) or for networking with other SIMATIC controls

You use a programming device (PG) to program the S7-300. You connect the programming device to the CPU by means of a programming device cable.

Using the PROFIBUS bus cable, you connect the CPU

- To other SIMATIC controls via the MPI / DP interface
- To the drives via the DP(DRIVE) interface.

No programming device / OP on DP(DRIVE)

We recommend that you do not connect a programming device / OP to DP(DRIVE).

Reason: If you connect a programming device / OP to DP(DRIVE), the properties of DP(DRIVE) change (for example isochronism), and the synchronism between drives may be lost as a result. Always therefore connect a programming device / OP to the MPI / DP interface and access the DP(DRIVE) via the "Routing" function.

3.3 Configuring

3.3.1 Single-tier configuration

Single-tier configuration

The Technology CPU supports only single-tier configurations.

3.3.2 Subnets

Overview: Subnets with the Technology CPU

The Technology CPU provides the following subnets:

- Multi Point Interface (MPI) or PROFIBUS DP
- DP(DRIVE): Optimized for drives

Transmission rate

Maximum transmission rates:

- MPI/PROFIBUS DP: 12 Mbaud
We recommend that you set 12 Mbaud for the Technology CPU
- DP(DRIVE): 12 Mbaud

Note

Before you transfer projects to the Technology CPU via the MPI/DP interface, you should increase the baud rate to at least 1.5 Mbaud or else the data transmission can take a very long time (up to 15 minutes at 187.5 kbaud).

3.4 Addressing

Number of nodes

Maximum number of nodes per subnet:

Table 3-2 Subnet nodes

Parameters	MPI	PROFIBUS DP	PROFIBUS DP (DRIVE)
Number	127	126	33
Addresses	0 to 126	0 to 125	1 to 125
Comments	Default: 32 addresses Reserved addresses: • Address 0 for PG • Address 1 for OP	of which: 1 master (reserved) 1 PG connection (address 0 reserved) 124 slaves or other masters	of which: • 1 master (reserved) and 32 slaves or drives

3.4 Addressing

Slot-specific addressing of modules

The Technology CPU is assigned to two slot numbers: 2 and 3.

The input and output addresses for I/O modules begin at the same module start address.

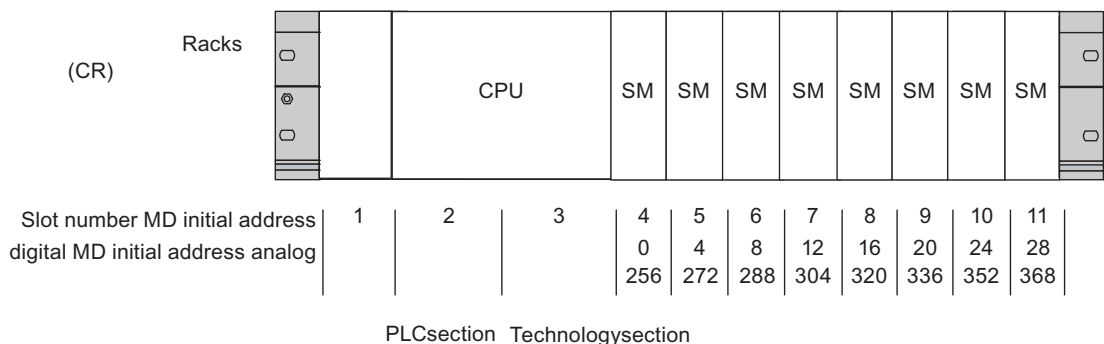

Figure 3-1 Slots of the S7-300 with Technology CPU and associated module start addresses

3.5 Commissioning

Requirements

If you wish to utilize the full scope of CPU functions, you will require

- STEP 7 and the *S7-Technology* optional package
- S7-300 is installed
- S7-300 is wired
- For a networked S7-300:
 - MPI/PROFIBUS addresses are set
 - Terminating resistors on the segments are enabled

3.6 Operating system

Technology CPU operating system

To meet the requirements of the integrated technology, technology functions have been added to the standard CPU operating system to obtain the technology operating system.

The technology operating system is included in the project and the configuration. In other words, if you load a project created with S7-Technology to the Technology CPU, the technology operating system is automatically transferred at the same time.

Updating the operating system

You can order the latest versions of the operating system from your Siemens representative or you can download it from the Internet.

3.7 Status and error displays

Status and error displays of the Technology CPU

Table 3- 3 Status and error displays of the Technology CPU

LED					Meaning
SF	5 VDC	FRCE	RUN	STOP	
Off	Off	Off	Off	Off	CPU power supply missing. Remedy: Check whether the power supply module is connected to mains and switched on. Check whether the CPU is connected to the power supply and switched on.
Off	On	X (see the description)	Off	On	The CPU is in STOP mode. Remedy: Start the CPU.
On	On	X	Off	On	The CPU is in STOP mode as a result of error. Remedy: refer to the tables below, evaluation of the SF LED
X	On	X	Off	Flashes (0.5 Hz)	The CPU requests memory reset.
X	On	X	Off	Flashes (2 Hz)	The CPU executes memory reset.
X	On	X	Flashes (2 Hz)	On	The CPU is in startup mode.
X	On	X	Flashes (0.5 Hz)	On	The CPU was halted by a programmed break point. For details, refer to the Programming Manual <i>Programming with STEP 7</i> .
On	On	X	X	X	Hardware or software error Remedy: refer to the tables below, evaluation of the SF LED
X	X	On	X	X	You enabled the Force function For details refer to the Programming Manual <i>Programming with STEP 7</i> .
X	X	X	On	Flashes (2 Hz)	STOP/shutdown What happens during shutdown? The control of the Technology CPU is already in STOP mode during "shutdown". The outputs of the centralized and distributed I/Os are deactivated. The integrated inputs/outputs for integrated technology and the ET 200M on the DP(DRIVE) are still active during shutdown. The integrated technology of the Technology CPU shuts down the drives on PROFIBUS DP(DRIVE) in a controlled manner. The integrated technology of the CPU then also goes into STOP. The integrated inputs/outputs for integrated technology and the ET 200M on the DP(DRIVE) are deactivated. The maximum duration of shutdown depends on your configuration in S7TConfig.
X	X	X	Flashes (0.5 Hz)	Flashes (2 Hz)	HOLD/shutdown
Flashes	Flashes	Flashes	Flashes	Flashes	Internal errors in Technology CPU. Contact your local SIEMENS partner.

Status and error displays for DP or DP(DRIVE)

Table 3- 4 LEDs BF1 and BF3

LED		Meaning
BF1	BF3	
On/ flashes	X	Error on the PROFIBUS DP interface of the Technology CPU. Remedy: See table LED BF1 illuminated
X	On/ flashes	Error on the DP(DRIVE) interface Remedy: See table <i>LED BF1 flashing</i>

Description of status X:

The LED can assume the On or Off state. This status, however, is irrelevant for the current CPU function. For example, the states Force On or Off do not influence the CPU STOP status

Table 3- 5 LED BF1 illuminated

Possible Errors	CPU reaction	Possible Remedies
<ul style="list-style-type: none"> Bus fault (hardware fault) DP interface error Different transmission rates in multiple DP master mode. If the DP slave / master interface is active: Short-circuit on the bus. With passive DP slave interface: transmission rate search, i.e. there are no other active nodes on the bus (a master, for example) 	Call of OB 86 (when CPU is in RUN mode). CPU switches to STOP if OB 86 is not loaded.	<ul style="list-style-type: none"> Check the bus cable for short-circuit or breaks. Evaluate the diagnostics. Reconfigure or correct the configuration.

Table 3- 6 LED BF1 flashes

Possible errors	CPU reaction	Possible remedies
The CPU is DP master / active slave: <ul style="list-style-type: none"> Failure of a connected station At least one of the configured slaves cannot be accessed. Incorrect configuration 	Call of OB 86 (when CPU is in RUN mode). CPU switches to STOP if OB 86 is not loaded.	Verify that the bus cable is connected to the CPU, or that the bus is not interrupted. Wait until the CPU has completed its startup. If the LED does not stop flashing, check the DP slaves or analyze the diagnostic data of the DP slaves.
The CPU is a DP slave The CPU parameters are incorrectly set. Possible causes: <ul style="list-style-type: none"> The response monitoring period has elapsed. PROFIBUS DP communication is down. Wrong PROFIBUS address. Incorrect configuration 	Call of OB 86 (if CPU is in RUN mode). CPU switches to STOP if OB 86 is not loaded.	<ul style="list-style-type: none"> Check the CPU. Verify that the bus connector is properly seated. Check whether the bus cable to the DP master has been disconnected. Check the configuration and parameter assignment.

3.7 Status and error displays

Table 3- 7 LED BF3 illuminated

Possible errors	CPU reaction	Possible remedies
<ul style="list-style-type: none"> • Bus fault (hardware fault) • DP interface error 	Error message in the technology DB configured by you.	Check for short-circuit or interruption in the bus cable.

Table 3- 8 LED BF3 flashes

Possible Errors	CPU reaction	Possible Remedies
<ul style="list-style-type: none"> • Failure of a connected station • At least one of the configured slaves cannot be accessed. • Incorrect configuration 	Error message in the technology DB configured by you.	<p>Verify that the bus cable is connected to the CPU, or that the bus is not interrupted.</p> <p>Wait until the CPU has completed its startup. If the LED does not stop flashing, check the DP slaves or analyze the diagnostic data of the DP slaves.</p>

Communication

4.1 Interfaces

4.1.1 Overview

The Technology CPU has two interfaces:

- MPI / DP interface (X1)
- PROFIBUS DP(DRIVE) interface (X3)

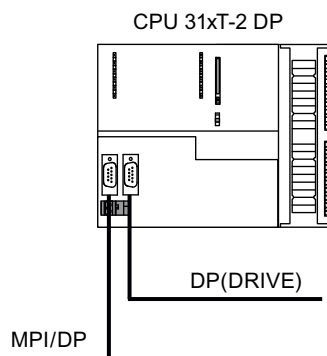

Figure 4-1 Technology CPU interfaces

4.1.2 MPI/DP interface (X1)

Availability

The Technology CPU features an MPI / DP interface (X1). A CPU with MPI / DP interface is supplied with default MPI parameter settings. Depending on your requirements, you may need to reconfigure the interface as a DP interface in STEP 7.

Operating modes

Possible interface operating modes:

- MPI
- DP master
- DP slave

MPI properties

The MPI (Multi-Point Interface) represents the CPU interface for PG/OP connections, or for communication on an MPI subnet.

The default transmission rate of all CPUs is 187.5 kbps. You can also set 19.2 kbps for communication with an S7-200. You can set baud rates of up to 12 Mbaud.

The CPU automatically broadcasts its bus configuration via the MPI interface (the transmission rate, for example). A PG, for example, can thus receive the correct parameters and automatically connect to a MPI subnet.

Note

You may only connect PGs to an MPI subnet which is in RUN. Other stations (for example, OP, TD, ...) should not be connected to the MPI subnet while the system is in RUN. Otherwise, transferred data might be corrupted as a result interference, or global data packages may be lost.

Note

Recommendation:

Before you transfer data to the CPU via the MPI interface, you should increase the baud rate to 1.5 Mbaud, otherwise the data transmission can take a very long time (up to 15 minutes at 187.5 kbaud)!

Devices capable of MPI communication

- PG/PC
- OP/TP
- S7-300 / S7-400 with MPI interface
- S7-200 (with 19.2 kbaud only)

Properties of PROFIBUS DP

The PROFIBUS DP interface is mainly used to connect distributed I/O. PROFIBUS DP allows you to create extensive subnets, for example.

The PROFIBUS DP interface can be set for operation in master or slave mode, and supports transmission rates up to 12 Mbaud.

The CPU broadcasts its bus parameters (transmission rate, for example) via the PROFIBUS DP interface when master mode is set. A PG, for example, can thus receive the correct parameters and automatically connect to a PROFIBUS subnet. In your configuration you can specify to disable bus parameter broadcasting.

Devices capable of PROFIBUS DP communication

- PG/PC
- OP/TD
- DP slaves
- DP master
- Actuators/sensors
- S7-300/S7-400 with PROFIBUS DP interface

4.1.3 PROFIBUS DP(DRIVE) interface (X3)

Properties

The PROFIBUS DP(DRIVE) interface is used to connect to drive systems. You can connect drive systems in accordance with the PROFIdrive.

The PROFIBUS DP(DRIVE) interface is configured as a master and supports transmission rates up to 12 Mbaud.

The PROFIBUS DP(DRIVE) interface support isochronous mode.

The CPU sends its bus parameter settings (e.g. baud rate) via the PROFIBUS DP(DRIVE) interface. In your configuration you can specify to disable bus parameter broadcasting.

Using the "Routing" function, you can access the drive parameters of the slaves in the DP(DRIVE) line for the purposes of commissioning and diagnostics. However, diagnostics cannot be performed via PROFIBUS DP(DRIVE) from the *STEP 7* user program.

Note

If you deselect "Startup with different target / actual configurations" in the Technology CPU properties in STEP 7, then the Technology CPU will boot even if the stations configured on DP-DRIVE are missing.

Note

The 2nd interface of the Technology CPU is allocated to PROFIBUS DP(DRIVE) and can no longer be used as second interface for PROFIBUS DP.

Connectable devices

You can connect drives to PROFIBUS DP(DRIVE), e.g.:

- MICROMASTER 420/430/440 and COMBIMASTER 411
- SIMODRIVE 611 universal
- SIMODRIVE POSMO CD/SI/CA
- MASTERDRIVES MC/VC
- ET 200M with IM 153-2 (isochronous!) and SM 322 for additional cam output
- ET 200S with IM 151-1 high feature
- SINAMICS S120 (optional with TM15 or TM17 high feature for high-speed cams)
- PROFIBUS module IM 174 (interface for analog drives and stepper motors)
- ADI4 (analog drive interface)
- Isochronous PROFIBUS encoder "SIMODRIVE sensor isochronous"

The components configured in HW Config are displayed in the "Hardware Catalog" window in HW Config. To show the screen, select profile "SIMATIC Technology CPU" in HW Config.

To ensure that the profile's selection list is complete, you must have installed the most recent version of S7-Technology.

Non-connectable devices

We would not recommend operating active PROFIBUS stations (PGs, PCs, OPs, TDs, etc.) on PROFIBUS DP(DRIVE). The DP cycle will be burdened by additional access times if you do operate these PROFIBUS stations on DP(DRIVE). In this case, isochronous processing of drive information cannot be guaranteed.

Always therefore connect a PG/OP to the MPI / DP interface and access the DP(DRIVE) via the "Routing" function.

No diagnostics on DP(DRIVE)

With the Technology CPU, note that you cannot evaluate any diagnostics data from DP(DRIVE) in your STEP 7 user program.

However, with your PC/PG on PROFIBUS DP, you can use the "Routing" function to access the drive parameters on the DP(DRIVE) line for commissioning and evaluating diagnostics (with the appropriate drive tools).

Additional information

For additional information on the communication interfaces and on time synchronization, refer to the "Communication" section of the manual, CPU 31xC and CPU 31x: Technical Specifications.

4.2 Communication services

4.2.1 Overview

Selecting the communication service

You need to decide on a communication service, based on functionality requirements. Your choice of communication service will influence

- the functionality available,
- whether an S7 connection is required or not, and
- the connection timing.

The user interface can vary considerably (SFC, SFB, ...), and is also determined by the hardware used (SIMATIC CPU, PC, ...).

Overview of communication services

The table below provides an overview of communication services offered by the CPU.

Table 4- 1 CPU communication services

Communication service	Functionality	Time at which the S7 connection is established ...	via MPI	via DP	to DP(DRIVE)
PG communication	Commissioning, test, diagnostics	from the PG, starting when the service is being used	X	X	-
OP communication	Operator control and process monitoring	from the OP at Power ON	X	X	-
S7 basic communication	Data communication	is programmed at the blocks (SFC parameters)	X	-	-
S7 communication	Data communication	as server only, communication link is set up by the communication partner	X	X	-
Global data communication*	Cyclic data communication (for example, flag bits)	does not require an S7 connection	X	-	-
Routing PG functions**	for example testing, diagnostics on other networks also	from the PG, starting when the service is being used	X	X	X
PROFIBUS DP	Data communication between master and slave	does not require an S7 connection	-	X	X

* The number of resources for global data communication can be found in the Technical Specifications.

** Functions can be routed only to DP(DRIVE), but not on DP(DRIVE)!

The following section describes the special features of the communication services of the CPU 31xT. For general information on the communication services and DPV1, refer to the S7-300 CPU 31xC and 31x manual: Technical Specifications and in the manual, Communication with SIMATIC.

4.2.2 S7 communication

Properties

A CPU can always operate in server or client mode in S7 communication: We distinguish between

- Communication with unilateral configuration (for PUT/GET only)
- Communication with bilateral configuration (for USEND, URCV, BSEND, BRCV, PUT, GET)

However, the functionality depends on the CPU. A CP is therefore required in certain situations.

Table 4- 2 Client and server in S7 communication, using connections with unilateral / bilateral configuration

CPU	Use in server mode for connections with unilateral configuration	Use in server mode for connections with bilateral configuration	Use as client
31x T-2 DP	Generally possible on MPI / DP interface without configuration of user interface	Only possible with CP and loadable FBs.	Only possible with CP and loadable FBs.

The user interface is implemented using the standard function blocks (FBs) listed under "Communication blocks" in the standard library of STEP 7.

Additional information

For additional information on communication, refer to the *Communication with SIMATIC* manual.

4.2.3 Routing

Definition

The routing function enables you to attach a PG/PC at any point in the network and establish a connection to all drives accessible via gateways.

Accessing drives in a DP(DRIVE) subnet from a PG/PC

Test, diagnostic and parameterizing functions can be routed via the MPI / DP interface (X1) to the DP(DRIVE) subnet with the Technology CPU.

The Technology CPU provides a certain number of connection resources for routing. These connections are available in addition to the S7 connection resources.

The number of routing connections can be found in the Technical Specifications.

Network gateway

Gateways between subnets are routed in a SIMATIC station that is equipped with interfaces to the respective subnets. The figure below shows the Technology CPU (DP master) acting as router for subnets 1 and 2.

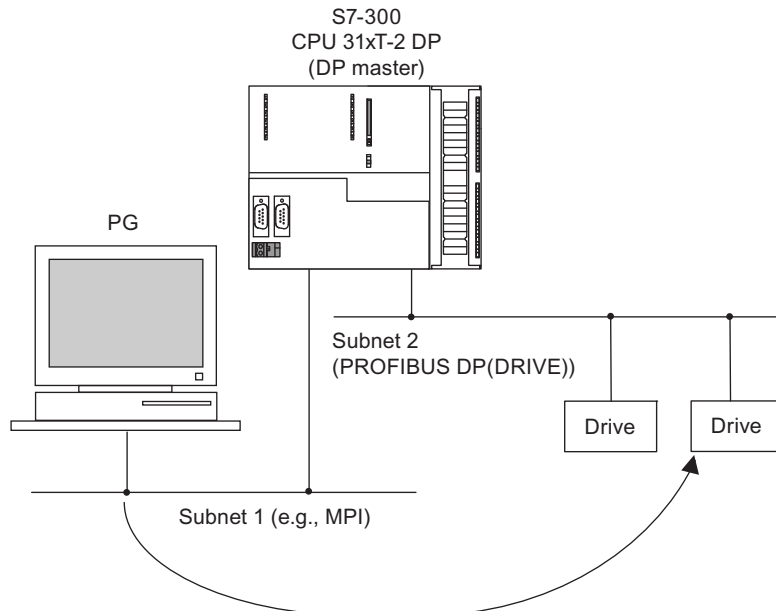

Figure 4-2 Routing - network gateway

Requirements for routing

- The station modules are "capable of routing" (CPUs or CPs).
- The network configuration does not exceed project limits.
- The modules have loaded the configuration data containing the latest "knowledge" of the entire network configuration of the project.

Reason: All modules participating in the network transition must receive the routing information defining the paths to other subnets.

- In your network configuration, the PG/PC you want to use to establish a connection via network node must be assigned to the network it is physically connected to.

Example of an application: TeleService

The figure below shows the example of an application for remote maintenance of an S7 station using a PG. The connection to other subnets is here established via modem connection.

The lower section of the figure shows how to configure this in *STEP 7*.

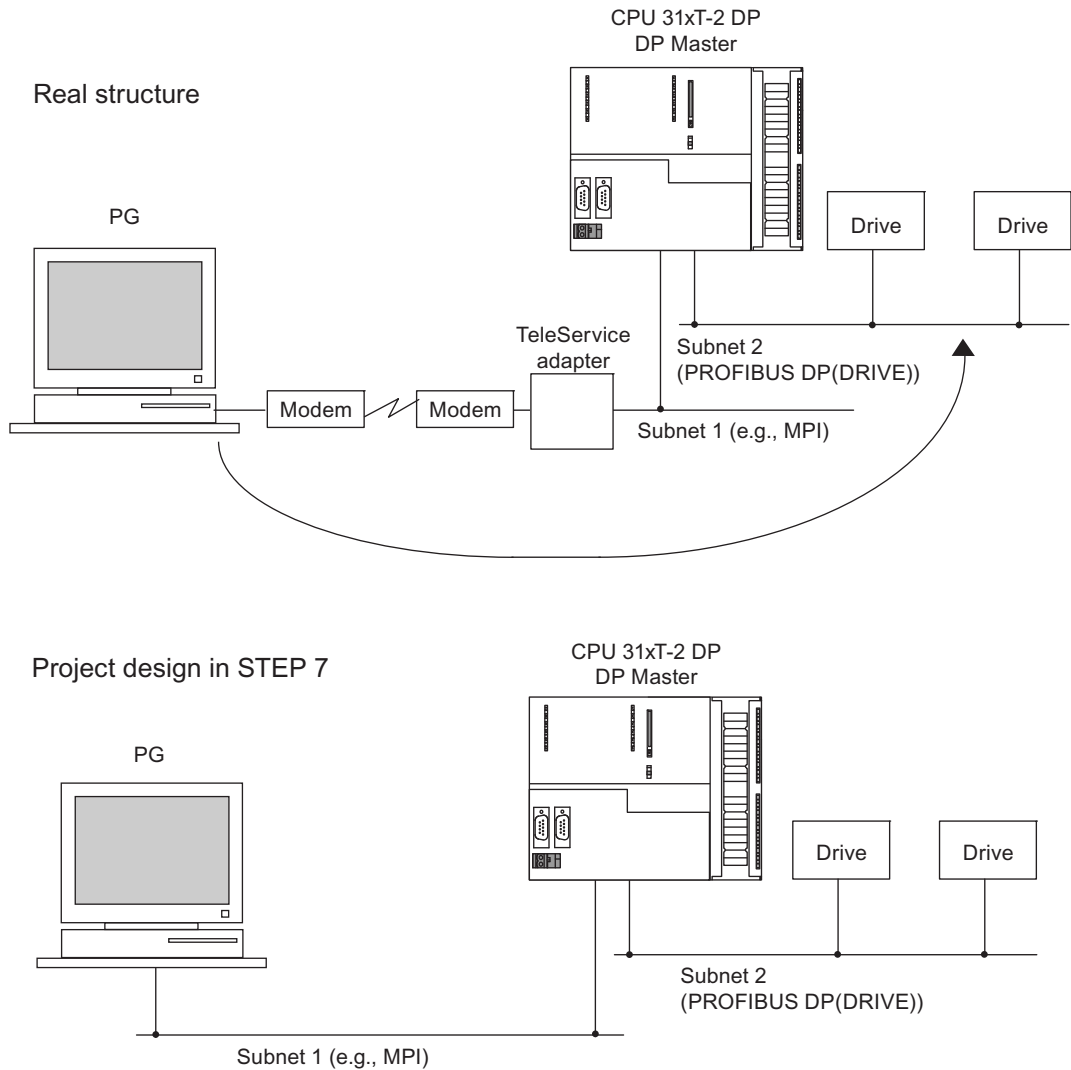

Figure 4-3 Routing - example of TeleService application

Additional information

Additional information:

- About setting the PG/PC interface for routing can be found in Getting Started *CPU 317T-2 DP: Controlling a SINAMICS S120* in chapter *Configuring the PG/PC Interface*.
- About routing can be found in the *Programming with STEP 7* manual, or directly to the *STEP 7* online help.
- About configuring with *STEP 7* can be found in the *Configuring Hardware and Connections in STEP 7* manual
- About fundamentals can be found in the *Communication with SIMATIC* manual.
- About the TeleService adapter can be found on the Internet (<http://support.automation.siemens.com/WW/view/en/14053309>).
- About SFCs can be found in the *Instruction list*, for more details refer to the *STEP 7 online help* or to the *System and Standard Functions* reference manual.
- About communication can be found in the *Communication with SIMATIC* manual.

4.2.4 Data consistency

Properties

A data area is consistent if it can be read or written to from the operating system as a consistent block. Data exchanged collectively between the stations should belong together and originate from a single processing cycle, that is, be consistent.

If the user program contains a programmed communication function, for example, access to shared data with XSEND/ XRCV, access to that data area can be coordinated by means of the "BUSY" parameter itself.

With PUT/GET functions

For S7 communication functions, such as PUT/GET or write / read via OP communication, which do not require a block in the user program on the CPU (operating in server mode), allowances must be made in the program for the extent of the data consistency.

The PUT/GET functions for S7 communication, or for reading/writing variables via OP communication, are executed at the CPU's scan cycle checkpoint.

In order to ensure a defined process interrupt reaction time, communication variables are copied consistently in blocks of maximum 160 bytes to/from the user memory at the scan cycle check point of the operating system. Data consistency is not guaranteed for larger data areas.

Note

Where defined data consistency is required, the length of communication variables in the CPU's user program may not exceed 160 bytes.

4.3 S7 connection as communication path

An S7 connection is established when S7 modules communicate with one another. This S7 connection is the communication path.

Note

Global data communication and the communication via PROFIBUS DP do not require S7 connections.

Every communication link requires S7 connection resources on the CPU for the entire duration of this connection.

This is why every S7 CPU provides a specific number of S7 connection resources. These are used by various communication services (PG/OP communication, S7 communication or S7 basic communication).

The number of resources for S7 and routing connections can be found in the Technical Specifications.

Availability of connection resources

The following table shows the available connection resources.

CPU	Total number Connection resources	reserved for			free S7 connections
		PG communication	OP communication	S7 basic communication	
315T-2 DP	16	1 to 15, default 1	1 to 15, default 1	0 to 12, default 0	All non-reserved S7 connections are displayed as free connections.
317T-2 DP	32	1 to 31, default 1	1 to 31, default 1	0 to 30, default 0	

Note

If you use CPU 315T-2 DP, you can configure a maximum of 14 connection resources for S7 communication in NetPro. The connections are then no longer available as free connections. The CPU 317T-2 DP supports the configuration of a maximum of 16 connection resources for S7 communication in NetPro.

Memory concept

5.1 Memory areas and retentive address areas

5.1.1 Technology CPU memory areas

The memory of the Technology CPU is divided into three areas:

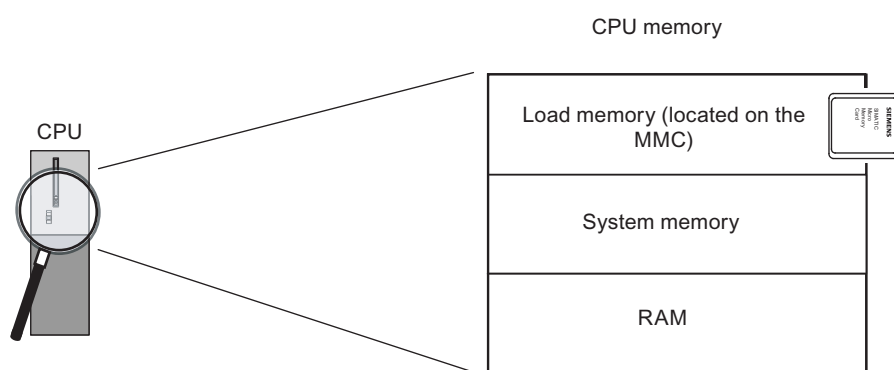

Figure 5-1 Technology CPU memory areas

Load memory

The load memory is located on the SIMATIC micro memory card (MMC). It is used to store code blocks, data blocks and system data (configuration, connections, module parameters, technology system data etc.).

For the Technology CPU, the size of the load memory corresponds to the size of the SIMATIC MMC minus approx. 3 MB. The 3 MB are required for the integrated technology and are therefore not available to the user.

Blocks that are identified as not relevant for the execution are stored exclusively in the load memory.

You can also store all the configuration data for your project on the SIMATIC Micro Memory Card.

CAUTION

Downloading user programs and hence operating the CPU is only possible if a SIMATIC MMC is inserted.

If you pull out the SIMATIC MMC while the CPU is in RUN mode, the CPU then goes into STOP mode and the drives are shut down in accordance with your programming in the *STEP 7* user program.

This is why you should only remove the SIMATIC Micro Memory Card when the CPU is in STOP.

System memory

The system memory is integrated in the CPU and cannot be expanded.

It contains

- the operand areas for flags, times and counters
- the process image of the inputs and outputs
- the local data

Work memory

The work memory is integrated in the CPU and cannot be extended. It is used to run the code and process user program data. Programs only run in the work memory and system memory. The work memory is always retentive.

5.1.2 Retentive address areas of the load memory, system memory and technology system data

Introduction

Your CPU is equipped with a maintenance-free retentive memory, i.e., its operation does not require a buffer battery. The retentivity is realized via the SIMATIC Micro Memory Card. Data is also retained in the retentive memory throughout POWER OFF and restart (warm restart).

Retentive data in load memory

Your program in the load memory is always retentive: it is already stored on the SIMATIC Micro Memory Card, where it is protected against power failure or memory restart.

Retentive data in system memory

In your configuration (Properties of CPU, Retentive address areas tab), specify which parts of the tags, timers and counters should be retentive and which of them are to be initialized with "0" on restart (warm restart).

The diagnostics buffer, MPI address (and transmission rate) and operating hour counter data are generally written to the retentive memory area on the CPU. Retentivity of the MPI address and baud rate ensures that your CPU can continue to communicate, even after a power loss, memory reset or loss of communication parameters (e.g. due to removal of the SIMATIC Micro Memory Card or deletion of communication parameters).

Retentive data in the work memory

Therefore, the contents of retentive DBs are always retentive at restart and POWER ON/OFF. Retentive data blocks can be uploaded to the work memory in accordance with the maximum limit allowed by the work memory.

In the case of the Technology CPU, non-retentive DBs are also supported. Non-retentive DBs are initialized from the load memory with their initial values whenever a restart is performed or when the power is switched off and then on again. Non-retentive data blocks and code blocks can be loaded in accordance with the maximum work memory limit.

Technology system data

The technology system data are always stored as retentive data in the load memory of the CPU.

5.1.3 Retentive behavior

Introduction

Your CPU is equipped with a maintenance-free retentive memory, i.e., its operation does not require a back-up battery. The retentivity is implemented via the SIMATIC Micro Memory Card. Data is also retained in the retentive memory throughout POWER OFF and restart (warm restart).

For information on the size of the retentive working memory (for retentive data blocks), refer to the Technical Specifications.

Technology system data

The technology system data are always stored as retentive data in the load memory of the CPU.

Retentive behavior of the memory objects

The table below shows the retentive behavior of memory objects during specific operating state transitions.

Table 5- 1 Retentive behavior of the memory objects

Memory object	Operating state transition		
	POWER ON / POWER OFF	STOP → RUN	CPU memory reset
User program/data (load memory)	X	X	X
<ul style="list-style-type: none"> • Retentive behavior of the DBs (without technology DB) • Retentive behavior of the technology DBs 	Can be set in the Properties of the DBs.		-
	-	-	-
Flags, timers and counters configured as retentive data	X	X	-
Diagnostics buffer, operating hour counters	X	X	X
MPI/DP address, transmission rate (or also DP address, transmission rate of the Technology CPU MPI/DP interface, if this is parameterized as DP node).	X	X	X
Technological parameters <ul style="list-style-type: none"> • Changed with FB "MC_WriteParameter" • Changed with <i>S7TConfig</i> 	-	X	-
	X	X	X

x = retentive; - = non-retentive

Retentive address areas of the memory of the CPU integrated technology

The values for the absolute encoder calibration are stored in a non-volatile memory in the integrated technology of the CPU.

With the technology function "MC_ReadSysParameter" you can read out the absolute encoder calibration values and store them retentively in a data block in the load memory on the SIMATIC MMC. If a CPU is replaced, you can write these stored values back to the integrated technology via the FB "MC_WriteParameter".

Retentive behavior of the technology data blocks

Technology data blocks are non-retentive.

5.1.4 Address areas of system memory

Overview

The system memory of the S7 CPUs is organized in address areas (refer to the table below). In a corresponding operation of your user program, you address data directly in the relevant address area.

Table 5- 2 Address areas of system memory

Operand areas	Description
Process input image	At every start of an OB1 cycle, the CPU reads the values at the input of the input modules and saves them the process input image.
Process output image	During its cycle, the program calculates the values for the outputs and writes these to the process output image. At the end of the OB1 cycle, the CPU writes the calculated output values to the output modules.
Flag	This area provides memory for saving the intermediate results of a program calculation.
Timers	Timers are available in this area.
Counters	Counters are available in this area.
Local data	Temporary data in a code block (OB, FB, FC) is saved to this memory area while the block is being edited.
Data blocks	See <i>recipes</i> , <i>measurement value logs</i> and <i>technology data blocks</i> .

Reference

For information on the address areas available with your CPU, refer to the Technical Specifications.

Configurable process image of the CPUs

In STEP 7, a user-specific size from 0 to 2048 can be set for the I/O process image on 31xT CPUs.

Note the information below:

Note

Currently, the dynamic setting of the process image only affects its update at the scan cycle control point. That is, the process input image is only updated up to the set PII size with the corresponding values of the peripheral input modules existing within this address area, or the values of the process output image up to the set POI size are written to the peripheral output modules existing within this address area.

This set size of the process image is ignored with respect to STEP 7 commands used to access the process image (for example U I100.0, L EW200, = Q20.0, T AD150, or corresponding indirect addressing commands also). However, up to the maximum size of the process image (that is, up to I/O byte 2047), these commands do not return any synchronous access errors, but rather access the permanently available internal memory area of the process image.

The same applies to the use of actual parameters of block calls from the I/O area (area of the process image).

Particularly if these process image limits were changed, you should check to which extent your user program accesses the process image in the area between the set and the maximum process image size. If access to this area continues the user program may not detect changes at the inputs of the I/O module, or actually fails to write output data to the output module and does not generate an error message.

You should also note that certain CPs may only be addressed outside of the process image.

I/O image DP(DRIVE)

Part of the address areas of the DP(DRIVE) is listed in the integrated technology as I/O image DP(DRIVE). You can read this area in the user program with the technology function "MC_ReadPeriphery" and write with the technology function "MC_WritePeriphery".

The update of the I/O image DP(DRIVE) is described in the S7 Technology manual at the technology functions "MC_ReadPeriphery" and "MC_WritePeriphery".

5.2 Memory functions, reset and warm restart

Memory functions

Memory functions are used to generate, modify or delete entire user programs or specific blocks. You can also ensure that your project data are retained by archiving these. If you created a new user program, use a programming device / PC to download the complete program to the SIMATIC Micro Memory Card.

CPU memory reset

After the insertion/removal of a Micro Memory Card, a CPU memory reset restores defined conditions for CPU restart (warm start).

Technology CPU:

- The CPU's memory management is rebuilt.
- Blocks in load memory are retained.
- All runtime-related blocks are transferred from the load memory to the work memory again.
- The data blocks in the work memory are initialized (are thus reset to their initial values).

Integrated technology of Technology CPU:

The CPU waits until the integrated technology has reached the STOP state.

- The integrated technology is parameterized again.
- The retentive memory of the integrated technology is rebuilt.
- Any distributed I/Os connected to DP(DRIVE) are parameterized again.
- The integrated technology is initialized again.

Reference

Also refer to CPU memory reset by means mode selector switch in the Commissioning section in the CPU 31xC and CPU 31x Operating Instructions.

Warm Restart

- All retentive DBs retain their current values.
- Non-retentive DBs are reset to their initial values.
- The values of all retentive M, C, T are retained.
- All non-retentive user data are initialized:
 - M, C, T, I, O with "0"
- All run levels are initialized.
- The process images are deleted.

Saving project data to SIMATIC Micro Memory Card

Using the **Save Project to Memory Card** and **Retrieve Project from Memory Card** functions, you can save all project data to a SIMATIC Micro Memory Card, and later retrieve it. For this operation, the SIMATIC Micro Memory Card can be located in a CPU or in the MMC adapter of a PG or PC.

Project data are compressed before they are saved to a SIMATIC Micro Memory Card and uncompressed when retrieved.

The volume of project data to be saved corresponds with the size of the project's archive file.

Note

In addition to project data, you may also have to store your user data on the MMC. You must therefore make sure beforehand that you select an MMC with sufficient memory capacity.

A message warns you if the memory capacity on your SIMATIC Micro Memory Card is insufficient

Even though you can load technology configuration data from the Micro Memory Card, you cannot edit the data.

For technical reasons, you can only transfer the entire contents (user program and project data) using the **Save Project to Memory Card** action.

5.3 Technology data blocks

Introduction

The integrated technology of the Technology CPU provides current information on the status and on the values of the technology objects via the technology data blocks. To achieve especially short response times, the technology data blocks can be evaluated in OB 65.

Processing sequence

When technology objects are configured, *S7-Technology* creates data blocks in the block folder.

If you initiate jobs to drives using a technology function, you read the states and values in the associated technology data block. A job is active if the block signals busy.

The CPU can execute a maximum of 210 active jobs simultaneously.

Technology functions that access technology data in read or write mode, occupy additional memory via the input parameter ANY-pointer. These are, for example:

- MC_ReadPeriphery
- MC_WritePeriphery
- MC_ReadRecord
- MC_WriteRecord
- MC_ReadDriveParameter
- MC_WriteDriveParameter
- MC_CamSectorAdd

No more than 100 jobs can be active simultaneously with the input parameter ANY-Pointer.

Reference

For further information, refer to the *S7 Technology* manual.

5.4 Memory of the integrated technology of the CPU

Memory utilization

The following table contains typical values for the memory utilization in the integrated technology. The values refer to a Technology CPU with firmware version of the integrated technology of V4.1.5 or higher: The measuring accuracy is 0.1%.

Technology	Memory utilization
Base load of the integrated technology	18%
Speed-controlled axis	0.7 %
Positioning axis	1.0 %
Following axis (with one following object)	1.5 %
Following axis (with two following objects)	2.0 %
External encoders	0.3 %
Output cams	0.15 %
Cam track	1.4 %
Measuring input	0.15%
Cam (empty)	0.02 %
Cam interpolation points*	0.0017 %
Path positioning axis	1.0 %
Path following axis (with one following object)	1.5 %
Path following axis (with two following objects) 1.5% 1.4% path object, Cartesian XY	2.0 %
Path object, Roll picker XY	0.9 %
Path object, Cartesian XYZ	0.9 %
Path object, Scara	0.9 %
Path object, articulated arm	0.9 %
Path object, Delta 2D picker	0.9 %
Path object, Delta 3D picker	0.9 %
Path object, Delta 3D picker with path synchronous positioning axis and following axis (1.1% 0.9%) Maximum memory utilization recommended, approx.	80 %

* You can find more information in the following calculation example.

Note

With insufficient memory, the Technology CPU goes into STOP mode. Note that these listed values are only typical values and some commands may temporarily require more memory during runtime.

If the memory utilization is excessive, online monitoring from S7T Config may no longer be possible. Therefore, the recommended calculated maximum memory utilization should not be exceeded.

Calculation example

The table shows the memory utilization for a sample configuration with a CPU 315T-2 DP with E version 01. The maximum memory utilization is 58% and is therefore less than the recommended maximum memory utilization.

Quantity	Description	Memory utilization	Memory utilization (total)
1	Base load of the integrated technology	18 %	18 %
6	Following axis (with one following object)	1.5 %	9 %
2	External encoder	0.3 %	0.6 %
6	Output cams	0.15 %	0.9 %
2	Measuring inputs	0.15 %	0.3 %
14	Cam (empty)	0.02 %	0.28 %
6000*	Cam interpolation points	0.0017 %	10.2 %
1000**	Cam interpolation points to be interpolated	0.0034 %	3.4 %
	Total		42.68 %

* The maximum possible number of cam interpolation points must be taken into account as value in the Technology CPU.
Example:
10 cams each with 300 cam interpolation points
2 cams each with 500 cam interpolation points
2 cams each with 1000 cam interpolation points
This is a total of 6000 cam interpolation points (10x300 + 2x500 + 2x1000).

** Additional memory is used during the interpolation of a cam. As only one cam can be interpolated at one time, in this case the cam with the largest number of cam interpolation points must be taken into account (this is 1000 cam interpolation points in the calculation example).

Reference

You can find more detailed information on determining the actual memory assignment in the integrated technology in the *S7 Technology* manual.

Cycle and response times

Overview

For information on calculating the cycle and response times for the CPU 31xT, refer to the CPU 31xC and CPU 31x manual. Technical Specifications, "Cycle and response times" section

Reference: Cycle time

You can view the cycle time of your user program on the PG.

Reference: Execution time

You can find information in the *S7-300 Instruction List for CPUs 31xC and 31x*. This tabular list contains the execution times for all

- *STEP 7* instructions the relevant CPUs can execute,
- the SFCs / SFBs integrated in the CPUs,
- the IEC functions which can be called in *STEP 7*.

Reference: Motion Control runtimes

You can find information about runtimes on PROFIBUS DP(DRIVE) in the *S7 Technology* manual.

Technical data

7.1 General technical data

7.1.1 Rated voltages of S7-300

Rated operating voltages

The S7-300 modules operate at different rated voltages. The table shows the rated voltages and corresponding tolerances.

Rated voltages	Tolerance
24 VDC	20.4 VDC to 28.8 VDC
120 VAC	93 VAC to 132 VAC
230 VAC	187 VAC to 264 VAC

7.1.2 Technical specifications of the Micro Memory Card

Plug-in SIMATIC Micro Memory Cards

Memory modules available:

Table 7- 1 Available SIMATIC Micro Memory Cards

Type			Order No.	Comment
Micro memory card	4	MB	6ES7953-8LMxx-0AA0	-
Micro memory card	8	MB	6ES7953-8LPxx-0AA0	Required for an operating system update

7.1.3 Standards and certifications

Introduction



Contents of general technical data:

- standards and test values satisfied by modules of the S7-300 automation system
- test criteria of S7-300 modules.

The Technology CPU orientates itself on the planned standards

- PLCopen - Technical Committee 2 – Task Force Function blocks for motion control Version 1.0
- PROFIdrive Profile 3.1 (Firmware Version 4.2)

Safety instructions

 WARNING
Personal injury and damage to property may occur. In potentially explosive environments, there is a risk of injury or damage if you disconnect any connectors while the S7-300 is in operation. Always isolate the S7-300 operated in such areas before you disconnect and connectors.
 WARNING
Risk of explosion The replacement of components possibly revokes the approval for Class I, DIV. 2.
 WARNING
These devices are suitable only for operation in Class I, Div. 2, Group A, B, C, D environments, or in non-hazardous environments.

Reference: Standards and approvals

The current standards and approvals for CPU 31xT are listed in chapter "Standards and approvals", "CPU 31xC and CPU 31x: Installation" manual (on the product DVD of the S7 Technology add-on package).

7.1.4 Electromagnetic compatibility

Definition

Electromagnetic compatibility (EMC) is the ability of an electrical installation to function satisfactorily in its electromagnetic environment without interfering with that environment.

The S7-300 modules also satisfy requirements of EMC legislation for the European domestic market. Compliance of the S7-300 system with specifications and directives on electric configuration is prerequisite.

Pulseshaped disturbance

The table below shows the EMC compatibility of S7 modules in areas subject to pulse-shaped disturbance.

Pulse-shaped disturbance	Test voltage	corresponds with degree of severity
Electrostatic discharge to IEC 61000-4-2	Air discharge: ± 8 kV	3
	Contact discharge ± 4 kV	2
Burst pulses (high-speed transient disturbance) to IEC 61000-4-4.	2 kV (power supply lines)	3
	2 kV (signal lines > 3 m)	3
	1 kV (signal lines < 3 m)	
High-energy single pulse (surge) to IEC 61000-4-5 External protective circuitry required (Refer to S7-300 CPU 31xC and CPU 31x Operating Instructions: Configuration, section "Protection against lightning and overvoltages")		3
• asymmetric coupling	2 kV (power supply lines) DC with protective elements 2 kV (signal/ data line only > 3 m), with protective elements as required	
• symmetric coupling	1 kV (power supply lines) DC with protective elements 1 kV (signal/ data line only > 3 m), with protective elements as required	

Additional measures

When connecting an S7-300 system to the public network, always ensure compliance with Limit Value Class B to EN 55022.

Sinusoidal disturbance

The table below shows the EMC compatibility of S7-300 modules in areas subject to sinusoidal disturbance.

Sinusoidal disturbance	Test values	corresponds with degree of severity
RF radiation (electromagnetic fields) to IEC 61000-4-3	10 V/m, with 80% amplitude modulation of 1 kHz in the 80 MHz to 1000 MHz range 10 V/m, with 50% pulse modulation at 900 MHz	3
RF conductance on cables and cable shielding to IEC 61000-4-6	Test voltage 10 V, with 80% amplitude modulation of 1 kHz in the 9 MHz to 80 MHz range	3

Emission of radio interference

Electromagnetic interference to EN 55011: Limit Class A, Group 1 (measured at a distance of 10 m.)

Frequency	Noise emission
30 MHz to 230 MHz	< 40 dB (µV/m)Q
230 MHz to 1000 MHz	< 47 dB (µV/m)Q

Noise emission via AC mains to EN 55011: Limit value class A, Group 1.

Frequency	Noise emission
0.15 MHz to 0.5 MHz	< 79 dB (µV/m)Q < 66 dB (µV/m)M
0.5 MHz to 5 MHz	< 73 dB (µV/m)Q < 60 dB (µV/m)M
5 MHz to 30 MHz	< 73 dB (µV/m)Q < 60 dB (µV/m)M

7.1.5 Shipping and storage conditions for modules and backup batteries

Introduction

The shipping and storage conditions of S7-300 modules surpass requirements to IEC 61131-2. The data below apply to modules shipped or put on shelf in their original packing.

The modules are compliant with climatic conditions to IEC 60721-3-3, Class 3K7 (storage), and with IEC 60721-3-2, Class 2K4 (shipping.)

Mechanical conditions are compliant with IEC 60721-3-2, Class 2M2.

Shipping and storage conditions for modules

Type of condition	Permissible range
Free fall (in shipping package)	≤ 1 m
Temperature	- 40 °C to + 70 °C
Barometric pressure	1080 hPa to 660 hPa (corresponds with an altitude of -1000 m to 3500 m)
Relative humidity	10% to 95%, no condensation
Sinusoidal oscillation to IEC 60068-2-6	5 Hz to 9 Hz: 3.5 mm 9 Hz to 150 Hz: 9.8 m/s ²
Shock to IEC 60068-2-29	250 m/s ² , 6 ms, 1000 shocks

7.1.6 Mechanical and climatic environmental conditions for S7-300 operation

Operating conditions

S7-300 systems are designed for stationary use in weather-proof locations. The operating conditions surpass requirements to DIN IEC 60721-3-3.

- Class 3M3 (mechanical requirements)
- Class 3K3 (climatic requirements)

Use with additional measures

The S7-300 may not be used under the conditions outlined below without taking additional measures:

- at locations with a high degree of ionizing radiation
- in aggressive environments caused, for example, by
 - the development of dust
 - corrosive vapors or gases
 - strong electric or magnetic fields
- in installations requiring special monitoring, for example
 - elevators
 - electrical plants in potentially hazardous areas

An additional measure could be an installation of the S7-300 in a cabinet or housing.

Mechanical environmental conditions

The table below shows the mechanical environmental conditions in the form of sinusoidal oscillations.

Frequency band	Continuous	Infrequently
$10 \text{ Hz} \leq f \leq 58 \text{ Hz}$	0.0375 mm amplitude	0.75 mm amplitude
$58 \text{ Hz} \leq f \leq 150 \text{ Hz}$	0.5 g constant acceleration	1 g constant acceleration

Reducing vibrations

If your S7-300 modules are exposed to severe shock or vibration, take appropriate measures to reduce acceleration or the amplitude.

We recommend the installation of the S7-300 on damping materials (for example, rubber-bonded-to-metal mounting.)

Test of mechanical environmental conditions

The table below provides important information with respect to the type and scope of the test of ambient mechanical conditions.

Condition tested	Test Standard	Comment
Vibration	Vibration test to IEC 60068-2-6 (sinusoidal)	Type of oscillation: Frequency sweeps with a rate of change of 1 octave/minute. 10 Hz ≤ f ≤ 58 Hz, constant amplitude 0.075 mm 58 Hz ≤ f ≤ 150 Hz, constant acceleration 1 g Duration of oscillation: 10 frequency sweeps per axis at each of three vertically aligned axes
Shock	Shock, tested to IEC 60068-2-27	Type of shock: half-sine Severity of shock: 15 g peak value, 11 ms duration Direction of shock: 3 shocks in each direction (+/-) at each of three vertically aligned axes
Continuous shock	Shock, tested to IEC 60068-2-29	Type of shock: half-sine Severity of shock: 25 g peak value, 6 ms duration Shock direction: 1000 shocks in each direction (+/-) at each of three vertically aligned axes

Climatic environmental conditions

The S7-300 may be operated on following environmental conditions:

Environmental conditions	Permissible range	Comments
Temperature: horizontal mounting position: vertical mounting position:	0°C to 60°C 0°C to 40°C	
Relative humidity	10 % to 95 %	No condensation, corresponds to relative humidity (RH) Class 2 to IEC 61131, Part 2
Barometric pressure	1080 hPa to 795 hPa	Corresponds with an altitude of -1000 m to 2000 m
Concentration of pollutants	SO ₂ : < 0.5 ppm; RH < 60 %, no condensation H ₂ S: < 0.1 ppm; RH < 60 %, no condensation	Test: 10 ppm; 4 days Test: 1 ppm; 4 days

7.1.7 Specification of dielectric tests, protection class, degree of protection, and rated voltage of S7-300

Test voltage

Proof of dielectric strength must be provided in the type test at a test voltage to IEC 61131-2:

Circuits with rated voltage V_e to other circuits or ground.	Test voltage
< 50 V	500 VDC
< 150 V	2500 VDC
< 250 V	4000 VDC

Protection class

Protection class I to IEC 60536, i.e., a protective conductor must be connected to the mounting rail!

Protection against the ingress of foreign matter and water

- Degree of protection IP 20 to IEC 60529, i.e., protection against contact with standard probes.

No protection against the ingress of water.

7.1.8 Dimension drawing

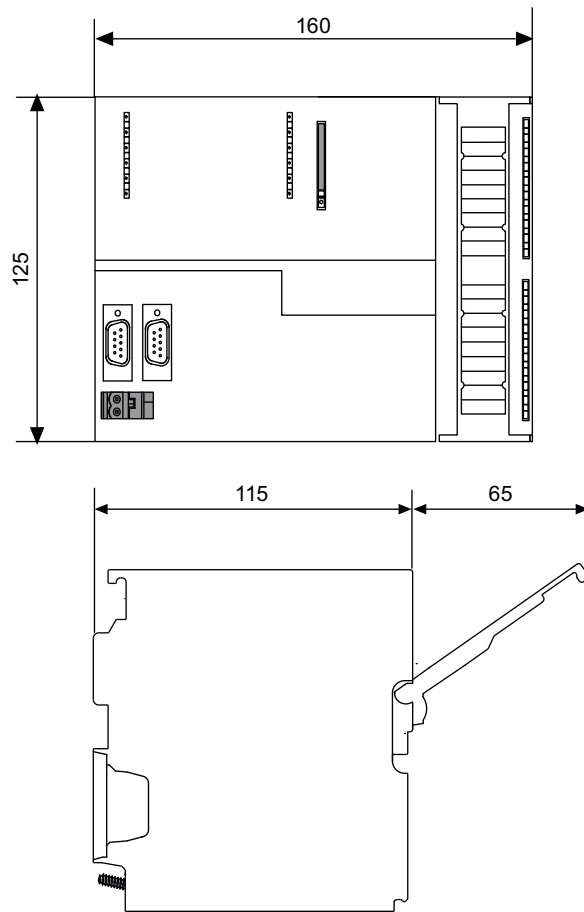

7.2 Technical specifications of the CPU 315T-2 DP and 317T-2 DP

Technical specifications of the CPUs

- CPU 315T-2 DP, order number 6ES7315-6TH13-0AB0
- CPU 317T-2 DP, order number 6ES7317-6TK13-0AB0

	6ES7315-6TH13-0AB0	6ES7317-6TK13-0AB0
Revision level		
HW revision level	01	01
Firmware version	CPU: V 2.7; Integrated technology: V 4.1.5	CPU: V 2.7; Integrated technology: V 4.1.5
associated programming package	STEP 7 V 5.4 + SP5 and higher plus S7 Technology V4.2 add-on package	STEP 7 V 5.4 + SP5 and higher plus S7 Technology V4.2 add-on package
Supply voltages		
Rated value		
• DC 24 V	Yes	Yes
• valid range, lower limit (DC)	20.4 V	20.4 V
• valid range, upper limit (DC)	28.8 V	28.8 V
external power line fusing (recommendation)	min. 2 A	min. 2 A
Load voltage L+		
• Rated value (DC)	24 V	24 V
• Polarity reversal protection	Yes	Yes
Digital outputs		
Load voltage L+		
• Rated value (DC)	24 V (2L+)	24 V (2L+)
• Polarity reversal protection	No (2L+)	No (2L+)
Current consumption		
• Quiescent current, typically	250 mA	250 mA
• Inrush current, typically	2.5 A	2.5 A
• I ² t	1 A ² s	1 A ² s
Power loss		
• Power loss, typically	6 W	6 W
Memory		
Work memory		
• integrated	256 KB	1024 KB
• expandable	No	No
Load memory		
• pluggable (MMC)	Yes	Yes
• pluggable (MMC), max.	8 MB	8 MB
• Data storage on MMC (after last programming session), min.	10 years	10 years

7.2 Technical specifications of the CPU 315T-2 DP and 317T-2 DP

	6ES7315-6TH13-0AB0	6ES7317-6TK13-0AB0
Backup		
• available	Yes, ensured through MMC (maintenance-free)	Yes, ensured through MMC (maintenance-free)
CPU/blocks		
• Number of blocks (total)	1024 (DBs, FCs, FBs). The maximum number of loadable blocks is possibly reduced due to the MMC used.	2048 (DBs, FCs, FBs). The maximum number of loadable blocks is possibly reduced due to the MMC used.
FB		
• Quantity, max.	1024; Number range: 0 to 2047	2048; Number range: 0 to 2047
• Size, max.	64 KB	64 KB
FC		
• Quantity, max.	1024; Number range: 0 to 2047	2048; Number range: 0 to 2047
• Size, max.	64 KB	64 KB
OB		
• Size, max.	64 KB	64 KB
• Number of dynamic-cycle OBs	1; OB 1	1; OB 1
• Number of time alarm OBs	1; OB 10	1; OB 10
• Number of delay interrupt OBs	1; OB 20	2; OB 20, 21
• Number of cyclic interrupt OBs	1; OB 35	4; OB 32, 33, 34, 35
• Number of process alarm OBs	1; OB 40	1; OB 40
• Number of DPV1 alarm OBs	3; OB 55, 56, 57	3; OB 55, 56, 57
• Number of isochronous mode OBs	1; OB 61	1; OB 61
• Number of technology synchronization alarm OBs	1; OB 65	1; OB 65
• Number of startup OBs	1; OB 100	1; OB 100
• Number of asynchronous mode error OBs	5; OB 80, 82, 85, 86, 87	5; OB 80, 82, 85, 86, 87
• Number of synchronous mode error OBs	2; OB 121, 122	2; OB 121, 122
Nesting depth		
• per priority class	8	16
• additional ones in an error OB	4	4

	6ES7315-6TH13-0AB0	6ES7317-6TK13-0AB0
CPU processing times		
• for bit operations, min.	0.1 µs	0.05 µs
• for word operations, min.	0.2 µs	0.2 µs
• for fixed-point arithmetics, min.	2 µs	0.2 µs
• for floating-point arithmetics, min.	3 µs	1 µs
Counter, timeers and their retentivity		
S7 counters		
• Quantity	256; Number range: 0 to 255	512; Number range: 0 to 511
Retentive address areas		
• Adjustable	Yes	Yes
default	8; FROM Z 0 to Z 7	8; FROM Z 0 to Z 7
Counting range		
• Lower limit	0	0
• Upper limit	999	999
IEC counter		
• available	Yes	Yes
Type	SFB	SFB
• Quantity	unlimited (limited only by work memory)	unlimited (limited only by work memory)
S7 times		
• Quantity	256; Number range: 0 to 255	512; Number range: 0 to 511
Retentive address areas		
• Adjustable	Yes	Yes
default	no retentivity	no retentivity
Time range		
• Lower limit	10 ms	10 ms
• Upper limit	9990 s	9990 s
IEC timer		
• available	Yes	Yes
Type	SFB	SFB
• Quantity	unlimited (limited only by work memory)	unlimited (limited only by work memory)
Data areas and their retentivity		
Flag		
• Quantity, max.	2048 bytes	4096 bytes
• Retentivity available	Yes; MB 0 to MB 2047	Yes; MB 0 to MB 4095
Default retentivity	MB 0 to MB 15	MB 0 to MB 15
• Number of cycle clock flags:	8; 1 flag byte	8; 1 flag byte

7.2 Technical specifications of the CPU 315T-2 DP and 317T-2 DP

	6ES7315-6TH13-0AB0	6ES7317-6TK13-0AB0
Data blocks		
• Quantity, max.	1023; from DB 1 to DB 1023	2047; from DB 1 to DB 2047
• Size, max.	64 KB	64 KB
• Retentivity selectable	Yes, at the Non Retain property of the DB	Yes, at the Non Retain property of the DB
Default retentivity	Yes	Yes
Local data		
• per priority class, max.	1024 bytes	1024 bytes
Address space		
I/O address space		
• Inputs	2048 bytes	8192 bytes
• Outputs	2048 bytes	8192 bytes
of those distributed		
• Inputs	2048 bytes	8192 bytes
• Outputs	2048 bytes	8192 bytes
Process image		
• Inputs, selectable	2048 bytes	2048 bytes
• Outputs, selectable	2048 bytes	2048 bytes
• Inputs, default	128 bytes	256 bytes
• Outputs, default	128 bytes	256 bytes
Process image partitions		
• Number of process image partitions, max.	1	1
Digital channels		
• integrated channels (DI)	0	0
• integrated channels (DO)	0	0
• Inputs	16384	65536
• Outputs	16384	65536
• Inputs, of those central	512	512
• Outputs, of those central	512	512
Analog channels		
• integrated channels (AI)	0	0
• integrated channels (AO)	0	0
• Inputs	1024	4096
• Outputs	1024	4096
• Inputs, of those central	64	64
• Outputs, of those central	64	64

7.2 Technical specifications of the CPU 315T-2 DP and 317T-2 DP

	6ES7315-6TH13-0AB0	6ES7317-6TK13-0AB0
Hardware configuration		
• Racks, max.	1	1
• Modules per rack, max.	8	8
Number of DP masters		
• integrated	2; 1 DP and 1 DP(Drive)	2; 1 DP and 1 DP(Drive)
• via CP	2 for DP	2 for DP
Number of FMs and CPs for operation (recommended)		
• FM	8	8
• CP, Point-to-Point	8	8
• CP, LAN	8	8
Time		
Clock		
• Hardware clock (realtime)	Yes	Yes
• backup, synchronization supported	Yes	Yes
• Backup time	6 weeks at an ambient temperature of 40°C	6 weeks at an ambient temperature of 40°C
• Precision per day, max.	10 s	10 s
Operating hours counter		
• Quantity	1	4
Number/range of numbers	0	0 to 3
Range of values	0 to 2 ³¹ hours (with SFC 101)	0 to 2 ³¹ hours (with SFC 101)
Resolution	1 hour	1 hour
• retentive	Yes, restart necessary after every cold restart	Yes, restart necessary after every cold restart
Time synchronization		
• supported	Yes	Yes
• on MPI	Master/slave	Master/slave
• on DP	Master/slave (on DP slave only as time slave)	Master/slave (on DP slave only as time slave)
• On the AS	Master/slave	Master/slave
S7 message functions		
• Number of stations that can be logged on for message functions, max.	16, depending on the connections configured for PG, OP and S7 basic communication	32, depending on the connections configured for PG, OP and S7 basic communication
• Process diagnostic messages	Yes	Yes
• simultaneously active Alarm-S blocks, max.	40	60

	6ES7315-6TH13-0AB0	6ES7317-6TK13-0AB0
Test and commissioning functions		
Status/control		
• Status/control variable	Yes	Yes
Variables	Inputs, outputs, flags, DBs, timers, counters	Inputs, outputs, flags, DBs, timers, counters
• Number of variables, max.	30	30
• of those are status variables, max.	30	30
• of those are control variables, max.	14	14
Force		
• Force	Yes	Yes
Force, variables	Inputs, outputs	Inputs, outputs
• Number of variables, max.	10	10
• Block status	Yes	Yes
• Single-step mode	Yes	Yes
• Number of break points	2 (without resume)	2 (without resume)
Diagnostics buffer		
• available	Yes	Yes
• Number of entries, max.	100	100
• adjustable	No	No
Communication functions		
• PG/OP communication	Yes	Yes
• Routing	Yes	Yes
Global data communication		
• supported	Yes	Yes
• Number of GD circuits, max.	8	8
• Number of GD packets, max.	8	8
• Number of GD packets, transmitting stations, max.	8	8
• Number of GD packets, receiving stations, max.	8	8
• Length of GD packets, max.	22 bytes	22 bytes
• Length of GD packets (of those consistent), max.	22 bytes	22 bytes
S7 basic communication		
• supported	Yes	Yes
• User data per job, max.	76 bytes	76 bytes
• User data per job (of those consistent), max.	76 bytes; 76 bytes (for X_SEND or X_RCV), 76 bytes (for X_PUT or X_GET as server)	76 bytes; 76 bytes (for X_SEND or X_RCV), 76 bytes (for X_PUT or X_GET as server)

	6ES7315-6TH13-0AB0	6ES7317-6TK13-0AB0
S7 communication		
• supported	Yes	Yes
• as server	Yes	Yes
• as client	Yes, via CP and loadable FBs	Yes, via CP and loadable FBs
• User data per job, max.	180 bytes (for PUT/GET)	180 bytes (for PUT/GET)
• User data per job, of those consistent, max.	160 bytes (as server)	160 bytes (as server)
S5-compatible communication		
• supported	Yes, via CP and loadable FCs	Yes, via CP and loadable FCs
Number of connections		
• Total	16	32
• suitable for PG communication	15	31
• reserved for PG communication	1	1
• selectable for PG communication, min.	1	1
• selectable for PG communication, max.	15	31
• suitable for OP communication	15	31
• reserved for OP communication	1	1
• selectable for OP communication, min.	1	1
• selectable for OP communication, max.	15	31
• suitable for S7 basic communication	12	30
• reserved for S7 basic communication	0	0
• selectable for S7 basic communication, min.	0	0
• selectable for S7 basic communication, max.	12	30
• selectable for routing, max.	8 additional	8 additional
1. Interface (X1)		
Interface type	integrated RS 485 interface	integrated RS 485 interface
Physics	RS 485	RS 485
• electrically isolated	Yes	Yes
• Power supply to interface (15 VDC to 30 VDC), max.	200 mA	200 mA

7.2 Technical specifications of the CPU 315T-2 DP and 317T-2 DP

	6ES7315-6TH13-0AB0	6ES7317-6TK13-0AB0
Functionality		
• MPI	Yes	Yes
• DP master	Yes	Yes
• DP slave	Yes	Yes
• Point-to-Point data link	No	No
MPI		
• Number of connections	32	32
Services		
• PG/OP communication	Yes	Yes
• Routing	Yes	Yes
• Global data communication	Yes	Yes
• S7 basic communication	Yes	Yes
• S7 communication	Yes	Yes
• S7 communication, as client	No; but possible via CP and loadable FBs	No; but possible via CP and loadable FBs
• S7 communication, as server	Yes; one-way connection configuration only	Yes; one-way connection configuration only
• Transmission speed, max.	12 Mbps	12 Mbps
DP master		
Services		
• PG/OP communication	Yes	Yes
• Routing	Yes	Yes
• Global data communication	No	No
• S7 basic communication	Yes; I-blocks only	Yes; I-blocks only
• S7 communication	Yes	Yes
• Constant bus cycle time supported	Yes	Yes
• Isochronous mode	Yes; OB 61	Yes; OB 61
• SYNC/FREEZE	Yes	Yes
• Enabling/disabling of DP slaves	Yes	Yes
• Number of DP slaves that can be enabled/disabled simultaneously, max.	4	J4
• DPV1	Yes	Yes
• Transmission speed, max.	12 Mbps	12 Mbps
• Number of Dp slaves, max.	124	124
Address space		
• Inputs, max.	2048 bytes	8192 bytes
• Outputs, max.	2048 bytes	8192 bytes

7.2 Technical specifications of the CPU 315T-2 DP and 317T-2 DP

	6ES7315-6TH13-0AB0	6ES7317-6TK13-0AB0
User data per DP slave		
• Inputs, max.	244 bytes	244 bytes
• Outputs, max.	244 bytes	244 bytes
DP slave		
Services		
• Routing	Yes; with active interface only	Yes; with active interface only
• Global data communication	No	No
• S7 basic communication	No	No
• S7 communication	Yes; server only, one-way connection configuration	Yes; server only, one-way connection configuration
• Direct data exchange (cross-traffic)	Yes	Yes
• DPV1	No	No
• Transmission speed, max.	12 Mbps	12 Mbps
• Automatic baud rate detection	Yes; with passive interface only	Yes; with passive interface only
Transfer memory		
• Inputs	244 bytes	244 bytes
• Outputs	244 bytes	244 bytes
• Address space, max.	32	32
• User data per address space, max.	32 bytes	32 bytes
• GSD file	http://www.ad.siemens.de/support , Product Support pages	http://www.ad.siemens.de/support , Product Support pages
2. Interface (X3)		
Interface type	integrated RS 485 interface	integrated RS 485 interface
Physics	RS 485	RS 485
• electrically isolated	Yes	Yes
• Power supply to interface (15 VDC to 30 VDC), max.	200 mA	200 mA
Functionality		
• MPI	No	No
• DP master	Yes, DP(DRIVE) master	Yes, DP(DRIVE) master
• DP slave	No	No
• Local Operating Network	No	No
DP master		
Services		
• PG/OP communication	No	No
• Routing	Yes	Yes
• Global data communication	No	No
• S7 basic communication	No	No

7.2 Technical specifications of the CPU 315T-2 DP and 317T-2 DP

	6ES7315-6TH13-0AB0	6ES7317-6TK13-0AB0
• S7 communication	No	No
• Constant bus cycle time supported	Yes	Yes
• Isochronous mode	Yes	Yes
• SYNC/FREEZE	No	No
• Enabling/disabling of DP slaves	Yes	Yes
• DPV1	No	No
• Transmission speed, max.	12 Mbps	12 Mbps
• Number of Dp slaves, max.	64	64
Address space		
• Inputs, max.	1024 bytes	1024 bytes
• Outputs, max.	1024 bytes	1024 bytes
User data per DP slave		
• Inputs, max.	244 bytes	244 bytes
• Outputs, max.	244 bytes	244 bytes
CPU/programming		
Programming language		
• STEP 7	Yes	Yes
• LAD	Yes	Yes
• FBD	Yes	Yes
• STL	Yes	Yes
• SCL	Yes	Yes
• CFC	Yes	Yes
• GRAPH	Yes	Yes
• HiGraph®	Yes	Yes
Instruction set	See Instructions list	See Instructions list
• Parenthesis levels	8	8
Know-how protection		
• User program protection / password security	Yes	Yes
System functions (SFC)	See Instructions list	See Instructions list
System function blocks (SFB)	See Instructions list	See Instructions list
Cycle time monitoring		
• Lower limit	1 ms	1 ms
• Upper limit	6000 ms	6000 ms
• selectable	Yes	Yes
• default	150 ms	150 ms
Integrated I/O		
Default addresses of integrated channels		
Digital inputs	66	66
Digital outputs	66	66

7.2 Technical specifications of the CPU 315T-2 DP and 317T-2 DP

	6ES7315-6TH13-0AB0	6ES7317-6TK13-0AB0
Digital data input		
• Number of inputs	4	4
• inputs available for technological functions	4	4
number of simultaneously controlled inputs		
horizontal mounting position		
• up to 40 °C, max.	4	4
• up to 60 °C, max.	4	4
vertical mounting position		
• up to 40 °C, max.	4	4
• Input characteristic to IEC 1131, type 1	Yes	Yes
Input voltage		
• Rated value, DC	24 V	24 V
for signal 0	-3 V to +5 V	-3 V to +5 V
for signal 1	15 V to 30 V	15 V to 30 V
Input current		
• for signal 1, typically	7 mA	7 mA
Input delay (at rated input voltage)		
for counters/technological functions		
• at 0 to 1, max.	10 µs typically	10 µs typically
• at 1 to 0, max.	10 µs typically	10 µs typically
Cable length		
• Shielded cable length, max.	1000 m	1000 m
Digital data output		
• Number of outputs	8	8
• high-speed outputs	8	8
• Short-circuit protection	Yes	Yes
Response threshold, typically	1.0 A	1.0 A
Limiting of the inductive cut-off voltage to	48 V	48 V
• Lamp load, max.	5 W	5 W
• Digital input control	No	No
Output voltage		
for signal 1, min.	Rated voltage - 2.5 V (2L+)	Rated voltage - 2.5 V (2L+)
Output current		
• for signal 1, rated value	0.5 A	0.5 A
• residual current for 0 signal, max.	0.3 mA	0.3 mA

7.2 Technical specifications of the CPU 315T-2 DP and 317T-2 DP

	6ES7315-6TH13-0AB0	6ES7317-6TK13-0AB0
Parallel wiring of two outputs		
• for performance increase	No	No
• for redundant control of a load	No	No
Switching frequency		
• on resistance load, max.	100 Hz	100 Hz
• on inductance load, max.	0.2 Hz to IEC 947-5-1, DC13	0.2 Hz to IEC 947-5-1, DC13
• on lamp load, max.	100 Hz	100 Hz
Total current of outputs (per group)		
horizontal mounting position		
• up to 40 °C, max.	4 A	4 A
• up to 60 °C, max.	3 A	3 A
Load resistance range		
• Lower limit	48 Ohm	48 Ohm
• Upper limit	4 kOhm	4 kOhm
Cable length		
• Shielded cable length, max.	1000 m	1000 m
Encoder		
Supported encoders		
• 2-wire BERO	No	No
Alarms/ diagnostics/ status information		
Alarms		
• Alarms	No	No
Diagnostics		
• Diagnostics functions	No	No
Diagnostics LED		
• Status display, digital output, (green)	Yes	Yes
• Status display, digital input, (green)	Yes	Yes
Insulation		
Insulation test voltage	500 VDC	500 VDC
Electrical isolation		
Electrical isolation for digital input signals		
• between channels and the backplane bus	Yes	Yes
Electrical isolation for digital output signals		
• between channels and the backplane bus	Yes	Yes

7.2 Technical specifications of the CPU 315T-2 DP and 317T-2 DP

	6ES7315-6TH13-0AB0	6ES7317-6TK13-0AB0
Permissible potential difference between different electrical circuits	75 VDC / 60 VAC	75 VDC / 60 VAC
Dimensions and weight		
Dimensions		
• Width	160 mm	160 mm
• Height	125 mm	125 mm
• Depth	130 mm	130 mm
Weight		
• Weight, approx.	750 g	750 g

7.3 Technical specifications of the integrated technology of CPUs 31xT

Technical specifications of the integrated technology

- CPU 315T-2 DP, with the order number 6ES7315-6TH13-0AB0
- CPU 317T-2 DP, with the order number 6ES7317-6TK13-0AB0

	6ES7315-6TH13-0AB0	6ES7317-6TK13-0AB0
Technology objects		
Total	32 (axes, cams, output cams, cam tracks, measuring inputs, external encoders)	64 (axes, cams, output cams, cam tracks, measuring inputs, external encoders)
Axes	8 axes (virtual or real axes)	32 axes (virtual or real axes)
Output cams	16 output cams 8 output cams can be output as "high-speed output cams" on the integrated outputs of the Technology CPU. An additional 8 output cams can be implemented via distributed I/Os (for example on the ET 200M or ET 200S) These can be implemented as "high-speed output cams" on the TM15 and TM17 High Feature.	32 output cams 8 output cams can be output as "high-speed output cams" on the integrated outputs of the Technology CPU. An additional 24 output cams can be implemented via distributed I/Os (for example on the ET 200M or ET 200S) These can be implemented as "high-speed output cams" on the TM15 and TM17 High Feature.
Cam tracks	16	32
Total number of output cams that are used in cam tracks	512 (32 output cams per cam track)	1024 (32 output cams per cam track)
Cams	16	32
Measuring inputs	8	16
External encoders	8	16
Path objects	4	8

7.4 Arrangement of integrated inputs/outputs for integrated technology

Introduction

The Technology CPU has 4 digital inputs and 8 digital outputs integrated. You use these inputs and outputs for technology functions, e.g. reference point acquisition (reference cams) or high-speed output cam switching signals.

You can also use the digital inputs / outputs with the technology functions "MC_ReadPeriphery" and "MC_WritePeriphery" in the STEP 7 user program.

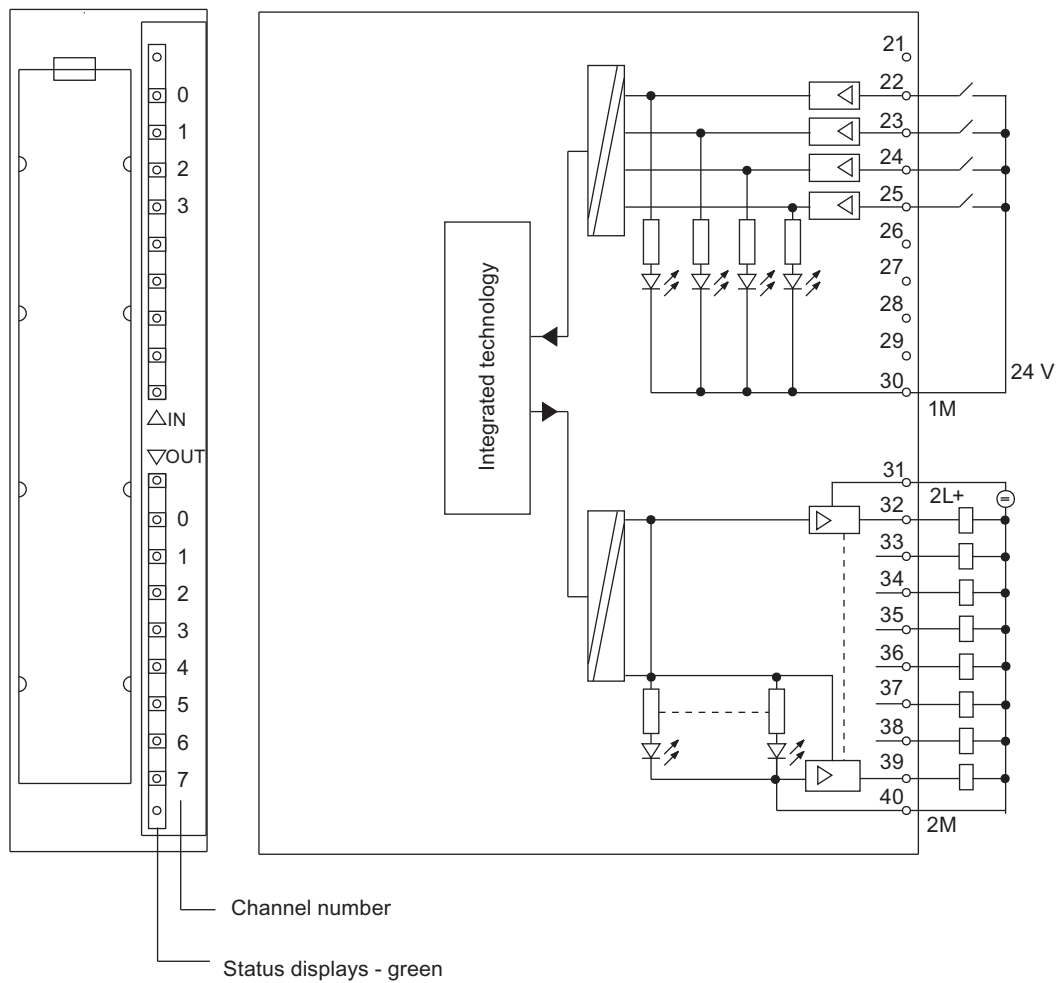

Figure 7-1 Block diagram of integrated inputs/outputs for integrated technology

Appendix

A.1 Information for the Changeover to the Technology CPU

A.1.1 Scope

Who should read this information?

Are you already using a CPU from the SIMATIC S7-300 series and now want to upgrade to a Technology CPU?

Please note that problems may occur when you download your user program to the "new" CPU.

If you have used one of the following CPUs in the past ...

Table A- 1 CPUs previously used

CPU	Order No.	As of version Firmware
CPU 312 IFM	6ES7312-5AC02-0AB0	1.0.0
	6ES7312-5AC82-0AB0	
CPU 313	6ES7313-1AD03-0AB0	1.0.0
CPU 314	6ES7314-1AE04-0AB0	1.0.0
	6ES7314-1AE84-0AB0	
CPU 314 IFM	6ES7314-5AE03-0AB0	1.0.0
CPU 314 IFM	6ES7314-5AE83-0AB0	1.0.0
CPU 315	6ES7315-1AF03-0AB0	1.0.0
CPU 315-2 DP	6ES7315-2AF03-0AB0	1.0.0
	6ES7315-2AF83-0AB0	
CPU 316-2 DP	6ES7316-2AG00-0AB0	1.0.0
CPU 318-2 DP	6ES7318-2AJ00-0AB0	V3.0.0

... Then please read the following information regarding migration to the Technology CPU

A.1.2 Changed behavior of certain SFCs

SFC 13, SFC 56 and SFC 57 which work asynchronously...

Some of the SFCs that work asynchronously, when used on CPUs 312 IFM to 318-2 DP, were always, or under certain conditions, processed after the first call ("quasi-synchronous").

On the Technology CPU, these SFCs actually run asynchronously. Asynchronous processing may cover multiple OB1 cycles. As a result, a wait loop may turn into an endless loop within an OB.

The following are affected:

- SFC 13 "DPNRM_DG"

On CPUs 312 IFM to 318-2 DP, this SFC always works "quasi synchronously" when it is called in OB 82. On the Technology CPU, it generally works asynchronously.

Note

In the user program, the job should merely be started in OB 82. The data should be evaluated in the cyclical program, taking account of the BUSY bits and the value returned in RET_VAL.

Tip

If you are using a Technology CPU, we recommend that you use SFB 54, rather than SFC 13 "DPNRM_DG".

- SFC 56 "WR_DPARM"; SFC 57 "PARM_MOD"

On CPUs 312 IFM to 318-2 DP, these SFCs always work "quasi-synchronously" during communication with centralized I/O modules and always work synchronously during communication with distributed I/O modules.

Note

If you are using SFC 56 "WR_DPARM" or SFC 57 "PARM_MOD", you should always evaluate the SFCs' BUSY bit.

SFC 20 "BLKMOV"

In the past, this SFC could be used with CPUs 312 IFM to 318-2 DP to copy data from a non runtime-related DB.

SFC 20 no longer has this functionality with the **Technology CPU** SFC 83 "READ_DBL" must now be used instead.

SFC 54 "RD_DPARM"

This SFC is no longer available on the **Technology CPU**. Use SFC 102 "RD_DPARA" instead, which works asynchronously.

SFCs that may return other results

You can ignore the following points if you only use logical addressing in your user program.

When using address conversion in your user program (SFC 5 "GADR_LGC", SFC 49 "LGC_GADR"), you must check the assignment of the slot and logical start address for your DP slaves.

- In the past, the diagnostic address of a DP slave was assigned to the slave's virtual slot 2. Since DPV1 was standardized, this diagnostic address has been assigned to virtual slot 0 (station proxy) for the **Technology CPU**
- If the slave has modeled a separate slot for the interface module (e.g. **Technology CPU** as an intelligent slave or IM 153), then its address is assigned to slot 2.

Activating / deactivating DP slaves via the SFC 12

With the **Technology CPU**, slaves that were deactivated via SFC 12 are no longer automatically activated at the RUN to STOP transition. Now they are not activated until they are restarted (STOP to RUN transition).

A.1.3 Interrupt events from distributed I/Os while the CPU status is in STOP

Interrupt events from distributed I/Os while the CPU status is in STOP

With the new DPV1 functionality (IEC 61158/ EN 50170, volume 2, PROFIBUS), the handling of incoming interrupt events from the distributed I/Os while the CPU status is in STOP has also changed.

Previous response by the CPU in the STOP state:

With CPUs 312 IFM to 318-2 DP, an interrupt event was initially noted while the CPU was in STOP mode. When the CPU status subsequently returned to RUN, the interrupt was then fetched by an appropriate OB (e.g. OB 82).

New response by the CPU:

With the **Technology CPU**, an interrupt event (process or diagnostic interrupt, new DPV1 interrupts) is acknowledged by the distributed I/O while the CPU is still in STOP status, and is entered in the diagnostic buffer if necessary (diagnostic interrupts only). When the CPU status subsequently returns to RUN, the interrupt is no longer fetched by the OB. Possible slave faults can be read using suitable SSL queries (e.g. read SSL 0x692 via SFC51).

A.1.4 Runtimes that change while the program is running

Runtimes that change while the program is running

If you have created a user program that has been fine-tuned in relation to certain processing times, please note the following points if you are using a **Technology CPU**:

- The program will run much faster on the **Technology CPU**.
- Functions that require MMC access (e.g. system start-up time, program download in RUN, return of DP station, etc), may sometimes run slower on the **Technology CPU**.

A.1.5 Converting the diagnostic addresses of DP slaves

Converting the diagnostic addresses of DP slaves

If you are using a **Technology CPU** as the master, please note that you may have to reassign the diagnostic addresses for the slaves since the changes to the DPV1 standard sometimes require two diagnostic addresses per slave.

- The virtual slot 0 has its own address (diagnostic address of the station proxy). The module status data for this slot (read SSL 0xD91 with SFC 51 "RDSYSST") contains IDs that relate to the entire slave/station, e.g. the "station error ID". Failure and restoration of the station are also signaled in OB 86 on the master via the diagnostic address of the virtual slot 0.
- The interface module is also modeled as a separate, virtual slot for some slaves (e.g. CPU as intelligent slave or IM 153) in which case it is assigned to virtual slot 2 with a separate address.
When the **Technology CPU** is used as an intelligent slave, for example, the operating status change is signaled in diagnostic interrupt OB 82 of the master via this address.

Note

Reading diagnostics data with SFC 13 "DPNRM_DG":
The originally assigned diagnostics address still works. Internally, *STEP 7* assigns this address to slot 0.

When using SFC51 "RDSYSST", for example, to read module status information or module rack/station status information, you must also consider the change in slot significance as well as the additional slot 0.

A.1.6 Reusing existing hardware configurations

Reusing existing hardware configurations

If you reuse the configuration of a CPU 312 IFM to 318-2 DP for a **Technology CPU**, the CPU may not run correctly.

If this is the case, you will have to replace the CPU in the STEP 7 hardware configuration editor. When you replace the CPU, STEP 7 will automatically accept all the settings (if appropriate and possible).

A.1.7 Replacement of a Technology CPU

Replacement of a Technology CPU

The Technology CPU is supplied with a connector inserted in the power supply port.

You do not need to disconnect the cables of the CPU when you replace a Technology CPU: Insert a screwdriver with 3.5 mm blade into the right side of the connector to open the interlock mechanism, then unplug it from the CPU. Once you have replaced the CPU, simply plug the connecting plug back into the power supply connector.

A.1.8 Using consistent data areas in the process image of a DP master

Consistent data

The table below illustrates the points to consider with respect to communication in a **DP master system** if you want to transfer I/O areas with "Total length" consistency. You can transfer a maximum of 128 bytes of consistent data.

Table A- 2 Consistent data

CPU 315-2 DP (as of firmware 2.0.0), CPU 317, CPU 319 CPU 31xC	CPU 315-2 DP (as of firmware 1.0.0), CPU 316-2 DP, CPU 318-2 DP (firmware < 3.0)	CPU 318-2 DP (firmware >= 3.0)
The address area of consistent data in the process image is automatically updated.	Even if it exist in the process image, consistent data is not automatically updated.	You can choose whether or not to update the address area of consistent data in the process image.
In order to read and write consistent data you can also use the SFCs 14 and 15 If the address area of consistent data is outside the process image, you have to use the SFCs 14 and 15 to read and write consistent data. Direct access to consistent areas is also possible (e.g. L PEW or T PAW).	To read and write consistent data, you must use SFC14 and 15.	To read and write consistent data, you can also use SFC 14 and SFC 15. If the address area of consistent data is not in the process image, you must use SFC 14 and SFC 15 to read and write consistent data. Direct access to consistent areas is also possible (e.g. L PEW or T PAW):

A.1.9 Load memory design for the Technology CPU

Load memory design for the Technology CPU

On CPUs 312 IFM to 318-2 DP, the load memory is integrated into the CPU and may be extended with a memory card,

The load memory of the **Technology CPU** is located on the Micro Memory Card (MMC). and is retentive. When blocks are downloaded to the CPU, they are stored on the MMC and cannot be lost even in the event of a power failure or memory reset.

Note

User programs can only be downloaded and thus the CPU can only be used if the MMC is inserted.

A.1.10 PG/OP functions

PG/OP functions

With CPUs 315-2 DP (6ES7315-2AFx3-0AB0), 316-2DP and 318-2 DP, PG/OP functions at the DP interface were only possible if the interface was set to active. With CPUs 31xC/31x, these functions are possible at both active and passive interfaces. The performance of the passive interface is considerably lower, however.

A.1.11 Routing for the CPU 31xC/31x as an intelligent slave

Routing for the CPU 31xC/31x as an intelligent slave

If you use the CPU 31xC/31x as an intelligent slave, the routing function can only be used with an actively-configured DP interface.

In the properties of the DP interface in STEP 7, select the "Test, Commissioning, Routing" check box of the "DP-Slave" option.

A.1.12 Altered retentive response with a Technology CPU

Altered retentive response with a Technology CPU

With data blocks for the **Technology CPU**

- you can set the retentive response in the block properties of the DB.
- Using SFC 82 "CREA_DBL" -> Parameter ATTRIB, NON_RETAIN bit, you can specify if the actual values of a DB should be maintained at POWER OFF/ON or STOP-RUN (retentive DB) or if the start values should be read from the load memory (non-retentive DB).

A.1.13 FMs/CPs with their own MPI address in a Technology CPU central configuration

FMs/CPs with their own MPI address in a Technology CPU central configuration

Table A- 3 Behavior of FMs/CPs with their own MPI address

<p>All CPUs apart from CPU 315-2 PN/DP, CPU 315T- 2 DP, CPU 317, CPU 318-2 DP and CPU 319-3 PN/DP</p>	<p>CPU 315-2 PN/DP, CPU 315T-2 DP, CPU 317 ,CPU 318-2 DP and CPU 319-3 PN/DP</p>
<p>If there are FMs/CPs with their own MPI address in the central rack of an S7-300, then they are in the exact same CPU subnet as the CPU MPI stations.</p>	<p>If there are FMs/CPs with their own MPI address in the central rack of an S7-300, then the CPU forms its own communication bus via the backplane bus with these FMs/CPs, which are separated from the other subnets.</p> <p>The MPI address of such an FM/CP is no longer relevant for the stations on other subnets. The communication to the FM/CP is made via the MPI address of the CPU.</p>

When you replace your existing CPU with a Technology CPU, therefore,

- you must replace the existing CPU by the Technology CPU in the STEP 7 project,
- Reconfigure the OPs. you must re-assign the control and the destination address (= the MPI address of the Technology CPU and the slot of the respective FM)
- Reconfigure the project data for FM/CP to be loaded to the CPU.

This is necessary to ensure that the FM/CP can still be "addressed" by the OP/PG in this rack.

Glossary

ACCU

Accumulators represent CPU register and are used as buffer memory for download, transfer, comparison, calculation and conversion operations.

Address

An address represents the identifier of a specific operand or operand range. Examples: input I 12.1; flag word MW 25; data block DB 3.

Analog module

Analog modules convert analog process values (for example, temperature) into digital values that can be processed by the CPU, or convert digital values into analog manipulated variables.

Automation system

An automation system is a programmable controller for SIMATIC S7.

Back-up memory

The backup memory ensures buffering of the memory areas of a CPU without backup battery. It backs up a configurable number of timers, counters, flags and data bytes, the retentive timers, counters, flags and data bytes.

Baud rate

Speed of the data transmission (bps)

Bus

A transfer medium that interconnects several nodes. Data can be transferred via serial or parallel circuits, that is, via electrical or fiber optic conductors .

Bus segment

Self-contained part of a bus system. Bus segments are interconnected by way of repeaters, for example, in PROFIBUS DP.

Clock flag

Flag which can be used to generate clock pulses in the user program (1 flag byte).

Note

When operating with S7-300 CPUs, make sure that the clock flag byte is not overwritten in the user program!

Code block

A SIMATIC S7 code block contains elements of the STEP 7 user program. (In contrast to a data block: This contains only data.)

Cold restart

On CPU startup (e.g. after it is switched from STOP to RUN via the mode selector or with POWER ON), OB100 (restart) is initially executed, prior to cyclic program execution (OB1). On restart, the process input image is read in and the STEP 7 user program is executed, starting at the first command in OB1.

Configuration

Assignment of modules to racks/slots and (for example with signal modules) addresses.

Consistent data

Data that belongs together in terms of its content and must not be separated, is designated as consistent data.

As an example, the values of analog modules must always be treated as consistent data; i.e. the value of an analog module must not be corrupted by reading it out at two different times.

Counters

Counters are part of CPU system memory. The content of "counter cells" can be modified by STEP 7 statements (for example, up/down count.)

CPU

Central processing unit = CPU of the S7 automation system with a control and arithmetic unit, memory, operating system, and interface for the programming device.

Cycle time

The cycle time represents the time a CPU requires for one execution of the user program.

Cyclic interrupt

→ interrupt, cyclic interrupt

Data block

Data blocks (DB) are data areas in the user program and contain the user data. There are global data blocks which can be accessed by all code blocks, and instance data blocks which are assigned to a specific FB call.

Data, static

Static data are data that are used only within a function block. These data are stored in an instance data block belonging to the function block. Data stored in an instance data block are retained until the next function block call.

Data, temporary

Temporary data represent local data of a block. They are stored in the L-stack when the block is executed. After the block has been processed, these data are no longer available.

Diagnostic interrupt

Modules capable of diagnostics report detected system errors to the CPU by means of diagnostic interrupts.

Diagnostics

System diagnostics

Diagnostics buffer

The diagnostics buffer is a buffered memory area in the CPU. It stores diagnostic events in the order of their occurrence.

DP master

A master which behaves in accordance with EN 50170, Part 3 is known as a DP master.

DP slave

A slave operated on the PROFIBUS with PROFIBUS DP protocol and which behaves in accordance with EN 50170, Part 3 is referred to as DP slave.

DP(DRIVE)

PROFIBUS interface that is controlled by the integrated technology of the CPU isochronously (and therefore also equidistant).

DPV1

The designation DPV1 means extension of the functionality of the acyclical services (to include new interrupts, for example) provided by the DP protocol. The DPV1 functionality is integrated in IEC 61158 / EN 50170, Volume 2, PROFIBUS.

Engineering station

PC workplace, at which configuration work is performed on a control system.

Error display

One of the possible reactions of the operating system to a runtime error is to output an error message. The other possible reactions include: Error reaction in the user program, CPU in STOP.

Error handling via OB

After the operating system has detected a specific error (e.g. an access error with STEP 7), it calls a dedicated organization block (error OB) in which the subsequent behavior of the CPU can be defined.

Error reaction

Reaction to a runtime error. The operating system can react in the following ways: It sets the automation system to STOP, indicates the error, or calls an OB in which the user can program a reaction.

Execution level

Execution levels form the interface between the operating system of the CPU and the user program. The sequence for executing the blocks of the user program is specified in the execution levels.

Flag

Flags are part of the CPU's system memory. They store intermediate results of calculations. They can be accessed in bit, byte, word or double word operations.

Force

The force function can be used to assign fixed values to specific variables of a user program or CPU (also: inputs and outputs).

In this context, please note the limitations listed in the *Overview of the test functions section in the Test Functions, Diagnostics and Troubleshooting chapter in the S7-300 Installation manual.*

Function

According to IEC 1131-3, a function (FC) is a code block without static data. A function allows transfer of parameters in a user program. Functions are therefore suitable for programming frequently occurring complex functions, e.g. calculations.

Function block

According to IEC 1131-3, a function block (FB) is a code block with static data. An FB enables the transfer of parameters in the user program. Function blocks are therefore suitable for programming frequently occurring complex functions, e.g. controls, mode selections.

GD circuit

A GD circuit comprises a number of CPUs sharing data by means of global data communication, and is used as follows:

- A CPU sends a GD packet to the other CPUs.
- A CPU sends and receives a GD packet from another CPU.

A GD circuit is identified by a GD circuit number.

GD element

A GD element is generated by assigning shared global data. It is identified by a unique global data ID in the global data table.

GD packet

A GD packet can consist of one or more GD elements transmitted in a single message frame.

Global data

Global data can be addressed from any code block (FC, FB, OB). In particular, this refers to bit memory M, inputs I, outputs Q, timers, counters and data blocks DB. Global data can be accessed either absolutely or symbolically.

Global data communication

Global data communication is a method of transferring global data between CPUs (without CFBs).

GSD file

The device data file (GSD file) contains all slave-specific properties. The format of GSD files is specified in EN 50170, Volume 2, PROFIBUS.

Instance data block

The STEP 7 user program assigns an automatically generated DB to every call of a function block. The instance data block stores the values of input, output and in/out parameters, as well as local block data.

Integrated inputs/outputs for integrated technology

The Technology CPU has 4 digital inputs and 8 digital outputs integrated. You use these inputs and outputs for technology functions, e.g. reference point acquisition (BERO) or high-speed output cam switching signals. The integrated inputs and outputs can also be used with technology functions in the *STEP 7* user program.

Integrated technology

In addition to the standard PLC functions, the Technology CPU has been expanded with integrated technology functions. The operating system of the Technology CPU has also been expanded in order to guarantee fast processing times for these technology functions.

Intelligent DP slave

Signal preprocessing field device. One of its features is that the input/output range provided for the DP master does not correspond to an actually existing I/O, but an input/output range that is mapped by a preprocessing CPU.

Interrupt

The CPU's operating system knows different priority classes for controlling user program execution. These priority classes include interrupts, e.g. process interrupts. When an interrupt is triggered, the operating system automatically calls an assigned OB. In this OB the user can program the desired response (e.g. in an FB).

Interrupt, cyclic interrupt

A cyclic interrupt is generated periodically by the CPU in a configurable time pattern. A corresponding OB will be processed.

See also Organization Block

Interrupt, delay

The time-delay interrupt belongs to one of the priority classes in SIMATIC S7 program processing. It is generated on expiration of a time started in the user program. A corresponding OB will be processed.

Interrupt, diagnostic

→ diagnostics interrupt

Interrupt, process

→ process interrupt

Interrupt, status

A status interrupt can be generated by a DPV1 slave and causes OB 55 to be called on the DPV1 master. For detailed information on OB 55, see the *Reference Manual System software for S7-300/400: System and Standard Functions*.

Interrupt, time-of-day

The time-of-day interrupt is one of the priority classes in SIMATIC S7 program processing. SIMATIC S7. It is generated at a specific date (or daily) and time-of-day (e.g. 9:50 or hourly, or every minute). A corresponding OB will be processed.

Interrupt, update

An update interrupt can be generated by a DPV1 slave and causes OB56 to be called on the DPV1 master. For detailed information on OB56, see the *Reference Manual System software for S7-300/400: System and Standard Functions*.

Interrupt, vendor-specific

A vendor-specific interrupt can be generated by a DPV1 slave. It causes OB57 to be called on the DPV1 master.

For detailed information on OB 57, refer to the *Reference Manual System Software for S7-300/400: System and Standard Functions*.

Load memory

Load memory is part of the CPU. It contains objects generated by the programming device. It can be implemented either as a plug-in memory card or as integrated memory.

Local data

Data, temporary

Master

When a master is in possession of the token, it can send data to other nodes and request data from other nodes (= active node).

Micro memory card (MMC)

Micro memory cards are memory media for CPUs and CPs. When compared with a → memory card, a Micro Memory Card is smaller.

Module parameter

Module parameters are values with which the behavior of the module can be set. A distinction is made between static and dynamic module parameters.

MPI

The multi-point interface (MPI) is the SIMATIC S7 interface for programming devices. It allows simultaneous operation of several nodes (programming devices, text displays, operator panels) on one or more CPUs. Each node is identified by a unique address (MPI address).

Nesting depth

Using block calls, one block can be called from within another. Nesting depth is referred to as the number of simultaneously called code blocks.

OB priority

The CPU operating system distinguishes between different priority classes, for example, cyclic program execution, process interrupt controlled program processing. Each priority class is assigned organization blocks (OBs) in which the S7 user can program a response. Per default, OBs have different priorities and they are processed and interrupt each other according to their priority classes.

Operating mode

SIMATIC S7 automation systems know the following operating modes: STOP, STARTUP, RUN.

Operating system

The operating system of the CPU organizes all the functions and processes of the CPU that are not connected to a special control task.

→ CPU

Organization block

Organization blocks (OBs) form the interface between CPU operating system and the user program. The sequence for executing the user program is specified in the organization blocks.

Parameters

1. Variable of a STEP 7 code block
2. Variable for setting the response of a module (one or several per module). As delivered, each module has an appropriate default setting that can be changed via configuration in STEP 7. The parameters are divided into static and dynamic parameters.

Parameters, dynamic

In contrast to static parameters, the dynamic parameters of modules can be changed during operation by calling an SFC in the user program, for example limit values of an analog signal input module.

Parameters, static

Unlike dynamic parameters, static parameters of modules cannot be changed by the user program. You can only modify these parameters by editing your configuration in STEP 7, for example, modification of the input delay parameters of a digital signal input module.

Priority class

The S7 CPU operating system provides up to 26 priority classes (or "Program execution levels"). Specific OBs are assigned to these classes. The priority classes determine which OBs interrupt other OBs. Multiple OBs of the same priority class do not interrupt each other. In this case, they are executed sequentially.

Process image

The process image is a component of the system memory of the CPU. At the start of the cyclic program the signal states of the input modules are transferred to the process input image. At the end of the cyclic program the process output image is transferred as a signal state to the output modules.

Process interrupt

A process interrupt is triggered by interrupt-triggering modules as a result of a specific event in the process. The process interrupt is signaled to the CPU. The assigned organization block will be processed according to interrupt priority.

PROFIBUS DP

Digital, analog and intelligent modules, as well as a wide range of field devices in accordance with EN 50170, Part 3, such as drives or valve terminals are moved to the local process by the automation system across distances of up to 23 km.

The modules and field devices are interconnected with the automation system via the PROFIBUS DP field bus and are addressed in the same way as the centralized I/O.

Programming device

Programming devices are essentially personal computers suitable for industry that have a compact design and can be transported. Their distinguishing feature is the special hardware and software for SIMATIC programmable logic controllers.

RAM

RAM (Random Access Memory) is a semiconductor read/write memory.

Reduction factor

The reduction factor determines the send/receive frequency for GD packets on the basis of the CPU cycle.

Reference ground

→ Ground

Reference potential

Voltages of participating circuits are referenced to this potential when they are viewed and/or measured.

Retentive address areas

A memory area is considered retentive if its contents are retained even after a power loss and transitions from STOP to RUN. The non-retentive area of the flags, timers and counters is reset following a power failure and a transition from the STOP mode to the RUN mode.

Retentive can be the:

- Flag
- S7 timers
- S7 counters
- Data areas

Revision level

Differentiates products of the same order number. The product version is incremented when forward-compatible functions are enhanced, after production-related modifications (use of new parts/components) and for bug fixes.

Runtime error

Errors that occur during execution of the user program on the automation system (in other words, not in the process).

S7T Config

With S7T Config you configure the technology objects required to implement your motion control task. The STARTER for the drives from the MICROMASTER and SINAMICS families is integrated in S7T Config.

Segment

→ Bus segment

Shutdown

What happens during shutdown?

1. The control of the Technology CPU is already in STOP mode during shutdown. The outputs of the centralized and distributed I/Os are deactivated.
2. The integrated inputs/outputs for integrated technology and the ET 200M on the DP(DRIVE) are still active during shutdown.
3. The integrated technology of the Technology CPU shuts down the drives on the PROFIBUS DP(DRIVE) in a controlled manner.
4. The integrated technology of the CPU then also goes into STOP. The integrated inputs/outputs for integrated technology and the ET 200M on the DP(DRIVE) are deactivated.

The maximum duration of shutdown depends on your configuration in S7T Config.

Signal module

Signal modules (SMs) form the interface between the process and the automation system. There are digital input and output modules (input/output module, digital) and analog input and output modules (input/output module, analog).

Signal status list

The system status list contains data that describes the current status of an S7-300. You can always use this list to obtain an overview of:

- The configuration of the S7-300
- The current CPU configuration and configurable signal modules
- The current states and processes in the CPU and in configurable signal modules.

Slave

A slave can only exchange data with a master after being requested to do so by the master.

STARTUP

The STARTUP mode is executed at the transition from STOP to RUN mode. It can be triggered by means of the mode selector switch, or after power on, or by an operator action on the programming device. An S7-300 performs a restart.

STEP 7

Programming software for the creation of user programs for SIMATIC S7 controllers.

Substitute value

Substitute values are parameterizable values which output modules transfer to the process when the CPU switches to STOP mode.

In the event of an I/O access error, a substitute value can be written to the accumulator instead of the input value which could not be read (SFC 44).

System diagnostics

System diagnostics is the detection, evaluation, and indication of faults/errors which occur within the automation system. Examples of such error/faults are program errors or failures on modules. System errors can be indicated by LEDs or in STEP 7.

System function

A system function (SFC) is a function integrated in the operating system of the CPU that can be called when necessary in the STEP 7 user program.

System function block

A system function block (SFB) is a function block integrated in the operating system of the CPU that can be called when necessary in the STEP 7 user program.

System memory

System memory is an integrated RAM memory in the CPU. System memory contains the address areas (e.g. timers, counters, flags) and data areas that are required internally by the operating system (for example, communication buffers).

Technology configuration data

The configuration that you have created with *STEP 7* is stored in the technology configuration data.

Technology data block

The integrated technology provides current information on the status and on the values of the technology objects via the technology data blocks.

Technology objects

Technology objects are the logical representation of axes, output cams, measuring inputs, cams and external encoders, with which the drive components can be controlled. The technology objects configured with the *SIMATIC S7-Technology* option package contain definitions for the physical properties of the mechanical system, for limits, monitoring and control.

Technology system data

Technology system data are the data of the technology objects, such as drive axis, output cam, ...

Terminator

The terminating resistor is used to avoid reflections on data links.

Time-delay interrupt

→ interrupt, delay

Time-of-day interrupt

Interrupt, time-of-day

Timer

Timers

Timers

Timers are part of CPU system memory. The content of "timer cells" is automatically updated by the operating system, asynchronously to the user program. STEP 7 statements are used to define the precise function of the timer cell (for example, ON delay) and to initiate their execution (for example, start).

User memory

The user memory contains the code blocks and data blocks of the user program. User memory can be integrated in the CPU, or stored on plug-in memory cards or memory modules. However, the user program is principally processed from the work memory of the CPU.

User program

In SIMATIC, a distinction is made between the operating system of the CPU and user programs. The user program contains all the instructions, declarations and data for signal processing required to control a plant or a process. It is assigned to a programmable module (for example CPU or FM) and can be structured in smaller units (blocks).

→ operating system

→ STEP 7

Work memory

The work memory is integrated in the CPU and cannot be extended. It is used to run the code and process user program data. Programs run exclusively in work memory and system memory.

Index

5

5 VDC, 13, 20

A

Activation/deactivation, 73
Addressing, 18
ADI4
 Analog drive interface, 26
Alarm event, 73
Analog drive interface
 ADI4, 26
Analog drives, 26
Approvals
 Standards, 48
Area of application, 9
Availability
 S7 connection, 32
Axis configurations, 9

B

Basic knowledge
 Required, 4
BF1, 13, 21
BF3, 13, 21
Blocks
 Load, 39
Breakpoints, 20
Burst pulses, 49
Bus fault, 21
BUSF
 LED, 21
BUSF1
 LED, 21

C

Central processing unit, 16
Code block, 33
COMBIMASTER, 26
Commissioning, 19

Communication, 23
 Data consistency, 31
 S7 communication, 28
Communication path
 S7 connection, 32
Communication services, 27
Communication variable, 31
components
 S7-300, 16
Configuration, 15
 S7 communication, 32
Configuration data, 33
 Technology, 35
Configuring, 10
Connectable devices, 26
 PROFIBUS DP, 25
Connection
 Voltage supply, 13
Continuous shock, 53
Control, 18
Control tasks, 9
Counters, 34
CPU
 Elements, 11
 Operating system, 19
CPU memory reset, 39

D

Data block (DB), 33
 Non-retentive, 34
 Retentive, 34
 Retentive behavior, 36
Data consistency, 31
Definition
 Electromagnetic Compatibility, 49
Degree of protection IP 20, 54
Devices
 connectable, 25, 26
 non-connectable, 26
Diagnosis
 Address, 74
Diagnostics, 25
Documentation landscape
 Position, 4
DP interface error, 21

DP(DRIVE)
 OP, 17
 Programming device, 17
Drive interface
 analog, 26

E

Electromagnetic Compatibility, 49
Electrostatic discharge, 49
Elements
 CPU, 11
EMC, 49
Emission of radio interference, 50
Error display, 13, 20
 DP-capable CPUs, 21
ET 200M, 26

F

Field of application, 9
Flag, 34
Force function, 20
FRCE, 13, 20

G

General technical specifications, 48
Global data communication, 27

H

Hardware catalog, 26
Hardware configuration
 reuse, 75
Hardware interrupt
 Response time, 31

I

IM 174 interface for analog drives and stepper
motors, 26
Indicators, 11
Information
 SFCs, 72
Inputs and outputs for technology
 integrated, 12
Insulation test, 54
Integrated inputs and outputs for technology, 12

Integrated Inputs/Outputs for Technology
 Layout, 70
Integrated technology, 18
Interface, 10, 23
Isochronism, 17
Isochronous mode, 11, 25

J

Job data compartment, 41

L

Layout
 Integrated Inputs/Outputs for Technology, 70
LED, 21
 Display, 13
Load
 of blocks, 39
Load memory, 33
 Size, 33
Load memory design
 Technology-CPU, 76
Local data, 34, 38

M

MASTERDRIVES, 26
Mechanical environmental conditions, 52
Memory
 Retentive, 34, 35
Memory functions
 Download of blocks, 39
Memory module, 12
Memory objects
 Retentive behavior, 36
Micro memory card (MMC), 33
 Slot, 12
 Technical specifications, 47
MICROMASTER 4, 26
Migration
 Technology CPU, 71
Mode selector switch, 13
Module
 Start address, 18
Motion control, 9
Motion tasks, 9
MPI, 18
 Properties, 24
MPI / DP interface, 23
MRES, 13

N

Network gateway, 29
 Non-connectable devices, 26
 Non-retentive data block, 34
 Number of nodes, 18

O

OP
 on DP(DRIVE), 17
 OP communication, 27
 Operand area, 34, 37
 Operating mode, 13
 Operating system, 19
 Of the CPU, 19
 Technology, 19
 updating, 19
 Operator controls, 11
 Optional package
 S7-Technology, 19

P

PG
 on DP(DRIVE), 17
 PG communication, 27
 PLCopen, 9
 Position
 Documentation landscape, 4
 Power supply, 16
 Process image, 34
 Processing sequence
 Data block, 41, 45
 PROFIBUS cable, 16
 PROFIBUS DP, 25
 Connectable devices, 25
 Properties, 24
 PROFIBUS DP (DRIVE), 18
 PROFIBUS DP(DRIVE), 23, 25
 PROFIdrive, 25
 Program execution
 Runtime, 74
 Programming, 17
 Programming device cable, 16
 Properties
 MPI, 24
 PROFIBUS DP, 24
 Protection class, 54
 Pulseshaped disturbance,
 Purpose of this documentation, 3
 PUT/GET function, 31

R

Replacement of a Technology CPU, 75
 Required basic knowledge, 4
 Requirement
 Commissioning, 19
 Routing, 29
 Retentive address areas, 34
 Retentive behavior
 DB, 36
 Memory objects, 36
 Technology data block, 36
 Retentive data block, 34
 Retentive memory, 34, 35
 Retentivity, 35
 reuse
 Hardware configurations, 75
 Routing, 29
 Access to stations on other subnets, 28
 Example of an application, 30
 PG functions, 27
 Requirements, 29
 RUN, 13, 20
 Runtime
 Program execution, 74

S

S7 basic communication, 27
 S7 communication, 28
 Configuration, 32
 S7 connection
 Availability, 32
 Communication path, 32
 S7-300
 components, 16
 S7-Technology, 19
 Optional package, 19
 Scope
 Manual, 71
 SF, 21
 SFC
 Information, 72
 Shipping conditions, 51
 Shock, 53
 Shutdown, 14, 20
 Signal module, 16
 SIMATIC Micro Memory Card
 Plug-in MMCs, 47
 SIMODRIVE 611 universal, 26
 SIMODRIVE POSMO, 26
 SINAMICS, 26

Sinusoidal disturbance, 50

Size

Load memory, 33

Slot, 12

Micro memory card (MMC), 12

Standards and approvals, 48

Start address

Module, 18

Status display, 13, 20, 33

DP-capable CPUs, 21

Stepper, 26

Stepper motors, 26

STOP, 13, 20, 20

Storage conditions, 51

Subnets, 17

System memory, 34, 37

Local data, 38

Operand areas, 37

T

Technical specifications

Electromagnetic Compatibility, 49

Micro memory card (MMC), 47

Shipping and storage conditions, 51

Technological configurations, 9

Technological tasks, 9

Technology, 35

Configuration data, 35

Integrated inputs and outputs, 12

Operating system, 19

Technology CPU, 9

Technology CPU

Migration, 71

Technology, 9

Technology data block

Processing sequence, 41, 42, 43

Retentive behavior, 36

Technology DB

Retentive behavior, 36

Technology objects, 9

Technology system data, 33

Technology-CPU

Load memory design, 76

Temperature, 51

Test voltage, 54

TIA environment, 9

Timers, 34

Transmission rate, 17

U

Updating

Operating system, 19

V

Vibration, 53

Voltage supply

Connection, 13

W

Work memory, 34

X

X1, 23

X3, 23