

Information for the operator of the machine

9300 *0.37 ... 11 kW*

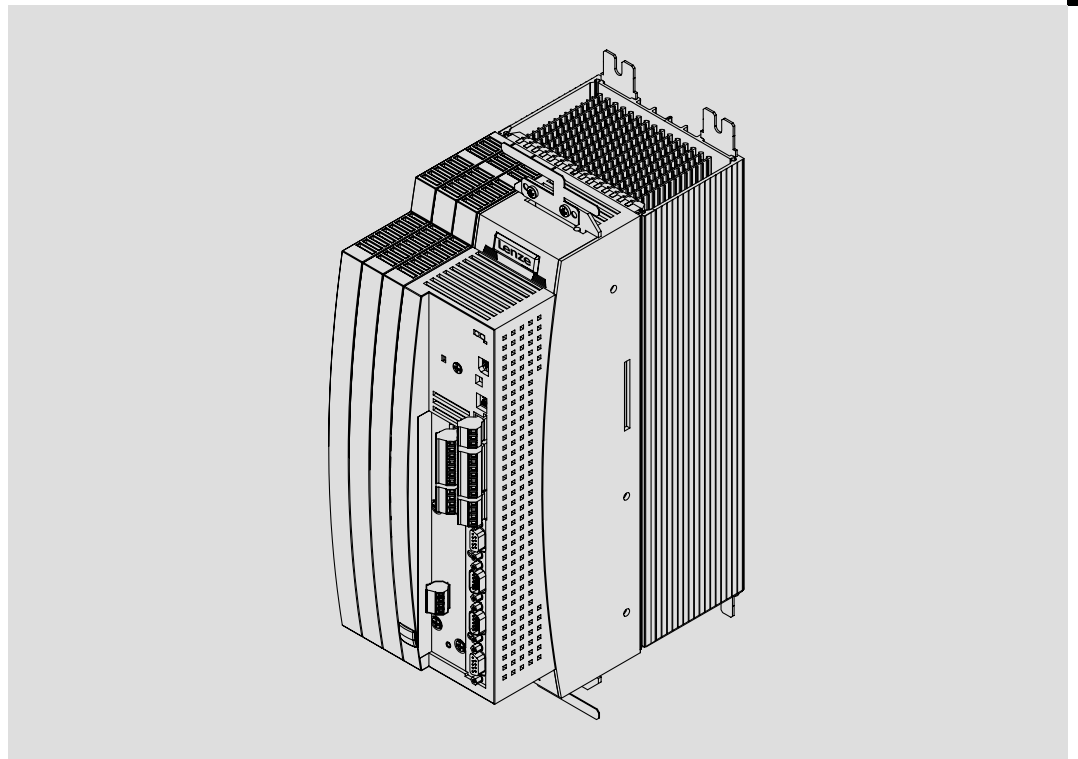

EVS9321-xx ... EVS9326-xx

Servo controller

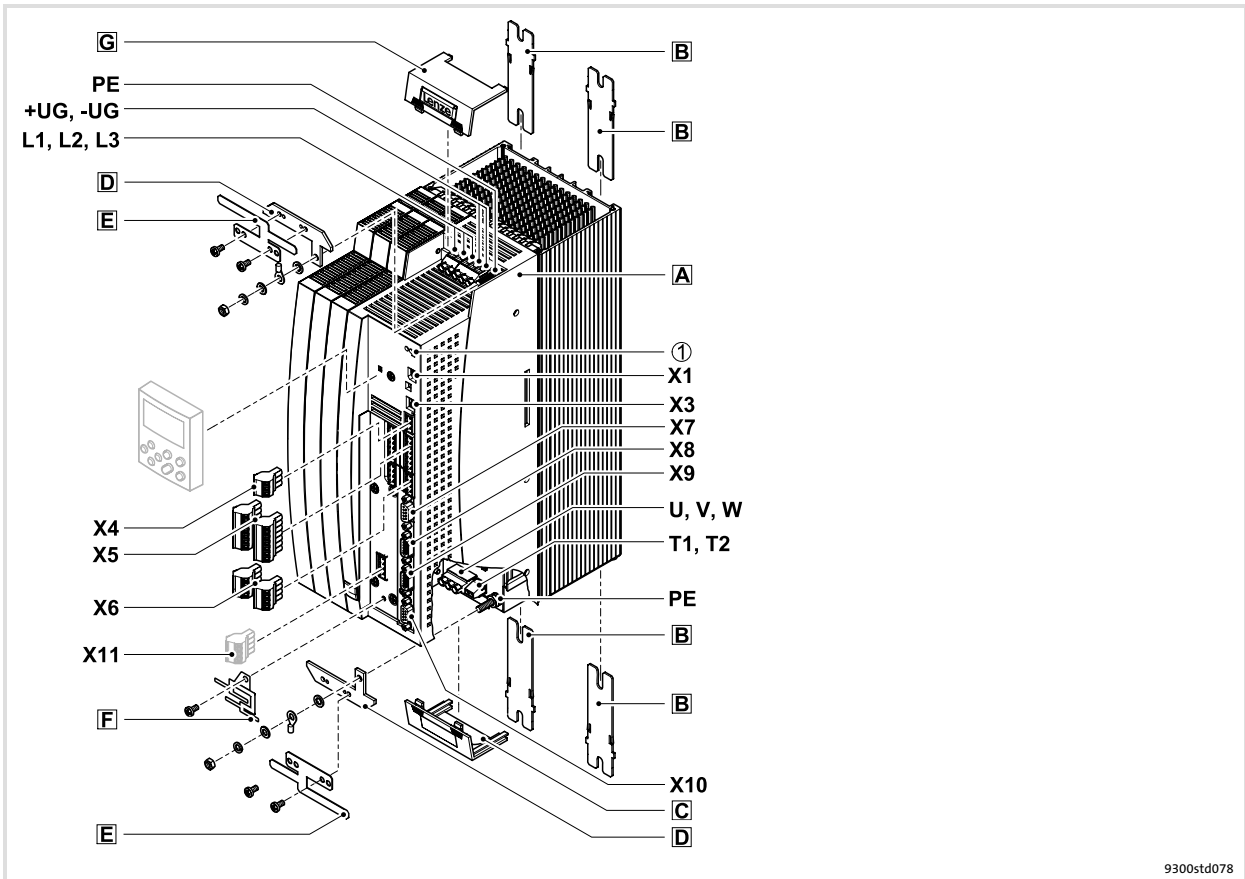

9300std078

Key for overview

Position	Description
A	Controller
B	Fixing rails for standard mounting
C	Cover for the motor connection
D	Shield connection support with fixing screws (2 items) 1 support for the shield sheet for the supply connections 1 support for the shield sheet for the motor cable
E	EMC shield sheet with fixing screws (2 items) 1 shield sheet for the supply connections 1 shield sheet for the motor cable and the feed cable for the motor temperature monitoring with PTC thermistor or thermal contact (NC contact)
F	EMC shield sheet with fixing screws for shielded control cables
G	Cover for the supply connections

Connections and interfaces

Position	Description
L1, L2, L3, PE	Mains connection
+UG, -UG	DC supply
U, V, W, PE	Motor connection
T1, T2	Connection of PTC thermistor or thermal contact (NC contact) of the motor
X1	AIF interface (automation interface) Slot for communication module (e. g. XT EMZ9371BC keypad)
X3	Jumper for setting analog input signal at X6/1, X6/2
X4	System bus (CAN) connection
X5	Connection of digital inputs and outputs
X6	Connection of analog inputs and outputs
X7	Connection of resolver and KTY temperature sensor of the motor
X8	Connection of incremental encoder with TTL level or SinCos encoder and KTY temperature sensor of the motor
X9	Connection of digital frequency input signal
X10	Connection of digital frequency output signal
X11	Connection of K _{SR} relay output for "safe standstill" (for variants V004 and V104 only)

Status displays

Position	LED red	LED green	Operating status
①	Off	On	Controller enabled
	On	On	Mains is switched on and automatic start is inhibited
	Off	Blinking slowly	Controller inhibited
	Blinking quickly	Off	Undervoltage or overvoltage
	Blinking slowly	Off	Active fault

1	About this documentation	5
1.1	Document history	5
1.2	Target group	5
1.3	Validity information	6
1.4	Conventions used	7
1.5	Notes used	8
2	Safety instructions	9
2.1	General safety and application notes for Lenze controllers	9
2.3	Thermal motor monitoring	13
2.3.1	Description	13
2.3.2	Parameter setting	14
2.4	Residual hazards	15
2.5	Safety instructions for the installation according to UL oder UR	16
3	Parameter setting	17
3.1	Parameter setting with the XT EMZ9371BC keypad	17
3.1.1	General data and operating conditions	17
3.1.2	Installation and commissioning	18
3.1.3	Display elements and function keys	18
3.1.4	Changing and saving parameters	20
3.1.5	Loading a parameter set	22
3.1.6	Transferring parameters to other standard devices	23
3.1.7	Activating password protection	25
3.1.8	Diagnostics	26
3.1.9	Menu structure	27
4	Troubleshooting and fault elimination	29
4.1	Display of operating data, diagnostics	29
4.2	Troubleshooting	30
4.2.1	Status display (LEDs on the controller)	30
4.2.2	Fault analysis with the history buffer	31
4.2.3	Fault analysis via LECOM status words (C0150/C0155)	32
4.3	System error messages	33
4.3.1	General error messages	33
4.3.2	Resetting system error messages	42

1 About this documentation



Note!

This documentation contains all necessary information for the machine operator to be able to operate the servo controllers of the 9300 series installed in your machine/plant.

You can make further use of all information in this documentation without consulting Lenze if you do not make any changes to the contents.

1.1 Document history

What is new / what has changed?

Material number	Version			Description
13330541	2.1	03/2010	TD23	Change of the company's address
13330541	2.0	03/2010	TD14	New edition due to reorganisation of the company UL-warnings updated Revision for software version 8x
13231631	1.0	11/2007	TD34	First edition



Tip!

Documentation and software updates for further Lenze products can be found on the Internet in the "Services & Downloads" area under <http://www.Lenze.com>

1.2 Target group

This documentation is intended for qualified personnel according to IEC 364.

Qualified, skilled personnel are persons who have the qualifications necessary for the work activities to be undertaken during the assembly, installation, commissioning, and operation of the product.

1 About this documentation

Validity information

1.3 Validity information



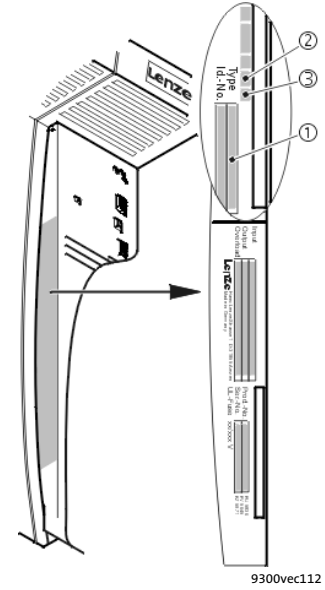

... 9300 servo controllers as of nameplate data:

	①	②	③	Nameplate																					
	EVS	93xx	- x x	Vxxx 1x 8x																					
Product series	EVS = Servo controller																								
Type no. / rated power	<table border="1"> <thead> <tr> <th></th> <th>400 V</th> <th>480 V</th> </tr> </thead> <tbody> <tr> <td>9321 =</td> <td>0.37 kW</td> <td>0.37 kW</td> </tr> <tr> <td>9322 =</td> <td>0.75 kW</td> <td>0.75 kW</td> </tr> <tr> <td>9323 =</td> <td>1.5 kW</td> <td>1.5 kW</td> </tr> <tr> <td>9324 =</td> <td>3.0 kW</td> <td>3.0 kW</td> </tr> <tr> <td>9325 =</td> <td>5.5 kW</td> <td>5.5 kW</td> </tr> <tr> <td>9326 =</td> <td>11 kW</td> <td>11 kW</td> </tr> </tbody> </table>					400 V	480 V	9321 =	0.37 kW	0.37 kW	9322 =	0.75 kW	0.75 kW	9323 =	1.5 kW	1.5 kW	9324 =	3.0 kW	3.0 kW	9325 =	5.5 kW	5.5 kW	9326 =	11 kW	11 kW
	400 V	480 V																							
9321 =	0.37 kW	0.37 kW																							
9322 =	0.75 kW	0.75 kW																							
9323 =	1.5 kW	1.5 kW																							
9324 =	3.0 kW	3.0 kW																							
9325 =	5.5 kW	5.5 kW																							
9326 =	11 kW	11 kW																							
Type	E = Panel-mounted unit C = Built-in unit in "cold plate" technique																								
Design	I = Servo PLC K = Servo cam P = Servo position controller R = Register controller S = Servo inverter T = Servo PLC technology																								
Variant	- Standard V003 = In "cold plate" technique V004 = With "safe standstill" function V100 = For IT mains V104 = With "safe standstill" function and for IT mains																								
Hardware version																									
Software version																									



1.4 Conventions used

This documentation uses the following conventions to distinguish between different types of information:

Type of information	Identification	Examples/notes
Spelling of numbers		
Decimal separator	language-dependent	In each case, the signs typical for the target language are used as decimal separators. For example: 1234.56 or 1234,56
Warnings		
UL warnings		Are only given in English.
UR warnings		
Text		
Program name	» «	PC software For example: »Engineer«
Icons		
Page reference		Reference to another page with additional information For instance:  16 = see page 16

1 About this documentation

Notes used

1.5 Notes used

The following pictographs and signal words are used in this documentation to indicate dangers and important information:

Safety instructions

Structure of safety instructions:





Danger!



(characterises the type and severity of danger)

Note



(describes the danger and gives information about how to prevent dangerous situations)

Pictograph and signal word	Meaning
 Danger!	Danger of personal injury through dangerous electrical voltage. Reference to an imminent danger that may result in death or serious personal injury if the corresponding measures are not taken.
 Danger!	Danger of personal injury through a general source of danger. Reference to an imminent danger that may result in death or serious personal injury if the corresponding measures are not taken.
 Stop!	Danger of property damage. Reference to a possible danger that may result in property damage if the corresponding measures are not taken.

Application notes

Pictograph and signal word	Meaning
 Note!	Important note to ensure troublefree operation
 Tip!	Useful tip for simple handling
	Reference to another documentation

Special safety instructions and application notes for UL and UR

Pictograph and signal word	Meaning
 Warnings!	Safety or application note for the operation of a UL-approved device in UL-approved systems. Possibly the drive system is not operated in compliance with UL if the corresponding measures are not taken.
 Warnings!	Safety or application note for the operation of a UR-approved device in UL-approved systems. Possibly the drive system is not operated in compliance with UL if the corresponding measures are not taken.

2 Safety instructions

2.1 General safety and application notes for Lenze controllers

(in accordance with Low-Voltage Directive 2006/95/EC)

For your personal safety

Disregarding the following safety measures can lead to severe injury to persons and damage to material:

- ▶ Only use the product as directed.
- ▶ Never commission the product in the event of visible damage.
- ▶ Never commission the product before assembly has been completed.
- ▶ Do not carry out any technical changes on the product.
- ▶ Only use the accessories approved for the product.
- ▶ Only use original spare parts from Lenze.
- ▶ Observe all regulations for the prevention of accidents, directives and laws applicable on site.
- ▶ Transport, installation, commissioning and maintenance work must only be carried out by qualified personnel.
 - Observe IEC 364 and CENELEC HD 384 or DIN VDE 0100 and IEC report 664 or DIN VDE 0110 and all national regulations for the prevention of accidents.
 - According to the basic safety information, qualified, skilled personnel are persons who are familiar with the assembly, installation, commissioning, and operation of the product and who have the qualifications necessary for their occupation.
- ▶ Observe all specifications in this documentation.
 - This is the condition for safe and trouble-free operation and the achievement of the specified product features.
 - The procedural notes and circuit details described in this documentation are only proposals. It is up to the user to check whether they can be transferred to the particular applications. Lenze Automation GmbH does not accept any liability for the suitability of the procedures and circuit proposals described.
- ▶ Lenze controllers (frequency inverters, servo inverters, DC speed controllers) and the accessory components can include live and rotating parts - depending on their type of protection - during operation. Surfaces can be hot.
 - Non-authorized removal of the required cover, inappropriate use, incorrect installation or operation create the risk of severe injury to persons or damage to material assets.
 - For more information, please see the documentation.
- ▶ High amounts of energy are produced in the controller. Therefore it is required to wear personal protective equipment (body protection, headgear, eye protection, ear protection, hand guard).

Application as directed

Controllers are components which are designed for installation in electrical systems or machines. They are not to be used as domestic appliances, but only for industrial purposes according to EN 61000-3-2.

When controllers are installed into machines, commissioning (i.e. starting of the operation as directed) is prohibited until it is proven that the machine complies with the regulations of the EC Directive 98/37/EC (Machinery Directive); EN 60204 must be observed.

Commissioning (i.e. starting of the operation as directed) is only allowed when there is compliance with the EMC Directive (2004/108/EC).

The controllers meet the requirements of the Low-Voltage Directive 2006/95/EC. The harmonised standard EN 61800-5-1 applies to the controllers.

The technical data and supply conditions can be obtained from the nameplate and the documentation. They must be strictly observed.

Warning: Controllers are products which can be installed in drive systems of category C2 according to EN 61800-3. These products can cause radio interferences in residential areas. In this case, special measures can be necessary.

Transport, storage

Please observe the notes on transport, storage, and appropriate handling.

Observe the climatic conditions according to the technical data.

Installation

The controllers must be installed and cooled according to the instructions given in the corresponding documentation.

The ambient air must not exceed degree of pollution 2 according to EN 61800-5-1.

Ensure proper handling and avoid excessive mechanical stress. Do not bend any components and do not change any insulation distances during transport or handling. Do not touch any electronic components and contacts.

Controllers contain electrostatically sensitive devices which can easily be damaged by inappropriate handling. Do not damage or destroy any electrical components since this might endanger your health!

Electrical connection

When working on live controllers, observe the applicable national regulations for the prevention of accidents (e.g. VBG 4).

The electrical installation must be carried out according to the appropriate regulations (e.g. cable cross-sections, fuses, PE connection). Additional information can be obtained from the documentation.

The documentation contains information on the installation according to EMC (shielding, earthing, arrangement of filters, and installation of the cables). Also observe this information with regard to drive controllers labelled with CE marking. The manufacturer of the system or machine is responsible for the compliance of the limit values required in connection with EMC legislation. In order to observe the limit values for radio interference emissions effective at the installation site, you have to mount the drive controllers into housings (e. g. control cabinets). The housings have to enable an EMC-compliant structure. Particularly observe that, for instance, control cabinet doors preferably are metallically connected to the housing in a circumferential manner. Reduce openings or apertures through the housing to a minimum.

Lenze controllers can cause a DC current in the PE conductor. If a residual current device (RCD) is used for the protection in the case of direct or indirect contact on a three-phase supplied controller, only one residual current device of type B is permissible on the current supply side of the controller. If the controller is supplied with one phase, also a residual current device (RCD) of type A may be used. Apart from the use of a residual current device (RCD) also other protective measures can be used, like for instance isolation from the environment by double or reinforced insulation or isolation from the supply system by a transformer.

Operation

If necessary, systems including controllers must be equipped with additional monitoring and protection devices according to the valid safety regulations (e.g. law on technical equipment, regulations for the prevention of accidents). The controllers can be adapted to your application. Please observe the corresponding information given in the documentation.

After the controller has been disconnected from the supply voltage, all live components and power connections must not be touched immediately because capacitors can still be charged. Please observe the corresponding stickers on the controller.

All protection covers and doors must be shut during operation.

Notes for UL-approved systems with integrated controllers: UL warnings are notes that only apply to UL systems. The documentation contains special UL notes.

Safety functions

Special controller variants support safety functions (e.g. "safe torque off", formerly "safe standstill") according to the requirements of appendix I No. 1.2.7 of the EC Directive "Machinery" 98/37/EC, EN 954-1 category 3 and EN 1037. Strictly observe the notes on the safety functions given in the documentation on the respective variants.

Maintenance and servicing

The controllers do not require any maintenance if the prescribed operating conditions are observed.

Disposal

Recycle metals and plastics. Dispose of printed circuit board assemblies according to the state of the art.

The product-specific safety and application notes given in these instructions must be observed!

2.2 Thermal motor monitoring

2.2.1 Description



Note!

From software version 8.0 onwards, the 9300 controllers are provided with an I^2xt function for sensorless thermal monitoring of the connected motor.

- ▶ I^2xt monitoring is based on a mathematical model which calculates a thermal motor utilisation from the detected motor currents.
- ▶ The calculated motor utilisation is saved when the mains is switched off.
- ▶ The function is UL-certified, i.e. additional protective measures for the motor are not required in UL-approved systems.
- ▶ Nevertheless, I^2xt monitoring does **not** provide full motor protection because other influences on the motor utilisation such as changes in the cooling conditions (e.g. cooling air flow interrupted or too warm) cannot be detected.

The $I^2 \times t$ -load of the motor is constantly calculated by the drive controller and displayed in C0066.

The $I^2 \times t$ -monitoring is designed in a way, that a motor with a thermal motor time factor of 5 min, a motor current of $1.5 \times I_r$ and a trigger threshold of 100 % releases the monitoring after 179 s.

You can set different reactions with two adjustable trigger thresholds.

- ▶ Adjustable reaction OC8 (TRIP, Warning, Off).
 - The reaction is set in C0606.
 - The trigger threshold is set in C0127.
 - The reaction OC8 can be used for example for an advance warning.
- ▶ Fixed reaction OC6-TRIP.
 - The trigger threshold is set in C0120.

Response of the $I^2 \times t$ -monitoring	Condition
The $I^2 \times t$ -monitoring is deactivated. C0066 = 0 % and MCTRL-LOAD-I2XT = 0,00 % is set.	Set the controller inhibit at C0120 = 0 % and C0127 = 0 %.
The $I^2 \times t$ -monitoring is stopped. The actual value in C0066 and at the MCTRL-LOAD-I2XT output is held.	Allow controller release at C0120 = 0 % and C0127 = 0 %.
The $I^2 \times t$ -monitoring is deactivated. The motor load is displayed in C0066.	Set C0606 = 3 (Off) and C0127 > 0 %.



Note!

An OC6 or OC8 error message can only be reset if the $I^2 \times t$ -monitoring has fallen below the set trigger threshold by 5 %.

2.2.2

Parameter setting

Parameter setting			
Code	Meaning	Value range	Lenze setting
C0066	Display of the I ² t utilisation of the motor	0 ... 250 %	-
C0120	Threshold: Triggering of an "OC6" error	0 ... 120 %	0 %
C0127	Threshold: Triggering of an "OC8" error	0 ... 120 %	0 %
C0128	Thermal time constant of the motor	0.1 ... 50.0 min	5.0 min
C0606	Response to "OC8" error	Trip, warning, off	Warning

Calculating the release time

$$t = - (C0128) \cdot \ln \left[1 - \frac{y + 1}{\left(\frac{I_M}{I_r}\right)^2 \cdot 100} \right]$$

I_M Actual motor current

I_r Rated motor current

y C0120 or C0127

- The thermal capacity of the motor is expressed by the thermal motor time factor (C0128). Please see the rated data of the motor for the value or ask the manufacturer of the motor.

Reading the release time off the diagram

Diagram for the determination of the release times of a motor with a thermal motor time factor of 5 min:

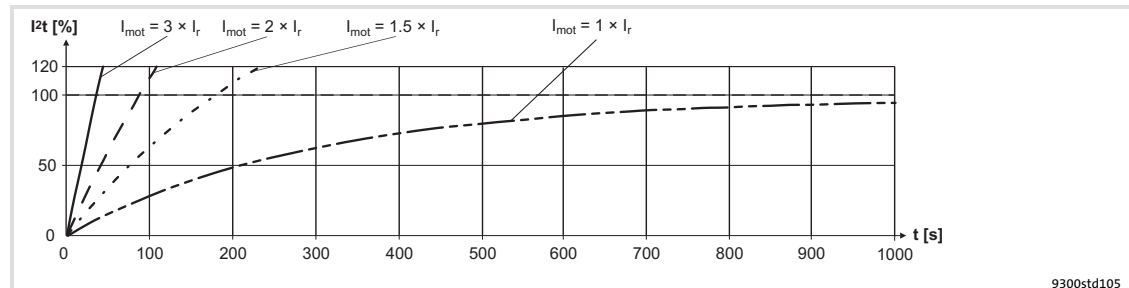

Fig. 2-1 I² × t-monitoring: Release times for different motor currents and trigger thresholds

I_{mot}	Motor current
I_r	Rated motor current
I^2t	I ² t load
T	Time

2.3 Residual hazards

Protection of persons

- ▶ Before working on the controller, check whether all power terminals are deenergised:
 - The power terminals U, V, W, +U_G and -U_G remain live for at least three minutes after disconnection from the mains.
 - The power terminals L1, L2, L3; U, V, W, +U_G and -U_G remain live when the motor is stopped.
- ▶ The leakage current to earth (PE) is > 3.5 mA. According to EN 50178
 - a fixed installation is required.
 - a double PE connection is required or, if in single design, it must have a cable cross-section of at least 10 mm².
- ▶ The heatsink of the controller has an operating temperature of > 80 °C:
 - Contact with the heatsink results in burns.
- ▶ During parameter set transfer the control terminals of the controller can have undefined states.
 - Therefore the connectors X5 and X6 must be disconnected from the controller before the transfer takes place. This ensures that the controller is inhibited and all control terminals have the defined state "LOW".

Device protection

- ▶ Frequent mains switching (e.g. inching mode via mains contactor) can overload and destroy the input current limitation of the drive controller:
 - At least 3 minutes must pass between switching off and restarting the devices EVS9321-xx and EVS9322-xx.
 - At least 3 minutes must pass between two starting procedures of the devices EVS9323-xx ... EVS9332-xx.
 - Use the "safe torque off" safety function (STO) if safety-related mains disconnections occur frequently. The drive variants Vxx4 are equipped with this function.

Protection of the machine/system

- ▶ Drives can reach dangerous overspeeds (e. g. setting of high output frequencies in connection with motors and machines not suitable for this purpose):
 - The drive controllers do not provide protection against such operating conditions. For this purpose, use additional components.

**Warnings!**

- ▶ **Motor Overload Protection**
 - For information on the protection level of the internal overload protection for a motor load, see the corresponding manuals or software helps.
 - If the integral solid state motor overload protection is not used, external or remote overload protection must be provided.
- ▶ **Branch Circuit Protection**
 - The integral solid state protection does not provide branch circuit protection.
 - Branch circuit protection has to be provided externally in accordance with corresponding instructions, the National Electrical Code and any additional codes.
- ▶ Please observe the specifications for fuses and screw-tightening torques in these instructions.
- ▶ **EVS9321 ... EVS9326:**
 - Suitable for use on a circuit capable of delivering not more than 5000 rms symmetrical amperes, 480 V maximum, when protected by fuses.
 - Suitable for use on a circuit capable of delivering not more than 50000 rms symmetrical amperes, 480 V maximum, when protected by CC, J, T or R class fuses.
 - Maximum surrounding air temperature: 0 ... +55 °C
 - > +40 °C: reduce the rated output current by 2.5 %/°C
 - Use 75 °C copper wire only.

3 Parameter setting

3.1 Parameter setting with the XT EMZ9371BC keypad

Description

The keypad is available as an accessory. A full description of the keypad can be obtained from the Instructions included in the keypad delivery.

Plugging in the keypad

It is possible to plug the keypad into the AIF interface or remove it during operation.

As soon as the keypad is supplied with voltage, it carries out a self-test. The keypad is ready for operation if it is in display mode.

3.1.1 General data and operating conditions

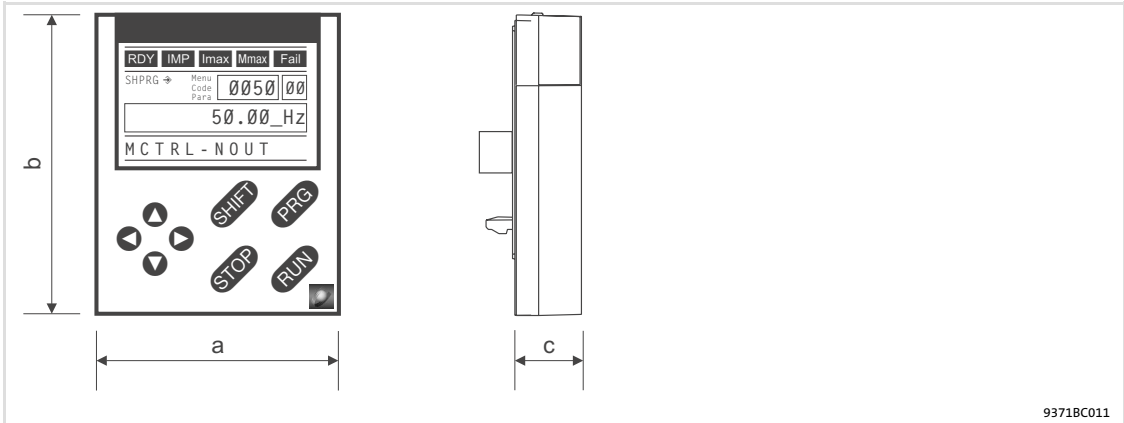

9371BC011

Feature	Values	
Dimensions		
Width	a	60 mm
Height	b	73.5 mm
Depth	c	15 mm
Environmental conditions		
Climate		
Storage	IEC/EN 60721-3-1	1K3 (-25 ... +60 °C)
Transport	IEC/EN 60721-3-2	2K3 (-25 ... +70 °C)
Operation	IEC/EN 60721-3-3	3K3 (-10 ... +60 °C)
Enclosure	IP 20	

3

Parameter setting

Parameter setting with the XT EMZ9371BC keypad Installation and commissioning

3.1.2

Installation and commissioning

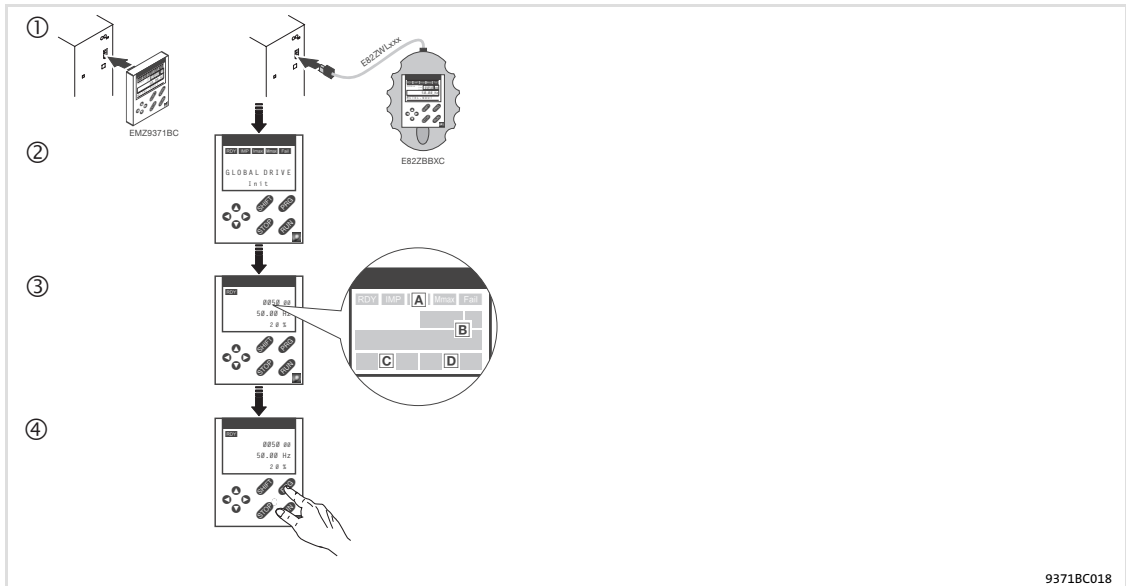

Fig. 3-1 Installation and commissioning of XT EMZ9371BC keypad or E82ZBBXC diagnosis terminal

- ① Connect keypad to the AIF interface on the front of the standard device.
The keypad can be connected/disconnected during operation.
- ② As soon as the keypad is supplied with voltage, it carries out a short self-test.
- ③ The operation level indicates when the keypad is ready for operation:
 - A Current state of the standard device
 - B Memory location 1 of the user menu (C0517):
Code number, subcode number, and current value
 - C Active fault message or additional status message
 - D Actual value in % of the status display defined in C0004
- ④ **PRG** must be pressed to leave the operation level

3.1.3

Display elements and function keys

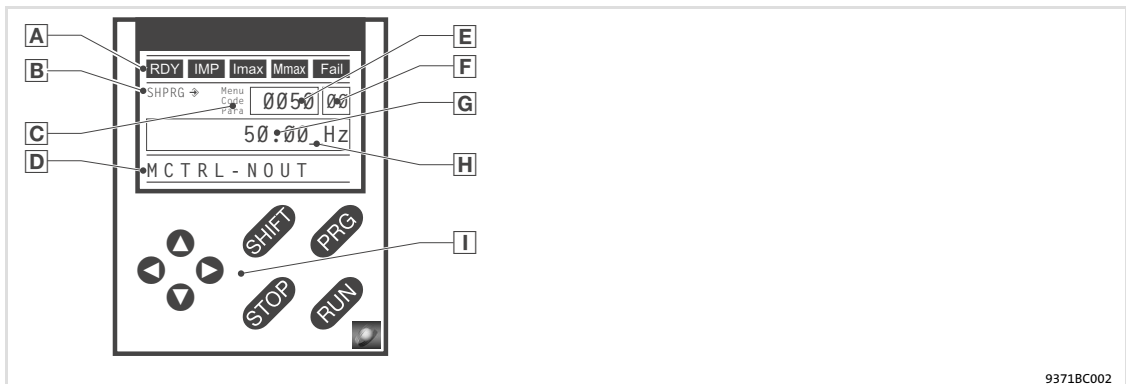

Fig. 3-2 Display elements and function keys of the XT EMZ9371BC keypad

Displays

A Status displays of standard device		
Display	Meaning	Explanation
RDY	Ready for operation	

Parameter setting with the XT EMZ9371BC keypad Display elements and function keys

IMP	Pulse inhibit is active	Power outputs are inhibited
Imax	The set current limit is exceeded in motor or generator mode	
Mmax	Speed controller 1 in the limitation	Drive is torque-controlled (Only active for operation with standard devices of the 9300 series)
Fall	Active fault	
B Acceptance of the parameters		
Display	Meaning	Explanation
↔	Parameter is accepted immediately	Standard device operates immediately with the new parameter value
SHPRG ↔	Parameter must be acknowledged with SHIFT PRG	Standard device operates with the new parameter value after being acknowledged
SHPRG	Parameter must be acknowledged in case of controller inhibit SHIFT PRG	Standard device operates with the new parameter value after the controller is enabled again
None	Display parameter	Change is not possible
C Active level		
Display	Meaning	Explanation
Menu	Menu level is active	Select main menu and submenus
Code	Code level is active	Select codes and subcodes
Para	Parameter level is active	Change parameters in the codes or subcodes
None	Operating level is active	Display operating parameters
D Short text		
Display	Meaning	Explanation
alphanumeric	Contents of the menus, meaning of the codes and parameters In the operating level display of C0004 in % and the active fault	
E Number		
Active level	Meaning	Explanation
Menu level	Menu number	Display is only active for operation with standard devices of the 8200 vector or 8200 motec series
Code level	Four-digit code number	
F Number		
Active level	Meaning	Explanation
Menu level	Submenu number	Display is only active for operation with standard devices of the 8200 vector or 8200 motec series
Code level	Two-digit subcode number	
G Parameter value		
	Parameter value with unit	
H Cursor		
	In the parameter level, the digit above the cursor can be directly changed	
I Function keys		
	For description see the following table	

Parameter setting

Parameter setting with the XT EMZ9371BC keypad
Changing and saving parameters

Function keys



Note!

Shortcuts with **SHIFT**:

Press and hold **SHIFT**, then press the second key in addition.

Key	Function			
	Menu level	Code level	Parameter level	Operating level
PRG		Change to the parameter level	Change to the operating level	Change to the code level
SHIFT PRG	Go to the "Short setup" menu and load predefined configurations ¹⁾		Accept parameters when SHPRG ⇌ or SHPRG is displayed	
▲ ▼	Change between menu items	Change of code number	Change of digit via cursor	
SHIFT ▲ SHIFT ▼	Quick change between menu items	Quick change of code number	Quick change of digit via cursor	
▶ ◀	Change between main menu, submenu and code level		Cursor to the right Cursor to the left	
RUN	Deactivate the function of the key STOP , the LED in the key goes off			
STOP	Inhibit the controller, the LED in the key is lit. Reset fault (TRIP-Reset): 1. Remove the cause of malfunction 2. Press STOP 3. Press RUN			

¹⁾ Only active for operation with standard devices of the 8200 vector or 8200 motec series

3.1.4

Changing and saving parameters



Note!

Your settings have an effect on the current parameters in the main memory. You must save your settings in a parameter set so that they are not lost when the mains are connected.

If you only need one parameter set, save your settings as parameter set 1, since parameter set 1 is loaded automatically after mains connection.

Step	Key sequence	Action
1. Select the menu	▲ ▼ ▶ ◀	Use the arrow keys to select the desired menu
2. Change to the code level	▶	Display of the first code in the menu
3. Select code or subcode	▼ ▲	Display of the current parameter value
4. Change to the parameter level	PRG	
5. When SHPRG is displayed, inhibit the controller	STOP ¹⁾	The drive coasts
6. Change parameter	A ▶ ◀	Move cursor below the digit to be changed
	B ▼ ▲	Change of digit
	SHIFT ▼	Quick change of digit
	SHIFT ▲	
7. Accept the changed parameter		

Parameter setting with the XT EMZ9371BC keypad Changing and saving parameters

Step		Key sequence	Action
	Display of SHPRG or SHPRG →	SHIFT PRG	Confirm change to accept the parameter Display "OK"
	Display →	-	The parameter has been accepted immediately
8.	Enable the controller, if required	RUN 1)	The drive runs again
9.	Change to the code level		
	A	PRG	Display of the operating level
	B	PRG	Display of the code with changed parameter
10.	Change further parameters		Restart the "loop" with step 1. or 3.
11.	Save changed parameters		
	A	▲ ▼ ▶ ◀	Select the code C0003 "PAR SAVE" in the menu "Load/Store"
	B	PRG	Change to the parameter level Display "0" and "READY"
	C	▲	Save as parameter set 1: ⇒ Set "1" "Save PS1" Save as parameter set 2: ⇒ Set "2" "Save PS2" Save as parameter set 3: ⇒ Set "3" "Save PS3" Save as parameter set 4: ⇒ Set "4" "Save PS4"
	D	SHIFT PRG	When "OK" is displayed, the settings are permanently saved in the selected parameter set.
12.	Change to the code level		
	A	PRG	Display of the operating level
	B	PRG	Display of C0003 "PAR SAVE"
13.	Set parameters for another parameter set		Restart the "loop" with step 1. or 3.

- 1) The function of the STOP key can be programmed:
C0469 = 1: Controller inhibit
C0469 = 2: Quick stop (Lenze setting)

Parameter setting

Parameter setting with the XT EMZ9371BC keypad
Loading a parameter set

3.1.5 Loading a parameter set

The keypad serves to load a saved parameter set into the main memory when the controller is inhibited. After the controller is enabled, it operates with the new parameters.



Danger!

- ▶ When a new parameter set is loaded, the controller is reinitialised and acts as if it had been connected to the mains:
 - System configurations and terminal assignments can be changed. Make sure that your wiring and drive configuration comply with the settings of the parameter set.
- ▶ Only use terminal X5/28 as source for the controller inhibit! Otherwise the drive may start in an uncontrolled way when switching over to another parameter set.



Note!

- ▶ After switching on the supply voltage, the controller always loads parameter set 1 into the main memory.
- ▶ It is also possible to load other parameter sets into the main memory via the digital inputs or bus commands.

Step		Key sequence	Action
1.	Inhibit controller		Terminal X5/28 = LOW
2.	Load the saved parameter set into the main memory		
		A ▲ ▼ ▶ ◀	Select the code C0002 "PAR LOAD" in the menu "Load/Store"
		B PRG	Change to the parameter level The active parameter set is displayed, e. g. display "0" and "Load Default" If you want to restore the delivery status, proceed with D
	Select the parameter set to be loaded	C ▲	Load parameter set 1: ⇒ Set "1" "Load PS1" Load parameter set 2: ⇒ Set "2" "Load PS2" Load parameter set 3: ⇒ Set "3" "Load PS3" Load parameter set 4: ⇒ Set "4" "Load PS4"
		D SHIFT PRG	"RDY" goes off. The parameter set is loaded completely into the main memory if "RDY" is displayed again.
3.	Change to the code level		
		A PRG	Display of the operating level
		B PRG	Display of C0002 "PAR LOAD"
4.	Enable controller		Terminal X5/28 = HIGH The drive is running with the settings of the loaded parameter set

3.1.6 Transferring parameters to other standard devices

Parameter settings can be easily copied from one standard device to another by using the keypad.

For this purpose use the "Load/Store" menu



Danger!

During the parameter transfer from the keypad to the standard device the control terminals can adopt undefined states!

Therefore the plugs X5 and X6 must be disconnected from the standard device before the transfer takes place. This ensures that the controller is inhibited and all control terminals have the defined state "LOW".

Copying parameter sets from the standard device into the keypad



Note!

After copying the parameter sets into the XT keypad (C0003 = 11), always the parameter set that was loaded last via C0002 is activated.

Like this the current parameters also remain active after copying:

- ▶ Save the current parameters in the parameter set before copying and load this parameter set in the controller via C0002.

Step	Key sequence	Action
1.	Connect the keypad to standard device 1	
2.	Inhibit controller	Terminal X5/28 = LOW The drive coasts.
3.	Select C0003 in the "Load/Store" menu	◀ ▶ ◀ ▶ ◀ ▶ ◀ ▶ Select code C0003 "PAR SAVE" in the "Load/Store" menu using the arrow keys.
4.	Change to the parameter level	PRG Display "0" and "READY"
5.	Copy all parameter set into the keypad	The settings saved in the keypad are overwritten. ▶ Set "11" "Save extern"
6.	Start copying	SHIF PRG The "RDY" status display goes off. As parameter value "BUSY" is displayed. If "BUSY" goes off after approx. one minute, all parameter sets were copied into the keypad. The "RDY" status display is lit.
7.	Change to the code level	A PRG B PRG Display of the operating level Display C0003 and "PAR SAVE"
8.	Enable controller	Terminal X5/28 = HIGH
9.	Remove keypad from standard device 1	

Parameter setting

Parameter setting with the XT EMZ9371BC keypad
Transferring parameters to other standard devices

Copying parameter sets fom keypad into the standard device

Step	Key sequence	Action
1.		Connect the keypad to standard device 2
2.		Inhibit controller Terminal X5/28 = LOW The "IMP" status display is lit. The drive coasts
3.		Pull the plugs X5 and X6 All control terminals have the defined "LOW" status.
4.	◀ ▶ ⏪ ⏩	Select C0002 in the "Load/Store" menu Select code C0002 "PAR LOAD" in the "Load/Store" menu using the arrow keys.
5.	PRG	Change to the parameter level The active parameter set is shown, e. g. display "0" and "Load Default"
6.		Select the correct copy function The settings saved in the standard device are overwritten.
		<ul style="list-style-type: none"> Copy all parameter sets available into the EEPROM of the standard device and save them permanently. The parameter set that was active before copying is overwritten. The parameters are not yet active after copying. Select parameter set and load it in the main memory. 22
	◀	Set "20" "ext -> EEPROM"
		<ul style="list-style-type: none"> Copy individual parameter sets into the main memory of the standard device.
	◀	Copy parameter set 1 into the main memory: Set ⇒ "11" "Load ext PS1"
		Copy parameter set 2 into the main memory: Set ⇒ "12" "Load ext PS2"
		Copy parameter set 3 into the main memory: Set ⇒ "13" "Load ext PS3"
		Copy parameter set 4 into the main memory: Set ⇒ "14" "Load ext PS4"
7.	SHIFT PRG	Start copying The "RDY" status display goes off. As parameter value "BUSY" is displayed. If "BUSY" goes off, the parameter sets selected were copied into the standard device. The "RDY" status display is lit.
8.		Change to the code level
	A PRG	Display of the operating level
	B PRG	Display C0002 and "PAR LOAD"
9.	◀ ▶ ⏪ ⏩	<ul style="list-style-type: none"> If the function "Copy all parameter sets into the EEPROM" (C0002 = 20) is selected, they might have to be loaded in the main memory manually. If the function "Copy individual parameter sets into the main memory" (C0002 = 1x) is selected, they might have to be saved permanently in the EEPROM manually.
10.		Plug in plugs X5 and X6
11.		Enable controller Terminal X5/28 = HIGH The drive is running with the new settings.

3.1.7 Activating password protection



Note!

- ▶ If the password protection is activated (C0094 = 1 ... 9999), you only have free access to the user menu.
- ▶ To access the other menus, you must enter the password. By this, the password protection is annulled until you enter a new password.
- ▶ Please observe that the password-protected parameters can be overwritten as well when transferring the parameter sets to other standard devices. The password is not transferred.
- ▶ Do not forget your password! If you have forgotten your password, it can only be reset via a PC or a bus system!

Activate password protection

Step	Key sequence	Action
1. Select the "USER menu"	⬅ ➡ ⬆ ⬇	Change to the user menu using the arrow keys
2. Change to the code level	➡	Display of code C0051 "MCTRL-NACT"
3. Select C0094	⬆	Display of code C0094 "Password"
4. Change to the parameter level	PRG	Display "0" = no password protection
5. Set password	A ⬆	Select password (1 ... 9999)
	B SHIFT PRG	Confirm password
6. Change to the code level	A PRG	Display of the operating level
	B PRG	Display of C0094 and "Password"
7. Change to the "USER menu"	⬅ ⬆ ⬇	

The password protection is active now.

You can only quit the user menu if you re-enter the password and confirm it with SHIFT PRG.

Remove password protection

Step	Key sequence	Action
1. Change to the code level in the user menu	➡	
2. Select C0094	⬆	Display of code C0094 "Password"
3. Change to the parameter level	PRG	Display "9999" = password protection is active
4. Enter password	A ⬆	Set valid password
	B SHIFT PRG	Confirm The password protection is deactivated by entering the password once again.
5. Change to the code level	A PRG	Display of the operating level
	B PRG	Display of C0094 and "Password"

The password protection is deactivated now. All menus can be freely accessed again.

3.1.8 Diagnostics

In the "Diagnostic" menu the two submenus "Actual info" and "History" contain all codes for

- ▶ monitoring the drive
- ▶ fault/error diagnosis

In the operating level, more status messages are displayed. If several status messages are active, the message with the highest priority is displayed.

Priority	Display	Meaning
1	GLOBAL DRIVE INIT	Initialisation or communication error between keypad and controller
2	XXX - TRIP	Active TRIP (contents of C0168/1)
3	XXX - MESSAGE	Active message (contents of C0168/1)
4	Special device states:	
		Switch-on inhibit
5	Source for controller inhibit (the value of C0004 is displayed simultaneously):	
	STP1	9300 servo: Terminal X5/28 ECSxS/P/M/A: Terminal X6/SI1
	STP3	Operating module or LECOM A/B/LI
	STP4	INTERBUS or PROFIBUS-DP
	STP5	9300 servo, ECSxA/E: System bus (CAN) ECSxS/P/M: MotionBus (CAN)
	STP6	C0040
6	Source for quick stop (QSP):	
	QSP-term-Ext	The MCTRL-QSP input of the MCTRL function block is on HIGH signal.
	QSP-C0135	Operating module or LECOM A/B/LI
	QSP-AIF	INTERBUS or PROFIBUS-DP
	QSP-CAN	9300 servo, ECSxA: System bus (CAN) ECSxS/P/M: MotionBus (CAN)
7	XXX - WARNING	Active warning (contents of C0168/1)
8	xxxx	Value below C0004

3.1.9 Menu structure

For simple, user-friendly operation, the codes are clearly arranged in function-related menus:

Main menu	Submenus	Description
Display	Display	
User-Menu		Codes defined in C0517
Code list		All available codes
	ALL	All available codes listed in ascending order (C0001 ... C7999)
	PS 1	Codes in parameter set 1 (C0001 ... C1999)
	PS 2	Codes in parameter set 2 (C2001 ... C3999)
	PS 3	Codes in parameter set 3 (C4001 ... C5999)
	PS 4	Codes in parameter set 4 (C6001 ... C7999)
Load/Store		Parameter set management Parameter set transfer, restore delivery status
Diagnostic		Diagnostic
	Actual info	Display codes to monitor the drive
	History	Fault analysis with history buffer
Short setup		Quick configuration of predefined applications Configuration of the user menu The predefined applications depend on the type of the standard device (frequency inverter, servo inverter, position controller, ...)
Main FB		Configuration of the main function blocks
	NSET	Setpoint processing
	NSET-JOG	Fixed setpoints
	NSET-RAMP1	Ramp function generator
	MCTRL	Motor control
	DFSET	Digital frequency processing
	DCTRL	Internal control
Terminal I/O		Connection of inputs and outputs with internal signals
	AIN1 X6.1/2	Analog input 1
	AIN2 X6.3/4	Analog input 2
	AOUT1 X6.62	Analog output 1
	AOUT2 X6.63	Analog output 2
	DIGIN	Digital inputs
	DIGOUT	Digital outputs
	DFIN	Digital frequency input
	DFOUT	Digital frequency output
	State bus	State bus (not with 9300 frequency inverter)
Controller		Configuration of internal control parameters
	Speed	Speed controller
	Current	Current controller or torque controller
	Phase	Phase controller (not with 9300 frequency inverter)
Motor/Feedb.		Input of motor data, configuration of speed feedback
	Motor adj	Motor data
	Feedback	Configuration of feedback systems
Monitoring		Configuration of monitoring functions

Parameter setting

Parameter setting with the XT EMZ9371BC keypad
Menu structure

Main menu	Submenus	Description
Display	Display	
LECOM/AIF		Configuration of operation with communication modules
	LECOM A/B	Serial interface
	AIF interface	Process data
	Status word	Display of status words
System bus		Configuration of system bus (CAN)
	Management	CAN communication parameters
	CAN-IN1	CAN object 1
	CAN-OUT1	
	CAN-IN2	CAN object 2
	CAN-OUT2	
	CAN-IN3	CAN object 3
	CAN-OUT3	
	Status word	Display of status words
	FDO	Free digital outputs
	Diagnostic	CAN diagnostic
FB config		Configuration of function blocks
Func blocks		Parameterisation of function blocks The submenus contain all available function blocks
FCODE		Configuration of free codes
Identify		Identification
	Drive	Software version of standard device
	Op Keypad	Software version of keypad

4 Troubleshooting and fault elimination

4.1 Display of operating data, diagnostics

The dialog box displays important operating parameters and supports you in diagnosing the drive controller.

- ▶ Open the **Diagnostics** dialog box in the parameter menu.

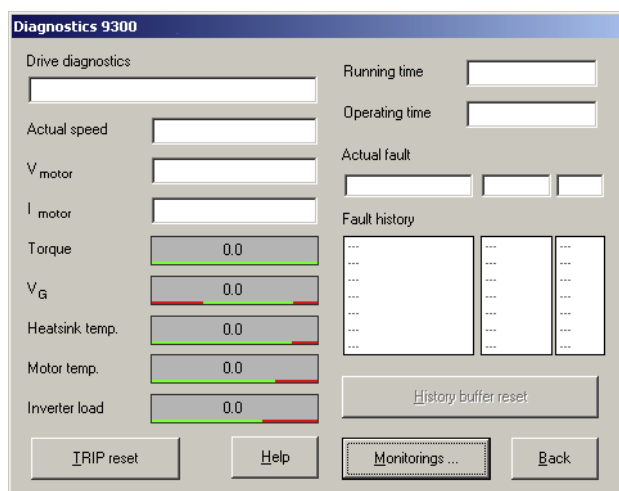

9300std230

Fig. 4-1 "Diagnostics" dialog box

- ▶ You can recognise immediately that a fault has occurred from the display elements or status information.
- ▶ An error can be analysed with
 - the history buffer in Global Drive Control (GDC) (📖 31) or
 - the keypad XT
 - and with the "General error messages" table in the "System error messages" chapter.
- ▶ The "General error messages" table provides tips on how to eliminate an error.

4 Troubleshooting and fault elimination

Troubleshooting

Status display (LEDs on the controller)

4.2 Troubleshooting

Detecting breakdowns

A breakdown can be detected quickly via the LEDs at the controller or via the status information at the keypad.

Analysing errors

Analyse the error using the history buffer. The list of fault messages gives you advice how to remove the fault. (📖 33)

4.2.1 Status display (LEDs on the controller)

During operation the operating status of the controller is shown by 2 LEDs.

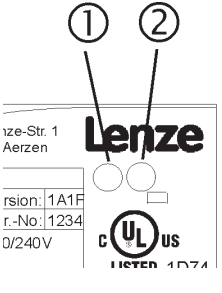
LED		Operating status	
Red ①	Green ②		
Off	On	Controller enabled	
On	On	Mains switched on and automatic start inhibited	
Off	Blinking slowly	Controller inhibited	
Blinking quickly	Off	Undervoltage or overvoltage	
Blinking slowly	Off	Fault active	

4.2.2 Fault analysis with the history buffer

The history buffer can be used to trace faults. The fault messages are stored in the 8 memory locations in the order of their occurrence.

- Open the **Diagnostics** dialog box in the parameter menu.

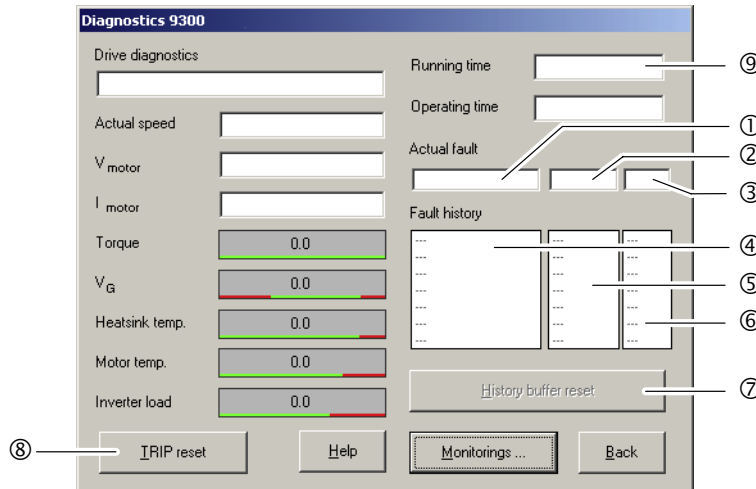

9300std230

Fig. 4-2 "Diagnostics" dialog box

Field	History buffer location	Entry	Note
① ② ③	1	Active fault	If the fault is no longer pending or has been acknowledged: <ul style="list-style-type: none"> • The content of memory units 1 ... 7 is shifted "upwards" by one memory unit. • The content of memory unit 8 is removed from the history buffer and can no longer be retrieved. • Memory unit 1 is deleted (= no active fault).
	2	Last fault	
	3	Next to last fault	
	4	Third to last fault	
④ ⑤ ⑥	5	Fourth to last fault	
	6	Fifth to last fault	
	7	Sixth to last fault	
	8	Seventh to last fault	

Explanations

①, ④	Fault indication and fault response (C0168) <ul style="list-style-type: none"> • The entry is effected as LECOM error number. • If several faults with a different response occur at the same time: <ul style="list-style-type: none"> – Only the fault the response of which has the highest priority is entered (1. TRIP, 2. message, 3. warning). • If faults with the same response occur (e. g. 2 messages) at the same time: <ul style="list-style-type: none"> – Only the fault that was triggered first is entered. – The OH7 and OH3 warnings are exceptions. If an OH7 warning is pending and the OH3 motor temperature threshold is reached, the OH7 warning is overwritten by the OH3 warning. If the motor temperature decreases again, the OH7 warning reappears.
②, ⑤	Time of the fault (C0169) <ul style="list-style-type: none"> • Reference time is the content of the power-on time meter ⑨. • If a fault is immediately followed by another fault for several times, only the time of the last occurrence is stored.
③, ⑥	Frequency of occurrence of the fault (C0170) <ul style="list-style-type: none"> • The time of the last occurrence is stored.
⑦	Click on Fault memory reset to clear the history buffer. The history buffer can only be cleared if no fault is active.
⑧	Click on TRIP reset to reset the fault.

4.2.3 Fault analysis via LECOM status words (C0150/C0155)

The LECOM status words (C0150/C0155) are coded as follows:

Code		Possible settings		IMPORTANT
No.	Designation	Lenze/ {Appl.}	Selection	
C0150	Status word	0		Status word for networking via automation interface (AIF) Read only
			0 {1} 65535	Controller evaluates information as 16 bits (binary coded)
			Bit 0 Not assigned Bit 1 Pulse inhibit (IMP) is active Bit 2 Not assigned Bit 3 Not assigned Bit 4 Not assigned Bit 5 Not assigned Bit 6 n=0 Bit 7 Controller inhibit (CINH) is active Bit 8 Controller status Bit 9 Controller status Bit 10 Controller status Bit 11 Controller status Bit 12 Warning is active Bit 13 Message is active Bit 14 Not assigned Bit 15 Not assigned	
C0155	Status word 2	0		Status word 2 (advanced status word) Display only
			0 {1} 65535	Controller interprets information as 16 bit (binary coded)
			Bit 0 Active fault Bit 1 M_{max} reached Bit 2 I_{max} reached Bit 3 Pulse inhibit(IMP) Bit 4 Ready for operation (RDY) Bit 5 Controller inhibit (CINH) Bit 6 TRIP active Bit 7 Initialisation Bit 8 Motor direction of rotation (Cw/CCw) Bit 9 Not assigned Bit 10 Not assigned Bit 11 Not assigned Bit 12 Not assigned Bit 13 Not assigned Bit 14 Not assigned Bit 15 Not assigned	

4.3 System error messages

4.3.1 General error messages



Note!

If the system error is retrieved via the system bus (CAN), the error messages are displayed as numbers (see column "Error message – No." of the below table).

Fault message		Description	Cause	Remedy
No.	Display			
---	---	No fault	-	-
0011	OC1	Short circuit of motor cable	Short circuit	<ul style="list-style-type: none"> Search for cause of short circuit. Check motor cable.
			Excessive capacitive charging current in the motor cable.	Use motor cable which is shorter or of lower capacitance.
0012	OC2	Motor cable earth fault	One of the motor phases has earth contact.	<ul style="list-style-type: none"> Search for cause of short circuit. Check motor cable.
0015	OC5	I x t overload	<ul style="list-style-type: none"> Frequent and too long acceleration with overcurrent Continuous overload with $I_{motor} > 1.05 \times I_{rx}$. 	Check drive dimensioning.
0016	OC6	I ² x t overload	<ul style="list-style-type: none"> Frequent and too long acceleration processes with motor overcurrent. Permanent motor overload with $I_{motor} > I_{rmotor}$ 	Check drive dimensioning.
x018	OC8	I ² x t overload advance warning	<ul style="list-style-type: none"> Frequent and too long acceleration processes with motor overcurrent. Permanent motor overload with $I_{motor} > I_{rmotor}$ 	Check drive dimensioning.
1020	OU	Overvoltage in DC bus	Braking energy is too high. (DC-bus voltage is higher than set in C0173.)	<ul style="list-style-type: none"> Use braking unit or regenerative module. Check dimensioning of the brake resistance.
1030	LU	Undervoltage in the DC bus	DC bus voltage is lower than specified in C0173.	<ul style="list-style-type: none"> Check mains voltage Check supply cable
x032	LP1	Motor phase failure	A current-carrying motor phase has failed.	<ul style="list-style-type: none"> Check motor. Check motor cable. Switch off monitoring (C0597 = 3).
			The current limit value is set too low.	Set higher current limit value via C0599.
0050	OH	Heatsink temperature > +90 °C	Ambient temperature $T_u > +40$ °C or > +50 °C	<ul style="list-style-type: none"> Allow module to cool and ensure better ventilation. Check ambient temperature in the control cabinet.
			Heatsink is very dirty.	Clean heatsink.
			Wrong mounting position	Change mounting position.

4

Troubleshooting and fault elimination

System error messages General error messages

Fault message		Description	Cause	Remedy
No.	Display			
x053	OH3	Motor temperature > +150 °C threshold (temperature detection via resolver or incremental value encoder)	Motor is thermally overloaded due to: <ul style="list-style-type: none"> ● Impermissible continuous current ● Frequent or too long acceleration processes 	<ul style="list-style-type: none"> ● Check drive dimensioning. ● Switch off monitoring (C0583 = 3).
			No PTC/temperature contact connected.	Correct wiring.
x054	OH4	Heatsink temperature > C0122	Ambient temperature $T_u > +40$ °C or $> +50$ °C	<ul style="list-style-type: none"> ● Allow module to cool and ensure better ventilation. ● Check ambient temperature in the control cabinet. ● Switch off monitoring (C0582 = 3).
			Heatsink is very dirty.	Clean heatsink
			Wrong mounting position	Change mounting position.
			The value specified under C0122 is set too low.	Enter a higher value under C0122.
x057	OH7	Motor temperature > C0121 (temperature detection via resolver or incremental value encoder)	Motor is thermally overloaded due to: <ul style="list-style-type: none"> ● Impermissible continuous current ● Frequent or too long acceleration processes 	<ul style="list-style-type: none"> ● Check drive dimensioning. ● Switch off monitoring (C0584 = 3).
			No PTC/temperature contact connected.	Correct wiring.
			The value specified under C0121 is set too low.	Enter a higher value in C0121.
x058	OH8	Motor temperature via inputs T1 and T2 is too high.	Motor is thermally overloaded due to: <ul style="list-style-type: none"> ● Impermissible continuous current ● Frequent or too long acceleration processes 	<ul style="list-style-type: none"> ● Check drive dimensioning. ● Switch off monitoring (C0585 = 3).
			Terminals T1 and T2 are not connected	Connect PTC/temperature contact.
x061	CE0	Automation interface (AIF) communication error	Faulty transfer of control commands via AIF.	<ul style="list-style-type: none"> ● Plug in the communication module/keypad XT firmly, screw down, if necessary. ● Switch off monitoring (C0126 = 3).
x062	CE1	Communication error on the process data input object CAN1_IN	CAN1_IN object receives faulty data or communication is interrupted.	<ul style="list-style-type: none"> ● Check wiring at X4. ● Check sender. ● Increase monitoring time under C0357/1, if necessary. ● Switch off monitoring (C0591 = 3).
x063	CE2	Communication error on the process data input object CAN2_IN	CAN2_IN object receives faulty data or communication is interrupted.	<ul style="list-style-type: none"> ● Check wiring at X4. ● Check sender. ● Increase monitoring time under C0357/2, if necessary. ● Switch off monitoring (C0592 = 3).
x064	CE3	Communication error on the process data input object CAN3_IN	CAN3_IN object receives faulty data or communication is interrupted.	<ul style="list-style-type: none"> ● Check wiring at X4. ● Check sender. ● Increase monitoring time under C0357/3, if necessary. ● Switch off monitoring (C0593 = 3).

Fault message		Description	Cause	Remedy
No.	Display			
x065	CE4	BUS-OFF state of system bus (CAN)	The controller has received too many faulty telegrams via the system bus (CAN) and has disconnected from the bus.	<ul style="list-style-type: none"> ● Check wiring at X4: Is the bus correctly terminated? ● Check shield connection of the cables. ● Check PE connection. ● Check bus load, reduce the baud rate if necessary. (Observe the cable length!) ● Switch off the monitoring (C0595 = 3).
x066	CE5	Time-out of system bus (CAN) (communication error of gateway function)	For remote parameterisation (C0370, C0371) via system bus (CAN): <ul style="list-style-type: none"> ● Slave does not respond. ● Communication monitoring time has been exceeded. 	<ul style="list-style-type: none"> ● Check wiring of system bus (CAN). ● Check CAN bus configuration.
0070	U15	Undervoltage of internal 15 V voltage supply		Check voltage supply.
0071	CCr	System failure	Strong interference injection on the control cables Ground or earth loops in the wiring	Screen control cables <ul style="list-style-type: none"> ● Check wiring ● Check PE connection After troubleshooting: Deenergise the device completely (disconnect 24 V supply, discharge DC bus)!
0072	PR1	Checksum error in parameter set 1 CAUTION: The Lenze setting is loaded automatically!	<ul style="list-style-type: none"> ● Fault when loading a parameter set. ● Interruption while transmitting the parameter set via keypad. The stored parameters are incompatible with the loaded software version.	<ul style="list-style-type: none"> ● Set the required parameters and store them under C0003 = 1. ● As to PLC devices, check the use of pointers. Store the parameter set under C0003 = 1 first to allow for a faults reset.
0073	PR2	Checksum error in parameter set 2 PLEASE NOTE: The Lenze setting is loaded automatically!	<ul style="list-style-type: none"> ● Fault while loading a parameter set. ● Interruption during the transfer of the parameter set via keypad. The parameters saved do not comply with the software version loaded.	<ul style="list-style-type: none"> ● Set the required parameters and save them with C0003 = 2. In order to be able to acknowledge the error, first save the parameter set with C0003 = 2.
0074	PEr	Program error	Error in the program flow	Send the parameter set (on floppy disk/CD-ROM) with a detailed description of the problem to Lenze. After troubleshooting: Deenergise the device completely (disconnect 24 V supply, discharge DC bus)!
0075	PR0	Error in parameter set.	The operating system software has been updated.	Storage of the Lenze setting C0003 = 1. After troubleshooting: Deenergise the device completely (disconnect 24 V supply, discharge DC bus)!
0077	PR3	Checksum error in parameter set 3 PLEASE NOTE: The Lenze setting is loaded automatically!	<ul style="list-style-type: none"> ● Fault while loading a parameter set. ● Interruption during the transfer of the parameter set via keypad. The parameters saved do not comply with the software version loaded.	<ul style="list-style-type: none"> ● Set the required parameters and save them with C0003 = 3. In order to be able to acknowledge the error, first save the parameter set with C0003 = 3.

4 Troubleshooting and fault elimination

System error messages

General error messages

Fault message		Description	Cause	Remedy
No.	Display			
0078	PR4	Checksum error in parameter set 4 PLEASE NOTE: The Lenze setting is loaded automatically!	<ul style="list-style-type: none"> ● Fault while loading a parameter set. ● Interruption during the transfer of the parameter set via keypad. 	<ul style="list-style-type: none"> ● Set the required parameters and save them with C0003 = 4.
			The parameters saved do not comply with the software version loaded.	In order to be able to acknowledge the error, first save the parameter set with C0003 = 4.
0079	PI	Fault during parameter initialisation	<ul style="list-style-type: none"> ● An error has been detected during the parameter set transfer between two devices. ● The parameter set does not match the controller, e.g. if data has been transferred from a higher-power controller to a lower-power controller. 	<ul style="list-style-type: none"> ● Correct parameter set. ● Send parameter set (on floppy disk/CD-ROM) and a detailed description of the problem to Lenze.
0080	PR6	Too many user codes		Reduce the number of user codes.
x082	Sd2	Resolver error at X7	Resolver cable interrupted.	<ul style="list-style-type: none"> ● Check cable for open circuit. ● Check resolver. ● Switch off the monitoring (C0586 = 3).
x083	Sd3	Encoder error at X9	Cable interrupted.	Check cable for open circuit.
			Pin X9/8 not connected.	Apply 5 V to pin X9/8 or switch off monitoring (C0587 = 3).
x085	Sd5	Encoder error at X6/1 and X6/2 (C0034 = 1)	Current signal at X6/1 X6/2 < 2mA.	<ul style="list-style-type: none"> ● Check cable for open circuit. ● Check current signal encoder. ● Switch off monitoring (C0598 = 3).
x086	Sd6	Motor temperature sensor error (X7 or X8)	Encoder for detecting the motor temperature at X7 or X8 indicates undefined values.	<ul style="list-style-type: none"> ● Check cable for firm connection. ● Switch off the monitoring (C0594 = 3).

Fault message		Description	Cause	Remedy
No.	Display			
x087	Sd7	Selection of the feedback in C0025 as absolute value encoder or alteration of the encoder constant in C0420 for setting $C0025 \geq 309$	An initialisation process within the absolute value encoder has to be carried out.	Save parameter set, then completely deenergise the device, and afterwards switch it on again.
		Initialisation error at X8	<ul style="list-style-type: none"> Defect of the encoder electronics Absolute value encoder at X8 does not send data. <p>Tip: The encoder may not rotate during mains switching.</p>	<ul style="list-style-type: none"> Make sure that the cable at X8 is tightened properly, and check it with regard to open circuit. Check absolute value encoder with regard to correct function. Set voltage supply via C0421 to 8.0 V. No Stegmann encoder connected. Replace defective encoder.
		Communication error of absolute value encoder at X8 during rotor position adjustment	A rotor position adjustment via C0095 = 1 could not be completed successfully.	Repeat rotor position adjustment. Note: After an Sd7 fault it is absolutely required to carry out another rotor position adjustment. Otherwise the drive may carry out uncontrolled movements after controller enable. The drive must not be commissioned without a successfully executed rotor position adjustment!
				After fault elimination: Completely deenergise device (switch off 24 V supply, discharge DC bus)!
x088	Sd8	SinCos encoder at X8 sends inconsistent data.	The tracks in the SinCos encoder are damaged.	Replace SinCos encoder.
			Interference level on the encoder cable is too high.	<ul style="list-style-type: none"> Check correct shield connection of encoder cable. Where required, decelerate the actuation of the fault message via the filter time constant. Setting: – for ECSxS/P/M/A in C0559. – for 9300 servo cam in C0575.
		SinCos encoder at X8 does not send any data.	Open circuit.	Check cable for wire breakage.
			Incorrect encoder connected.	Connect SinCos encoder of the Stegmann company.
			SinCos encoder is defective.	Replace SinCos encoder.
	Supply voltage set incorrectly.	Set voltage supply in C0421.		
		After fault correction: completely deenergise the device (switch off 24 V supply, discharge DC bus)!		
x089	PL	Error during rotor position adjustment (the error is saved with mains failure protection)	<ul style="list-style-type: none"> The rotor position adjustment was cancelled. During rotor position adjustment with absolute value encoder, the error Sd7 or SD8 occurred. 	Activate rotor position adjustment with C0095 = 1. Then carry out TRIP reset and afterwards carry out the rotor position adjustment again with controller enable.
x091	EEr	External monitoring has been triggered via DCTRL.	A digital signal assigned to the TRIP-SET function has been activated.	<ul style="list-style-type: none"> Check external encoder. Switch off the monitoring (C0581 = 3).
0105	H05	Internal fault (memory)		Contact Lenze.

Fault message		Description	Cause	Remedy
No.	Display			
0107	H07	Internal fault (power stage)	During initialisation of the controller, an incorrect power stage was detected.	Contact Lenze.
x110	H10	Heatsink temperature sensor error	Sensor for detecting the heatsink temperature indicates undefined values.	<ul style="list-style-type: none"> • Contact Lenze. • Switch off the monitoring (C0588 = 3).
x111	H11	Temperature sensor error: Temperature inside the controller	Sensor for detecting the internal temperature indicates undefined values.	<ul style="list-style-type: none"> • Contact Lenze. • Switch off the monitoring (C0588 = 3).
x151	P01	Error "negative limit switch".	Negative limit switch was reached.	<ul style="list-style-type: none"> • Control drive in positive direction • Check wiring at X5/E2.
x152	P02	Error "positive limit switch".	Positive limit switch was reached.	<ul style="list-style-type: none"> • Control drive in negative direction • Check wiring at X5/E1.
x153	P03	Following error	<p>The angle difference between set and actual position is larger than the following error limit set under C0255.</p> <p>Drive cannot follow the digital frequency (I_{max} limit).</p>	<ul style="list-style-type: none"> • Increase following error limit under C0255. • Switch off the monitoring (C0589 = 3). <p>Check drive dimensioning.</p>
x154	P04	Error "negative position limit".	Negative position limit (C1224) was not reached.	Find out why the value was not reached (e.g. "incorrect" position targets, set function position value) and adjust the position limit in C1224 if necessary.
x155	P05	Error "positive position limit".	Positive position limit (C1223) was exceeded.	Find out why the value was exceeded (e.g. "incorrect" position targets, set function position value) and adjust the position limit in C1223 if necessary.
x156	P06	No reference.	The reference point is not known. In the case of absolute positioning, no homing was performed before the first positioning.	<p>Perform one of the following functions and restart:</p> <ul style="list-style-type: none"> • Manual homing. • Start homing in the program. • Set reference.
x157	P07	Parameter set mode is absolute instead of relative.	An absolute parameter set (C1311) was performed during relative positioning (position mode C1210).	<p>Perform one of the following functions and restart:</p> <ul style="list-style-type: none"> • Change the parameter set from absolute to relative. • Change position mode.
x158	P08	Error "actual reference dimension offset".	Actual reference dimension offset (C1226) outside the position limits. Error of the program function "set position value".	If necessary, adapt the position limit values or check whether the program function "set position value" is to be applied.
x159	P09	Error in positioning program.	Impermissible programming	<p>Check position program:</p> <ul style="list-style-type: none"> • A parameter set with final speed must be followed by a parameter set with positioning; it is not permissible to wait for input.
x162	P12	Error in the range of the encoder.	The range of the absolute encoder was exceeded.	<ul style="list-style-type: none"> • Return drive by manual positioning. • Check position limits and adjustment of the encoder. • Design and mount the absolute encoder in a way that does not exceed the traversing range.

Fault message		Description	Cause	Remedy
No.	Display			
x163	P13	Angle overrun.	<ul style="list-style-type: none"> ● Phase controller limit reached ● Drive cannot follow the digital frequency (I_{max} limit). 	<ul style="list-style-type: none"> ● Enable drive ● Check drive dimensioning.
x164	P14	1. Following error.	The drive cannot follow the setpoint. The following error is greater than the limit value in C1218/1.	<ul style="list-style-type: none"> ● Increase current limit under C0022 (observe max. motor current). ● Reduce acceleration. ● Check drive dimensioning. ● Increase limit value under C1218/1
x165	P15	2. Following error.	The drive cannot follow the setpoint. The following error is greater than the limit value in C1218/2.	<ul style="list-style-type: none"> ● Increase current limit C0022 (observe max. motor current). ● Reduce acceleration. ● Check drive dimensioning. ● Increase limit value under C1218/2
x166	P16	Faulty transfer of system bus (CAN) sync telegram.	The sync telegram from the master (PLC) is out of sync cycle.	<ul style="list-style-type: none"> ● Set the "sync cycle" to the transmission cycle of the master (PLC) under C1121. ● Note: <ul style="list-style-type: none"> – C0362 displays the time interval between 2 sync telegrams. – C0362 = 0: communication interrupted.
			The sync telegram of the master (PLC) is not received.	<ul style="list-style-type: none"> ● Check communication channel. ● Check baud rate, controller address. ● Note: <ul style="list-style-type: none"> – C0362 displays the time interval between 2 sync telegrams. – C0362 = 0: communication interrupted.
			The controller is enabled too fast.	Delay the controller enable. The time delay required depends on the time interval between the sync telegrams.
x167	P17	Error "touch probe control".	Various function blocks use the touch probe input at the same time (e.g. FB DFSET and POS). A conflict arises.	<ul style="list-style-type: none"> ● Configure another touch probe input for FB POS (not possible for FB DFSET). ● Switch off monitoring (C1289/1).

Fault message		Description	Cause	Remedy
No.	Display			
x168	P18	Internal limitation.	Arithmetic operation generated data cannot be varied arbitrarily. Wrongly specified values were automatically limited internally.	
			C1298 = 1: The negative position limit in C1223 is outside the possible display range of $1 \leq (C1223 \times C1205) \leq 1.07E9 \text{ inc}$	Check the values in C1202/4, C1207/1, C1207/2. Read out the limited value in C1220/10 and enter it in C1223 if necessary.
			C1298 = 2: The positive position limit in C1224 is outside the possible display range of $1 \leq (C1224 \times C1205) \leq 1.07E9 \text{ inc}$	Check the values in C1202/4, C1207/1, C1207/2. Read out the limited value in C1220/11 and enter it in C1224 if necessary.
			C1298 = 3: The maximum speed v_{\max} in C1240 is outside the possible display range of $1 \leq (C1240 \times C1205 \times 16.384) \leq 2.14E9 \text{ inc}$ or $v_{\max} \text{ not } C1240 / C1204 \times 60 \leq 1.5 \times n_{\max}$	Check the values in C0011, C1202/4, C1207/1, C1207/2. Read out the limited value in C1220/12 and enter it in C1240 or adjust the value in C1240 to C0011 if necessary.
			C1298 = 4: The maximum acceleration a_{\max} in C1250 is outside the possible display range of $1 \leq (C1250 \times C1205 \times 16.384 / 1000) \leq 2.8634E7 \text{ inc}$	Check the values in C1202/4, C1207/1, C1207/2. Read out the limited value in C1220/13 and enter it in C1250 if necessary.
			C1298 = 5: An internal value range has been exceeded for a speed standardisation. Valid range: $1 \leq (C0011 \times C1207/1 / C1207/2) \leq 65536 / 60000 \leq 32767$	Check the values in C0011, C1207/1, C1207/2 and correct them.
x169	P19	The input values at X9 are limited.	The function block DFIN limits the input values. This causes the loss of increments.	<ul style="list-style-type: none"> Reduce the frequency on the digital frequency connection. Check the settings for the slave (C0425) and for the master (C0030). These settings must be identical.
x171	P21	Following error.	The phase difference between set and actual position is larger than the following error limit set under C1328.	<ul style="list-style-type: none"> Extend the following error limit under C1328. Switch off monitoring (C1329=3).
			Drive cannot follow the digital frequency (I_{\max} limit).	Check drive dimensioning.
x190	nErr	Speed control error (Speed out of tolerance margin (C0576))	<ul style="list-style-type: none"> Active load (e.g. for hoists) is too high. Mechanical blockades on the load side 	Check drive dimensioning.
x200	NMAX	Maximum system speed (C0596) has been exceeded.	<ul style="list-style-type: none"> Active load (e.g. for hoists) is too high. Drive is not speed-controlled, torque is excessively limited. 	<ul style="list-style-type: none"> Check drive dimensioning. Increase torque limit, if necessary. Switch off monitoring (C0607 = 3).
0201	overrun Task1	Time-out in task 1 (ID 2)	Task processing takes longer than the monitoring time set.	<ul style="list-style-type: none"> Adjust the length of the task runtime. Adjust monitoring time. Determine the cause of time-out by checking the task runtime at the task monitor. Swap out time-critical program parts in a slower task.
...		
0208	overrun Task8	Time-out in task 8 (ID 9)		

Fault message		Description	Cause	Remedy
No.	Display			
0209	float Sys-T	Float error in system task (ID 0)	Error in real calculation (e. g. division by 0)	Check calculations (program code).
0210	float Cycl.-T	Float error in cyclic task (PLC_PRG ID 1)		
0211	float Task1	Float error in task 1 (ID 2)		
...		
0218	float Task8	Float error in task 8 (ID 9)		
0219	overrun Cyc.-T	Time-out in cyclic task (PLC_PRG ID 1)	Task processing takes longer than the monitoring time set.	<ul style="list-style-type: none"> • Adjust the length of the task runtime. • Adjust monitoring time. • Determine the cause of time-out by checking the task runtime at the task monitor. • Swap out time-critical program parts in a slower task.
0220	noT-Fkt Credit	Not enough technology units available.	A program with technology functions has been tried to be loaded to a controller not providing the corresponding units.	<ul style="list-style-type: none"> • Use technology variant of the controller. • Contact Lenze, if necessary.
x220	CDA	Data error	Attempt to transmit faulty profile data	Repeat profile data transfer.
x221	CDA-LOAD	Faulty checksum	The checksum of the transferred profile data is not correct.	Repeat profile data transfer and check for correctness.
0230	No Program	Missing PLC program	No PLC program loaded.	Load PLC program.
0231	Unallowed Lib	PLC program calls invalid library function.	In the PLC program a library function has been called which is not supported by the controller (e.g. because the corresponding hardware is missing).	<ul style="list-style-type: none"> • Remove library function or ensure that the corresponding hardware is available. • Contact Lenze, if necessary.
0232	NoCam Data	Motion profiles (cam data) are not available.	When calling functions of the function library LenzeCamControl.lib it was detected that there are no motion profiles (CAM data) loaded in the memory of the controller.	<ul style="list-style-type: none"> • Ensure that the valid cam data has been attached to the project via the DDS CAM support. • Reload the PLC program into the controller. (Possibly the command Online→Reset (origin) has been executed in DDS.)
x240	ovrTrans Queue	"Free CAN objects" error	Overflow of the transmit request memory	<ul style="list-style-type: none"> • Reduce the number of transmit requests. • Prolong the cycle time.
x241	ovr Receive		Too many receive telegrams	Reduce the number of telegrams on the system bus (CAN).
x250	2.Flash Err	Error when the FLASH memory is accessed	The PLC program tries to access non-available or defect FLASH memory	Make sure that the PLC has the corresponding FLASH memory. If not, please contact Lenze. After troubleshooting: Deenergise the device completely (disconnect 24 V supply, discharge DC bus)!
x251	AddData CsErr	Error during FLASH memory access	Check sum error occurred when loading data into the FLASH memory	Check the checksum of the file to be loaded and repeat the data transfer.

4 Troubleshooting and fault elimination

System error messages

Resetting system error messages



Fault message		Description	Cause	Remedy
No.	Display			
x252	AddData DIErr	Error during FLASH memory access	An error occurred when downloading the data into the FLASH memory (e.g. time-out, transmission error, mains failure during transmission)	Check/repeat data transfer.
x260	Err Node Guard	"Life guarding event"	The controller configured as a CAN slave does not receive a "Node Guarding" telegram from the CAN master within the "Node Life Time".	<ul style="list-style-type: none"> • Check wiring at X4. • Check CAN configuration. • Ensure that "node guarding" has been activated in the CAN master • Adapt the "node life time" (C0383) to CAN master setting.

Explanation of the error numbers:

x 0 = TRIP, 1 = message, 2 = warning, 3 = FAIL-QSP

e.g. "2091": An external monitoring has triggered the warning EEr

4.3.2 Resetting system error messages

Reaction	Measures to reset the fault message
TRIP/ FAIL-QSP	 Note! If a TRIP/FAIL QSP source is still active, the pending TRIP/FAIL QSP cannot be reset. The TRIP/FAIL QSP can be reset by: <ul style="list-style-type: none"> • pressing ⇒ STOP on keypad XT EMZ9371 BC. Then, press RUN to re-enable the controller. • Set code C0043 = 0. • Control word C0135, bit 11 • Control word AIF • Control word system bus (CAN) / MotionBus (CAN) at ECSxS/P/M After the reset of the TRIP/FAIL QSP, the drive remains at standstill.
Message	 Danger! The fault message is reset automatically after the fault has been eliminated, and the drive restarts automatically.
Warning	After the fault has been eliminated, the fault message is reset automatically.



© 03/2010

Lenze Automation GmbH
Hans-Lenze-Str. 1
D-31855 Aerzen
Germany



+49 (0)51 54 / 82-0



+49 (0)51 54 / 82 - 28 00



Lenze@Lenze.de



www.Lenze.com

Service

Lenze Service GmbH
Breslauer Straße 3
D-32699 Extertal
Germany



00 80 00 / 24 4 68 77 (24 h helpline)



+49 (0)51 54 / 82-11 12



Service@Lenze.de



EDKVS93-01 ■ 13330541 ■ EN ■ 2.1 ■ TD23

10 9 8 7 6 5 4 3 2 1