

SIEMENS

Programmable Controller S5-110A

E811 - STANDEXEMPLAR

Manual

Order No.: 6ES5 998-0AA 22

Issue 1

| Contents | Order No.: |
|--|----------------------|
| Instructions | GWA 4NEB 807 0690-02 |
| Testadapter | GWA 4NEB 807 0515-02 |
| Test module | GWA 4NEB 807 0518-02 |
| Timer/counter module | GWA 4NEB 807 0524-02 |
| Serial Central Controller Interface Module | GWA 4NEB 807 0500-02 |
| Programming Instructions | GWA 4NEB 807 0691-02 |
| | |
| | |
| | |
| | |
| | |

Instructions

Testadapter

Test module

Timer/counter module

Serial Central Controller Interface Module

Programming Instructions

SIEMENS

SIMATIC S5

**SIMATIC S5–110A
Programmable Controller**

Operating Instructions

SIMATIC S5-110A Programmable Controller

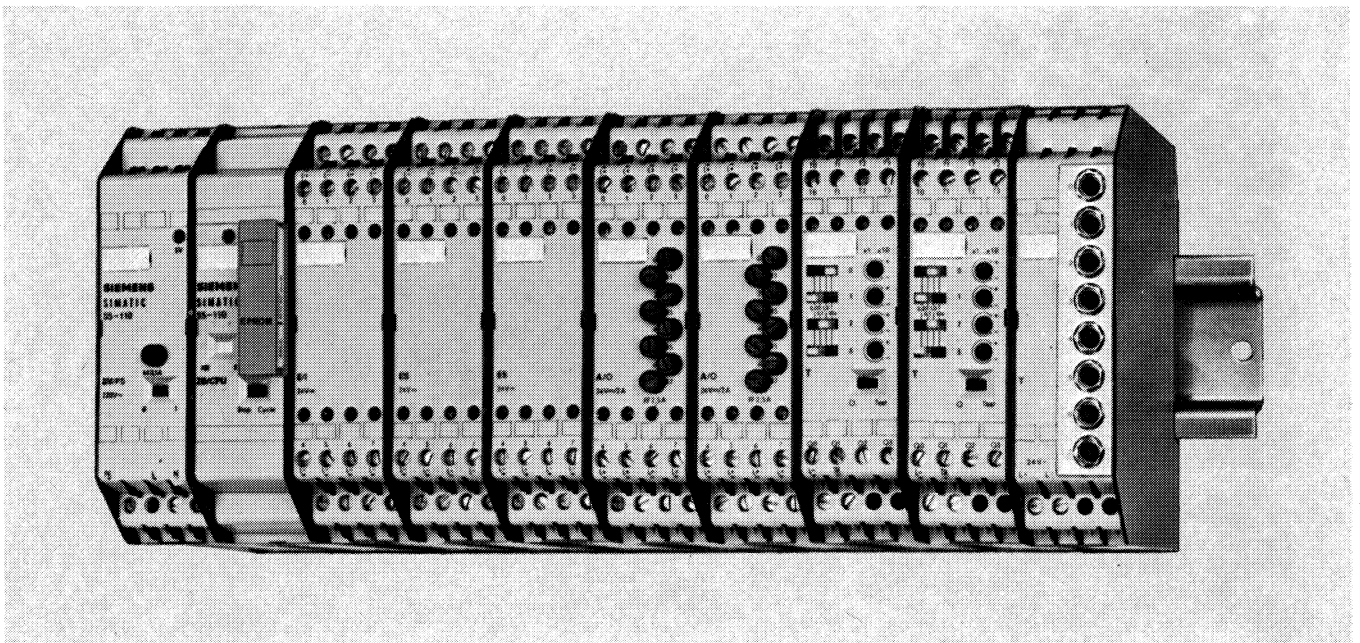

Fig. 1 SIMATIC S5-110A Programmable Controller with eight I/O modules

| Contents | Page | Page |
|--|------|--|
| 1. Description | | |
| 1.1 Application | 1.2 | |
| 1.2 Construction | 1.2 | |
| 1.3 Principle of operation | 1.4 | |
| 1.3.1 General | 1.4 | |
| 1.3.2 Central processing unit | 1.5 | |
| 1.3.3 910 Memory submodule | 1.6 | |
| 1.3.4 930 Power supply module | 1.6 | |
| 1.3.5 400, 401 and 405 Input modules (solid state) | 1.6 | |
| 1.3.6 Output modules | 1.6 | |
| 1.3.7 Timer modules | 1.7 | |
| 1.3.8 418 Display module | 1.9 | |
| 1.3.9 500 Programmer interface module | 1.9 | |
| 1.3.10 330 Test module and 322 test adapter | 1.10 | |
| 1.3.11 931 Power supply module | 1.10 | |
| 1.3.12 311 Serial interface | 1.10 | |
| 1.4 Technical specification | | |
| 2. Installation | | |
| 2.1 Installation guidelines | 2.1 | |
| | | |
| | 2.2 | Guidelines for the electrical installation |
| | 2.3 | Expansion capability |
| | 2.4 | Construction and dimensions |
| | 2.5 | Connections |
| | 2.6 | RI suppression |
| | | |
| | | 3. System start-up and operation |
| | 3.1 | Checking the system |
| | 3.2 | Settings and signals |
| | | |
| | | 4. Maintenance |
| | 4.1 | Replacing the NiCd batteries |
| | 4.2 | Testing and troubleshooting |
| | | |
| | | 5. Appendix |
| | 5.1 | Overview of STEP 5 operations for the S5-110A PC |
| | 5.2 | Interface assignments |
| | 5.3 | Signal sequence at the I/O interface |
| | | |
| | | 6. Spare parts |
| | 6.1 | |

1. Description

1.1 Application

The SIMATIC S5-110A programmable controller can be used for solving simple automation tasks. It is a low-priced alternative to relay and contactor control systems.

The programmable controller can be used, for example, for the following applications:

- Storing of signals from pushbuttons
- Evaluating the position of selector switches
- Processing signals from limit and safety switches
- Counting low-frequency pulses
- Controlling motors, valves, actuators, etc.
- Signalling critical plant statuses

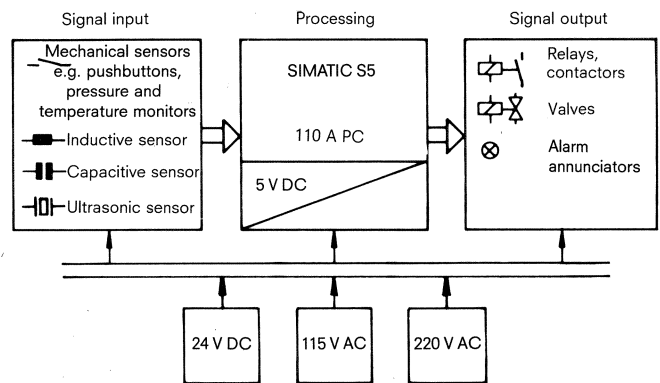

Fig. 2 Structure of a system using the S5-110A programmable controller

1.2 Construction

- The S5-110A programmable controller consists of the following:
- Central controller with mounting rack of standard or extended length
 - Peripheral I/O modules
 - Supplementary modules

But for a few exceptions, the central processing unit (CPU), power supply unit, I/Os and supplementary modules are of the block type.

Each module consists of a printed-circuit board inside a fibreglass-reinforced plastics block or casing with very good thermal conductivity. This protects the PCBs against external influences. No fans are required for heat dissipation.

The blocks are simply snapped onto the sectional rail of the mounting rack. The electrical connection between the block (plug connector on the base) and the module location is automatically established when the block is snapped on. No further wiring is required, except for the 417 relay modules and the 381/383 timer/counter modules, which require a special power supply (see pp. 1.7 and 1.8).

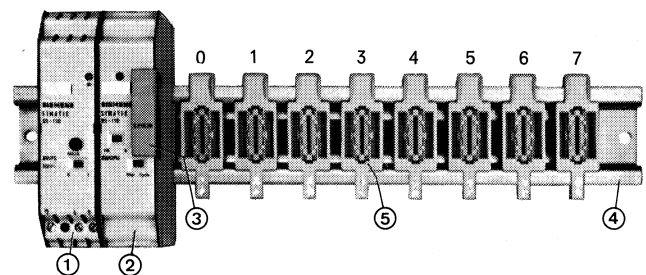

Central controller

Fig. 3 Configuration for up to eight I/Os (single-tier arrangement with mounting rack of standard length)

- ① 930 Power supply module
- ② 900 CPU
- ③ 910 Memory module (plug-in type)
- ④ 710 Mounting rack
- ⑤ Socket connectors (with addresses)

1. Description

1.2 Construction

Central controller

The central controller consists of the following:

Central processing unit (CPU)

The CPU contains a CMOS bit processor, which processes the statements stored in a plug-in memory submodule (program medium).

Adjustment for 2K or 4K memory submodules is automatic. A backup battery can be retrofitted.

910 Memory submodule (plug-in)

The memory submodule is an EPROM (Erasable Programmable Read Only Memory) for 1, 2 or 4K statements, depending on the version selected.

930 Power supply module

The 930 power supply module converts the external supply voltage of 240 VAC, 220 VAC, 115 VAC or 24 VDC to the necessary internal DC supply voltage of +5V.

This module can power 32 I/O modules (maximum configuration, including expansion units). The power for external devices such as sensors, contactors, valves etc., must be supplied by an additional external power pack.

710 Mounting rack (of standard and extended length)

This is a 75 mm standard sectional rail with pre-wired socket connectors attached to the bus. The first I/O location has the address 0 (earlier rails commenced with address 1). In multi-tier configurations, the location addresses are printed above each other on the socket connectors. Various mounting arrangements and module configurations are described in Section 2.2.

The "PS" module locations may only be used for the CPU power supply module and, if expansion units are used, for the connecting cable. These two locations are identical and cannot be addressed.

SIMATIC S5-110A

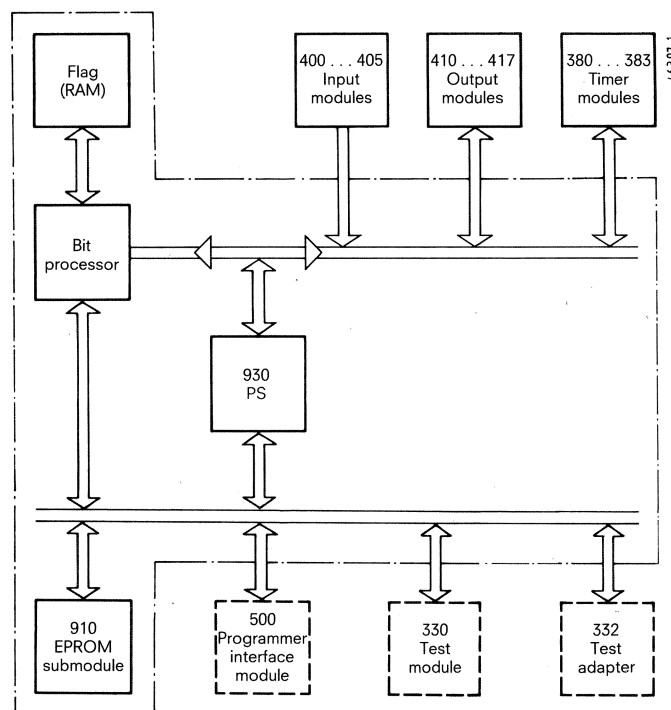

Fig. 4 Structure of the SIMATIC S5-110A programmable controller

I/O modules

The following I/O modules are available:

- 400 to 405 input modules
- 410 to 417 output modules (solid-state and with relays)
- 380 timer module
- 381 and 383 timer/counter modules

These modules are snapped onto the socket connectors of the mounting rack.

Supplementary modules

The following supplementary modules are available:

- 418 Display module
- 500 Programmer interface module
- 330 Test module
- 332 Test adapter
- 931 Power supply module (220V AC/24V DC/0.8 A)
- 311 Serial interface module

1. Description

1.3 Principle of operation

1.3.1 General

The program memory (memory submodule, programmer) contains the STEP 5 program written by the user. The memory is byte-oriented. Each memory location consists of eight bits, two such locations making up a complete statement, such as **AI 5.1**:

"Scan input 1 on block 5 for the signal state "1", and AND this signal with the result of the previous scanning operation."

The statements in the program memory are processed cyclically one after the other by the CPU. The individual memory locations are referred to by means of an address counter. The next two memory locations (i.e. one complete statement) are read out by incrementing the address counter by one.

The function of the controller is described below by way of example of the **AI 5.1** scanning operation (see Fig. 5).

When the address counter of the processor reaches the respective program memory location, the **AI 5.1** statement is read out.

The parameter 5.1 is routed to the I/O modules via the peripheral bus. The "5" in the parameter is evaluated via the coded peripheral bus, i.e. the block plugged into the fifth connector is addressed. The input or output on this block is addressed by the "1" component of the parameter.

The operation decoder evaluates the operand "1" and enables all input modules. In keeping with the addressing described above, therefore, block "5" is enabled only if it is an input module.

The complete parameter thus specifies input 5.1, which can then be scanned. Depending on the signal state at this input, a "1" or "0" signal is routed to the logic unit in the processor via the signal status line (D_{in}).

From the bit pattern for the letter "A" (in the operation "AI AND Input I) the operation decoder recognizes that the result of the scanning operation is to be ANDed in the logic unit with the result of the scanning statement last processed.

This new result of the logic operation (RLO) is stored in the logic unit and is taken into account by the processor when processing the next statement.

The address counter is then incremented and the next statement is processed by the processor.

In the case of output commands, the result of the last logic operation is routed via the data output line (D_{out}) to the output modules and stored there. The transfer command for the I/O memory is contained in the tier enable (see Section 5.3). Timer modules are started with output commands and the time running is evaluated by scanning operations for the inputs with the same address.

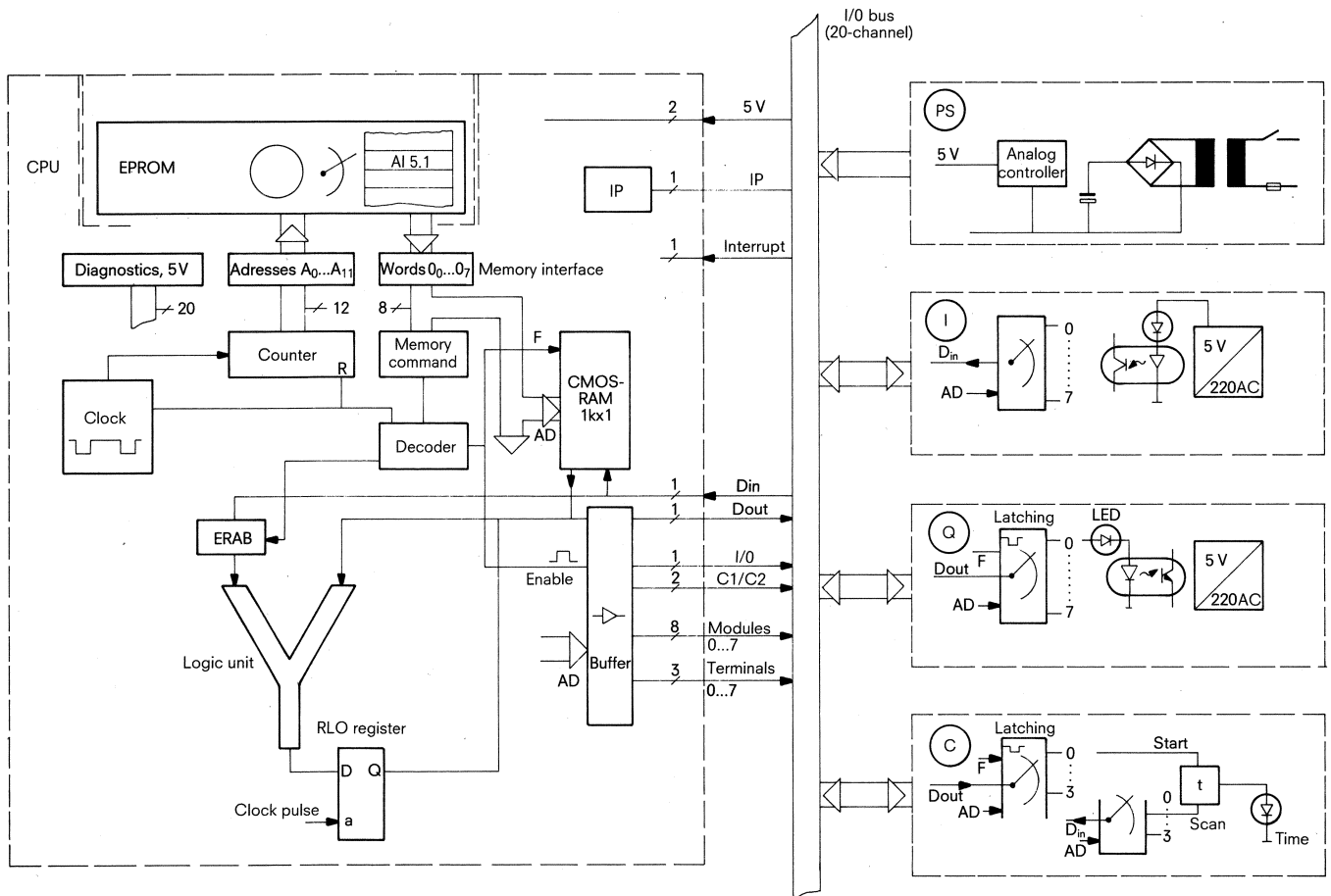

Fig. 5 Mode of operation

ERAB = First input bit scan
IP = Initialising pulse

1.3.2 CPU (6ES5-900-7AD11)

The following functional units are located in this module:

- CMOS bit processor
- RAM user memory
 - 128 output flags (internal relay equivalents) (Q) as image of the signal status of the outputs
 - 384 output flags (Q), non-retentive
 - 511 flags (F), retentive
- Receptacle for the 910 memory submodule
- Connector for the I/O bus (on rear of module)
- Mode selector
- Selector for retentive "R" and non-retentive "NR"
- Backup battery (NiCd); can be retrofitted
- LED display for stop state of the CPU

A clock pulse generator generates the system clock. A counter is used to increment addresses in the program memory (EPROM) so that the program statements can be read out and decoded by the processor (operation decoder). The processor then executes the statements with the aid of the system clock (see STEP 5 operation set for the S5-110A programmable controller).

The program is stored on EPROMs in a memory submodule. These submodules are available with memory ICs for 1K, 2K, or 4K statements (equivalent to 2K, 4K or 8K bytes).

When the power supply is switched on, an initializing pulse is generated.

An initializing pulse is also generated if the mode selector is actuated ("Stop" position) and if an on-line connection is established via the programmer.

This initializing pulse is also generated on power failure or if the power supply is switched off and has the following effect:

- Resetting of the address counter to 0
- Unlatching of the outputs
- Display of the "Stop" state (LED).

The initializing pulse generated by a cold restart disappears

- if the voltage rises above the lower operating limit (4.5 V) within 40 ms
- if the mode selector is moved to the "Cycle" position
- if an on-line connection is established

After a cold restart the outputs are disabled for **one** program scan. During this scan, the user RAM is reset to a defined state according to the position of the retentive/non-retentive selector switch (on the front of the CPU).

The user RAM for the flags is divided into two areas:

Optionally retentive flags and non-retentive flags (output flags).

The retentive flags are referenced with flag operations (SF, RF, = F).

This flag area (F) can be supported by a backup battery, i.e. if the power supply fails, the signal status of these flags is retained.

Selector switch in "NR" (non-retentive) position:

- Resetting of all flag locations for assignment and setting operations (= F, SF, RF)

- Resetting of all outputs flags for assignment and latching operations (= Q, SQ, RQ)

When the switch is in the "NR" (non-retentive) position, flags (F) and output flags (Q) have the same reactions and characteristics.

Selector switch in "R" (retentive) position:

- Flag area (F) unaffected on cold restart.
- Unlatching of all output flags for assignment and latching operations (= Q, SQ, RQ).

If retentive characteristics are required, the flags should be addressed with "1"-active latching or unlatching operations (SF, RF) so that, if the power supply should fail, the process image is not falsified via the inputs.

The charge of the battery is monitored by a watchdog. As soon as the power returns after a power failure, the watchdog determines whether the battery is low (less than 2.5 V) or not. If the battery voltage is low, the fault memory is set, an initializing impulse is generated and the stop lamp lights up.

After a charging time of approximately half a minute, the battery voltage monitor and the battery will have been refreshed enough so that operation is immediately possible by putting the mode selector to "Cycle".

A full charge takes three days. The backup time after full charging is at least one week. It is advisable to replace the Ni-Cd-battery every two years.

When the selector switch is in the "NR" position, battery voltage monitoring is deactivated. An automatic warm restart always takes place when power supply is resumed.

The processor has a timer set to approx. 300 ms for scan-time monitoring. If a "BE" or "BEC" operation is processed before this time is up, the timer is reset to 0. The "Address zero" signal (start of a new scanning cycle) triggers the timer which then runs once more for approx. 300 ms. If, during this period of approx. 300 ms, the timer is not "reset" (e.g. by a program error), the processor stops.

The red LED on the CPU displays the "Stop" state as a group signal:

- if there is a power supply undervoltage
- if the mode selector is in the "Stop" position
- if the backup battery is low (after recovery of the power supply, mode selector in "R" position)
- if the scan time monitor is referenced.

The CPU also has an interrupt with the aid of which the influence of the scan time can be reduced. A special input module (6ES5-401-7AA13) sends a pulse via the interrupt line (IR) to the processor when a signal change occurs at the input. When processing the interrupt scans (AF 0.0) scattered throughout the program, the processor jumps back to the beginning of the program where the statements that have to be processed rapidly are located.

The bus driver amplifies the bus signals with which the I/O modules are driven.

1. Description

1.3 Principle of operation

1.3.3 910 Memory submodule

Each submodule has an EPROM program memory with

1K statements
2K statements or
4K statements.

For programming, the memory submodule is plugged into the receptacle on the programmer.

The memory identifiers (jumpers K1...K5, see Section 5.2) and the related EPROM configuration must not be changed, otherwise the programmers will not accept the memory submodule.

For the user's information we reproduce here Intel's technical specifications regarding the immutability of programmed data. A precondition is that the windows of the EPROMs are covered with adhesive labels to prevent the entry of light.

The following failure rates (based on the 2716 EPROM) can be expected:

– Operation: approx. 4 % in 10 years (0.045 % / 1.000 h, 55 °C)
– Storage: approx. 0.6 % in 20 years (0.003 % / 1.000 h, 55 °C)

The memory submodule is the only component of the 110A PC which can be destroyed by static electricity if conductive parts are touched (MOS chip; floor carpeting may cause static charges!). If the submodule is transported outside the controller, it is recommended that the antistatic cassette supplied be used.



1.3.4 930 Power supply module

The 930 power supply module generates the internal control voltage of +5V DC from the line voltage of 240V AC, 220V AC, 115V AC or 24V DC.

This module can supply power for 32 I/O modules (maximum configuration including expansion units). Field devices, such as sensors, contactors, valves etc., must be powered either from an external power supply unit or from the mains. The module contains the following:

- Line-side on/off switch
- Line-side fuse
- Noise suppression filter
- 5V LED display
- Connector for I/O bus

1.3.5 400, 401 and 405 Input modules (solid state)

Each with eight inputs for a signal voltage of
24V DC
24V DC with group signal
48V AC/DC
115V AC/DC
220V AC/DC

The input signals on all the input modules are galvanically isolated by means of optocouplers, suppressed and converted to the internal signal level of +5V.

LEDs on the front of these modules display the signal statuses of the inputs (LEDs driven by external voltage).

The 6ES5 401 input module sends a group signal to the CPU when the state of an input changes from "0" to "1" or vice versa (selectable by two externally accessible switches at the rear of the module – each switch for four inputs). Like all the other input modules, this module can be plugged into any location on the mounting rack.

1.3.6 Output modules

410, 415, and 417 output modules

each with eight outputs for the following signal voltages/currents:

24V DC/2A
48V DC/0.5A
48V AC/2A
115V AC/2A
220V AC/2A

The output modules store the binary output signals, amplify the internal signal (5V DC) and use it to switch the required external voltage. The output signals are galvanically isolated by means of optocouplers.

LEDs on the front of these modules display the signal statuses of the outputs (LEDs driven via the bus).

410 Output module (6ES5) (transistor)

The output modules can switch all resistive and inductive loads, including lamps, if the current consumption does not exceed the value given in Section 1.4 (Technical specification).

The outputs can be switched in parallel (ORed) if they are fed from the **same** source (P), but not for the purpose of increasing the load current.

Series connection of the outputs is also permissible since the residual voltage in the "on" state is low (2.5 V).

Assuming that the line resistance is within the prescribed limits (20 % of the rated resistance), the fuses on the front of the module (FF 2.5 A) will blow if a direct short-circuit should occur. These fuses offer the line protection required by VDE 01100 so that the output module can also be regarded as a terminal block.

The 6ES5 410-7AA21 (48V DC) output module is not current-limited. The maximum current for inductive loads is 0.5A.

415 Output module (6 ES5) (Triac)

The output modules are usually fitted with RC elements to protect against noise. These elements give rise to a capacitive residual current in the 415 AC output modules. It must be ensured that the loads recognize this residual current as a "0" signal. Siemens contactors from size 0 upwards are suitable as loads.

The maximum contactor size is determined by the continuous operating current, which should be less than 2 A. The outputs are adequately rated for the inrush currents.

Outputs can be connected in parallel (OR) if they have the same phase voltage and if the greatly increased capacitive residual current I_{res} is taken into account.

Contacts can either be connected in series or in parallel with the outputs. If they are connected in parallel, a varistor (Siemens SI0V S 10 K275) must be connected in parallel with the contact.

Contactors driven by outputs must not have RC elements (parallel resonance excited by residual current).

In the case of disturbances in connection with contactors driven by contact-making devices, it is advisable to fit the contactors with RC elements. Reversing circuits for motor and capacitor combinations must not be implemented with the 514 output module.

All outputs are current-limited (FF 6.3A).

417 Output module (6ES5) (relays)

The relays of these modules are driven via the peripheral bus. The relays require an external 24V DC supply.

These modules are particularly immune to external disturbances. They can be used even for driving loads which cannot be driven by static output modules owing to the residual current in the "0" signal state.

The relay contacts are fitted with varistors (Siemens SI0V S 10 K275). The contact thus still has a high resistance when open.

The total current at the common point must not exceed 5A (see Section 2.4).

1.3.7 Timer modules

380 Timer module

for four timers (10 ms to 100 s).

Each timer can be roughly set to the following time ranges by means of a slide switch:

- 10 ms to 100 ms
- 100 ms to 1 s
- 1 s to 1 s
- 10 s to 100 s.

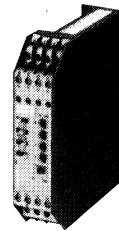
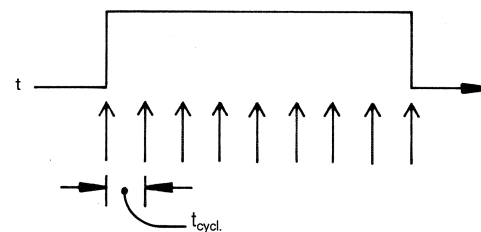

Fig. 6 380 Timer module

The time ranges overlap. Fine setting is made by means of the built-in potentiometers. For remote operation, external potentiometers can be connected through a resistance of 500 k. Shielded cables of up to 10 m long may be used for this purpose.

The times are set using the test switch (on the front of the module, CPU in the stop state) and observing the LEDs or, in the case of short times, with an oscilloscope via outputs Q0...Q3 (see Section 3.2).

In the case of the short times, it must be noted that the scan time, which depends on the length of the program, considerably influences the accuracy of the time set.



The scan time must be considerably shorter than the set time:

$$\text{Max. error } \frac{\Delta t}{t} \leq \pm \frac{n \cdot t_{ST}}{T} \cdot 100 \%$$

n: Number of statements
 t_{ST} : 20 μ s (time for one statement)
 T: Set time

This is valid for all timer modules.

1. Description

1.3 Principle of operation

381 Timer/counter module (digital time generation)
with eight timers/counters (down counters)

Comprising:

- a 381 timer/counter module,
- max. eight 382 adapter blocks (type I or type II)
- max. eight thumbwheel switches with LEDs or
- max. eight thumbwheel switches with a numeral display.

One adapter block and one thumbwheel switch with LED or numeric display is required for each timer or counter. The times or counts are set with the thumbwheel switch.

Three-decade thumbwheel switches either with 7-segment numeric display for displaying the current time or with an LED for indicating that the timer or counter is running (see Fig. 8).

The timer or counter function can be selected by means of a switch on the adapter block.

Timer and counter ranges (adapter block)

Time ranges: 0.01 s to 9.99 s
0.1 s to 99.9 s
1 s to 999 s

Counting range: 999 to 0 (down counter)

The timer/counter module has eight connectors on the front for establishing the electrical connection (715 connecting cable, max. 10 m long) to eight 382 adapter blocks. The adapter blocks are snapped onto a 35 mm standard sectional rail.

Thumbwheel switches and numeric displays are designed for flush mounting in panels.

The adapter block and thumbwheel switch or 7-segment display are connected to each other with flat ribbon cables (length approx. 200 mm). Supply voltage of the timer/counter module: 24 V DC.

The cable between the timer/counter module and the adapter block (unshielded, 2.5 m; 5 m; 10 m in length) must not be run in the same cable as I/O cables.

When programming, a space of at least five statements must be left between setting and scanning operations for the timer. If the timer is reset within one cycle and started again, thirty statements (e.g. NOPs) must be inserted between the RQ(U) and SQ(L) statements.

383 Timer/counter module

for 12 timers and 4 timer/counters (up-counters) time range 10 ms...999 s

The module consists of:

- a 383 timer/counter module (double width)
- an operator's panel with thumbwheel switches and three-decade numeric display and
- a keypad with 16 keys and 16 LEDs.

The timer/counter module is snapped onto two adjacent locations of the mounting rack with the same line coding and addressed via the bus. A 220V AC supply must be connected. The timer module has two 50-way connectors at the front for connecting the operator's panel (left connector) and the keypad (right connector). Both operating elements are designed for flush mounting in panels.

Detailed operating instructions are obtainable;
Order Number: GWA NEB 807 0524-02.

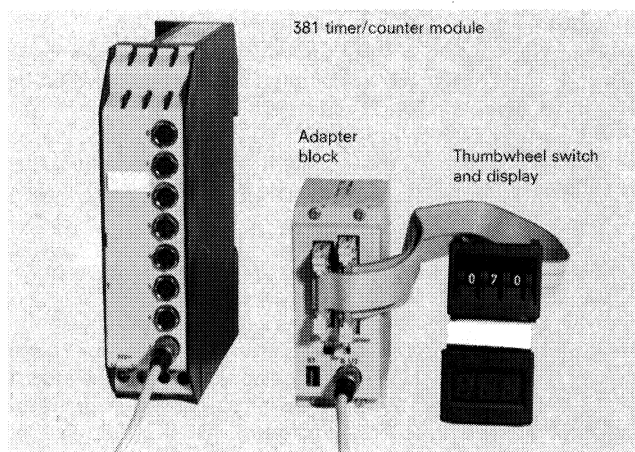

Fig. 7 381 Timer/counter module with components

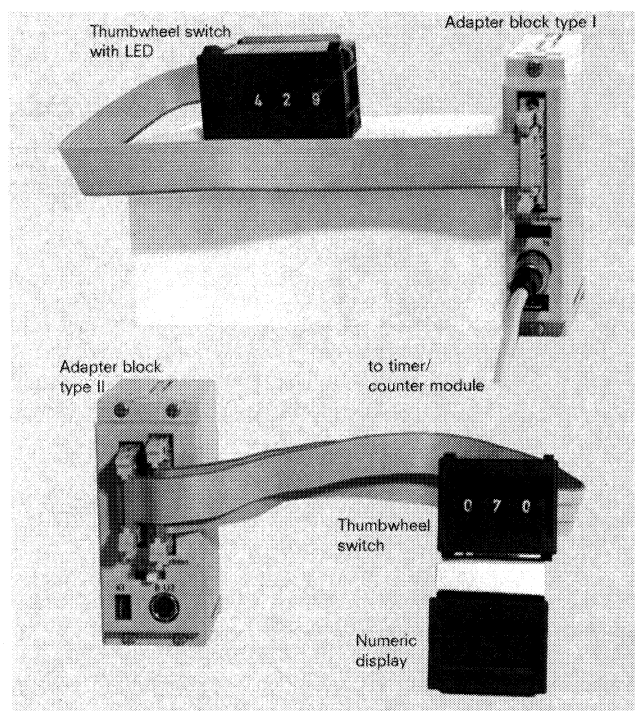

Fig. 8 382 Adapter blocks with accessories

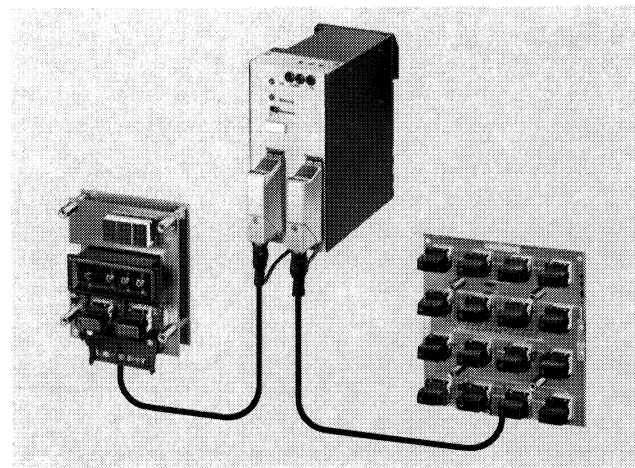

Fig. 9 383 Timer/counter module with operator's panel and keypad

1.3.8 418 Display module

Two-digit numbers can be displayed by the program via the display module.

The module is powered via the bus; external connections are not required.

The module is addressed by output commands from the program. Bit addresses 0 to 3 are used to address the first decade (tetrad), and addresses 4 to 7 for the second decade. Programming is possible in hexadecimal or in BCD code.

Example: Display of message number 95, display module at location 7

| | | | | | | | | |
|--------------|---|---|---|---|---|---|---|---|
| Connection | 7 | 6 | 5 | 4 | 3 | 2 | 1 | 0 |
| Significance | 1 | 0 | 0 | 1 | 0 | 1 | 0 | 1 |



Statement sequence

- = Q 7.0
- = Q 7.2 Bits 1, 3, 5, 6 must already have
- = Q 7.4 been reset.
- = Q 7.7

Application range:

- Display of processing steps in sequence controls
- Display of faults and errors

1.3.9 500 Programmer interface module

for connecting a 630, 631 or 670 programmer to the S5-110A PC.

The program stored in the RAM of the programmer can be tested on-line, corrected if necessary and started up by means of this interface module (transfer of signal state and RLO).

The interface module has a central clock pulse generator which controls data transfer in both directions (programmer, PC). The clock pulse generator of the CPU is disabled when the interface module is plugged in.

The parallel interface is driven by fast TTL chips (transmitter, receiver). The installation guidelines must be taken into account to ensure reliable operation (see Section 2.4).

See the Operating Instructions of the programmers and Section 2.4 for details.

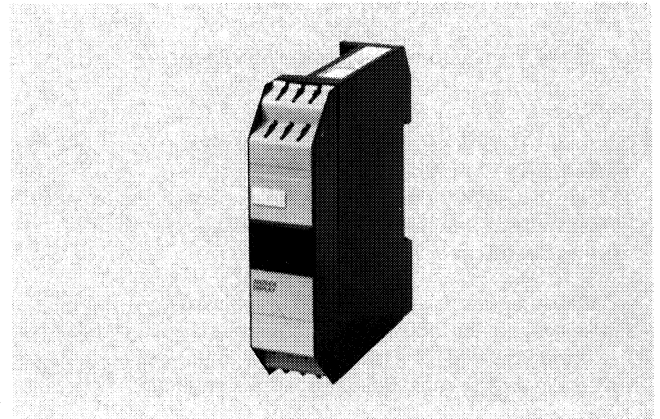

Fig. 10 418 Display module

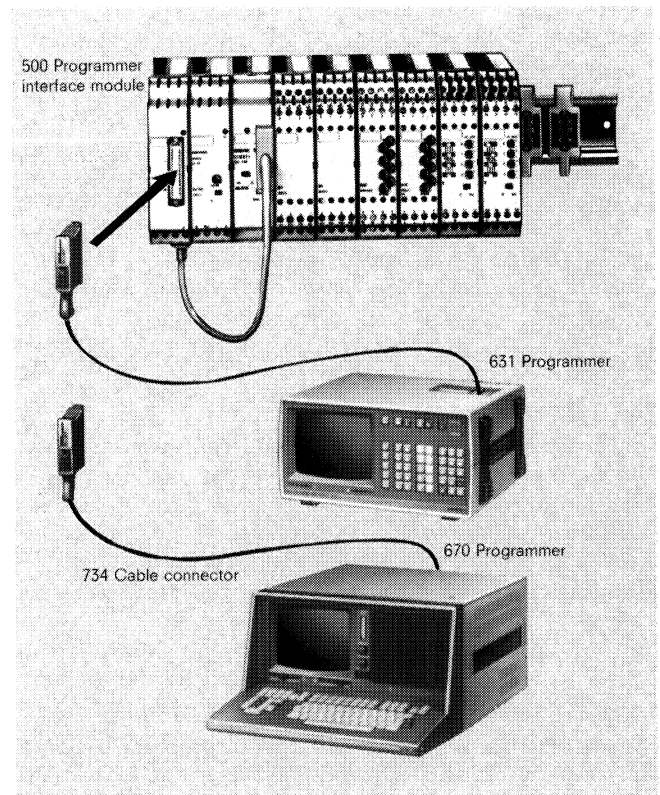

Fig. 11 500 Programmer interface module

1. Description

1.3 Principle of operation

1.3.10 330 Test module and 322 test adapter

for simple system start-up and error diagnostics.

Functions:

- Start-up of individual program sections by setting starting and end addresses (hexadecimal);
- Display of memory addresses and the respective statements with signal statuses and results of logic operations;
- Testing the program in single-step mode.

The 330 test module is snapped onto the mounting rack at the free location next to the 930 power supply module and hooked up electrically to the 900 CPU by a cable connector. The programmed memory submodule is plugged into the test module.

Detailed Operating Instructions are available,
Order No. GWA 4 NEB 807 0518-02a.

332 Test adapter

for fault diagnostics.

Functions:

Display of the signal status and the result of the logic operation at selectable memory address (hexadecimal).

The 332 test adapter is plugged to the receptacle for the 910 memory submodule in the CPU and the 910 memory submodule is inserted into the 332 test adapter.

Detailed Operating Instructions are available,
Order No. GWA 4NEB 807 0515-02a.

1.3.11 931 Power supply module

This module generates a 24V DC/0.8 A supply from a 220V AC/115V AC primary voltage, e.g. for

- 417 relay module
- 381 timer/counter module
- sensors (contacts, BERO proximity switches etc.)

The module can be snapped onto a 75 mm standard sectional rail.

1.3.12 311 Serial interface

The serial interface permits SIMATIC S5-100 peripheral devices to be connected to SIMATIC S5-130/150 PCs and to Siemens 300 Systems computers over distances of up to 1,000 m. Data exchange with the central controllers is by means of a TTY 20 mA current loop interface.

Details can be found in Operating Instructions
GWA 4NEB 807 0500-02.

A power supply with 0.9 A (6ES5 930-7AA01/12/22) is sufficient for powering a serial interface at 240V AC, 220V AC or 115V AC. In order to keep the voltage drop in the cable to the 311 interface module as low as possible if the 6ES5 710-0FA21 (110 F) mounting rack is used in a multi-user configuration, the power supply should be located next to the 311 interface module. If the power supply is 24V DC, two 6ES5 930-7AA31 power supply units are required.

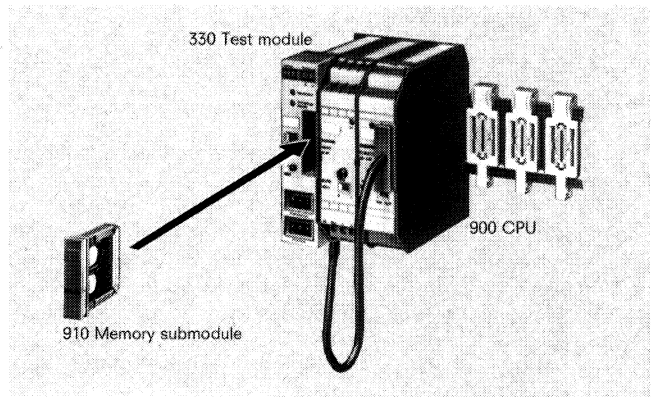

Fig. 12 Installation of test module

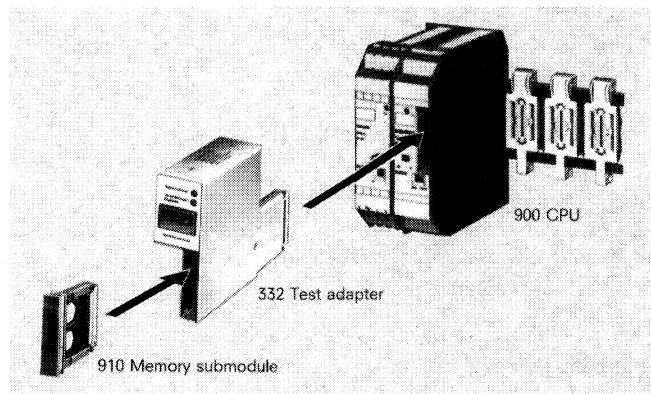

Fig. 13 Installation of test adapter and memory submodule

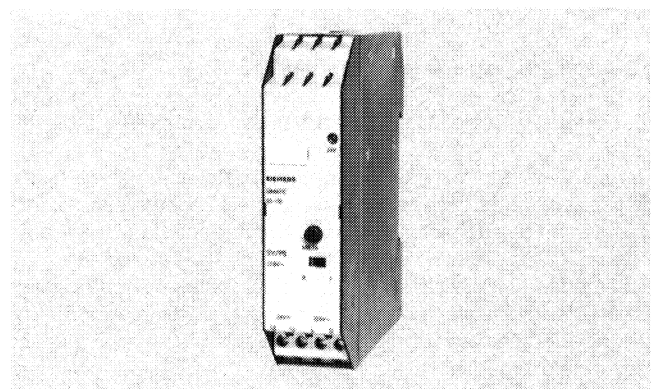

Fig. 14 931 Power supply unit for 220V AC

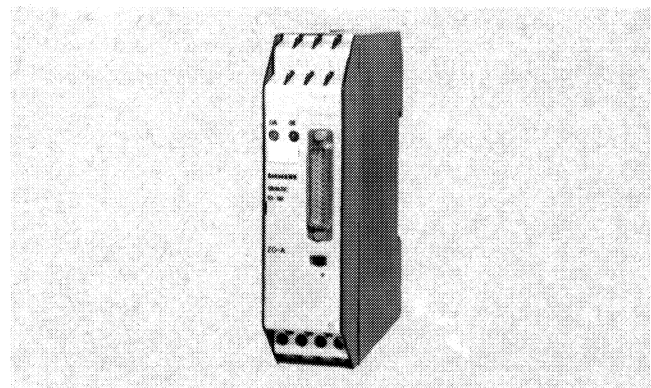

Fig. 15 311 Serial interface module

1. Description

1.4 Technical specification

| General | |
|--|--|
| Insulation group | at U ≥ 24V: group C to VDE 0110 at U = 5V: group 2 to VDE 0110, § 13 |
| Degree of protection | IP 20 for modules with screw terminals, otherwise IP 50 |
| Ambient temperature | 0 °C to +55 °C, without forced ventilation |
| Storage temperature for units with NiCd backup battery | −40 °C to +85 °C (life of NiCd backup battery restricted at temperatures over 45 °C) |
| RI suppression | Limit class B to VDE 0871 Degree of RI suppression N to VDE 0875 |
| Humidity rating | F to DIN 40 040, less than 70 % relative humidity, annual average for ≤ 35 °C |
| Mechanical loading | Mounting in stationary equipment, vibration resistance to DIN 40046, Sheet 8 10... 58 Hz, constant amplitude 0.075 mm 58... 500 Hz, constant acceleration 1 g 20 cycles par axis, 1 octave per minute |
| Module dimensions (W × H × D) | 40 mm × 166 mm × 150 mm |

| Mounting racks | Standard length 6ES5 710-0SA11 | Extended length 6ES5 710-0SA41 | |
|---|--|---|---|
| Mechanical construction | Standard sectional rail with 10 wired module locations 0...7 | Standard sectional rail with 18 wired module locations 0...15 | Location coding starting with "0" |
| Dimensions (W × H × D) of the standard sectional rail | 482.6 mm × 75 mm × 25 mm | 813 mm × 75 mm × 25 mm | |
| Mounting arrangements | in cabinets: e.g. 8MF (600 mm) 19 inch; Vertical mounting surface | in cabinets: e.g. 8MF (900 mm); Vertical mounting surface | see Section 2.2 for installation guidelines |
| Module locations | | | |
| – total | 10 | 18 | |
| – for I/O modules | 8 | 16 | |
| Number of mounting racks linked with cable connector | | | |
| – one above the other | max. 4 | 2 | |
| – side by side | max. 2 | – | |
| Weight | approx. 1.53 kg | 2.56 kg | |

| Central processing units | 6ES5 900-7AD11 |
|------------------------------------|--|
| Addressing volume | 4092 statements (max.) |
| Execution time per statement | 20 µs |
| Scan time monitoring | 300 ms |
| Flags (internal relay equivalents) | 511 bits, switch-selectable for retentive or non-retentive (F0.1...F63.7) |
| Battery backup for flags | Battery (6ES5 980-0AC11) for at least 1 week backup time (typical: 6 weeks); charging time: 3 days; life approx. 2 years |
| Free output flags | 384 bits, non-retentive (Q16.0...Q63.7) |
| Addressing range | see table "STEP 5 operation set", Section 5.1 |
| Power consumption | 120 mA (including memory submodule) |
| Power losses | < 1 W |
| Weight | approx. 0.6 kg |

| Memory submodules | 6ES5 910-0AA21 with EPROM | 6ES5 910-0AA31 with EPROM | 6ES5 910-0AA41 with EPROM |
|---|--|---------------------------|---------------------------|
| Memory capacity | 1020 statements | 2044 statements | 4092 statements |
| Weight | 0.4 kg | 0.4 kg | 0.4 kg |
| Data security (based on 2K × 8 bits, 55 °C) | Operation: approx. 4 % failures in 10 years Storage: approx. 0.6 % failures in 20 years | | |

1. Description

1.4 Technical specification

W. Flach Ambg.

| 930 and 931 power supply modules | For internal 5 V supply | | | For external 24 V supply | |
|--|---|-----------------------------|-----------------------------------|---|---------------------------------|
| | 6ES5 930-7AA12 | 6ES5 930-7AA22 | 6ES5 930-7AA31 | 6ES5 931-7AA11 | 6ES5 931-7AA21 |
| Input voltage - rated value - tolerance | 220V AC ¹⁾ -15 %, +10 % | 115V AC -15 %, +10 % | 24V DC <i>35V</i> -15 %, +25 % | 220V AC ¹⁾ -15 %, +10 % | 115V AC -15 %, +10 % |
| Line frequency - rated value - permitted range | 50 Hz 47 Hz to 63 Hz | 50 Hz 47 Hz to 63 Hz | - <i>Schaltregler</i> - | 50 Hz 47 Hz to 63 Hz | 50 Hz 47 Hz to 63 Hz |
| Input current (rated value) | 80 mA | 150 mA | 400 mA | 160 mA | 320 mA |
| Fuse (primary) e.g. Wickmann | T 0.15 A (slow) No. 19198 | T 0.3 A (slow) No. 19198 | T 0.5 A (slow) No. 19195 | M 0.2 A No. 19201 | M 0.4 A No. 19201 |
| Output voltage | 5.2V DC | 5.2V DC | 5.2V DC | 24V DC (unstabilized) | 24V DC (unstabilized) |
| Output current (rated value) | 0.9A | 0.9A | 0.7A | 0.8A | 0.8A |
| Load capability | 100 % at 55 °C | 100 % at 55 °C | 100 % at 55 °C | 75 % at 55 °C 100 % at 45 °C | 75 % at 55 °C 100 % at 45 °C |
| Short-circuit protection | yes, fuse | yes, fuse | 5 min | no | no |
| Permissible duration of voltage dips at rated output current | < 3 ms | < 3 ms | < 2 ms | - | - |
| Power losses | 9 W | 9 W | 9 W | 6 W | 6 W |
| Weight | approx. 0.7 kg | 0.7 kg | 0.4 kg | 0.7 kg | 0.7 kg |
| Notes | Intended for internal 5V supply of the S5-110A PC, sufficient for maximum configuration with I/Os and test modules and 500 programmer interface module. For serial interface: 2 x 930-7AA31 (24V). | | | Intended for external 24V supply, e.g. of relay output modules, the 381 timer/counter module or proximity switches. | |

¹⁾ 240V AC: 6ES5-930-7AA01 on request, 6ES5-931-7AA01 on request

| Digital input modules | 6ES5 400-7AA13 | 6ES5 401-7AA13 | 6ES5 405-7AB11 | 6ES5 405-7AB21 | 6ES5 405-7AB31 |
|---|---|--------------------------------------|--|--------------------------------------|------------------------------------|
| Number of inputs | 8 | 8 (with group signal ¹⁾) | 8 | 8 | 8 |
| Galvanic isolation | yes | | yes | yes | yes |
| Input voltage U_N | 24 V DC | | 115 V UC ⁴⁾ | 220 V UC | 48 V UC |
| Input voltage - for "0" signal - for "1" signal | -35 V to +4.5 V +13 V to +35 V | | 0 to 40 V UC 85 V UC to 132 V UC | 0 to 70 V UC 170 V UC to 264 V UC | 0 to 18 V UC 38 V UC to 65 V UC |
| Input current at "1" signal - suitable proximity switches | 8.5 mA | 8.5 mA | 10 mA AC, 5.7 mA DC | 15 mA AC, 2.4 mA DC | 13 mA AC, 12 mA DC |
| Delay time at signal change: - "ON" "0" → "1" - "OFF" "1" → "0" | DC BEROs ²⁾ 1.5 ms to 5 ms 1.5 ms to 5 ms | | AC BEROs ³⁾ 2.3 ms to 13 ms 2.0 ms to 35 ms | | |
| Total load capability at 1.2 U_N | 100 % based on the sum of the currents of all inputs | | 75 % based on the sum of the currents of all inputs | | |
| Insulation voltage VDE 0160 - for rated value - tested with | internal 5 V voltage to external connection voltage; inputs/outputs of one module towards each other 36 V DC 500 V AC 250 V AC/DC 1.5 kV AC | | | | |
| Internal current consumption (at 5 V DC) | 1 mA | | 1 mA | | |
| Power losses | 3 W | | 6 W | 10 W | 3 W |
| Weight | approx. 0.39 kg | | 0.4 kg | | |

¹⁾ Edge for each group of four can be set externally; see Section 3.2 ²⁾ $I_0 \leq 1.5 \text{ mA}$ ³⁾ $I_0 \leq 5 \text{ mA AC}$; $I_1 \geq 10 \text{ mA}$ ⁴⁾ 115 V UC = 115 V AC/DC

Max. length of signal cables between sensors and digital input modules depending on the method of installation and the voltage in adjacent cables

| Voltage on the signal line Δ Input voltage of the input module | run together | | | | | run separately |
|--|--|---------|------------|----------|----------|--|
| | if adjacent cable has a voltage of 24 V DC | 48 V DC | 48 V AC/DC | 115 V AC | 220 V AC | if separately laid cable has a voltage of 220 V AC |
| 24 V DC | 1500 m | 1500 m | 200 m | 100 m | 50 m | 600 m |
| 48 V DC | 200 m | 3500 m | 800 m | 400 m | 200 m | 3500 m |
| 115 V AC/DC | 100 m | 400 m | 400 m | 500 m | 250 m | no restriction |
| 220 V AC/DC | 50 m | 200 m | 200 m | 250 m | 500 m | no restriction |

1. Description

1.4 Technical specification

| Digital output modules static | 6ES5 410-7AA11 | 6ES5 410-7AA21 | 6ES5 415-7AB11 | 6ES5 415-7AB21 | 6ES5 415-7AA31 |
|--|--|---|--|---|---|
| Number of outputs | 8 | | | | |
| Galvanic isolation | yes | | | | |
| Supply voltage U_S – rated value – permissible range | 24 V DC 3 V DC to 33 V DC | 48 V DC 3 V DC to 53 V DC | 115 V AC 88 V AC to 132 V AC | 220 V AC 176 V AC to 264 V AC | 24 V AC to 48 V AC 20 V AC to 65 V AC |
| Output current at "1" signal | max. 2 A | 2 A resistive 0,5 A inductive | 2 A | 2 A | 2 A |
| Short-circuit protection ¹⁾ : fuse e.g. Wickmann | FF 2.5 A No. 19230 | FF 2.5 A No. 19230 | FF 6.3 A No. 19230 | FF 6.3 A No. 19230 | FF 6.3 A No. 19230 |
| Limitation of voltage induced on circuit interruption | to $U_p = 30$ V DC –17 V | to $U_p = 48$ V DC –8 V | Circuit interrupted at $I = 0$ | | |
| Switching frequency – resistive loads – lamps – inductive loads | 100 Hz 11 Hz 2 Hz | 11 Hz 11 Hz 0.1 Hz | 20 Hz 11 Hz 2 Hz | | |
| Total load capability | 100 % at 20 °C; 50 % at 55 °C (Expressed as a percentage of the sum of the currents of all outputs) see Fig. below | | | | |
| Residual current at "0" signal | max. 1 mA | 1 mA | 8 mA AC | 10 mA AC | 5 mA AC |
| Signal level of outputs – "1" signal | $U_p - 1.8$ V | | | | |
| Max. cable resistance | 2.4 Ω | 4.8 Ω | 11 Ω | 22 Ω | 2.4 Ω to 4.8 Ω |
| Cable length | 400 m | 400 m | 400 m | 400 m | 400 m |
| Insulation voltage rating to VDE 0160 – tested with | Internal 5 V DC voltage to external input voltage, inputs and outputs of a module with respect to each other 500 V AC | | | 1500 V AC | 1500 V AC |
| Internal current consumption (at 5 V) | 16 mA (8 systems) | | 16 mA (8 systems) | | |
| Power losses | 16 W | | 16 W | | |
| Weight | approx. 0.68 kg | | 0.68 kg | | |
| Notes | Digital input modules with the same voltage can be driven (see p. 35) | | Only up to 24 V current-limited Contactors of 3TJ range cannot be driven | | |

| Digital output modules with relays | 6ES5 417-7AA11 | 6ES5 417-7AA21 |
|---|---|--|
| Number of outputs | 8 | |
| Galvanic isolation | yes, for 4 outputs each | |
| Supply voltage U_p – rated – permissible range | 24 V 20...30 V | 24 V 20...30 V |
| Relays | MZ 24 HS | V 23057- A016-A402 |
| Switching capacity of contacts – resistive load | max. 30 V AC/DC 0.5 A min. 80 mV/50 μA | 250 V AC/5 A 30 V DC/2.5 A |
| – inductive load | max. – min. – | 250 V AC/1.5 A, AC 11 30 V DC/0.5 A, DC 11 |
| Contact life in switching cycles | 30V/0.5 A: $5 \cdot 10^5$ 80mV: $10 \cdot 10^5$ | 250VAC/1.5 A: $2 \cdot 10^5$ 30VDC/0.5A: $1.5 \cdot 10^6$ |
| Switching frequency – resistive load | max. 100 Hz | 10 Hz |
| – inductive load | max. – | 2 Hz |
| Total load capability (expressed as a percentage of the sum of the currents of all outputs) | 100 % at 40 °C } 50 % at 55 °C } | see Fig. on right |
| Insulation voltage ¹⁾ to VDE 0160 – tested with | 500 V AC | 1500 V AC |
| Current consumption – internal (at 5 V DC) – external (at 30 V DC) | 16 mA 0.1 A | 16 mA 0.2 A |
| Power losses | 1.5 W | 3 W |
| Weight | approx. 0.7 kg | 0.7 kg |

Load capability of the outputs
Output modules, static

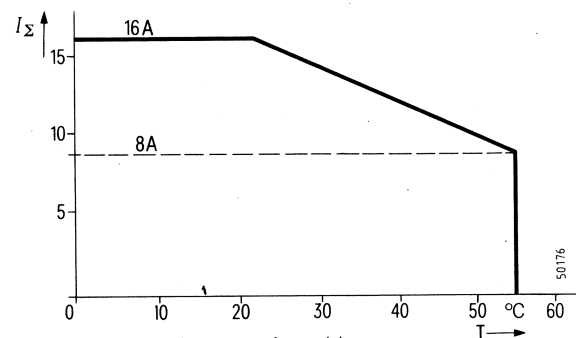

Total current for all eight outputs of a module as a function of ambient temperature.

Output modules, with relays

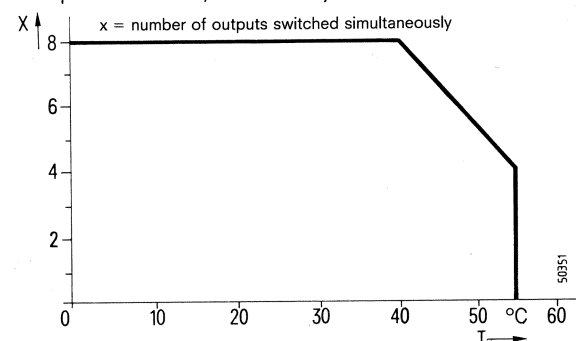

Permissible number of simultaneously switched outputs as a function of ambient temperature.

¹⁾ If short-circuit protection is required

²⁾ Internal 5 V DC voltage against external input voltage. Inputs and outputs of a module against each other.

1. Description

1.4 Technical specification

| 381 Timer/counter module | | 6ES5 381-7AA11 | |
|---|---------|---|---|
| Number of timers | max. | 8 (if no counters are used) | |
| Time ranges , selectable | | with switch (on adapter block) with thumbwheel switch (connected to adapter block) | |
| – Range selection | | | |
| – Fine setting of the range | | | |
| – Time range in switch setting | | | |
| | 0.01 s | 0.01 s to 9.99 s | |
| | 0.1 s | 0.1 s to 99.9 s | |
| | 1 s | 1 s to 999 s | |
| Reproducibility | | 1 unit of the end value of the time range (see Section 1.3.7) | |
| Number of counters | max. | 8 (if no timers are used) | |
| Counting range | | 999 to 0 (down-counting) | |
| – Counting frequency | max. | 100 Hz, $R_E = 2.4 K$ (hardware counter) | |
| – Range selection | | with switch (on adapter block) | |
| – Fine setting of the range | | with thumbwheel switch (connected to adapter block) | |
| Display of current value | | digital display or LED | |
| Supply voltage | | 24 V DC | |
| Distance between | | | |
| – “Set” and “Scan” operations | | 5 statements | |
| – “Set” and “Reset” operations ¹⁾ | | 30 statements | |
| Current consumption | | | |
| – Internal (at 5 V DC) | | 25 mA | |
| – External (at 30 V DC) | | 400 mA | |
| Power losses | max. | 10 W | |
| Weight | approx. | 0.8 kg (1.8 lbs) | |
| Adapter block for 381 timer/counter module | | 6ES5 382-0AA32 (Type I) with thumbwheel switch and LED display | 6ES5 382-0AB32 (Type II) with thumbwheel switch and digital display |
| Time processing | | with internal quartz crystal | |
| Counter processing | | Counting pulses from external 24 V signal | |
| Length of connecting cable between adapter block and – 381 timer/counter module | | Optionally 2.5 m, 5 m or 10 m | |
| – thumbwheel switch or digital display | | 0.2 m | |
| Setting of timer/counter values | | Digital via 3-decade thumbwheel switches | |
| Display | | LED (LED lights up until the time/count is reached) | Digital display (shows the current time) |
| Current consumption (digital display) | | | 50 mA (average value for digits 0..9) |
| Module dimensions (W × H × D) | | 20 mm × 100 mm × 65 mm | 40 mm × 100 mm × 65 mm |
| Weight | approx. | 0.19 kg | 0.34 kg |

¹⁾ For setting and resetting in one scan

| 381 Timer/counter module | | 6ES5 383-7AA12 | |
|---|---------|---|--|
| Number of timers | max. | 16 (if no counters are used) | |
| Number of module locations required | | 2 adjacent locations | |
| Timer/counter ranges , selectable | | with coding switch (on operator's panel) | |
| – Range selection | | inactive | |
| – Time range in position | 0 | 0.01 s to 9.99 s | |
| | 1 | 0.1 s to 99.9 s | |
| | 2 | 1 s to 999 s | |
| | 3 | 1 s to 999 s | |
| – Counters (12 ... 15) | 4 | 1 s to 999 s | |
| Reproducibility | | see Section 1.3.7 | |
| Number of counters | max. | 4 (if not more than 12 timers are used) | |
| Range | | 1 to 999 (up-counting) | |
| Counting range | | 100 Hz | |
| – Counting frequency | max. | | |
| Supply voltage | | 220 V AC | |
| – Rated value | | – 15 %, + 10 % | |
| – Tolerance | | | |
| Line frequency | | 47 to 63 Hz | |
| Current consumption | | | |
| – Internal (at 5 V DC) | | 60 mA | |
| – External (at 220 V AC) | | 1.5 A | |
| Battery backup for timer/counter setpoints | | Lithium battery 3.4 V/1.75 Ah 6ES5 980-0AD41 Life of battery: approx. 3 years | |
| Module dimensions (W × H × D) | | 80 mm × 166 mm × 150 mm | |
| Weight | approx. | 2.23 kg | |
| Operator's panel for 383 timer/counter module | | 6ES5 384-0AA11 | |
| Mounting | | in front panels | |
| Length of cable connector between operator's panel and 383 timer/counter module | | 1.5 m | |
| Internal current consumption (at 5 V DC) | | 280 mA | |
| Degree of protection | | IP 00 | |
| Module dimensions (W × H × D) | | 94 mm × 110 mm × 60 mm | |
| Weight | approx. | 0.48 kg | |
| Keypad for 383 timer/counter module | | 6ES5 384-0AB11 | |
| Number of keys | | 16 | |
| Number of LEDs | | 16 | |
| Mounting | | in front panels | |
| Length of cable between keypad and 383 timer/counter module | | 1.5 m | |
| Internal current consumption (at 5 V DC) | | 200 mA | |
| Degree of protection | | IP 00 | |
| Module dimensions (W × H × D) | | 141 mm × 139 mm × 42 mm | |
| Weight | approx. | 0.44 kg | |

1. Description

1.4 Technical specification

| 380 Timer module | | 6ES5 380-7AA12 | |
|--|------------|---|--|
| Number of timers | | 4 (bit addresses 0 ... 3. Do not use bit addresses 4 ... 7 in the program) | |
| Time ranges, selectable | | with switch | |
| – Range selection | | with internal and/or external potentiometers (R = 500 kΩ; shielded cable max. 10 m) | |
| – Time setting of the range | | | |
| – Time ranges in switch position: | 0.01 s | 0.008 s to 0.160 s | |
| | 0.1 s | 0.05 s to 1.5 s | |
| | 1 s | 0.75 s to 25 s | |
| | 10 s | 7 s to 230 s | |
| Reproducibility | | ± 3 % of the set time | |
| Temperature drift | | + 1 % of set time per 10 °C | |
| Cumulative error | | < 5 % of the set time per 1000 h | |
| Internal current consumption (at 5 V DC) | | 8 mA | |
| Weight | approx. | 0.4 kg | |
| Display module | | 6ES5 418-7AA11 | |
| Display | | Two-digit 7-segment display 0 ... F (hexadecimal) (6 mm × 10 mm) | |
| Control | | Significance 8 4 2 1 | |
| | 1st decade | Bit address X.3 X.2 X.1 X.0 | |
| | 2nd decade | Bit address X.7 X.6 X.5 X.4 | |
| Internal current consumption (at 5 V DC) | | 100 mA (typ.) | |
| Module dimensions | | Standard 110A block | |
| Weight | approx. | 0.4 kg | |

| 311-7 CC interface module | | 6ES5 311-7AA11 | |
|--|---------|---|--|
| Type of interface module | | Serial | |
| Type of interface | | 20 mA current loop (TTY) | |
| Transmission speed | | 2400, 4800 or 9600 baud | |
| Number of | | | |
| – input modules | max. | 16 (± 128 inputs) | |
| – output modules | max. | 15 (± 120 outputs) | |
| Length of cable between 311-7 CC interface module and interfaced higher-order device | max. | 1000 m shielded | |
| Number of 930 power supply units required | | 1 (2 in the case of 930-7AA31) PS in the vicinity of 311 interface module | |
| Internal current consumption (at 5 V DC) | max. | 0.9 A | |
| Module dimensions (W × H × D) | | 40 mm × 166 mm × 150 mm | |
| Weight | approx. | 0.4 kg | |
| 500 Programmer interface module | | 6ES5 500-7AA12 | |
| Type of interface module | | Parallel (see Section 2.5 for guidelines for correct operation) | |
| Internal current consumption (at 5 V DC) | | 0.4 A | |
| Weight | approx. | 0.45 kg | |

| Programmiers | PG 630 C | PG 631 ¹⁾ | PG 670 | PG 675 | |
|-----------------------------------|---|--|---|---|--|
| Type of display | Alphanumeric display | Screen | Screen | Screen | |
| Program representation | LAD STL | LAD STL | LAD STL CSF | LAD STL CSF | |
| Programming modes with 110A PC | off-line on-line | off-line on-line | off-line on-line | off-line on-line | |
| Supply voltage | 110/220 V; 50/60 Hz | 110/220 V; 50/60 Hz | 110/220 V; 50/60 Hz | 110/220 V; 50/60 Hz | |
| Dimensions (W × H × D) (in mm) | | | | | |
| – Unit | | | | | |
| – Case | 380 × 95 × 350 490 × 170 × 390 | 465 × 230 × 375 585 × 260 × 430 | 488 × 290 × 655 536 × 325 × 815 | 340 × 225 × 440 585 × 260 × 430 | |
| Printer interface | 20 mA current loop | 20 mA current loop | 20 mA current loop | 20 mA current loop | |
| Ambient temperature | 0 to +40 °C | 0 to +40 °C | 0 to +40 °C | +10 to +40 °C | |
| Transport and storage temperature | –40 to +70 °C | –40 to +70 °C | –40 to +70 °C | –40 to +70 °C | |
| Weight | approx. 15 kg with case and UV erasing facility | 15 kg with case, without UV erasing facility | 41 kg with case and UV erasing facility | 15 kg without case or UV erasing facility | |

2. Installation

2.1 Installation guidelines

2.1 Installation guidelines

The S5-110A programmable controller is designed for installation in stationary equipment not necessarily free of vibrations. It has been tested as follows:

- 10 ... 58 Hz at 0.075 mm deflection
- 58 ... 500 Hz at max. 1g acceleration,
- Rate of change 1 octave/min,
- Duration of test in three axes at right angles to each other, 20 cycles per axis.

When a control system is installed the following should be taken into account:

1. The controller should be installed on non-moving equipment if possible.
2. If an S5-110A PC is mounted in a cabinet together with contactors, the mounting plate for the S5-110A must be kept separate from the mounting plate for the contactors so that vibrations caused by switching the contactors are not transmitted to the electronics. Installation in separate cabinets may be necessary.
3. If vibrations outside the above limits occur in the vicinity of the S5-110A, measures must be undertaken (e.g. the use of anti-vibration mountings) to reduce the vibrations to within permissible limits.

2.2 Guidelines for the electrical installation

The following guidelines should be adhered to when cabling and wiring the system:

- Cables with different rated operating voltages may be run together in the same cable duct as long as the maximum cable lengths are not exceeded. However, separation of the 24 V and 220 V cables (either separate cables or separately bundled) is to be recommended.
- Supply cables and PE cables should be as short as possible and run in such a way as to avoid inductive or capacitive coupling with the input and output signal lines.
- The cables between the subracks (5 V signals) must be run at some distance from the horizontal wiring ducts and never in the ducts.
- Particular care must be taken to ensure that the connectors of the modules or the cables are clean and secure (no contamination, bus socket connector not loose or pushed out of plastics holder).
- The (24 V DC/48 V) power supply modules may be of simple design, but should have a smoothing capacitor (approx. 4700 μ F/40 V) (induced voltage peak when the power is switched off).
- Earthed operation (L- of the 24 V power supply module earthed) affords more immunity to noise. If earth-free operation is mandatory, an earth fault monitoring system must be installed in accordance with VDE 0100, § 60 and VDE 0113, Section 8. The cores of the 24 V power supply can be earthed with 2 x 35 nF Y capacitors (e.g. B81211-A-B35) as an HF bypass.
- The modules of the 110A PC must not be snapped on or removed with the power on; this is particularly important for the connection between the 500 interface module and the programmer.

2.3 Expansion capability

The single-tier PC contains, in addition to the power supply module (PS) and the central processing unit (CPU), eight (16 *) locations for I/O modules (input, output and timer modules) in any mix.

Graduated expansion of the PC is possible by adding further mounting racks to obtain up to four-tier (two-tier *) configurations. The electrical connection between the bus cables of the mounting racks is established by means of cable connectors.

Addressing the modules

The S5-110A programmable controller has location-oriented addressing, i.e. when programming, a module is addressed with the address of the socket connector into which it is plugged. The individual module location addresses are printed on the socket connectors. The upper row of addresses applies to the first and third tiers (the first eight I/O module locations *) , the lower row to the second and fourth tiers (the last eight I/O module locations).

Module configurations

1. Two module locations with the same address must not accommodate identical modules.
2. Only **one** timer module may be plugged into locations with the same address; the second location with the same address must be left free.

Example (standard mounting rack):

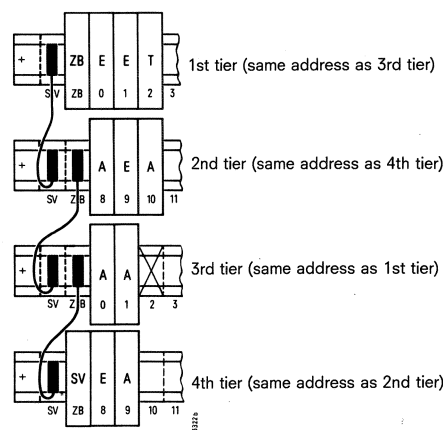

If locations 1 and 2 of the first tier have input modules plugged into them, module locations 1 and 2 of the third tier can only take output modules.

If module location 3 of the first tier is occupied by a timer module, module location 3 of the third tier must remain free.

If module location 1 of the second tier has an output module plugged into it, module location 8 of the fourth tier can only take an input module.

If different cable connectors are used (-711- and -713-), the addresses of tier 1 can be made to correspond to those of tier 2 and those of tier 3 to those of tier 4.

*) If extra-long mounting racks are used.

2. Installation

2.3 Expansion capability/Addressing

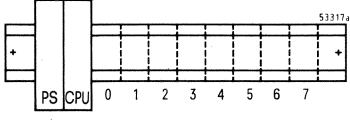
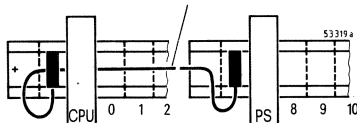
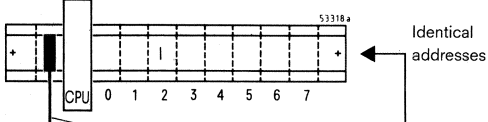
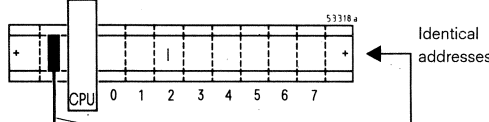
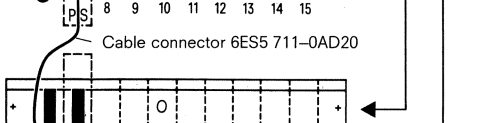
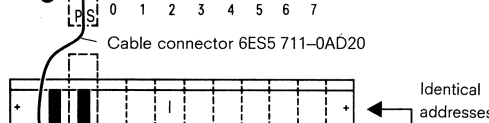
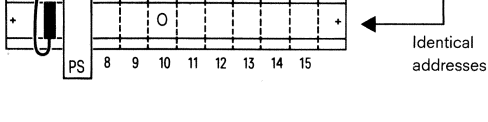
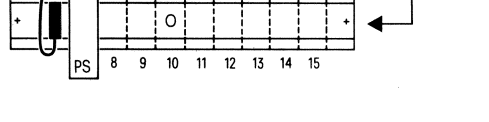
| Degree of expansion | Mounting rack (standard length) 6ES5 710-0SA11 (8 I/O module locations per mounting rack) | | Cable connector 6ES5 711-0AJ00 |
|---------------------|--|-------------|--|
| Single tier |  | Single tier |  |
| Two tiers |  | Two tiers |  |
| Three tiers |  | Three tiers |  |
| Four tiers |  | Four tiers |  |

Configuration I

Configuration II

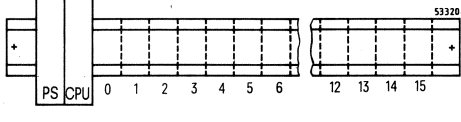
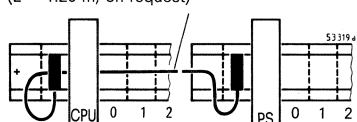
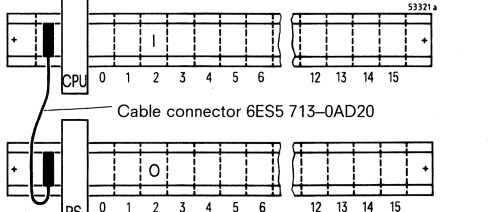
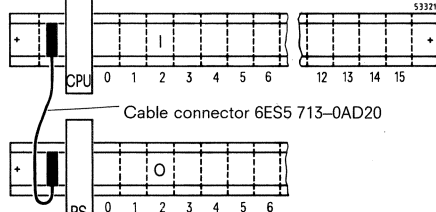
| Degree of expansion | Mounting rack (extra-long) 6ES5 710-0SA41 (16 I/O module locations per mounting rack) | | Cable connector 6ES5 713-0BB20 (L = 1.20 m, on request) |
|---------------------|--|-------------|--|
| Single tier |  | Single tier |  |
| Two tiers |  | Two tiers |  |

The shorter mounting rack can also be installed at the top.

2. Installation

2.4 Construction and dimensions

The mounting rack of the S5-110A programmable controller can be installed as follows:

It can be fixed to mounting plates or any other vertical mounting surface, or installed in cabinets (with dimensions in inches or mm).

In the case of two to four-tier arrangements (one above the other), a clearance of at least 300 mm (centre-to-centre) should be left between the mounting racks in order not to impede the flow of air and to provide access to the modules for installation and dismantling.

The dimensions are given in the diagrams on the following pages of this section.

The I/O modules are snapped onto the socket connectors of the mounting rack. This establishes the connection to the CPU and power supply via the bus cable.

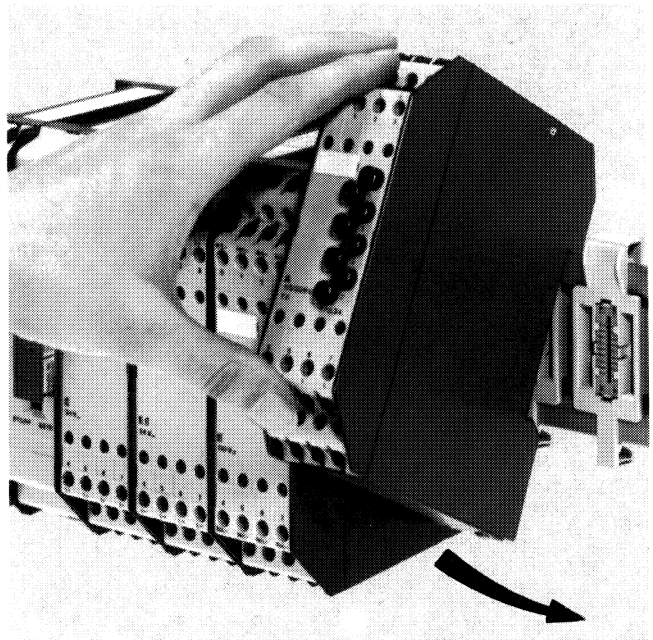

Fig. 16 Snapping an I/O module onto the mounting rack

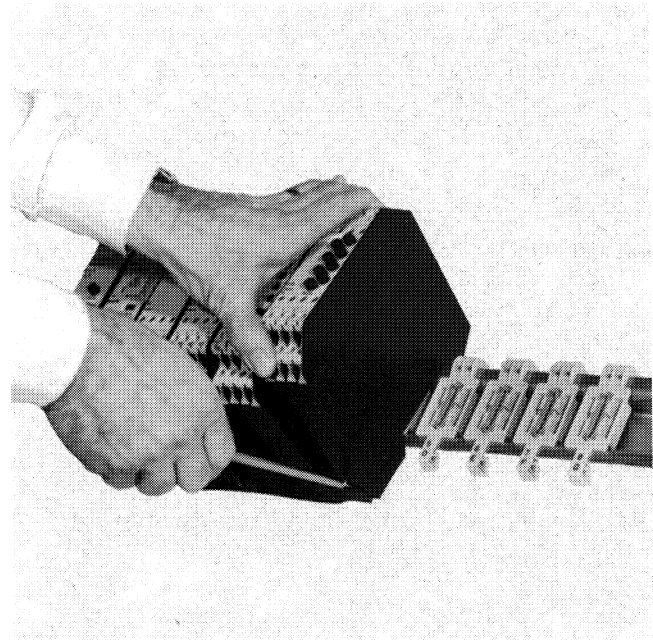

Fig. 17 Removing an I/O module

The module is removed as shown in the illustration opposite by unhooking it from the snap-on connector using a screwdriver and then levering it up with one hand.

2. Installation

2.4 Construction and dimensions

2.4 Construction and dimensions

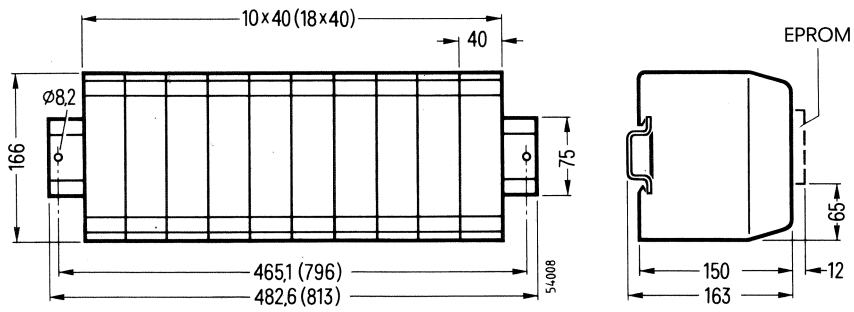

Fig. 18 Single-tier configuration
The values given in brackets are for the extra-long mounting subrack

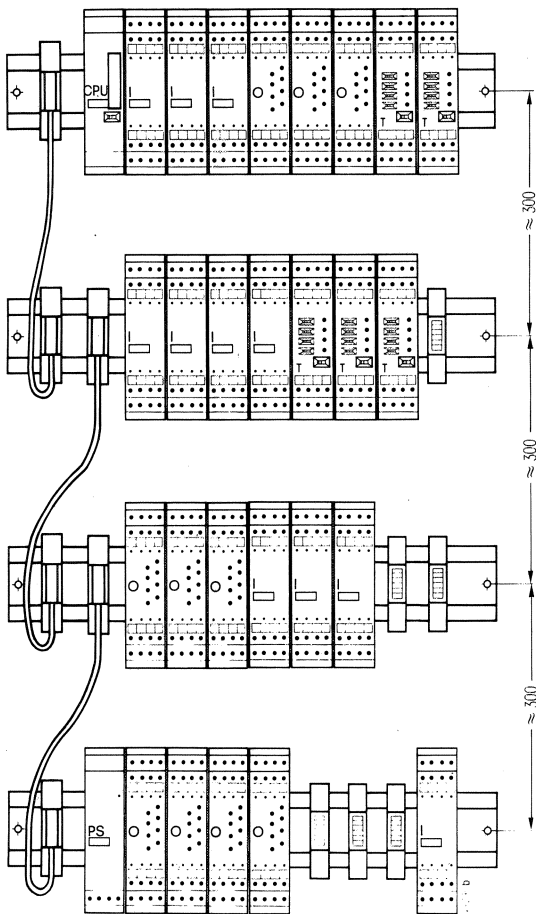

Fig. 19 Four-tier configuration

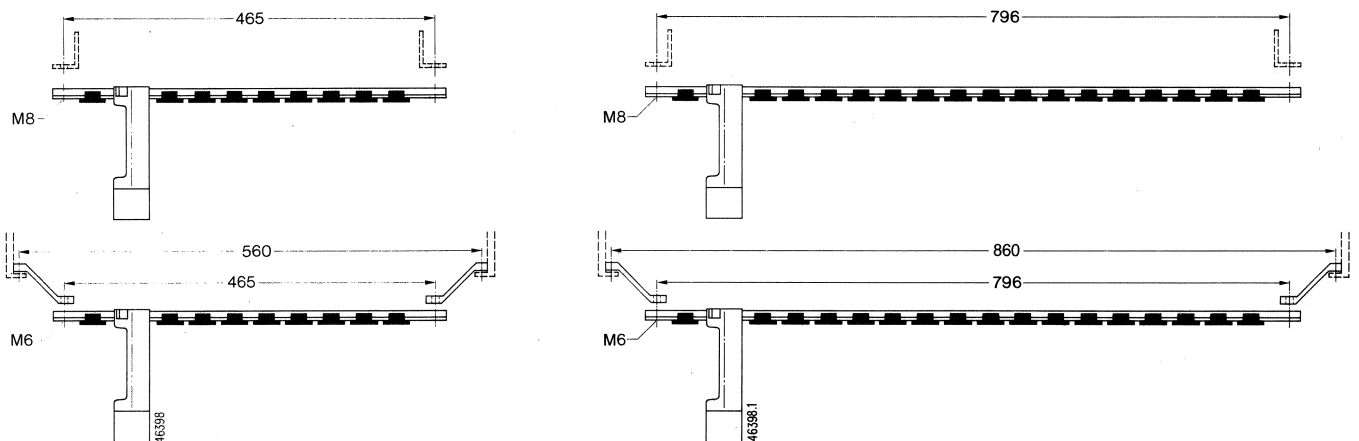

Fig. 20 Installation in cabinets Top: Cabinets with dimensions in inches
Bottom: Cabinets with metric dimensions (e.g. 8MF cabinets as in Catalog NV 2)

2. Installation

2.4 Construction and dimensions

2.4 Construction and dimensions (in mm)

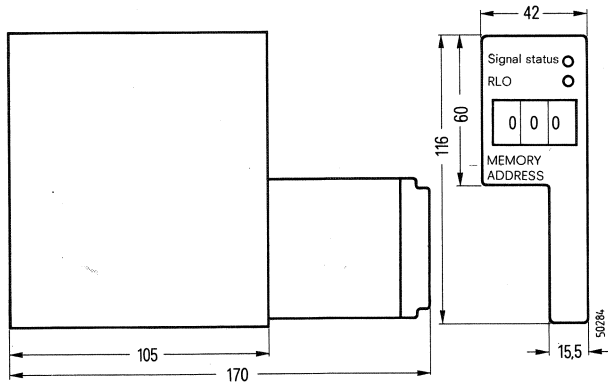

Fig. 21 332 Test adapter

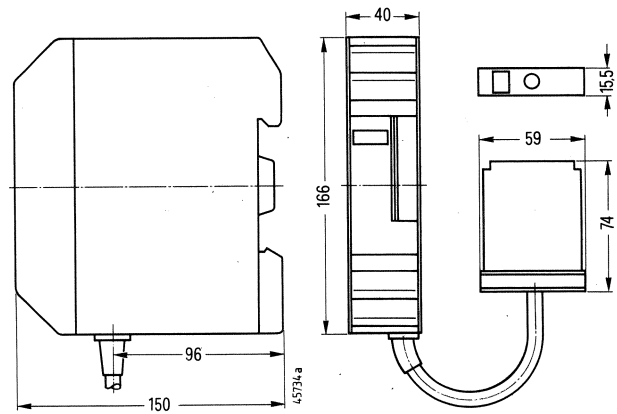

Fig. 22 500 Programmer interface module and 330 test module

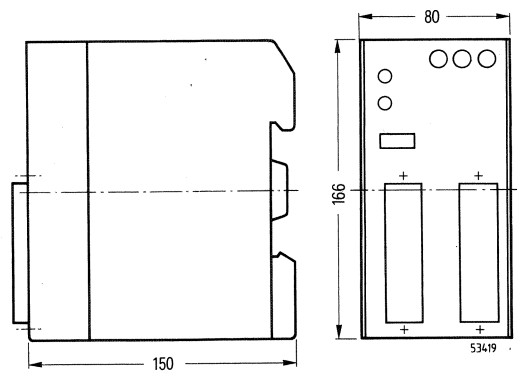

Fig. 23 383 Timer/counter module

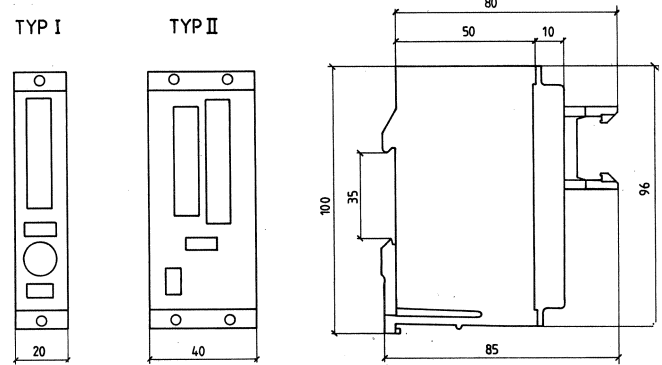

Fig. 24 Adapter blocks for 381 timer/counter module

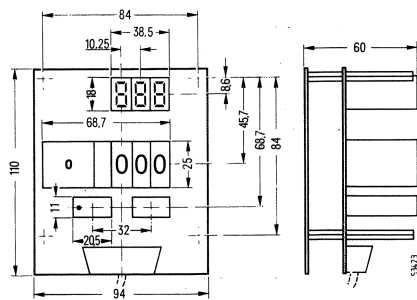

Fig. 25 Operator's panel for 383 timer/counter module

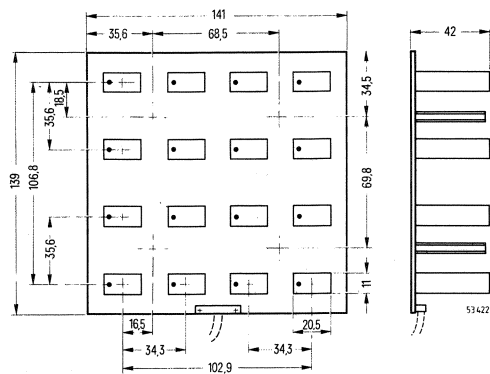

Fig. 26 Keypad for 383 timer/counter module

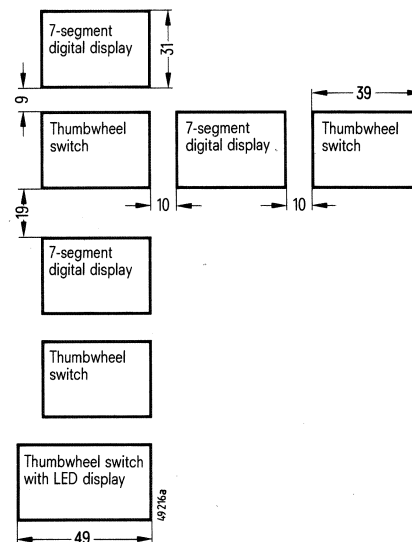

Fig. 27 Panel cutouts for thumbwheel switches with and without LED display and 7-segment digital display

2.5 Connections

The designation of the module terminals are summarized on the following page.

Terminal marking

| | |
|--------------------|-----------------------------------|
| AC supply: | DC supply: |
| L1 \triangle (R) | L+ \triangle (P) \triangle + |
| L2 \triangle (S) | L- \triangle (M) \triangle - |
| L3 \triangle (T) | |
| N \triangle | Mint \triangle Earth (internal) |
| PE \triangle | |

Each terminal can take two external leads with cross-sections of

- 1 to 2.5 mm², solid conductors and
- 0.75 to 1.5 mm², stranded conductors (using end sleeves)

Permissible tightening torque 80 to 100 Ncm.

The **930 power supply module** (available for 240 V AC, 220 V AC, 115 V AC or 24 V DC) is connected to the line voltage, and the protective earth conductor to the "PE" terminal.

The "Mint" terminal should only be connected for on-line operation (see p. 2.8). This increases the immunity to noise during operation with the programmer.

In the case of **static input/output modules**, all eight inputs/outputs are floating. The module inputs/outputs must only be used for the specified voltage.

The screw terminals for the input and output signal lines of the I/O modules are arranged at the top and bottom of the blocks in double rows.

If the inputs or outputs are not used as independent bipolar contacts, the supply potential can be looped with plug-in jumpers (6ES5 763-0AA11; 20 per packet).

In the case of **relay output modules**, each of the six separate supply terminals can be connected to different voltages (e.g. 220 V AC, 115 V AC, 24 V DC, 48 V AC). Of the eight outputs, Nos. 0 to 3 are fully isolated and any desired voltage can be applied to them. In the case of outputs 4 to 7, the voltage applied to the left-hand and right-hand outputs must be the same as that applied to the corresponding inputs (see p. 2.7). Moreover, a 24 V DC voltage (terminals L+ and L-) is required for the internal power supply.

The 931 power supply module can supply power for eight 6ES5 417-7AA11 relay modules or four 6ES5 417-7AA21 relay modules.

380 Analog timer modules:

- The TR, Mint and Q0 . . . 3 terminals must only be used for time setting (see Section 3.2).
- If no external potentiometers are connected to the 380 timer module, the respective terminals must be short-circuited (the module is supplied with the jumpers already inserted).
- 500k external potentiometer connected via shielded cables with a maximum length of 10 m.
- No external power supply required; supply from 5 V bus.

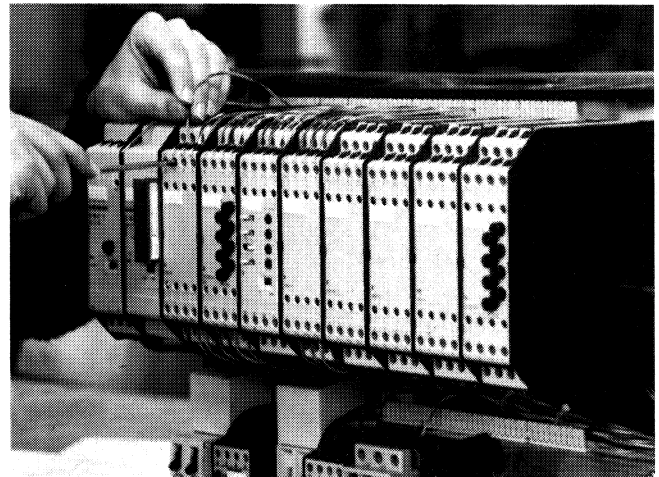

Fig. 28 Connecting the external leads

381/382 Timer/counter module

- Connection of 24 V DC voltage from front. (The 931 power supply module can power two 381 blocks.)
- Connection of the 24 V signal lines for counting operations
- Cables to the 382 adapter block must be run at a safe distant from the input/output lines.
- If interference occurs, the L- terminal must be connected to PE.

383 Timer/counter module:

See also Operating Instructions GWA 4NEB 807 0524-02

- The module requires a 220 V AC mains supply.
- Connection of operator's panel and keypad
- Connection of cable shield from the operator's panel and keypad to the metal housing
- Connection of the PE cable

381 timer/counter module

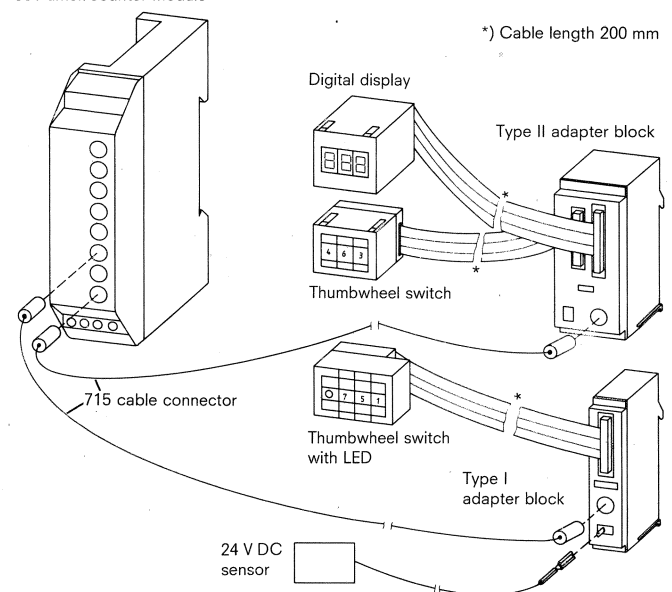

Fig. 29 381 Timer/counter module with adapter blocks, thumbwheel switches and digital display

2. Installation

2.5 Connections

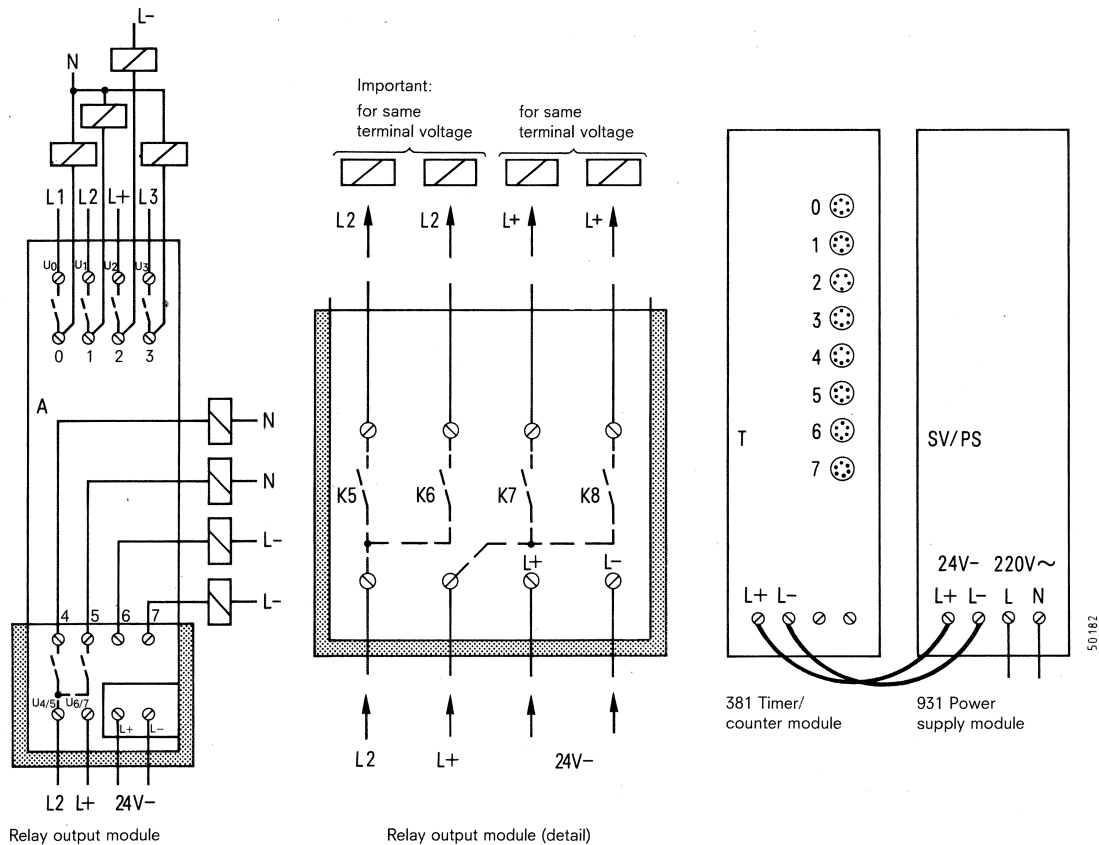
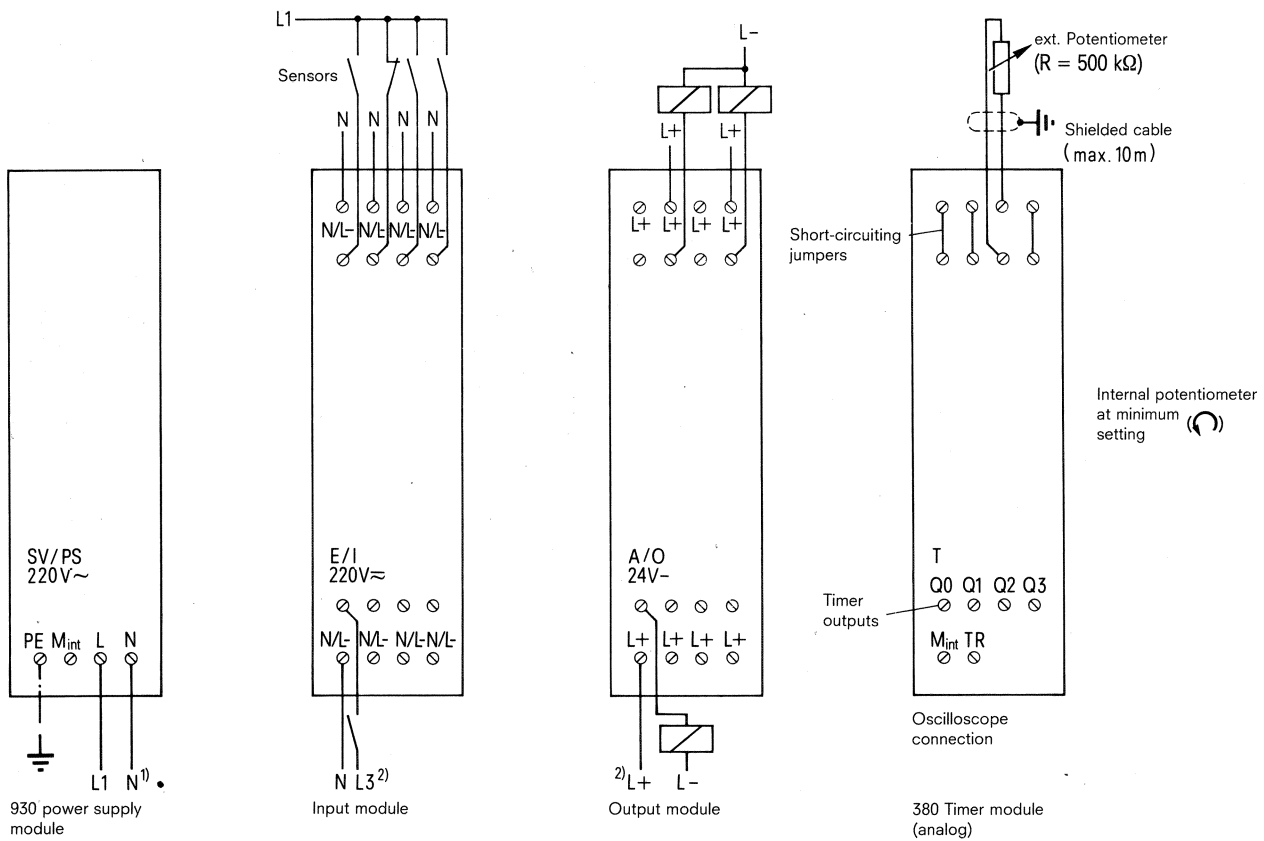

Fig. 30 Module connections

¹⁾ 240 V AC, 220 V AC, 115 V AC or 24 V DC, depending on the module type

²⁾ All inputs or outputs have the voltage for which the module is designed.

500 Programmer interface module

The interface module can be snapped onto the 75 mm standard sectional rail next to the CPU. It has no contact to the bus. The cable connector is plugged into the receptacle for the memory submodule on the CPU and the programmer cable connected via the 50-way connector (Section 1.3.9).

The following arrangement must be adhered to for disturbance-free operation:

1. Connect the subracks to each other and to the PE terminal.
2. Do not run the 734 cable connector in the same cable duct as the external module connection cables.
3. Connect the "Mint" terminal of the power supply module directly with the "PE" terminal of the 500 interface module.
4. Do not connect the "PE" terminal of the power supply module direct to the "Mint" terminal, but connect it with a separate cable to the rack earth (PE).
5. Connect the "PE" terminal of the interface module to the subrack.
6. If a mains filter (SIEMENS – Type B84 102–K40) is used, connect the PE terminal by the shortest possible route to the rack earth (PE) using a separate wire.

If the 6ES5 500–7AA12 interface module **and** a 6ES5930–7AA12/22 power supply module (with integrated mains filter) are used, the common mains connection can be dispensed with (Fig. 32).

In extremely noisy environments, a configuration as shown in Fig. 31 is also recommended.

In the case of a 24 V DC power supply (930–7AA31), the recommended configuration is as in Fig. 32. There is less susceptibility to noise if the power supply module is earthed (L-potential to PE).

Note: Connecting and disconnecting the 734 cable connector under power is only possible if the "Mint" terminal of the power supply has been connected.

See Section 1.3.10 for installation of the 330 test module and 332 test adapter.

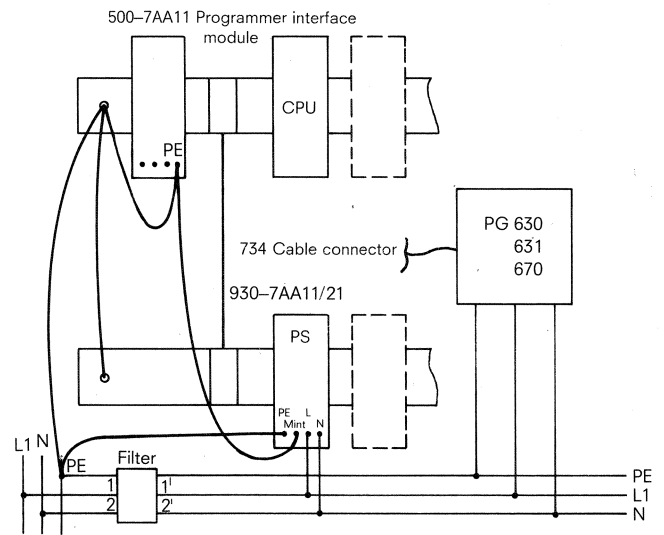

Fig. 31 On-line arrangement with 6ES5 500–7AA11 interface module and 6ES5 930–7AA11/21 power supply module

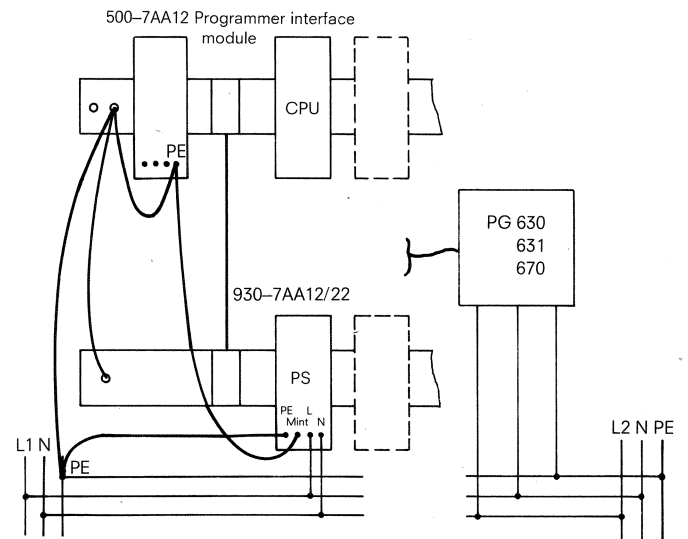

Fig. 32 On-line arrangement with 6ES5 500–7AA12 interface module and 6ES5 930–7AA01/7AA12/7AA22/7AA31 power supply module

2.6 RI suppression

The S5–110A PC generates noise as a result of the discrete frequencies involved and the use of Triacs on the AC output modules. If the following recommendations are observed, the threshold values B of VDE 0871 are adhered to.

- For 240 V, 220 V and 115 V AC the 6ES5 930–7AA01/12/22 power supply modules with integral suppression filters are used.
- For 24 V DC, it must be ensured that at least version C of the 6ES5 930–7AA31 power supply module is used.
- All AC output lines over 2 m long must be suppressed as follows:

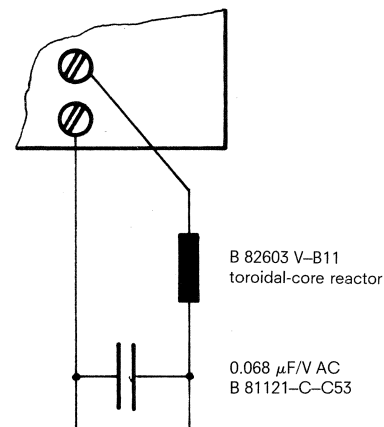

Fig. 33 RI suppression with RC elements

3. System start-up and operation

3.1 Checking the system

3.1 Checking the system

1. Is the control system switched off?
2. Is the wiring correct?
3. Have the installation guidelines been followed?
4. Is the PE conductor correctly connected?
5. Make certain that there are no connections to circuits with higher voltages!
6. Are the voltages within the permitted ranges?
7. Start-up the control system initially without applying the load voltage for the output modules.

3.2 Settings and signals

930 Power supply module

The PC power supply (5 V) is switched on by putting the switch on the front of the module from "0" to "1".

An LED shows that the 5 V supply is available. If there is no 5 V supply, the fuse must be checked.

931 Power supply module

The controls are the same as those of the 930 power supply module. In this case, however, the output voltage is 24 V DC.

900 Central processing unit

Move the "NR" (non-retentive) – "R" (retentive) switch to the required position:

- "NR" position: flags non retentive
- "R" position: flags retentive

Set mode selector to required position.

- "Stop" position: processor is in the stop state
- "Cycle" position: the processor operates cyclically

The red Stop LED indicates that:

- the mode selector is in the "Stop" position
- the backup battery **was** low (only in "R" position)
- there is an undervoltage in the 5 V supply
- the scan time monitor has responded.

410, 415 and 417 Output modules

The green LEDs display the signal status of the outputs. They are bright when there is an output signal.

Note: The LEDs are in the 5 V control circuit and only display the signal status. If a fuse blows, this is not displayed. The advantage of this arrangement is that process outputs can be traced without having to apply the load voltage.

400/401/405 Input modules

The green LEDs display the signal status of the inputs. They are bright if there is an input signal.

Note: The LED is on the primary side before the optocoupler. The displays are also bright even if the PC is switched off if the load voltage (220 V AC, 110 V AC, 48 V AC or 24 V DC) is still applied.

401 Input module (interrupt)

Each group of four inputs can be set by means of two switches at the rear of the module to generate an interrupt signal on the positive-going or negative-going edge of the input signal pulse.

Viewed from the back of the block:

- Left switch position signifies negative-going edge
- Right switch position signifies positive-going edge

In exceptional cases, interrupt generation can be suppressed by opening the module and removing individual jumpers. The module then has the same characteristics as a normal 400 input module.

E/I 0...3 →



E/I 4...7 →

3. System start-up and operation

3.2 Settings, signals

380 Timer module (analog)

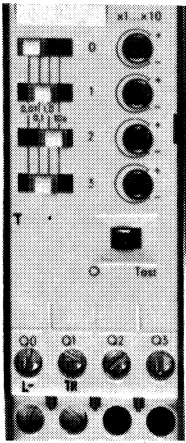

Fig. 34 Timer setting with sliding switch and potentiometer

- Put the four switches, each of which can be set to one of four time ranges, into the desired position (coarse time setting).
- Fine setting by means of potentiometers on the front of the module and/or by means of external potentiometers ($R = 500 \text{ k}\Omega$) connected in series. These external potentiometers are connected instead of the jumpers. Maximum length for shielded cable is 10 m; shield connected to the "PE" terminal.
- The times set are checked using the Test switch. **Important:** First move the mode selector on the CPU to the "Stop" position, then put the Test switch on the timer module to the "Test" position. This causes all four timers to run. The running of the timers can be observed on the respective LEDs.

The four LEDs are bright as long as the timer is running, even if the timers are started via the process. The fine setting is made by means of a stopwatch or an oscilloscope connected to the terminals in the bottom row (terminals: Q0 to Q3 = Timer outputs; TR = Trigger; L- = Mint).

Note: The timers X4 . . . X7 must not be used as output flags.

382 Adapter blocks for the 381 timer/counter module

The adapter blocks contain the following:

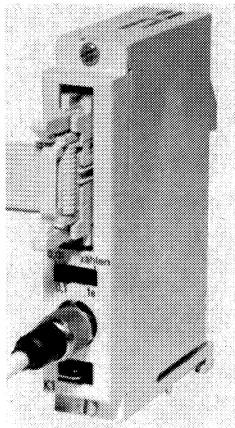

Fig. 35 Controls and terminals on the Type I adapter block

- A switch with four positions:
 - Three positions for the time ranges 0.01 s; 0.1 s and 1 s, and a "Counter" position.
- A terminal lug "K1" for connecting a 24 V DC signal for counting.
- A "Bu 2" socket for the connector of a 715 cable from the timer/counter module.

Time processing: Time base derived from internal quartz crystal oscillator.

Counting: Counting pulses derived from external 24 V DC signal.

The required time or count is set on the three-decade thumbwheel switch. The time can be monitored either by an LED (Type I 382-0AA32) or a 7-segment display (Type II 382-0AB32).

383 Timer/counter module

See Operating Instructions, Order No. GWA 4NEB 807 0524-02

500 Interface module

Check the measures taken to suppress noise (see Section 2.5).

When interconnecting the programmer, the programmer interface module and the CPU, make sure that this is carried out with the units switched off or that the Mint terminal is permanently wired to the PE conductor.

In addition to the programmed STEP 5 statement, the signal status (SIGN) and result of the logic operation (RLO) can be displayed on the programmer.

The signal status displayed is "1" (bright) if the input, output or flag scanned is in the "1" state.

For latching/unlatching operations (=, S (L), R (U)), the display of the signal status is without significance (random value on the highresistance D_{in} line).

The result of the logic operation is the result **after** processing the current statement in combination with the previous status.

330 Test module/332 Test adapter

See Operating Instructions, Order Nos.

GWA 4NEB 807 0518-02a (330)

GWA 4NEB 807 0515-02a (332)

The comments on the 500 interface above with regard to signal status and the result of the logic operation also apply here.

4. Maintenance

The modules require practically no maintenance.

4.1 Replacing the Ni-Cd batteries (CPU)

The Ni-Cd battery must be replaced every two years. This can be done by the customer himself:

1. The CPU can, but need not, be removed for replacing the battery. The battery can also be replaced during operation.
2. Remove the frontplate by inserting a screwdriver into the groove at the bottom of the frontplate and then levering the latter off.
3. Pull out the battery connecting plug and remove the battery unit.
4. Insert a new battery unit (6ES5 980-0AC11) in the reverse order.

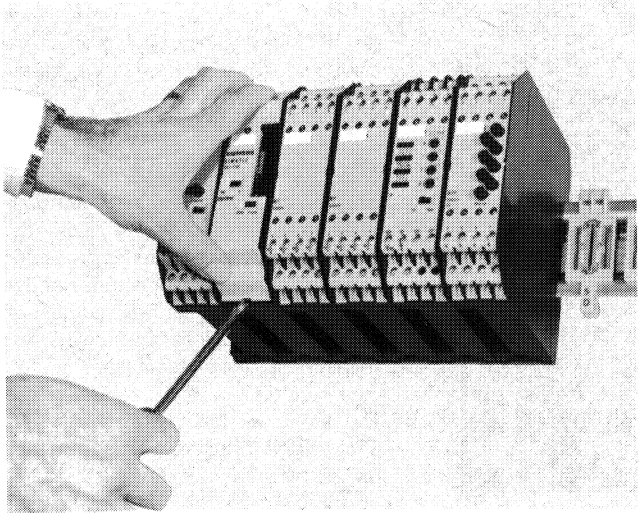

Fig. 36 Removing the frontplate

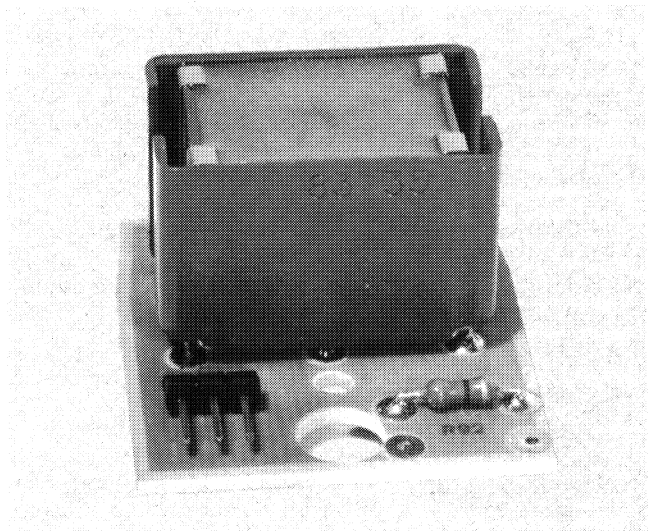

Fig. 37 Battery with connecting plug

It takes three days to fully charge the battery. However, operation can be resumed after about 1 minute by putting the mode selector to "Cycle".

4. Maintenance

4.2 Testing and troubleshooting

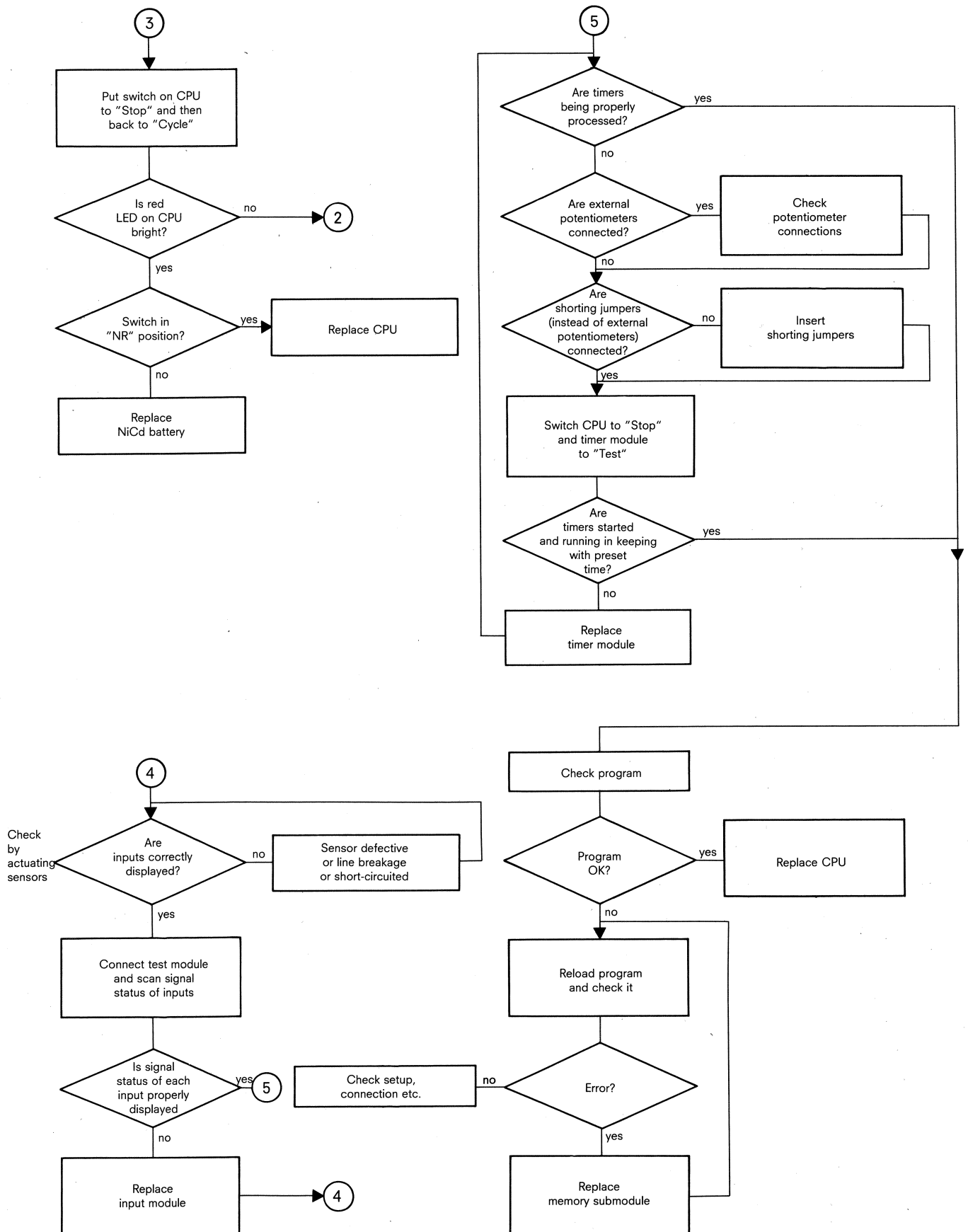









Fig. 39 Troubleshooting flowchart, continued

5.1 Overview of STEP 5 operations for the S5-110A programmable controller

5.1 Overview of STEP 5 operations for the S5-110A PC

| Operation | | Operand | | | Description |
|-------------------------------------|---|---------|-----------------|---|--|
| Representation Statement list | Ladder diagram | I | Q ¹⁾ | F | |
| STL | LAD | | | | |
| A |  | | | | Normally open contact in series, scanning for "1" |
| | | | | | 0.0 |
| AN |  | | | | Normally closed contact in series, scanning for "0" |
| O |  | | | | Normally open contact in parallel, scanning for "1" |
| ON |  | | | | Normally closed contact in parallel, scanning for "1" |
| S |  | | | | Latch if RLO = "1"; no action if RLO = "0" |
| | | | | | 0.0 |
| R |  | | | | Unlatch if RLO = "1"; no action if RLO = "0" |
| | | | | | 0.0 |
| = |  | | | | Assignment (latch if RLO = "1"; unlatch if RLO = "0") |
| NOP 0 | NOP 0 | | X | | No operation: Overwriting erroneously programmed statements |
| NOP 1 | NOP 1 | | X | | No operation: Keeping memory locations free |
| BE | BE | | X | | Unconditional block end; return to beginning of program |
| BEC | BEC | | X | | Conditional block end; if RLO = "1", return to beginning of program. If RLO = "0", no operation is executed. BEC has no effect on first input bit scan (ERAB). BEC always triggers scan time monitoring, BEC loops therefore do not cause shutdown. BEC illegal in SF 0.0 – RF 0.0 sequence. |

Key to operand identifiers:

- I Input
- Q Output (coil)
- F Flag (internal relay)

¹⁾ F 0.0 statements can be used without restriction in the case of the 500-7AD11 CPU.

5. Appendix

5.1 Overview of STEP 5 operations for the S5-110A PC

| Organization | | | Parameter range | MC5 (Hexadecimal) | | Comments |
|---|------------------------------|----------------------|---|----------------------------|-----------------------------|---|
| PG 670 PG 631 | PG 630 C | PG 610 Test 330 | | 1st byte + bit address | 2nd byte + block address | |
| A I AN I O I ON I | A I AN I O I ON I | 0 1 4 5 | 0.0 ... 15.7 | C0 E0 C8 E8 | 00 00 00 00 | |
| A Q AN Q O Q ON Q | A Q AN Q O Q ON Q | 2 3 6 7 | I/Os 0.0 ... 15.7 Flags: 16.0 ... 63.7 | C0 E0 C8 E8 | 80 80 80 80 | |
| A F AN F O F ON F | A F AN F O F ON F | 2. 3. 6. 7. | 0.1 ... 63.7 | 80 A0 88 A8 | 00 00 00 00 | |
| S Q R Q = Q | S Q R Q = Q | A b E | I/Os 0.0 ... 15.7 Flags: 16.0 ... 63.7 | D0 F0 D8 | 80 80 80 | |
| S F R F = F | S F R F = F | A. b. E. | 0.1 ... 63.7 | 90 B0 98 | 00 00 00 | The respective bit/block address must be added here |
| A F S F R F | A F S F R F | 2. A. b. | 0.0 | 80 90 B0 | 00 00 00 | |
| NOP ∅ NOP 1 BEC BE | * 08 * 07 * 00 * 09 | 8 F □ 9 | — | 00 FF 05 65 | 00 FF 00 00 | Organizational operations |
| Blank line STL CSF LAD End of segment | * 11 * 12 * 13 * 10 | | — | 10 10 10 10 10 | 82 83 84 85 FF | Screen statements |

5.2 Interface assignments

Memory interface

Shown on the plug connector of the memory submodule (looking at the pin side)

| | c | b | a |
|----|----------------------|------------------|------------------------|
| 1 | \overline{RI}_0 | 0V | +5V (V _{cc}) |
| 2 | A ₀ | A ₁ | A ₂ |
| 3 | A ₃ | A ₄ | A ₅ |
| 4 | A ₆ | A ₇ | A ₈ |
| 5 | A ₉ | A ₁₀ | A ₁₁ |
| 6 | PD1 | PD2 | \overline{BE} |
| 7 | NOP | VKE | STAT. |
| 8 | ZS | \overline{T}_1 | K6 |
| 9 | FP | FR | STOP |
| 10 | O ₀ | O ₁ | O ₂ |
| 11 | O ₃ | O ₄ | O ₅ |
| 12 | O ₆ | O ₇ | K1 |
| 13 | $\overline{CS1}$ | \overline{RIA} | K2 |
| 14 | $\overline{CS2}$ | \overline{TS} | K3 |
| 15 | \overline{T}_{ext} | PSW | K4 |
| 16 | V _{pp} | 0V | K5 |

- A₀ to A₁₁ Address bus, bits 0 to 11
- O₀ to O₇ Data bus, bits 0 to 7
- $\overline{CS1}$, $\overline{2}$ CHIP SELECT. Enabling of first and/or second chip (EPROM) of the user memory
- PD1, 2 Programming input of first and/or second chip (EPROM) (enable signal for "Read")
- K1 to K5 Identifier for memory capacity (0.5K, 1K, 2K or 4K statements)
- K5 Battery test pin
- VKE Result of logic operation
- STAT. Signal status of input modules and RAM
- \overline{BE} End of block
- \overline{RIA} Request for initializing pulse
- \overline{TS} Clock generator stop
- \overline{T}_{ext} External clock
- \overline{T}_1 Clock for CPU
t₁ = 3.0 μs (pulse)
t₂ = 17.0 μs (interval)
- NOP No operation (test module, "1" ≙ NOP)
- ZS Address counter stop
- FP, FR Enable I/Os and/or RAM
- \overline{RI}_0 Internal initializing pulse
- STOP Cycle/Stop identifier ("1" ≙ Stop)
- V_{pp} Supply voltage for readout (+5V) or for programming (+25V) the EPROM
- PSW Diagnostic software; also acts as memory identifier

Socket connectors (I/O)

| | | | | |
|----|------------------|--|-----------------|----|
| 2 | +5V | | E/A | 1 |
| 4 | Z2 | | Z1 | 3 |
| 6 | F6 | | F7 | 5 |
| 8 | JR | | RI | 7 |
| 10 | F4 | | F5 | 9 |
| 12 | D _{OUT} | | D _{IN} | 11 |
| 14 | F2 | | F3 | 13 |
| 16 | K1 | | K2 | 15 |
| 18 | F0 | | F1 | 17 |
| 20 | M- | | K0 | 19 |

- I/O Enable input (= "0") and/or output blocks (= "1")
- Z1, Z2 Tier enable for blocks in central controller
- F0 to F7 Addressing of blocks
- K0 to K2 Addressing of inputs/outputs on the block selected
- D_{in} DATA IN, signal status of inputs
- D_{out} DATA OUT, signal status for latching outputs
- RI Initializing pulse
- JR Interrupt; group signal of respective digital input module
- M- 0 V DC

Identifiers for the memory submodule

Important: Avoid touching the PCB or the ICs on the memory submodule.

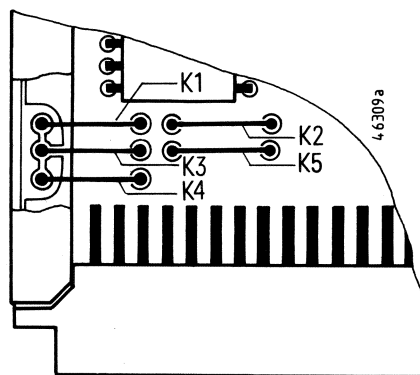

| Memory configuration (statements) | Jumpers inserted |
|-----------------------------------|------------------|
| 0.5 K | K 3 |
| 1 K | K 3, K 4 |
| 2 K | K 1, K 3, K 4 |
| 4 K | K 1, K 3, K 5 |

Jumper assignments on the memory submodule for the relevant memory configuration.

5. Appendix

5.3 Signal sequence at the I/O interface

5.3 Signal sequence at the I/O interface

The S5-110A programmable controller operates with a basic clock T1 for reading statements in the correct order and an auxiliary T2 for controlling data transfer at the I/O. The negated signal of the basic clock T1 can be monitored at the memory interface (b8). The signal of auxiliary clock T2 can be accessed either at interface C9 or at I/O interface Z1 (pin 3) and Z2 (pin 4).

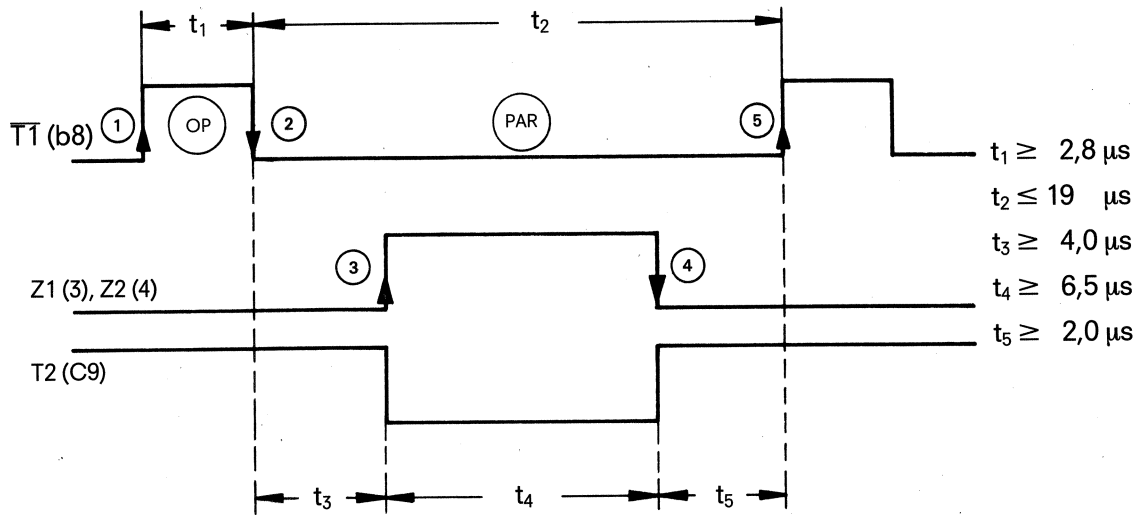

Fig. 40 Signal timing diagram

- ① Increment program counter
- ② Store statement (1st byte), address output, input module enable
- ③ Output module enable
- ④ Store output signal
- ⑤ Transfer RLO register, increment program counter

6. Spare parts

| Components of the S5-110A PC | Order No. | Weight approx. kg | Components of the S5-110A PC (continued) | Order No. | Weight approx. kg |
|--|--|--------------------------|--|---|--------------------|
| Mounting rack (standard length)¹⁾ with bus cable, for power supply module, CPU and up to 8 I/O modules | 6ES5 710-0SA11 | 1.53 | 330 Test module | 6ES5 330-7AB11 | 0.52 |
| Mounting rack (extra long)¹⁾ with bus cable, for power supply module, CPU and up to 16 I/O modules | 6ES5 710-0SA41 | 2.56 | 332 Test adapter | 6ES5 332-0AA11 | 0.5 |
| Cable connectors (see Section 2.3) between mounting racks 6ES5 710-0SA11 Mounting one above the other length 0.32 m side by side length 0.8 m | 6ES5 711-0AD20 6ES5 711-0AJ00 | 0.06 0.07 | 380 Timer module 4 timers 10 ms to 100 s | 6ES5 380-7AA12 | 0.4 |
| between mounting racks 6ES5 710-0SA41 Mounting one above the other length 0.32 m side by side length 1.2 m | 6ES5 713-0AD20 6ES5 713-0BB20 | 0.06 0.07 | 381 Timer/counter module 8 timers/counters | 6ES5 381-7AA11 | 0.8 |
| 930 Power supply modules for internal 5 V supply: 240 VAC/5 VDC, 0.9 A ²⁾ 220 VAC/5 VDC, 0.9 A 115 VAC/5 VDC, 0.9 A 24 VAC/5 VDC, 0.7 A | 6ES5 930-7AA01 6ES5 930-7AA12 6ES5 930-7AA22 6ES5 930-7AA31 | 0.7 0.7 0.7 0.4 | Adapter block type I (3 decades) complete for 381 timer/counter module with thumbwheel switch and LED display | 6ES5 382-0AA32 | 0.19 |
| 931 Power supply module for external 24 V supply: 240 VAC/24 VDC, 0.8 A ²⁾ 220 VAC/24 VDC, 0.8 A 115 VAC/24 VDC, 0.8 A | 6ES5 931-7AA01 6ES5 931-7AA11 6ES5 931-7AA21 | 0.7 0.7 0.7 | Adapter block type II (3 decades) complete for 381 timer/counter module with thumbwheel switch and 7-segment display | 6ES5 382-0AB32 | 0.34 |
| 900 CPU retentive/non-retentive for all memory submodules | 6ES5 900-7AD11 | 0.4 | Cable connector between 381 timer counter module and interface blocks length 1.5 m 5 m 10 m | 6ES5 715-0BC50 6ES5 715-0BF00 6ES5 715-0CB00 | 0.06 0.1 0.2 |
| Backup battery (NiCd) (required for retentive flags) | 6ES5 980-0AC11 | | Spare parts (3 decades) | | |
| 910 Memory submodule with EPROM memory capacity 1K statements 2K statements 4K statements (1K = 1024) | 6ES5 910-0AA21 6ES5 910-0AA31 6ES5 910-0AA41 | 0.04 | Adapter block type I (LED) | 6ES5 773-7AC11 | |
| | | | Adapter block type type II (digital display) | 6ES5 773-7AC21 | |
| | | | Thumbwheel switch | 6ES5 773-0AD21 | |
| | | | Thumbwheel switch with LED | 6ES5 773-0AE21 | |
| | | | 7-segment digital display | 6ES5 773-0AF21 | |
| | | | 383 Timer/counter module 16 timers/4 counters | 6ES5 383-7AA12 | 2.23 |
| | | | Operator's panel for 383 timer/counter module | 6ES5 384-0AA11 | 0.48 |
| | | | Keypad for 383 timer/counter module | 6ES5 384-0AB11 | 0.44 |

Continued on page 6.2

¹⁾ Subrack, coding beginning with "1" 6ES5 710-0AA11/ 6ES5 710-0AA41. Still available as spare part.

²⁾ on application

6. Spare parts (continued)

| Components of the S5-110A PC | Order No. | Weight approx. kg | Components of the S5-110A PC (continued) | Order No. | Weight approx. kg |
|--|---|-------------------|---|-------------------------|-------------------|
| Input modules, each with 8 inputs | | | Plug-in jumpers for input and output modules package of 20 | 6ES5 763-0AA11 | |
| 400 Digital input module | 6ES5 400-7AA13 | 0.39 | Dust cover for bus cable package of 100 | 4T 807 0424-01 | |
| 401 Digital input module with group signal | 6ES5 401-7AA13 | 0.39 | Fuses for power supply modules | 261 324 | |
| 405 Digital input module | 6ES5 405-7AB11 | 0.4 | 930-7AA11 (220 V AC) T 0.1 A (slow) | 261 325 | |
| 115 V UC | 6ES6 405-7AB21 | 0.4 | 930-7AA21 (115 V AC) T 0.2 A (slow) | 261 327 | |
| 220 V UC | 6ES5 405-7AB31 | 0.4 | 930-7AA31 (24 V DC) T 0.5 A (slow) | 4F 990 0641-01 | |
| 48 V UC | | | 930-7AA01 (240 V AC) T 0.15 A (slow) | 4F 990 0641-02 | |
| | | | 930-7AA12 (220 V AC) T 0.15 A (slow) | 4F 990 0641-02 | |
| | | | 930-7AA22 (115 V AC) T 0.3 A (slow) | 261 015 | |
| | | | 931-7AA01 (240 V AC) M 0.2 A (medium) | 261 334 | |
| | | | 931-7AA11 (220 V AC) M 0.2 A (medium) | 261 131 | |
| | | | 931-7AA22 (115 V AC) M 0.4 A (medium) | 261 312 | |
| | | | Fuses for output modules | | |
| | | | 410- (24 V DC, 48 V DC) FF 2.5 A | | |
| | | | 415- (220 V AC, 115 V AC, 48 V AC) FF 6.3 A (very fast) | | |
| Output modules, each with 8 outputs | | | Circuit diagrams for modules | 6ES5 991-0BB11 | |
| Digital output modules (static) | | | S5-110A PC Manual | | |
| 24 V DC, 2 A | 6ES5 410-7AA11 | 0.68 | German | 6ES5 998-0AA12 | |
| 46 V DC, 2 A | 6ES5 410-7AA21 | 0.68 | English | 6ES5 998-0AA22 | |
| 24 V AC/48 V AC, 2 A | 6ES5 410-7AA31 | 0.68 | French | 6ES5 998-0AA32 | |
| 115 V AC, 2 A | 6ES5 410-7AB11 | 0.68 | | | |
| 220 V AC, 2 A | 6ES5 410-7AB21 | 0.68 | | | |
| Digital output module (with relays) | | | Operating Instructions | | |
| 80 mV to 30 V | 6ES5 417-7AA11 | 0.7 | for PC | 4NEB 807 0690-02 | |
| 30 V to 240 V AC | 6ES5 417-7AA21 | 0.7 | for peripheral I/O rack with serial CC interface module | 4NEB 807 0500-02 | |
| | | | for 332 test adapter | 4NEB 807 0515-02 | |
| | | | for 330 test module | 4NEB 807 0518-02 | |
| | | | for 383 timer/counter module | 4NEB 807 0524-02 | |
| 418 Display module 2 × 7-segment display | 6ES5 418-7AA11 | | | | |
| 500 Programmer interface module for interfacing the 630C, 631 and 670C programmers to the S5-110A PC | 6ES5 500-7AA12 | 0.45 | | | |
| Cable connector interface module – programmer ³⁾ | 6ES5 734-0BD20 | | | | |
| 311 CC Interface module for linking input and output modules to higher order units and systems | 6ES5 311-7AA11 | 0.5 | | | |
| 723 Cable connector between 311-7 CC interface module and 302 EU interface module | 6ES5 723-0□□□□³⁾ | | | | |
| possible cable lengths |  | | | | |
| 1 m | BB0 | | | | |
| 2 m | BC0 | | | | |
| 4 m | BE0 | | | | |
| 5 m | BF0 | | | | |
| 10 m | CB0 | | | | |
| 20 m | CC0 | | | | |
| 40 m | CE0 | | | | |
| 80 m | CJ0 | | | | |
| 100 m | DB0 | | | | |
| 200 m | DC0 | | | | |
| 400 m | DE0 | | | | |
| 800 m | DJ0 | | | | |
| 1000 m | EB0 | | | | |

¹⁾ Subrack, coding beginning with "1" 6ES5 710-0AA11 or 6ES5 710-0AA41 onwards.

²⁾ On application

³⁾ To be ordered from GWA

