

SERVO INVERTER

POSIDYN®

SDS 4000

Installation and Commissioning Instructions

It is essential to read and comply with these instructions prior to installation and commissioning.

MANAGEMENTSYSTEM



certified by DQS according to
DIN EN ISO 9001, DIN EN ISO 14001
Reg-No. 000780 UM/QM



SV. 4.5

GB 06/2008



Table of contents

1. Notes on Safety	1	10. Positioning Control	19
2. Technical Specifications	2	10.1 Function Overview	19
3. Physical Installation	3	10.2 Connections	19
3.1 Installation Site	3	10.3 Dest. Positions and Proc. Blocks	20
4. Electrical Installation	3	10.4 Absolute / Relative Positioning	20
4.1 EMC-Compatible Installation	4	10.5 Commissioning	21
4.2 DC Limit Braking	4	10.5.1 Limited Position Range	21
4.3 DC Limit Braking	4	10.5.2 Continuous Traversing Range (Rotary Axis)	21
4.3.1 Direct coupling of devices	4	10.6 Reference Point Traversing	22
4.3.2 Coupling of devices with DC fuse	4	10.7 Position Controller	23
4.4 Electrical Installation	4	10.8 Process Block Chaining	23
4.5 Motor Connection, Halting Brake, X13	5	10.9 Simple Examples	24
4.6 Brake Resistor, X12	5	10.10 Emergency Off	25
5. Connection Assignment	6	10.11 Ext. Rot./Lin. Path Measurement	25
5.1 Terminal Overview	6	10.11.1 Position Encoder	25
5.2 Terminal Assignments	7	10.11.2 Parameterization – Motor/Ext. Meas. Sys.	25
5.2.1 Terminal X1 (I/O)	7	10.11.3 Special reactions with SSI encoders	25
5.2.2 Terminal X2 (24 V)	7	10.12 Posi Switching Points	26
5.2.3 Terminals: X3 (Service), X20 (Encoder), X40 (Resolver), X41 (Sin/Cos)	8	11. Synchronous Running, Elec. Gearbox	26
5.2.4 Terminals X11 and X12 (R _{ballast})	8	11.1 Function Overview	26
5.2.5 Terminal X13 (Motor)	8	11.2 Connection of Pulse Source	27
5.3 Control Portion, Terminal Strip X1	9	11.3 Master - Slave	27
5.4 X3 Service Plug Connector (RS232, CAN)	10	11.4 Commissioning	28
5.5 X40 Resolver	10	11.5 Angle Difference	28
5.6 X20 Encoder In/Out (TTL)	10	11.6 Angle and Speed Sync. Running	28
5.7 Encoder Input (External Encoder)	11	11.7 Emergency Off	28
5.8 X41 Sin/Cos, Absolute Value Encoder	12	11.8 Reference Point Traversing - Slave	28
6. Multi-Motor Operation	13	12. Technology	29
7. Operator Control	14	12.1 PID Controller	29
7.1 Status Indication	14	12.2 Winders	29
7.2 Controlbox	14	12.2.1 Diameter Sensor on AE1/AE2	29
7.2.1 Local Mode	14	12.2.2 Indirect Tension Control at M-Max Limit	30
7.2.2 Operation Indication	14	12.2.3 Winding with Compensating Roller	30
7.2.3 Parameter Memory	15	12.2.4 Winding with Tension Sensor	30
7.2.4 Parameterization	15	12.2.5 Compensation of Fault Variables	30
7.2.5 Password	15	13. Parameter Description	31
8. Commissioning	16	14. Option Boards	59
8.1 Default Setting	16	14.1 Option Board SEA 4000	59
8.2 Motor, Braking Resistor	16	14.2 Option Board SDP 4000	60
8.3 Speed Specification	16	14.3 Opt. Board SEA+SDP 4000 (Combi Board)	60
8.3.1 Speed Specification via Controlbox	16	15. Result Table	61
8.3.2 External Speed Specification	16	16. Operating States	62
8.3.3 Speed Spec. via Potentiometer	16	17. Faults / Events	63
8.3.4 Characteristic Curve of Ref. Value	17	STÖBER ANTRIEBSTECHNIK Deutschland	65
8.3.5 Speed Spec. via Fixed Ref. Value	17	STÖBER ANTRIEBSTECHNIK International	67
8.3.6 Speed Spec. via Clk Pulse Generator	17	18. Block Circuit Diagram - Sync. Running	69
8.3.7 Motor Potentiometer	17	19. Block Circuit Diagrams	69
8.3.8 Frequency Reference Value	17	19.1 Fast Speed Ref. Value Active (D99=1)	69
8.4 Speed Controller	17	19.2 Reference Value Processing	70
8.5 Halt / Quick Stop	17	20. Parameter Table	71
8.6 Brake Control	17	21. Accessories	74
8.7 Binary Inputs BE1 to BE4 (Opt. BE5 to BE15)	18	21.1 Accessories Overview	74
8.8 Parameter Record Selection	18	21.2 Braking resistor	76
8.9 Acknowledgment of Faults	18	21.2.1 Allocation of braking resistor to SDS	76
8.10 Motor Startup	18	21.2.2 Braking Resistor FZT/FZZT (Dimensions)	76
9. Torque Limits / Operating Range	18	21.2.3 Braking Resistor VHPR (Dimensions)	77
9.1 Torque Limits	18	21.3 Input Filter (Dimensions)	77
9.2 Operating Range	19	21.4 Output Derating (Dimensions)	77

1 NOTES ON SAFETY



To prevent avoidable problems from occurring during commissioning and/or operation, it is essential to read and comply with this entire instruction manual before starting installation and commissioning.

Based on DIN EN 50178 (once VDE 0160), SDS-series servo inverters are defined as electronic power equipment (BLE) for the control of power flow in high-voltage systems. They are designed exclusively to power servo machines. Handling, installation, operation and maintenance must be performed in accordance with valid and/or legal regulations, applicable standards and this technical documentation.

The servo inverter are products of the restricted sales class (in accordance with IEC 61800-3). Use of this products in residential areas may cause high-frequency interference in which case the user may be ordered to take suitable measures.

The user must ensure strict adherence to these standards.

The safety notes and specifications stated in additional sections (items) must be adhered to by the user.



Caution! High touch voltage! Danger of electric shock! Danger of death!

Never under any circumstances may the housing be left open or connections disconnected when the power is on. Disconnect the power plug of the servo inverter and wait at least 5 minutes after the power voltage has been switched off before opening the servo inverter to install or remove option boards. Correct configuration and installation of the inverter drive are prerequisites to correct operation of the servo inverter. Only appropriately qualified personnel may transport, install, commission and operate this device.

Pay particular attention to the following:

- Permissible protection class: Protective ground; operation only permitted when protective conductor is correctly connected. The devices may not be operated directly on IT networks.
- Installation work may only be performed in a voltage-free state. When work has to be done on the drive, inhibit the enable and disconnect the complete drive from the power network. Adhere to the 5 safety regulations.
- Discharge time of the DC link capacitors > 5 minutes
- Do not penetrate the interior of the device with any kind of object.
- When performing installation or other work in the switching cabinet, protect the device against falling objects (e.g., pieces of wire, flexible leads, metal parts and so on). Conductive parts may cause short circuiting or device failure on the frequency inverter.
- Before commissioning, remove all extra coverings to prevent the device from overheating.

The servo inverter must be installed in a switching cabinet which does not exceed the maximum ambient temperature (see technical data). Only copper wiring may be used. For wire cross sections, see table 310-16 of standard NEC at 60° C or 75° C.

STÖBER ANTRIEBSTECHNIK accepts no liability for damages caused by non-adherence to the instructions or applicable regulations.

The motor must have an integral temperature monitoring device or external motor overload protection must be used.

Either the motor itself must be equipped with temperature monitoring, or external protection against motor overload must be used.

Only suitable for use on power networks which cannot supply more than a symmetric, nominal short-circuit current of 5000 A at 480 Volt.

Notes:

Subject to technical changes for improvement of the devices without prior notice. This documentation is solely a product description. It is not a promise of features in the sense of warranty rights.

2. Technical Specifications

Model	Model 1				Model 2a	Model 2b
	SDS 4011	SDS 4021	SDS 4041	SDS 4071	SDS 4101	SDS 4141
Type of device						
Nominal connected load	1 kVA	2 kVA	4 kVA	7 kVA	10 kVA	14 kVA
Nominal current (effective value, ±3%)	1.5 A	3 A	6 A	10 A	14 A	20 A
Max. output current (max. of approx. 5 sec, ±3%)	3 A	6 A	12 A	20 A	28 A	40 A
Connected voltage	(L1 - L3) 3 x 230 V - 10% to 480 V + 10%, 50 to 60 Hz					
Power fuses ¹	3 x 6 AT		3 x 10 AT		3 x 20 AT	
Conductor cross section, power connection	1.5 mm ²	1.5 mm ²	1.5 mm ²	1.5 mm ²	2.5 mm ²	4 mm ²
Conductor cross section, motor connection	1.5 mm ²	1.5 mm ²	1.5 mm ²	1.5 mm ²	2.5 mm ²	
Conductor cross section, halting brake	Min. of 0.75 mm ² (consider voltage loss)					
Conductor cross section, ext. 24 V/GND	Max. of 2.5 mm ² (consider voltage loss)					
Overtoltage source						
Clock pulse frequency	8 kHz					
Braking resistance, internal	66 Ω / 80 W Max. of 10.5 kW for 1 sec		33 Ω / 200 W Max. of 21 kW for 1 sec			
Braking resistance, external ² (limit data for brake chopper)	μ 30 Ω/max. 500 W const. Max. of 21 kW for 1 sec		μ 30 Ω / max. 1500 W const. Max. of 21 kW for 1 sec			
Switch-on threshold, brake chopper	840 to 870 V					
Switch-off threshold, brake chopper	800 to 830 V					
RFI suppression	Integrated network filter in accordance with EN 55011, class A					
Permissible length of motor cable	25 m, shielded; 25 to 100 m, shielded with output derating					
Auxiliary voltage, 24 V without brake connection	18 to 36 V, 1 A					
Auxiliary voltage, 24 V with brake connection	24 V - 0% to 24 V + 10%, 3 A + 0.5 A at Sin/Cos					
Fuses, 24 V	Internal: 3.15 AT, external: max. of 16 AF due to conductor cross section 2.5 mm ²					
Max. output current, brake	2 A					
Protection rating/mounting position	IP20/always vertical					
Ambient temperature	0° to 45° C for nominal data Up to 55° C with power reduction of 2.5% /° C					
Storage temperature	-20 °C to +70 °C, max. change, 20 K/h					
Humidity during operation	Relative humidity of 85%, no condensation					
Installation altitude	Up to 1000 m without restriction; 1000 to 2500 m with derating of 1.5%/100 m					
Degree of soil	Soiling degree of 2 in acc. w. EN 60204/EN 50178					
Dimensions W x H x D, without plug (in mm)	70 x 318 x 255				100x318x255	115x318x255
Power loss	30 W	40 W	60 W	90 W	160 W	200 W
Storage capacity	1 year					
Weight (in kg) - without packing - with packing	4,4 5,8				5,6 6,9	7,4 8,7

¹ Line circuit breaker - tripping characteristic D in accordance with EN 60898

² External braking resistors with thermal monitoring are recommended. Mandatory for UL use!

3 PHYSICAL INSTALLATION

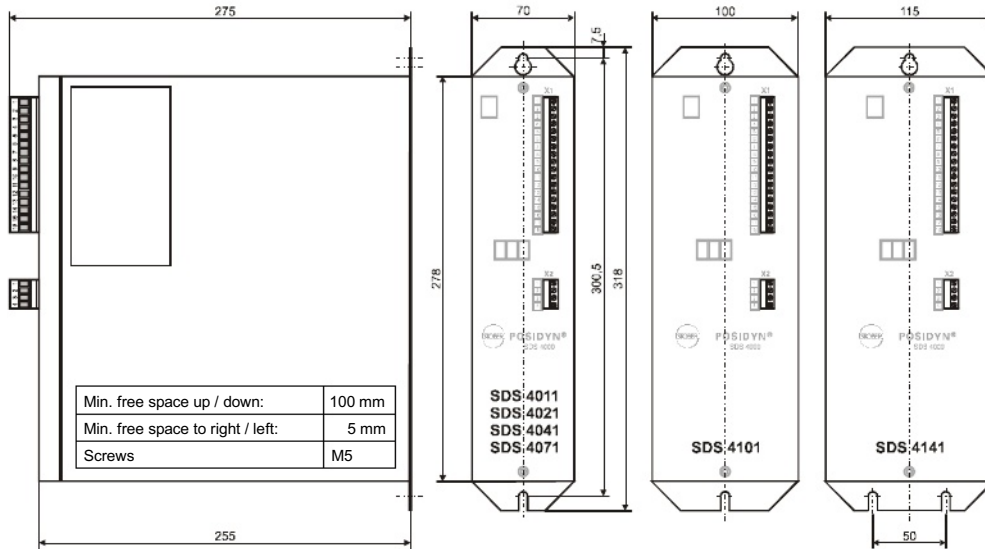

3.1 Installation site

- Operate only in dlosed switching cabinet.
- Install inverter only in vertical position.
- Avoid installation over heat-producing devices.
- Ensure sufficient air circulation in switching cabinet. (Minimum free space of 100 mm over and under the device!)
- Keep installation site free of dust, corrosive fumes and all liquids (in accordance with soil degree 2 in acc. with EN 60204/EN 50178).
- Avoid atmospheric humidity.
- Avoid condensation (e.g., by anti-condensation heaters).
- Use unpainted mounting plates with conductive surface (e.g., unpainted) to conform with EMC regulations.

4 ELECTRICAL INSTALLATION

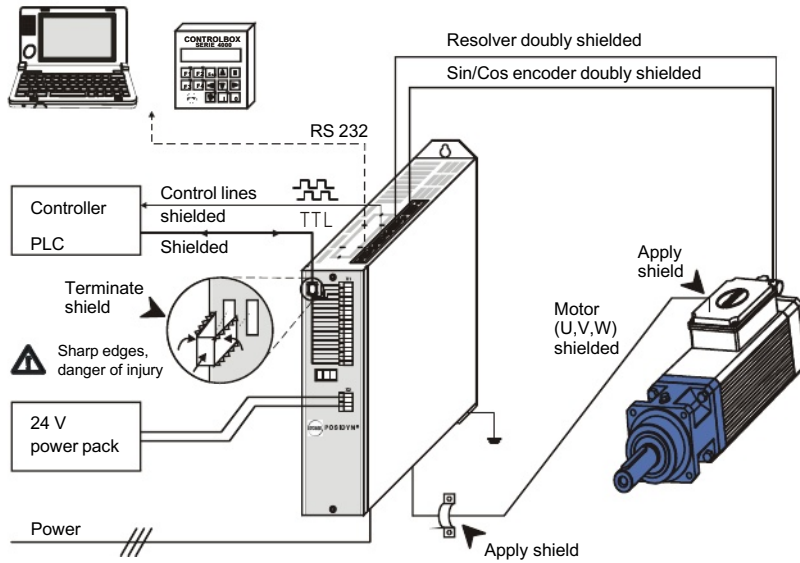

4. Electrical Installation

4.1 EMC-compatible installation

Basic rules

- Install control and power cables separately (> 20 cm).
- Install power, encoder and motor cables in separate spaces.
- Central grounding point in immediate vicinity of the inverter.
- All shields and protective conductors of motor and power cables are applied here over a large area.
- Reference value cables must be shielded and, if necessary, twisted in pairs.
- Connect shield of control lines on one side to the reference ground of the reference value source (PLC, controller, etc.).

Motor cable (see accessories, chap. 21)

- Use shielded cables. Apply shield on both sides.
- Use output derating when cables are longer than 25 m.

4.2 FI circuit breaker

Network phases and directly grounded conductor are connected to the protective conductor with Y capacitors. When voltage is present, a leakage current flows over these capacitors to the protective conductor. The greatest leakage current is created when a malfunction occurs (asymmetric feeding over only one phase) and power-on (sudden change in voltage). The maximum leakage current caused by asymmetric powering is 66 mA (power voltage of 400 V) for SDS inverters. If FI circuit breakers must be used, the problem of power-on and power-off can be minimized by using selective FI circuit breakers (delayed switch-off) or FI circuit breakers with greater triggering currents (e.g., 300 or 500 mA). Use of several devices on one FI circuit breaker is not recommended.

4.3 DC link coupling

4.3.1 Direct coupling of devices

All coupled devices must be connected to one common power fuse. The fuse may not exceed 20 AT. This limits maximum possible drive power to approx. 10 kW.

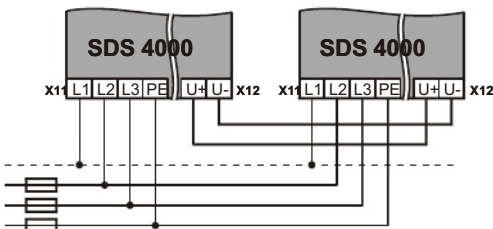

4.3.2 Coupling of devices with DC fuse

Each device has its own power fuse based on its technical specifications (chap. 2). In addition, each device must be protected on the DC link (U+ and U-) with the same current strength. The fuse must be suitable for a voltage of 500 V DC. Lines with lengths of 20 cm and longer must be shielded.

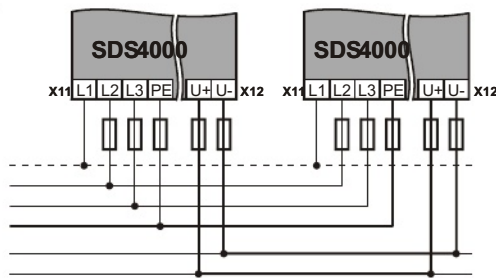

Brake resistance for DC link coupling:
Internal brake resistors may remain active since the braking power is distributed evenly. Important: Set type of resistor **A20** correctly. Set **A38=1** for a pure DC-link-coupling feed-in without power network connection.

4.4 Electrical installation

- Only connect inverter to three-phase, grounded, industrial power network.
- User must provide fuses for power network and 24 V supply (see technical specifications, chap. 2).
- Install power and control cables separately (> 20 cm).

Important: When installing the 24 V brake lines in the motor cable, **shield the brake lines separately** if the inverter addresses the brake directly.

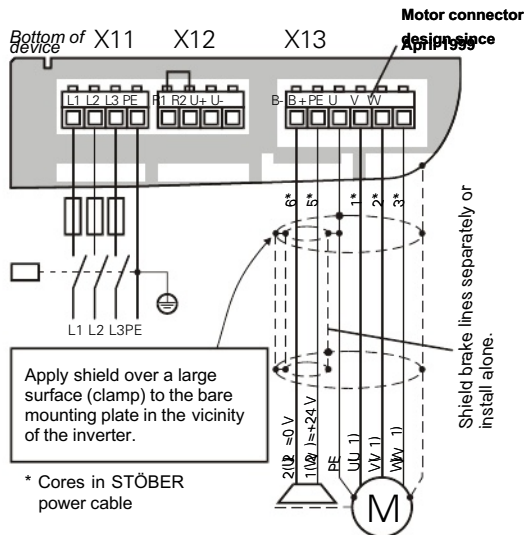

Important: With direct brake control, a voltage of approx. 1.3 V occurs on the inverter (protection against pole reversal and EMC derating). However, since the halting brake requires at least 24 V - 10% = 21.6 V, use an external contact (relay) for long brake lines. The same also applies to power packs which supply less than 24 V.

4. Electrical Installation

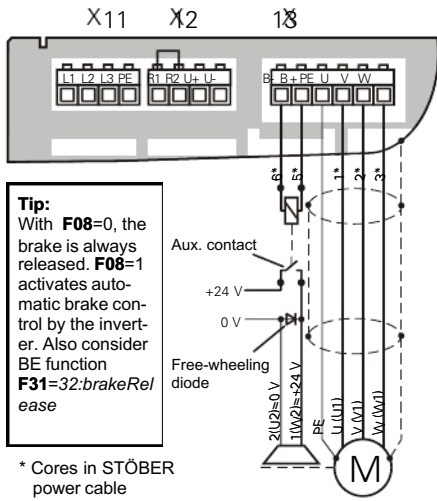

Caution: Important information on motor connector
With devices delivered up to March 1999, motor connector X13 has a different orientation than the front power connectors X11 and X12.

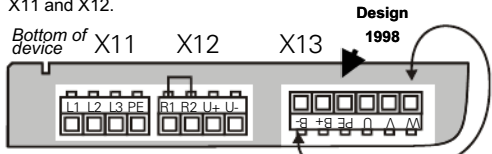

The motor connector must be rewired when these older devices are replaced with newer ones. The old allocation is a mirror image of the new one and, if left as is, will damage inverter and motor!

Shielding for STÖBER power cables

Use the included clamp to connect the shielding with the HF reference potential (mounting plate and inverter's housing). If this is not possible, the shielding (red flexible lead) can be connected to the PE terminal of the device.

4.5 Motor connection, halting brake, X13

Together with any halting brake, the motor is connected to plug connector X13 (on the bottom of the device). The inverter can directly address the halting brake. The external 24 V supply must be designed for this.

- Only use shielded cable to connect motor.
- **Apply shield on both sides.**
- On the inverter side, apply shield with a clamp over a large surface to the bare mounting plate.
- If the motor cable also contains lines to the +24 V halting brake and this brake is addressed by the inverter, these lines must be **shielded separately!** Connect the shields on both sides.

Terminal block

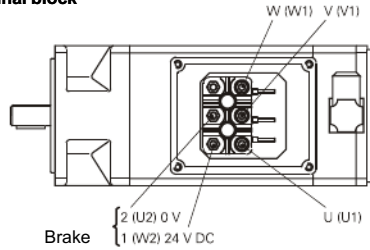

Power connector



	Power Connector	STÖBER Cable
U	1	1 (U1)
V	2	2 (V2)
W	6	3 (W3)
⊥	⊥	⊥
+ 24 V	4	5 (BR1)
0 V	5	6 (BR2)

4.6 Brake resistor, X12

SDS servo inverters are always equipped with a brake resistor. A jumper between R1 and R2 must be wired to activate the internal brake resistor. For technical details, see page 2. Greater brake performance requires connection of an external brake resistor. Connector X12 is used for the connection (on

the bottom of the device).

internal

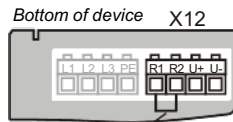

Jumper between R1 and R2 only for int. brake resistor!!

external

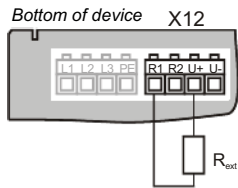

	Jumper Between	Connection Between
Int. brake resistor	R1 and R2	---
Ext. brake resistor	not applicable	R1 and U+

Lines to the external brake resistor which are longer than 30 cm must be shielded. The brake chopper triggers at a DC link voltage of 840 to 870 V. The internal brake resistors will remain active for all axes when a DC link coupling of several devices is used with the terminals U+ and U-. The brake chopper distributes the braking load evenly over all inverters (which may even have different current strengths).

The current of the internal brake resistor is monitored and protected against overload with a thermal i2t model. **With the external brake resistor, we recommend using types with integrated overcurrent relays to prevent thermal damage caused by overload.**

5. Connection Assignment

5.1 Terminal overview

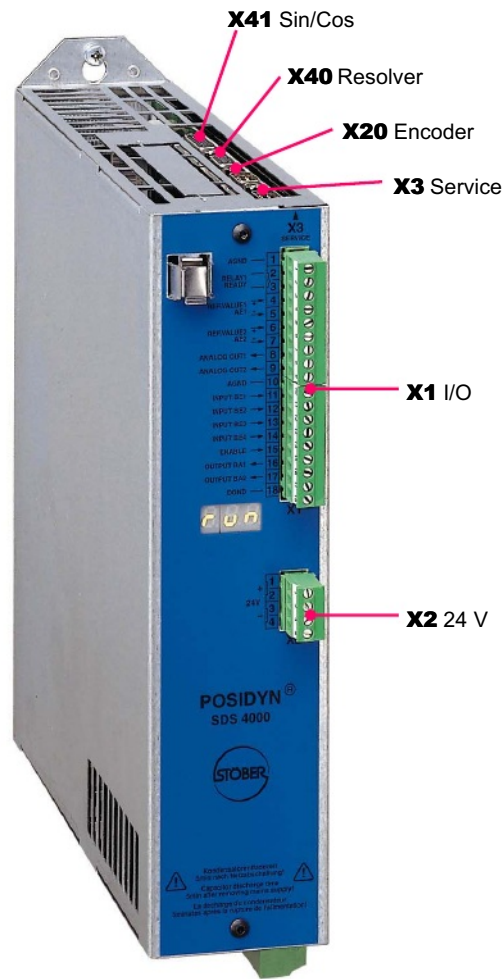

Bottom of device

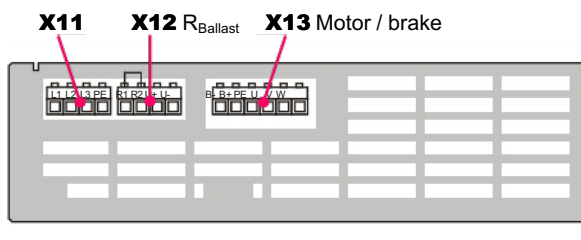

5. Connection Assignment

5.2 Terminal assignments

5.2.1 Terminal X1 (I/O)

Analog ...

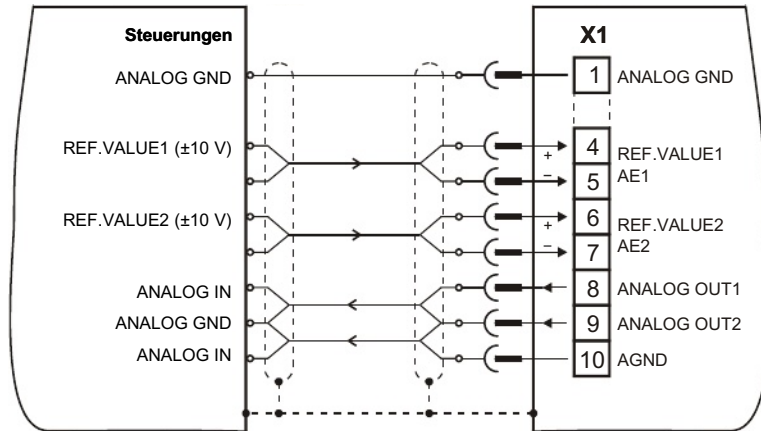

Digital ...

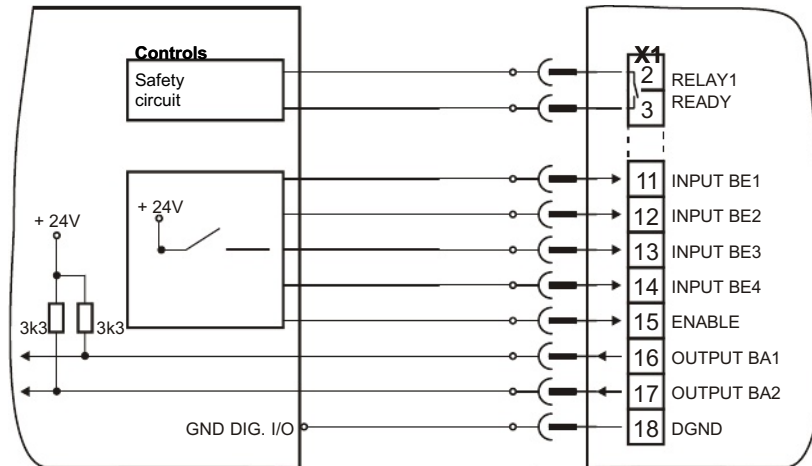

5.2.2 Terminal X2 (24 V)

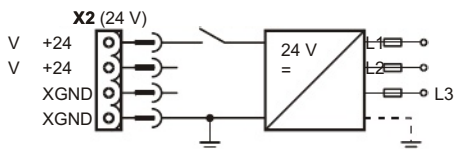

⚠ Pole reversal will damage the device.

5. Connection Assignment

5.2.3 Terminals: X3 (Service), X20 (Encoder), X40 (Resolver), X41 (Sin/Cos)

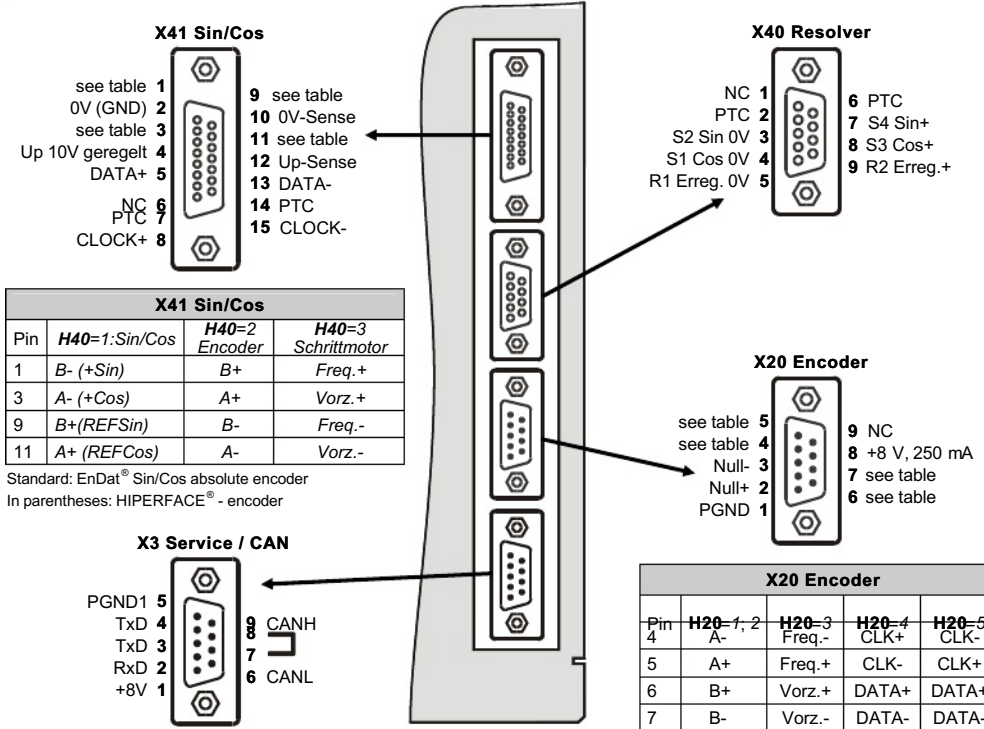

5.2.4 Terminals X11 and X12 (Ballast)

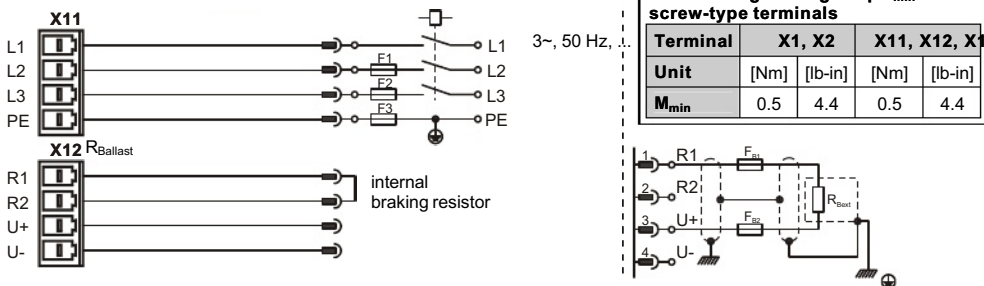

5.2.5 Terminal X13 (Motor)

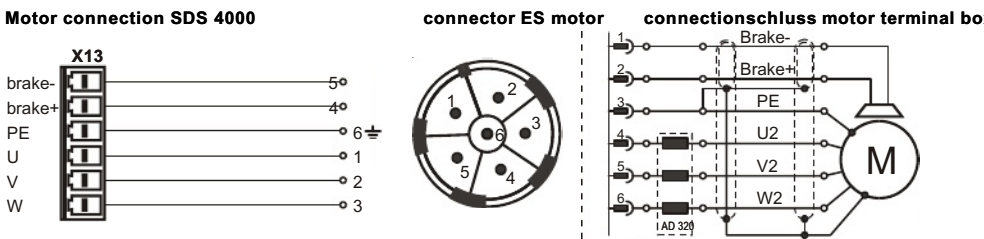

5. Connection Assignment

5.3 Control portion, terminal strip X1

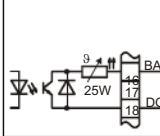
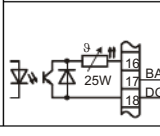
	Ter-minal	Function	Circuiting	
Control terminals strip X1	1	AGND: Reference ground for analog signals	Reference potential for terminals X1.4 to X1.9	
	2	Relay 1/ready for operation Max. of 24 V DC, 42 V AC, 0.5 A	Shows readiness of the servo inverter (i.e., relay closed)	
	3		Function can be programmed under F10 .	
	4	Analog input AE1 0 to ±10 V, Ri = 20 kΩ, 14-bit resolution Ta = 1 msec	Function can be programmed under F25 . Default setting: F25=10:ref.value ; 10 V=3000 rpm (↔ D02)	
	5			
	6	Analog input AE2 0 to ±10 V, Ri = 20 kΩ, 12-bit resolution Ta = 4 msec	Function can be programmed under F20 . Default setting: F20=0:inactive	
	7			
	8	Analog output 1, Ta = 4 msec ±10 V, Ri = 2.2 kΩ, 10-bit resolution Calibrated at the plant for a load = 20 kΩ	Function can be programmed under F40 . Default setting: F40=4:n-motor ; 10 V=3000 rpm (↔ C01 n-Max)	
	9	Analog output 2, Ta = 4 msec ±10 V, Ri = 2.2 kΩ, 10-bit resolution Calibrated at the plant for load = 20 kΩ	Function can be programmed under F45 . Default setting: F45=1:l-motor ; 10 V=2 x I _{Nom} (SDS)	
	10	AGND: Reference ground for analog signals	Reference potential for terminals X1.4 to X1.9, internally connected with X1.1	
	11	Binary input BE1 * 8:halt	Inputs which can be programmed as desired. Function is specified with parameters F31 to F34 . Scanning time Ta = 4 msec. When an HTL incremental encoder is connected to BE1 and BE2, the max. input frequency is 80 kHz. With the functions <i>posi.next</i> , <i>posi.start</i> and <i>syncFreeRun</i> , BE1 reacts <i>without delays</i> . * Default setting of the inverter	L level: 0 to 7 V/0 mA
	12	Binary input BE2 * 6:dirOfRotat		H level: +12 to 30 V/ 7 mA
	13	Binary input BE3 * 9:quick stop (with ramp)		Interference immunity: EN 61000-4
	14	Binary input BE4 * 0:inactive		
	15	Enable, Ta = 4 msec		
	16	Binary output BA1 ¹ Open collector, 36 V (max.), 10 mA (max.), Ta = 4 msec Pullup resistance μ 3.3 kΩ	Outputs which can be programmed as desired. Function is specified with parameters F80 (BA1) and F00 (BA2).	
	17	Binary output BA2 ¹ Open collector, 36 V (max.), 10 mA (max.), Ta = 4 msec Pullup resistance μ 3.3 kΩ		
	18	DGND: Digital ground	Reference potential for terminals X1.11 to X1.17	

¹ Evaluation of the outputs via inverting interface terminals (e.g., Phoenix DEK-REL-24/I/1)

5. Connection Assignment

5.4 X3 Service plug connector (RS232, CAN)

Service plug connector X3 can be used to connect a PC or the external operator unit (i.e., *Controlbox*). When a PC is connected, the same G3 FDS cable (Id.-No. 41488) can be used as for the **POSIDRIVE®** FDS 4000 frequency inverter.

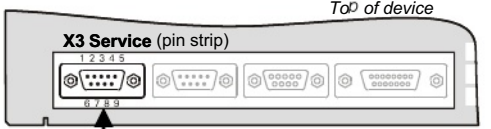

Pin	1	2	3	4	5	6	7	8	9
Signal	+8V	RxD	TxD	TxD	PGND ¹	CANL	Internally connected		CANH

1) PGND ground (I/O ground) is galvanically isolated from digital DGND on plug connector X1.

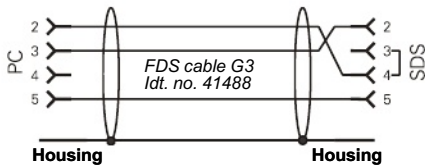

FDS cable G3, cat. no. 41488

Connection cable between the serial interface of the PC (Notebook) and serial interface X3 of the FDS. Only applies to FDSs with a sealed keyboard. Do NOT replace with a conventional serial connection cable. Such cables can only be used with a special adapter (cat. no. 41489).

The +10 V on pin 1 is exclusively to power a Kommubox and/or a Controlbox.

Caution: A brief short circuit against ground can cause a brief reset of the processor.

The RS 232 interface can be used to create a low-cost network of several inverters with an "RS 232 ring."

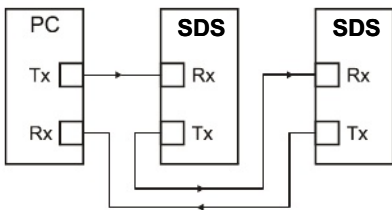

Networking with an RS 232 ring is supported by FDS Tool.

The RS 232 ring can be used to control the inverters by communication via USS protocol.

For more information on the USS protocol, see the USS documentation (no. 441564).

5.5 X40 Resolver

The default setting specifies a 2-pin resolver as the motor encoder. For connection, adhere to the following points.

- Use fabricated STÖBER cables for optimum interference immunity.
- Use only resolver cables with cores which are twisted in pairs and shielded.
- Cross section: 0.14 mm² [LIY (C) Y3 (2 x 0.14) + (2 x 0.25)]
- Use 2 cores with 0.25 mm² for positor line evaluation.
- Apply outer shield on both sides. Apply inner shield only on the inverter side.
- Use exclusively sub D **plug connectors with shielded housing** (e.g., Siemens V42254-A6000-G109).
- Apply shield over a large surface on the housing of the plug connector.

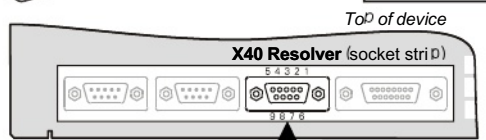
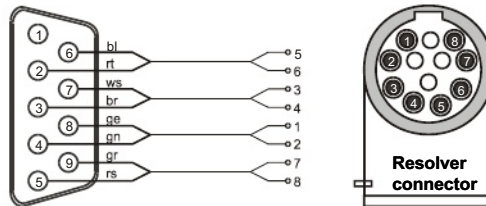

Signal	S3 Cos+	S1 Cos-	S4 Sin+	S2 Sin-	PTC Thermistor	PTC	R2 Erreg+	R1 Erreg-
Pin X40	8	4	7	3	6	2	9	5
Motor ¹	1	2	3	4	6	5	7	8
Kabel ²	ge	gn	ws	br	bl	rt	gr	rs

1) Pin number of the 12-pin resolver connector for the STÖBER ES motor
2) Color when the STÖBER resolver cable is used

5.6 X20 Encoder IN/OUT (RS422)

Simulation of an incremental encoder on plug connector X20 is activated with **H20=1:encoder sim**. The number of pulses can be changed with the parameter **H21**. Adhere to the following points when using encoder simulation.

- Use only suitable cables with cores which are twisted in pairs and shielded.
- On the receiver side, the lines require low-ohmic termination and differential evaluation. Recommended termination impedance: 150 Ω.
- Connect ground on pin 1 with the ground of the higher-level controller.
- Apply shield on both sides over a large surface to the housing of the plug connector.

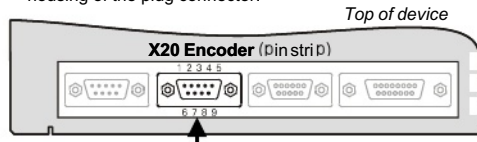

5. Connection Assignment

Other possible configurations:

H20=2: encoder in; input for ext. incremental encoder (TTL)

H20=3: stepMot in; frequency + sign
(chap. 11.2)

H20=4: SSI sim; output of position in SSI format

H20=5: SSI master; connection of external SSI encoder

Pin	1	2	3	4	5	6	7
H20=0	PGND	-	-	-	-	-	-
H20=1	PGND	Zero+	Zero-	A-	A+	B+	B-
H20=2	PGND	-	-	A-	A+	B+	B-
H20=3	PGND	-	-	Freq-	Freq+	Sign+	Sign-
H20=4	PGND	-	-	CLK+	CLK-	Data+	Data-
H20=5	PGND	-	-	CLK-	CLK+	Data+	Data-

1) PGND ground (I/O ground) is galvanically isolated from digital DGND on plug connector X1.

5.7 Encoder input (external encoder)

Four versions are available to connect encoder or frequency / sign signals (stepper motor simulation).

- HTL signals on BE1 and BE2, fmax = 80 kHz
- TTL signals (differential, RS 422) on X20, fmax = 160 kHz
- 1 V_{SS} and TTL signals on X41, fmax = 160 kHz.
- SSI signals from an external SSI encoder on X20

When an encoder is connected to BE1/BE2, **F31=14** and **F32=15** must be programmed.

Connector X20 is programmed with **H20=2:encoder in** to evaluate incremental encoders. External SSI encoders can also be connected to X20 (**H20=5:SSI master**).

Although, in contrast to X20, X41 does not offer galvanic isolation, it does provide a regulated voltage supply (10 V with sense lines, regulated to 5 V) for the external encoder. For connection assignment, see the beginning of chap. 5. Connector X41 is programmed with **H40=2:encoder in** to evaluate incremental encoders.

Voltage supply of 5 V encoders

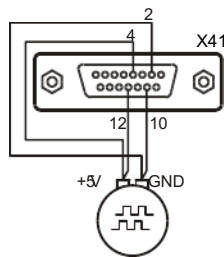

Adhere to the following points.

- Only track A and track B are evaluated but not the zero track.
- BE1/BE2, X20 and X41 may not be parameterized simultaneously as the encoder input (i.e., only one pulse counter exists!).
- When plug connector X20 is used as the encoder input and lines exceed 1 m, a terminating impedance of 150 Ohm must be provided externally between signals A+ and A- and B+ and B-. See figure.
- Since X41 does not offer galvanic isolation, only measuring systems which are closed and powered by X41 may be connected there.
- Use double-shielded cable with cores twisted in pairs.

X20 – Encoder input (incremental encoder)

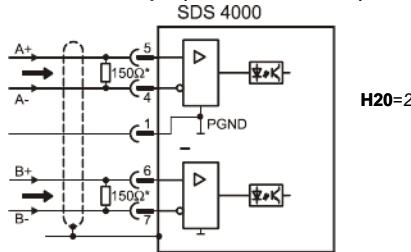

* Terminating resistor for cables longer than 1 m

BE1/BE2 encoder input

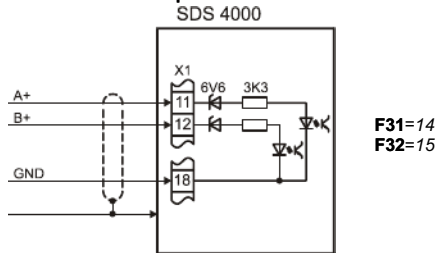

The external encoder is usually used as the signal source for synchronous operation (**G27** reference value) or for position control (**I02** posi.encoder, chap. 10.11). When stepper motor simulation is used, angle synchronous operation (**G20=2**, chap. 11) must be activated in operating mode **C60=1**.

H20=4:SSI sim. simulates the signals of an SSI encoder on X20. This is particularly useful when the motor is controlled with an absolute encoder with sin/cos track. The absolute angle and the multi-turn information can then be obtained from there. **H60** can be used to switch the code between "0:gray" and "1:binary." The information is output in the following format: 12 bits multi-turn, 12 bits within one motor revolution, the 25th bit is always 0.

5. Connection Assignment

5.8 X41 SIN/COS, absolute encoder

Connector X41 is primarily used to connect multi-turn and single-turn absolute encoders with EnDat® or HIPERFACE® interface (sin/cos encoder). An extra sin/cos track gives an excellent speed resolution for maximum running smoothness and dynamics.

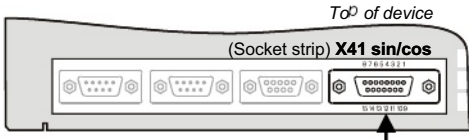

Pin	1	2	3	4	5	6	7	8
Signal	B- +Sin	0V	A- +Cos	Up	Data+	-	PTC	Clock+
Motor ¹⁾	10	16	7	14	-	6	8	
Cable ²⁾	or- ange	br/bl	yel	br/rd	gray	-	br/yel	wt/bk

Pin	9	10	11	12	13	14	15
Signal	B+ RefSin	0V Sense	A+ RefCos	Up Sense	Data-	PTC	Clock-
Motor ¹⁾	12	4	15	1	17	5	9
Cable ²⁾	red	gm/bk	grn	gm/rd	bl	br/gra	wt/yel

Italics: HIPERFACE® encoder

- Due to the missing galvanic isolation of X41, only closed measuring systems can be operated with the power supply via X41.
- The sin/cos encoder must be built onto the motor since it is also used for commutation.
- Use only original STÖBER cables for ES motors!
- Enable connector X41 with **H40=1:SinCos in**.
- Activate motor control with **B26=3:X41**.
- The fault "37:n-feedback" may occur during parameterization. This fault can only be acknowledged by turning the power and 24 V off (save parameters before with **A00=1!**).
- Resolvers and sin/cos encoders cannot be used at the same time.
- Simultaneous use of sin/cos encoders with external incremental encoders is not possible.
- Simultaneous use of sin/cos encoders with frequency specified externally (synchronous operation, stepper motor simulation) is not possible.
- Sin/cos and SSI encoders or SSI simulation on X20 can be used at the same time.
- Use of SSI encoder as master for synchronous operation with sin/cos encoder on the motor is under preparation.
- SSI simulation on X20 is available with sin/cos encoders.

A continuous zero-point setting is possible with all available reference traversing modes (e.g., mode **I30=3: def.home**). The inverter is equipped with an electronic gearbox (safe against power failure) which permits absolute position acquisition over 4096 x 64 = 262,144 encoder revolutions for linear axes, or an unlimited traversing area for continuous axes with any gearbox. When this feature is used, the zero position only has to be re-referenced when the inverter is changed.

6 MULTI-MOTOR OPERATION

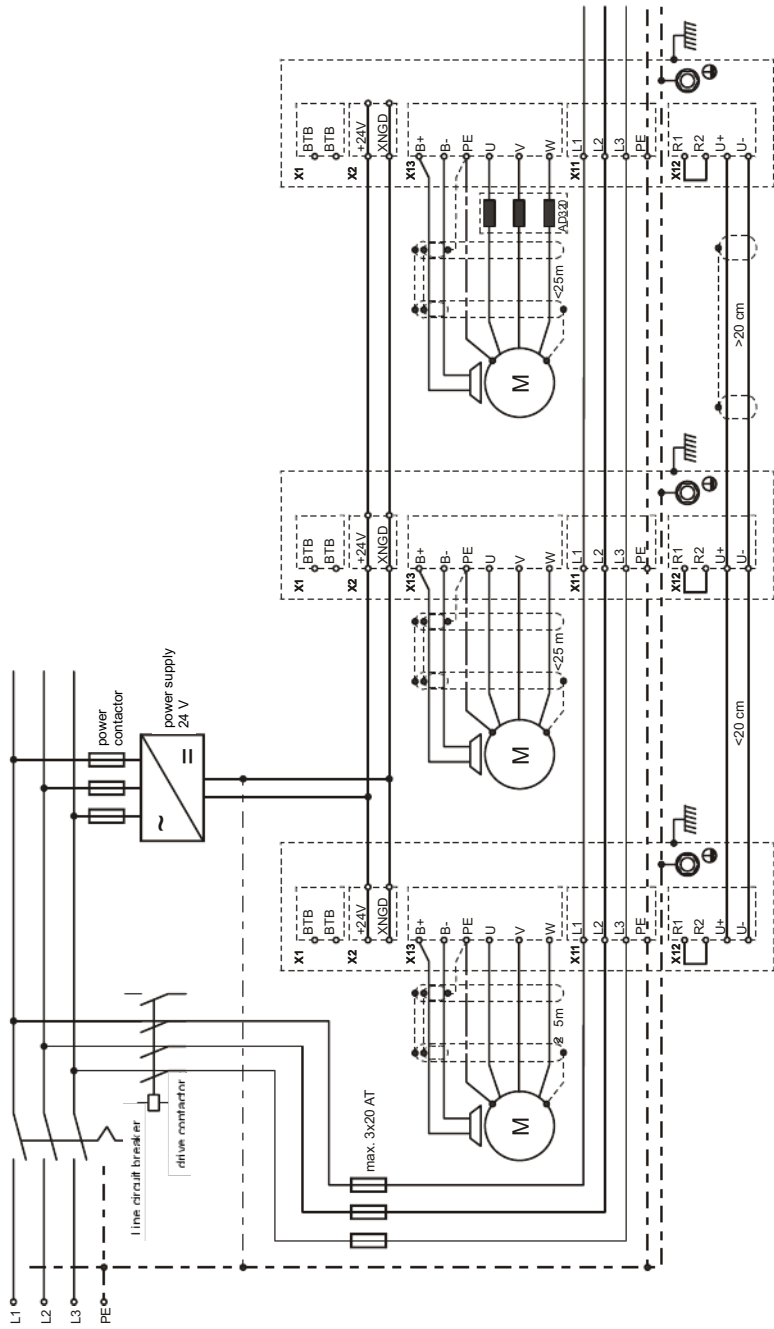

7. Operator Control

7 OPERATOR CONTROL

There are three ways to control and program the SDS servo inverter.

- External Controlbox operator unit
- FDS PC software
- Simubox Fieldbus communication

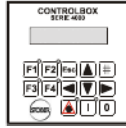

7.1 Status indication

The SDS servo inverter is equipped with a three-position status display, showing the operational status (e.g., "rdy" for ready) or the flashing number of a fault which has occurred (e.g., "E31" for fault 31:short/ground). Controlbox offers a plain-text display with additional diagnostic capabilities (see chap. 16 + 17).



Operational states	
dir	Illegal direction of rotation. Specified direction of rotation contradicts the permissible direction of rotation in C02 .
EnA	Turned on. Only for control via fieldbus (DRIVECOM profile)
HLt	Halt signal active (e.g., during manual traversing)
inH.	Switch-on disable - Inverter is powered with +24 V but the network power is missing.
inH	Switch-on disable - Enable was active during power-on and <i>Autostart</i> was deactivated by A34 =0. Inverter expects a change from H to L level on enable input X1.15.
i2t	i2t message. Current limitation due to overload.
PoS	Positioning mode. Drive is stationary.
rEF	Reference point traversing
rdy	Ready for operation (not enabled)
run	Drive is enabled.
tSt	Self test and calibration after +24 V becomes available on X2. Standard devices show the software version after the 24 V power is turned on. Customized devices with modifications indicate tSt . For complete version designation, see parameter E50 .
OFF	FDS Tool has removed the enable so parameterization can be performed. Enable again with FDS Tool or turn 24 V OFF-ON to resume operation.
StP	Limit switch is active.

7.2 Controlbox

The Controlbox as portable housing or in DIN built-in housing (96 x 96 mm) is connected with the X3 interface (2-m cable is included). It offers:

- **Local mode (manual traversing)** – see chap. 7.2.1
- **Text indicator** – see chap. 7.2.2
- **Memory for seven parameterizations** – see chap. 7.2.3
- **Parameterization without PC** – see chap. 7.2.4
- **Locking with password** – see chap. 7.2.5

If you do not have a Controlbox, you can use the "Simubox.exe" program (also installed during installation of FDS Tool) to simulate a Controlbox.

7.2.1 Local mode

When manual tipping is used for the drive, Controlbox can be used to turn the motor shaft without having to address the binary inputs.

- Switches to local mode and back. The drive stops (internal enable = off). An **I** appears on the bottom right of the display. **A55** (manual key function) must be active.
- **I** Enable = turn on with local mode. The drive is in the state **5:halt** and can be controlled with the arrow keys **◀** and **▶**.
- **0** Enable = off with local mode
If not already active, local mode is activated (i.e., the drive stops).

7.2.2 Operation indication

In speed (**C60**=0) mode, the layout of the *operational display* is shown below.

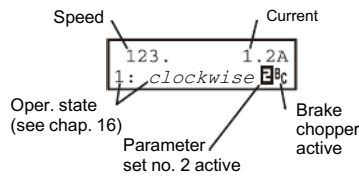

All possible operational states are listed in chap. 16. When **E** is on, the inverter is using parameter record no. 2. No special indication is provided when parameter record no. 1 is active (default setting). The symbol **E%** appears when the brake chopper is running.

C51 is used to scale the speed (when a gearbox is installed on the motor, **C51** can be used to indicate the output speed). The measured **actual speed / C51** is indicated.

The first line of the display can also be customized. A variable selected via **C50** (e.g., power) is divided by **C51** and provided with the unit in **C53** (e.g., "items/min"). The unit can only be specified via FDS Tool. The number of positions after the decimal point is provided by **C52**.

In position mode (**C60**=2), the first line shows the act. position. The second line shows the status.

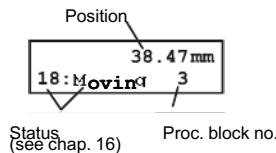

Regardless of the operating mode, events and alarms are indicated in the second line (e.g., "53:Stop"). All events and alarms are listed in chap. 17.

7. Operator Control

7.2.3 Parameter memory

Controlbox offers memory space for the parameters of up to 7 SDS servo inverters.

Store parameterization of the SDS on Controlbox

- Press **#** key. Display shows "A.. inverter."
- Press **#** key. Display shows "A00 save param."
- Press **▲** key until "A03 write PBox" appears.
- Press **#** key until the second line of the display flashes.
- Press the **▲** and **▼** keys to select the memory address number (1 to 7). If the memory address is already occupied, this is indicated with the name of the data record on the display.
- Press **#** key to save the parameterization.

Read data from Controlbox

- Press **#** key. Display shows "A.. inverter."
- Press **#** key. Display shows "A00 save param."
- Press **▲** key. "A01 readBox&save" appears.
- Press **#** key. The second line of the display flashes.
- Press the **▲** and **▼** keys to select the memory address number (1 to 7). The data record names of the already stored parameterizations are indicated.
- Press **#** key to read in the parameterization and store automatically, safe from power failures.

The data are not automatically stored with **A40** (read Parabox).

The Controlbox Tool program makes it possible to directly transmit the parameters between Controlbox and a PC.

7.2.4 Parameterization

The following six keys are used for the parameterization with Controlbox.

- Return to prev. menu level
- Select various menu levels
- Reject changes
- Accept changes
- Acknowledgement of mal-functions (**A31=1**)

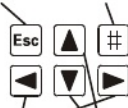

- Group selection
- Parameter selection
- Edit parameters

To program, press the **#** key (Enter). You are now in group selection. The menu is divided into **groups** which are identified as **A, B, C, ...**. Select the groups with the arrow keys (i.e., **▲** and **▼**). Press the **#** key again to access the parameters of the selected group. The parameters are designated with the group letters and a number (e.g., **A10** or **D02**).

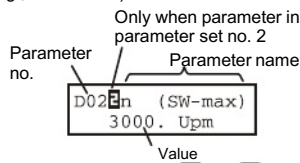

Parameters are selected with the **▲** and **▼** keys. To change a parameter, press the **#** key again. The flashing value can now be changed with **▲** and **▼**. The changes take effect

immediately. The change value is accepted by pressing the **#** key. The **Esc** key undoes the change. To return from parameter selection to the group letters, press **Esc**. To return to the status display, press **Esc** again.



Parameter changes must be saved with A00=1 (save parameters) before the device is turned off.

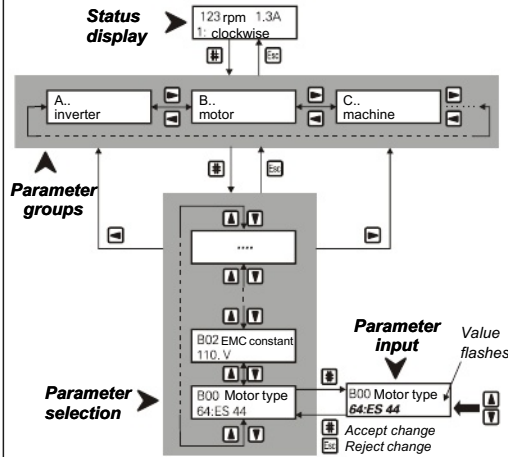

In the default setting (status on delivery), the inverter only displays the most important parameters required for commissioning. For complex drive tasks, the *expanded menu* is activated with **A10=1**.

With **A10=2:service**; Access to rarely used service parameters. Both the normal menu and the expanded menu do not show parameters which are not related to the current task.

Example: When a predefined STÖBER motor (e.g., ES 44) is selected in parameter **B00** (motor type), parameters **B10** to **B17** (poles to M0) are not shown.

Approximately 50 sec after the last key was pressed, the device returns automatically to the status display. This return can be switched off with **A15=0** (auto return inactive).

Fieldbus: Most of the parameters pertaining to the fieldbus can only be set on the PC with FDS Tool.

7.2.5 Password

The parameters can be protected against unauthorized change. To do this, enter a password (a number between 1 and 9999) in parameter **A14**, and save it with **A00=1**. Password protection is inactive if **A14=0**. The Parameter **A14** can only be accessed in the extended menu with **A10=1**.

On a protected device, the parameters can only be changed after the correct password has been entered in **A13**.

8. Commissioning

8 COMMISSIONING

8.1 Default setting

To obtain the default setting, set parameter **A04**=1. The default settings are listed below.

- Run mode: Speed
- Speed reference value via AE1 (fast reference value **D99**=1)
- 10 V = 3000 rpm
- Encoder output X20: 1024 imp./U.

Ramps:

- Binary input 1 (**F31**): 1: Halt (ramp inactive)
- Binary input 2 (**F32**): 2: Direction of rotation
- Binary input 3 (**F33**): 9: Quick stop
- Analog output 1 (**F40**): 4: E08 n-motor
- Analog output 2 (**F45**): 1: E00 l-motor
- Holding brake is not addressed.

⇒ The expanded menu is activated with **A10**=1.

8.2 Motor, braking resistor

Before the drive is commissioned, the STÖBER ES servo motor must be identified on the SDS. Selection with **B00** is performed from a motor database.

- In **B00**, select the motor type (e.g., 64:ES44).
- In **B02**, enter the "EMK" constant (standard = 110 V).
- In **B26**, enter the motor encoder (standard = resolver).
- When a holding brake is to be addressed, set **F08**=1, and enter the application and release time in **F06** and **F07**.

- With external fans, set **F03**=1.
- Torque limits **C03** and **C04** must be adjusted to the loadability of the mechanical parts (i.e., gear box). **C03** and **C04** are percentages relative to standstill torque **M0** of the motor. Limit **C04** is used for quick stop, for example. Usually

$$C03 = C04 \leq M_{2B_gearbox} / M_{0_motor} / i \quad (*)$$

must be set (M_{2B} = max. acceleration torque of the gear box, i = transmission). Starting with the 1999 edition, the SMS catalog lists in column S_{C03} the value (*) to be entered as a suggestion. For more information on torque limits, see chapter 9.2.

This can be monitored with a phase test using **B40**=1 (procedure: enable off; **B40**=1; enable on; enable off again when finished). **Caution:** The drive must be decoupled from the load since movement takes place. For details, see **B40** in the parameter list.

With external motors, the selection "60:user defined" must be made in **B00** with input of the other motor parameters **B02** to **B17**. This information can usually be found on the motor nameplate.

This procedure must be concluded with **B40**=1 (phase test).

Caution: Make sure that the load is decoupled from the drive!

8.3 Speed specification

There are many ways to specify the speed. However, remember that parameter **D99 fast reference value** restricts the possibilities.

- D99=1:active** Fast sampling (1 msec) of analog input AE1. **Caution:** Reference value options and fixed reference values are not shown.
- D99=0:inactive** Release the fixed reference values and access to all reference value parameters. Sample analog input AE1 = 4 msec

8.3.1 Speed specification via Controlbox

Controlbox offers a commissioning function without circuiting the control terminals. The tipping speed is determined by the following selection. It can be changed with the appropriate parameters.

- Speed control **C60=1:** Tip speed / Tip ref. value (**A51**)
- Position control **C60=2:** Tip speed (**I12**)

- Activation/deactivation of local operation is signaled by LED.
- Connect drive. Motor is under power. Indicated by LED.
- Move drive (right/left) as long as the keys are pressed.
- Motor becomes currentless.

8.3.2 External speed specification

- Connect speed reference value to analog input AE1.
- Enter speed at 10 V in parameter **D02**.
- When higher-level position control is being used, **D02** must exceed the maximum speed actually required by at least 10% (i.e., control reserve).
- Any offset for the analog input can be compensated for with **D06**.
- If required, program ramps with **D00** and **D01**.

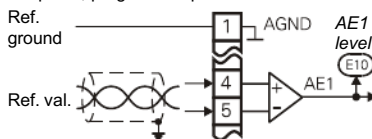

8.3.3 Speed specification via potentiometer

When a potentiometer is used to specify the reference values,

the analog outputs must be parameterized to +10 V or -10 V reference voltage. **Caution:** R=2.2 kΩ.

- **F40**=7:+100% for + 10 V on analog output 1
- **F45**=8:-100% for - 10 V on analog output 2
- Set **F47** (analog output 2 factor) = 100%

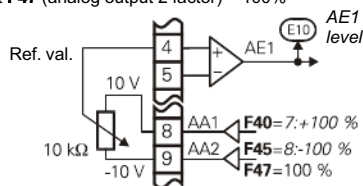

8. Commissioning

8.3.4 Characteristic curve of ref. value

With fast reference value (**D99=1**) active, the reference value must be available on AE1. With **D99=0**, the (main) reference value can be available on either AE1 or AE2, but the AE function (i.e., either **F25** or **F20**) must be *10:reference value* (default setting for AE1). The speed is calibrated with the parameters **D06** (RV offset) and **D02** (speed at maximum reference value). Parameter **D03** (maximum reference value) is helpful, for example, when the higher-level controller can output a maximum of 5 V (i.e., **D03=50%** would then have to be entered).

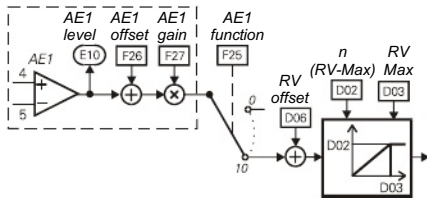

8.3.5 Speed specification via fixed ref. value

With **D99=0** (fast reference value inactive), 8 fixed ref. values (FSW) are available with the corresponding ramps in group **D**. Binary coding via signals RV-select 0 to RV-select 2 (param. **F31** to **F34**) is used for the selection. The combination "000" corresponds to the conventional analog reference value.

8.3.6 Speed specification via clock pulse generator

A clock pulse generator is available to optimize the speed controller.

- Enter desired speed in **A51** (e.g., 50 rpm).
- Activate clock pulse generator with **D93=1**.
- Enter clock pulse cycle in **D94** (e.g., 0.5 sec).
- Activate enable.

The drive switches the speed between **+A51** and **-A51** with cycle **D94**.

8.3.7 Motor potentiometer

The "motorpoti function" can be used to steplessly increase or decrease the motor speed via two binary inputs.

- Two binary inputs are programmed to "4: motorpoti up" or "5: motorpoti dwn" via **F31** to **F34**.
- The "motorpoti function" is activated with **D90=1**.
- When the key is pressed, the speed is changed in accordance with ramps in **D00** and **D01**. When the "motorpoti function" is active (**D90=1**), most of the parameters of group **D** (reference values) are not indicated.
- **D90=2** causes the motor potentiometer to be added to the normal reference value.
- The reference value generated by the motor potentiometer is set to 0 if both binary inputs are high.
- With **D91=1**, the ref. value is saved in non-volatile memory.
- With **D91=0**, a low level on the enable deletes the motor potentiometer reference value.

⇒ The motor potentiometer function is not available when **D99=1** (fast reference value).

8.3.8 Frequency reference value

There are two ways to accept the frequency reference value.

- Incremental encoder, tracks A and B
- Stepper motor signal, frequency + sign

For connection, see chapters 4 and 5. The software must be programmed to "el. gear," as described in chapter 11.

8.4 Speed controller

The speed controller is an ideal PI controller with reference value smoothing. With STÖBER ES motors, the optimum function of the speed controller is ensured by the default setting. The necessity of controller adjustment (parameters **C31**, **C32** and **C33**) is usually restricted to:

- Great external moments of inertia (**C31** ↑, **C32** ↓, **C33** ↑)
- Mechanical parts with oscillation capability (**C31** ↓, **C33** ↑)

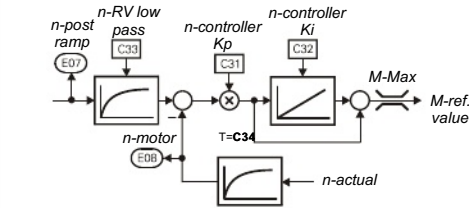

8.5 Halt / quick stop

In the default setting, binary input BE1 is programmed to

F31=8:halt. In the default setting, the halt is performed without ramp since **D01=0** sec is preset. A separate deceleration ramp can be implemented with the function "9:quick stop" (**D81** Decel-S). In the default setting, BE3 is programmed to **F33=9:quick stop**.

With operational mode "position," the ramp function is always active. The process block Decel ramp takes effect with halt. Max. acceleration **I11** takes effect with quick stop.

8.6 Brake control

The addressing of a +24 V motor halting brake is activated with **F08=1**. The connections are available on X13 (B+ and B-). The brake is released by the end stage enable and closed with falling enable. The set release time **F06** and the application time **F07** of the brake is considered.

The brake is applied again under the following conditions:

- Removal of the enable. Watch **F38=1**.
- Halt. One BE must be programmed to HALT (e.g., **F31=8**).
- Quick stop. One BE must be programmed to quick halt

- (e.g. **F31=9**) **F38=2**.
- For process block for positioning, see group **L**.

The motor halting brake can be manually released. For this, parameter **F08=0** must be set and one component must be assigned with the function "32: breakRelease" and addressed. Caution: Before this, ensure safe state for brake release. Even when **F08=0**, the brake output is addressed. The release and application times are not considered, however. This function is intended to prevent excess wear when the brake functionality is not configured (starting with SV 4.5B).

9. Torque Limits / Operating Range

8.7 Binary inputs BE1 to BE4 (Opt. BE5 to BE15)

With the default setting, the binary inputs which can be programmed as desired have the following meaning.

- BE1 = 8: Halt
- BE2 = 6: Direction of rotation (left/right)
- BE3 = 9: Quick stop
- BE4 = 0: Inactive

Option board SEA-4000 offers 10 additional binary inputs. The function of the binary inputs is specified via the parameters

F31 to **F34**, and **F60** to **F69** in the extended menu (**A10**=1).

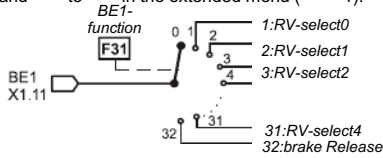

When several inputs are connected to one function, the signals are either AND or OR-linked (**F30** BE-logic). Functions without a connection to a BE signal are provided internally with an L-level signal.

8.8 Parameter record selection

The SDS inverter supports two separate parameter records. Specification of the active parameter record is performed in one of the following ways.

- Externally via a binary input (**A41**=0)
- Internally via a keyboard (**A41**=1 or 2)

The active parameter record is indicated in **E84**. To specify via a binary input, one of the parameters **F31** to **F35** must be set to "11:paraSet-select" in both parameter records. Selection never takes place unless the power section is deactivated.

The parameters of both parameter records can be indicated and programmed regardless of which parameter record is currently active. **A11** (paraSet Edit) is used to specify the parameter record (1 or 2) to be edited. When parameters of the 2nd record are involved (**A11**=2), a **E** is indicated to the right of the parameter number.

Certain parameters (e.g., operation input, **A30**) are only available once, and a **E** is then not indicated next to the parameter number. This applies to all parameters of group **A**, the display parameters of group **E** (e.g., torque, utilization and similar), and positioning (groups **I**, **J**, **L** and **N**).

Example of time behavior with quick stop for enable-off (**F38**=1, for enable see also **F31**=11):

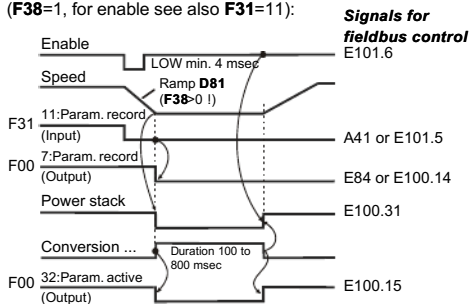

When autostart is active (**A34**=1), the switchover takes place immediately when the edge of the signal "11:Paraset" occurs. Enabling is automatically deactivated internally.

Parameter records can be copied via **A42** and **A43** (copy paraSet). **A42**: copy paraSet 1 > 2 to "1:active" overwrites parameter record 2 with the values of parameter record 1.

⇒ Usually, the first parameter record should be set up first.

The parameters are then copied to parameter record 2 with **A42**=1 (active). **A11**=2 is then used to switch to parameter record 2 and edit the necessary values there.

After completion, all parameters are saved with **A00**=1.

Remember: When the mode (**C60**) is switched from position to speed, the actual position during **C60**=1 is only partially included. This means the reference position is lost when you switch back (**I86**→0).

With electronic gear boxes, the internal variables like the current angle of deviation are retained when a parameter record is switched (prerequisite: **C60** remains the same). However, the parameters of group **G**.. are switched.

8.9 Acknowledgment of faults

The table of possible faults is located on page 48. Faults are acknowledged in the following ways.

- **Enable:** Change from L to H level on the enable input, and then back to L. Always available.
- **Binary input (F31 to F34=13)**
- **Key** (only when **A31**=1) and only in the display
- **Auto reset** (only when **A32**=1)

Caution!
Drive starts up immediately.

Parameters **E40** and **E41** can be used to scan the last 10 faults. Value 1 represents the last fault. FDS Tool can be used to define the inverter reaction (e.g., fault, warning, message or nothing) to certain events (e.g., overload, excessive temperature, and operating range) as desired.

The fault "37:n-feedback" can only be acknowledged by turning the 24 V supply off and on.

8.10 Motor startup

A34=0 (auto-start inactive) in the default setting prevents the motor from starting up by itself after the power is turned on. Cf. operation status "12:inhibited" on page 45. Before activating auto start (**A34**=1), check to determine whether safety requirements permit an automation restart.

9 TORQUE LIMITS / OPERATING RANGE

9.1 Torque limits

There are several methods of limiting motor torque.

- In the default setting, **C03** (M-Max 1) is the current torque limit in % of motor standstill torque **M0**.
- A binary input (assign BE funct. "10:torque select" via one of the param. **F31** to **F34**) can be used to switch between the two torque limits **C03** (M-Max 1) and **C04** (M-Max 2).
- Analog input **AE2** can also be used to limit torque. Set parameter **F20**=2.10 V corresponds to 100% motor standstill torque **M0**. Other scaling is available via **F22** (**AE2** gain).
- With quick stop, **C04** always takes effect.

10. Positioning Control

The actually effective torque limit is calculated from the minimum of the various limit values. It can be scanned in parameter **E62**. Maximum available torque is always limited by the maximum inverter current.

9.2 Operating range

Freely programmable comparators can be used to simultaneously monitor 3 measured values (i.e., "operating range"). The first 2 values (speed and torque) are fixed. The third value can be selected as desired with **C47**. The limit values are specified with the following parameters.

- **C41, C42:** n-Min, n-Max
- **C43, C44:** M-Min, M-Max
- **C45, C46:** Measured value "X" (specified in **C47**)

C48=1 monitors the absolute value of measured value "X" (**C47**). **C48=0** also includes the sign. Parameter **C49** specifies whether monitoring is also to be continued during acceleration phases and enable-off. When at least one of the limits is exceeded, this can be signaled on a binary output with the "6:operation range" function (e.g., **F00=6**). Another use is the control of process-block chaining (cf. **J17=4**).

If only one or two of these range monitoring options are used, the limits of the unused ranges must be set to their limit values (e.g., **C43=0%** and **C44=400%** when torque monitoring is not required).

10 POSITIONING CONTROL

The basic model of the SDS 4000 servo inverter offers integrated positioning control.

Since the capabilities of standard devices are limited by the number of inputs available, use of option board *SEA-4000* or digital communication (e.g., RS 232, CAN bus and PROFIBUS-DP) is recommended for solving typical positioning tasks.

10.1 Function overview

- 32 positions can be programmed as 32 process blocks.
- Continuous position control with following error monitoring
- Parameterization in units (e.g., degrees, mm)
- Resumption of interrupted process blocks possible
- Change in destination possible during traversing
- Reference point travel with several modes
- Sequence programming possible via process block chaining (e.g., "Go to pos. 1, wait 2 sec, go on to pos. 2, wait for signal and return")
- Tip mode (inching)
- Teach-in function
- Speed override via analog input possible
- Any gear ratios are calculated with fractions without rounding errors. No drifting with continuous axes.
- Continuous referencing for continuous axes
- "Electrical cam" function switches digital output within programmed position range.
- Hardware and software limit switch
- Rotary attachment function
- Path specification via analog input possible
- Brake control for lifting systems
- Positioning with absolute value encoders (also continuous mode)

10.2 Connections

The standard device without option board is used for simple applications.

Applications with greater demands on binary inputs require the use of the **SEA 4001 option board**.

The SEA 4000 expansion board offers 10 binary inputs and 5 binary outputs.

An analog input can be used to adjust positioning speed steplessly. Called "speed override," this function is not only

useful during the commissioning but also a feature in mode on.

Below is a typical configuration with option.

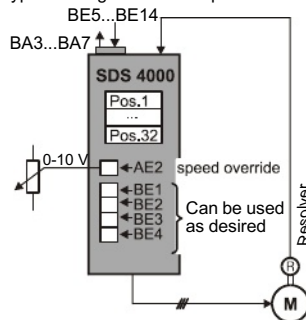

The following functions for binary inputs (parameters **F31** to

F34 and **F60** to **F69**) are important:

- **RV-select0 to 4:** Binary coded position selection. Process block 1 is selected with "00000," and process block 32 is selected with "11111."
 - **8:halt:** Rising edge interrupts running motion with the current process block ramp. Since tip mode (i.e., inching) via binary inputs is not possible unless halt is active, halt switches between tip and automatic operation.
 - **9:quick stop:** Rising edge interrupts positioning with maximum acceleration **I11**.
 - **16:posi.step:** When a chain of process blocks is being used, *posi.step* starts the consecutive process blocks. A movement which is in progress is not interrupted.
 - **19:posi.start:** Starts the just selected process block. A movement which is in progress is always interrupted.
 - **20:posi.next:** Only for chained process blocks. If programmed appropriately (cf. **J17=3**), immediately concludes the running process block, and starts the next one. A remaining path which is to be traveled after *posi.next* occurs can be defined. See chapter 10.8.
 - **17:tip+, 18:tip-:** Tip mode (i.e., inching)
 - **21:stop+, 22:stop-:** Limit switch
 - **23:reference input:** Reference switch connection
 - **24:start reference:** Starts reference point traversing
 - **25:teach-in:** Actual position is assumed in the just selected process block.
- ⇒ The binary inputs can be inverted via **F51** to **F54** and **F70** to **F73**. Removal of the **enable** always causes a quick stop with maximum acceleration **I11**.

Analog inputs AE2 and AE1 (par. **F20** and **F25**)

- **1:additional RV:** Relative traversing paths are multiplied by (100% + level). Example: 0 V → no additional reference value (i.e., 100% of the traversing path).

10. Positioning Control

- **4:RV-factor:** Relative traversing paths are multiplied by the level. Example: 0 V → no movement (i.e., 0% of the traversing path).
- **5:override:** The programmed positioning speed can be changed online via potentiometer ("speed override" function for CNC controllers), for example.
- **6:posi. offset:** An offset can be added to the current position online via AE2. Cf. parameter **I70**.

Binary outputs (par. **F00, F80, F81, ...**)

- **3:Ref Val reached:** Location in position window **I22**. Signal appears when drive "in position."
- **8:electrical cam:** Signal appears when the actual position is located between parameters **I60** and **I61**. Signal is used as message to other modules, for example.
- **9:Following error:** Signal appears when the maximum following error in **I21** is exceeded.
- **10:Position active:** Drive is in position control. No process block and no process block chain being processed.
- **13:referenced:** Drive is referenced.
- **19:s-memory1 to 21:s-memory3:** Output the memory locations set by the posi switching points during process-block movements (see chap. 10.12).
- **23:RV-ackn.0 to 25:RV-ackn.4:** Binary coded response message from the active **I82** process block. Cf. diagram in chap. 10.3.

10.3 Destination positions and process blocks

Each position to be approached to is described by several parameters. Together these parameters make up a process

block. Up to 32 process blocks are available. The first 8 process blocks can be accessed via Controlbox. Process block no. 1 is described by parameters **J10** to **J18**, while the second process block is described by parameters **J20** to **J28**, and so on.

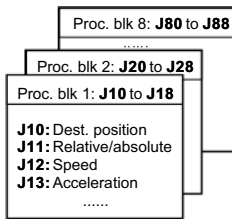

Process blocks 9 to 32 can only be programmed via FDS Tool or via fieldbus.

A process block can be selected as shown below.

- Binary coded via binary inputs **RV-select0** to **RV-select4**. The binary combination "00000" selects process block no. 1, while "11111" selects process block **J02-02**. Selection via binary inputs is not possible in block **J02-02**.
- Parameter **J02** if not equal zero here.

The **response message** of the current process block appears:

- In parameter **I82** ("active process block")
- In the 2nd line of the operational indication
- It is binary-coded from binary outputs "23:RV-ackn.0" to "27:RV-ackn.4."

The selected process block is shown inverted until the movement starts.

When a process block starts, the active block is not shown inverted (binary-coded like **RV-select** signals) as long as **posi.start**, **posi.step** or **posi.next** is queued.

When a process block cannot be started (e.g., see "51:refused"), the selected block continues to be shown inverted. This happens even when a movement is terminated.

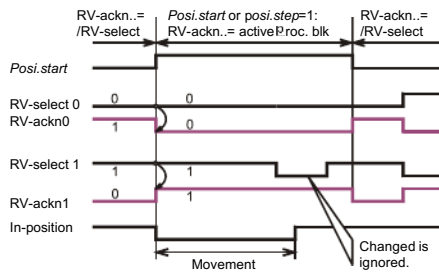

- ⇒ When the position is specified directly via **fieldbus**, process block 1 (**J10**) receives special treatment. The inverter does not acknowledge the write routine until all internal conversions have been completed and the inverter is ready to start. The parameter **E124** ("start.pos 1") is also available from the fieldbus. **J10** is written here and, after conversion, is immediately started automatically. The output signal "32:param.active" signals the completion of a parameter conversion.

10.4 Absolute/relative positioning

One of 4 possible traversing methods (parameters **J11, J21, J31** and so on) can be assigned to each process block.

- Relative
- Absolute
- Continuous, positive
- Continuous, negative

A **relative** path always refers to the current location (chain dimensions).

An **absolute** position refers to a fixed reference point (i.e., machine zero point) which is determined with *reference traversing*. See chapter 10.6. For this reason, an absolute position **always** requires reference traversing. Any start commands given without reference traversing are answered by the inverter with "51:refused".

When a process block is defined as **continuous** and a start command is given, the axis moves in the specified direction until a signal arrives from the outside (e.g., **posi.next** or **posi.start**). The speed can be adjusted via analog input AE2. (Set the AE2 function **F20=5:Override** for this.)

Successful conclusion of a movement is signaled via the output signal "reference value-reached" (**F00=3** and **F80=3**). This signal appears when the actual position lands in the **position window** (destination $\pm I22$) for the first time. The signal is not withdrawn until the next traversing command is given.

10. Positioning Control

10.5 Commissioning

Before positioning control is activated, speed control must be commissioned and, if necessary, optimized with the FDS Scope function.

Positioning control is activated with

C60=2:position

The **status indicator**¹ changes and displays the actual position in the first line.

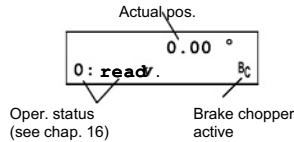

Important: If you want to change the location of the decimal point in the position display via **I06 (I06=decimal point shift)**, do this at the beginning of commissioning since the significance of all positions is changed.

10.5.1 Limited position range

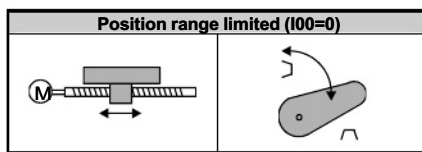

Limited traversing range means that the permissible area of movement is restricted by end stops or similar. Safety requires that limit switches be provided. If the inverter is not equipped with a sufficient number of free inputs (i.e., operation without an option board), the limit switches must be evaluated by a higher level controller. The primary parameters are listed below:

- **I00=0** Limited traversing range
- **I05: Unit of measurement** (e.g., mm, degrees (°), inch)
- **I06:** Number of decimal places
- **I07: Distance per motor revolution** (e.g., mm/U)
- **I10:** Maximum speed (e.g., mm/sec)
- **I11:** Maximum acceleration (e.g., mm/sec²)
- **I12:** Tip mode speed

Important: Since some parameters in groups **I** and **J** (e.g., paths or accelerations) may assume very large values, the keys can be used to directly select (via Controlbox) the tens exponent to be changed. Only the individual digit flashes and not the entire number. The keys can be used to increment/decrement the value by the selected tens exponent:

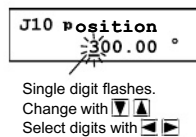

⇒ Before starting initial tests, check the limit switches, and decouple the drive from the machine if necessary.

The enable can now be activated as the first test. The display¹ shows

17:posi.active

The position control loop functions, and the current position is maintained. During the next step, the drive is moved via **tip mode (i.e., inching mode)**. Set parameter **J03=1** for this. The keys can be used to traverse the drive.

⇒ The speed can also be changed during traversing via analog input AE2 (**F20=5**).

The next step is the commissioning of reference traversing. See chapter 10.6. **Software limit switches I50 and I51** can be programmed with a referenced axis (**I86=1**). The software limit switches prevent movement to positions outside **I50** and **I51**.

A short relative movement (**J11=0**) can be specified in **J10** (destination position process block 1) for testing purposes. The speed is entered in **J12**, while the ramps are entered in **J13** and **J14**. **J00=1** can be used to start and monitor the movement. Do not forget the enable.

10.5.2 Continuous traversing range (rotary axis)

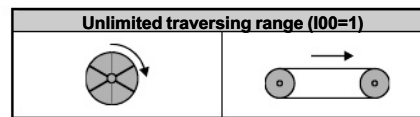

The most important feature of a continuous traversing area is the cyclic repetition of certain positions during movement in one direction (e.g., hand on a clock).

Gear ratio: Parameters **I07** and **I08** permit precise specification of the gear ratio (i.e., based on the number of teeth). This prevents a path drift with relative positioning. Cf. examples in chapter 10.9.

Rotary axis function: Selection of **I00=1:unlimited** means that the actual position is only counted up to *circular length* **I01** (e.g., 360°). After this value, counting begins again at zero. If both directions are permitted, the movement progresses from point A to point B (i.e., absolute destination specification) over the shortest path (i.e., **path optimization**).

Direction of rotation: If both directions are permitted (**I04=0**), the movement from A to B is performed over the shortest path when **absolute** destination specification is used (**I03=1, path optimization active**). However, with block changes on the fly, the original direction of rotation is retained. Limitation of the permissible direction of rotation **I04** affects all process blocks and manual traversing. An alternate method is to use **I03=0** to deactivate path optimization. Remember, however, that, when you want to approach an absolute destination in the *negative* direction of rotation, you must enter the destination with a *negative sign* (in connection with the modulo calculation). Example: After you enter -270°, the drive moves to position 90° *rotating counterclockwise*.

A short relative movement (**J11=0**) can be specified for testing purposes in **J10** (destination position, process block 1). **J00=1** can be used to start and monitor the movement.

¹ Only in connection with a Controlbox

10. Positioning Control

10.6 Reference point traversing

When the 24 V supply voltage is turned on, the actual position is unknown. A defined preliminary position is achieved with *reference traversing*. Absolute movements can only be performed in referenced status. The referenced state is signaled with **I86=1** and can be output on the binary output.

Reference point traversing is parameterized with **I30** to **I38**. The primary parameters are listed below.

- **I30**: Type of reference point traversing
- **I31**: Direction of reference point traversing
- **I32**: High-speed reference point traversing
- **I33**: Low-speed reference point traversing
- **I35**: Zero-pulse of the motor encoder
- **I37**: Automatic reference point traversing at power-on

There are three ways to start reference point traversing.

- Automatically (**I37=1** or **2**)
- Signal on binary input (**F31** to **F34=24**)
- Inching with **J05=1**

If only one direction (**I04>0**) is permitted, reference point traversing is performed from the beginning with speed **I33**. Reference traversing type **I30** specifies the required initiators or the functions for binary inputs. **I31** is used to determine the (search) direction when reference point traversing is started. If the reference switch (or limit switch) is active, the direction is reversed. Cf. example 2 further down. The correct value for **I31** can be tested by inching the axis (parameter **J03**), for example. The status of the binary inputs can be scanned in **E19**.

Specification of two speeds (i.e., **I32** and **I33**) is primarily an advantage for long linear axes.

The **acceleration** during reference point traversing is 1/2 of the maximum acceleration in **I11**. When the reference point is detected, the actual position is set to **I34** (i.e., reference position), and the drive brakes until it is at a standstill. The distance required for reversal or braking is generally

$$\text{Distance} = \frac{1}{2a} v^2$$

With v: Speed
a: Acceleration (**I11/2** here).

After reference point traversing has been concluded, the drive remains where it is after the required braking distance (**I33²/I11**) and does not return to the reference position. Cf. above. The AE2 "override" function (**F20=5**) changes the speed and also the braking distance.

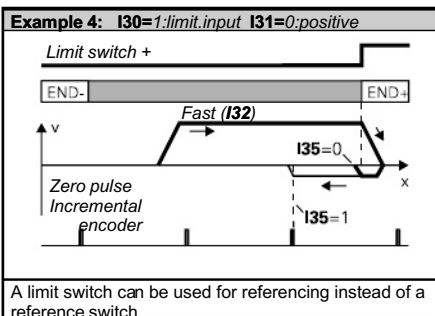
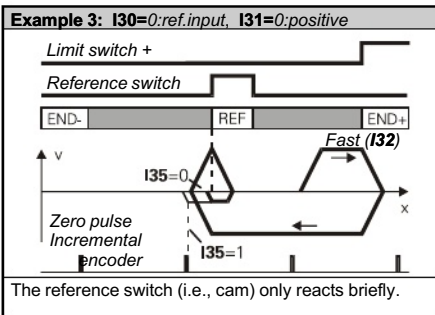
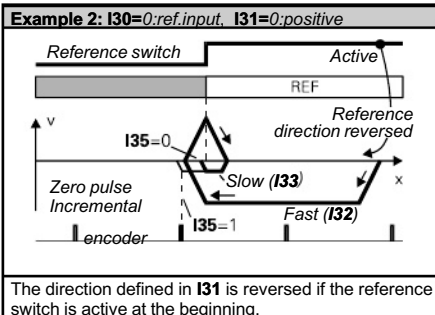
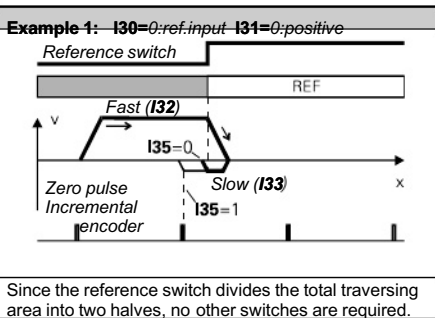

When the power or the external 24 V voltage supply fails, the information on the reference position is lost. After power returns, **I37=1** is used to automatically trigger reference point traversing with the first start command (i.e., *posi.start* or *posi.step*). After a reference point traversing procedure has been concluded, you can automatically move to any initial position by programming parameter **I38** (*ref. block*) to the number of the parameter record to be approached.

10. Positioning Control

10.7 Position controller

To minimize following error deviation (i.e., difference between reference value and actual position), the SDS uses speed precontrol (speed feed forward). The maximum permissible following error deviation specified in **I21** is continuously monitored. The position controller is running continuously during the entire movement.

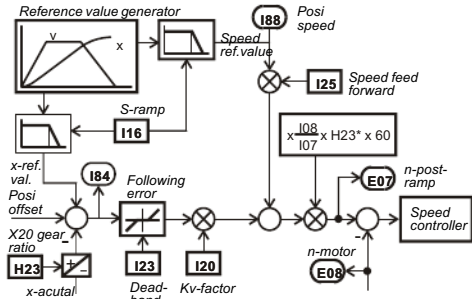

- **H23** (X20 gear ratio): Example of position control using X20

The gain of position control **I20** (i.e., the "stiffness" of control) is called the "Kv factor."

The parameter **I16** (S-ramp) can be used to parameterize "joltless" traversing profiles and prevent high-frequency excitation due to a low pass. The time constant **I16** corresponds to a low-pass limit frequency of $fg=2\pi/I16$.

10.8 Process block chaining

The "next block" parameters **J16**, **J26**, **J36** and so on can be used to chain process blocks into sequences. For example, at the end of one process block, this can be used to automatically move to an additional position (i.e., next block). The following parameters apply to the 1st process block.

- **J16** next block. If **J16=0**, then no chaining.
- **J17** next start. Specifies how next block **J16** is to be started.
- **J18** delay. Applies when **J17=1:with delay**

For details on **J17**, see the parameter table.

Example 1: With a rotary attachment, 60° steps are performed in a continuous cycle with 1-sec pauses in between.

Solution: **J10=60°** (Path)
J11=0:relative (Position mode)
J16=1 (Next block no. 1)
J17=1:with delay (Next start with delay)

⇒ **J18=1.000 sec** (delay of 1 sec)
 ⇒ Process block no. 1 starts itself.

Example 2: Three fixed positions are always traversed in the same order.

Solution: **J10, J20, J30=Destination specification**
J11=J21=J31=1:absolute
J16=2, J26=3, J36=1 (chaining)
J17=J27=J37=0:posi.step

⇒ The movements are triggered by the rising edge of the *posi.step* signal.

Example 3: A conveyor belt is to stop after exactly 100 mm following a sensor signal.

Solution: **J11=2:endless positive**
J16=2 (Next block no. 2)
J17=3:posi.next (Next start)
J20=100 mm
J21=0:relative

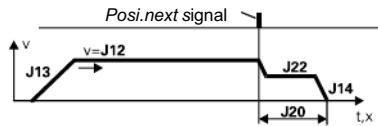

⇒ The *posi.start* signal starts process block no. 1. The drive continues to run until the rising edge of the *posi.next* signal after which a branch is made to process block no. 2. When *posi.next* is connected to BE1, the reaction occurs without a delay time. If the **J17=3:posi.next** setting is not made, *posi.next* is ignored! Cf. example 4.

Example 4: Positioning of a shelf handling device. The exact destination position is specified by a light barrier which is triggered briefly at each shelf. Until just before the destination, the signals of the light barrier must be ignored. We will assume that the destination is located between 5.1 m and 5.4 m.

Solution:

The approximate position is traveled to with block no. 1.
J10=5.1 m (Approximate position)
J11=1:absolute
J16=2 (Next block no. 2)
J17=2:no stop (Next start)

Posi.next is activated in block 2 (**J27**).
J20=5.4 m (Maximum position)
J21=1:absolute
J26=3 (Next block no. 3)
J27=3:posi.next (Next start)

The braking distance is defined in block 3.
J30=0.05 m (Braking distance)
J31=0:relative

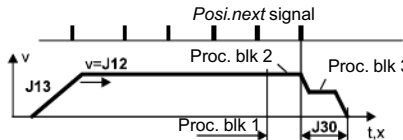

⇒ Process block no. 1 is started with *posi.start*. Just before the probable destination and without an intermediate stop, a switch is made to process block no. 2 where the *posi.next* signal is armed. Process block no. 3 is triggered with *posi.next*, and the braking distance specified in **J30** is executed. If the *posi.next* signal fails to appear (e.g., light barrier is defective), the drive stops at position **J20**.

Tips:

- An operational status of **17:posi.active** indicated on the display means that no process block and no chain of process blocks (i.e., sequential program) is being executed at the moment. The drive is under position control. The *posi.start* and *posi.step* signals have the same effect here.
- **I82** indicates the number of the process block currently being processed. **I82=0** means that no process block is being processed.

10. Positioning Control

- The inverter assumes the basic state "17:posi.active" when the enable is turned off and on.
- The "17:posi.active" state can also be output on BA1 or BA2.

10.9 Simple examples

Without the option board, 4 digital inputs are available.

Example 1: Belt drive (i.e., endless movement). Four different feed lengths are traversed relatively.

Solution: BE1: RV-select0 (F31=1)
BE2: RV-select1 (F32=2)
BE3: posi.start (F33=19)

BE1	BE2	Block	Process Block Parameter
0	0	1	J10,J12,J13,J14
1	0	2	J20,J22,J23,J24
0	1	3	J30,J32,J33,J34
1	1	4	J40,J42,J43,J44

⇒ The traversing method (e.g., J11, J21, J31 and so on) remains set to "0:relative" for all blocks. The selected process block is indicated in I83.

Example 2: Linear axis with end stops. Two fixed positions are traversed absolutely.

Solution: BE1: RV-select0 (F31=1)
BE2: posi.start (F32=19)
BE3: ref.input (F33=23)

BE1	Position	Process Block Parameter
0	1	J10,J12,J13,J14
1	2	J10,J12,J13,J14

⇒ The traversing method (J11 and J21) for both process blocks is "1:absolute." After power-on, reference point traversing is automatically executed by I37=1 with the first posi.start command. The reference switch must have the characteristics shown in example 1 of chapter 10.6.

Example 3: Belt drive (endless movement) with stop at pulse (i.e., defined braking distance)

Solution: BE1: posi.start (F31=19)
BE3: posi.next (F33=20)
J11=2:endless positive
J17=3:posi.next
J20=...(braking distance)

⇒ We recommend applying the posi.next signal to BE1 (F31=20) so that the delay time of 4 msec is omitted. Evaluation of posi.next is activated with J17=3.

For additional details on posi.next, see chapter 10.8 (chaining of process blocks).

Example 4: A rotary attachment is to be positioned continuously and without drift in 60° increments. A STÖBER K302 0170 with i=16.939393... is to be used as the gearbox. The exact ratio is i=3354/198.

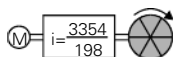

Solution: The rotary attachment rotates precisely 360° x 198 / 3354 per motor revolution. Thus, I07=71280, and I08=3354. The path is programmed in degrees (J10=60°). The circular length I01 is 360°.

Example 5: A toothed belt drive is to move continuously and without drift in fixed increments (41 catches per circular length). The toothed disk has 23 teeth, while the belt has 917 teeth. For gearbox, see above.

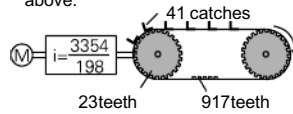

Solution: The path is programmed in units of distance. One unit of distance is exactly one catch. The belt drive rotates precisely 198 / 3354 x 23 x 41 / 917 units of distance per motor revolution. Thus, I07=186714, and I08=3075618. The path is programmed in units of distance=1/41 of the circular length. The circular length I01 is 41 units.

Example 6: A conveyor belt drive with slip is to move in fixed increments continuously and without drift. Exactly 41 catches are distributed over a circular length of 4 m.

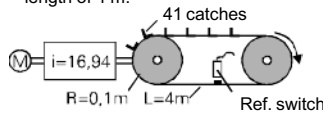

Solution: The distance per motor revolution is 2 πR/i. Thus I07=37.09 mm/R. Drift is prevented by continuous referencing (I36=1) or the posi.next signal.

Important: The distance to be traveled (e.g., J10) multiplied by the number of catches (41) must precisely equal the circular length I01. If not, the drive will drift away even with continuous referencing. If necessary, I01 and I07 must be adjusted accordingly. The reference switch should be located between two catches.

Important: When continuous referencing I36=1 is used, I07 must always be rounded off to the next higher number.

Example 7: Screw/press controller Starting at a certain position, the torque is to be monitored. When a limit is exceeded, a return to the start position is made.

Solution: The first part of the movement is handled by process block no. 1. Without stopping, the system switches to process block no. 2 before the end position (J16=2) and J17=2). The speed remains the same (J12=J22). When the torque limit (working area) specified by C44 is exceeded, the system switches to process block no. 3 (J26=3 and J27=4). In our example, the working area is limited by the maximum torque C44.

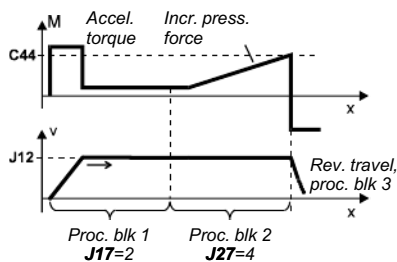

10. Positioning Control

10.10 Emergency off

If the power is cut off from the inverter with the emergency off switch, all information on the position is lost. When the inverter goes on again, the power must be referenced again.

When 24 V is provided via an option board, a movement which is interrupted by an emergency off can be continued and completed under the following conditions.

- The HALT signal becomes active at least 4 msec before the enable is removed.
- The HALT signal remains present until power returns and the enable is minimum 4 msec active.

Another method of interrupting and continuing a process block is to use the following sequence of signals.

EMERGENCY OFF Operation

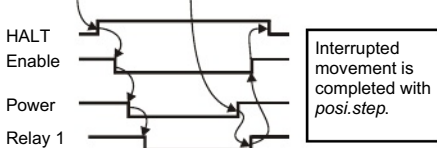

Parameter **I19=1** can be used to specify that an enable-off will lead to "23:interrupted." The interrupted process block can then be completed with *posi.step*. With the default setting (**I19=0**), removal of the enable causes sequence control to be reset (status "17:posi.active"). Process blocks with chaining "without a stop" (**J17=2**) can only be terminated (status "17:posi.active").

10.11 Ext. rotary / linear path measurement

When an "external" measuring system is mounted directly on the machine for positioning, this measuring system controls the position. The motor is controlled with its own encoder (standard procedure).

Example for linear path measurement:

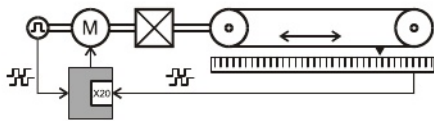

Important: The external measuring system must be able to supply at least 30 measuring increments per revolution - as converted to the motor shaft.

10.11.1 Position encoder

The encoder for position control is selected with **I02** and the motor encoder for motor control is selected with **B26**. The following table lists the possible interfaces with the inverter's supply voltages U_B and the parameters for the number of increments (*inc/R*) and the gear ratios between motor and encoder (*gear-i*).

	Remarks	U_B	Inc/R	Gear-i
X20	TTL incremental encoder, SSI encoder	-	H22	H23
BE	HTL incremental encoder	-	F36	F49
X41	TTL incremental encoder (no galv. isolation)	5 V	H41	H42

10.11.2 Parameterization - motor/ext. meas. system

The movement of the external measuring system (rotary or straight) must be defined with **I07** and **I08**. First, the increments of the encoder must be specified (for SSI encoder, the resolution is converted from bits to increments; 24 bits equal 1024 pulses). See table above. Then the physical implementation is defined with **I07** and **I08**.

Examples:

- 1) A revolving table with a rotation angle of 360° is directly coupled with a pulse encoder (1024 pulses per revolution).
H20 = 2:encoder In
H22 = 1024 I/R
I05 = 2:°
I07 = 360
I08 = 1 R
- 2) A conveyor belt with a 100-mm drive roller is combined with a pulse encoder (1024 pulses per rotation) which is mounted on the drive roller.
H20 = 2:Encoder In
H22 = 1024 I/R
I05 = 3:millimeter
I07 = 314 (100 mm * π) feed per roller revolution
I08 = 1 R
- 3) A linear axis with position encoder (100 pulses per 1 mm)
H20 = 2:encoder In
H22 = 100 I/R
I05 = 3:millimeter
I07 = 1
I08 = 1 R

H23: The ratio of the motor speed to the encoder speed must be entered in **H23** for speed precontrol. **H23** has no effect on the positioning but speed precontrol is very important for system dynamics.

Block circuit diagram:

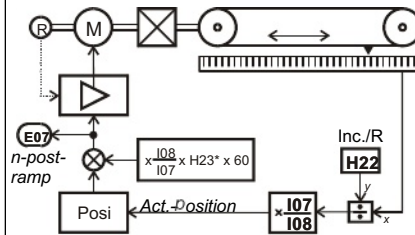

10.11.3 Special reactions with SSI encoders

The connection of the encoder is made on interface X20 (**H20=5**).

At a resolution of 24 or 25 bits (see **H61**), one revolution has 12 bits (i.e., one revolution is divided into 4096 positions). This corresponds to a resolution of a pulse encoder with 1024 lines (quadruple evaluation). **H20** must thus be set to 1024.

Be sure that the coding (gray or binary) is set correctly in **H62**.

11. Synchronous Running, El. Gearbox

10.12 Posi switching points

Posi switching points can be used to generate signals on the binary outputs during the movement. In contrast to the "electric cam" which is *always* active between positions **I60** and **I61**, *posi* switching points are only evaluated during the running process blocks (movement) in which they were activated (**L11**, **L12**).

There are 4 *posi* switching points - S1 to S4. Each of these switching points can be used in several process blocks. Up to two switching points can be selected in one process block.

Two switching points are selected for process block no. 1 with the parameters **L11** and **L12**, as shown below.

Parameter	Possible Selection Values
L11 Switch A	"0:inactive", "1:switch S1",
L12 Switch B	"...4:switch S4"

The characteristics of the switching points are specified in group **N...** . For instance, the first switching point (S1) is described with **N10** ... **N14**.

Parameter	Possible Selection Values
N10 s1-position	Example: 113.00 mm
N11 s1-method	"0:absolute", "1:rel.to start" or "2:rel.to end"
N12 s1-memory1	Selection for each: "0:inactive",
N13 s1-memory2	"1:set", "2:clear", "3:toggle"
N14 s1-memory3	

* Toggle = change state each time level changes (i.e., "L" -> "H" -> "L" -> "H" and so on)

Position of the switching point can be determined in the process block (**N10**, **N11**). The position of the switching point must be outside the target window **I22**.

The switching points have no direct effect on the outputs. Instead, up to 3 **switch memories** can be set, cleared or toggled in each switching point. Each binary output can be programmed to one of these three switch memories. **F80=20:s-memory2** outputs switch memory 2 to output BA1.

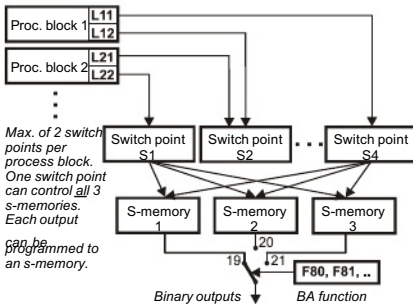

Example 1: Binary output 2 (relay 2) should be set in process block 2, 150 mm before the target position and then reset just before the Posi window is reached.

Solution: Two switch points (S1 and S2) are required. Switch point S1 activates switch memory 1 (s-memory1). Switch point S2 deactivates the same memory.

Switch Point S1	Switch Point S2
N10=150 mm	N20=5 mm
N11=2:rel.to endpos	N21=1:rel.to endpos
N12=1:set s-memory1	N22=2:clear s-memory1

Switching points S1 and S2 are assigned to process block 2 in group **L...** .

L21 = switch S1, **L22** = switch S2

Output BA2 is assigned to s-memory1 with **F00=19**.

Example 2: A binary output is to be turned on and off by the inverter with binary output BA1. Since the pistol's reactions are slow, it must be turned on (after the start of the process block) in advance at distance **a** and turned off at distance **b** before the end of the process block.

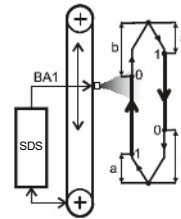

Solution: Two process blocks (position up, position down) and two switch points are required. The first switch point activates switch memory 1 ("s-memory1"). The second switch point deactivates the same memory.

Switch Point S1	Switch Point S2
N10=a (distance a)	N20=b (distance b)
N11=1:rel.to start	N21=2:rel.to endpos
N12=1:set s-memory1	N22=2:clear (s-memory1)

The same switching points are parameterized in both process blocks.

Process Block 1	Process Block 2
L11 = Switch point S1	L21 = Switch point S1
L12 = Switch point S2	L22 = Switch point S2

Output BA1 is assigned to *s-memory-1* with **F80=19**.

11 SYNCHRONOUS RUNNING, EL. GEARBOX

Using the synchronous running functionality, you can precisely synchronize two shafts. Different gear ratios are calculated without rounding errors. An incremental encoder of a master drive is used as the master, for example, but frequency/sign signals (i.e., stepper motor simulation) can also be processed.

11.1 Function overview

- Precise speed and angle ratio
- Gear ratio can be set as fraction.
- Following error monitoring
- Free wheeling via binary input
- No stationary angle error
- Angle offset via binary inputs
- Fine adjustment of the gear ratio possible via AE2
- Master signals as incremental encoder (tracks A and B) or stepper motor (frequency and sign)
- SSI as master encoder

The **block circuit diagram** for synchronous running is shown in chapter 18.

11. Synchronous Running, El. Gearbox

11.2 Connection of pulse source

The reference value can be received in the form of impulses in one of the following ways.

- Track A + B of an incremental encoder
- Direction + frequency (stepper motor simulation) or
- Serial data interface SSI

Pulse processing is performed by the "electronic gear" function (**G20** > 0) in mode **C60=1: speed**. The fast reference value must be **off** (**D99=0**).

Both HTL (24 V) and TTL (5 V differential) in accordance with RS 422) signals are processed.

HTL signals:

- Use BE1 and BE2 (X1.11 and X1.12).
- Set **F31=14**, **F32=15** for incremental encoder.
- Set **F31=15**, **F32=14** for stepper motor simulation.
- Enter resolution (pulses/revolution) in **F36**.
- Set master encoder **G27=0: BE encoder**. (Activate synchronous run with **G20** before.)

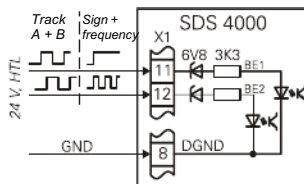

TTL signals:

- Use plug connector X20. Remember terminal resistance for cables longer than 1 m.
- Set **H20=2: encoder in** for incremental encoder.
- Set **H20=3: stepMot in** for stepper motor simulation.
- Enter resolution (pulses/revolution) in **H22**.
- Set master encoder **G27=1: X20**. (Activate synchronous run with **G20** before.)
- X41 can also be used instead of X20. See chap. 5.5.

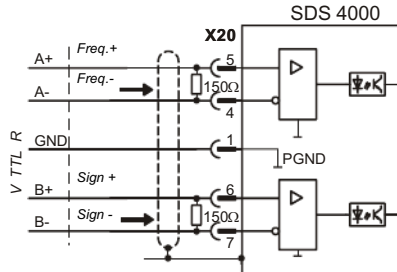

A finished, cascadeable master slave connection (ID no. 42940) can be used to pass the pulses from one SDS to the next. The cable length has been optimized for inverters up to 20 A (SDS 4141).

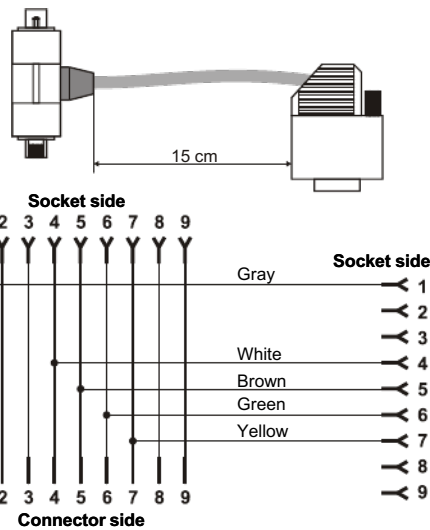

SSI interface:

- Use plug connector X20.
- Set **H20** to SSI master (**H20=5**).
- Set **H61** (SSI code) in accordance with encoder used.
- Set **H62** (data bits) in accordance with the resolution of the encoder.

The parameter **H60** (SSI-inverse) can be used to influence the direction of rotation.

11.3 Master - slave

When two SDS 4000 inverters are coupled as master-slave, signals of the encoder simulation on plug connector X20 are connected to the same plug connector of the next inverter.

Master:

- Set encoder simulation on X20 with **H20=1**.
- If necessary, change number of increments in **H21**.

Slave:

- Deactivate fast reference value with **D99=0**.
- Set **H20=2: encoder in**.
- Set the number of pulses/revolution in **H22** for the master (i.e., **H22** on slave = **H21** on master).
- Activate angle synchronous run with **G20=2**.
- Set master encoder to **G27=1: X20**.
- Set slave/master speed ratio in **G22/G21**.
- If necessary, change direction of revolution in **D92**.
- The primary functions are listed below.

Binary inputs (parameters **F31** to **F34**)

- **12: ext fault**;
- **17: tip +**; The slave is shifted in the positive direction in relation to the master. The speed is the result of the current speed reference value (AE1 or fixed reference value).
- **18: tip -**; Same as "17: tip +" but in the negative direction.
- **27: syncFreeRun**; Switch off synchronous running to run the drive with the analog reference value, for example.
- **28: syncReset**; Current synchronous difference **G29** is reset.

11. Synchronous Running, El. Gearbox

Binary outputs (parameters **F00** and **F80, F81**)

- **12:sync.diff.;** The synchronous difference exceeds limit value **G24**.

Analog inputs **AE2** (parameter **F20, F25**)

- **5:override.;** The gear ratio is affected during operation (i.e., change every 250 msec).
- **13:Sync.offset;** Slave position is changed via analog voltage (100% = **G38**).
- **14:Sync. n-RV;** External speed feed forward with analog reference value

11.4 Commissioning

- Commission master and slave separately (speed control). Parameters **F26, F36** and **H22** are important.
- Configure the encoder input/master on the slave (**F31=14** and **F32=15** or **H20=2**).
- On the slave, speed synchronous running is activated with **G20=1**, and the angle synchronous running is activated with **G20=2**.
- On the slave, enter the number of encoder increments of the master (**F36** or **H22**).
- On the slave, specify the speed ratio (**G22/G21**).
- Direction of rotation can be changed with **D92**.

The master often requires no further parameterization.

11.5 Angle difference

The current difference between master and slave is indicated in **G29**. The angle of difference is reset when:

- When voltage is turned on (power and 24 V) if **G20<3**
- Always for BE function "28:SyncReset"
- For enable, halt and quick stop. See **G25**.
- For BE function "27:SyncFreeRun." See **G25**.

The angle controller multiplies angle difference **G29** by **G23** (Kp.). The resulting speed offset is limited to $\pm G26$ (n-correction-Max).

A continuous angle shift between master and slave can be implemented with the BE functions *Tip +* and *Tip -*. The speed difference is the current speed reference value (i.e., analog input AE1 or the fixed reference value). Another way to shift the angle is the AE function "13:synchron-offset."

The **dynamic angle difference** during acceleration is reduced with **speed feed forward**.

- Usually, the master increments are differentiated and added as **speed feed forward** to the speed reference value.
Advantage: No extra wiring required
Disadvantage: The master must move first before the slave can react. The speed obtained by differentiation is smoothed with a low pass. ($T = G22/G21 * F36/H22 * 4$ msec if **G27=0:BE-encoder**. Otherwise $T = G22/G21 * H22/F36 * 4$ msec. In addition: $T \geq 16$ msec).
- The "14:Syncron reference value" function can be used to directly switch the speed reference value (post ramp) from the master to the analog input of the slave (**F20=14**). The function of the analog output **F40=11:E07 n-postRmp** can be used for this with the master. No ramp can be parameterized on the slave for the external precontrol (speed feed forward). If the analog reference value is circuited in parallel on master and slave, no ramps may be active on the master.

11.6 Angle and speed synchronous running

With *angle* synchronous running (**G20=2**), all angle deviations are acquired and adjusted. However, this is not always desired. In *speed* synchronous running mode (**G20=1**), the angle controller can be partially or completely deactivated.

The following setting is used to limit angle difference **G29** to the value **G24**.

G20=1: speed synchron run
G23>0 (Kp synchronous running)

Although the speed ratio is precisely adhered to, the slave never attempts to catch up with an angle difference over **G24**. This is similar to a mechanical safety notching coupling.

Make the following selection for pure speed synchronous running.

G24=0

The speed ratio is not mathematically precise.

11.7 Emergency off

The following measures are helpful in minimizing divergence of master and slave when the power goes off.

- Select master low voltage limit **A35** higher than that of the slave.
- Set master quick stop to **F38=2**.
- Couple DC links between master and slave.
- Adapt master quick stop ramp (**D81**) and torque limits (**C04**) on the master and slave to the mass ratios.

Turning off the power while the enable is active causes the fault "46:low voltage." After power returns, a device initialization is performed which may take several seconds.

⇒ We recommend removing the enable at the same time the power is removed so that the inverter does not go into "fault mode".

11.8 Reference point traversing - slave

Reference point traversing permits you to automatically put the slave into a defined initial position.

Reference point traversing is specified with parameters **G31** to **G35**. Reference point traversing is started with a binary input (function **F31=24:Start ref.**).

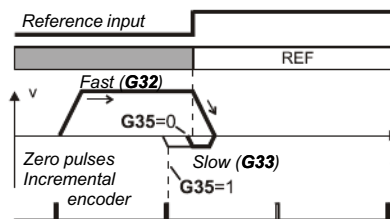

The drive moves at speed **G32** in direction **G31** until the reference switch (reference input) on a BE becomes active (function **F31=23:Ref.input**). The angle deviation is reset, and the drive halts.

If only one direction of revolution is permitted (**C02**), the drive moves in direction **C02** at speed **G33** until the *rising* edge of the reference switch. The reference direction (**G31**) is ignored in this case.

12. Technology

12 TECHNOLOGY

12.1 PID controller

The PID controller on analog input AE2 can be used as a technology controller for compensating rollers, pressure, throughput and similar. It is activated with **G00=1**.

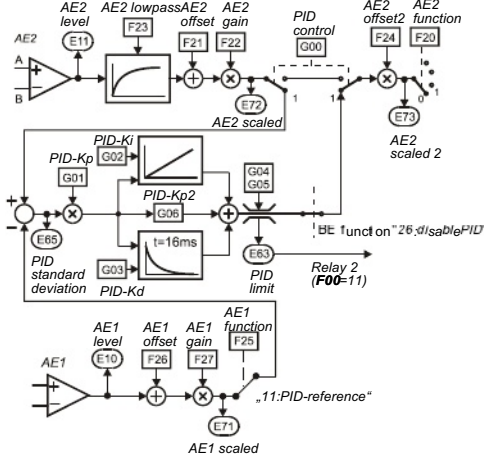

There are four ways to compare reference and actual values.

- Use of differential input AE2. The two signals are connected to "+" and "-" in relation to analog ground.
- A fixed reference value can be defined in **F21** (AE2 offset).
- AE1 can be programmed to **F25=11:PID-reference**.
- PID-reference via fieldbus (**E121**)

The low pass filter (smoothing, time constant **F23**) suppresses undesired high-frequency oscillations. The output of the PID controller is usually used as an additional reference value (**F20=1**). The binary input function "26:disable PID" (**F31** to **F35**) deactivates the controller. The controller output (i.e., adjustment variable) can be limited by **G04** and **G05**. Active limitation can be signaled on relay 2 (**F00=11**), for example. This can be used to indicate a malfunction in the process (e.g., tearing of wound material).

Important: Enable-off sets the output of the PID controller and the I portion to zero.

12.2 Winders

The standard inverter software contains functions for solving simple winding tasks (i.e., reel drives). The following tasks are supported.

Task	Diagram
1 Winding with diameter sensor at constant speed $v = \text{const}$	
2 Winding with indirect tension control at the M-max. limit	

Task	Diagram
3 Winding with compensating rollers via speed offset and PID controller on AE2	
4 Winding with direct tension control with tension sensor on AE2	

When a material is wound and unwound, the speed progresses in reverse proportion to the diameter ($n \sim 1/D$). If there is no diameter sensor (tasks 2 to 4), the diameter is calculated by the inverter as $D \sim v\text{-master} / n\text{-motor}$ (**G11=1**) or obtained by integration of the roller deviation (**G11=2**). The maximum change in speed of the diameter is provided by **G16**. The current diameter is indicated in parameter **G19** (actual winding diameter). This can be output on the monitor output with **F40=5**. Depending on the task, the winding drive uses the following modes.

- Speed-controlled, **G10=1:n mode** (tasks 1 + 3)
- At the M-max. limit, **G10=2:M-Max mode** (tasks 2 + 4)

12.2.1 Diameter sensor on AE1/AE2

Winders or unwinders with constant circumferential speed. The diameter sensor is connected to the analog input. The primary parameters are listed below.

- **F20=7:wind.diameter** (for AE1: **F25**)
- **G10=1:n mode**
- **G11=0:AE2-measured**
- **G12** winder D-Min., **G13** winder D-Max.

Parameters **F21** and **F22** are used to assign the values *D-Min.* and *D-Max.* to the related sensor voltages *U-Min.* and *U-Max.*

- **F21** = - *U-Min.* 40 V x 100% (AE2 offset)
- **F22** = 10 V ÷ (*U-Max.* - *U-Min.*) x 100% (AE2 gain)

Since the reference value decreases with increasing diameter in accordance with the reciprocal value 1/D, the master reference value is the highest possible speed with an empty roll.

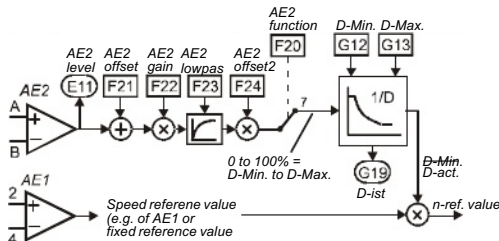

12. Technology

12.2.2 Indirect tension control at M-max limit

Winders or unwinders with constant tension without extra sensors. The winding speed is specified by a master drive. The **master reference value** must be such that it precisely corresponds to the motor speed required there for *D-Min.* (i.e., empty roll). The master reference value must always be **positive**. See **E10** (AE1 level). If necessary, the direction of motor revolution must be adjusted with **D92**. The winding drive calculates the diameter in accordance with $D \sim v\text{-master} \div n\text{-motor}$ and affects the torque limit in proportion to *D*. The torque limit on AE2 or **C03** is the greatest possible torque with a full roll. The primary parameters are listed below:

- **G10=2:M-Max mode**
- **G11=1:n-line/n-motor**
- **G12 Winding D-Min., G13 winding D-Max**
- **G14 Winding D-ini**
- **F20=2:torque-limit or C03**
- **D92** Reference value negation
- **G15** Override reference value

The speed reference value of a **winder** must always be greater than the master reference value so that the drive runs at the torque limit. This is ensured with the override reference value **G15** which is added to the master reference value. In contrast, an **unwinder** should never be allowed to start running automatically in the direction of unwinding. For this reason, the master reference value of AE1 is never provided unless it is positive. Override reference value **G15** ensures that the material is tensed when the master reference value = 0 (i.e., the unwinder

attempts to rotate slowly against the direction of winding). The direction of motor revolution can be adjusted with **D92** or via a binary input. Cf. **F31=6**. The following figure illustrates how this process functions.

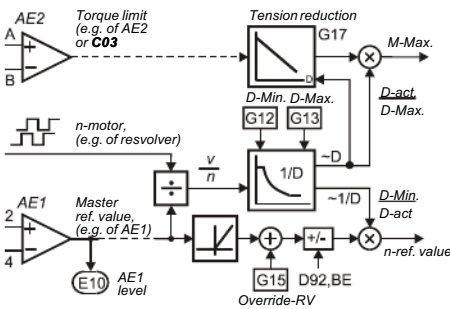

Before the winding process starts, the initial diameter must be set to **G14** via a binary input (e.g., **F31=29** for BE1). When the power is turned off, the current diameter (*D-act*) is saved in non-volatile memory. Incorrect calibration of the master reference value will cause *D-act* to drift away. If the master reference value is too high (e.g., due to **D02** being too high), *D-act* will also be too high! **G17** can be used to parameterize *tension reduction* with increasing diameter.

12.2.3 Winding with compensating roller

Winders or unwinders with constant tension provided by a compensating roller. The position of the compensating roller is measured and controlled via a PID controller on AE2. The winding speed is specified by a master drive. The winding drive

calculates the diameter in accordance with $D \sim v\text{-master} / n\text{-motor}$ and multiplies both the master reference value and the offset reference value by 1/*D*. The primary parameters are listed below.

- **G10=1:n mode**
- **G11=1:n-line/n-motor**
- **G12 Winding D-Min., G13 winding D-Max**
- **G14 Winding D-ini**
- **G00=1 (PID controller active)**
- **G01 PID controller Kp, G02 PID controller Ki**
- **F20=1:additional reference value**

Block circuit diagram:

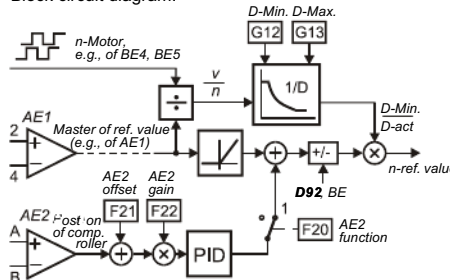

Instead of using **G11=1:n-line/n-motor** to calculate the diameter, **G11=2:roller** can also be used for a compensating roller. The deviation of the roller is measured with an analog input (**F20=12:wind.roller**). A speed feedback is not required.

Integration of the diameter is controlled by the positive or negative deviation of the roller.

12.2.4 Winding with tension sensor

Tasks similar to winding with compensating roller but with the following differences.

- **G10=2:M-Max mode**
- **F20=2: torque-limit**
- **G15** Override reference value

When winding with tension sensors, it is often a good idea to use an external PID controller with integration and precontrol (speed feed forward) of the tension reference value.

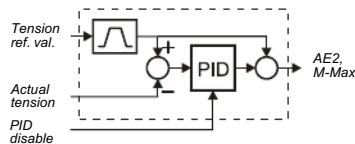

12.2.5 Compensation of fault variables



The effects of friction and inertia on the traction can be compensated for. The torque limit is offset by the friction used with **G40** and **G41**.



Compensation of inertia: The inertia torque of the full roll at *D-Max* must be converted to the motor shaft and entered in **C30** as a ratio of the inertia torque of the motor. The acceleration is obtained by differentiation of the encoder signal. The result can be smoothed with **G42**.

The variable diameter may also affect the gain of the speed controller. The gain between **C31*C35** at *D-Min* and **C31** at *D-Max* changes in proportion to the square of the diameter.

The *I* portion is affected in the same way.

13. Parameter Description

A.. Inverter		
Para. No.	Description	
A00 ¹⁾	Save parameter: 0: inactive; 1: The parameters of both parameter records are saved in non-volatile memory. Saving is triggered when the value changes from 0 to 1. " A02 check parameter " is then performed automatically.	
A01•	Read parabox & save: Read parameters from Controlbox and save in non-volatile memory. The inverter recognizes automatically what is connected to X3. With Controlbox : First select desired data record (1 to 7), and then press  . " A02 check parameter " is started automatically. When read errors occur (e.g., Parabox disconnected while being read accessed), all parameters are rejected, and the settings last saved with A00 are restored. 0: inactive; 1: active; <i>1 to 7 for Controlbox</i> (number of the data record)	
A02 ¹⁾	Check parameter: Parameterization is checked for correctness. For possible results, see chap. 15. 0: inactive; 1: active; Parameters of the parameter record to be edited (see A11) are checked for the following. - Adherence to the value range - Correct programming of the binary inputs (F31 to F35)	
A03 ¹⁾	Write to Parabox: Write data of the inverter to external data medium (Parabox, Controlbox) 0: inactive; 1 to 7; The parameters of both parameter records are copied from the inverter to Parabox (Controlbox). For handling, see A01 .	
A04• ¹⁾	Default settings: All parameters are reset to their default settings. 0: inactive; 1: active; The procedure is triggered when the value changes from 0 to 1.	
A10	Menu level: Specifies the parameters which can be accessed by the user 0: standard; Parameters which can be accessed are highlighted in gray in the parameter table (see chap. 21). All parameters remain in effect including those in the "1:extended" menu level. 1: extended; Access to all parameters which can be set 2: service; Access to rarely used service parameters. Small print (e.g., A37).	
A11	Parameter set edit: Specifies the parameter record to be edited. The parameter record to be edited (A11) and the active parameter record (status indication) do not have to be identical. For example, parameter record 1 can be edited while the inverter continues operation with parameter record 2. See also chapter 9.4. 1: parameter set 1; Parameter record 1 is edited. 2: parameter set 2; Parameter record 2 is edited.	
A12	Language: When the language is changed, FDS-Tool-specific texts U22, U32, U42 and U52 are reset to the default setting. This also applies to C53 and I09 . 0: deutsch; 1: english; 2: french;	
A13	Set password: Password is requested. If a password is defined in A14 , this must be entered here before parameters can be changed. See chapter 7.3.	
A14	Edit password: Definition and modification of the password. 0 means that no password has been set. All other values are valid passwords. See chapter 7.3. A defined password can only be read out via FDS Tool.	
A15	Auto-return: Permits automatic return from the menu to the status indication. In edit mode (i.e., the edited parameter is flashing), there is no automatic return to the status indication. 0: inactive; 1: active; If 50 seconds pass without a key being pressed, the display jumps back to the status indication.	
A20	Braking resistor type: Specification of the braking resistor type 19: inactive; Brake transistor deactivated. Too much braking force causes fault "36:overcurrent." 20: Internal; Integrated braking resistor. See page 2 of technical data. 21: User defined; Any external braking resistor. See A21, A22 and A23 . 22: 80Ohm0.3kW 23: 80Ohm0.6kW 24: 30Ohm0.6kW 25: 30Ohm1.0kW 26: 30Ohm1.2kW 27: 30Ohm2.5kW	A thermal model monitors the max. permissible power which can be led off via the braking resistor. This protects the braking resistor against thermal overload. A thermal overload causes the fault "42:tempBrakeRes."
A21	Brake resistor resist.: Only with A20=1 (user defined), resistance value of the braking resistor used. <i>Value range in Ω:</i> Depends on type, up to 600	

• The power pack must be turned off before these parameters can be changed.
Italics These parameters are sometimes not shown depending on which parameters are set.
 1) See result table in chap 15. 2) Only available when **D90=1** 3) Only available when **D99=0**
 Parameters which are included in the *normal* menu scope (**A10=0**). For other parameters, select **A10=1:extended** or **A10=2:service**.
 Parameters marked with a "√" can be parameterized separately from each other in parameter record 1 and 2.

13. Parameter Description

A.. Inverter		E
Para. No.	Description	
A22	Braking resistor rating: Only with A20=1 (user defined), capacity of the braking resistor used. <i>Value range in kW: 0 to depends on type</i>	
A23	Braking resistor therm.: Only with A20=1 (user defined), thermal time constant of the braking resistor. <i>Value range in sec: 0.1 to 40 to 100</i>	
A30•	Operation input: Specifies the srcin of the control signals (i.e., enable, direction of rotation and ref. value) <i>0: control interface (X1); Control signals (e.g., enable and so on) are generated via the X1 terminals. All binary inputs must be programmed accordingly. Fieldbus operation without Drivecom profile.</i> <i>1: serial (X3); Control signals (e.g., enable and so on) are generated from the PC (FDS Tool software). The inverter is connected to the PC via sub D plug connector X3 (RS 232-C interface). See chapter 9.9. Remote control via the PC requires that the enable input (X1.15) be high.</i> <i>2: inactive;</i> <i>3: SDP 4000; Control of the device via PROFIBUS-DP. This requires the PROFIBUS-DP option board.</i> <i>4: CAN-bus; Control of the device via CANopen with the integrated CAN bus interface which is standard.</i> The following applies to both settings (i.e., "3: Profibus-DP" and "4: CAN-bus"). The servo inverter is put into a drive-compatible mode for device control. This control is performed exclusively either via the selected fieldbus (requires that all parameters for the function of the binary and analog inputs F20, F31, F32, F33 and so on be set to inactive) or in mixed operation with these inputs. The high level must always be present on the enable input (X1.15).	
A31	Esc-reset: Use the Esc key to acknowledge faults while they are being indicated. <i>0: inactive;</i> <i>1: active; Faults can be acknowledged with Esc.</i>	
A32	Auto-reset: Faults which occur are acknowledged automatically. <i>0: inactive;</i> <i>1: active;</i> The inverter acknowledges some faults automatically. See chapter 17. Faults can be automatically acknowledged successfully three times within a time period of 15 minutes (default setting). A fourth fault is not acknowledged automatically. Instead, relay 1 opens, and the fault must be acknowledged in some other way (i.e., enable, binary input F31 to F35=13 , or Esc key A31). The automatic acknowledgment counter is reset. After three unsuccessful attempts at acknowledgment, the inverter ignores automatic acknowledgment and	
A33	Time limit reset: The period of automatic acknowledgment is parameterized from 1 to 255 min in A33 . <i>Value range in min: 1 to 15 to 255</i>	
A34	Auto-start: Before you activate auto-start A34=1 , check to determine whether safety requirements permit an automatic restart. Use only permitted when the standards or regulations pertaining to the system or machine are adhered to. <i>0: inactive; After power-on, the enable must change from L level to H level to enable the drive (→ message "12:inhibited"). This prevents the motor from starting up unintentionally (i.e., machine safety).</i> <i>1: active; When auto-start is active, the drive can start running immediately (if enabled) after the power is turned on.</i>	
A35	Low voltage limit: If the inverter is enabled and the DC-link voltage is less than the value set here, the inverter assumes fault "46:low voltage." A35 should usually be approx. 85% of the power voltage present to offset possible failure of a power phase. <i>Value range in V: 150 to 350 to 570</i>	
A36	Mains voltage: Maximum voltage provided to the motor by the inverter. Usually the power voltage. Starting at this voltage, the motor runs in the field weakening range. <i>Value range in V: 140 to 400 to 480</i>	
A37	Reset memorized values: The six different following error counters E33 to E38 (e.g., maximum current, maximum temperature and so on) are reset.	
A38	DC power-input: <i>0: inactive;</i> <i>1: active;</i>	
A40• ¹⁾	Read parabox: Read parameters from a Controlbox <i>without</i> automatic storage. <i>0: inactive;</i> <i>1 to 13: active; For function, cf. A01.</i>	
A41	Select parameter set: Two parameter records are available. These can be selected via the binary inputs or directly via A41 . The selected parameter record does not become active until the enable has been removed and after a maximum of 300 msec have passed. Some parameters retain their validity in both parameter record 1 and parameter record 2 (e.g., the posi. parameters in I, J and L). Parameters which can be programmed separately in parameter record 2 are indicated by a E between the coordinate and parameter name. See chap. 7.1.	

* The power pack must be turned off before these parameters can be changed.

Italics These parameters are sometimes not shown depending on which parameters are set.

1) See result table in chap 15.

2) Only available when **D90≠1**

3) Only available when **D99=0**

E Parameters which are included in the *normal* menu scope (**A10=0**). For other parameters, select **A10=1:extended** or **A10=2:service**.

Parameters marked with a "E" can be parameterized separately from each other in parameter record 1 and 2.

13. Parameter Description

B.. Motor		
Para. No.	Description	
B00•	Motor-type: Motor selection from the motor data base. The STÖBER system motor used is specified with B00 =61 to 69. B00 =60 (user defined) is used for special windings or motors of other manufacturers. 60: user defined 62: ES 33 64: ES 44 66: ES 54 68: ES 74 61: ES 32 63: ES 42 65: ES 52 67: ES 72 69: ES 76 The EMC voltage constant must be entered in B02 . An "*" on the display means that at least one of the parameters (B53 , B64 and B65) differs from the default setting of the STÖBER motor data base.	√
B02	EMC-constant: Specifies the peak value of inducted voltage between two phases at 1000 rpm. Value range in V: 5 to 110 to 3000	√
B03	Motor fan: Only if B00 > 60 (STÖBER motors). The thermally permissible motor torque is increased (if model of the motor). B03 =1 thus also increases the torque limits since M-Max limits C03 and C04 are specified relative to motor standstill torque M0. To prevent overloading a gearbox after installing a motor fan retroactively, C03/C04 must be adjusted to the new M0. See catalog or name plate. 0: inactive; 1: active;	√
B10•	Poles: Calculated from the nominal speed of the motor $p=2 \times (f \times 60/n_{Nom})$. Internally, the controller works with frequencies. Correct speed indication requires entry of the number of poles. Value range: 2 to 6 to 16	√
B11•	P-nominal: Nominal power as per nameplate Value range in kW: 0.12 to (depends on type)	√
B12	I-nominal: Nominal current as per nameplate. Value range in A: 0 to (depends on type)	√
B13	n-nominal: Nominal speed as per nameplate Value range in rpm: 0 to depends on type to 6000	√
B17	M0 (standstill): Standstill torque M0 as shown on name plate. Reference value for M-max limits C03 and C04 . Value range in Nm: 0 to (depends on type) to 327.67	√
B26•	Motor-encoder: B26 specifies which encoder input will be used for motor control. The encoder increments are specified with F36 or H22 . Regardless of B26 , the master encoder is set for synchronous operation (G20 =1) with G27 and the BOSI-encoder (C60 =2) is set with I02 . 2: resolver (X40), Standard for STÖBER ES motors 3: X41 (SinCos); Single and multi-turn, absolute-value encoders with sin/cos track	√
B40• ¹⁾	Phase test: 0: inactive; 1: active; Tests motor symmetry in increments of 60°. The following points are checked. - Connection of phases U, V and W - Motor and resolver pole number - Phase position of resolver or sin/cos encoder - Symmetry of the winding resistors of the phases U, V and W. If a winding resistor deviates by ±10%, the inverter reports "19:symmetry." The function is started when the level on the input enable (X1.9) changes from low to high. Exiting the parameter requires another low signal on the enable.	
B41• ¹⁾	Autotuning: 0: inactive; 1: active; Winding resistors of the motor are measured. The function is started when the level on the input enable (X1.9) changes from low to high. Exiting the parameter requires another low signal on the enable. A00 =1 saves the measuring results in non-volatile memory. B00 =60, autotuning of the motor is essential! Important for optimum coordination between inverter and motor. B00 =61 to 69, autotuning of the motor is not required.	
B52	L-motor: Inductivity Lu-v of the motor winding. Only enter for motors of other manufacturers. Value range in mH: 0.01 to depend on type to 327.67	√
B53	R1-motor: Stator resistance (Ru-v) of the motor winding. Only entered for non STÖBER motors. Value range in Ω: 0.01 to depends on type to 327.67	√
B64	Ki-IQ (torque) Integral gain of the torque controller. Value range in %: 0 to depends on type to 400	√
B65	Kp-IQ (torque) Proportional gain of the torque controller. Value range in %: 0 to depends on type to 400	√

* The power pack must be turned off before these parameters can be changed.
Italics These parameters are sometimes not shown depending on which parameters are set.
 1) See result table in chap 15. 2) Only available when **D90**≠1 3) Only available when **D99**=0
 Parameters which are included in the normal menu scope (**A10**=0). For other parameters, select **A10**=1:extended or **A10**=2:service.
 Parameters marked with a "*" can be parameterized separately from each other in parameter record 1 and 2.

13. Parameter Description

C.. Machine		
Para. No.	Description	
C00	n-Min: Only if C60 ≠2 (run mode≠position). Minimum permissible speed. The speed refers to the motor shaft speed. Reference values less than n-Min are ignored and raised to n-Min. <i>Value range in rpm: 0 to C01</i>	√
C01	n-Max: Maximum permissible speed. The speed refers to the motor shaft speed. Reference values over n-Max are ignored and limited to n-Max. <i>Value range in rpm: C00 to 3000 to 6000</i>	√
C02*	Permitted. direction of rotat.: Only if C60 ≠2 (run mode≠position). Determines the permissible direction of rotation. The direction of rotation can be specified via the binary inputs. <i>The direction of rotation:</i> <i>1: clockwise;</i> <i>2: counter-clockwise;</i>	√
C03	M-Max 1: Maximum torque in % of motor zero current. The active torque limit can be further reduced with an analog input (see F25 =2). If the maximum torque is exceeded, the controller responds with the message "47:drive overload". See also remarks for C04 . <i>Value range in %: 0 to 150 to 400 (and any M-Max signal present on analog input-AE function "2:Torque limit")</i>	√
C04	M-Max 2: Additional torque limit. You can switch between C03 and C04 with a binary input (F3..= 10:torque select). See chap. 9.2. Remarks: Since C04 is always active for a quick stop , C04 ≥ C03 should usually apply! <i>Value range in %: 0 to 150 to 400</i>	√
C30	J-mach/J-motor: Ratio of the inertia of load to motor. This factor is effective for all control modes and is important for optimization between inverter and motor (i.e., dynamics). Entry is not mandatory. Remarks: In winding mode, the effective inertia torque is calculated for C30 ≥ 1.5 to the fourth power with the winding diameter for compensation of the acceleration torque. The following applies: J(D-Min) = 1.5 * J-motor, J (D-Max) = C30 * J-motor. The torque supplied by the drive is increased so that tension remains constant and extra torque is available for acceleration. <i>Value range: 0 to 1000</i>	√
C31	n-controller Kp: Proportional gain of the speed controller. Remarks: In winding mode (G10 >0), the Kp gain with the winding diameter is quadratically reduced from C31 for D-Max down to C31 * C35 for D-Min. <i>Value range in %: 0 to 60 to 400</i>	√
C32	n-controller Ki: Integral gain of the speed controller. Reduce C32 when overshwinging occurs in the target position. Remarks: In winding mode (G10 >0), the Ki gain with the winding diameter is quadratically reduced from C32 * C31 for D-Max down to C32 * C31 * C35 for D-Min. <i>Value range in %: 0 to 30 to 400</i>	√
C33	n-RefVal low pass: Reference value smoothing. C33 should be increased for reference value noise, physical oscillation or large foreign masses. <i>Value range in msec: 0 to 2 to 3276.7</i>	√
C34	n-motor low pass: Smoothing of the motor speed. <i>Value range in msec: 0.3 to (depends on type) to 3276.7</i>	√
C35	n-control. Kp standstill: Without winders: C31 and C32 are multiplied by C35 as soon as the motor speed drops below C40 . With winders: The formulas described under C31 and C32 apply. <i>Value range in %: 5 to 100</i>	√
C40	n-window: If F00 =3 (BA 2 as signal relay for "3:reference value-reached") or F00 =2 (BA 2 as signal contact for speed "2:standstill"), the reference value is considered achieved in a window of reference value ± C40 . Also applies to the other binary inputs. A halting brake is not activated as long as [n] > C40 . <i>Value range in rpm: 0 to 3 to 300</i>	√
C41	Operating range n-Min: Parameters C41 to C46 can be used to specify an operating area. An output (F00 =6) can be used to signal that these values have been exceeded. All area monitoring procedures are performed at the same time. If area monitoring is not required, the minimum parameters must be set to the lower-limit values, and the maximum parameters must be set to the upper-limit values. Cf. chapter 9.3. When C49 =0, operating-range monitoring is suppressed when the motor is not powered and during acceleration/braking procedures. When C48 =1, amount generation is activated. <i>Value range in rpm: 0 to C42</i>	√
C42	Operating range n-Max: See C41 . <i>Value range in rpm: C41 to 6000</i>	√

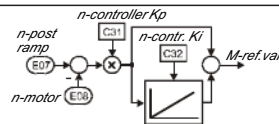

* The power pack must be turned off before these parameters can be changed.
Italics These parameters are sometimes not shown depending on which parameters are set.
 1) See result table in chap 15. 2) Only available when **D90**≠1 3) Only available when **D99**=0
 Parameters which are included in the *normal* menu scope (**A10**=0). For other parameters, select **A10**=1:extended or **A10**=2:service.
 Parameters marked with a "√" can be parameterized separately from each other in parameter record 1 and 2.

13. Parameter Description

C.. Machine		E
Para. No.	Description	
C43	Operating range M-Min: See C41 . Value range in %: 0 to C44	√
C44	Operating range M-Max: See C41 . Value range in %: C43 to 400	√
C45	Operating range X-Min.: See C41 . Monitors range defined in C47 . Value range in %: -400 to 0 to C46	√
C46	Operating range X-Max.: See C41 . Monitors range defined in C47 . Value range in %: C45 to 400	√
C47	Operating range C45/C46: Defines the range to be monitored. 0: E01 P-motor; 5: E22 i2t-device; 10: E71 AE1-scaled; 1: E02 M-motor; 6: E23 i2t-motor; 11: E72 AE2-scaled; 2: E10 AE1-level; 7: E24 i2t-braking resistor; 12: E73 AE2-scaled 2; 3: E11 AE2-level; 8: E62 actual M-Max; 13: inactive 4: E16 analog-output1-level; 9: E65 PID-error; 14: E08 n-motor; (% ref. to C01)	√
C48	Operating range of amount C47: 0: absolute; First, the amount is generated from the signal selected in C47 . Example: C47 =AE2; C45 =30%; C46 =80%. The operating range is -80% to -30% and +30% to +80%. 1: range; The signal selected in C47 must be located in range C45 to C46 . Example: C47 =AE2, C45 = -30%, C46 = +10%. The operating range is -30% to +10%.	√
C49	Operating range accel&ena: 0: inactive; During acceleration or deactivated enable, the "operating range" signal for the binary outputs is set to "0"=ok. The three ranges are only monitored during stationary operation (compatible with device software V 4.4). 1: active; The operating range is always monitored.	√
C50	Display function: Only if C60 ≠2 (operating mode≠position). Parameters C50 to C53 can be used to design the first line of the display as desired. See chapter 6.1. Eight characters are available for a number, and 8 characters are available for any unit. Display value = raw value/display factor. 0: n2 & l-motor; 1: E00 l-motor; The inverter supplies the actual motor current in amperes as the raw value. 2: E01 P-motor; The inverter supplies as the raw value the actual active power as a percentage of the nominal motor power. 3: E02 M-motor; As the raw value, the inverter supplies the actual motor torque as a percentage of the nominal motor torque. 4: E08 n-motor; The inverter supplies the actual speed in rpm as the raw value.	√
C51	Display factor: Only if C60 ≠2. Raw value (C50) is divided by the value entered here. Value range: -1000 to 1 to 1000	√
C52	Display decimals: Only if C60 ≠2. Number of positions after the decimal point for the value in the display. Value range: 0 to 5	√
C53	Display text: Only if C60 ≠2 (operating mode≠position) and C50 >0. Text for customer-specific unit of measure in the operating display (e.g., "units/hour"). Maximum of 8 positions. Can only be entered with FDS Tool.	√
C60	Run mode 0: torque; Specification of a bipolar torque reference value. Reference value processing on AE1 at 1 msec. 1: speed; Speed reference value, conventional operating mode 2: position; Position control activated. When enable signal on X1.9, the position controller is turned on, and the current position is maintained. If C60 =2, group "D.. reference value") is not shown at all. When the mode is switched from speed to position, the reference position is lost. 3: position extern;	√
D.. Reference Value		E
Group D is not shown in run mode C60 =2:position.		
Para. No.	Description	
D00	Reference value accel: Acceleration ramp for analog reference value inputs. Is only used for specification of reference value via terminal strip X1 and motor potentiometer. – Voltage, current via analog input 1 (X1.2 to 4) – Frequency via binary input BE5 (X1.8 to 14) – Motor potentiometer via the binary inputs (D90 =1) Value range in msec/3000 rpm: 0 to 30000	√

* The power pack must be turned off before these parameters can be changed.
Italics These parameters are sometimes not shown depending on which parameters are set.
 1) See result table in chap 15. 2) Only available when **D90**≠1 3) Only available when **D99**=0
 Parameters which are included in the *normal* menu scope (**A10**=0). For other parameters, select **A10**=1:extended or **A10**=2:service.
 Parameters marked with a "√" can be parameterized separately from each other in parameter record 1 and 2.

13. Parameter Description

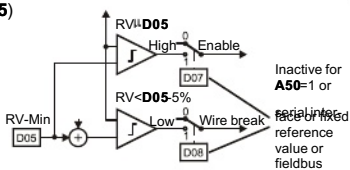
D.. Reference Value		Group D is not shown in run mode C60=2:position.	
Para. No.	Description		
D01	Reference value decel: Deceleration ramp for analog reference value inputs. Is only used for specification of reference value via terminal strip X1 and motor potentiometer. – Voltage, current via analog input 1 (X1.2 to 4) – Frequency via binary input BE5 (X1.8 to 14) – Motor potentiometer via the binary inputs (D90=1) <i>Value range in msec/3000 rpm: 0 to 30000</i>		√
D02 ²⁾	Speed (max. ref. value): Parameters D02 to D05 can be used to specify as desired the relationship between D02 speed reference value and speed with a reference value (D02) characteristic curve. <i>Value range in rpm: 0 to 3000 to 6000</i>		√
D03 ^{2;3)}	Reference value-Max.: Reference value to which the speed (max. RV - D02) is assigned. Percentage of the analog reference value (10 V = 100%) at which the maximum speed (D02) is achieved. <i>Value range in %: D05 to 100</i>		√
D04 ^{2;3)}	n speed (min. ref. value): Speed achieved with minimum reference value (D05). <i>Value range in rpm: 0 to 6000</i>		√
D05 ^{2;3)}	Reference value-Min.: Reference value to which the speed (min. RV - D04) is assigned. Percentage of the analog reference value (10 V = 100%) at which the minimum speed (D04) is achieved. <i>Value range in %: 0 to D03</i>		√
D06 ^{2;3)}	Reference value offset: Corrects an offset on analog input 1 (X1.2 to 4). When the ref. value is 0, the motor may not be permitted to rotate. If a revolution occurs anyway, this value must be entered with reversed sign as the offset (e.g., if param. E10 shows 1.3%, D06 must be parameterized to -1.3%). The value range is ±100%. While the ref. value offset is being entered, the current value of the analog input is shown at the same time. <i>Value range in %: -100 to 0 to 100</i>		√
D07 ^{2;3)}	Reference value enable: When the minimum reference value (D05) is set to a value greater than 1%, an enable can be derived from the reference value output. <i>Q: inactive;</i> <i>1: active;</i> An additional enable is derived from the reference value on analog input 1. If the reference value enable is high, the output is greater than or equal to the minimum reference value (D05). If the reference value enable is low, the output is less than the minimum reference value (D05). 		√
D08 ^{2;3)}	Monitor reference value. Monitors reference value output. Monitors for wire break. Ref. value monitoring will only function if the minimum reference value specified in D05 is greater than or equal to 5% (D05 ≥ 5%). <i>Q: inactive;</i> <i>1: active;</i> If the reference value output is 5% less than the minimum permissible reference value (D05), the inverter shows "43:RV wire brk."		√
D09 ^{2;3)}	Fix reference value no.: Selection of a fixed reference value <i>Q: external selection via binary inputs and BE functions RV-select 0 to 2</i> <i>1 to 7: fixed selection of fixed reference value. BE inputs are ignored.</i>		√
D10 ^{2;3)}	Accel 1: Up to 7 fixed reference values/ramp records can be defined per parameter record. Selection is made via the binary inputs. At least one binary input must be programmed to reference value selector (e.g., F31=1:RV-select0). The reference value selector is used to assign the fixed reference values or ramp records to the signals of the binary inputs. The result of the binary coding is shown in E60 (0 to 7). The ramp records (accel 1 to 7 / decel 1 to 7) are only active in connection with the assigned fixed reference values 1 to 7. Accel 1: Acceleration time for ramp record 1 as related to 150 Hz. <i>Value range in msec/3000 rpm: 0 to 60 to 30000</i>		√
D11 ^{2;3)}	Decel 1: Deceleration time for ramp record 1 as related to 150 Hz. <i>Value range in msec/3000 rpm: 0 to 60 to 30000</i>		√
D12 ^{2;3)}	Fix reference value 1: Selection is made parallel to ramp record 1 (accel 1 / decel 1) via the binary inputs. <i>Value range in rpm: -6000 to 750 to 6000</i>		√
D20 ^{2;3)}	Accel 2: Acceleration time for ramp rec. 2 as related to 150 Hz. <i>Value range in msec/3000 rpm: 0 to 90 to 30000</i>		√

No.	Accel	Decel	Reference Value
0	D00	D01	Analog, freq,...
1	D10	D11	Fixed RV 1
2	D20	D21	Fixed RV 2
:	:	:	:
7	D70	D71	Fixed RV 7

• The power pack must be turned off before these parameters can be changed.
Italics These parameters are sometimes not shown depending on which parameters are set.
 1) See result table in chap 15. 2) Only available when **D90**≠1 3) Only available when **D99**=0
 Parameters which are included in the normal menu scope (**A10**=0). For other parameters, select **A10**=1:extended or **A10**=2:service.
 Parameters marked with a "√" can be parameterized separately from each other in parameter record 1 and 2.

13. Parameter Description

D.. Reference Value		Group D is not shown in run mode C60=2:position.																
Para. No.	Description																	
D21 ^{2;3)}	Decel 2: Deceleration time for ramp rec. 2 as related to 150 Hz. Value range in msec/3000 rpm: 0 to <u>90</u> to 30000		√															
D22 ^{2;3)}	Fix reference value 2: Selection is made parallel to ramp rec. 2 (accel 2/decel 2) via the binary inputs. Value range in rpm: -6000 to <u>1500</u> to 6000		√															
D30 ^{2;3)}	Accel 3: Acceleration time for ramp rec. 3 as related to 150 Hz. Value range in msec/3000 rpm: 0 to <u>120</u> to 30000		√															
D31 ^{2;3)}	Decel 3: Deceleration time for ramp rec. 3 as related to 150 Hz. Value range in msec/3000 rpm: 0 to <u>120</u> to 30000		√															
D32 ^{2;3)}	Fix reference value 3: See D12 . Value range in rpm: -6000 to <u>3000</u> to 6000		√															
D40 ^{2;3)}	Accel 4: Acceleration time for ramp record 4 as related to 150 Hz. Value range in msec/3000 rpm: 0 to <u>5</u> to 30000		√															
D41 ^{2;3)}	Decel 4: Deceleration time for ramp record 4 as related to 150 Hz. Value range in msec/3000 rpm: 0 to <u>5</u> to 30000		√															
D42 ^{2;3)}	Fix reference value 4: See D12 . Value range in rpm: -6000 to <u>500</u> to 6000		√															
D50 ^{2;3)}	Accel 5: Acceleration time for ramp record 5 as related to 150 Hz. Value range in msec/3000 rpm: 0 to <u>10</u> to 30000		√															
D51 ^{2;3)}	Decel 5: Deceleration time for ramp record 5 as related to 150 Hz. Value range in msec/3000 rpm: 0 to <u>10</u> to 30000		√															
D52 ^{2;3)}	Fix reference value 5: See D12 . Value range in rpm: -6000 to <u>1000</u> to 6000		√															
D60 ^{2;3)}	Accel 6: Acceleration time for ramp record 6 as related to 150 Hz. Value range in msec/3000 rpm: 0 to <u>20</u> to 30000		√															
D61 ^{2;3)}	Decel 6: Deceleration time for ramp record 6 as related to 150 Hz. Value range in msec/3000 rpm: 0 to <u>20</u> to 30000		√															
D62 ^{2;3)}	Fix reference value 6: See D12 . Value range in rpm: -6000 to <u>2000</u> to 6000		√															
D70 ^{2;3)}	Accel 7: Acceleration time for ramp record 7 as related to 150 Hz. Value range in msec/3000 rpm: 0 to <u>25</u> to 30000		√															
D71 ^{2;3)}	Decel 7: Deceleration time for ramp record 7 as related to 150 Hz. Value range in msec/3000 rpm: 0 to <u>25</u> to 30000		√															
D72 ^{2;3)}	Fix reference value 7: See D12 . Value range in rpm: -6000 to <u>2500</u> to 6000		√															
D81	Decel-quick: Quick stop ramp. Effective if a binary input is programmed to quick stop (F3..=9) or parameter F38>0 . When a quick stop is triggered by the binary inputs, the drive is decelerated with the deceleration ramp set here. In position mode (C60=2), quick stop is performed on ramp I11 . Value range in msec/3000 rpm: 0 to <u>2</u> to 30000		√															
D90 ³⁾	Reference value source: See block circuit diagram in chap. 19. 0: standard reference value 1: motor potentiometer Two binary inputs can be used to simulate a "motor potentiometer." This requires that one binary input be programmed to "4: motorpoti up" and another binary input to "5: motorpoti down" (e.g., F33=4 and F34=5). Only ramps D00 and D01 can change the speed. 2: motor potentiometer+reference value ref. value for speed of the motor potentiometer function is added to the "standard" ref. value (i.e., analog input, fixed reference values). When D90=1 , only the motor potentiometer ref. value is used. The ramps selected with the binary inputs are used, and the motor potentiometer ref. value changes with RV-accel/RV-decel (i.e., D00 and D01).	<table border="1"> <thead> <tr> <th>BE3</th> <th>BE4</th> <th>Motor Poti RV</th> </tr> </thead> <tbody> <tr> <td>L</td> <td>L</td> <td>Constant</td> </tr> <tr> <td>H</td> <td>L</td> <td>Larger</td> </tr> <tr> <td>L</td> <td>H</td> <td>Smaller</td> </tr> <tr> <td>H</td> <td>H</td> <td>0</td> </tr> </tbody> </table>	BE3	BE4	Motor Poti RV	L	L	Constant	H	L	Larger	L	H	Smaller	H	H	0	√
BE3	BE4	Motor Poti RV																
L	L	Constant																
H	L	Larger																
L	H	Smaller																
H	H	0																
D91 ³⁾	Motorpoti function: Only if D90≠0 (reference value source ≠ standard RV) <i>0: non-volatile;</i> The reference value which was approached is retained both when the enable is removed and when the power is turned off/on. <i>1: volatile;</i> The reference value is set to 0 when the enable becomes low or the power for the drive is turned off.		√															
D92	Negate reference value: See block circuit diagram in chap. 19. <i>0: inactive;</i> <i>1: active;</i> The reference value channel is negated. Corresponds to a reverse in direction of rotation. Not related to the selected reference value.		√															

* The power pack must be turned off before these parameters can be changed.
Italics These parameters are sometimes not shown depending on which parameters are set.
 1) See result table in chap 15. 2) Only available when **D90=1** 3) Only available when **D99=0**
 Parameters which are included in the *normal* menu scope (**A10=0**). For other parameters, select **A10=1:extended** or **A10=2:service**.
 Parameters marked with a "√" can be parameterized separately from each other in parameter record 1 and 2.

13. Parameter Description

E.. Display Values		
<i>Para. No.</i>	<i>Description</i>	
E26	Binary output 1: Only present when an option board exists (E54 =1 or 2).	
E27	BA15..1&Rel1: Status of all binary outputs as binary word. BA15 to BA1 are indicated from left to right. Relay 1 is indicated to the far right.	
E28	Analog-output-level: See E16 .	
E29	n-ref. value raw: Speed reference value before the offset reference values and the reference value limitation. This is the master reference value for the winder and the free-wheeling reference value for synchronous	
E30	Run time: Indicates the current run time. Run time means that the inverter is connected to the power supply.	
E31	Enable time: Indicates the active time. Active time means that the motor is powered.	
E32	Energy counter: Indicates the total power consumption in kWh.	
E33	Vi-max-memorized value: The DC-link voltage is monitored continuously. The largest value measured is saved here in non-volatile memory. This value can be reset with A37 →1.	
E34	I-max-memorized value: The motor current is continuously monitored. The largest value measured is stored here in non-volatile memory. This value can be reset with A37 →1.	
E35	Tmin-memorized value: The temperature of the inverter is continuously monitored. The smallest value measured is stored here in non-volatile memory. This value can be reset with A37 →1.	
E36	Tmax-memorized value: The temperature of the inverter is continuously monitored. The greatest value measured is stored here in non-volatile memory. This value can be reset with A37 →1.	
E37	Pmin-memorized value: The active power of the drive is continuously monitored. The smallest value measured is stored here in non-volatile memory. This value can be reset with A37 →1.	
E38	Pmax-memorized value: The active power of the drive is continuously monitored. The largest value measured is stored here in non-volatile memory. This value can be reset with A37 →1.	
E40	Fault type: This parameter allows you to make a selection from archived faults. The inverter stores the last 10 faults in the order in which they occurred. The number of the fault is indicated at the top right. 1 indicates the latest fault, and 10 indicates the oldest fault. The type of fault is shown in plain text in the bottom line. Proceed as follows to select which of the 10 faults will be indicated. Press the key. The number (1 to 10) of the indicated fault flashes in the top line. The type of fault is indicated in plain text in the bottom line (e.g., "31:short/ground"). The arrow keys can then be used to select the desired fault number.	
E41	Fault time: The run time at the time of the selected fault is indicated. Selection is the same as for E40 .	
E42	Fault count: Number of faults of the type of fault selected. Proceed as follows to select the type of fault. Press the key. A fault code and the fault appear in plain text (e.g., "31:short/ground") in the bottom line. The arrow keys can then be used to select the desired type of fault. The number of faults of this event is shown in the top line (0 to 65,535).	
E45	Control word: Control of <i>Drivocom</i> device state machine during fieldbus operation with Kommubox.	
E46	Status word: Status of the device during fieldbus operation with Kommubox. See fieldbus documentation.	
E47	n-field-bus: Reference value speed during fieldbus operation with Kommubox.	
E50	Device: Indication of the exact device type (e.g., SDS 4041).	
E51	Software-version: Software version of the inverter (e.g., V4.5).	
E52	Device-number: Number of the device from a manufactured series. Same as the number on the nameplate.	
E53	Variant-number	
E54	Option-board: Indication of the option board detected during initialization. 10: none; 11: SDP 4000 12: SEA 4000 13: SEA + DP 4000	
E55	Identity-number: Number assigned by the user as desired from 0 to 65535. Can only be write-accessed with FDS Tool or fieldbus.	
E56	Parameter set ident. 1: Indicates whether parameters in parameter record 1 were changed. Can be set by "E40 phase test" and "J04 Tech-in" are executed. 0: All values are default settings (A04 =1). 1: Specified value during initialization by FDS Tool. 2 to 253: Customer specification/configuration with FDS Tool. Status without change. 253: When parameters are changed via fieldbus or via the USS protocol, E56 and E57 = 254 are set. 254: At least one parameter value was changed with the keyboard (Controlbox or device)!	
E57	Parameter set ident. 2: Same as E56 but for parameter set 2.	

- The power pack must be turned off before these parameters can be changed.
- Italics* These parameters are sometimes not shown depending on which parameters are set.
- 1) See result table in chap 15. 2) Only available when **D90**≠1 3) Only available when **D99**=0
- Parameters which are included in the *normal* menu scope (**A10**=0). For other parameters, select **A10**=1:*extended* or **A10**=2:*service*.
- Parameters marked with a "√" can be parameterized separately from each other in parameter record 1 and 2.

13. Parameter Description

F.. Control Interface		
Para. No.	Description	
F00	<p>BA2-function: Functions of binary output 2 (X1.17). <i>1: inactive;</i> 2: standstill: Output active when speed 0 rpm \pmC40 is reached. 3: reference value-reached: When C60=1 (speed mode): output is active when speed reference value is within \pmC40. When C60=2 (position mode), <i>refVal-reached</i> means "in position." The signal appears when reference value specification is concluded (i.e., end of ramp) and the actual position is located within target window \pmI22. The signal is not withdrawn until the next start command. When enable-off occurs, "RefVal-reached" is reset when window I22 is exited or I21 (following error) is exceeded. "RefVal-reached" then remains low. This function cannot be used with process block changes via chaining "no stop" (J17=2). 4: torque-limit: Output active when the active torque limit is reached. See E62. 5: warning: Output active when a warning occurs. 6: operation range: Output active when the defined operational range (C41 to C46) is exited. 7: active parameter set: Only works when F00=7 is parameterized in both parameter records. BA2 inactive = parameter record 1, BA2 active = parameter record 2. The signal arrives before the new parameter record takes effect and can be used, for example, for contactor control with a two-motor drive. Cf. chap. 9.4. 8: electronic cam 1: Only applicable when C60=2 (position mode). Signal appears when the actual position is located between the limits I60 and I61. Useful for starting actions on other drives or modules. 9: following error: Only applicable when C60=2. Maximum following error I21 was exceeded. The reaction to a following error (e.g., fault, warning, and so on) can be parameterized via FDS Tool. 10: posi.active: Only applicable when C60=2. Signal only appears when positioning control is in the basic status "17:posi.active" (i.e., no process block and no chaining being processed). This can be used to signal the end of a chaining sequence, for example. 11: PID-controller limit: Signals restriction of the output of the PID controller to the value G04. 12: synchron difference: Signals that the maximum synchronous angle difference G24 has been exceeded. 13: referenced: Only if C60=2 (position control). Output is high while the drive is being referenced (i.e., reference point traversing has been successfully concluded). 14: clockwise: Speed n>0. For zero crossing, hysteresis with C40. 15: fault: A fault has occurred. 16: inhibited: See "12:inhibited" mode in chap. 16. 17: BE1: Route binary input to binary output. In addition to galvanic isolation, also used to read binary inputs via ASI bus. 18: BE2: Cf. selection "17:BE1." 19: Switch-memory 1: Output switch memory S1. Each of the "posi switching points" defined in Group N.. can be used to control 3 switch memories (S1, S2 and S3) simultaneously. 20: Switch-memory 2: Output switch memory S2. 21: Switch-memory 3: Output switch memory S3. 22: ready for reference value: The drive is powered. Magnetization is established. Reference value can be specified. 23: reference value-ackn.0: In position rmode: When no <i>posi.start</i>, <i>posi.step</i> or <i>posi.next</i> signal is queued, the <i>RV-select</i> signals are output inverted (monitoring with wire break detection). Otherwise active process block I82 is output. See time diagram in chap. 10.3. 24: reference value-ackn.1: See "23:reference value-ackn.0." 25: reference value-ackn.2: See "23:reference value-ackn.0." 26: reference value-ackn.3: See "23:reference value-ackn.0." 27: reference value-ackn.4: See "23:reference value-ackn.0." 28: BE3: Cf. selection "17:BE1." 30: BE4; 31: BE6; 32: parameters active: Low signal means internal parameter conversions not completed. Useful for the handshake with a higher level controller when converting parameter records, and similar.</p>	√
F03	<p>BA2 t-on: Causes a delay in switch-on of BA2. Can be combined with all functions of BA2. The related function must be present for at least t-on so that the BA 2 becomes active. <i>Value range in sec: 0 to 5.024</i></p>	√
F04	<p>BA2 t-off: Causes a delay in switch-off of BA2. Can be combined with all functions of BA2. <i>Value range in sec: 0 to 5.024</i></p>	√

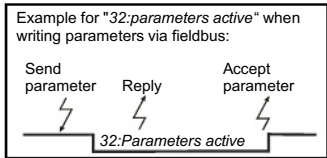

* The power pack must be turned off before these parameters can be changed.
Italics These parameters are sometimes not shown depending on which parameters are set.
 1) See result table in chap 15. 2) Only available when D90=1 3) Only available when D99=0
 Parameters which are included in the normal menu scope (A10=0). For other parameters, select A10=1:extended or A10=2:service.
 Parameters marked with a "√" can be parameterized separately from each other in parameter record 1 and 2.

13. Parameter Description

F.. Control Interface		E															
Para. No.	Description																
F33•	<p>BE3-function: 0 to 13 and greater than 16. See F31. <i>15:inactive</i> 14:ccw V3.2: By programming F33=14 and F34=14, the direction of rotation of inverters can be simulated with software 3.2.</p> <table border="0"> <tr> <td>BE3</td> <td>BE4</td> <td>Command</td> </tr> <tr> <td>0</td> <td>0</td> <td>Quick stop (if F38 not 0) or halt (F38=0).</td> </tr> <tr> <td>0</td> <td>1</td> <td>Clockwise direction of rotation</td> </tr> <tr> <td>1</td> <td>0</td> <td>Counter-clockwise direction of rotation</td> </tr> <tr> <td>1</td> <td>1</td> <td>Halt</td> </tr> </table> <p><i>Value range: 0 to 9 to 32</i></p>	BE3	BE4	Command	0	0	Quick stop (if F38 not 0) or halt (F38 =0).	0	1	Clockwise direction of rotation	1	0	Counter-clockwise direction of rotation	1	1	Halt	√
BE3	BE4	Command															
0	0	Quick stop (if F38 not 0) or halt (F38 =0).															
0	1	Clockwise direction of rotation															
1	0	Counter-clockwise direction of rotation															
1	1	Halt															
F34•	<p>BE4-function: 0 to 13 and greater than 16. See F31. <i>14:cw V3.2 (see F33), 15:inactive.</i> <i>Value range: 0 to 32</i></p>	√															
F35•	<p>BE5-function: Additional input only available with option board <i>SEA-4000</i>. Selection via F31: BE1 function (exception: selection values 14 and 15 are not available here). <i>Value range: 0 to 32</i></p>	√															
F36•	<p>BE-increments: When an incremental encoder is used on BE1 and BE2, the number of increments per revolution must be entered here. If the incremental encoder is not mounted on the motor shaft, the step-down ratios may have to be considered. When external encoders (i.e., not on the motor) are used, remember F49. <i>Value range in I/R: 30 to 1024 to 4096</i></p>	√															
F38	<p>Quick stop: Only if C60≠2 (mode ≠ position). F38 controls the automatic triggering of quick stop under certain operating conditions (brake on quick stop ramp D81). <i>0: inactive;</i> Quick stop can only be triggered by the BE function "9:Quick stop." 1: enable and clockwise/counter-clockwise; Important for use of two direction-of-rotation inputs (i.e., clockwise and counterclockwise) on BE1 and BE2. Quick stop is triggered when BE1 is low and BE2 is low or when the enable is removed (also reference value enable D07 or additional enable via BE). 2: fault and enable; In addition to the BE function "9:Quick stop," removal of the enable and "non-dangerous" faults (e.g., "46:Low voltage") causes the quick stop. During positioning (C60=2), quick stop is always triggered with F38=2. When a quick stop is triggered by removing the enable, this ends after $t = 500 \text{ msec} + 2.2 * C01 * D81$ (e.g.,</p>	√															
F40	<p>Analog-output1-function: Functions of analog output X1.8. A voltage of ±10 V is available on the terminals. The resolution is 19.5 mV, and the scanning time is 4 msec. <i>0: inactive;</i> 1: <i>E00 I-motor;</i> Indication of motor vector current, 10 V = nominal inverter current, bipolar (-10 V to +10 V). 2: <i>E01 P-motor;</i> Indication of motor active power, 10 V = nominal motor power (B11), bipolar. 3: <i>E02 M-motor;</i> Indication of motor torque, 10 V = nominal motor torque, bipolar. 4: <i>E08 n-motor;</i> Indication of motor speed, 10 V = n-max (C01), bipolar. 5: <i>G19 D-actual.;</i> Indication of the diameter (winder), 10 V = Dmax (G13). 6: <i>winder actual tension;</i> Output of current winder tension. F-tension = (M-act./M0 x (D-max/D-act.) 100%. 7: +10V; Fixed value (e.g., for powering a potentiometer). 8: -10V; Fixed value (e.g., for powering a potentiometer). 9: <i>winder tension setpoint;</i> Tension reference value for winding at torque limit (G10=2). 10: <i>motor potent. value;</i> 10 V = n-Max (C01), unipolar. 11: <i>E07 n-post-ramp;</i> 10 V = n-Max (C01), bipolar.</p>	√															
F41	<p>Analog-output1-offset: Offset of analog output X1.8. <i>Value range in %: -400 to 0 to 400</i></p>	√															
F42	<p>Analog-output1-gain: The raw value specified via F40 is offset with F41 and multiplied by factor F42. Example: If F40=1 and F42=50%, then 5 V on the analog output = nominal inverter current. <i>Value range in %: -400 to 100 to 400</i></p>	√															
F43	<p>Analog-output1-absolute: An absolute value (amount) is generated for the output signal. <i>0: inactive;</i> 1: <i>active;</i></p>	√															
F45	<p>Analog-output2-function: Function of analog output X1.9. For selection, see F40. <i>Value range: 0 to 1 to 11</i></p>	√															
F46	<p>Analog-output2-offset: Offset for output X1.9. Cf. F41. <i>Value range in %: -400 to 0 to 400</i></p>	√															
F47	<p>Analog-output2-gain: Gain for output X1.9. Cf. F42. <i>Value range in %: -400 to 50 to 400</i></p>	√															

* The power pack must be turned off before these parameters can be changed.
Italics These parameters are sometimes not shown depending on which parameters are set.
 1) See result table in chap 15. 2) Only available when **D90**≠1 3) Only available when **D99**=0
 Parameters which are included in the *normal* menu scope (**A10**=0). For other parameters, select **A10**=1:*extended* or **A10**=2:*service*.
 Parameters marked with a "√" can be parameterized separately from each other in parameter record 1 and 2.

13. Parameter Description

F.. Control Interface		E
Para. No.	Description	
F49	BE-gear ratio: Only if C60 =2. Conversion of an external posi encoder to the motor shaft. Caution: Parameter has no effect on the speed calculation for motor control (vector control). It is only used to convert the position of an external encoder. The following must apply: F49 = number of motor revolutions/number of encoder revolutions. If this formula results in values over 32.767, the number of encoder increments in F36 must be divided by a suitable factor (e.g., 2). The result of the above formula is then also divided and entered in F49 . See also chapter 10.11.2. <i>Value range:</i> -32.768 to 1 to 32.767	√
F51... F55...	BE1-invert to BE5-invert <i>0:</i> inactive; No inversion. <i>1:</i> active; Input is inverted. Useful for the HALT signal or limit switch, for example.	√
F60	BE6-function: Additional inputs only available with option board <i>SEA-4000</i> . Selection via F31 : BE1 function (exception: selection values 14 and 15 are not available here). <i>Value range:</i> 0 to 32	√
F61	BE7-function: See F60 . <i>Value range:</i> 0 to 32	√
F62	BE8-function: See F60 . <i>Value range:</i> 0 to 32	√
F63	BE9-function: See F60 . <i>Value range:</i> 0 to 32	√
F64	BE10-function: See F60 . <i>Value range:</i> 0 to 32	√
F65	BE11-function: See F60 . <i>Value range:</i> 0 to 32	√
F66	BE12-function: See F60 . <i>Value range:</i> 0 to 32	√
F67	BE13-function: See F60 . <i>Value range:</i> 0 to 32	√
F68	BE14-function: See F60 . <i>Value range:</i> 0 to 32	√
F70... F78	BE6-invert to BE14-invert: Cf. F51 to F55 (only available with option boards). <i>0:</i> inactive; no inversion. <i>1:</i> active; Input is inverted.	√
F80	BA1-function: Function of binary output 1. <i>1:</i> inactive; <i>2 to 32:</i> Selection values in acc. w. parameter F00 (BA2-function).	√
F81	BA2-function: Selection values in acc. w. parameter F00 . <i>Value range:</i> 0 to 1 to 32	√
F82	BA3-function: Selection values in acc. w. parameter F00 . Only available with option boards. <i>Value range:</i> 1 to 32	√
F83	BA4-function: Selection values in acc. w. parameter F00 . <i>Value range:</i> 1 to 32	√
F84	BA5-function: Selection values in acc. w. parameter F00 . <i>Value range:</i> 1 to 32	√
F85	BA6-function: Selection values in acc. w. parameter F00 . <i>Value range:</i> 1 to 32	√
F86	BA7-function: Selection values in acc. w. parameter F00 . <i>Value range:</i> 1 to 32	√
G.. Technology		E
Para. No.	Description	
G00	PID-controller: Activates the PID controller on input AE2. Cf. chapter 12.1. <i>0:</i> inactive; <i>1:</i> active;	√
G01	PID-controller Kp: Only if G00 =1 (i.e., PID controller active). Loop gain. The total gain of the control loop is also affected by F22 (AE2 gain) in addition to G01 . Cf. block circuit diagram in chap. 12.1. <i>Value range:</i> 0 to 0.3 to 100	√
G02	PID-controller Ki: Only if G00 =1 (i.e., PID controller active). Gain of I share in 1/sec. Example: If G02 =0.2 x 1/sec, then a 20% higher constant input signal is integrated within one second. <i>Value range in 1/sec:</i> 0 to 10	√

* The power pack must be turned off before these parameters can be changed.

Italics These parameters are sometimes not shown depending on which parameters are set.

1) See result table in chap 15.

2) Only available when **D90**=1

3) Only available when **D99**=0

Parameters which are included in the *normal* menu scope (**A10**=0). For other parameters, select **A10**=1: *extended* or **A10**=2: *service*.

E Parameters marked with a "√" can be parameterized separately from each other in parameter record 1 and 2.

13. Parameter Description

G.. Technology		E
Para. No.	Description	
G03	PID-controller Kd: Only if G00=1 (i.e., PID controller active). Gain of D share in msec. <i>Value range in msec: 0 to 1000</i>	√
G04	PID-controller limit: Only if G00=1 (i.e., PID controller active). Adjuster-variable limit. For scaling, see F22 . Asymmetric limits can be specified with G04 and G05 (e.g., from -10% to +30%). Upper and lower limit values are automatically (internally) sorted correctly. <i>Value range in %: -400 to 400</i>	√
G05	PID-controller limit2: See G04 . <i>Value range in %: -400 to 400</i>	√
G06	PID-controller Kp2: Pure proportional gain of the PID controller. Effective parallel to I and D portion. <i>Value range: 0 to 1 to 10</i>	√
G10	Winding operation: Activates the winding functions (speed reduction based on diameter). <i>D: inactive;</i> <i>1: n mode;</i> Speed adjustment in accordance with $n \sim 1/D$. No effect on torque limit M-Max. <i>2: M-Max mode;</i> Maximum torque is reduced based on D-Act/D-Max.	√
G11	Diameter: Only if G10≠0 (winding operation active). Specifies the type of diameter definition. <i>D: AE-measurement;</i> Diameter sensor 0 to 10 V is connected to AE2. <i>1: n-line/n-motor;</i> For traction or compensating roller controllers. The diameter is calculated from the ratio of control speed to motor speed. The control speed (i.e., speed reference value) always refers to an empty reel (i.e., the smallest diameter). <i>2: roller;</i> The diameter is calculated with an overtravel ramp based on E122 (from fieldbus or via analog input function "12.winder roller"). If E122 > 5%, G19 is increased by ramp G16 . If E122 < -5%, G19 is decreased by ramp G16 . Otherwise G19 remains constant.	√
G12	Min. winding diameter: Only if G10≠0 (winding operation active). Diameter of an empty reel. <i>Value range in mm: 10 to 3000</i>	√
G13	Max. winding diameter: Only if G10≠0 (winding operation active). Diameter of a full reel. <i>Value range in mm: 10 to 100 to 3000</i>	√
G14	Begin. winding diameter: Only if G10≠0 (winding operation active). Initial diameter. Must be set via a binary input with the function "29.wind.setD-ini" (F31 to F35). <i>Value range in mm: 40 to 3000</i>	√
G15	Overdrive ref. value: Only if G10≠0 (winding operation active). G15 is added to the control reference value while winding at the torque limit (G10=2) so that M-limit is triggered and the winding material remains taunt. <i>Value range in rpm: -6000 to 0 to 6000</i>	√
G16	Diam.calculator ramp: Only when G10>0 . Integration speed of the diameter calculation. G11=0: no function G11=1: limitation of the integration speed for G19 G11=2: ramp with which the diameter is changed when $-5\% < E122 < +5\%$. <i>Value range in mm/sec: 0 to 10 to 100</i>	√
G17	Tension reduction: Only when G10>0 . Reduction of tension as diameter increases. If min. diameter D-Min: winding with 100% tension. Up to D-Max: tension reduced linearly up to $(100\% - G17)$. <i>Value range in %: 0 to 100</i>	√
G19	Actual. winding diameter: Only if G10≠0 (winding operation active). Indication of the current diameter.	
G20	Electronic gear: Only when C60=1: speed . Activates the "electronic gear/synchronous running" function (chap. 11). See block circuit diagram in chap. 18. <i>D: inactive;</i> <i>1: speed synchron run;</i> G24 limits the effect of the angle controllers. Cf. chap. 11.6. <i>2: angle synchron run</i> <i>3: angle + save;</i> Same as G20=2 . However, each time enable-off occurs, the angle deviation is stored non-volatily and thus remains available after power off and on. See also G25 .	√
G21	Speed master: Only if G20>0 (electronic gear active). The slave speed is calculated from $nSlave = G22/G21 \times nMaster$. The increments of the incremental encoders are specified with F36 and H22 . If G21=1 and G22=2 , the slave is twice as fast as the master. We recommend selecting the number of increments for the master encoder (in acc. w. G27) as a power of 2 (e.g., 1024). <i>Value range: 1 to 2147483647</i>	√
G22	Speed slave: Only if G20>0 (electronic gear active). See G21 . At a speed ratio of 1:1, G21=G22=1 must be parameterized. The direction of rotation of the slave can be changed with D92 . <i>Value range: 1 to 2147483647</i>	√

* The power pack must be turned off before these parameters can be changed.
Italics These parameters are sometimes not shown depending on which parameters are set.
 1) See result table in chap 15. 2) Only available when **D90≠1** 3) Only available when **D99=0**
 Parameters which are included in the *normal* menu scope (**A10=0**). For other parameters, select **A10=1:extended** or **A10=2:service**.
 Parameters marked with a "√" can be parameterized separately from each other in parameter record 1 and 2.

13. Parameter Description

G.. Technology		E
<i>Para. No.</i>	<i>Description</i>	
G23	Kp synchron: Only if G20>0 (electronic gear active). Gain of the angle controller in 1/sec. Typical values are 10 to 60. G23=0 activates speed synchronous running. The slave then no longer attempts to catch up with the master (e.g., after a blockage). Instead, the mathematically precise speed ratio is only ensured within the window \pm G24 . When G23=0 and G24=0 , the master encoder is only used as a speed reference value, and the ratio set in G22/G21 is not precisely maintained mathematically. Cf. chapter 11.6. <i>Value range in 1/sec: 0 to 30 to 100</i>	√
G24	Max. synchron. difference: Only if G20>0 (electronic gear active). Maximum angle of deviation between master and slave (following error). When this value is exceeded, a signal is generated on the output (cf. F00 or F80=12:synch.diff.), but no fault is triggered. This can be performed with external wiring and the input function "12:ext.fault" (F31 to F35). In G20=1:speed sync. mode , G24 limits the effect of the angle controller. This smooths the transition between pure speed synchronous and angle synchronous running. <i>Value range in °: 0 to 3600 to 30000</i>	√
G25	Synchron reset: Only if G20>0 . Defines conditions for resetting the current synchronous deviation. <i>0: with BE;</i> Reset only possible with BE function "28:SyncReset" (always possible). <i>1: enable & BE;</i> Reset also with removal of the enable as well as with halt and quick stop. <i>2: free run & BE;</i> Reset only with BE functions "27:syncFreeRun" and "28:SyncReset." <i>3: enable & free run & BE;</i> All methods above will cause a reset. The synchronous deviation is always set to zero when the device is turned on. (Exception: G20=3 . Reset is only performed when the stored deviation exceeds 5°).	√
G26	n-correction-Max: Only if G20>0 (electronic gear active). G26 limits the output of the angle controller. Important when large angle deviations must be reduced (e.g., when the free-run function is used). <i>Value range in rpm: 0 to 3000 to 6000</i>	√
G27	Synchronous encoder: Only when G20>0 . Signals of the master arrive over this interface. <i>0: BE-encoder;</i> Master signals are connected to binary inputs. <i>1: X20;</i> Master signals arrive over plug connector X20. <i>2: X41;</i>	√
G28	n-Master: Only when G20>0 . For monitoring during commissioning. Speed of reference value encoder as per G27 . <i>Value range in rpm: ±5000</i>	
G29	Synchron difference: Only if G20>0 (electronic gear active). Indication of the current synchronous deviation in degrees as related to the slave motor. n-controller Ki>0 is required for a synchronous deviation near 0. <i>Value range in °: -2147483648 to 0 to 2147483647</i>	
G30	Speed feed forward: Speed precontrol for synchronous running. When G30=100% , no following error is used when speed is constant (synchronous deviation is zero). With dynamic movements, G30 must be reduced (50 to 80%). Otherwise the slave will overswing. <i>Value range in %: 0 to 80 to 100</i>	√
G31	Reference direction: Only if G20>0 . Starting direction to look for the reference point. Referencing searches for a reference cam. Cf. I30=0:Ref.input in positioning mode and the examples in chap. 10.6. Synchronous deviation is reset at the reference position. Other ways of resetting the synchronous deviation include the BE signal "28:Synchro Reset" or automatically with parameter G25 . <i>0: positive;</i> <i>1: negative;</i>	√
G32	Reference speed fast: Only if G20>0 . Speed for first phase of referencing (rough traversing). <i>Value range in rpm: 0 to 1000 to 6000</i>	√
G33	Reference speed slow: Only if G20>0 . Speed for final phase of referencing. <i>Value range in rpm: 0 to 300 to 6000</i>	√
G35	Ref.encoder signal 0: Only if G20>0 . Referencing to zero pulse of the motor encoder. Do not use for continuous mode with an odd-number gear ratio. <i>0: inactive;</i> <i>1: Motor-encoder;</i>	√
G38	Synchronous offset: Only if G20>0 . An offset distance based on the voltage on an analog input can be added to the current slave position. 10 V corresponds to the angle entered in G38 . <i>Value range in °: -214748364.8 to 0 to 214748364.7</i>	√
G40	Static friction torque: Only if G10>0 . Offset of the static friction (i.e., the friction (coulomb) independent of the speed). Value is converted to the motor shaft. <i>Value range in Nm: 0 to 327.67</i>	√

• The power pack must be turned off before these parameters can be changed.

Italics These parameters are sometimes not shown depending on which parameters are set.

1) See result table in chap 15.

2) Only available when **D90=1**

3) Only available when **D99=0**

Parameters which are included in the normal menu scope (**A10=0**). For other parameters, select **A10=1:extended** or **A10=2:service**.

E Parameters marked with a "√" can be parameterized separately from each other in parameter record 1 and 2.

13. Parameter Description

G.. Technology		E
Para. No.	Description	
G41	<p>Dynamic friction torque: Only if G10>0. Offset of the speed-proportional friction. Value converted to the motor shaft at 1000 rpm. Value range in Nm/1000 rpm: 0 to 327.67</p>	√
G42	<p>T-dyn lowpass: Only if G10>0. Torque for acceleration/deceleration can be offset dynamically. The load/motor inertia ratio with a full reel (D-Max) must be entered for this in parameter C30. The acceleration portion to be used is obtained by dividing the speed. G42 specifies the related smoothing time constant.</p>	√

H.. Encoder		E
Para. No.	Description	
H20	<p>X20-function: See also description in chap. 5.4. 0: inactive; 1: encoder simulation; Encoder simulation (TTL) output for a host controller. H21 specifies the number of pulses. 2: encoder In; Connection of an incremental encoder with ROD signals. Wire-break monitoring active. 3: stepmotor In; Stepper motor input function. Track A is the sign (low = positive, high = negative). Track B is the counting frequency (chapters 11.2 and 14.1). 4: SSI simulation; Simulation of a multi-turn SSI encoder. Useful for an absolute-value encoder on X41 for motor control. The host controller can scan the absolute position in SSI format on X20. 5: SSI master; Connection of an SSI encoder (absolute value encoder). Note: SSI encoders can be used as external encoders for POSI. The absolute position for POSI can only be read from the encoder when the device starts up. If H20 is reparameterized and H20 was or is now H20=5, this triggers fault "37:n-feedback" which cannot be acknowledged. Save values with A00, and turn basic device off/on.</p>	√
H21	<p>Encodersim. increments: Only if H20=1. Specifies the number of pulses per motor revolution. 0: 256; 1: 512; 2: 1024; 3: 2048; 4: 4096;</p>	√
H22	<p>X20-increments: Number of increments for incremental encoders. With SSI encoders, the range of H23 (X20 gear ratio) can be expanded with H22. See chap. 10.11. H22=1024 is the neutral setting. Value range in I/R: 30 to 1024 to 4096</p>	√
H23	<p>X20-gear ratio: Only if C60=2. Conversion of an external posi encoder to the motor shaft. Caution: Parameter has no effect on the speed calculation for motor control (vector control). It is only used to convert the position of an external encoder. The following must apply: H23 = number of motor revolutions/number of encoder revolutions. If this formula results in values over 32.767, the number of encoder increments in H22 must be divided by a suitable factor (e.g., 2). The result of the above formula is then also divided and entered in H23. See also chapter 10.11.2. With SSI encoders, the gear ratio is expanded by setting H22 to a value other than 1024. Value range: -32.768 to 1 to 32.767</p>	√
H24	<p>X20-zero-Pos.: Zero pulse shift during encoder simulation. Value range in °: 0 to 360</p>	√
H31	<p>Resolver poles: Number of poles of the connected resolver. Typical values are 2 (standard for STÖBER) and 6. Value range: 2 to 16</p>	√
H32	<p>Commutation-offset: Shifts the resolver zero position in comparison to the motor. Since STÖBER motors are set to H32=0 at the plant and tested, it is usually never necessary to change H32. If the B40 phase test results in an H32 value > 0, this probably indicates a problem with the plug connectors or wiring. Value range in °: 0 to 360</p>	√
H40	<p>X41-function: See description in chapters 5.5 and 5.6. 0: inactive; 1: SinCos in; 2: encoder in; 3: stepMot in;</p>	√
H41	<p>X41-increments: The value is automatically determined with sin/cos encoders with EnDat® or Hiperface® interface. Value range in I/R: 30 to 1024 to 4096</p>	√
H42	<p>X41-gear ratio: See H23. Value range: -32.768 to 1 to 32.767</p>	√
H60	<p>SSI-invert: Reverse sign for external SSI encoders. Wrong sign → unstable control loops. 0: inactive; Clockwise revolution of motor shaft while facing the shaft (A side) counts as positive. 1: active; Clockwise revolution of motor shaft counts as negative.</p>	√

* The power pack must be turned off before these parameters can be changed.
Italics These parameters are sometimes not shown depending on which parameters are set.
 1) See result table in chap 15. 2) Only available when **D90**≠1 3) Only available when **D99**=0
 Parameters which are included in the normal menu scope (**A10**=0). For other parameters, select **A10**=1:extended or **A10**=2:service.
 E Parameters marked with a "√" can be parameterized separately from each other in parameter record 1 and 2.

13. Parameter Description

I.. Posi. Machine		E
Para. No.	Description	
I07	<p>Way/revolution numerator: For consideration of the gear ratio between machine and encoder I02. For external position measurement, cf. chap. 10.11. The number of decimal positions corresponds to I06. The posi. direction of rotation can be changed with negative values in I07.</p> <p>Example: With a gear ratio of $i=12.43$ and an angle specification on the drive shaft, then $I07=360^\circ/12.43 R=28.96^\circ/R$. For higher requirements, precision can be increased to almost any amount with I08.</p> <p>Example: 12.34567 mm/R corresponds to I07=12345.67 and I08=1000. Cf. also chap. 10.9.</p> <p><i>Value range in I05: -31 bits to 360 to 31 bits</i></p>	
I08	<p>Way/revolution denomin.: Counter I07 is divided by denominator I08. A mathematically precise gear ratio can thus also be calculated as a fraction (e.g., toothed gear box and toothed belt gear box). Important for external encoders that are not mounted on the motor shaft: One "encoder revolution" must be related to one motor revolution.</p> <p><i>Value range in R: 1 to 31 bits</i></p>	
I09	<p>Measurement unit: Only if I05=0 (user unit). Indication of the unit of measure defined by the user with FDS Tool. Up to 4 characters can be used.</p>	
I10	<p>Max. speed: Unit/sec.</p> <p>Works simultaneously with the maximum motor speed in C01. The actual speed limit corresponds to the lower of the two parameters. When a higher feed speed is specified, the value is limited to I10 or C01 without causing the following error.</p> <p><i>Value range in I05/sec: 0 to 10 to 31 bits</i></p>	
I11	<p>Max. acceleration: Units/sec². With quick stop, the drive decelerates with I11. The acceleration for manual (I12) and reference point traversing (I33, chap. 10.6) is also derived from I11 (i.e., each is 1/2 of I11).</p> <p><i>Value range in I05/sec²: 0 to 10 to 31 bits</i></p>	
I12	<p>Tip speed: Units/sec. Speed during manual operation (J03). As with all speeds, it can be changed via analog input (F20=5:Override). Acceleration during manual operation is 1/2 of I11.</p> <p><i>Value range in I05/sec: 0 to 180 to 31 bits</i></p>	
I15	<p>Accel-override: Permits modification of the set ramps via AE2 (F20=5:Override).</p> <p><i>Q: inactive;</i> Ramps are not changed by override. Standard setting.</p> <p><i>1: active;</i> Ramps are changed by override. Only recommended in exceptional cases (e.g., process block chain). Without stop to generate simple n(x) speed profiles</p> <p>Caution: The override value affects acceleration to the power of two. Danger of overload when override > 100%. During ramps, changes in accel-override are only adjusted slowly in a background task. When Accel-Override (I15=1) is activated, the override value should not be decreased to 0%. This would make the ramp infinitely long and the drive would never stop!</p>	
I16	<p>S-ramp: Reverse limitation through square sinus ramp. The generated acceleration profile is smoothed with the specified time constant. Positioning takes a little longer.</p> <p><i>Value range in msec: 0 to 32767</i></p>	
I19	<p>ENA-interrupting: In the default setting, removal of the enable causes the position controller to be reset (status "17:posi.active"). Particularly during continuous positioning, it is important that interrupted process blocks can be concluded after emergency off or similar. I19=1 offers particularly simple process block interruption. See also chap. 10.10.</p> <p><i>Q: inactive;</i> Enable-off resets the positioning controller.</p> <p><i>1: active;</i> Enable-off while process block is running causes status "23:interrupted." The interrupted process block is completed with <i>Posi.step</i>. Not possible for process blocks which are chained <i>without Stop</i> (J17=2).</p>	
I20	<p>Kv-factor: Gain of position controller (only P characteristic) with unit of 1/sec. The Kv factor is also known as the speed gain. In actual practice, the Kv factor is sometimes specified with the unit m/min/mm which is exactly $0.06 \times I20$. See also block circuit diagram in chap. 10.7.</p> <p><i>Value range in 1/sec: 0 to 30 to 100</i></p>	
I21	<p>Max. following error: The output function (F00=9:follow.error) is activated when the following error defined in I21 is exceeded. FDS Tool can then be used to specify the desired reaction to the exceeded following error as a fault (default setting), warning or message.</p> <p><i>Value range in I05: 0 to 90 to 31 bits</i></p>	
I22	<p>Target window: Window for the output signal "reference value reached" (F00=3:RefVal-reached). I22 must be greater than I23!</p> <p><i>Value range in I05: 0 to 5 to 31 bits</i></p>	
I23	<p>Dead band pos. control. "Dead zone" of the position controller. Useful to prevent idle-state oscillation particularly when an external position encoder is used and there is reversal play in the mechanics. Cf. chap. 10.7.</p> <p>Caution: I23 Dead band must be smaller than target window I22!</p> <p><i>Value range in I05: 0 to 31 bits</i></p>	

* The power pack must be turned off before these parameters can be changed.
Italics These parameters are sometimes not shown depending on which parameters are set.
 1) See result table in chap 15. 2) Only available when **D90**≠1 3) Only available when **D99**=0
 Parameters which are included in the *normal* menu scope (**A10**=0). For other parameters, select **A10**=1:extended or **A10**=2:service.
 Parameters marked with a "Q" can be parameterized separately from each other in parameter record 1 and 2.

I.. Posi. Machine		
<i>Para. No.</i>	<i>Description</i>	
I25	Speed feed forward: Switches the calculated speed profile to the output of the position controller (chap. 10.7). If there is overswinging in the destination position, I25 and C32 must be reduced. <i>Value range in %:</i> 0 to 80 to 100	
I30	Reference mode: For details on reference point traversing, see chapter 10.6. <i>0: reference input;</i> When searching for the reference point, the reference input is the determining factor (i.e., the BE function "23:Reference input" must be parameterized). <i>1: stop input;</i> The function of the reference input is fully covered by the stop switch (i.e., BE function "21:Stop +" or "22:Stop -" must be parameterized). When the starting direction is positive (I31 =0), positive "Stop +" is required. Triggering the wrong stop switch causes a fault. <i>2: encoder signal 0;</i> Only of interest for drives without a gearbox. Used to align the motor shaft to a defined position. <i>3: define home;</i> BE function "24:Start ref." or J05 → 1 immediately sets the actual position to I34 without performing an additional movement. For example, this can be used to set the actual position to zero at all times (enable must be active). <i>4: posi.start;</i> Each <i>posi.start</i> signal causes reference position I34 to be set. This can be used, for example, to indicate the actual distance as the current position with relative positioning and offset of the traversing path via analog signal (" <i>1:additional reference value</i> " and " <i>4:reference value-factor</i> ").	
I31	Reference direction: Initial direction to take when searching for the reference point. Cf. chapter 10.6. If only one direction is permitted (I04 >0), the reference traversing direction depends on I04 and not I31 . <i>0: positive;</i> <i>1: negative;</i>	
I32	Reference speed fast: Speed for the first phase of reference point traversing (i.e., determining the rough area). Omitted when only one direction of rotation (I04) is permitted. Only the slow speed (I33) is then used for this type of reference point traversing. <i>Value range in I05/sec:</i> 0 to 90 to 31 bits	
I33	Reference speed slow: Speed for the final phase of reference point traversing. Switching between I32 and I33 is automatic. Cf. figures in chapter 10.6. The acceleration during reference point traversing is I11/2 . <i>Value range in I05/sec:</i> 0 to 4.5 to 31 bits	
I34	Reference position: Value which is loaded to the reference point (e.g., provided by the reference switch or the stop switch) as the actual position. The drive stops after reference point traversing. The position is determined by brake ramp I11/2 . Cf. chapter 10.6. <i>Value range in I05:</i> -31 bits to 0 to 31 bits	
I35	Ref.encoder signal 0: Only if I36 =0 and I30 ≠2. Referencing to zero pulse of an incremental encoder. <i>0: inactive;</i> Zero pulse is not evaluated. Referencing to the edge of the stop or reference switch. Important for continuous axes with transmissions, for example. Also useful when there are not enough binary inputs and demands on accuracy are not high. <i>1: motor encoder;</i> <i>2: posi encoder;</i> In acc. w. parameter I02 (under preparation).	
I36	Continuous reference: Only for continuous axes (I30 =0). Used for fully automatic compensation of slip or inexact gear ratio. After the reference points are traversed for the first time, actual position I80 is always overwritten with reference position I34 each time the reference switch is passed over in direction I31 (but only in this direction!). Since the path which is still to be traversed is corrected, the axis is able to perform any number of relative movements in one direction without drifting, even when drives have slip. If the reference switch is connected to BE3, the signal is processed immediately. Remember: When I36 =1, the other edge of the reference switch is evaluated than the one for I36 =0 during reference point traversing. Circular length I01 must be as close as possible to the path between two reference signals (e.g., after one belt rotation, the same position must be indicated). Check actual position I80 during a rotation with I36 =0, and adjust I07 if necessary. The distance per rotation I07 must always be rounded to the next higher number to prevent undesired counterclockwise offsets. The reference switch should not be triggered during a deceleration ramp since a negative offset would cause a counterclockwise movement. Important: Target window I22 must be greater than the maximum physical inaccuracy! <i>0: inactive;</i> <i>1: active</i>	
I37	Power-on reference: Automatic reference point traversing after power-on. <i>0: inactive;</i> <i>1: posi.start;</i> After power-on, the inverter assumes operating mode "24:ref.wait." The first <i>posi.start</i> or <i>posi.step</i> signal starts the reference point traversing procedure. <i>2: automatic;</i> Reference point traversing is started automatically as soon as the enable appears.	

• The power pack must be turned off before these parameters can be changed.

Italics These parameters are sometimes not shown depending on which parameters are set.

1) See result table in chap 15.

2) Only available when **D90**≠1

3) Only available when **D99**=0

 Parameters which are included in the *normal* menu scope (**A10**=0). For other parameters, select **A10**=1:*extended* or **A10**=2:*service*.

 Parameters marked with a "√" can be parameterized separately from each other in parameter record 1 and 2.

13. Parameter Description

I.. Posi. Machine		E
Para. No.	Description	
I38	Reference block: Number of the process block (i.e., 1 to 32) which is to be automatically started at the end of reference point traversing. This can be used to put the drive into a defined position after the reference points have been traversed. <i>0:</i> standstill. No automatic start. <i>1 to 32:</i> Number of the process block to be executed.	
I40	Posi.-step memory: Helpful during relative positioning of continuous axes. <i>0:</i> inactive; <i>Posi.step</i> signals during a movement are ignored. <i>1:</i> no stop; <i>Posi.step</i> signals which arrive during a movement cause the current destination position to be changed immediately. The process block specified by the reference block or, if no reference block is defined, the currently selected process block takes over. Example: Two additional <i>posi.step</i> signals arrive during a relative movement of 100 mm. The drive then moves precisely 300 mm without stopping.	
I50	Software-stop -: Only if I00=0 (limited position range). Effective only when axis is referenced. Positioning control rejects traversing jobs outside the software limit switches (message "51:Refused"). Manual-traversing and continuous process blocks are stopped at the software stops. Caution: Software stops do nothing to compensate when the permissible position range is exceeded due to a change on the fly to a process block with slower ramps! <i>Value range in I05:</i> -31 bits to 10000000 to 31 bits	
I51	Software-stop +: Only if I00=0 (limited position range). Effective only when axis is referenced. <i>Value range in I05:</i> -31 bits to 10000000 to 31 bits	
I60	Electronic cam 1 begin: In the positioning area between I60 and I61 , the <i>el.cam</i> signal (F00=8) becomes high. "Electronic cam" only functions in the referenced state. Cf. also the related function "operating range" in chapter 9.3. <i>Value range in I05:</i> -31 bits to 0 to 31 bits	
I61	Electronic cam 1 end: See I60 . <i>Value range in I05:</i> -31 bits to 100 to 31 bits	
I70	Position-offset: A correction path corresponding to the voltage on AE2 can be added to the current reference value position (F20=6). 10 V corresponds to the path specified in I70 . Useful, for example, for creating complicated x(t) profiles which are generated by a PC as voltage. After activation of the inverter (i.e., enable), the current offset value is approached at the manual speed I12 . The reference value from AE2 is then supplied without restrictions and the AE2 low pass can be used for smoothing. <i>Value range in I05:</i> 0 to 31 bits	
I80	Actual position: Read only. Indication of the actual position. <i>Value range in I05:</i> ±31 bits	
I81	Target position: Read only. Indication of the current reference value position. <i>Value range in I05:</i> ±31 bits	
I82	Active process block: Read only. Indication of the currently active block during block processing (traverse, wait) and during standstill at a process block position. The approached process block is indicated in I82 as long as the "RV reached" signal (i.e., in position) is present. When the drive is not in a process block position (e.g., after power on, manual traversing or termination of a movement), I82=0 applies. When I82>0 , the signals "23: reference value-ackn.0" to "27: reference value-ackn.4" can indicate the active process block in binary coded format ("000" for process block 1 - i.e., I82=1). Cf. chap. 10.3.	
I83	Selected process block: Read only. Indication of the block selected via binary inputs or J02 . This process block would be executed with the <i>posi.start</i> signal. Cf. also chap. 10.3 and F00=23 .	
I84	Following error: Read only. Indication of the current position deviation. Cf. I21 and F00=9 . <i>Value range in I05:</i> ±31 bits	
I85	In position: Read only. Indication of output signal F00=3:refVal-reached . <i>0:</i> inactive; Drive moving or destination position not reached. <i>1:</i> active; See output signal F00=3:refVal-reached and I22 target window.	
I86	Referenced: Read only. Indication of output signal "13:referenced." For reference point traversing, see chap. 10.6. <i>0:</i> inactive; Drive not referenced. No absolute positioning possible. <i>1:</i> active; Drive referenced.	
I87	Electronic cam 1: Read only. Indication of output signal "8:electronic cam 1." <i>0:</i> inactive; Current position is outside I60 and I61 . <i>1:</i> active; Current position is within I60 and I61 .	
I88	Speed: Read only. Indication of the current reference value of the positioning speed with unit. Cf. chap. 10.7. <i>Value range in I05/sec:</i> ±31 bits	

* The power pack must be turned off before these parameters can be changed.
Italics These parameters are sometimes not shown depending on which parameters are set.
 1) See result table in chap 15. 2) Only available when **D90=1** 3) Only available when **D99=0**
 Parameters which are included in the *normal* menu scope (**A10=0**). For other parameters, select **A10=1:extended** or **A10=2:service**.
 Parameters marked with a "¶" can be parameterized separately from each other in parameter record 1 and 2.

14. Option board
14.1 Option board SEA 4000

14.1 Option board SEA 4000

Purpose:
Expansion of the digital inputs/outputs of a POSIDYN® SDS 4000 servo inverter

- 10 additional binary inputs (BE5 to BE14), galvanically isolated
- 5 additional binary outputs (BA3 to BA7), galvanically isolated
- Inputs/outputs identical to those of option boards SEA + SDP4000 (combi board)

Installation:

- ① Remove the cover from the top of the housing with a suitable tool (side cutting pliers). Do not saw. Do not allow metal shavings to penetrate the device.
- ② Install board vertically in the housing, and secure with two screws.

Terminal	Function	Parameter	Circuiting
Terminal strip X21	1	Input BE5	F35 L - level: 0 to 7 V / 0 mA H - level: +12 to 30 V / 7 mA, Ri=3,3 kΩ
	2	Input BE6	
	3	Input BE7	
	4	Input BE8	
	5	Input BE9	
	6	Input BE10	
	7	Input BE11	
	8	Input BE12	
	9	Input BE13	
	10	Input BE14	
11	Output BA3	F82	<ul style="list-style-type: none"> • External power must be available on terminal X21.17 and be between 15 and 29 V. • Maximum output current 50 mA with load against ground • Maximum output current 200 mA with load against 24 V
12	Output BA4	F83	
13	Output BA5	F84	
14	Output BA6	F85	
15	Output BA7	F86	
16	GND		Reference ground galvanically isolated from inverter
17	+24 V		Voltage for the output drivers (BA3 to BA7)

14.2 Option board SDP 4000

Purpose:
 PROFIBUS link to a **POSIDYN®** SDS 4000 servo inverter
 • Plug connector allocation is identical to the SEA + SDP4000 option board (combi-board).

Installation:
 ① Remove the cover from the top of the housing with a suitable tool (side cutting pliers). Do not saw. Do not allow metal shavings to penetrate the device.
 ② Install board vertically in the housing, and secure with two screws.

	Ter- mi- nal	Function	Comment
Terminal \$ ip X32	1	Not used	For correct function, use only suitable plug connectors for connection of the bus cable. The incoming and outgoing bus cable can be inserted in this plug connector and screwed down.
	2	Not used	
	3	TxD/RxD (P) = B	The sliding switch on the plug connector must be set to "on" for the last station so that the bus terminal resistors are connected.
	4	RTS	
	5	DGND	
	6	VP	
	7	Not used	
	8	TxD/RxD (N) = A	
	9	Not used	

14.3 Option board SEA 4000 and SDP 4000 (combi board)

Purpose:
 Expansion of the digital inputs/outputs of a **POSIDYN®** SDS 4000 servo inverter
 • 10 additional binary inputs (BE5 to BE14), galvanically isolated
 • 5 additional binary outputs (BA3 to BA7), galvanically isolated
 • PROFIBUS link to a **POSIDYN®** SDS 4000 servo inverter

Installation:
 ① Remove the cover from the top of the housing with a suitable tool (side cutting pliers). Do not saw. Do not allow metal shavings to penetrate the device.
 ② Install board vertically in the housing, and secure with two screws.

For terminal allocation X21 and X32, see option boards SEA 4000 and SDP 4000.

15. Result Table

Result Table	
The result of actions (e.g., save parameter (A00=1) is indicated on the display. Possible results are listed below.	
0: Error free	The data were transferred correctly.
1: Error!	General error
2: Wrong box	Controlbox's data memory has incompatible data structure (e.g., formatting for another memory size).
3: Invalid data	Controlbox's data memory contains invalid data. Write Controlbox again, and repeat the procedure.
5: OK (adjusted)	Software version of Controlbox data (or similar) and inverter differ in several parameters. Confirm with the # key. Message does not affect functionality of the controller.
6: OK (adjusted)	Software version of Controlbox data (or similar) and inverter differ in several parameters. Confirm with the # key. Message does not affect functionality of the controller.
9: BE encoder signal	<ul style="list-style-type: none"> If synchronous reference value G27=0:BE encoder or posi encoder I02=0:BE encoder, the following must apply: F31=14(15), F32=15(14). If G27=1 (synchronous reference value = X20) or I02=1 (posi encoder = X20), the following must apply: F31≠14(15), F32≠15(14). Values in parentheses: Encoder (signal A, B) and stepper motor connection (frequency + sign) access the same counter.
10: Limit value	Value outside the value range
12: BE/X20/X41	Conflict while accessing the encoder pulse counter (there is only one) or error in parameterization of the sin/cos encoder <ul style="list-style-type: none"> X20 may not be simultaneously programmed as the pulse input with BE1/BE2 or X40 (F31, F31≠14, 15 and H40≠2:encoder In when H20=2, 3 and vice versa). When motor encoder B26=3:SinCos, H40=1:SinCos must be programmed. When motor encoder B26=3:SinCos, neither X20 nor BE1/BE2 may be programmed as the pulse input (encoder or stepper motor).
13: BE cw/ccw	Programming F31=14 and F32=14 can be used to simulate the direction of rotation of inverters with software SDS 3.2. The functions "direction of rotation," "halt," and "quick stop" may not be assigned to other BEs.
14: Canceled	<ul style="list-style-type: none"> The B40/B41 actions could not be executed correctly. Action canceled (e.g., due to removal of enable). The current exceeded the permissible maximum value (e.g., short circuit or ground fault) during "autotuning" or "phase test" (B40, B41).
15: R1 too high	A stator resistance measured during "autotuning" (B41) was too high. Motor is circuited incorrectly. Motor cable is defective.
16: Phase fault U	Error in phase U
17: Phase fault V	Error in phase V
18: Phase fault W	Error in phase W
19: Symmetry	Error in symmetry of phases U, V and W. Deviation of a winding resistor by ±10%.
20: Motor connection	Resolver or motor pole number is not correct.
21: Enable ?	The enable must be present for actions J00/J01/J05 .
22: F20=F25 ??	Both analog inputs (AE1 and AE2) are programmed for the same function. F20-F25 must apply.
25: Phase order	Error in motor wiring (order of the phases, U, V, W incorrect). Is reported as the result of the B40 phase test. <ul style="list-style-type: none"> Check motor wiring and, if necessary, resolver cable too.
26: Encoder offset	The zero offset of the motor encoder (resolver) is not correct. Is reported as the result of the B40 phase test. With STÖBER ES motors, the error is usually to be found in the wiring or in the plug connector. <ul style="list-style-type: none"> Check motor and resolver wiring. Then start phase test (B40) again. If no wiring error can be found, the measured offset is stored (non-volatile) via A00=1 in H32 with all other parameters.

16. Operating States

Operating States		
The operating state is indicated in the display of Controlbox with number and name and can be queried under E80 during fieldbus access. An abbreviation appears in the LED status display of the device.		
0: Ready	rdy	Inverter is ready. Voltage is available.
1: Clockwise	run	Fixed positive speed
2: Counter-clockwise	run	Fixed negative speed
3: Acceleration	run	Acceleration procedure in progress (Accel)
4: Deceleration	run	Deceleration procedure in progress (Decel)
5: Halt	HLF	Halt command present
7: n > n-Max	run	Reference value is greater than minimum of C01 and E126 (via analog input or fieldbus).
8: Illegal direction	dir	Specified direction of rotation is not the permissible direction of rotation (C02).
11: Quick stop	HLF	Quick stop is being performed.
12: Inhibited	INH	This state prevents an undesired startup of the drive. Effective for: <ul style="list-style-type: none"> • Drive is turned on (power on) with enable = high (only if A34=0). • A fault is acknowledged with a low-high change in enable. • Opened load relay (no power or no phase). • If A30=3:SDP 4000 or A30=4:CAN-bus and the fieldbus sends a "disable voltage" control command, or the enable terminal becomes low, or a quick stop is completed.
13: Serial (X3)	run Not always	Parameter A30=1 parameterized. Inverter is controlled by the PC via serial interface.
14: Enabled	EnA	Only available with <i>Drivocom</i> profile. Bus connection.
15: Self test	FTF	Self-test is being performed on inverter.
16: Fault	Exy	Inverter's power pack is disabled. "xy" is the fault code (see chap. 17).
17: Positioning-active	Pos	Position control is active. Waiting for a start command. Basic state of positioning control.
18: Moving	run	Processing a traversing job. Drive is moving. Indicated instead of the states of the speed mode (i.e. <i>accelerate, brake, left and right</i>).
19: Delay	Pos	For process block chaining with defined delay or for repetition of relative movements. During a stop between two sequential jobs, the signal "in position" is generated, but the display shows "delay."
20: Wait	Pos	For process block chaining with defined manual start (i.e., wait for <i>posi.step</i> signal)
21: Referencing	REF	During reference point traversing with posi or synchronous running
22: Tip	run	During manual traversing
23: Interrupted	Pos	After an interrupted process block (i.e., halt or quick stop) with the option of continuing with the <i>posi.step</i> signal. <i>Posi.step</i> is then used to move to the srcinal destination position regardless of whether the drive has been moved in the meantime. The "23:Interrupted" state is retained when the enable is turned off and on while the halt signal is active. A change in enable without the halt signal and manual traversing cause the basic state "17:Posi.active."
24: Reference wait	REF	Wait for <i>posi.start</i> or <i>posi.step</i> signal to trigger reference point traversing after power on (I37=1).
25: Stop input	STP	Drive is positioned on stop input and can only be moved out of this position with manual or reference point traversing.
26: Parameter inhibit	OFF	Enable was deactivated from the PC with software while data was being transferred from the PC to the inverter.

17. Fault / Events

Faults / Events

When faults occur, the inverter is no longer able to control the drive and is disabled. An entry is made in the fault memory (**E40/E41**), and relay 1 (ready for operation) releases. If installed when the fault occurs, the Parabox is written automatically. Certain events (cf. last column of the table below) can be declared via FDS Tool as faults, messages, warnings or not effective.

		Auto Reset	FDS Tool*
31: Short/ground	The hardware overcurrent switch-off is active. • Motor requires too much current from the inverter (e.g., interwinding fault or overload).	√	
34: Hardw. fault	The non-volatile data memory is defective or software version is time-limited.		
35: Watchdog	Monitors the load and functions of the microprocessor This malfunction may also be caused by EMC problems (e.g., shield of the motor cable or PE conductor not connected at all or connected incorrectly).	√	
36: High voltage	DC-link voltage too high • Power too high • Reverse powering of the drive while braking (no brake resistor connected, brake chopper defective, brake chopper deactivated with A20). See chap. 4.6. • Braking resistor with too low resistance value (overcurrent protection). • Automatic ramp extension at U_{max} is possible with A20=1 and A22=0 .	√	
37: n-feedback	Resolver: Wire break or signal level too low Fault can only be acknowledged by turning 24 V off and on! Sin/cos absolute-value encoder: • During device startup - Communication to the device is faulty. - Absolute-value encoder unknown - Communication protocol unknown (neither EnDat® nor HiperFace) • During operation - Wire break or signal level too low - Change in B26		
38: tempDev.sens	The heat dissipater temperature is over the limit value. Cf. E25 . • Temperature of environment/switching cabinet is too high.		
39: TempDev.i2t	The inverter limits the output current to 99% of the nominal current. The i^2t model calculated for the inverter has reached 100% of the thermal load. • Inverter is overloaded. (inverter too small). • Temperature of the environment/switching cabinet is too high. • Closed brake • Motor connected incorrectly • Resolver connected incorrectly		
40: Invalid data	The data in non-volatile memory are incomplete. Reset non-volatile memory with " A00 save values." This loads the default values.		
41: Temp.motorTMP	Excessive temperature indicated by the motor temperature sensor. • Motor is overloaded. Use external ventilation. • Temperature sensor not connected (X40.2 to X40.6)		
42: Temp.brakeRes	The i^2t model for the braking resistor reaches 100% thermal load. • A20 programmed incorrectly • Permissible power loss of brake resistance is too high. • With internal brake resistance: No jumper on X12. → chap. 5.2. • With external brake resistance: Brake resistor not connected.		
44: Ext.fault	Fault triggered by BE		
45: OTempMot.i2t	• Motor overloaded • Cooling insufficient		√
46: Low voltage	DC-link voltage is below the limit value set in A35 . • Drops in the power supply • Acceleration times are too short (ramps, D..).	√	√

* Events can be programmed with FDS Tool as messages, warnings or faults, or can be completely deactivated.

17. Fault / Events

Faults / Events

When faults occur, the inverter is no longer able to control the drive and is disabled. An entry is made in the fault memory (**E40/E41**), and relay 1 (ready for operation) releases. Certain events (cf. last column of the table below) can be declared via FDS Tool as faults, messages, warnings or not effective.

		Auto Reset	FDS Tool*
47: Device overl.	The maximum torque has been exceeded. The permissible torque is limited by parameters C03 and C04 and the possible torque limitation via analog input. See chap. 9.2.	√	√
48: Accel.overl.	Same as "47:Device overload" except for an acceleration procedure. M-Max 2 (C04) is permitted for the acceleration procedure with "cycle characteristic" startup (C20=2).	√	√
49: Decel.overl.	Same as "47:Device overload" except for a deceleration procedure	√	√
50: Operat.area	The operating area defined under C41 to C46 has been exited. See also chap. 9.3.	√	√
51: Refused	Only for positioning (C60=2). <i>Posi.start</i> or <i>posi.step</i> was not accepted. <ul style="list-style-type: none"> • Destination position is located outside software limit switches I50 and I51. • In non-referenced status (I86=0), no absolute positions (e.g., J11=1) are traveled to. • The direction of rotation in the current process block is not the same as the permissible direction I04. 	√	√
52: Communication	<ul style="list-style-type: none"> • Fault during communication between inverter and FDS Tool during remote control via PC • Communication fault during fieldbus operation 	√	
53: Stop input	A limit switch connected via a BE input or monitored via fieldbus has been triggered. During referencing at the limit switch (I30=1), a reversal of the limit switches will cause a fault.	√	
54: Follow. error	The maximum following error (i.e., deviation between actual position and reference value position) permitted by I21 has been exceeded. • Motor overload, too much acceleration or blockage • KV-factor I20 too small; speed feed forward I25 too small	√	√
55: OptionBoard	<ul style="list-style-type: none"> • When option board <i>SEA-4000</i> is used, the external 24 V voltage is not present or the card is defective. No fault if enable is deactivated. • No option card found 		
56: Overspeed	Actual speed exceeds n-Max by more than 15%.		

* The events checked in the "FDS Tool" column can be parameterized with FDS Tool as messages, warnings or faults in the group **U..** protective functions.

Acknowledgment of faults:

- **Enable:** Change from low to high level on the enable input. Always available:
-  key (only if **A31=1**).
- **Auto-reset** (only if **A32=1**).
- **Binary input** (**F31** to **F34=13**).

Caution!
 Drive starts up immediately!

Parameters **E40** and **E41** can be used to scan the last 10 faults (i.e., value 1 is the last fault). FDS Tool can then be used to assign the inverter's reaction (fault, warning, message or nothing) to certain events.

18. Block Circuit Diagram Synchronous Running
19.1 Fast Reference Value active (D99=1)

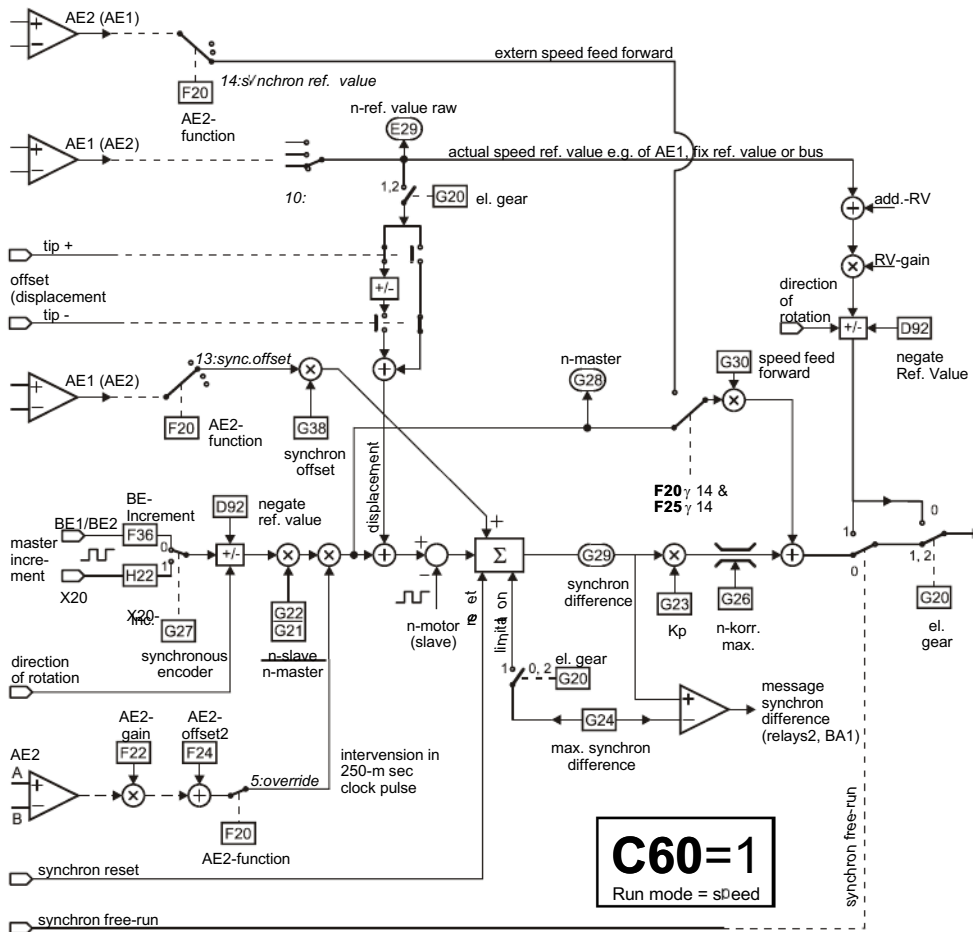

19.1 Block circuit diagram: Fast reference value active (D99=1)

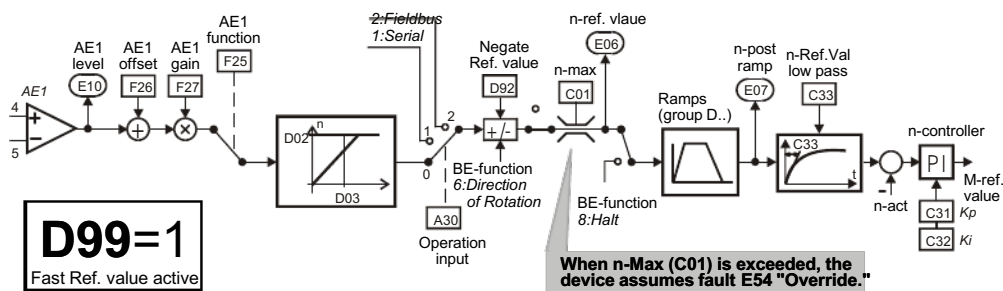

19.2 Block Circuit Diagram Reference Value Processing

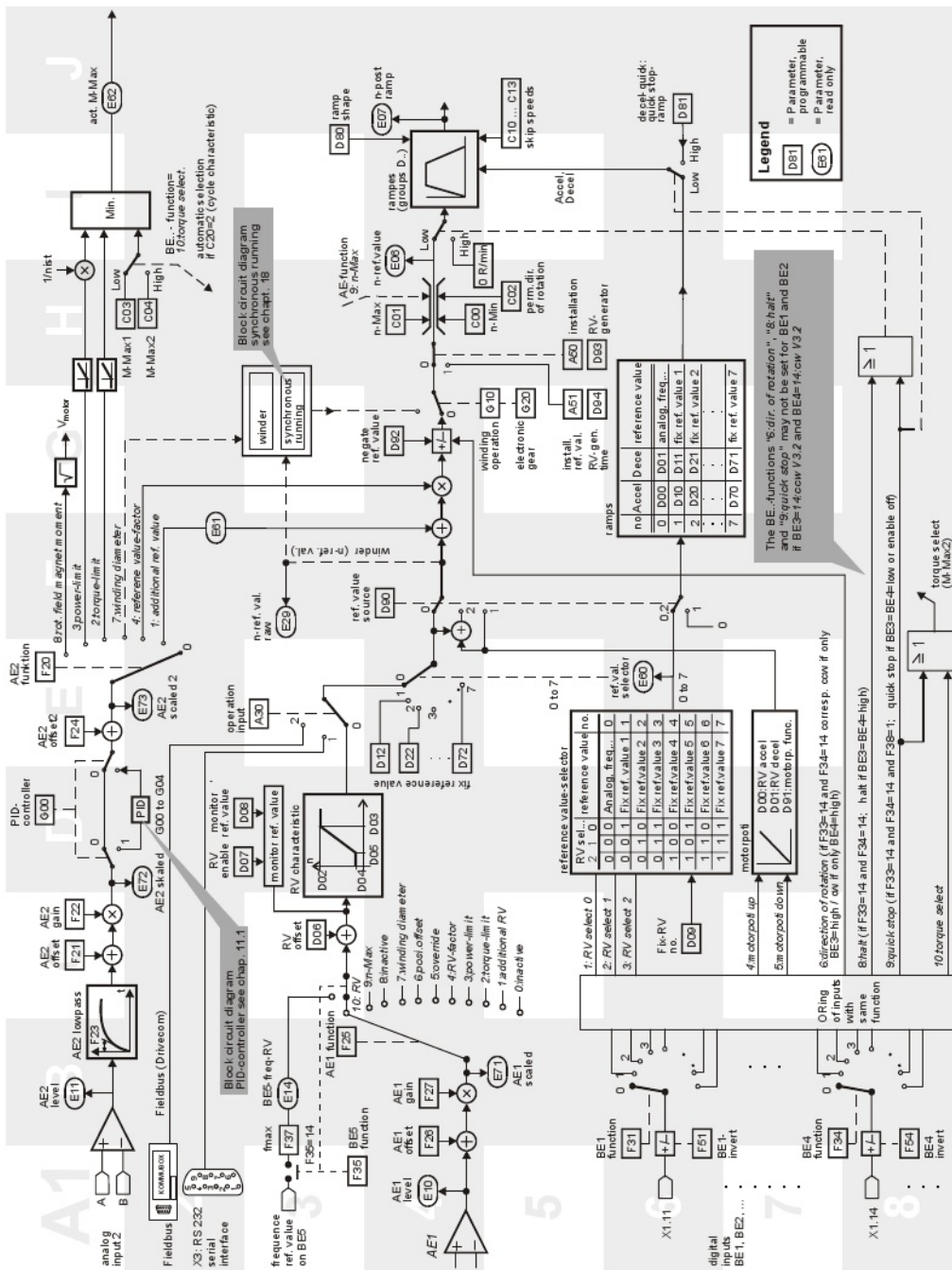

20. Parameter Table

Parameter	DS	Inpt.
A.. Inverter		
A00 Save parameter [%]		
A01 Read parabox & save [%]		
A02 Check parameter [%]		
A03 Write to parabox [%]		
A04 Default settings [%]		
A10 Menu level	0	
A11 Parameter set edit		
A12 Language	0	
A13 Set password		
A14 Edit password		
A15 Auto-return	1	
A20 Braking resistor type	20	
A21 Brak. resistor resist. [Ω]	*	
A22 Brak. resistor rating [kW]	*	
A23 Brak. resistor therm [sec]	40	
A30 Operation input	0	
A31 Esc-reset	1	
A32 Auto-reset	0	
A33 Time auto-reset [min]	15	
A34 Auto-start	0	
A35 Low voltage limit [V]	350	
A36 Mains voltage [V]	400	
A37 Reset memorized values		
A38 DC power-input	0	
A40 Read parabox [%]		
A41 Select parameter set		
A42 Copy para set 1>2 [%]		
A43 Copy para set 2>1 [%]		
A50 Tip		
A51 Tip ref. value [rpm]	300	
A55 Key hand function	1	
A80 Serial address	0	
A82 CAN-baudrate	1	
A83 Busaddress	0	
A84 Profibus baudrate		
B.. Motor		
B00 Motor-type	*	
B02 EMC-constant [V]	110	
B03 Motor fan	0	
B10 Poles	6	
B11 P-nominal [kW]	*	
B12 I-nominal [A]	*	
B13 n-nominal [rpm]	*	
B17 M0 (standstill) [Nm]	*	
B26 Motor-encoder	2	
B40 Phase test [%]		
B52 L-motor [mH]	*	
B53 R1-motor [Ω]	*	
B64 Ki-IQ (Moment) [%]	*	
B65 Kp-IQ (moment) [%]	*	
C.. Machine		
C00 n-Min [rpm]	0	
C01 n-Max [rpm]	3000	
C02 Perm. dir. of rotation	0	
C03 M-Max 1 [%]	150	
C04 M-Max 2 [%]	150	
C30 J-mach/J-motor	0	
C31 n-controller Kp [%]	60	

Parameter	DS	Inpt.
C32 n-controller Ki [%]	30	
C33 n-RefVal low pass [msec]	2	
C34 n-motor low pass [msec]	*	
C35 n-control. Kp standstill [%]	100	
C40 n-window [rpm]	3	
C41 Oper. range n-Min [rpm]	0	
C42 Oper. range n-Max [rpm]	6000	
C43 Operat. range M-Min [%]	0	
C44 Operat. range M-Max [%]	400	
C45 Operat. range x-Min [%]	0	
C46 Operat. range x-Max [%]	400	
C47 Operat. range C45/C46	0	
C48 Operat. range C47 abs	0	
C49 Operat. range accel&ena	0	
C50 Display function	0	
C51 Display factor	1	
C52 Display decimals	0	
C53 Displaytext		
C60 Run mode	1	
D.. Reference value		
D00 RV accel [msec/3000rpm]	0	
D01 RV decel [msec/3000rpm]	0	
D02 Speed (max. ref. value)[rpm]	3000	
D03 Reference value -Max [%]	100	
D04 Speed (min. ref. value)[rpm]	0	
D05 Ref. value-Min [%]	1	
D06 Ref. value offset [%]	0	
D07 Ref. value enable	0	
D08 Monitor ref. value	0	
D09 Fix reference value no.	0	
D10 Accel 1 [msec/3000rpm]	60	
D11 Decel 1 [msec/3000rpm]	60	
D12 Fix ref. value 1 [rpm]	750	
D20 Accel 2 [msec/3000rpm]	90	
D21 Decel 2 [msec/3000rpm]	90	
D22 Fix ref. value 2 [rpm]	1500	
D30 Accel 3 [msec/3000rpm]	120	
D31 Decel 3 [msec/3000rpm]	120	
D32 Fix ref. value 3 [rpm]	3000	
D40 Accel 4 [msec/3000rpm]	5	
D41 Decel 4 [msec/3000rpm]	5	
D42 Fix ref. value 4 [rpm]	500	
D50 Accel 5 [msec/3000rpm]	10	
D51 Decel 5 [msec/3000rpm]	10	
D52 Fix ref. value 5 [rpm]	1000	
D60 Accel 6 [msec/3000rpm]	20	
D61 Decel 6 [msec/3000rpm]	20	
D62 Fix ref. value 6 [rpm]	2000	
D70 Accel 7 [msec/3000rpm]	25	
D71 Decel 7 [msec/3000rpm]	25	
D72 Fix ref. value 7 [rpm]	2500	
D81 Decel-quick[msec/3000rpm]	2	
D90 Reference value source	0	
D91 Motorpoti function	0	
D92 Negate reference value	0	
D93 RV-generator		
D94 Ref. val. generator time [msec]	500	
D99 Fast reference value	1	

Parameter	DS	Inpt.
E.. Display values		
E00 I-motor [A]		
E01 P-motor [kW]		
E02 M-motor [Nm]		
E03 DC-link-voltage [V]		
E06 n-reference value [rpm]		
E07 n-post-ramp [rpm]		
E08 n-motor [rpm]		
E09 Rotor position [r]		
E10 AE1-level [%]		
E11 AE2-level [%]		
E16 Analog-output1-level [%]		
E17 Relay 1		
E18 BA 2		
E19 BE15...BE1 & enable		
E20 Device utilization [%]		
E21 Motor utilization [%]		
E22 i2t-device [%]		
E23 i2t-motor [%]		
E24 i2t-braking resistor [%]		
E25 Device temperature [°C]		
E26 Binary output 1		
E27 BA15..1&Rel1		
E28 Analog-output2-level [%]		
E29 n-ref. value raw [rpm]		
E30 Run time [h,m,sec]		
E31 Enable time [h,m,sec]		
E32 Energy counter [kWh]		
E33 VI-max-memo value [V]		
E34 I-max-memo value [A]		
E35 Tmin-memo value [°C]		
E36 Tmax-memo value [°C]		
E37 Pmin-memo value [kW]		
E38 Pmax-memo value [kW]		
E40 Fault type		
E41 Fault time		
E42 Fault count		
E45 Control word		
E46 Status word		
E47 n-field-bus [rpm]		
E50 Device		
E51 Software-version		
E52 Device-number		
E53 Variant-number		
E54 Option-board		
E55 Identity-number		
E56 Parameter set ident. 1		
E57 Parameter set ident. 2		
E58 Kommubox		
E60 Reference value selector		
E61 Additional ref. value [rpm]		
E62 Actual M-max [%]		
E63 PID-controller limit		
E64 Brake		
E65 PID-error [%]		
E71 AE1 scaled [%]		
E72 AE2 scaled [%]		
E73 AE2 scaled2 [%]		
E80 Operating condition		

20. Parameter Table

Parameter	DS	Inpt.
E81	Event level	
E82	Event name	
E83	Warning time	
E84	Active parameter set	
F.. Control interface		
F00	BA2-function	1
F03	Relay2 t-on [sec]	0
F04	Relay2 t-off [sec]	0
F05	Relay2 invert	0
F06	t-brake release [sec]	0.1
F07	t-brake set [sec]	0.052
F08	Brake	0
F10	Relay1-function	0
F19	Quick stop end	0
F20	AE2-function	0
F21	AE2-offset [%]	0
F22	AE2-gain [%]	100
F23	AE2-lowpass [msec]	0
F24	AE2-offset2 [%]	0
F25	AE1-function	10
F26	AE1-offset [%]	0
F27	AE1-gain [%]	100
F30	BE-logic	0
F31	BE1-function	8
F32	BE2-function	6
F33	BE3-function	9
F34	BE4-function	0
F36	BE5-function	0
F36	BE increment [I/R]	1024
F38	Quick stop	0
F40	Analog-output1-function	4
F41	Analog-output1-offset [%]	0
F42	Analog-output1-gain [%]	100
F43	Analog-output1-absolute	0
F45	Analog-output2-function	1
F46	Analog-output2-offset [%]	0
F47	Analog-output2-gain [%]	50
F49	BE-gear ratio	1
F51	BE1-invert	0
F52	BE2-invert	0
F53	BE3-invert	0
F54	BE4-invert	0
F55	BE5-invert	0
F60	BE6-function	0
F61	BE7-function	0
F62	BE8-function	0
F63	BE9-function	0
F64	BE10-function	0
F65	BE11-function	0
F66	BE12-function	0
F67	BE13-function	0
F68	BE14-function	0
F70	BE6-invert	0
F71	BE7-invert	0
F72	BE8-invert	0
F73	BE9-invert	0
F74	BE10-invert	0
F75	BE11-invert	0
F76	BE12-invert	0

Parameter	DS	Inpt.
F77	BE13-invert	0
F78	BE14-invert	0
F80	BA1-function	1
F81	BA2-function	1
F82	BA3-function	1
F83	BA4-function	1
F84	BA5-function	1
F85	BA6-function	1
F86	BA7-function	1
G.. Technology		
G00	PID-controller	0
G01	PID-controller Kp	0.3
G02	PID-controller Ki [1/sec]	0
G03	PID-controller Kd [msec]	0
G04	PID-controller limit [%]	400
G05	PID-controller limit2 [%]	-400
G06	PID-controller Kp2	1
G10	Winding operation	0
G11	Diameter	0
G12	Min. winding diam. [mm]	10
G13	Max. winding diam. [mm]	100
G14	Beg. winding diam. [mm]	10
G15	Overdrive ref. value [rpm]	0
G16	Diam. calculator ramp [mm/sec]	10
G17	Tension reduction [%]	0
G19	Winding act. diam. [mm]	
G20	Electronic gear	0
G21	Speed master	1
G22	Drehzahl Slave	1
G23	Kp synchron [1/sec]	30
G24	Max. sync. difference [°]	3600
G25	Synchron reset	3
G26	n-correction-Max. [rpm]	3000
G27	Synchronous encoder	0
G28	n-Master [rpm]	
G29	Synchron difference [°]	0
G30	Speed feed forward [%]	80
G31	Reference direction	0
G32	Reference speed fast [rpm]	1000
G33	Reference speed slow [rpm]	300
G35	Ref.encoder signal 0	0
G38	Synchronous offset [°]	0
G40	Static friction torque [Nm]	0
G41	Dyn. friction torque [Nm/100rpm]	0
G42	T-dyn lowpass [msec]	50
H.. Encoder		
H20	X20-function	1
H21	Encodersim. increments	2
H22	X20-increments [I/R]	1024
H23	X20-gear ratio	1
H24	X20-zeroPos. [°]	0
H31	Resolver poles	2
H32	Commutation-offset [°]	0
H40	X41-function	0
H41	X41-increments [I/R]	1024
H42	X41-gear-ratio	1
H60	SSI-invert	0
H61	SSI-Code	0
H62	SSI-databits	25

Parameter	DS	Inpt.
I.. Posi.Machine		
I00	Position range	1
I01	Circular length [I05]	360
I02	Posi-encoder	2
I03	Direction optimization	1
I04	Move direction	0
I05	Measure unit selection	2
I06	Decimal digits	2
I07	Way/rev. numerator [I05]	360
I08	Way/rev. denominator [R]	1
I09	Measurement unit	
I10	Max. speed [I05/sec]	10
I11	Max. accel. [I05/sec²]	10
I12	Tip speed [I05/sec]	180
I15	Accel-override	0
I16	S-ramp [msec]	0
I19	ENA-interrupting	0
I20	Kv-factor [1/sec]	30
I21	Max. following error [I05]	90
I22	Target window [I05]	5
I23	Dead band pos. control [I05]	0
I25	Speed feed forward [%]	80
I30	Reference mode	0
I31	Reference direction	0
I32	Ref. speed fast [I05/sec]	90
I33	Ref. speed slow [I05/sec]	4,5
I34	Reference position [I05]	0
I36	Ref. encoder signal 0	0
I36	Continuous reference	0
I37	Power-on reference	0
I38	Reference block	0
I40	Posi.-step memory	0
I50	Software-stop - [I05]	-10000000
I51	Software-stop + [I05]	10000000
I60	Electr. cam1 begin [I05]	0
I61	Electronic cam1 end [I05]	100
I70	Position-offset [I05]	0
I80	Actual position [I05]	
I81	Target position [I05]	
I82	Active process block	
I83	Selected process block	
I84	Following error [I05]	
I85	In position	
I86	Referenced	
I87	Electronic cam 1	
I88	Speed [I05/sec]	
J.. Posi.Command		
J00	Posi.start	
J01	Posi.step	
J02	Process block number	0
J03	Tip-mode	
J04	Teach-in	
J05	Start reference	

■ = Standard menu level. Cf. par. A10
 Extended menu level: A10-1

WE = Default setting

* = Depends on type

20. Parametertabelle

Parameter		DS	Entry of Process Blocks 1 to 8 (Process blocks 9 to 32 can only be programmed with FDS-Tool)							
			Block 1	Block 2	Block 3	Block 4	Block 5	Block 6	Block 7	Block 8
			J10 to J18	J20 to J28	J30 to J38	J40 to J48	J50 to J58	J60 to J68	J70 to J78	J80 to J88
J..0	Position [105]	0								
J..1	Position mode	0								
J..2	Speed [105/sec]	1000								
J..3	Accel [105/sec ²]	1000								
J..4	Decel [105/sec ²]	1000								
J..5	Repeat number	0								
J..6	Next block	0								
J..7	Next start	0								
J..8	Delay [sec]	0								

Parameter		DS	Entry							
			L.. Posi.Command 2 (Extended Process Block Parameters)							
			L10 to L12	L20 to L22	L30 to L32	L40 to L42	L50 to L52	L60 to L62	L70 to L72	L80 to L82
L..0	Brake	0								
L..1	Switch A	0								
L..2	Switch B	0								







Parameter		DS	Entry			
			M.. Menu skip (Menüsprungziele)			
			Jump to F1 M50 to M52	Jump to F2 M60 to M62	Jump to F3 M70 to M72	Jump to F4 M80 to M82
M50	F1-jump to					
M51	F1-lower limit					
M52	F1-upper limit					

Parameter		DS	Entry			
			N.. Posi.Switches			
			Switch S1 N10 to N14	Switch S2 N20 to N24	Switch S3 N30 to N34	Switch S4 N40 to N44
N..0	S..-position [105]	0				
N..1	S..-method	0				
N..2	S..-memory1	0				
N..3	S..-memory 2	0				
N..4	S..-memory 3	0				

Parameter		DS	Entry
			U..Protective Functions
U00	Level low voltage	3	
U01	Time low voltage	2	
U02	Level temp. limit device i2t	1	
U03	Time temp. limit device i2t	10	
U10	Level temp. limit motor i2t	1	
U11	Time temp. limit motor i2t	30	
U20	Level drive overload	1	
U21	Time drive overload	10	
U22	Text drive overload	drive overload	
U30	Level acceleration overload	1	
U31	Time acceleration overload	5	
U32	Text acceleration overload	acceleration overload	
U40	Level break overload	1	
U41	Time break overload	5	
U42	Text break overload	break overload	
U50	Level operating range	1	
U51	Time operating range	10	
U52	Text operating range	operating range	
U60	Level following error	3	
U61	Time following error	500	
U70	Level posi. refused	1	

- = Standard menu level. Cf. par. **A10**
Extended menu level: **A10=1**
- WE** = Default setting
- *** = Depends on type

21.1 Accessories overview

	Id. No.	Designation	Remark
	42604	Option board SEA4000 In addition: 10 binary inputs and 5 binary outputs.	Chap. 14.1
	42605	Option board DP4000 Profibus-DP link	Chap. 14.1
	42559	Option board DP4000 and SEA4000 (combi board) In addition: 10 binary inputs and 5 binary outputs plus Profibus-DP link.	Profibus-DP documentations: Publ. no. 441525 (german) Publ. no. 441535 (english)
	---	CAN-Bus link integrated	CAN bus documentation: Publ. no. 441532 (german) Publ. no. 441562 (english)
	42940	Master-slave connection (prefabricated) Connection of the incremental encoder interface on the configuration output of the master drive to the incremental encoder interface on the configuration input of the slave.	Chap. 11.2
	44087	CD WELT DER ELEKTRONIK This CD-ROM contains: <ul style="list-style-type: none"> • Sample applications, • Documentation, • FDS-Tool (PC programm for programming, operation and observation of the inverters) • Fieldbus datas 	Download from: http://www.stoerber.de FDS-Tool documentation: Publ. no. 441349 (german) Publ. no. 441409 (english)
	41488	Connection cable G3 PC <-> FDS connection cable with 9-pin sub D plug connector, plug connector/socket	Chap. 9.9

Id. No.	Designation	Remark
	<p>42224 External operator, CONTROLBOX Operating unit for parameterisation and operation of the inverters. Connecting lead (2 m) is included in the scope of supply.</p>	<p>Controlbox documentation: Publ. no. 441445 (german) Publ. no. 441479 (englisch) Publ. no. 441651 (french)</p> <p>Additional cables: 5 m = Id.-no. 43216 10 m = Id.-no. 43217</p>
	<p>42225 External operator, in a built-in DIN housing 96x96 mm see above Protection rating IP54</p>	
	<p>42558 PC adapter with power pack Power supply for Controlbox for direct data exchange with the PC.</p>	<p>Chap. 7</p>
	<p>42583 PC adapter with PS/2 connector Power supply via PS/2 interface for Controlbox for direct data exchange with the laptop.</p>	<p>Chap. 7</p>

21. Accessories

21.2 Braking resistor

21.2.1 Allocation of braking resistor to SDS

Type	Id. No.	FZT			FZZT		FZDT	VHPR ^c 	VHPR
		300x45 300 W 80 Ω	400x65 600 W >30 Ω	400x65 600 W 20 Ω	400x65 1200 W 30 Ω	400x65 1200 W 20 Ω	500x65 2500 W 20 Ω	VHPR150V 150 W 100 Ω	VHPR600V 600 W 100 Ω
		41730	41641	41648	41643	41651	41653	45973	44316
SDS 4011	42227	X	-	-	-	-	-	X	-
SDS 4021	42228	X	-	-	-	-	-	X	-
SDS 4041	42229	X	X	-	X	-	-	-	X
SDS 4071	42230	X	X	-	X	-	-	-	X
SDS 4101	42961	X	X	-	X	-	-	-	X
SDS 4141	42231	X	X	-	X	-	-	-	X
SDS 4281	43481	-	-	X	-	X	X	-	-
SDS 4481	43482	-	-	X	-	X	X	-	-

21.2.2 Braking resistor FZT / FZZT (dimensions)

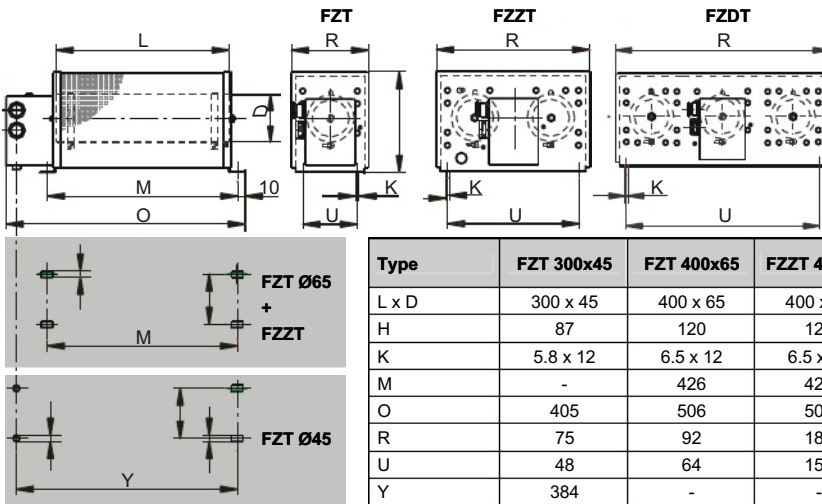

Type	FZT 300x45	FZT 400x65	FZZT 400x65	FZDT 500x65
L x D	300 x 45	400 x 65	400 x 65	500 x 65
H	87	120	120	120
K	5.8 x 12	6.5 x 12	6.5 x 12	6.5 x 12
M	-	426	426	526
O	405	506	506	606
R	75	92	185	275
U	48	64	150	240
Y	384	-	-	-
Weight [kg]	approx. 1.5	approx. 2.6	approx. 4.6	approx 7.8

[dimensions in mm]

21.2.3 Braking resistor VHPR (dimensions)

Type	VHPR150V 150 W, 100 Ω	VHPR600V 600 W, 100 Ω
L	212	420
C	193	400
B	40	60
A	21	31
D	4.3	5.3
E	8	11.5
F	13	19.5
Weight [g]	approx. 310	approx. 1300

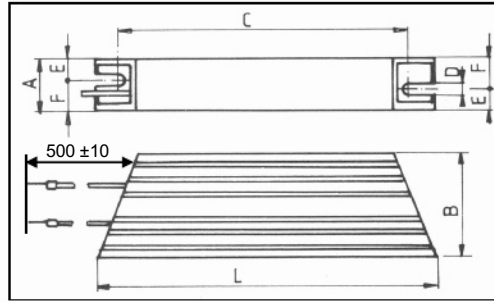

[dimensions in mm]

21.3 Input filter (dimensions)

Type	Id. No.	Input filter for radio-interference level „B“
SDS 4011	42227	FS 4834-10-29, 10 A _{eff} [28203]
SDS 4021	42228	
SDS 4041	42229	
SDS 4071	42230	
SDS 4101	42961	FS 4835-25-29, 25 A _{eff} [28204]
SDS 4141	42231	

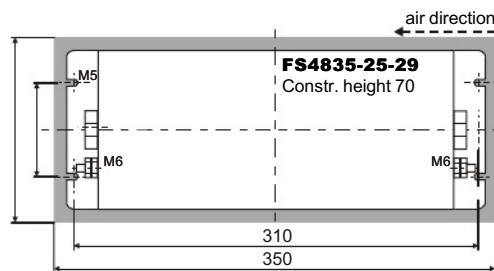
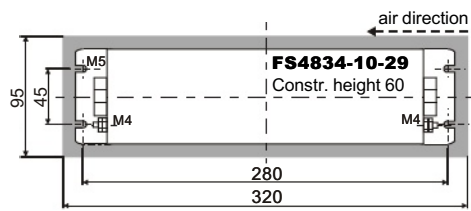

[dimensions in mm]

21.4 Output derating (dimensions)

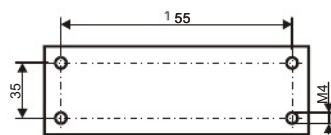

Output derating AD 320 (complete)	
Id. No.	99860
Rated current	max. 3 x 20 A
Frequency	8.3 kHz
Inductance	1.2 mH

**Additional information under:
<http://www.stoeber.de>**

STÖBER . . . The Drive for Your Automation

 STÖBER ANTRIEBSTECHNIK GmbH + Co. KG GERMANY Kieselbronner Strasse 12 · 75177 Pforzheim Postfach 910103 · 75091 Pforzheim Fon +49 (0) 7231 582-0, Fax +49 (0) 7231 582-1000 Internet: http://www.stoeber.de / e-Mail: mail@stoeber.de
--

Presented by:

© 2008 STÖBER ANTRIEBSTECHNIK GmbH + Co. KG
Publication no. 441449.02.02 · 062 008
- Subject to change without prior notice -