

Automation Panel 1000

User's manual

Version: **1.10 (January 2018)**
Model no.: **MAAP1000-ENG**

Translation of the original manual

The values and specifications listed in this manual are current as of its publication. We reserve the right to change the contents of this manual without notice. Bernecker + Rainer Industrie-Elektronik Ges.m.b.H. is not liable for technical/editorial errors and/or any incomplete information in this manual. In addition, Bernecker + Rainer Industrie-Elektronik Ges.m.b.H. shall not be liable for any incidental or consequential damages in connection with or arising from the furnishing, performance or use of the product(s) in this documentation. Software names, hardware names and trademarks are registered by their respective companies.

Chapter 1: General information

Chapter 2: Technical data

Chapter 3: Commissioning

Chapter 4: Software

Chapter 5: Standards and certifications

Chapter 6: Accessories

Chapter 7: Servicing and maintenance

Appendix A

Chapter 1 General information.....	8
1 Manual history.....	8
2 Safety guidelines.....	10
2.1 Intended use.....	10
2.2 Protection against electrostatic discharge.....	10
2.2.1 Packaging.....	10
2.2.2 Guidelines for proper ESD handling.....	10
2.3 Policies and procedures.....	10
2.4 Transport and storage.....	11
2.5 Installation.....	11
2.6 Operation.....	11
2.6.1 Protection against touching electrical parts.....	11
2.6.2 Environmental conditions - Dust, moisture, corrosive gases.....	11
2.6.3 Viruses and dangerous programs.....	12
2.7 Environmentally friendly disposal.....	12
2.7.1 Separation of materials.....	12
3 Organization of safety notices.....	13
4 Guidelines.....	13
5 Overview.....	14
 Chapter 2 Technical data.....	 16
1 Introduction.....	16
1.1 About this user's manual.....	16
1.2 Description of individual modules.....	16
1.2.1 AP1000 panels.....	16
1.2.2 Link modules.....	16
1.3 System components / Configuration.....	17
1.3.1 Configuration.....	17
2 Complete system.....	18
2.1 Connection options.....	18
2.1.1 SDL operation.....	18
2.1.2 DVI operation.....	20
2.1.3 SDL3 mode.....	21
2.1.4 SDL4 operation.....	22
2.2 Mechanical characteristics.....	23
2.2.1 Dimensions.....	23
2.2.2 Installation diagrams.....	25
2.2.3 Spacing for air circulation.....	27
2.2.4 Mounting orientations.....	28
2.2.5 Weight specifications.....	30
2.3 Environmental characteristics.....	31
2.3.1 Temperature specifications.....	31
2.3.2 Humidity.....	35
2.3.3 Vibration.....	35
2.3.4 Shock.....	35
2.3.5 Protection.....	36
2.4 Electrical characteristics.....	37
2.4.1 +24 VDC power supply.....	37
2.4.2 Power calculation.....	38
2.4.3 Block diagrams.....	39
2.5 SDL/DVI receiver - 5DLSDL.1001-00 device interfaces.....	40
2.5.1 Overview.....	40
2.5.2 +24 VDC power supply.....	41
2.5.3 Panel In interface.....	42
2.5.4 USB interfaces.....	44
2.5.5 USB In interface.....	45
2.5.6 COM serial interface.....	45

2.5.7 Brightness controls.....	45
2.6 5DLSD3.1001-00 SDL3 receiver - Device interfaces.....	46
2.6.1 Overview.....	46
2.6.2 +24 VDC power supply.....	47
2.6.3 SDL3 In interface.....	48
2.6.4 SDL3 In LEDs.....	48
2.6.5 USB interfaces.....	49
2.7 5DLSD4.1001-00 SDL4 receiver - Device interfaces.....	50
2.7.1 Overview.....	50
2.7.2 +24 VDC power supply.....	51
2.7.3 SDL4 In interface.....	52
2.7.4 SDL4 In LEDs.....	52
2.7.5 USB interfaces.....	53
2.8 Features of AP1000 panels.....	54
2.8.1 Slide-in labels.....	54
2.8.2 Key and LED configuration.....	55
2.8.3 USB interface.....	59
2.9 Mounting compatibility.....	60
2.9.1 Compatibility overview.....	60
2.9.2 Compatibility details.....	62
3 Individual components.....	70
3.1 Panels.....	70
3.1.1 5AP1120.0573-000.....	70
3.1.2 5AP1151.0573-000.....	73
3.1.3 5AP1120.0702-000.....	76
3.1.4 5AP1130.0702-000.....	78
3.1.5 5AP1120.101E-000.....	80
3.1.6 5AP1130.101E-000.....	82
3.1.7 5AP1120.1043-000.....	84
3.1.8 5AP1180.1043-000.....	87
3.1.9 5AP1181.1043-000.....	90
3.1.10 5AP1182.1043-000.....	93
3.1.11 5AP1120.1214-000.....	96
3.1.12 5AP1120.121E-000.....	99
3.1.13 5AP1130.121E-000.....	101
3.1.14 5AP1120.1505-000.....	103
3.1.15 5AP1180.1505-000.....	106
3.1.16 5AP1181.1505-000.....	109
3.1.17 5AP1120.156B-000.....	113
3.1.18 5AP1130.156C-000.....	115
3.1.19 5AP1130.185C-000.....	117
3.1.20 5AP1120.1906-000.....	119
3.2 Link modules.....	122
3.2.1 5DLSDL.1001-00.....	122
3.2.2 5DLSD3.1001-00.....	124
3.2.3 5DLSD4.1001-00.....	126
Chapter 3 Commissioning.....	127
1 Installation.....	127
1.1 Important information concerning installation/commissioning.....	127
1.2 Mounting an Automation Panel 1000 with retaining clips.....	129
1.3 Mounting an Automation Panel 1000 with clamping blocks.....	131
1.4 Replacing link modules.....	133
2 Connecting to the power grid.....	134
2.1 Installing the DC power cable.....	134
2.1.1 Wiring.....	134
2.2 Connecting the power supply to a B&R device.....	135

2.3 Functional ground - Grounding concept.....	136
3 Cable connections.....	137
4 Switching on the device for the first time.....	138
4.1 General information before switching on the device.....	138
4.2 Switching on the Automation Panel.....	138
5 Touch screen calibration.....	139
5.1 Single-touch (analog resistive).....	139
5.1.1 Windows 10 IoT Enterprise 2016 LTSC.....	139
5.1.2 Windows 10 IoT Enterprise 2015 LTSC.....	139
5.1.3 Windows Embedded 8.1 Industry Pro.....	139
5.1.4 Windows 7 Professional / Ultimate.....	139
5.1.5 Windows Embedded Standard 7 Embedded / Premium.....	139
5.1.6 Windows XP Professional.....	139
5.1.7 Windows Embedded Standard 2009.....	139
5.2 Multi-touch (projected capacitive - PCT).....	140
5.2.1 Windows 10 IoT Enterprise 2016 LTSC.....	140
5.2.2 Windows 10 IoT Enterprise 2015 LTSC.....	140
5.2.3 Windows Embedded 8.1 Industry Pro.....	140
5.2.4 Windows 7 Professional / Ultimate.....	140
5.2.5 Windows Embedded Standard 7 Premium.....	140
6 Adjusting the display brightness.....	141
6.1 Adjusting in SDL / SDL3 / SDL4 mode.....	141
6.2 Adjusting in DVI mode.....	141
Chapter 4 Software.....	142
1 Upgrade information.....	142
1.1 Upgrading the firmware on the Automation Panel.....	142
2 Multi-touch drivers.....	142
3 Automation Runtime.....	143
3.1 General information.....	143
3.2 Automation Runtime Embedded (ARemb).....	143
4 B&R Automation Device Interface (ADI) Control Center.....	144
4.1 Functions.....	144
4.2 Installation.....	145
5 B&R Automation Device Interface (ADI) Development Kit.....	146
6 B&R Automation Device Interface (ADI) .NET SDK.....	147
7 B&R Key Editor.....	148
8 B&R KCF Editor.....	149
9 HMI Service Center.....	149
9.1 5SWUTI.0001-000.....	149
9.1.1 General information.....	149
9.1.2 Order data.....	150
Chapter 5 Standards and certifications.....	151
1 Standards and guidelines.....	151
1.1 CE marking.....	151
1.2 EMC directive.....	151
2 Certifications.....	152
2.1 UL certification.....	152
2.2 GOST-R.....	152
2.3 EAC.....	152
2.4 KC.....	153
2.5 RCM.....	153
2.6 DNV GL certification (Det Norske Veritas Germanischer Lloyd).....	153
2.6.1	153
2.7 UL Haz. Loc. certification.....	154
2.7.1 General safety guidelines.....	154

2.7.2 Mounting and installation.....	154
2.7.3 Operation.....	155
2.7.4 Maintenance, breakdowns and disassembly.....	155
2.7.5 USB connection with the Automation Panel 1000.....	156
2.7.6 USB connection with the SDL or SDL3 link module.....	158
Chapter 6 Accessories.....	160
1 Power connectors.....	160
1.1 0TB103.9x.....	160
1.1.1 General information.....	160
1.1.2 Order data.....	160
1.1.3 Technical data.....	160
2 USB flash drives.....	162
2.1 5MMUSB.xxxx-01.....	162
2.1.1 General information.....	162
2.1.2 Order data.....	162
2.1.3 Technical data.....	162
2.1.4 Temperature/Humidity diagram.....	163
2.2 5MMUSB.032G-02.....	164
2.2.1 General information.....	164
2.2.2 Order data.....	164
2.2.3 Technical data.....	164
2.2.4 Temperature/Humidity diagram.....	165
3 Cables.....	166
3.1 DVI cables.....	166
3.1.1 5CADVI.0xxx-00.....	166
3.2 SDL cables.....	169
3.2.1 5CASDL.0xxx-00.....	169
3.3 SDL cables with 45° male connector.....	172
3.3.1 5CASDL.0xxx-01.....	172
3.4 SDL flex cables.....	175
3.4.1 5CASDL.0xxx-03.....	175
3.5 SDL flex cables with extender.....	180
3.5.1 5CASDL.0xx0-13.....	180
3.6 SDL3/SDL4 cables.....	184
3.6.1 5CASD3.xxxx-00.....	184
3.7 USB cables.....	187
3.7.1 5CAUSB.00xx-00.....	187
3.8 RS232 cables.....	189
3.8.1 9A0014.xx.....	189
4 Line filter.....	191
4.1 5AC804.MFLT-00.....	191
4.1.1 General information.....	191
4.1.2 Order data.....	191
4.1.3 Technical data.....	191
4.1.4 Dimensions.....	192
4.1.5 Drilling template.....	192
4.1.6 Connecting to the end device.....	192
5 Clamping blocks.....	193
5.1 5AC900.BLOC-00.....	193
5.1.1 General information.....	193
5.1.2 Order data.....	193
5.2 5AC900.BLOC-01.....	193
5.2.1 General information.....	193
5.2.2 Order data.....	193
6 USB interface cover.....	194
6.1 5AC900.1201-00.....	194

6.1.1 General information.....	194
6.1.2 Order data.....	194
6.2 5AC900.1201-01.....	194
6.2.1 General information.....	194
6.2.2 Order data.....	194
Chapter 7 Servicing and maintenance.....	195
1 Cleaning.....	195
2 Tips for extending the service life of the display.....	196
2.1 Backlight.....	196
2.1.1 How can the service life of backlights be extended?.....	196
2.2 Image persistence.....	196
2.2.1 What causes image persistence?.....	196
2.2.2 How can image persistence be reduced?.....	196
3 Pixel errors.....	196
4 Repairs, complaints and replacement parts.....	196
Appendix A	197
1 Abbreviations.....	197
2 Viewing angles.....	197
3 Chemical resistance.....	198
3.1 Autotex panel overlay (polyester).....	199
3.2 Coated aluminum front.....	200
3.3 Touch screen.....	201
4 Touch screen.....	202
4.1 5-wire AMT touch screen (single-touch).....	202
4.1.1 Technical data.....	202
4.1.2 Temperature/Humidity diagram.....	202
4.2 3M touch screen (multi-touch generation 3).....	203
4.2.1 Technical data.....	203
4.2.2 Temperature/Humidity diagram.....	203

Chapter 1 • General information

Information:

This user's manual is not intended for end customers! It is the responsibility of the machine manufacturer or system provider to provide the safety guidelines relevant to end customers in the operating instructions for the end customer in the respective local language.

1 Manual history

Version	Date	Change
0.10 PRELIMINARY	2015-06-11	<ul style="list-style-type: none"> • First version
0.20 PRELIMINARY	2015-06-29	<ul style="list-style-type: none"> • Updated the following display units: <ul style="list-style-type: none"> ◦ "5AP1120.0573-000" on page 70 ◦ "5AP1120.0702-000" on page 76 ◦ "5AP1120.1043-000" on page 84 ◦ "5AP1120.1214-000" on page 96 ◦ "5AP1120.1906-000" on page 119 ◦ "5AP1151.0573-000" on page 73 ◦ "5AP1180.1043-000" on page 87 ◦ "5AP1181.1043-000" on page 90 ◦ "5AP1182.1043-000" on page 93
0.30 PRELIMINARY	2015-09-16	<ul style="list-style-type: none"> • Updated the following display units: <ul style="list-style-type: none"> ◦ "5AP1120.101E-000" on page 80 ◦ "5AP1120.121E-000" on page 99 ◦ "5AP1120.156B-000" on page 113 • Updated data in sections "Mechanical characteristics", "Environmental characteristics" and "Electrical characteristics".
0.40 PRELIMINARY	2015-10-12	<ul style="list-style-type: none"> • Updated information about the complete system, see "Mechanical characteristics", "Environmental characteristics" and "Electrical characteristics".
0.50 PRELIMINARY	2015-11-02	<ul style="list-style-type: none"> • Modified technical data for display unit "5AP1120.121E-000" on page 99. • Updated information about the complete system, see "Environmental characteristics".
1.00	2015-12-15	<ul style="list-style-type: none"> • Updated temperature/humidity diagrams for "Panels" on page 70. • Updated UL 50 rating "Front: Type 4X indoor use only" for "Panels" and in section "Protection" on page 36. • Updated information about the complete system, see "Environmental characteristics".
1.05	2016-09-27	<ul style="list-style-type: none"> • Updated chapter 5 "Standards and certifications", updated DNV GL. • Updated section "+24 VDC power supply" on page 37. • Updated section "HMI Service Center" on page 149. • Updated the following display units: <ul style="list-style-type: none"> ◦ "5AP1130.0702-000" on page 78 ◦ "5AP1130.101E-000" on page 82 ◦ "5AP1130.121E-000" on page 101 • Updated data in sections "Mechanical characteristics", "Environmental characteristics" and "Electrical characteristics". • Updated the following accessories: <ul style="list-style-type: none"> ◦ Clamping blocks "5AC900.BLOC-00" on page 193 ◦ Clamping blocks "5AC900.BLOC-01" on page 193 ◦ USB interface cover "5AC900.1201-00" on page 194 ◦ USB interface cover "5AC900.1201-01" on page 194 ◦ Line filter "5AC804.MFLT-00" on page 191
1.06	2016-10-21	<ul style="list-style-type: none"> • Updated "Maximum ambient temperature during operation" on page 31.
1.08	2017-03-10	<ul style="list-style-type: none"> • Renamed "display units" to "panels". • Updates sections "Multi-touch drivers" on page 142, "Automation Runtime Embedded (ARemb)" on page 143 and "B&R Key Editor" on page 148. • Documented the following panel: <ul style="list-style-type: none"> ◦ "5AP1130.156C-000" on page 115 ◦ "5AP1130.185C-000" on page 117 • Updated data in sections "Mechanical characteristics", "Environmental characteristics" and "Electrical characteristics".

Version	Date	Change
1.10	2018-01-15	<ul style="list-style-type: none">• Updated chapter 2 "Technical data".• Revised section "Installation" on page 127.• Documented the following individual components:<ul style="list-style-type: none">◦ "5AP1181.1505-000" on page 109◦ "5DLS4.1001-00" on page 126• Updated the following sections:<ul style="list-style-type: none">◦ "DNV GL certification (Det Norske Veritas Germanischer Lloyd)" on page 153◦ "UL Haz. Loc. certification" on page 154◦ "B&R Automation Device Interface (ADI) Control Center" on page 144◦ "B&R Automation Device Interface (ADI) Development Kit" on page 146◦ "B&R Automation Device Interface (ADI) .NET SDK" on page 147◦ "B&R Key Editor" on page 148◦ "Touch screen calibration" on page 139◦ "5CASDL.0xxx-03" on page 175◦ "5CASDL.0xx0-13" on page 180• Updated section "Repairs, complaints and replacement parts" on page 196.

2 Safety guidelines

2.1 Intended use

Programmable logic controllers (PLCs), operating/monitoring devices (industrial PCs, Power Panels, Mobile Panels, etc.) and uninterruptible power supplies from B&R have been designed, developed and manufactured for conventional use in industrial environments. They were not designed, developed and manufactured for any use involving serious risks or hazards that could lead to death, injury, serious physical impairment or loss of any kind without the implementation of exceptionally stringent safety precautions. In particular, this includes the use of these devices to monitor nuclear reactions in nuclear power plants, in flight control or flight safety systems as well as in the control of mass transportation systems, medical life support systems or weapons systems.

2.2 Protection against electrostatic discharge

Electrical components that can be damaged by electrostatic discharge (ESD) must be handled accordingly.

2.2.1 Packaging

- **Electrical components with a housing**
...do not require special ESD packaging but must be handled properly (see "Electrical components with a housing").
- **Electrical components without a housing**
...are protected by ESD-suitable packaging.

2.2.2 Guidelines for proper ESD handling

Electrical components with a housing

- Do not touch the connector contacts on connected cables.
- Do not touch the contact tips on circuit boards.

Electrical components without a housing

The following points apply in addition to the points listed under "Electrical components with a housing":

- Any persons handling electrical components or devices with installed electrical components must be grounded.
- Components are only permitted to be touched on their narrow sides or front plate.
- Components must always be placed on or stored in a suitable medium (ESD packaging, conductive foam, etc.). Metallic surfaces are not suitable storage surfaces!
- Components must not be subjected to electrostatic discharge (e.g. caused by charged plastics).
- Observe a minimum distance of 10 cm from monitors and television sets.
- Measuring instruments and equipment must be grounded.
- Probe tips of galvanically isolated measuring instruments must be temporarily discharged on suitably grounded surfaces before taking measurements.

Individual components

- ESD protective measures for individual components are thoroughly implemented at B&R (conductive floors, footwear, arm bands, etc.).
- Increased ESD protective measures for individual components are not required for handling B&R products at customer locations.

2.3 Policies and procedures

Electronic devices are never completely failsafe. If the programmable logic controller, operating/monitoring device or uninterruptible power supply fails, the user is responsible for ensuring that other connected devices such as motors are brought to a safe state.

When using programmable logic controllers or operating/monitoring devices as control systems in connection with a Soft PLC (e.g. B&R Automation Runtime or comparable product) or Slot PLC (e.g. B&R LS251 or comparable product), safety precautions relevant to industrial control systems (e.g. the provision of safety devices such as emergency stop, etc.) must be observed in accordance with applicable national and international regulations. This also applies to all other devices connected to the system, such as drives.

All tasks such as the installation, commissioning and servicing of devices are only permitted to be carried out by qualified personnel. Qualified personnel are those familiar with the transport, mounting, installation, commissioning and operation of devices who also have the appropriate qualifications to perform these tasks (e.g. IEC 60364). National accident prevention regulations must be observed.

The safety notices, information about connection conditions (nameplate and documentation) and limit values specified in the technical data must be read carefully before installation and commissioning and are to be observed in all cases.

2.4 Transport and storage

During transport and storage, devices must be protected against undue stress (mechanical loads, temperature, moisture, corrosive atmospheres, etc.).

2.5 Installation

- Devices are not ready for use immediately upon delivery. They must be installed and wired according to the requirements of this documentation in order for EMC limit values to be observed.
- Installation must be performed according to this documentation using suitable equipment and tools.
- Devices are only permitted to be installed by qualified personnel and when the power is switched off. Before installation, voltage to the control cabinet must be switched off and prevented from being switched on again.
- General safety guidelines and national accident prevention regulations must be observed.
- Electrical installation must be carried out in accordance with applicable guidelines (e.g. wire cross sections, fuses, protective ground connections).

2.6 Operation

2.6.1 Protection against touching electrical parts

To operate programmable logic controllers, operating/monitoring devices and uninterruptible power supplies, certain components must carry dangerous voltage levels over 42 VDC. Touching one of these components can result in a life-threatening electric shock. This could lead to death, severe injury or damage to property.

Before switching on programmable logic controllers, operating/monitoring devices or the uninterruptible power supply, it must be ensured that the housing is properly connected to ground (PE rail). Ground connections must also be established when the operating/monitoring device or uninterruptible power supply is connected for test purposes or only being operated for a short period of time!

Before switching on the device, all voltage-carrying components must be securely covered. During operation, all covers must remain closed.

2.6.2 Environmental conditions - Dust, moisture, corrosive gases

The use of operating/monitoring devices (e.g. industrial PCs, Power Panels, Mobile Panels) and uninterruptible power supplies in very dusty environments must be avoided. The collection of dust on devices can affect functionality and may prevent sufficient cooling, especially in systems with active cooling (fans).

The presence of corrosive gases can also result in impaired functionality. In combination with high temperature and humidity, corrosive gases – e.g. with sulfur, nitrogen and chlorine components – can induce chemical reactions that can damage electronic components very quickly. The presence of corrosive gases is indicated by blackened copper surfaces and cable ends on existing installations.

When operated in dusty or moist environments that could potentially impair functionality, operating/monitoring devices such as the Automation Panel and Power Panel are protected on the front against the ingress of dust or moisture when installed properly (e.g. cutout installation). The back of all devices must be protected from the ingress of dust and moisture, however; any collected dust must be removed at suitable intervals.

2.6.3 Viruses and dangerous programs

This system is subject to potential risk each time data is exchanged or software is installed from a data storage device (e.g. diskette, CD-ROM, USB flash drive, etc.), network connection or the Internet. The user is responsible for assessing these risks, implementing preventive measures such as virus protection programs, firewalls, etc. and making sure that software is obtained only from trusted sources.

2.7 Environmentally friendly disposal

All programmable controllers, operating/monitoring devices and uninterruptible power supplies from B&R are designed to minimize harm to the environment as far as possible.

2.7.1 Separation of materials

It is necessary to separate out the different materials so that devices can undergo an environmentally friendly recycling process.

Component	Disposal
Programmable logic controllers Operating/Monitoring devices Uninterruptible power supply Batteries and rechargeable batteries Cables	Electronics recycling
Cardboard/Paper packaging	Paper/Cardboard recycling
Plastic packaging material	Plastic recycling

Table 1: Environmentally friendly disposal

Disposal must take place in accordance with applicable legal regulations.

3 Organization of safety notices

Safety notices in this manual are organized as follows:

Safety notice	Description
Danger!	Failure to observe these safety guidelines and notices can result in death, severe injury or substantial damage to property.
Warning!	Failure to observe these safety guidelines and notices can result in severe injury or substantial damage to property.
Caution!	Failure to observe these safety guidelines and notices can result in injury or damage to property.
Information:	These instructions are important for avoiding malfunctions.

Table 2: Description of the safety notices used in this documentation

4 Guidelines

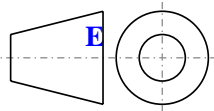

European dimension standards apply to all dimension diagrams.

All dimensions are specified in mm.

Unless otherwise specified, the following general tolerances apply:

Range of nominal size	General tolerance per DIN ISO 2768 (medium)
Up to 6 mm	±0.1 mm
6 to 30 mm	±0.2 mm
30 to 120 mm	±0.3 mm
120 to 400 mm	±0.5 mm
400 to 1000 mm	±0.8 mm

Table 3: Range of nominal sizes

5 Overview

Model number	Short description	Page
	Accessories	
0TB103.9	Connector 24 VDC - 3-pin female - Screw clamp terminal block 3.31 mm ²	160
0TB103.91	Connector 24 VDC - 3-pin female - Cage clamp terminal block 3.31 mm ²	160
5AC804.MFLT-00	Line filter	191
5AC900.1201-00	USB interface cover M20 IP65 flat	194
5AC900.1201-01	USB interface cover M20 IP65 curved	194
5AC900.BLOC-00	Terminal block with brackets, 10 pcs.; replacement part	193
5AC900.BLOC-01	Clamping block without brackets, 10 pcs.; replacement part	193
5SWUTI.0001-000	HMI Service Center USB flash drive - Hardware diagnostic software - For APC810/PPC800 - For APC910/PPC900 - For APC2100/PPC2100 - For APC51x/PP500 - For Automation Panel 800/900	150
	DVI cables	
5CADVI.0018-00	DVI-D cable - 1.8 m	166
5CADVI.0050-00	DVI-D cable - 5 m	166
5CADVI.0100-00	DVI-D cable - 10 m	166
	Link modules	
5DLS3.1001-00	Automation Panel link module - SDL3 receiver - For Automation Panel 923/933/1000 - For Automation Panel 5000	124
5DLS4.1001-00	Automation Panel link module - SDL4 receiver - For Automation Panel 923/933/1000 - For Automation Panel 5000	126
5DLSDL.1001-00	Automation Panel link module - SDL/DVI receiver - For Automation Panel 923/933/1000 - For Automation Panel 5000	122
	Panels	
5AP1120.0573-000	Automation Panel 5.7" VGA TFT - 640 x 480 pixels (4:3) - Single-touch (analog resistive) - Control cabinet installation - Landscape format - For PPC2100 / link modules - Installation compatible with 5PP520.0573-00	70
5AP1120.0702-000	Automation Panel 7" WVGA TFT - 800 x 480 pixels (16:10) - Single-touch (analog resistive) - Control cabinet installation - Landscape format - For PPC2100 / link modules - Compatible with 5PP520.0702-00	76
5AP1120.101E-000	Automation Panel 10.1" WXGA TFT - 1280 x 800 pixels (16:10) - Single-touch (analog resistive) - Control cabinet installation - Landscape format - For PPC2100 / PPC3100 / link modules	80
5AP1120.1043-000	Automation Panel 10.4" VGA TFT - 640 x 480 pixels (4:3) - Single-touch (analog resistive) - Control cabinet installation - Landscape format - Front USB - For PPC900 / PPC2100 / PPC3100 - For link modules - Compatible with 5PP520.1043-00	84
5AP1120.1214-000	Automation Panel 12.1" SVGA TFT - 800 x 600 pixels (4:3) - Single-touch (analog resistive) - Control cabinet installation - Landscape format - Front USB - For PPC900 / PPC2100 / PPC3100 - For link modules - Compatible with 5PP520.1043-00	96
5AP1120.121E-000	Automation Panel 12.1" WXGA TFT - 1280 x 800 pixels (16:10) - Single-touch (analog resistive) - Control cabinet installation - Landscape format - For PPC2100 / PPC3100 / link modules	99
5AP1120.1505-000	Automation Panel 15.0" XGA TFT - 1024 x 768 pixels (4:3) - Single-touch (analog resistive) - Control cabinet installation - Landscape format - Front USB - For PPC900 / PPC2100 / PPC3100 - For link modules - Compatible with 5PP520.1505-00, 5AP920.1505-01, 5PC720.1505-xx, 5PC820.1505-00	103
5AP1120.156B-000	Automation Panel 15.6" HD TFT - 1366 x 768 pixels (16:9) - Single-touch (analog resistive) - Control cabinet installation - Landscape format - For PPC900 / PPC2100 / PPC3100 / link modules	113
5AP1120.1906-000	Automation Panel 19.0" SXGA TFT - 1280 x 1024 pixels (5:4) - Single-touch (analog resistive) - Control cabinet installation - Landscape format - Front USB - For PPC900 / PPC2100 / PPC3100 / link modules - Compatible with 5AP920.1906-01, 5PC720.1906-00, 5PC820.1906-00	119
5AP1130.0702-000	Automation Panel 7.0" WVGA TFT - 800 x 480 pixels (16:10) - Multi-touch (projected capacitive) - Control cabinet installation - Landscape format - For PPC2100 / link modules - Installation compatible with 5PP520.0702-00	78
5AP1130.101E-000	Automation Panel 10.1" WXGA TFT - 1280 x 800 pixels (16:10) - Multi-touch (projected capacitive) - Control cabinet installation - Landscape format - For PPC2100 / PPC3100 / link modules	82
5AP1130.121E-000	Automation Panel 12.1" WXGA TFT - 1280 x 800 pixels (16:10) - Multi-touch (projected capacitive) - Control cabinet installation - Landscape format - For PPC2100 / PPC3100 / link modules	101
5AP1130.156C-000	Automation Panel 15.6" Full HD TFT - 1920 x 1080 pixels (16:9) - Multi-touch (projected capacitive) - Control cabinet installation - Landscape format - For PPC900 / PPC2100 / PPC3100 / link modules	115
5AP1130.185C-000	Automation Panel 18.5" Full HD TFT - 1920 x 1080 pixels (16:9) - Multi-touch (projected capacitive) - Control cabinet installation - Landscape format - For PPC900 / PPC2100 / PPC3100 / link modules	117
5AP1151.0573-000	Automation Panel 5.7" VGA TFT - 640 x 480 pixels (4:3) - Single-touch (analog resistive) - Control cabinet cable installation - Portrait format - 22 function keys and 20 system keys - For PPC2100 / link modules - Compatible with 5PP551.0573-00	73
5AP1180.1043-000	Automation Panel 10.4" VGA TFT - 640 x 480 pixels (4:3) - Single-touch (analog resistive) - Control cabinet installation - Landscape format - Front USB - 22 function keys - For PPC900/PPC2100/PPC3100- For link modules - Compatible with 5PP580.1043-00, 5AP980.1043-01	87
5AP1180.1505-000	Automation Panel 15.0" XGA TFT - 1024 x 768 pixels (4:3) - Single-touch (analog resistive) - Control cabinet installation - Landscape format - Front USB - For PPC900/PPC2100/PPC3100 - For link modules - Compatible with 5PP580.1505-00, 5AP980.1505-01	106
5AP1181.1043-000	Automation Panel 10.4" VGA TFT - 640 x 480 pixels (4:3) - Single-touch (analog resistive) - Control cabinet installation - Portrait format - Front USB - 38 function keys and 20 system keys - For PPC900/PPC2100/PPC3100 - For link modules - Compatible with 5PP581.1043-00, 5AP981.1043-01, 5PC781.1043-00	90
5AP1181.1505-000	Automation Panel 15" XGA TFT - 1024 x 768 pixels (4:3) - Single-touch (analog resistive) - Control cabinet installation - Landscape format - Front USB interface - 32 function keys and 92 system keys - For PPC900 / PPC2100 / PPC3100 / link modules - Compatible with 5PP581.1505-000	109
5AP1182.1043-000	Automation Panel 10.4" VGA TFT - 640 x 480 pixels (4:3) - Single-touch (analog resistive) - Control cabinet installation - Landscape format - Front USB - 44 function keys and 20 system keys - For PPC900/PPC2100/PPC3100 - For link modules - Compatible with 5PP582.1043-00, 5AP982.1043-01, 5PC782.1043-00	93
	RS232 cables	
9A0014.02	RS232 extension cable for operation of a remote display unit with touch screen, 1.8 m	189
9A0014.05	RS232 extension cable for operation of a remote display unit with touch screen, 5 m	189
9A0014.10	RS232 extension cable for operation of a remote display unit with touch screen, 10 m	189

Model number	Short description	Page
SDL cables		
5CASDL.0008-00	SDL cable - 0.8 m	169
5CASDL.0018-00	SDL cable - 1.8 m	169
5CASDL.0050-00	SDL cable - 5 m	169
5CASDL.0100-00	SDL cable - 10 m	169
5CASDL.0150-00	SDL cable - 15 m	169
5CASDL.0200-00	SDL cable - 20 m	169
5CASDL.0250-00	SDL cable - 25 m	169
5CASDL.0300-00	SDL cable - 30 m	169
SDL cables 45° connection		
5CASDL.0018-01	SDL cable - 45 degree connector - 1.8 m	172
5CASDL.0050-01	SDL cable - 45 degree connector - 5 m	172
5CASDL.0100-01	SDL cable - 45 degree connector - 10 m	172
5CASDL.0150-01	SDL cable - 45 degree connector - 15 m	172
SDL cables flex		
5CASDL.0018-03	SDL flex cable - 1.8 m	175
5CASDL.0050-03	SDL flex cable - 5 m	175
5CASDL.0100-03	SDL flex cable - 10 m	175
5CASDL.0150-03	SDL flex cable - 15 m	175
5CASDL.0200-03	SDL flex cable - 20 m	175
5CASDL.0250-03	SDL flex cable - 25 m	175
5CASDL.0300-03	SDL flex cable - 30 m	175
5CASDL.0300-13	SDL flex cable with extender - 30 m	180
5CASDL.0400-13	SDL flex cable with extender - 40 m	180
5CASDL.0430-13	SDL flex cable with extender - 43 m	180
SDL3/SDL4 cables		
5CASD3.0030-00	SDL3 cable - 3 m	184
5CASD3.0050-00	SDL3 cable - 5 m	184
5CASD3.0100-00	SDL3 cable - 10 m	184
5CASD3.0150-00	SDL3 cable - 15 m	184
5CASD3.0200-00	SDL3 cable - 20 m	184
5CASD3.0300-00	SDL3 cable - 30 m	184
5CASD3.0500-00	SDL3 cable - 50 m	184
5CASD3.1000-00	SDL3 cable - 100 m	184
USB accessories		
5MMUSB.032G-02	USB 3.0 flash drive 32 GB MLC	164
5MMUSB.2048-01	USB 2.0 flash drive 2048 MB B&R	162
5MMUSB.4096-01	USB 2.0 flash drive 4096 MB B&R	162
USB cables		
5CAUSB.0018-00	USB 2.0 connection cable - Type A - type B connector - 1.8 m	187
5CAUSB.0050-00	USB 2.0 connection cable - Type A - type B connector - 5 m	187

Chapter 2 • Technical data

1 Introduction

1.1 About this user's manual

This user's manual contains all relevant information about an operational Automation Panel 1000 cabinet-mounted device.

This user's manual applies to the modular Automation Panel 1000 product generation. Information about Automation Panel 920, 980, 981 and 982 systems can be found in the Automation Panel 900 user's manual. Information about Automation Panel 9x3 systems can be found in the Automation Panel 9x3 user's manual.

1.2 Description of individual modules

1.2.1 AP1000 panels

AP1000 panels form the basis for the Automation Panel 1000, Panel PC 900, Panel PC 2100 and Panel PC 3100 system families. A wide selection of different display diagonals as well as panels with touch screen and keys are available. The panels can only be operated as a complete system in combination with a link module (Automation Panel 1000) or CPU board and system unit (Panel PC 900, Panel PC 2100, Panel PC 3100). The panels are installed using retaining clips or clamping blocks.



1.2.2 Link modules

Link modules have various graphics interfaces and connections. An Automation Panel is put together by installing a link module onto a panel.

A link module cannot be operated without a panel.



1.3 System components / Configuration

Automation Panel 1000, Panel PC 900, Panel PC 2100 and Panel PC 3100 systems can be assembled to meet individual requirements and operating conditions. Automation Panel 1000, Panel PC 900, Panel PC 2100 and Panel PC 3100 systems are flexible so that an Automation Panel can be converted to a Panel PC or vice versa.

1.3.1 Configuration

The following individual components are required for operation as an Automation Panel 1000:

- Panel
- Link module







Configuration - Base system						
Panels	Select 1					
    		Display size	Resolution	Touch screen	Keys	Format
	1120 panels					
	5AP1120.0573-000	5.7"	VGA	Single-touch	No	Landscape
	5AP1120.0702-000	7.0"	WVGA	Single-touch	No	Landscape
	5AP1120.1043-000	10.4"	VGA	Single-touch	No	Landscape
	5AP1120.101E-000	10.1"	WXGA	Single-touch	No	Landscape
	5AP1120.1214-000	12.1"	SVGA	Single-touch	No	Landscape
	5AP1120.121E-000	12.1"	WXGA	Single-touch	No	Landscape
	5AP1120.1505-000	15.0"	XGA	Single-touch	No	Landscape
	5AP1120.156B-000	15.6"	HD	Single-touch	No	Landscape
	5AP1120.1906-000	19.0"	SXGA	Single-touch	No	Landscape
	1130 panels					
	5AP1130.0702-000	7.0"	WVGA	Multi-touch	No	Landscape
	5AP1130.101E-000	10.1"	WXGA	Multi-touch	No	Landscape
	5AP1130.121E-000	12.1"	WXGA	Multi-touch	No	Landscape
	5AP1130.156C-000	15.6"	FHD	Multi-touch	No	Landscape
	5AP1130.185C-000	18.5"	FHD	Multi-touch	No	Landscape
	1151 panels					
	5AP1151.0573-000	5.7"	VGA	No	Yes	Portrait
	1180 panels					
	5AP1180.1043-000	10.4"	VGA	Single-touch	Yes	Landscape
	5AP1180.1505-000	15.0"	XGA	Single-touch	Yes	Landscape
	1181 panels					
	5AP1181.1043-000	10.4"	VGA	Single-touch	Yes	Portrait
5AP1181.1505-000	15.0"	XGA	Single-touch	Yes	Landscape	
1182 panels						
5AP1182.1043-000	10.4"	VGA	Single-touch	Yes	Landscape	
Link modules	Select 1					
	5DLSDL.1001-00 SDL/DVI receiver					
	5DLSD3.1001-00 SDL3 receiver					
	5DLSD4.1001-00 SDL4 receiver					
Terminal blocks	Select 1					
	Power connectors					
	0TB103.9					
	0TB103.91					

Figure 1: Automation Panel 1000 - Configuration

2 Complete system

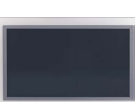
2.1 Connection options

The Automation Panel can be connected to a B&R industrial PC via SDL, DVI SDL3 or SDL4 operations. The connection options described below provide an overview of the operating modes as well as possible limitations.

2.1.1 SDL operation

2.1.1.1 SDL operation - Mode 1

In SDL operating mode 1, all communication between the Automation Panel and B&R industrial PC is handled using a single SDL cable.

In addition to display data, information from the touch screen and matrix keys as well as service and diagnostic data is transferred. The Automation Panel can be installed up to from the B&R industrial PC. USB 1.1 is also transferred over this distance and fully integrated in SDL. External modules are not necessary for this.

The brightness of the display can be set using the ADI Control Center, for example.

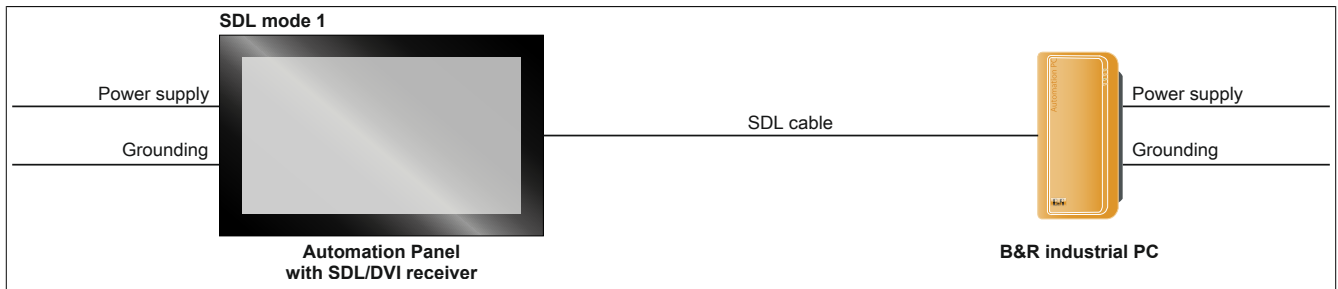

Availability of interfaces on the Automation Panel with SDL/DVI receiver:

Panel In	✓	USB In	✗	Power supply	✓	Brightness controls	✗
USB1, USB2	✓	COM touch screen inter-face	✗	Grounding	✓		

Requirements

- Automation Panel with SDL/DVI receiver
- B&R industrial PC with SDL interface
- SDL cable

2.1.1.2 SDL operation - Mode 2

In SDL operating mode 2, communication between the Automation Panel and B&R industrial PC is handled using an SDL cable connected to interface "Panel In" and a USB type A/B cable connected to interface "USB In".

In addition to display data, information from the resistive touch screen and matrix keys as well as LED, service and diagnostic data is transferred over the SDL cable. Data from the multi-touch touch screen is transferred over the USB type A/B cable. The Automation Panel can be installed up to 5 m (USB specification) from the B&R industrial PC. USB 2.0 data can be transferred over this distance via the USB type A/B cable. External modules are not necessary for this.

The brightness of the display can be set using the ADI Control Center, for example.

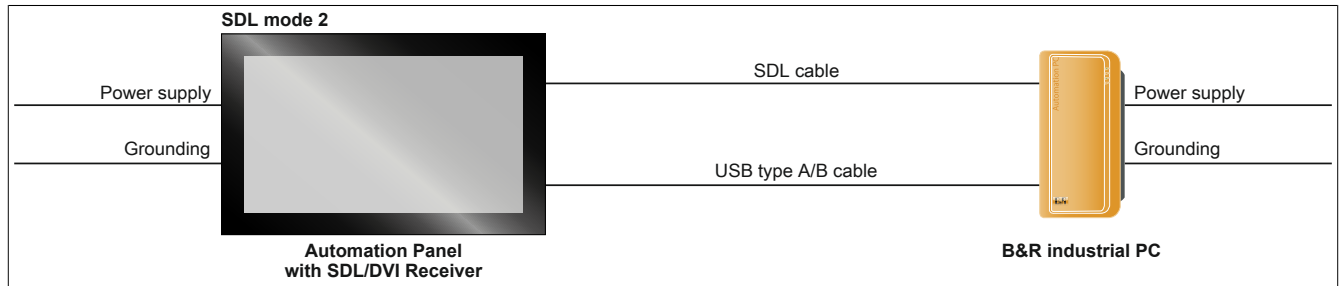

Availability of interfaces on the Automation Panel with SDL/DVI receiver:

Panel In	✓	USB In	✓	USB 2.0	Power supply	✓	Brightness controls	x
USB1, USB2	✓	COM touch screen inter-face	x		Grounding	✓		

Maximum cable length: 5 m

Requirements

- Automation Panel with SDL/DVI receiver
- B&R industrial PC with SDL interface
- SDL cable, USB type A/B cable

2.1.2 DVI operation

In the DVI operating mode, all signals needed to operate the Automation Panel are each transferred over a separate cable. The brightness of the display can be set using the brightness buttons.

2.1.2.1 DVI operation with single-touch Automation Panel

If an Automation Panel with resistive touch screen (single-touch) is operated with DVI, then a DVI cable, USB type A/B cable and RS232 cable must be connected.

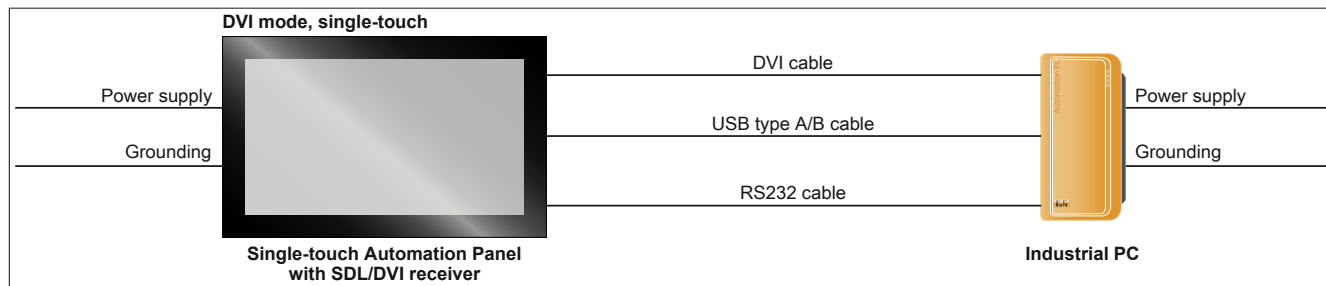

Availability of interfaces on the Automation Panel with SDL/DVI receiver:

Panel In	✓	USB In	✓	USB 2.0	Power supply	✓	Brightness controls	✓
USB1, USB2	✓	USB 2.0	COM touch screen inter-face	✓	Grounding	✓		

Maximum cable length: 5 m

Requirements

- Automation Panel with SDL/DVI receiver
- B&R industrial PC with DVI interface
- DVI cable, USB type A/B cable, RS232 cable

2.1.2.2 DVI mode with multi-touch Automation Panel

If an Automation Panel with PCT touch screen (multi-touch) is operated with DVI, then a DVI cable and USB type A/B cable must be connected.

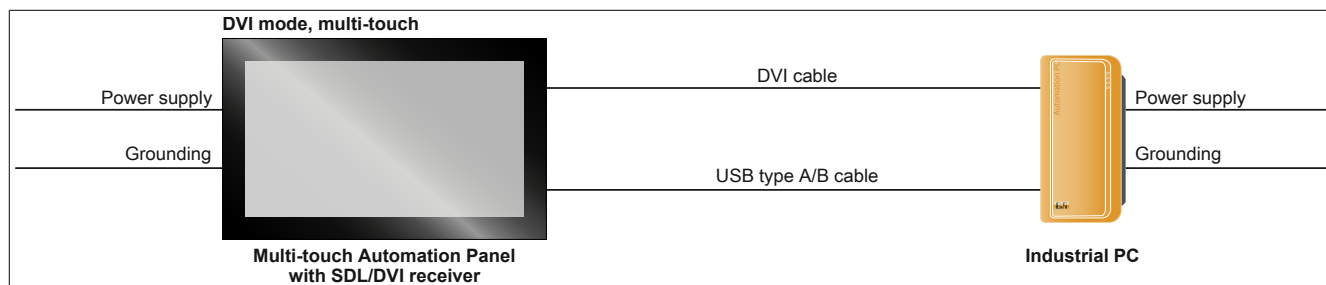

Availability of interfaces on the Automation Panel with SDL/DVI receiver:

Panel In	✓	USB In	✓	USB 2.0	Power supply	✓	Brightness controls	✓
USB1, USB2	✓	USB 2.0	COM touch screen inter-face	x	Grounding	✓		

Maximum cable length: 5 m

Requirements

- Automation Panel with SDL/DVI receiver
- B&R industrial PC with DVI interface
- DVI cable, USB type A/B cable

2.1.2.3 General limitations / Special considerations

- Key and LED data is not transferred.
- Data from operating elements is not transferred.
- Service and diagnostic data is not transferred.
- Maximum cable length is limited to 5 m.

2.1.3 SDL3 mode

Smart Display Link 3 (SDL3) technology transfers all communication channels between a B&R industrial PC and panel up to 100 m over a standard Ethernet cable (min. Cat 6a). An RJ45 connector ideal for narrow spaces such as feed-throughs and swing arm system is used to connect to the device.

2.1.3.1 SDL3 mode with SDL3 transmitter

In the SDL3 operating mode with an SDL3 transmitter in the B&R industrial PC, all communication between the Automation Panel and B&R industrial PC is handled using a single SDL3 cable.

In addition to display data, information from the touch screen and matrix keys as well as service and diagnostic data is transferred. The Automation Panel can be installed up to 100 m from the B&R industrial PC. USB 2.0 is also transferred over this distance and fully integrated in SDL3. External modules are not necessary for this.

The brightness of the display can be set using the ADI Control Center.

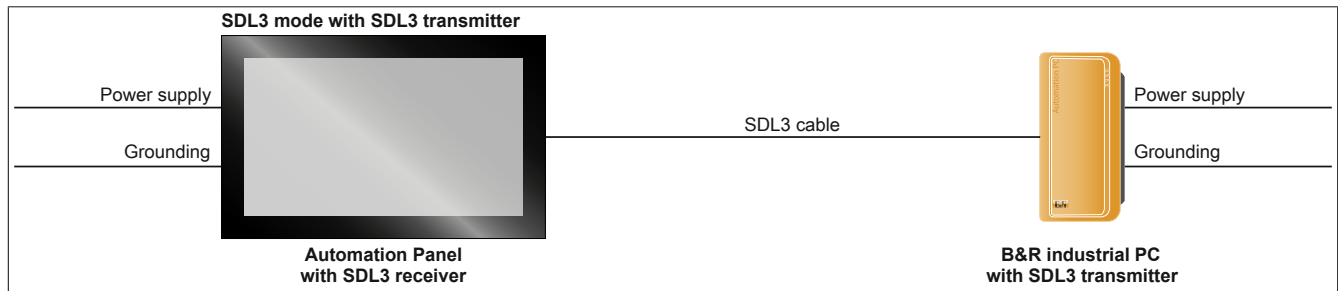

Availability of interfaces on the Automation Panel with SDL3 receiver:

SDL3 interface ✓ USB1, USB2 ✓ USB 2.0 Power supply ✓ Grounding ✓

Maximum cable length of SDL3: 100 m

Requirements

- Automation Panel with SDL3 receiver
- B&R industrial PC with SDL3 interface
- SDL3/SDL4 cable

2.1.3.2 General limitations / Special considerations

- The USB 2.0 transfer rate is limited to 30 Mbit/s with SDL3.
- The SDL3 transmitter constantly emulates a display using EDID data and hot plugging code; this allows DVI-compatible operation. As a result, improperly displayed images are possible during operation with multiple displays. In Windows, a connected panel is registered by the graphics driver even in the following situations:
 - No cable is connected.
 - A connection has not yet been established between the SDL3 link module and the SDL3 transmitter.

These improperly displayed images can be circumvented by making suitable configurations in BIOS or via the graphics driver.

2.1.4 SDL4 operation

Smart Display Link 4 (SDL4) technology transfers all communication channels between a B&R industrial PC and panel up to 100 m over a standard Ethernet cable (min. Cat 6a). An RJ45 connector ideal for narrow spaces such as feed-throughs and swing arm system is used to connect to the device.

2.1.4.1 SDL4 operation with SDL4 transmitter

In the SDL4 operating mode with an SDL4 transmitter in the B&R industrial PC, all communication between the Automation Panel and B&R industrial PC is handled using a single SDL4 cable.

In addition to display data, information from the touch screen and matrix keys as well as service and diagnostic data is transferred. The Automation Panel can be installed up to 100 m from the B&R industrial PC. USB 2.0 is also transferred over this distance and fully integrated in SDL4. External modules are not necessary for this.

The brightness of the display can be set using the ADI Control Center, for example.

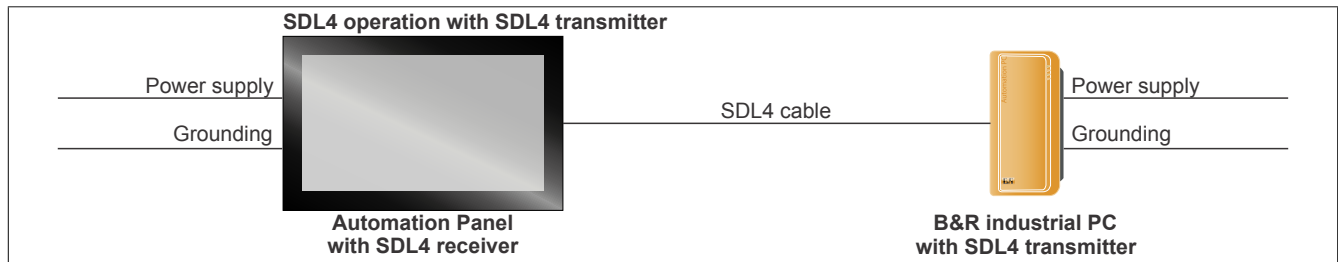

Availability of interfaces on the Automation Panel with SDL4 receiver:

SDL4 interface ✓ USB1, USB2 ✓ USB 2.0 Power supply ✓ Grounding ✓

Maximum cable length of SDL4: 100 m

Requirements

- Automation Panel with SDL4 receiver
- B&R industrial PC with SDL4 interface
- SDL3/SDL4 cable

2.1.4.2 General limitations

- The USB 2.0 transfer rate is limited to 150 Mbit/s with SDL4.
- The SDL4 transmitter constantly emulates a display using EDID data and hot plugging code; this allows DVI-compatible operation. As a result, improperly displayed images are possible during operation with multiple displays. In Windows, a connected panel is registered by the graphics driver even in the following situations:
 - No cable is connected.
 - A connection has not yet been established between the SDL4 link module and SDL4 transmitter.

These improperly displayed images can be circumvented by making suitable configurations in BIOS or via the graphics driver.

2.2 Mechanical characteristics

2.2.1 Dimensions

AP1000 panels with retaining clips - Dimensions

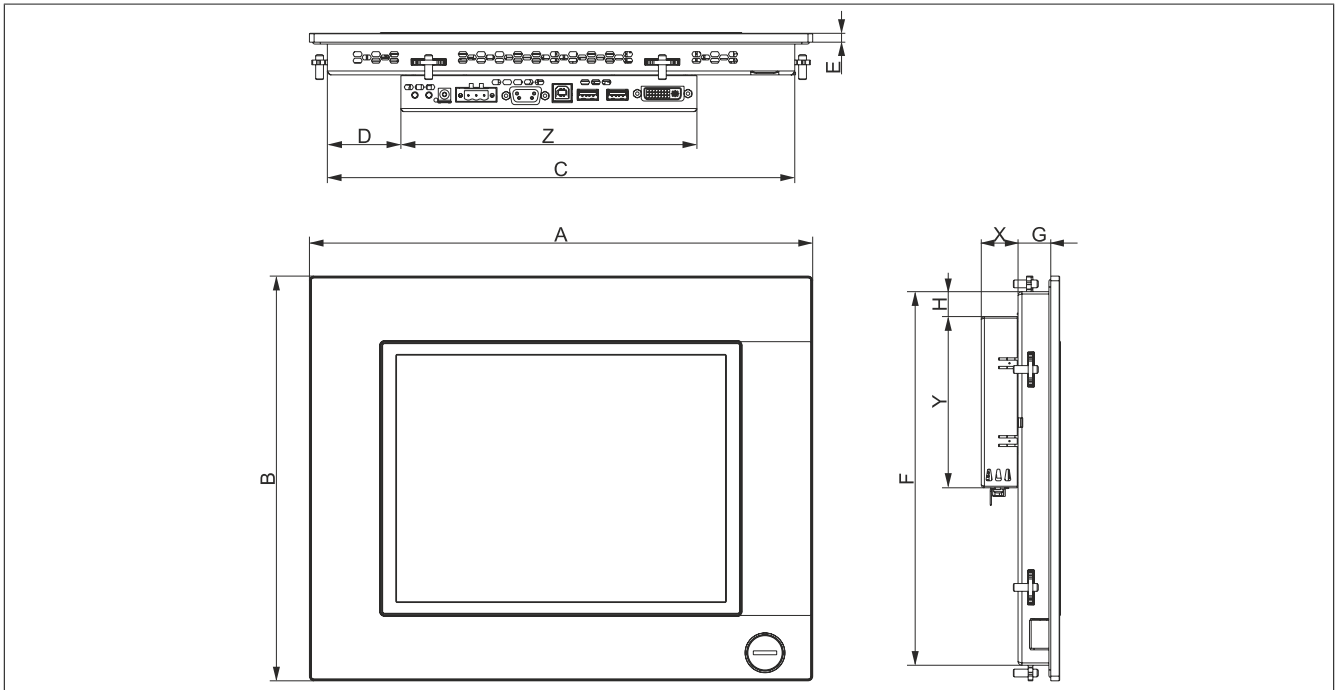

Figure 2: Automation Panel 1000 with retaining clips - Dimensions

All dimensions are specified in mm.

Display type	Model number	A	B	C	D	E	F	G	H
5.7" single-touch	5AP1120.0573-000	212	156	196	3	5.7	140	19.5	2.5
5.7" with keys	5AP1151.0573-000	212	245	196	3	5.7	229	19.5	2.5
7.0" single-touch	5AP1120.0702-000	212	156	196	3	5.7	140	19.5	2.5
7.0" multi-touch	5AP1130.0702-000	209	153	196	3	9	140	20	7.25
10.1" single-touch	5AP1120.101E-000	279	191	266	38	9	178	18	13.5
10.1" multi-touch	5AP1130.101E-000	279	191	266	38	9	178	18	13.5
10.4" single-touch	5AP1120.1043-000	323	260	300	47.2	5.7	240	21	16
10.4" single-touch with keys	5AP1180.1043-000	323	260	300	47.2	5.7	240	21	16
12.1" single-touch	5AP1120.121E-000	324	221.5	311	60.5	9	208.5	18	13.5
12.1" multi-touch	5AP1130.121E-000	324	221.5	311	60.5	9	208.5	18	13.5
15.6" single-touch	5AP1120.156B-000	414	258.5	401	105.5	9	245.5	20	13.5
15.6" multi-touch	5AP1130.156C-000	414	258.5	401	105.5	9	245.5	20	13.5
18.5" multi-touch	5AP1130.185C-000	475	295	462	166.5	9	282	18	13.5

Table 4: AP1000 panels with retaining clips - Dimensions

Link module type	Model number	X	Y	Z
SDL/DVI receiver	5DLSDL.1001-00	23.6	110	190
SDL3 receiver	5DLSD3.1001-00	23.6	110	190
SDL4 receiver	5DLSD4.1001-00	23.6	110	190

Table 5: Link modules - Dimensions

Information:

2D and 3D drawings (in DXF and STEP format) can be downloaded from the B&R website (www.br-automation.com).

AP1000 panels with clamping blocks - Dimensions

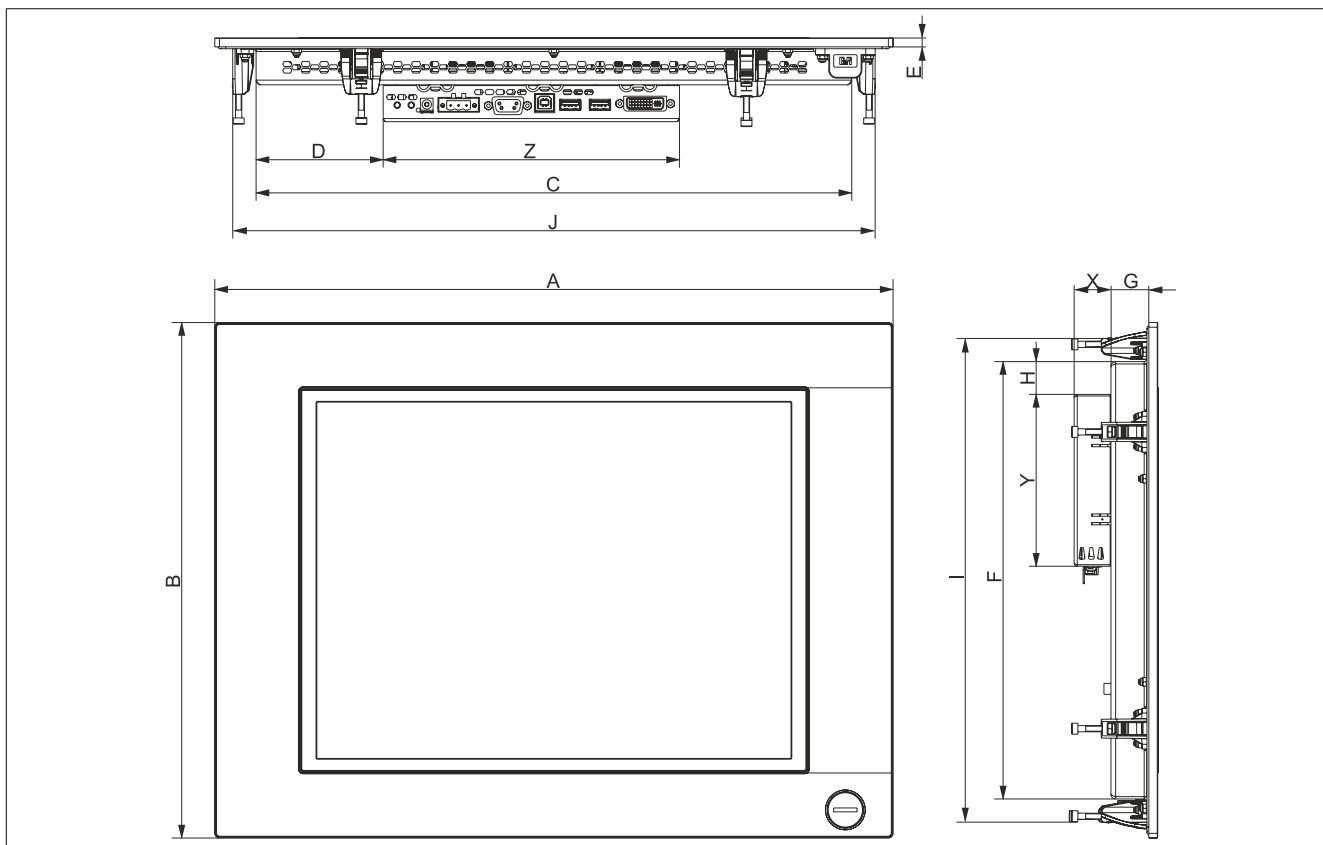

Figure 3: Automation Panel 1000 with clamping blocks - Dimensions

All dimensions are specified in mm.

Display type	Model number	A	B	C	D	E	F	G	H	I	J
10.4" single-touch with keys	5AP1181.1043-000	323	358	270	70.5	5.7	305	21.3	17.5	338	300
10.4" single-touch with keys	5AP1182.1043-000	423	288	355.5	70.5	5.7	234	21.3	17.5	268	400
12.1" single-touch	5AP1120.1214-000	362	284	309	52.5	5.7	234	20.3	17.5	264	339
15.0" single-touch	5AP1120.1505-000	435	330	382	81.5	5.7	280	24.3	24	310	412
15.0" single-touch with keys	5AP1180.1505-000	435	330	382	81.5	5.7	280	24.3	24	310	412
15.0" single-touch with keys	5AP1181.1505-000	435	430	382	81.5	5.7	380	24.3	24	410	412
19.0" single-touch	5AP1120.1906-000	527	421	445	186.5	5.7	351	23.3	19.3	401	507

Table 6: AP1000 panels with clamping blocks - Dimensions

Link module type	Model number	X	Y	Z
SDL/DVI receiver	5DLSDL.1001-00	23.6	110	190
SDL3 receiver	5DLSD3.1001-00	23.6	110	190
SDL4 receiver	5DLSD4.1001-00	23.6	110	190

Table 7: Link modules - Dimensions

Information:

2D and 3D drawings (in DXF and STEP format) can be downloaded from the B&R website (www.br-automation.com).

2.2.2 Installation diagrams

Information:

When installing the Automation Panel 1000, be sure to leave sufficient space for air circulation as well as additional space for operation and maintenance of the device.

AP1000 panels with retaining clips - Installation diagrams

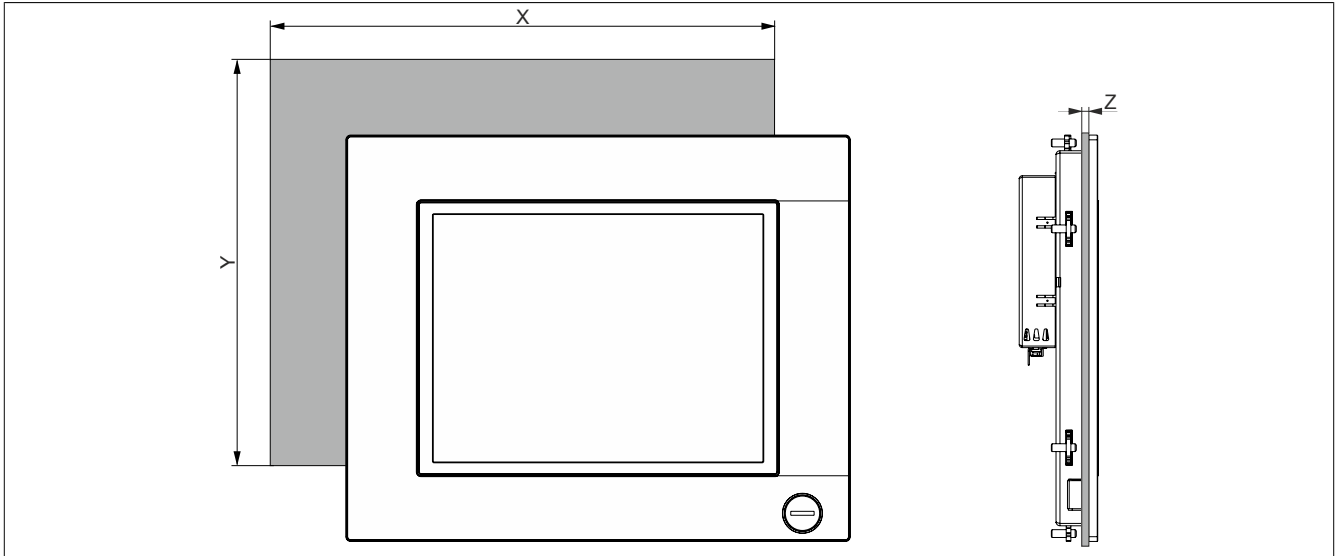

Figure 4: Automation Panel 1000 with retaining clips - Installation diagram

All dimensions are specified in mm.

The cutout tolerances are +0 mm / -0.5 mm.

Display type	Model number	X	Y	Z min	Z max	Number of retaining clips
5.7" single-touch	5AP1120.0573-000	199	143	1	8	4
5.7" with keys	5AP1151.0573-000	199	232	1	8	6
7.0" single-touch	5AP1120.0702-000	199	143	1	8	4
7.0" multi-touch	5AP1130.0702-000	199	143	1	8	4
10.1" single-touch	5AP1120.101E-000	268	180	1	6	8
10.1" multi-touch	5AP1130.101E-000	268	180	1	6	8
10.4" single-touch	5AP1120.1043-000	303	243	1	10	8
10.4" single-touch with keys	5AP1180.1043-000	303	243	1	10	8
12.1" single-touch	5AP1120.121E-000	313	210.5	1	6	10
12.1" multi-touch	5AP1130.121E-000	313	210.5	1	6	10
15.6" single-touch	5AP1120.156B-000	403	247.5	1	6	10
15.6" multi-touch	5AP1130.156C-000	403	247.5	1	6	10
18.5" multi-touch	5AP1130.185C-000	464	284	1	6	10

Table 8: AP1000 panels with retaining clips - Installation diagrams

The "Z" measurement indicates the thickness of the wall or control cabinet panel.

A 2.5 mm hex socket screwdriver is needed to tighten and loosen the screws on the retaining clips. The maximum tightening torque for the retaining clips is 1 Nm.

Information:

A minimum distance of 30 mm at all points is required to perform the installation with retaining clips.

AP1000 panels with clamping blocks - Installation diagrams

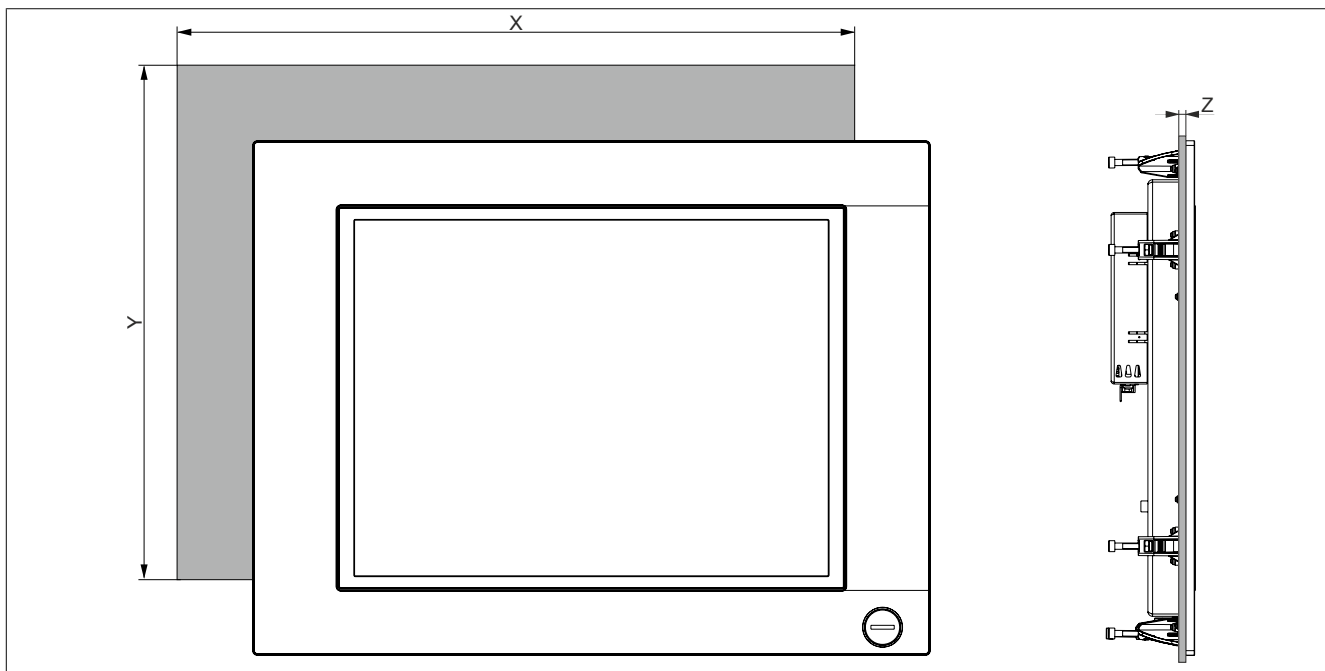

Figure 5: Automation Panel 1000 with clamping blocks - Installation diagram

All dimensions are specified in mm.

The cutout tolerances are +0 mm / -0.5 mm.

Display type	Model number	X	Y	Z min	Z max	Number of clamping blocks
10.4" single-touch with keys	5AP1181.1043-000	303	341	2	10	10
10.4" single-touch with keys	5AP1182.1043-000	403	271	2	10	8
12.1" single-touch	5AP1120.1214-000	342	267	2	10	8
15.0" single-touch	5AP1120.1505-000	415	313	2	10	8
15.0" single-touch with keys	5AP1180.1505-000	415	313	2	10	8
15.0" single-touch with keys	5AP1181.1505-000	415	413	2	10	10
19.0" single-touch	5AP1120.1906-000	510	404	2	10	12

Table 9: AP1000 panels with clamping blocks - Installation diagrams

The "Z" measurement indicates the thickness of the wall or control cabinet panel.

A 3 mm hex socket screwdriver is needed to tighten and loosen the screws on the clamping blocks. The maximum tightening torque for the clamping blocks is 0.5 Nm.

2.2.3 Spacing for air circulation

In order to ensure sufficient air circulation, the specified clearance values must be observed above, below, to the side and behind the device. For the minimum specified clearance, see the following diagrams. This applies to all variants.

Information:

The following figure and table illustrate the complete system from a thermal point of view. Additional space needed to operate or service the device must be taken into account during installation.

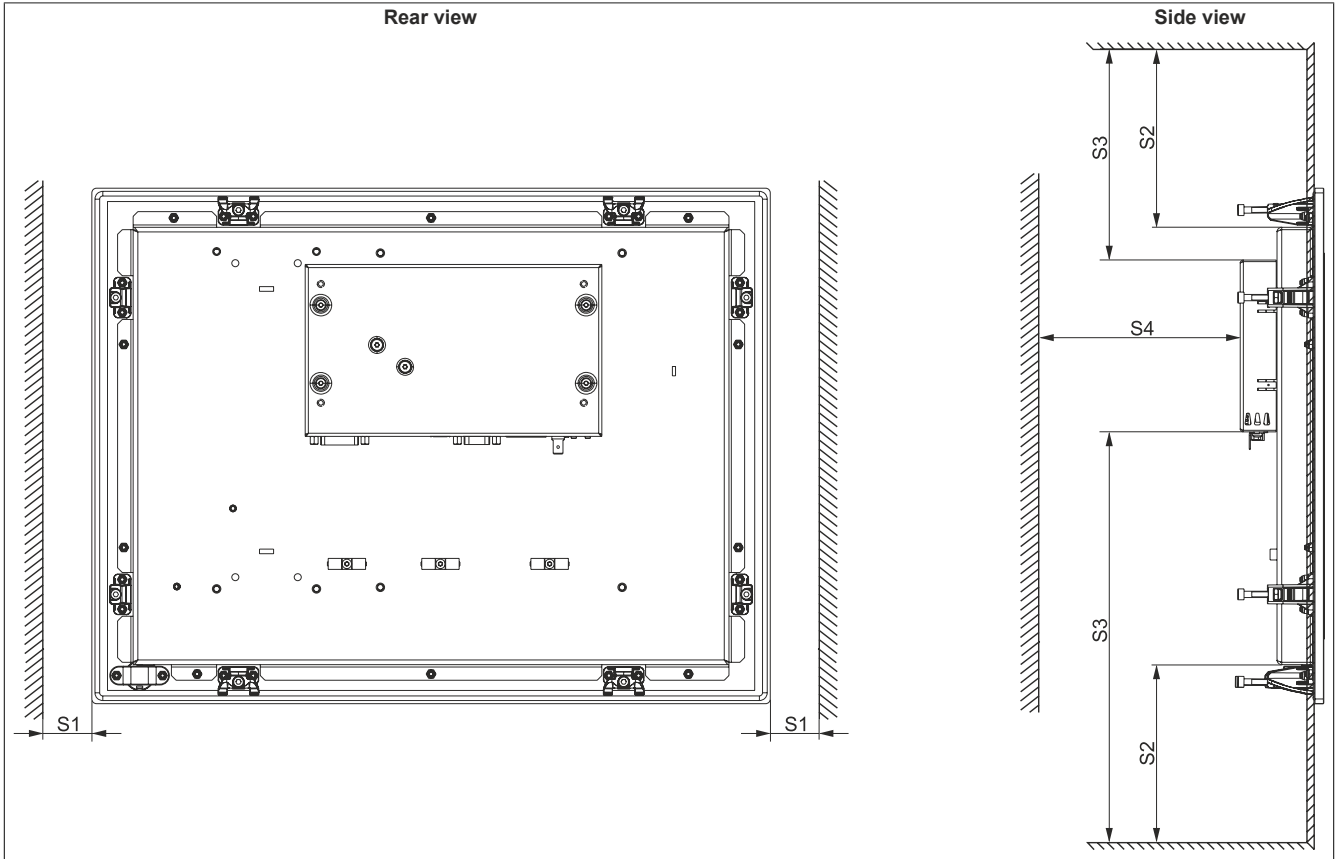

Figure 6: Automation Panel 1000 - Spacing for air circulation

S1: ≥ 10 mm

S2: ≥ 50 mm

S3: ≥ 80 mm

S4: ≥ 50 mm

Information:

A minimum distance of 30 mm at all points is required to perform the installation with retaining clips.

Caution!

The spacing specifications for air circulation are based on the worst-case scenario for operation at the maximum specified ambient temperature. The maximum specified ambient temperature must not be exceeded!

If the spacing specifications for air circulation cannot be observed, then the maximum specified temperatures for the temperature sensors (see "[Temperature sensor positions](#)" on page 34) must be monitored by the user and appropriate measures taken if they are exceeded.

2.2.4 Mounting orientations

The following diagrams show the approved mounting orientations for the Automation Panel 1000. The AP1000 must be mounted as illustrated and described below.

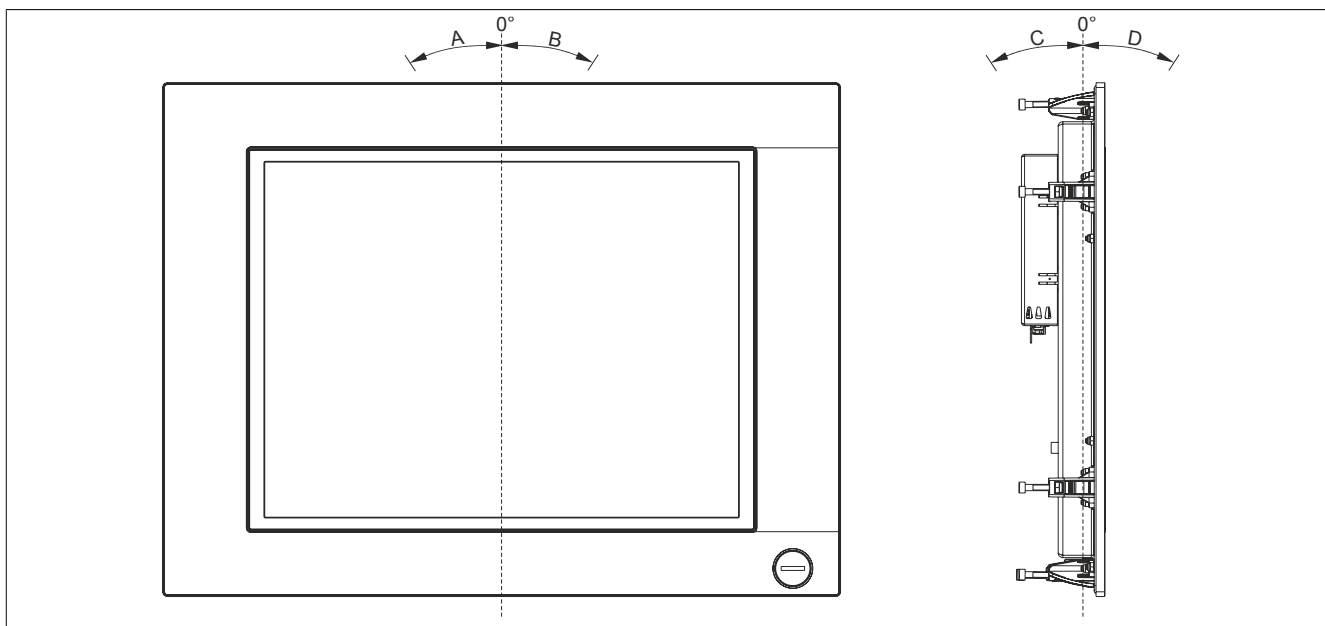

Figure 7: Automation Panel 1000 - Mounting orientation

If "✓" is marked for the panel, it can be used at the maximum ambient temperature (see "Maximum ambient temperature during operation" on page 31) of the complete system without problems.

If there is a specific temperature for the panel in a particular mounting orientation, for example "55", then the ambient temperature is not permitted to exceed this temperature.

Mounting orientations for the Automation Panel 1000 with SDL/DVI receiver

			Panel																			
			5AP1120.0573-000	5AP1151.0573-000	5AP1120.0702-000	5AP1130.0702-000	5AP1120.101E-000	5AP1130.101E-000	5AP1120.1043-000	5AP1180.1043-000	5AP1181.1043-000	5AP1182.1043-000	5AP1120.1214-000	5AP1120.121E-000	5AP1130.121E-000	5AP1120.1505-000	5AP1180.1505-000	5AP1181.1505-000	5AP1120.156B-000	5AP1130.156C-000	5AP1130.185C-000	5AP1120.1906-000
Mounting orientation	0°	0°	✓	✓	✓	✓	✓	✓	✓	✓	✓	✓	✓	✓	✓	✓	✓	✓	✓	✓	✓	✓
	A	-1° to -90° (counterclockwise)	✓	✓	✓	✓	✓	✓	✓	✓	✓	✓	✓	✓	✓	✓	✓	✓	✓	✓	✓	✓
	B	+1° to +90° (clockwise)	✓	✓	✓	✓	✓	✓	✓	✓	✓	✓	✓	✓	✓	✓	✓	✓	✓	✓	✓	✓
	C, D	±180° (interfaces on top)	✓	✓	✓	✓	✓	✓	✓	✓	✓	✓	✓	✓	✓	✓	✓	✓	✓	✓	✓	✓
	C	-1° to -45°	✓	✓	✓	✓	✓	✓	✓	✓	✓	✓	✓	✓	✓	✓	✓	✓	✓	✓	✓	✓
	D	+1° to +90° (display facing down)	✓	✓	✓	✓	✓	✓	✓	✓	✓	✓	✓	✓	✓	✓	✓	✓	✓	✓	✓	✓

Table 10: Automation Panel 1000 with SDL/DVI receiver - Mounting orientations

Mounting orientations for the Automation Panel 1000 with SDL3 receiver

		Panel																				
		5AP1120.0573-000	5AP1151.0573-000	5AP1120.0702-000	5AP1130.0702-000	5AP1120.101E-000	5AP1130.101E-000	5AP1120.1043-000	5AP1180.1043-000	5AP1181.1043-000	5AP1182.1043-000	5AP1120.1214-000	5AP1120.121E-000	5AP1120.121E-000	5AP1120.1505-000	5AP1180.1505-000	5AP1181.1505-000	5AP1120.156B-000	5AP1130.156C-000	5AP1130.185C-000	5AP1120.1906-000	
Mounting orientation	0°	0°	✓	✓	✓	✓	✓	✓	✓	✓	✓	✓	✓	✓	✓	✓	✓	✓	✓	✓	✓	
	A	-1° to -90° (counterclockwise)	55	55	✓	✓	✓	✓	✓	✓	✓	✓	✓	55	55	✓	✓	✓	✓	✓	50	✓
	B	+1° to +90° (clockwise)	55	55	✓	✓	✓	✓	✓	✓	✓	✓	✓	✓	✓	✓	✓	✓	✓	✓	✓	✓
	C, D	±180° (interfaces on top)	55	55	✓	✓	✓	✓	✓	✓	✓	✓	✓	✓	✓	✓	✓	✓	✓	✓	✓	✓
	C	-1° to -45°	55	55	✓	✓	✓	✓	✓	✓	✓	✓	✓	✓	✓	✓	✓	✓	✓	✓	✓	55
	D	+1° to +90° (display facing down)	55	55	55	55	✓	✓	55	55	55	55	55	55	55	55	55	55	✓	✓	50	55

Table 11: Automation Panel 1000 with SDL3 receiver - Mounting orientations

Mounting orientations for the Automation Panel 1000 with SDL4 receiver

		Panel																				
		5AP1120.0573-000	5AP1151.0573-000	5AP1120.0702-000	5AP1130.0702-000	5AP1120.101E-000	5AP1130.101E-000	5AP1120.1043-000	5AP1180.1043-000	5AP1181.1043-000	5AP1182.1043-000	5AP1120.1214-000	5AP1120.121E-000	5AP1120.121E-000	5AP1120.1505-000	5AP1180.1505-000	5AP1181.1505-000	5AP1120.156B-000	5AP1130.156C-000	5AP1130.185C-000	5AP1120.1906-000	
Mounting orientation	0°	0°	✓	✓	✓	✓	✓	✓	✓	✓	✓	✓	✓	✓	✓	✓	✓	✓	✓	✓	✓	
	A	-1° to -90° (counterclockwise)	55	55	✓	✓	✓	✓	✓	✓	✓	✓	✓	55	55	✓	✓	✓	✓	50	50	55
	B	+1° to +90° (clockwise)	55	55	✓	✓	✓	✓	✓	✓	✓	✓	✓	✓	✓	✓	✓	✓	✓	50	✓	✓
	C, D	±180° (interfaces on top)	55	55	✓	✓	✓	✓	✓	✓	✓	✓	✓	✓	✓	✓	✓	✓	✓	✓	✓	✓
	C	-1° to -45°	55	55	✓	✓	✓	✓	✓	✓	✓	✓	✓	✓	✓	✓	✓	✓	✓	50	✓	55
	D	+1° to +90° (display facing down)	55	55	55	55	✓	✓	55	55	55	55	55	55	55	55	55	55	✓	50	50	55

Table 12: Automation Panel 1000 with SDL4 receiver - Mounting orientations

2.2.5 Weight specifications

All weights are specified in g (grams).

Display type	Model number	Weight
5.7" single-touch	5AP1120.0573-000	1100
5.7" with keys	5AP1151.0573-000	1400
7.0" single-touch	5AP1120.0702-000	900
7.0" multi-touch	5AP1130.0702-000	1200
10.1" single-touch	5AP1120.101E-000	1900
10.1" multi-touch	5AP1130.101E-000	2000
10.4" single-touch	5AP1120.1043-000	2800
10.4" single-touch with keys	5AP1180.1043-000	2800
10.4" single-touch with keys	5AP1181.1043-000	3400
10.4" single-touch with keys	5AP1182.1043-000	3500
12.1" single-touch	5AP1120.1214-000	3200
12.1" single-touch	5AP1120.121E-000	2300
12.1" multi-touch	5AP1130.121E-000	2400
15.0" single-touch	5AP1120.1505-000	5000
15.0" single-touch with keys	5AP1180.1505-000	4900
15.0" single-touch with keys	5AP1181.1505-000	6000
15.6" single-touch	5AP1120.156B-000	4200
15.6" multi-touch	5AP1130.156C-000	3700
18.5" multi-touch	5AP1130.185C-000	4600
19.0" single-touch	5AP1120.1906-000	7300

Table 13: AP1000 panels - Weight

Link module type	Model number	Weight
SDL/DVI receiver	5DLSDL.1001-00	538
SDL3 receiver	5DLSD3.1001-00	527
SDL4 receiver	5DLSD4.1001-00	525

Table 14: Link modules - Weight

2.3 Environmental characteristics

2.3.1 Temperature specifications

Various panels can be combined with various link modules. The many different configurations possible result in varying maximum ambient temperatures, which can be seen in the following table in this section.

Information:

The maximum specified ambient temperatures for operation were determined under worst-case conditions. Experience has shown that higher ambient temperatures can be achieved in typical applications, e.g. in Microsoft Windows. Testing and evaluation in this regard must be performed on-site by the user in each individual case (temperatures can be read in BIOS or using the B&R Control Center, for example).

Information regarding worst-case conditions

- BurnInTest tool (BurnInTest V4.0 Pro from Passmark Software) for simulating a 100% load on the interface via loopback adapters (serial interface, USB interfaces)
- Maximum system expansion and power consumption

2.3.1.1 Maximum ambient temperature during operation

All specifications are valid for non-condensing operation.

		Link module			Location of sensor(s)
		SDL/DVI 5DLSDL.1001-00	SDL3 5DLS3.1001-00	SDL4 5DLS4.1001-00	
		All temperature values in degrees Celsius (°C) at 500 m above sea level.			
		The maximum ambient temperature is typically derated by 1°C per 1000 meters starting at 500 meters above sea level.			
		Maximum ambient temperature	60	60¹⁾	60
		What else can also be operated at the max. ambient temperature, or is there a limitation?			
Panels	5AP1120.0573-000	✓	✓ ¹⁾	✓	Display - See temperature sensor position
	5AP1151.0573-000	✓	✓ ¹⁾	✓	
	5AP1120.0702-000	✓	✓ ¹⁾	✓	
	5AP1130.0702-000	✓	✓ ¹⁾	✓	
	5AP1120.101E-000	55	55 ¹⁾	55	
	5AP1130.101E-000	55	55 ¹⁾	55	
	5AP1120.1043-000	✓	✓ ¹⁾	✓	
	5AP1180.1043-000	✓	✓ ¹⁾	✓	
	5AP1181.1043-000	✓	✓ ¹⁾	✓	
	5AP1182.1043-000	✓	✓ ¹⁾	✓	
	5AP1120.1214-000	✓	✓ ¹⁾	✓	
	5AP1120.121E-000	✓	✓ ¹⁾	✓	
	5AP1130.121E-000	✓	✓ ¹⁾	✓	
	5AP1120.1505-000	✓	✓ ¹⁾	✓	
	5AP1180.1505-000	✓	✓ ¹⁾	✓	
	5AP1181.1505-000	✓	✓ ¹⁾	✓	
	5AP1120.156B-000	✓	55 ¹⁾	55	
5AP1130.156C-000	55	50 ¹⁾	55		
5AP1130.185C-000	55	55 ¹⁾	55		
5AP1120.1906-000	✓	✓ ¹⁾	✓		

1) The maximum ambient temperature for SDL3 link module 5DLS3.1001-00 < Rev. A5 with the corresponding panel is reduced by 5°C.

Table 15: Maximum ambient temperature during operation

2.3.1.2 How to determine the maximum ambient temperature

1. Select the link module.
2. The "Maximum ambient temperature" row shows the maximum ambient temperature for the complete system, including the respective link module.

Information:

Maximum temperature data is for operation at 500 meters. The maximum ambient temperature is typically derated by 1°C per 1000 meters (starting at 500 meters above sea level).

3. The panel determines if there are temperature limits.

If "✓" is marked for the installed component, it can be used at the maximum ambient temperature of the complete system without problems.

If there is a specific temperature next to the component, for example "45", then the ambient temperature of the complete system is not permitted to exceed this temperature.

2.3.1.3 Minimum ambient temperature during operation

The minimum ambient temperature for non-condensing operation is 0°C.

2.3.1.4 Ambient temperature during storage and transport

The following table provides an overview of the minimum and maximum ambient temperatures for storing and transporting individual components.

Display type	Model number	Storage	Transport
5.7" single-touch	5AP1120.0573-000	-25 to 80°C	-25 to 80°C
5.7" with keys	5AP1151.0573-000	-25 to 70°C	-25 to 70°C
7.0" single-touch	5AP1120.0702-000	-25 to 80°C	-25 to 80°C
7.0" multi-touch	5AP1130.0702-000	-25 to 70°C	-25 to 70°C
10.1" single-touch	5AP1120.101E-000	-25 to 70°C	-25 to 70°C
10.1" multi-touch	5AP1130.101E-000	-25 to 70°C	-25 to 70°C
10.4" single-touch	5AP1120.1043-000	-25 to 80°C	-25 to 80°C
10.4" single-touch with keys	5AP1180.1043-000	-25 to 70°C	-25 to 70°C
10.4" single-touch with keys	5AP1181.1043-000	-25 to 70°C	-25 to 70°C
10.4" single-touch with keys	5AP1182.1043-000	-25 to 70°C	-25 to 70°C
12.1" single-touch	5AP1120.1214-000	-25 to 80°C	-25 to 80°C
12.1" single-touch	5AP1120.121E-000	-25 to 80°C	-25 to 80°C
12.1" multi-touch	5AP1130.121E-000	-25 to 70°C	-25 to 70°C
15.0" single-touch	5AP1120.1505-000	-25 to 80°C	-25 to 80°C
15.0" single-touch with keys	5AP1180.1505-000	-25 to 80°C	-25 to 80°C
15.0" single-touch with keys	5AP1181.1505-000	-25 to 80°C	-25 to 80°C
15.6" single-touch	5AP1120.156B-000	-25 to 70°C	-25 to 70°C
15.6" multi-touch	5AP1130.156C-000	-20 to 70°C	-20 to 70°C
18.5" multi-touch	5AP1130.185C-000	-25 to 70°C	-25 to 70°C
19.0" single-touch	5AP1120.1906-000	-25 to 70°C	-25 to 70°C

Table 16: AP1000 panels - Ambient temperature during storage and transport

Link module	Model number	Storage	Transport
SDL/DVI receiver	5DLSDL.1001-00	-20 to 60°C	-20 to 60°C
SDL3 receiver	5DLSD3.1001-00	-20 to 60°C	-20 to 60°C
SDL4 receiver	5DLSD4.1001-00	-20 to 60°C	-20 to 60°C

Table 17: Link modules - Ambient temperature during storage and transport

2.3.1.5 Temperature monitoring

A sensor in the display monitors the temperature of the AP1000 panel. The location of the temperature sensor is illustrated in [Tab. 18 "Temperature sensor position" on page 34](#). The values listed in [Tab. 18 "Temperature sensor position" on page 34](#) represent the defined maximum temperature for this measurement point. An alarm is not triggered if this temperature is exceeded.

These temperatures ¹⁾ can be read in various ways in approved operating systems:

- BIOS
- B&R Control Center²⁾
- B&R ADI Development Kit²⁾
- B&R ADI .NET SDK²⁾
- B&R HMI Service Center²⁾
- B&R HMI Diagnose²⁾
- B&R PVI ADI line²⁾
- B&R ADI SNMP Agent²⁾
- Automation Runtime Library²⁾

For applications that do not run in approved operating systems, temperatures can be evaluated using the B&R implementation guide. In addition to the implementation guide, programs in MS-DOS are also available.

¹⁾ The temperature measured approximates the immediate ambient temperature but may also be influenced by neighboring components.

²⁾ Drivers for approved operating systems can be downloaded at no cost from the Downloads section of the B&R website (www.br-automation.com).

2.3.1.6 Temperature sensor positions

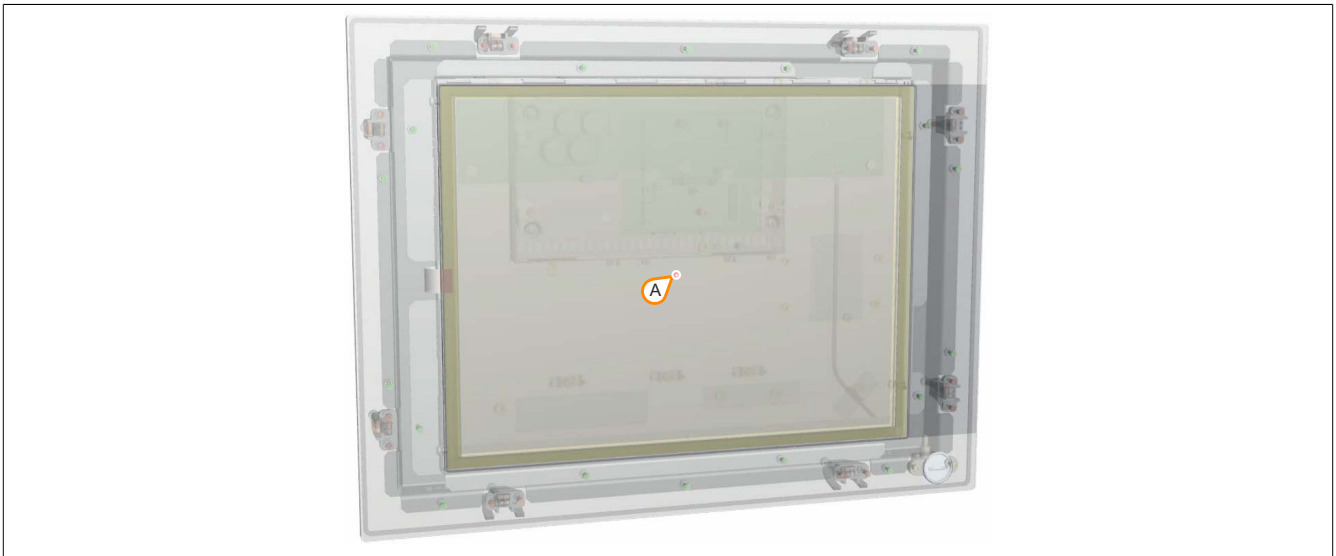

Figure 8: Automation Panel 1000 - Temperature sensor position

ADI sensors	Position	Measurement point for	Measurement	Max. specified
Panel	A	Display	Temperature of the display (sensor integrated in panel).	5AP1120.0573-000: 80°C 5AP1151.0573-000: 80°C 5AP1120.0702-000: 85°C 5AP1130.0702-000: 85°C 5AP1120.101E-000: 80°C 5AP1130.101E-000: 80°C 5AP1120.1043-000: 90°C 5AP1180.1043-000: 90°C 5AP1181.1043-000: 90°C 5AP1182.1043-000: 90°C 5AP1120.1214-000: 80°C 5AP1120.121E-000: 80°C 5AP1130.121E-000: 80°C 5AP1120.1505-000: 90°C 5AP1180.1505-000: 90°C 5AP1181.1505-000: 90°C 5AP1120.156B-000: 80°C 5AP1130.156C-000: 80°C 5AP1130.185C-000: 80°C 5AP1120.1906-000: 80°C

Table 18: Temperature sensor position

2.3.2 Humidity

The following table shows the minimum and maximum relative humidity values (non-condensing) of the individual components that are relevant to the humidity limitations of the complete system. The lowest and highest common values are always used for this determination.

Display type	Model number	Operation	Storage	Transport
5.7" single-touch	5AP1120.0573-000 ≤ Rev. D0	5 to 90%	5 to 90%	5 to 90%
5.7" single-touch	5AP1120.0573-000 ≥ Rev. E0	20 to 90%	10 to 90%	10 to 90%
5.7" with keys	5AP1151.0573-000 ≤ Rev. D0	5 to 90%	5 to 90%	5 to 90%
5.7" with keys	5AP1151.0573-000 ≥ Rev. E0	20 to 90%	10 to 90%	10 to 90%
7.0" single-touch	5AP1120.0702-000	20 to 90%	10 to 90%	10 to 90%
7.0" multi-touch	5AP1130.0702-000	20 to 90%	10 to 90%	10 to 90%
10.1" single-touch	5AP1120.101E-000	20 to 90%	10 to 90%	10 to 90%
10.1" multi-touch	5AP1130.101E-000	20 to 90%	10 to 90%	10 to 90%
10.4" single-touch	5AP1120.1043-000	5 to 90%	5 to 90%	5 to 90%
10.4" single-touch with keys	5AP1180.1043-000	5 to 80%	5 to 90%	5 to 90%
10.4" single-touch with keys	5AP1181.1043-000	5 to 80%	5 to 90%	5 to 90%
10.4" single-touch with keys	5AP1182.1043-000	5 to 80%	5 to 90%	5 to 90%
12.1" single-touch	5AP1120.1214-000	20 to 90%	10 to 90%	10 to 90%
12.1" single-touch	5AP1120.121E-000	5 to 90%	5 to 90%	5 to 90%
12.1" multi-touch	5AP1130.121E-000	5 to 90%	5 to 90%	5 to 90%
15.0" single-touch	5AP1120.1505-000	8 to 90%	8 to 90%	8 to 90%
15.0" single-touch with keys	5AP1180.1505-000	8 to 90%	8 to 90%	8 to 90%
15.0" single-touch with keys	5AP1181.1505-000	8 to 90%	8 to 90%	8 to 90%
15.6" single-touch	5AP1120.156B-000	5 to 90%	5 to 90%	5 to 90%
15.6" multi-touch	5AP1130.156C-000	5 to 90%	5 to 90%	5 to 90%
18.5" multi-touch	5AP1130.185C-000	5 to 90%	5 to 90%	5 to 90%
19.0" single-touch	5AP1120.1906-000	5 to 90%	5 to 90%	5 to 90%

Table 19: AP1000 panels - Relative humidity

All values apply to non-condensing operation/storage/transport.

Link module type	Model number	Operation	Storage	Transport
SDL/DVI receiver	5DLSDL.1001-00	5 to 90%	5 to 95%	5 to 95%
SDL3 receiver	5DLS3.1001-00	5 to 90%	5 to 95%	5 to 95%
SDL4 receiver	5DLS4.1001-00	5 to 90%	5 to 95%	5 to 95%

Table 20: Link modules - Humidity

The specifications listed correspond to the relative humidity (non-condensing) at an ambient temperature of 30°C. For more detailed information about specific temperature-dependent humidity values, see the technical data for the individual components.

2.3.3 Vibration

The following table provides an overview of the maximum vibration values of the complete system. Limitations are possible through the use of individual components.

	Operation ¹⁾		Storage ¹⁾²⁾	Transport ¹⁾²⁾
	Continuous	Periodic		
Automation Panel 1000	2 to 9 Hz: 1.75 mm amplitude 9 to 200 Hz: 0.5 g	2 to 9 Hz: 3.5 mm amplitude 9 to 200 Hz: 1 g	2 to 8 Hz: 7.5 mm amplitude 8 to 200 Hz: 2 g 200 to 500 Hz: 4 g	2 to 8 Hz: 7.5 mm amplitude 8 to 200 Hz: 2 g 200 to 500 Hz: 4 g

Table 21: Vibration

- 1) Testing is performed in accordance with EN 60068-2-6.
- 2) This value applies to a device in its original packaging.

2.3.4 Shock

The following table provides an overview of the maximum shock values of the complete system. Limitations are possible through the use of individual components.

	Operation ¹⁾	Storage ¹⁾²⁾	Transport ¹⁾²⁾
Automation Panel 1000	15 g, 11 ms	30 g, 6 ms	30 g, 6 ms

Table 22: Shock

- 1) Testing is performed in accordance with EN 60068-2-27.
- 2) This value applies to a device in its original packaging.

2.3.5 Protection

In accordance with EN 60529, the Automation Panel 1000 has IP65 protection on the front and IP20 protection on the back under the following conditions:

- The Automation Panel 1000 is installed correctly (see ["Installation" on page 127](#)).
- All covers and components are installed on the interfaces and slots.
- All environmental conditions are observed.

In accordance with UL 50 "Type 4X indoor use only" also applies to the front of the Automation Panel 1000 under the same conditions.

2.4 Electrical characteristics

2.4.1 +24 VDC power supply

Danger!

This device is only permitted to be supplied by a SELV/PELV power supply or with safety extra-low voltage (SELV) per EN 60950.

The 3-pin male connector required for connecting the power supply is not included in delivery. It can be ordered from B&R using model number 0TB103.9 (screw clamp terminal block) or 0TB103.91 (cage clamp terminal block).

For the pinout, see the following table. The supply voltage is protected internally by a soldered fuse (10 A, fast-acting) to prevent damage to the device in the event of overload (fuse replacement necessary) or if the voltage supply is connected incorrectly (reverse polarity protection → fuse replacement not necessary). The device must be returned to B&R for repairs if the fuse is destroyed in the event of error.

+24 VDC power supply	
Protected against reverse polarity	
Pin	Description
1	+
2	Functional ground
3	-
Model number	Short description
	Terminal blocks
0TB103.9	Male connector 24 V 5.08 3-pin screw clamp terminal block
0TB103.91	Male connector 24 V 5.08 3-pin cage clamp terminal block

3-pin male power supply connector
+24 VDC power supply



Table 23: +24 VDC voltage supply connection

Electrical characteristics	
Nominal voltage	24 VDC ±25%, SELV ¹⁾
Nominal current	Max. 3 A
Overvoltage category in accordance with EN 61131-2	II
Electrical isolation	Yes
Uninterruptible power supply	No

1) EN 60950 requirements must be observed.

2.4.2 Power calculation

In order to calculate the total power of the Automation Panel, the power rating of the display being used must be added to the power rating of the link module being used.

The following specifications are maximum values without additional consumers (USB devices, etc.).

Link module	Model number	Total power consumption of link module
SDL/DVI receiver	5DLSL.1001-00	Max. 3.6 W without USB consumer Max. 8.6 W with USB consumer
SDL3 receiver	5DLS3.1001-00	Max. 8.1 W without USB consumer Max. 13.1 W with USB consumer
SDL4 receiver	5DLS4.1001-00	Max. 8.1 W without USB consumer Max. 13.1 W with USB consumer

Table 24: Link modules - Power calculation

The following specifications are maximum values without additional consumers (USB devices, etc.).

Display type	Model number	+5 V	3V3	+12 V	Power consumption Total
5.7" single-touch	5AP1120.0573-000	-	0.7 W	2.5 W	3.2 W
5.7" with keys	5AP1151.0573-000	0.5 W	1.3 W	2.5 W	4.3 W
7.0" single-touch	5AP1120.0702-000	-	1.0 W	3.5 W	4.5 W
7.0" multi-touch	5AP1130.0702-000	1.0 W	1.0 W	3.5 W	5.5 W
10.1" single-touch	5AP1120.101E-000	-	1.0 W	5.8 W	6.8 W
10.1" multi-touch	5AP1130.101E-000	1.0 W	1.0 W	5.8 W	7.8 W
10.4" single-touch	5AP1120.1043-000	-	1.3 W	3.6 W	4.9 W
10.4" single-touch with keys	5AP1180.1043-000	0.5 W	1.9 W	3.6 W	6.0 W
10.4" single-touch with keys	5AP1181.1043-000	0.7 W	1.9 W	3.6 W	6.2 W
10.4" single-touch with keys	5AP1182.1043-000	1.0 W	1.9 W	3.6 W	6.5 W
12.1" single-touch	5AP1120.1214-000	-	1.9 W	7.0 W	8.9 W
12.1" single-touch	5AP1120.121E-000	-	2.5 W	7.8 W	10.3 W
12.1" multi-touch	5AP1130.121E-000	1.0 W	2.5 W	7.8 W	11.3 W
15.0" single-touch	5AP1120.1505-000	-	2.1 W	8.9 W	11.0 W
15.0" single-touch with keys	5AP1180.1505-000	0.5 W	2.7 W	8.9 W	12.1 W
15.0" single-touch with keys	5AP1181.1505-000	0.8 W	2.7 W	8.9 W	12.4 W
15.6" single-touch	5AP1120.156B-000	1.8 W	-	15.6 W	17.4 W
15.6" multi-touch	5AP1130.156C-000	6 W	-	18 W	24 W
18.5" multi-touch	5AP1130.185C-000	7 W	-	18.6 W	25.6 W
19.0" single-touch	5AP1120.1906-000	5.0 W	-	22.0 W	27.0 W

Table 25: AP1000 panels - Power calculation

Example

15" panel 5AP1120.1505-000	2.1 W + 8.9 W	11.0 W
5DLSL.1001-00 SDL/DVI receiver	8.6 W (with USB consumers)	8.6 W
	Total max.:	19.6 W

2.4.3 Block diagrams

The following block diagram shows the simplified structure of the 5DLSDL.1001-00 SDL/DVI receiver link module.

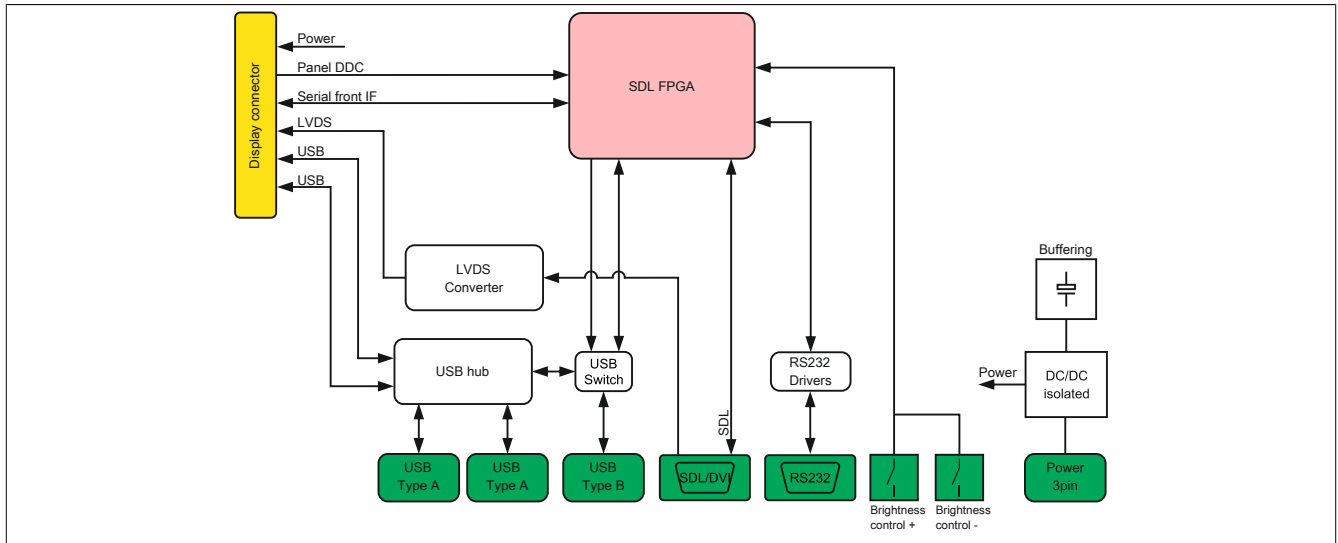

Figure 9: SDL/DVI receiver link module - Block diagram

The following block diagram shows the simplified structure of the 5DLSD3.1001-00 SDL3 receiver link module.

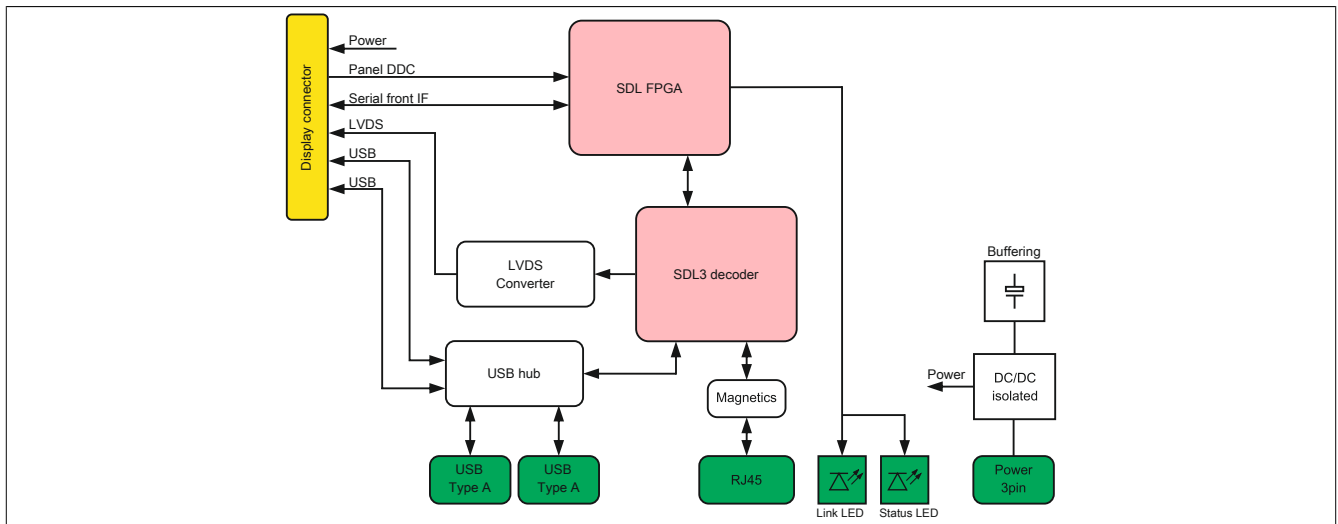

Figure 10: SDL3 receiver link module - Block diagram

The following block diagram shows the simplified structure of the 55DLSD4.1001-00 SDL4 receiver link module.

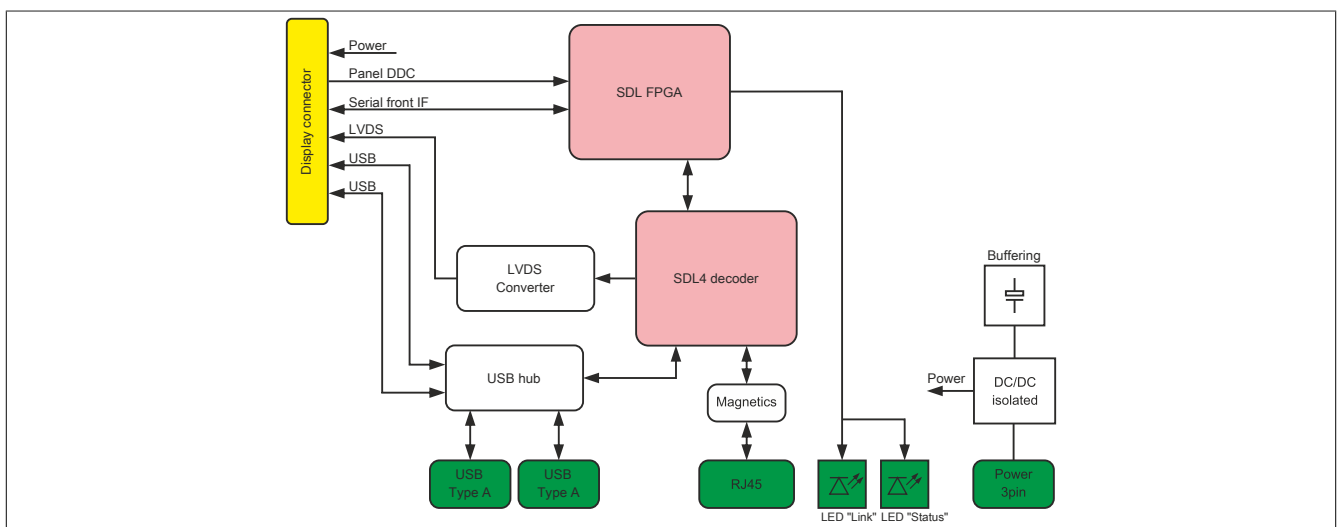

Figure 11: SDL4 receiver link module - Block diagram

2.5 SDL/DVI receiver - 5DLSDL.1001-00 device interfaces

2.5.1 Overview

SDL/DVI receiver interfaces are located on the back of the Automation Panel 1000.

Information about SDL/DVI mode can be found in sections ["SDL operation" on page 18](#) and ["DVI operation" on page 20](#).

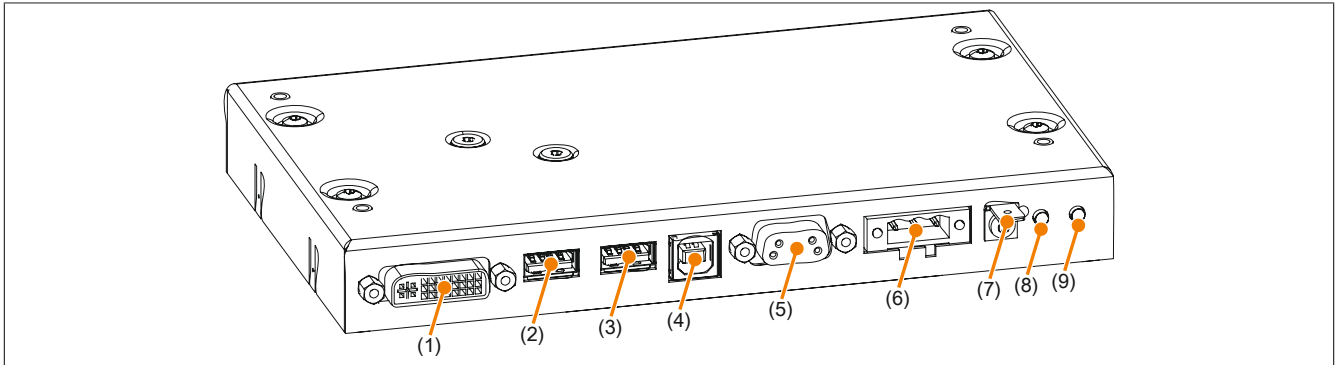

Figure 12: Overview of interfaces - SDL/DVI receiver link module

No.	Type of interface		No.	Type of interface	
1	Panel In SDL/DVI	"Panel In interface"	6	24 VDC power	"+24 VDC power supply"
2	USB1	"USB interfaces"	7	Grounding	"Grounding"
3	USB2	"USB interfaces"	8	Brightness (DVI) +	"Brightness controls"
4	USB In	"USB In interface"	9	Brightness (DVI) -	"Brightness controls"
5	COM	"COM serial interface"			

2.5.2 +24 VDC power supply

Danger!

This device is only permitted to be supplied by a SELV/PELV power supply or with safety extra-low voltage (SELV) per EN 60950.

The 3-pin male connector required for connecting the power supply is not included in delivery. It can be ordered from B&R using model number 0TB103.9 (screw clamp terminal block) or 0TB103.91 (cage clamp terminal block).

For the pinout, see the following table. The supply voltage is protected internally by a soldered fuse (10 A, fast-acting) to prevent damage to the device in the event of overload (fuse replacement necessary) or if the voltage supply is connected incorrectly (reverse polarity protection → fuse replacement not necessary). The device must be returned to B&R for repairs if the fuse is destroyed in the event of error.

+24 VDC power supply	
Protected against reverse polarity	
Pin	Description
1	+
2	Functional ground
3	-
Model number	Short description
Terminal blocks	
0TB103.9	Male connector 24 V 5.08 3-pin screw clamp terminal block
0TB103.91	Male connector 24 V 5.08 3-pin cage clamp terminal block

3-pin male power supply connector
+24 VDC power supply



Table 26: +24 VDC voltage supply connection

Electrical characteristics	
Nominal voltage	24 VDC ±25%, SELV ¹⁾
Nominal current	Max. 3 A
Overvoltage category in accordance with EN 61131-2	II
Electrical isolation	Yes
Uninterruptible power supply	No

1) EN 60950 requirements must be observed.

2.5.2.1 Grounding

Caution!

Functional ground (pin 2 of power supply and ground connection) must be kept as short as possible and connected to the largest possible wire cross section at the central grounding point (e.g. the control cabinet or system).

The ground connection is located next to the power supply for the link module.

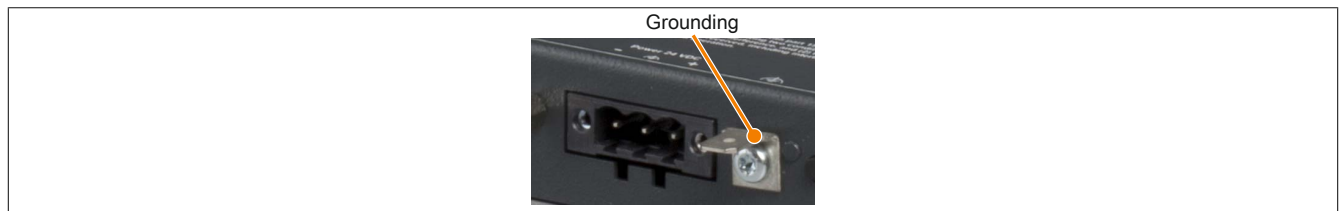

Figure 13: Ground connection

The ground connection must be used, for example, to fasten a copper strip to a central grounding point in the control cabinet or system where the device is installed. The largest possible conductor cross section should be used (at least 2.5 mm²).

2.5.3 Panel In interface

The Panel In interface can be used for SDL or DVI transfer. For more information, see "SDL operation" on page 18 and "DVI operation" on page 20.

Panel In interface - SDL (Smart Display Link) / DVI	
The following overview lists the video signals available on the panel input. For additional details, see the technical data for the link module or panel being used.	
Link module	Video signals
5DLSDL.1001-00	SDL, DVI



Table 27: Panel In interface - SDL, DVI

Information:

The hardware and graphics drivers of approved operating systems support the hot plugging of display devices to the Panel In interface for service purposes. The panel connector is specified for max. 100 connection cycles.

Information:

If a display device with touch screen is connected to the Panel In interface and then disconnected again during operation (hot plugging), it may be necessary to recalibrate the touch screen.

2.5.3.1 Pinout

Pin	Assignment	Description	Pin	Assignment	Description
1	TMDS data 2-	DVI lane 2 (negative)	16	HPD	Hot plug detect
2	TMDS data 2+	DVI lane 2 (positive)	17	TMDS data 0-	DVI lane 0 (negative)
3	TMDS data 2/4 SHIELD	Shield for data pair 2 and 4	18	TMDS data 0+	DVI lane 0 (positive)
4	SDL-	SDL lane (negative)	19	TMDS Data 0/ XUSB1 SHIELD	Shield for data pair 0 and USB1
5	SDL+	SDL lane (positive)	20	XUSB1-	USB lane 1 (negative)
6	DDC clock	DDC-based control signal (clock)	21	XUSB1+	USB lane 1 (positive)
7	DDC data	DDC-based control signal (data)	22	TMDS clock shield	Shield for clock pair
8	N/C	Not connected	23	TMDS clock+	DVI clock (positive)
9	TMDS data 1-	DVI lane 1 (negative)	24	TMDS clock -	DVI clock (negative)
10	TMDS DATA 1+	DVI lane 1 (negative) HDMI clock (positive)	C1	N/C	Not connected
11	TMDS DATA 1/ XUSB0 SHIELD	Shield for data pair 1 and USB0	C2	N/C	Not connected
12	XUSB0-	USB lane 0 (negative)	C3	N/C	Not connected
13	XUSB0+	USB lane 0 (positive)	C4	N/C	Not connected
14	+5 V power	+5 V power supply	C5	N/C	Not connected
15	Ground (return for +5 V, HSync and VSync)	Ground			

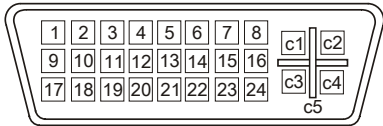

Table 28: DVI interface - Pinout

2.5.3.2 USB transfer in SDL and DVI mode

Information:

The USB transfer rate is limited to USB 1.1 in SDL mode.

In DVI mode, the maximum USB transfer rate depends on the USB interface and USB hub on the industrial PC.

2.5.3.3 Cable lengths and resolutions for SDL transmission

The following table lists the relationship between segment lengths and maximum resolution depending on the SDL cable being used:

SDL cable Segment length [m]	Resolution						
	VGA 640 x 480	SVGA 800 x 600	XGA 1024 x 768	HD 1366 x 768	SXGA 1280 x 1024	UXGA 1600 x 1200	FHD 1920 x 1080
0.8	5CASDL.0008-00	5CASDL.0008-00	5CASDL.0008-00	5CASDL.0008-00	5CASDL.0008-00	5CASDL.0008-00	5CASDL.0008-00
1.8	5CASDL.0018-00	5CASDL.0018-00	5CASDL.0018-00	5CASDL.0018-00	5CASDL.0018-00	5CASDL.0018-00	5CASDL.0018-00
	5CASDL.0018-01	5CASDL.0018-01	5CASDL.0018-01	5CASDL.0018-01	5CASDL.0018-01	5CASDL.0018-01	5CASDL.0018-01
	5CASDL.0018-03	5CASDL.0018-03	5CASDL.0018-03	5CASDL.0018-03	5CASDL.0018-03	5CASDL.0018-03	5CASDL.0018-03
5	5CASDL.0050-00	5CASDL.0050-00	5CASDL.0050-00	5CASDL.0050-00	5CASDL.0050-00	5CASDL.0050-00	5CASDL.0050-00
	5CASDL.0050-01	5CASDL.0050-01	5CASDL.0050-01	5CASDL.0050-01	5CASDL.0050-01	5CASDL.0050-01	5CASDL.0050-01
	5CASDL.0050-03	5CASDL.0050-03	5CASDL.0050-03	5CASDL.0050-03	5CASDL.0050-03	5CASDL.0050-03	5CASDL.0050-03
10	5CASDL.0100-00	5CASDL.0100-00	5CASDL.0100-00	5CASDL.0100-00	5CASDL.0100-00	5CASDL.0100-00	5CASDL.0100-00
	5CASDL.0100-01	5CASDL.0100-01	5CASDL.0100-01	5CASDL.0100-01	5CASDL.0100-01	5CASDL.0100-01	5CASDL.0100-01
	5CASDL.0100-03	5CASDL.0100-03	5CASDL.0100-03	5CASDL.0100-03	5CASDL.0100-03	5CASDL.0100-03	5CASDL.0100-03
15	5CASDL.0150-00	5CASDL.0150-00	5CASDL.0150-00	5CASDL.0150-00	5CASDL.0150-00	-	-
	5CASDL.0150-01	5CASDL.0150-01	5CASDL.0150-01	5CASDL.0150-01	5CASDL.0150-01	-	-
	5CASDL.0150-03	5CASDL.0150-03	5CASDL.0150-03	5CASDL.0150-03	5CASDL.0150-03	-	5CASDL.0150-03
20	5CASDL.0200-00	5CASDL.0200-00	5CASDL.0200-00	5CASDL.0200-00	5CASDL.0200-00	-	-
	5CASDL.0200-03	5CASDL.0200-03	5CASDL.0200-03	5CASDL.0200-03	5CASDL.0200-03	-	5CASDL.0200-03
25	5CASDL.0250-00	5CASDL.0250-00	5CASDL.0250-00	5CASDL.0250-00	-	-	-
	5CASDL.0250-03	5CASDL.0250-03	5CASDL.0250-03	5CASDL.0250-03	-	-	-
30	5CASDL.0300-00	5CASDL.0300-00	-	-	-	-	-
	5CASDL.0300-03	5CASDL.0300-03	5CASDL.0300-13	5CASDL.0300-13	5CASDL.0300-13	-	5CASDL.0300-13
40	5CASDL.0400-13	5CASDL.0400-13	5CASDL.0400-13	5CASDL.0400-13	5CASDL.0400-13	-	5CASDL.0400-13

Table 29: Cable lengths and resolutions for SDL transmission

2.5.3.4 Cable lengths and resolutions for DVI transfer

The following table shows the relationship between segment length and maximum resolution depending on the DVI cable:

DVI cable Segment length [m]	Resolution						
	VGA 640 x 480	SVGA 800 x 600	XGA 1024 x 768	HD 1366 x 768	SXGA 1280 x 1024	UXGA 1600 x 1200	FHD 1920 x 1080
1.8	5CADVI.0018-00	5CADVI.0018-00	5CADVI.0018-00	5CADVI.0018-00	5CADVI.0018-00	5CADVI.0018-00	5CADVI.0018-00
5	5CADVI.0050-00	5CADVI.0050-00	5CADVI.0050-00	5CADVI.0050-00	5CADVI.0050-00	5CADVI.0050-00	5CADVI.0050-00

Table 30: Cable lengths and resolutions for DVI transfer

The maximum cable length for DVI transfer is limited to 5 m due to the USB specification.

2.5.4 USB interfaces

The link module is equipped with a USB 2.0 (Universal Serial Bus) host controller with multiple USB interfaces, 2 of which are accessible externally for the user.

Warning!

Peripheral USB devices can be connected to the USB interfaces. Due to the large number of USB devices available on the market, B&R cannot guarantee their functionality. Functionality is ensured when using the USB devices available from B&R.

Caution!

Because this interface is designed according to general PC specifications, extreme care should be exercised with regard to EMC, cable routing, etc.

USB1, USB2

The USB1 and USB2 interfaces are available for the user to connect USB devices.

Depending on the transfer method (SDL or DVI mode), the transfer rate of the USB1 and USB2 interfaces may be limited. Possible transfer methods are listed in section "Connection options" on page 18.

Transfer method	USB type	Max. cable length
SDL mode 1	USB 1.1	40 m ¹⁾
SDL mode 2	USB 2.0	5 m
DVI mode, single-touch	USB 2.0	5 m
DVI mode, multi-touch	USB 2.0	5 m

1) The max. cable length of 40 m depends on the resolution; see table "Cable lengths and resolutions for SDL transfer" on page for exact specifications.

Universal Serial Bus (USB1, USB2) ¹⁾	
Type	USB 2.0
Design	Type A
Transfer rate	Low speed (1.5 Mbit/s), full speed (12 Mbit/s), high speed (480 Mbit/s)
Current-carrying capacity ²⁾ USB1, USB2	Total max. 1 A
Cable length USB 2.0	Max. 5 m (without hub)

2x USB type A, female

USB1



USB2

Table 31: USB1/USB2 interface

- 1) The interfaces, etc. available on the device or module have been numbered as such for easy identification. This numbering may differ from that used by the particular operating system.
- 2) Each USB interface is protected by a shared, maintenance-free "USB current-limiting circuit breaker" (total max. 1 A).

Front USB

Automation Panel 1000 systems with 10.4", 12.1" (4:3 format only), 15" (4:3 format only) and 19" display sizes are equipped with a USB 2.0 interface on the front. For more information, see section "USB interface" on page 59.

2.5.5 USB In interface

The USB In interface is a USB 2.0 type B interface that is used to transfer USB data. It must be connected to the USB interface on the output device (e.g. B&R Industrial PC) when using DVI mode or SDL operating mode 2 as the transfer method. Possible transfer methods are listed in section "Connection options" on page 18.

If the interface is connected to an output device (B&R Industrial PC), then USB 2.0 transfer rates are possible on the USB1 and USB2 interfaces.

USB In interface ¹⁾	
Type	USB 2.0
Design	Type B
Transfer rate	Low speed (1.5 Mbit/s), full speed (12 Mbit/s), high speed (480 Mbit/s)
Current-carrying capacity ²⁾	Max. 500 mA
Cable length	Max. 5 m (without hub)

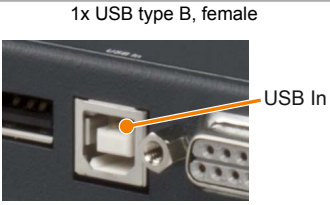

Table 32: USB In interface

- 1) The interfaces, etc. available on the device or module have been numbered as such for easy identification. This numbering may differ from that used by the particular operating system.
- 2) Each USB interface is protected by a maintenance-free "USB current-limiting circuit breaker" (max. 500 mA).

2.5.6 COM serial interface

The serial interface is only available for use with single-touch displays in DVI mode. It is used to transfer data from the resistive touch screen and must be connected to a serial interface on the output device.

COM serial interface ¹⁾	
RS232	
Type	RS232, modem-capable, not electrically isolated
UART	16550-compatible, 16-byte FIFO
Transfer rate	Max. 115 kbit/s
Bus length	Max. 15 m
Pin	Assignment
1	N/C
2	RXD
3	TXD
4	N/C
5	GND
6	N/C
7	RTS
8	CTS
9	N/C

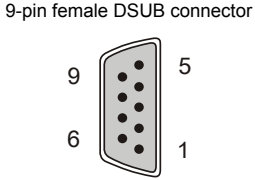

Table 33: COM - Pinout

- 1) The interfaces, etc. available on the device or module have been numbered as such for easy identification. This numbering may differ from that used by the particular operating system.

2.5.7 Brightness controls

The brightness controls can be used to configure the brightness of the backlight on the Automation Panel in DVI mode. These buttons have no effect in SDL mode; in this case, the brightness can be configured in the B&R Control Center, for example.

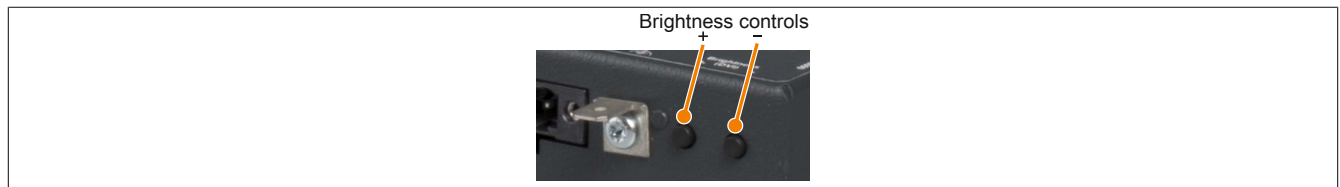

Figure 14: Brightness controls

2.6 5DLSD3.1001-00 SDL3 receiver - Device interfaces

2.6.1 Overview

SDL3 receiver interfaces are located on the back of the Automation Panel 1000.

Information about SDL3 mode can be found in section "[SDL3 mode](#)" on page 21.

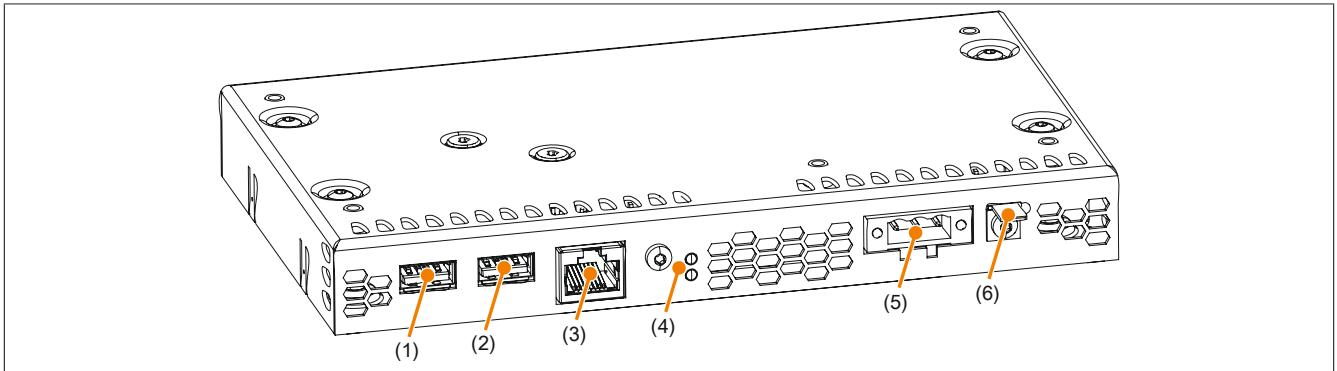

Figure 15: Overview of interfaces - SDL3 receiver link module

No.	Type of interface	No.	Type of interface
1	USB1	4	SDL3 In LEDs
2	USB2	5	24 VDC power
3	SDL3 In	6	Grounding

2.6.2 +24 VDC power supply

Danger!

This device is only permitted to be supplied by a SELV/PELV power supply or with safety extra-low voltage (SELV) per EN 60950.

The 3-pin male connector required for connecting the power supply is not included in delivery. It can be ordered from B&R using model number 0TB103.9 (screw clamp terminal block) or 0TB103.91 (cage clamp terminal block).

For the pinout, see the following table. The supply voltage is protected internally by a soldered fuse (10 A, fast-acting) to prevent damage to the device in the event of overload (fuse replacement necessary) or if the voltage supply is connected incorrectly (reverse polarity protection → fuse replacement not necessary). The device must be returned to B&R for repairs if the fuse is destroyed in the event of error.

+24 VDC power supply	
Protected against reverse polarity	
Pin	Description
1	+
2	Functional ground
3	-
Model number	Short description
	Terminal blocks
0TB103.9	Male connector 24 V 5.08 3-pin screw clamp terminal block
0TB103.91	Male connector 24 V 5.08 3-pin cage clamp terminal block

3-pin male power supply connector
+24 VDC power supply



Table 34: +24 VDC voltage supply connection

Electrical characteristics	
Nominal voltage	24 VDC ±25%, SELV ¹⁾
Nominal current	Max. 3 A
Overvoltage category in accordance with EN 61131-2	II
Electrical isolation	Yes
Uninterruptible power supply	No

1) EN 60950 requirements must be observed.

2.6.2.1 Grounding

Caution!

Functional ground (pin 2 of power supply and ground connection) must be kept as short as possible and connected to the largest possible wire cross section at the central grounding point (e.g. the control cabinet or system).

The ground connection is located next to the power supply for the link module.

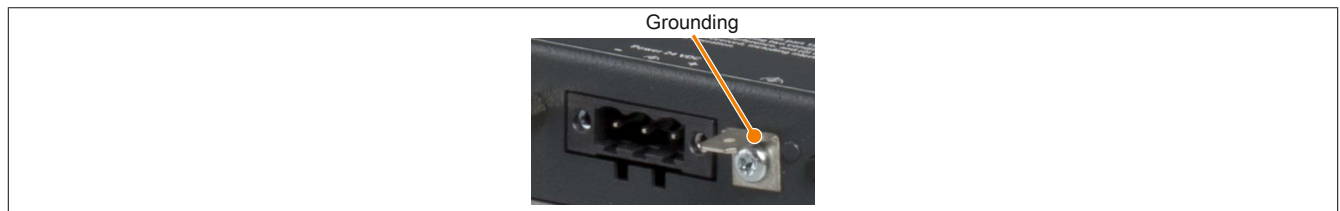

Figure 16: Ground connection

The ground connection must be used, for example, to fasten a copper strip to a central grounding point in the control cabinet or system where the device is installed. The largest possible conductor cross section should be used (at least 2.5 mm²).

2.6.3 SDL3 In interface

The SDL3 In interface is a female RJ45 connector and operated with SDL3 transmission technology. For more information, see section "SDL3 mode" on page 21.

SDL3 In interface - SDL3	
The following overview lists the video signals available on the panel input. For additional details, see the technical data for the link module or panel being used.	
Link module	Video signals
5DLSD3.1001-00	SDL3

Female RJ45 connector

1

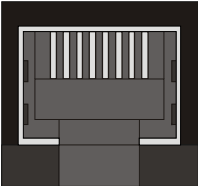

Table 35: SDL3 In interface

Information:

The hardware and graphics drivers of approved operating systems support the hot plugging of display devices to the SDL3 In interface for service purposes. The female RJ45 connector is specified for 500 connection cycles.

Information:

If a display device with touch screen is connected to the SDL3 In interface and then disconnected again during operation (hot plugging), it may be necessary to recalibrate the touch screen.

2.6.3.1 Cable lengths and resolutions for SDL3 transmission

The maximum cable length for SDL3 transfers is 100 m with a B&R SDL3/SDL4 cable (regardless of the panel resolution).

2.6.4 SDL3 In LEDs

The SDL3 In LEDs are located next to the SDL3 In interface.

SDL3 In LEDs			
LED	Color	Status	Function
Link	Yellow	On	Indicates an active SDL3 connection
		Off	No active SDL3 connection
Status	Yellow	On	SDL3 connection established and OK
		Off	No active SDL3 connection
		Blinking	Indicates the SDL3 connection is OK, but a firmware image is corrupt



Table 36: SDL3 In LEDs

2.6.5 USB interfaces

The link module is equipped with a USB 2.0 (Universal Serial Bus) host controller with multiple USB interfaces, 2 of which are accessible externally for the user.

Warning!

Peripheral USB devices can be connected to the USB interfaces. Due to the large number of USB devices available on the market, B&R cannot guarantee their functionality. Functionality is ensured when using the USB devices available from B&R.

Caution!

Because this interface is designed according to general PC specifications, extreme care should be exercised with regard to EMC, cable routing, etc.

USB1, USB2

The USB1 and USB2 interfaces are available for the user to connect USB devices.

Universal Serial Bus (USB1, USB2) ¹⁾	
Type	USB 2.0
Design	Type A
Transfer rate	Low speed (1.5 Mbit/s), full speed (12 Mbit/s), high speed (30 Mbit/s)
Current-carrying capacity ²⁾ USB1, USB2	Total max. 1 A
Cable length USB 2.0	Max. 5 m (without hub)

2x USB type A, female

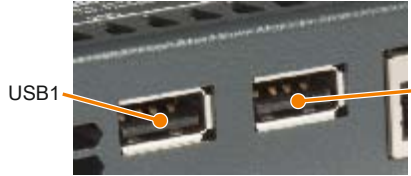

Table 37: USB1/USB2 interface

- 1) The interfaces, etc. available on the device or module have been numbered as such for easy identification. This numbering may differ from that used by the particular operating system.
- 2) The USB interfaces are protected by a shared, maintenance-free "USB current-limiting circuit breaker" (total max. 1 A).

Front USB

Automation Panel 1000 systems with 10.4", 12.1" (4:3 format only), 15" (4:3 format only) and 19" display sizes are equipped with a USB 2.0 interface on the front. For more information, see section "[USB interface](#)" on page 59.

2.7 5DLSD4.1001-00 SDL4 receiver - Device interfaces

2.7.1 Overview

SDL4 receiver interfaces are located on the back of the Automation Panel 1000.

For information about SDL4 mode, see section "SDL4 operation" on page 22.

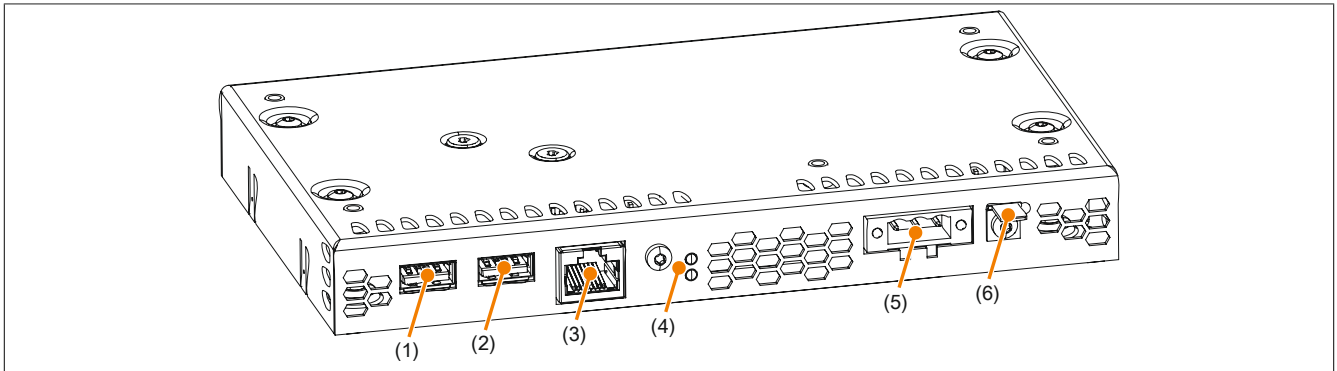

Figure 17: Overview of interfaces - SDL4 receiver link module

No.	Type of interface	No.	Type of interface
1	USB1	4	SDL4 In LEDs
2	USB2	5	24 VDC power
3	SDL4 In	6	Grounding

2.7.2 +24 VDC power supply

Danger!

This device is only permitted to be supplied by a SELV/PELV power supply or with safety extra-low voltage (SELV) per EN 60950.

The 3-pin male connector required for connecting the power supply is not included in delivery. It can be ordered from B&R using model number 0TB103.9 (screw clamp terminal block) or 0TB103.91 (cage clamp terminal block).

For the pinout, see the following table. The supply voltage is protected internally by a soldered fuse (10 A, fast-acting) to prevent damage to the device in the event of overload (fuse replacement necessary) or if the voltage supply is connected incorrectly (reverse polarity protection → fuse replacement not necessary). The device must be returned to B&R for repairs if the fuse is destroyed in the event of error.

+24 VDC power supply	
Protected against reverse polarity	
Pin	Description
1	+
2	Functional ground
3	-
Model number	Short description
	Terminal blocks
0TB103.9	Male connector 24 V 5.08 3-pin screw clamp terminal block
0TB103.91	Male connector 24 V 5.08 3-pin cage clamp terminal block

3-pin male power supply connector
+24 VDC power supply



Table 38: +24 VDC voltage supply connection

Electrical characteristics	
Nominal voltage	24 VDC ±25%, SELV ¹⁾
Nominal current	Max. 3 A
Overvoltage category in accordance with EN 61131-2	II
Electrical isolation	Yes
Uninterruptible power supply	No

1) EN 60950 requirements must be observed.

2.7.2.1 Grounding

Caution!

Functional ground (pin 2 of power supply and ground connection) must be kept as short as possible and connected to the largest possible wire cross section at the central grounding point (e.g. the control cabinet or system).

The ground connection is located next to the power supply for the link module.

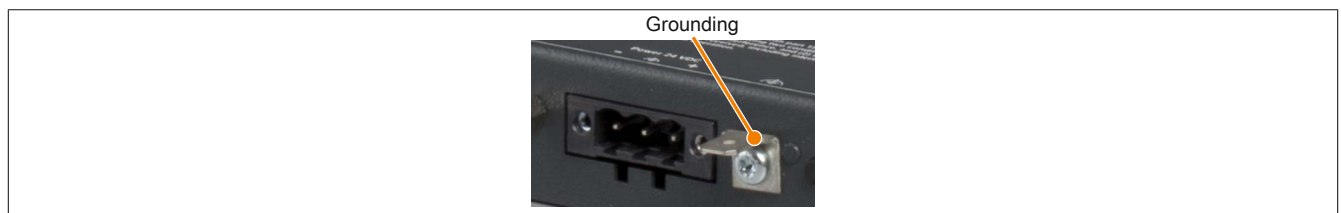

Figure 18: Ground connection

The ground connection must be used, for example, to fasten a copper strip to a central grounding point in the control cabinet or system where the device is installed. The largest possible conductor cross section should be used (at least 2.5 mm²).

2.7.3 SDL4 In interface

The SDL4 In interface is a female RJ45 connector and operated with SDL4 transmission technology. For more information, see section "SDL4 operation" on page 22.

SDL4 In interface - SDL4	
The following overview shows the possible video signals available on the Panel input. For additional details, see the technical data for the link module or panel being used.	
Link module	Video signals
5DLSD4.1001-00	SDL4

RJ45 connector, female

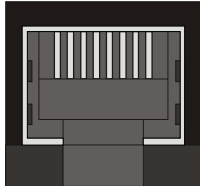

Table 39: SDL4 In interface

Information:

Hot plugging display devices on the SDL4 In interface for service purposes is supported by the hardware and graphics drivers of approved operating systems. The female RJ45 connector is specified for 500 connection cycles.

Information:

If a display device with touch screen is connected to the SDL4 In interface and then disconnected again during operation (hot plugging), it may be necessary to recalibrate the touch screen.

2.7.3.1 Cable lengths and resolutions for SDL4 transfer

The maximum cable length for SDL4 transfers is 100 m with a B&R "SDL3/SDL4 cables" (regardless of the panel resolution).

2.7.4 SDL4 In LEDs

The SDL4 In LEDs are located next to the SDL4 In interface.

SDL4 In LEDs			
LED	Color	Status	Explanation
Link	Yellow	On	Indicates an active SDL4 connection.
		Off	No active SDL4 connection.
Status	Yellow	On	The SDL4 connection is established and OK.
		Off	No active SDL4 connection.
		Blinking	Indicates the SDL4 connection is OK, but a firmware image is corrupt



Table 40: SDL4 In LEDs

2.7.5 USB interfaces

The link module is equipped with a Universal Serial Bus 2.0 (USB) host controller with multiple USB interfaces, 2 of which are accessible externally for the user.

Warning!

Peripheral USB devices can be connected to the USB interfaces. Due to the large number of USB devices available on the market, B&R cannot guarantee their functionality. Functionality is ensured when using the USB devices available from B&R.

Caution!

Because this interface is designed according to general PC specifications, extreme care should be taken with regard to EMC, wiring, etc.

USB1, USB2

The USB1 and USB2 interfaces are available for the user to connect USB devices.

Universal Serial Bus (USB1, USB2) ¹⁾	
Type	USB 2.0
Design	Type A
Transfer rate	Low speed (1.5 Mbit/s), full speed (12 Mbit/s), high speed (150 Mbit/s)
Current-carrying capacity ²⁾ USB1, USB2	Total max. 1 A
Cable length USB 2.0	Max. 5 m (without hub)

2x USB type A, female

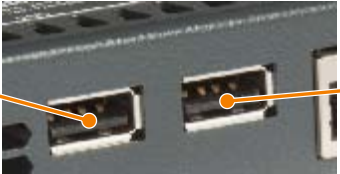

Table 41: USB1/USB2 interface

- 1) The interfaces, etc. available on the device or module have been numbered as such for the purpose of clear differentiation. This numbering may deviate from the numbering used by the respective operating system, however.
- 2) The USB interfaces are protected by a shared maintenance-free "USB current-limiting switch" (total max. 1 A).

Front USB

Automation Panel 1000 systems with 10.4", 12.1" (4:3 format only), 15" (4:3 format only) and 19" display sizes are equipped with a USB 2.0 interface on the front. For more information, see section "[USB interface](#)" on page 59.

2.8 Features of AP1000 panels

A wide selection of different display diagonals as well as panels with touch screen and keys are available. The following table provides an overview of the panels and their features.

Display type	Model number	Resolution	Touch screen	Function keys	System keys	Front USB interface
5.7" single-touch	5AP1120.0573-000	VGA	Single-touch	No	No	No
5.7" with keys	5AP1151.0573-000	VGA	No	Yes	Yes	No
7.0" single-touch	5AP1120.0702-000	WVGA	Single-touch	No	No	No
7.0" multi-touch	5AP1130.0702-000	WVGA	Multi-touch	No	No	No
10.1" single-touch	5AP1120.101E-000	WXGA	Single-touch	No	No	No
10.1" multi-touch	5AP1130.101E-000	WXGA	Multi-touch	No	No	No
10.4" single-touch	5AP1120.1043-000	VGA	Single-touch	No	No	Yes
10.4" single-touch with keys	5AP1180.1043-000	VGA	Single-touch	Yes	No	Yes
10.4" single-touch with keys	5AP1181.1043-000	VGA	Single-touch	Yes	Yes	Yes
10.4" single-touch with keys	5AP1182.1043-000	VGA	Single-touch	Yes	Yes	Yes
12.1" single-touch	5AP1120.1214-000	SVGA	Single-touch	No	No	Yes
12.1" single-touch	5AP1120.121E-000	WXGA	Single-touch	No	No	No
12.1" multi-touch	5AP1130.121E-000	WXGA	Multi-touch	No	No	No
15.0" single-touch	5AP1120.1505-000	XGA	Single-touch	No	No	Yes
15.0" single-touch with keys	5AP1180.1505-000	XGA	Single-touch	Yes	No	Yes
15.0" single-touch with keys	5AP1181.1505-000	XGA	Single-touch	Yes	Yes	Yes
15.6" single-touch	5AP1120.156B-000	HD	Single-touch	No	No	No
15.6" multi-touch	5AP1130.156C-000	FHD	Multi-touch	No	No	No
18.5" multi-touch	5AP1130.185C-000	FHD	Multi-touch	No	No	No
19.0" single-touch	5AP1120.1906-000	SXGA	Single-touch	No	No	Yes

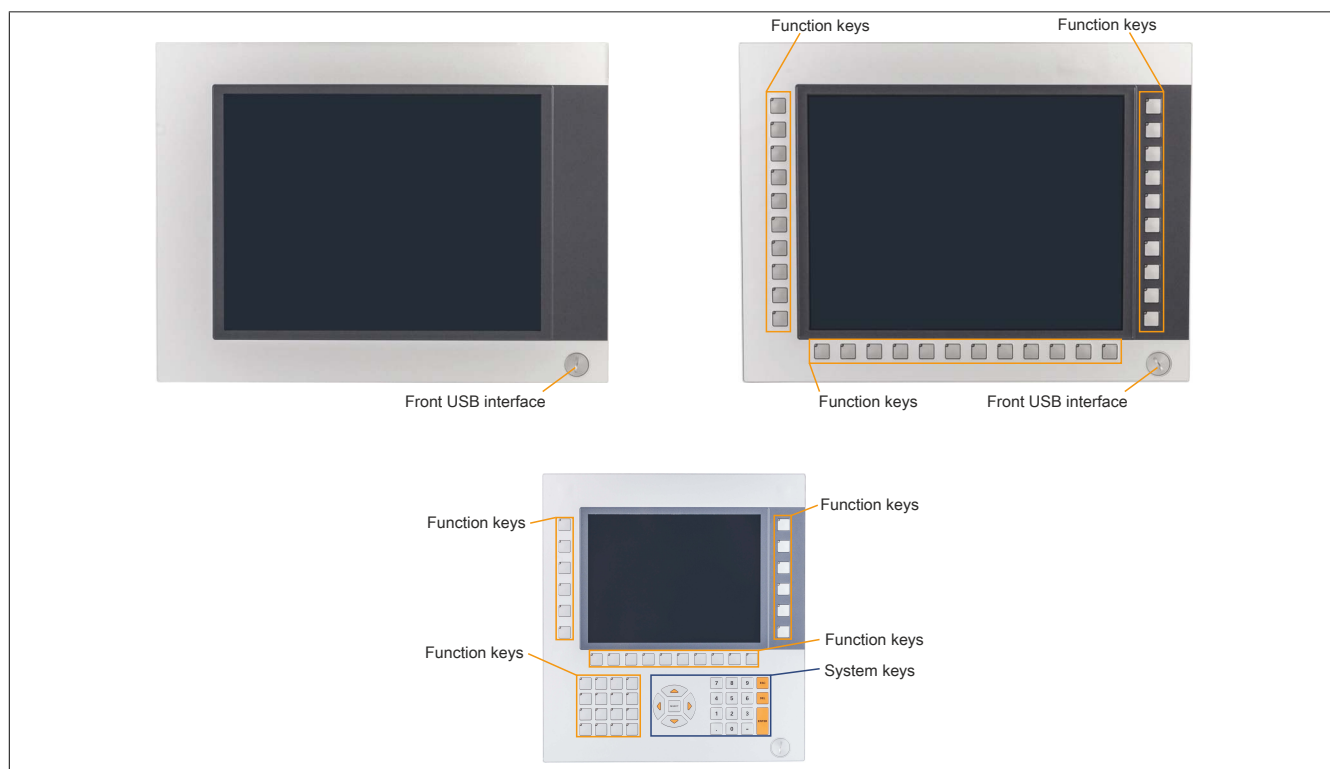

Figure 19: Features of AP1000 panels

2.8.1 Slide-in labels

Panels with keys are delivered with transparent slide-in labels inserted in the function keys for custom labeling.

It is also possible to download a template for slide-in labels with individual captions from the B&R website (www.br-automation.com).

The slide-in label slots are accessible on the back of Automation Panel devices.

2.8.2 Key and LED configuration

Each key and LED can be individually configured and adapted to the application. Several B&R tools are available for this:

- B&R Key Editor for Windows operating systems
- B&R KCF Editor for Windows operating systems
- Visual Components for Automation Runtime

Keys and LEDs from each device are processed by the matrix controller in a bit string of 128 bits each.

The positions of keys and LEDs in the matrix are represented as hardware numbers. The hardware numbers can be read directly on the target system using the B&R Key Editor or B&R Control Center.

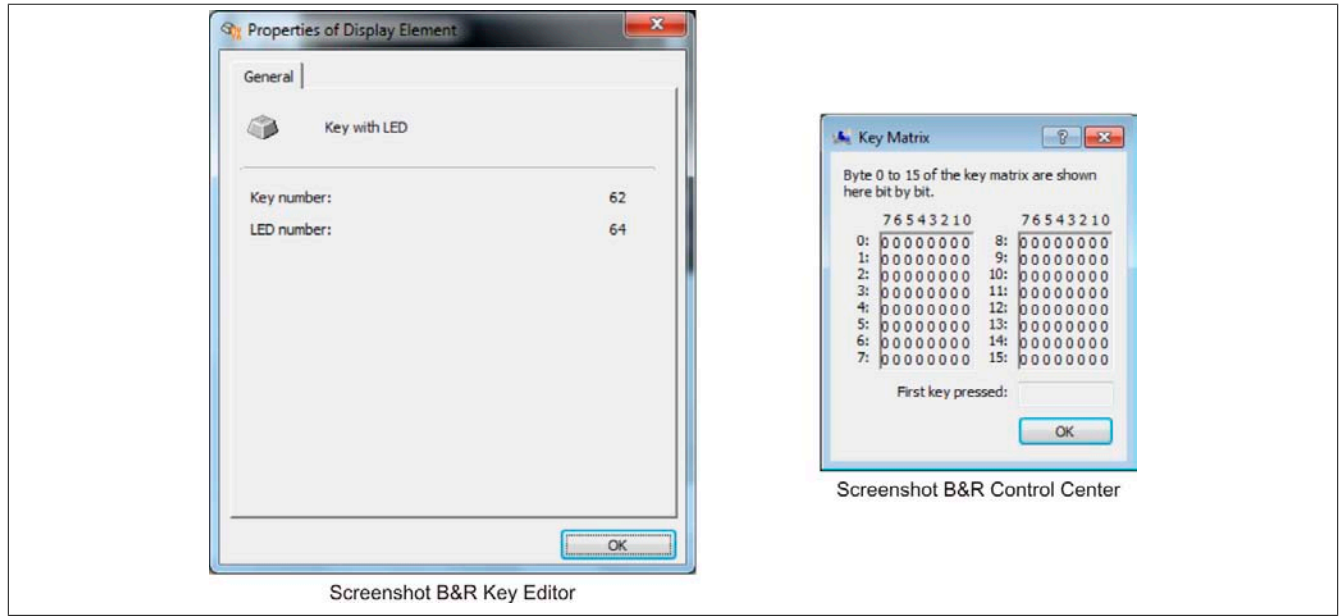

Figure 20: Hardware numbers in the B&R Key Editor and B&R Control Center

The following graphics show the positions of the keys and LEDs in the matrix. They are represented as follows.

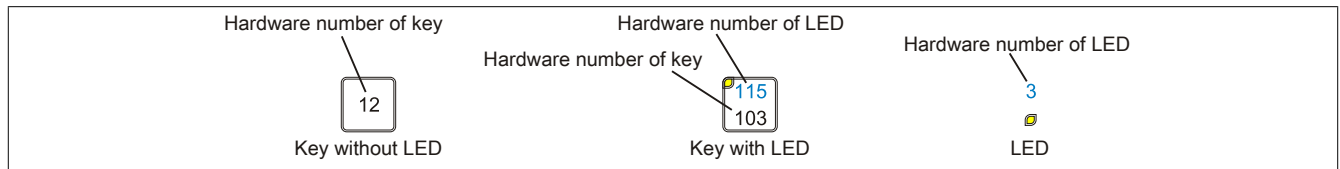

Figure 21: Representation of keys and LEDs

5AP1151.0573-000

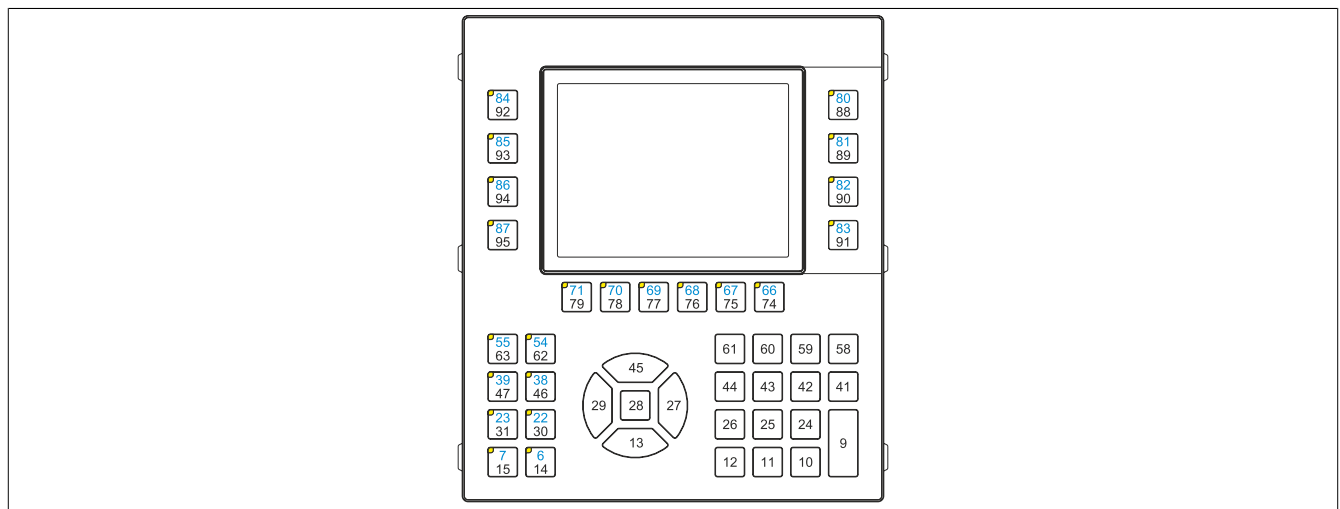

Figure 22: 5AP1151.0573-000 - Key and LED configuration

5AP1180.1043-000

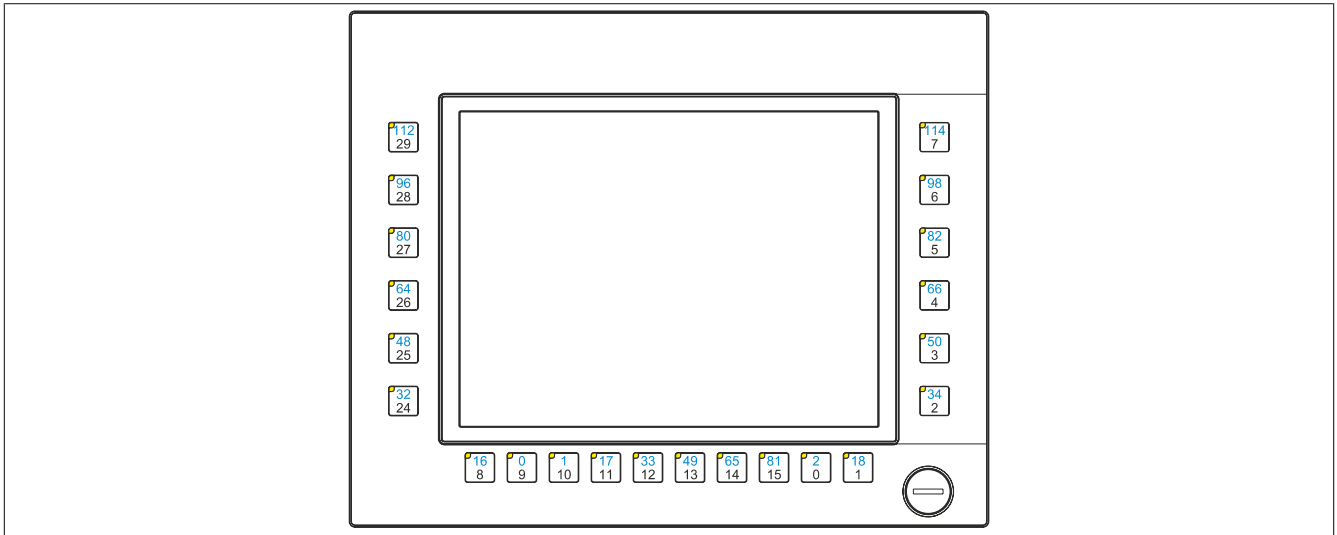

Figure 23: 5AP1180.1043-000 - Key and LED configuration

5AP1181.1043-000

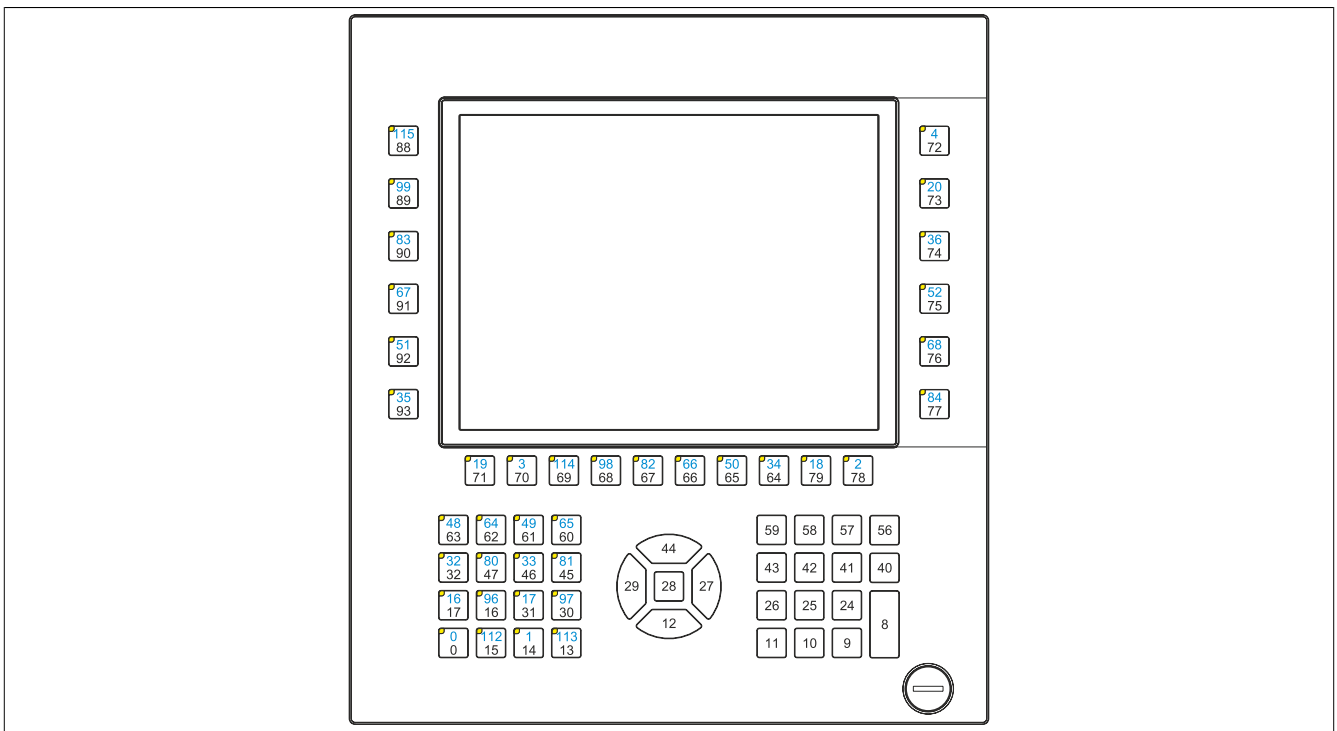

Figure 24: 5AP1181.1043-000 - Key and LED configuration

5AP1182.1043-000

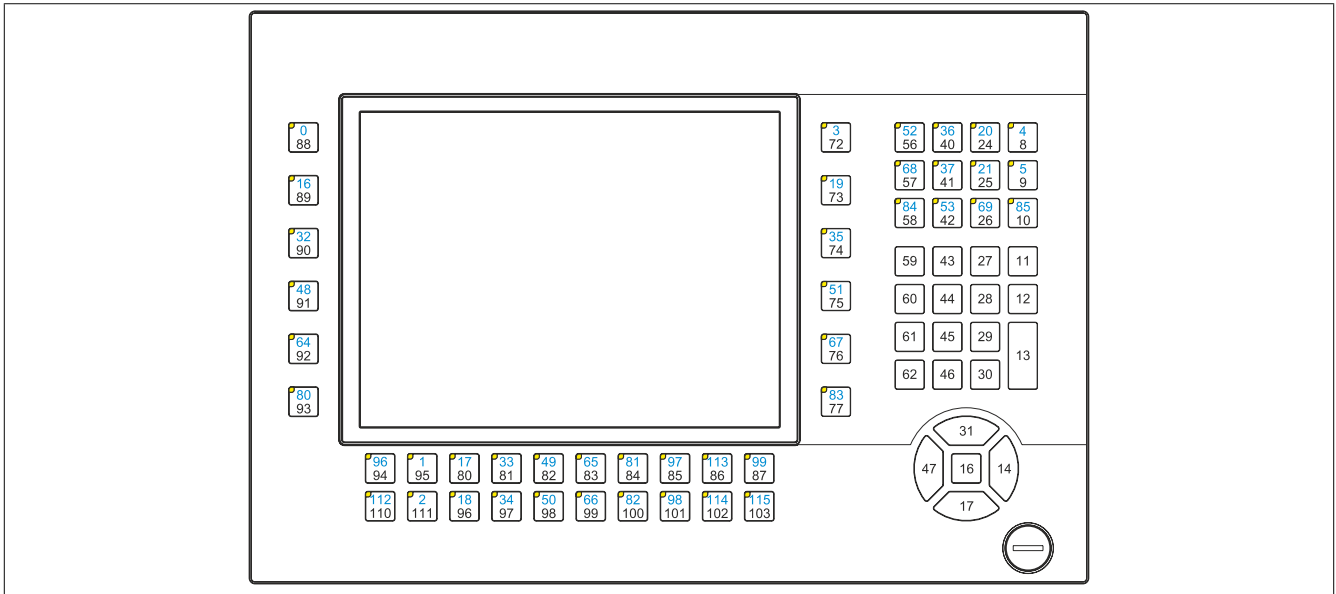

Figure 25: 5AP1182.1043-000 - Key and LED configuration

5AP1180.1505-000

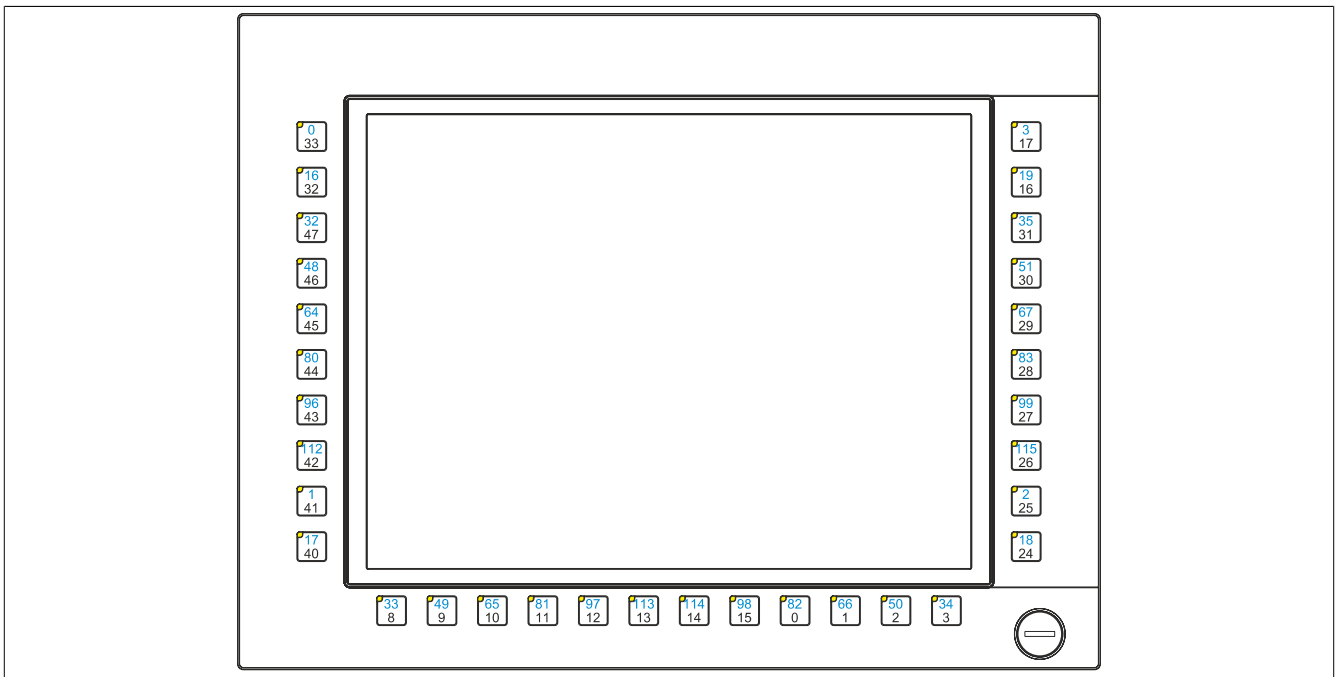

Figure 26: 5AP1180.1505-000 - Key and LED configuration

5AP1181.1505-000

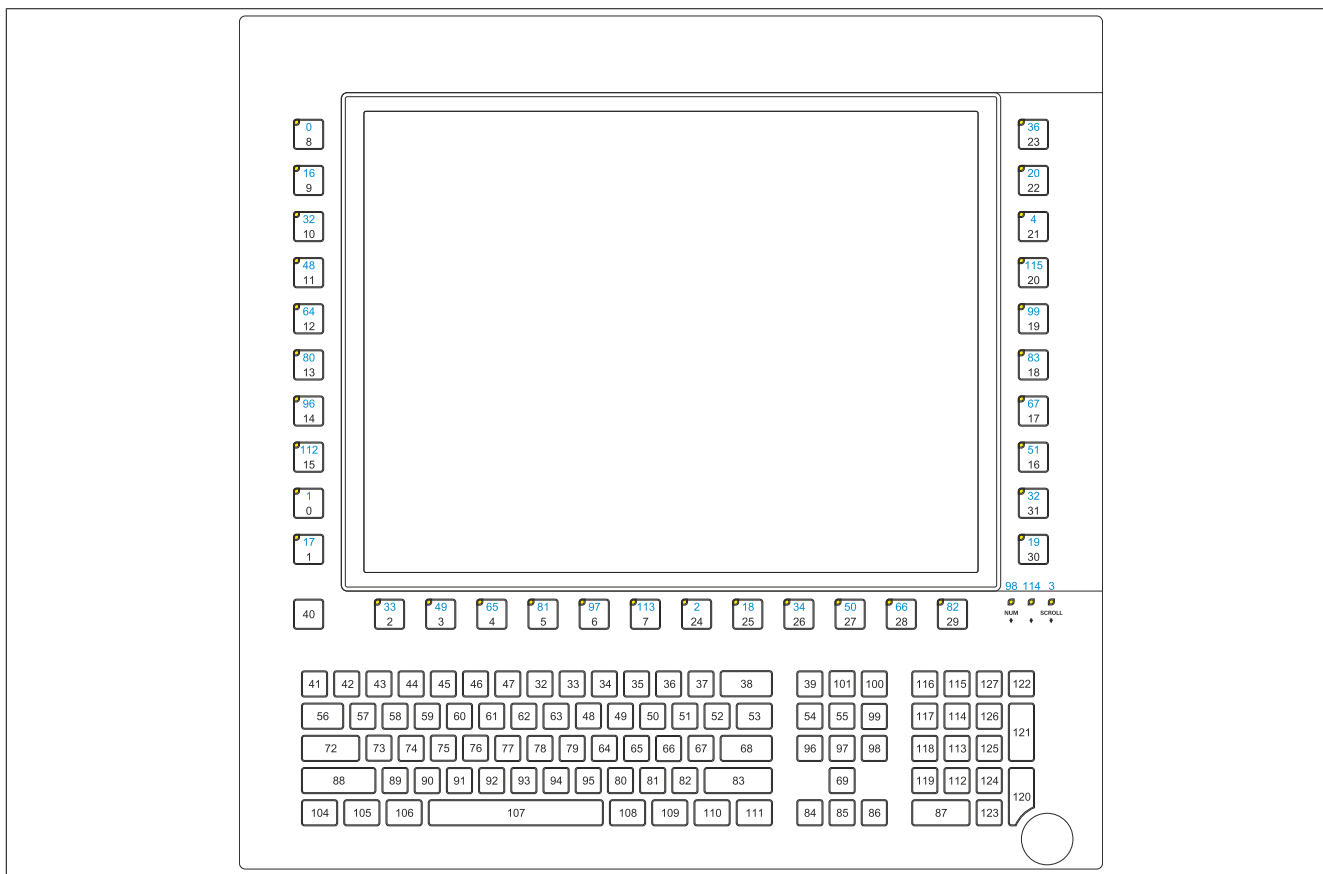

Figure 27: 5AP1181.1505-000 - Key and LED configuration

2.8.3 USB interface

AP1000 panels with 10.4", 12.1" (only 4:3 format), 15" (only 4:3 format) and 19" display sizes are equipped with a USB 2.0 interface on the front. This is equipped with a USB interface cover. IP65 protection (front) is only provided if the USB interface cover is installed correctly.

Warning!

Peripheral USB devices can be connected to the USB interfaces. Due to the large number of USB devices available on the market, B&R cannot guarantee their functionality. Functionality is ensured when using the USB devices available from B&R.

Caution!

Because this interface is designed according to general PC specifications, extreme care should be exercised with regard to EMC, cable routing, etc.

Front USB

The front USB interface is available to the user for service purposes.

Depending on the transfer method (SDL or DVI mode), the transfer rate of the USB1 and USB2 interfaces may be limited. For possible transfer methods, see section "Connection options" on page 18.

Transfer method	USB type	Max. cable length
SDL mode 1	USB 1.1	40 m
SDL mode 2	USB 2.0	5 m
DVI mode, single-touch	USB 2.0	5 m
DVI mode, multi-touch	USB 2.0	5 m
SDL3 mode	USB 2.0	100 m
SDL4 operation	USB 2.0	100 m

Universal Serial Bus (front USB) ¹⁾	
Type	USB 2.0
Design	Type A
Transfer rate	Low speed (1.5 Mbit/s), full speed (12 Mbit/s), high speed (480 Mbit/s) ²⁾
Current-carrying capacity ³⁾ Front USB	Max. 500 mA
Cable length USB 2.0	Max. 5 m (without hub)
1x USB type A, female (sample image) 	

Table 42: Front USB interface

- 1) The interfaces, etc. available on the device or module have been numbered as such for easy identification. This numbering may differ from that used by the particular operating system.
- 2) In SDL3 operation: Low speed (1.5 Mbit/s), full speed (12 Mbit/s), high speed (30 Mbit/s).
In SDL4 operation: Low speed (1.5 Mbit/s), full speed (12 Mbit/s), high speed (150 Mbit/s).
- 3) The USB interface is protected by a maintenance-free "USB current-limiting circuit breaker" (max. 500 mA).

2.9 Mounting compatibility

This section provides information about the compatibility of the installation dimensions for Power Panel 100/200, Power Panel 300/400, Power Panel 500, Automation Panel 900, Automation Panel 1000, Automation Panel 700 and Panel PC 800 devices in relation to the respective device display size.

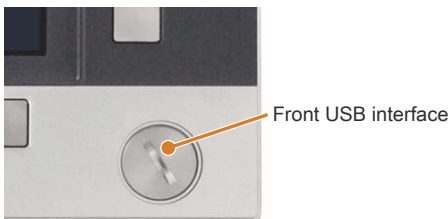
The outer dimensions of the device types are identical for the respective display sizes.

Information:

The device name "AP1000" refers to the Automation Panel 1000 as well as Panel PC 900 and Panel PC 2100 systems with an installed AP1000 panel.

The names of the different device types are shortened as follows:

Device type	Shortened form
Power Panel 100/200	PP100/200
Power Panel 300/400	PP300/400
Power Panel 500	PP500
Automation Panel 900	AP900
Automation Panel 1000	AP1000
Panel PC 700	PPC700
Panel PC 800	PPC800

Table 43: Shortened product names

2.9.1 Compatibility overview

The following table provides an overview of PP100/200, PP300/400, PP500, AP900, AP1000, PPC700 and PPC800 devices. Detailed information can be found in section "Compatibility details".

Information:

The cutout tolerance for PP100/200, PP300/400, PP500, AP900, PPC700 and PPC800 systems is ± 0.5 mm.

The cutout tolerance for the AP1000 is +0 mm / -0.5 mm.

Compatibility between device types is represented on each line by matching symbols.

Display size	Format		PP100/200	PP300/400	PP500	AP900	AP1000 ¹⁾	PPC700	PPC800
5.7"	Horizontal1	Outer dimensions	■ 212 x 156	■ 212 x 156	■ 212 x 156	-	■ 212 x 156	-	-
		Installation dimensions	● 199 x 143	● 199 x 143	● 199 x 143	-	● 199 x 143	-	-
	Horizontal2	Outer dimensions	■ 302 x 187	■ 302 x 187	■ 302 x 187	-	-	-	-
		Installation dimensions	● 289 x 174	● 289 x 174	● 289 x 174	-	-	-	-
	Vertical1	Outer dimensions	■ 212 x 245	■ 212 x 245	■ 212 x 245	-	■ 212 x 245	-	-
		Installation dimensions	● 199 x 226.8	● 199 x 226.8	▲ 199 x 232	-	▲ 199 x 232	-	-
7"	Horizontal1	Outer dimensions	-	-	■ 212 x 156	-	■ 212 x 156	-	-
		Installation dimensions	-	-	▲ 199 x 143	-	▲ 199 x 143	-	-
10.4"	Horizontal1	Outer dimensions	■ 323 x 260	■ 323 x 260	■ 323 x 260	■ 323 x 260	■ 323 x 260	■ 323 x 260	-
		Installation dimensions	● 303 x 243	● 303 x 243	● 303 x 243	● 303 x 243	● 303 x 243	● 303 x 243	● 303 x 243
	Horizontal2	Outer dimensions	■ 423 x 288	■ 423 x 288	■ 423 x 288	■ 423 x 288	■ 423 x 288	■ 423 x 288	-
		Installation dimensions	● 402 x 266.5	● 402 x 266.5	▲ 403 x 271	□ 402 x 271	▲ 403 x 271	□ 402 x 271	-
	Vertical1	Outer dimensions	■ 323 x 358	■ 323 x 358	■ 323 x 358	■ 323 x 358	■ 323 x 358	■ 323 x 358	-
		Installation dimensions	● 303 x 336	● 303 x 336	▲ 303 x 341	▲ 303 x 341	▲ 303 x 341	▲ 303 x 341	-

Table 44: Overview of device compatibility

Display size	Format		PP100/200	PP300/400	PP500	AP900	AP1000 ¹⁾	PPC700	PPC800
12.1"	Horizontal1	Outer dimensions	■ 362 x 284	■ 362 x 284	■ 362 x 284	■ 362 x 284	■ 362 x 284	■ 362 x 284	-
		Installation dimensions	● 345 x 267	● 345 x 267	▲ 342 x 267	▲ 342 x 267	▲ 342 x 267	▲ 342 x 267	-
15"	Horizontal1	Outer dimensions	■ 435 x 330	■ 435 x 330	■ 435 x 330	■ 435 x 330	■ 435 x 330	■ 435 x 330	■ 435 x 330
		Installation dimensions	● 415 x 312	● 415 x 312	▲ 415 x 313	● 415 x 312	▲ 415 x 313	● 415 x 312	● 415 x 312
	Vertical1	Outer dimensions	■ 435 x 430	■ 435 x 430	■ 435 x 430	■ 435 x 430	-	■ 435 x 430	-
		Installation dimensions	● 415 x 412	● 415 x 412	▲ 415 x 413	● 415 x 412	-	● 415 x 412	-
17"	Horizontal1	Outer dimensions	-	-	-	■ 477 x 390	-	■ 477 x 390	-
		Installation dimensions	-	-	-	▲ 460 x 373	-	▲ 460 x 373	-
19"	Horizontal1	Outer dimensions	-	-	-	■ 527 x 421	■ 527 x 421	■ 527 x 421	■ 527 x 421
		Installation dimensions	-	-	-	▲ 510 x 404	▲ 510 x 404	▲ 510 x 404	▲ 510 x 404
21.3"	Horizontal1	Outer dimensions	-	-	-	■ 583 x 464	-	-	-
		Installation dimensions	-	-	-	▲ 566 x 447	-	-	-

Table 44: Overview of device compatibility

- 1) The device name "AP1000" refers to the Automation Panel 1000 as well as Panel PC 900 and Panel PC 2100 systems with an installed AP1000 panel.

2.9.2 Compatibility details

2.9.2.1 Example

The measurement values (all in mm) and information in the following figure also apply to the other figures below.

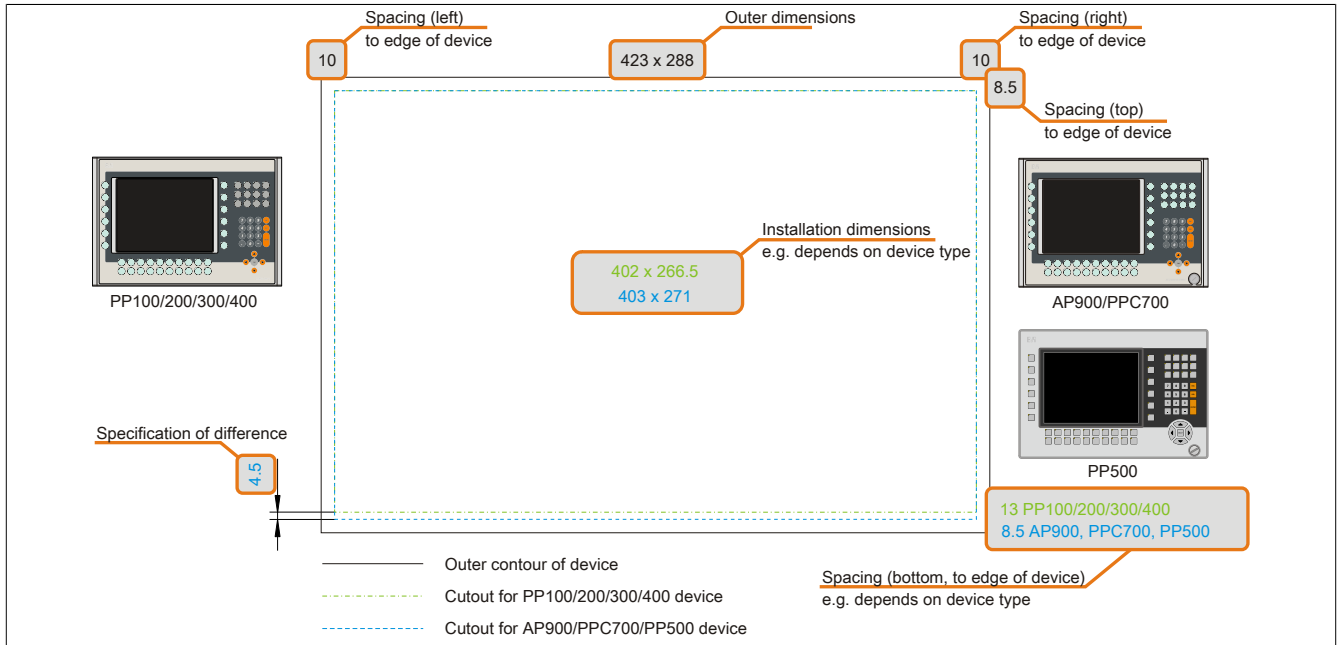

Figure 28: Compatibility details - Figure layout

2.9.2.2 5.7" devices

The cutout tolerance for PP100/200, PP300/400, PP500, AP900, PPC700 and PPC800 systems is ± 0.5 mm. The cutout tolerance for the AP1000 is $+0$ mm / -0.5 mm.

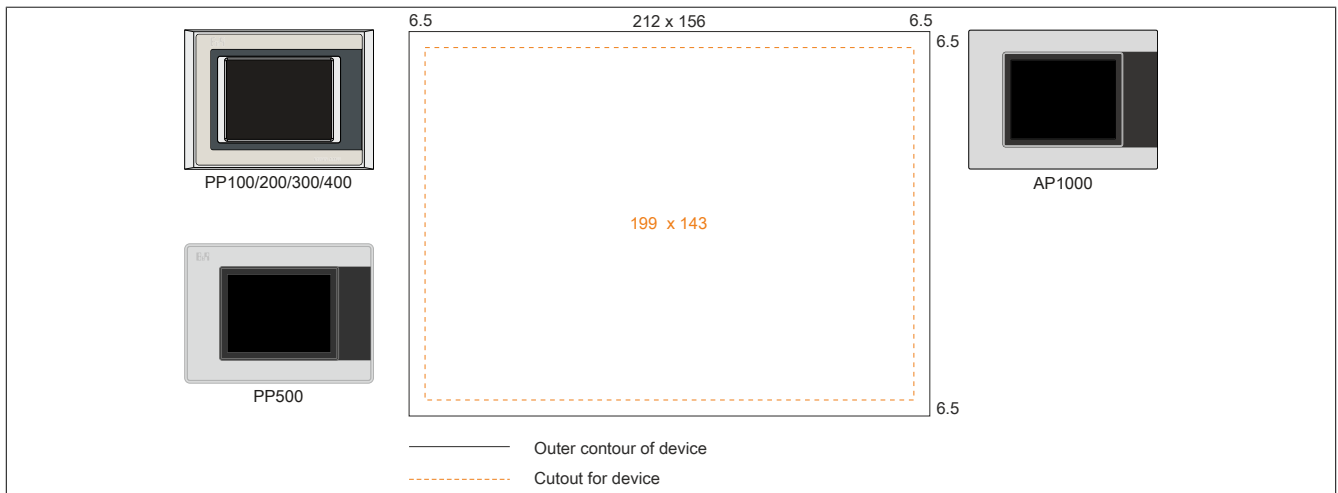

Figure 29: Mounting compatibility - 5.7" device - Horizontal1

5.7" Automation Panel 1000, Power Panel 500 devices and Power Panel 100/200/300/400 devices are 100% mounting compatible in the Horizontal1 format.

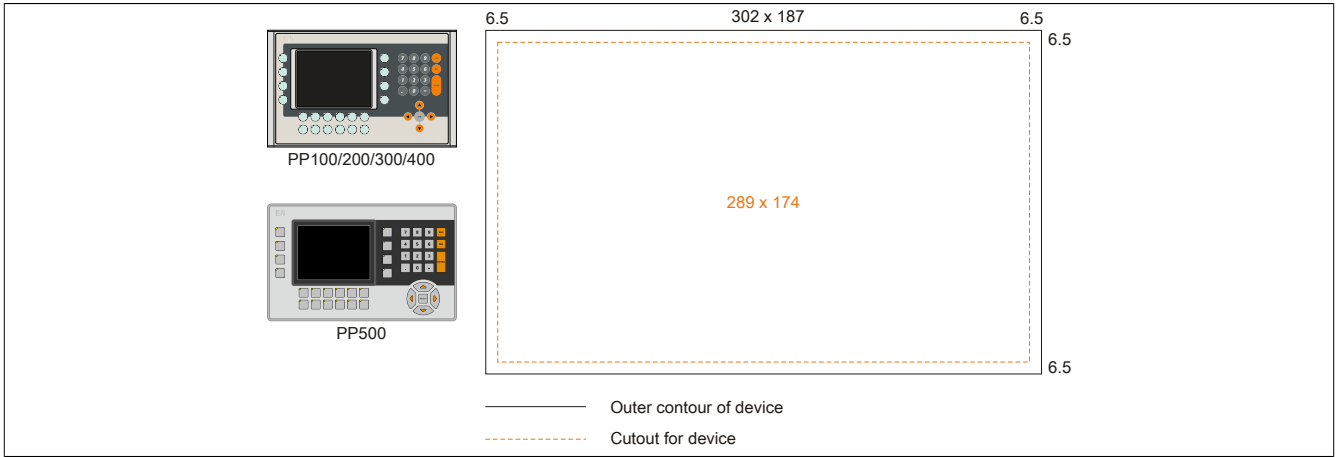

Figure 30: Mounting compatibility - 5.7" device - Horizontal2

5.7" Power Panel 500 devices and Power Panel 100/200/300/400 devices are 100% mounting compatible in the Horizontal2 format.

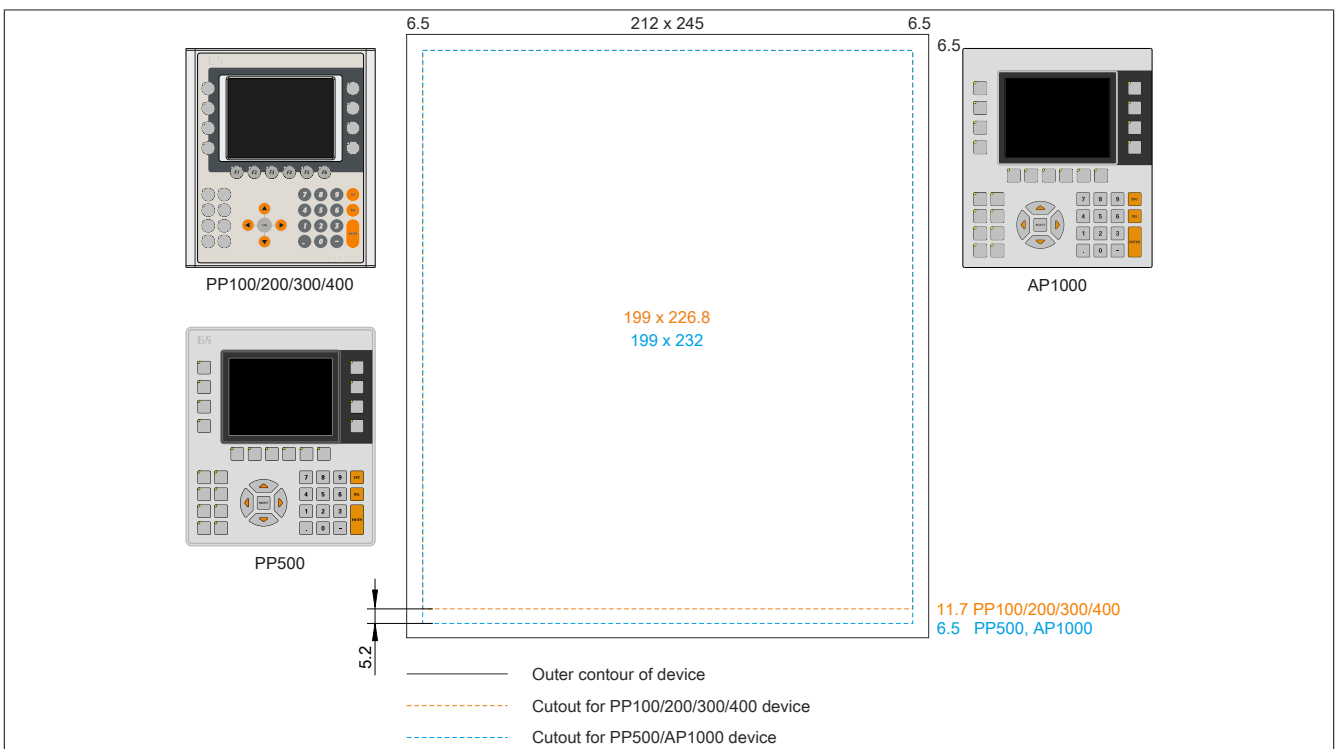

Figure 31: Mounting compatibility - 5.7" device - Vertical1

5.7" Automation Panel 1000 and Power Panel 500 devices are not 100% mounting compatible with Power Panel 100/200/300/400 devices in the Vertical1 format. Automation Panel 1000 and Power Panel 500 devices require a cutout that is 5.2 mm higher (bottom edge).

The larger cutout can be used for all devices under certain conditions:

- When mounting, make sure that the PP100/200/300/400 devices are placed and mounted as close to the center of the cutout as possible. Failure to do so can prevent the retaining clips from holding firmly, which means that a solid seal is no longer guaranteed by the gasket (IP65).

2.9.2.3 10.4" devices

The cutout tolerance for PP100/200, PP300/400, PP500, AP900, PPC700 and PPC800 systems is ± 0.5 mm. The cutout tolerance for the AP1000 is $+0$ mm / -0.5 mm.

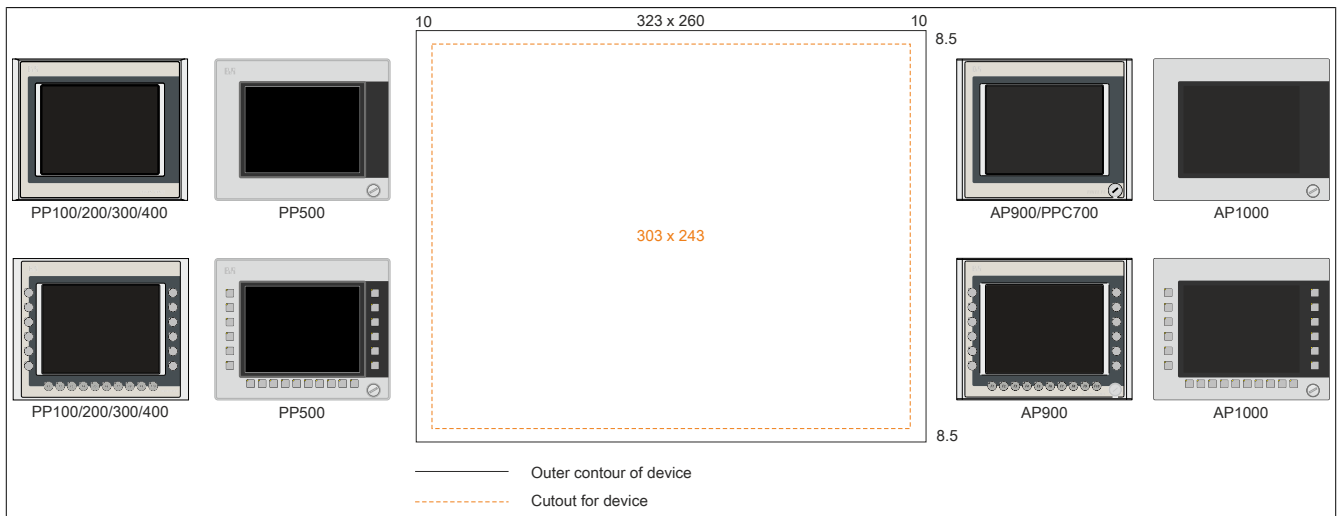

Figure 32: Mounting compatibility - 10.4" device - Horizontal1

10.4" Automation Panel 1000, Automation Panel 900, Panel PC 700, Power Panel 500 devices and Power Panel 100/200/300/400 devices are 100% mounting compatible in Horizontal1 format.

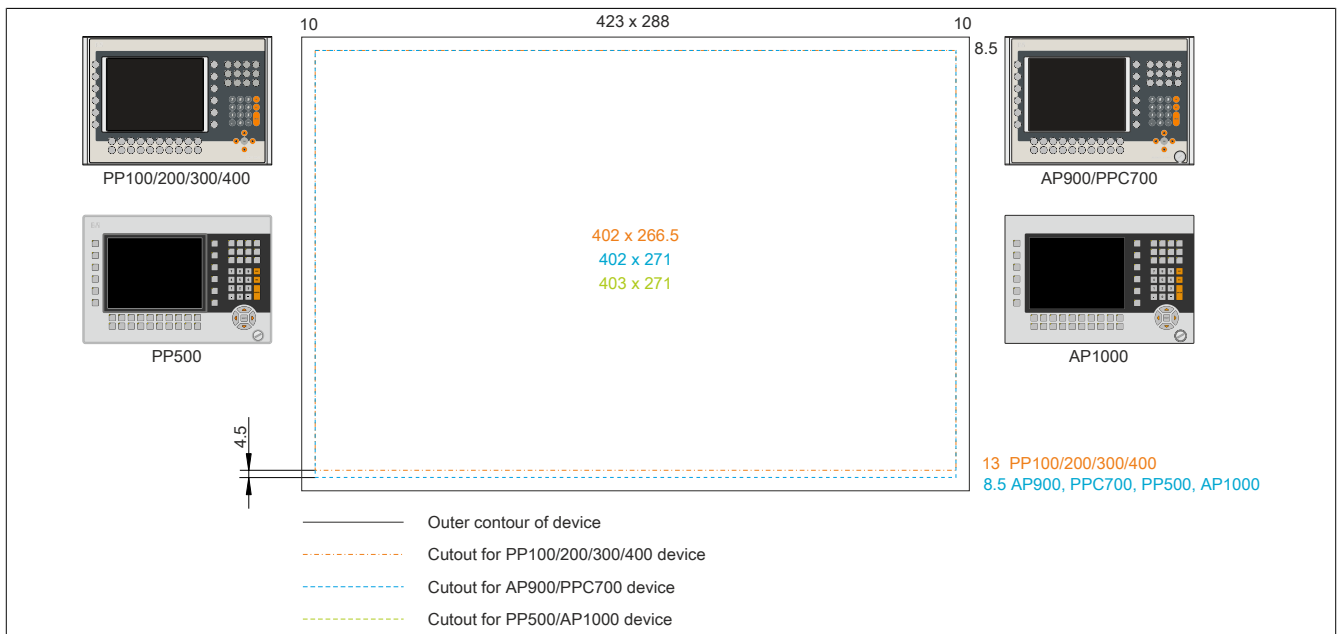

Figure 33: Mounting compatibility - 10.4" device - Horizontal2

10.4" Automation Panel 1000, Automation Panel 900, Panel PC 700 and Power Panel 500 devices are not 100% mounting compatible with Power Panel 100/200/300/400 devices in Horizontal2 format. Automation Panel 1000, Automation Panel 900, Panel PC 700 and Power Panel 500 devices require a cutout that is 4.5 mm higher (bottom edge).

The larger cutout can be used for all devices under certain conditions:

- When mounting, make sure that the PP100/200/300/400 devices are placed and mounted as close to the center of the cutout as possible. Failure to do so can prevent the retaining clips from holding firmly, which means that a solid seal is no longer guaranteed by the gasket (IP65).

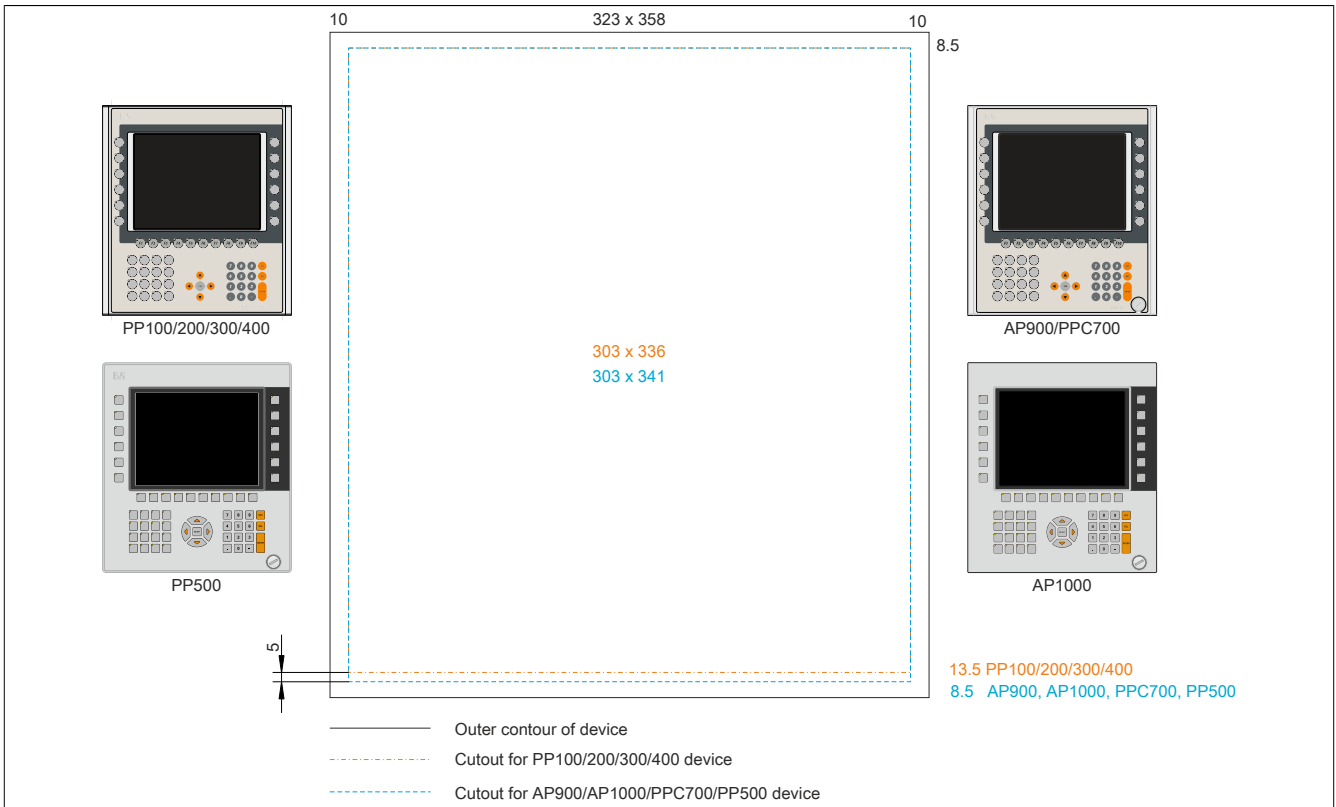

Figure 34: Mounting compatibility - 10.4" device - Vertical1

10.4" Automation Panel 1000, Automation Panel 900, Panel PC 700 and Power Panel 500 devices are not 100% mounting compatible with Power Panel 100/200/300/400 devices in Vertical1 format. Automation Panel 1000, Automation Panel 900, Panel PC 700 and Power Panel 500 devices require a cutout that is 5 mm higher (bottom edge).

The larger cutout can be used for all devices under certain conditions:

- When mounting, make sure that the PP100/200/300/400 devices are placed and mounted as close to the center of the cutout as possible. Failure to do so can prevent the retaining clips from holding firmly, which means that a solid seal is no longer guaranteed by the gasket (IP65).

2.9.2.4 12.1" devices

The cutout tolerance for PP100/200, PP300/400, PP500, AP900, PPC700 and PPC800 systems is ± 0.5 mm. The cutout tolerance for the AP1000 is $+0$ mm / -0.5 mm.

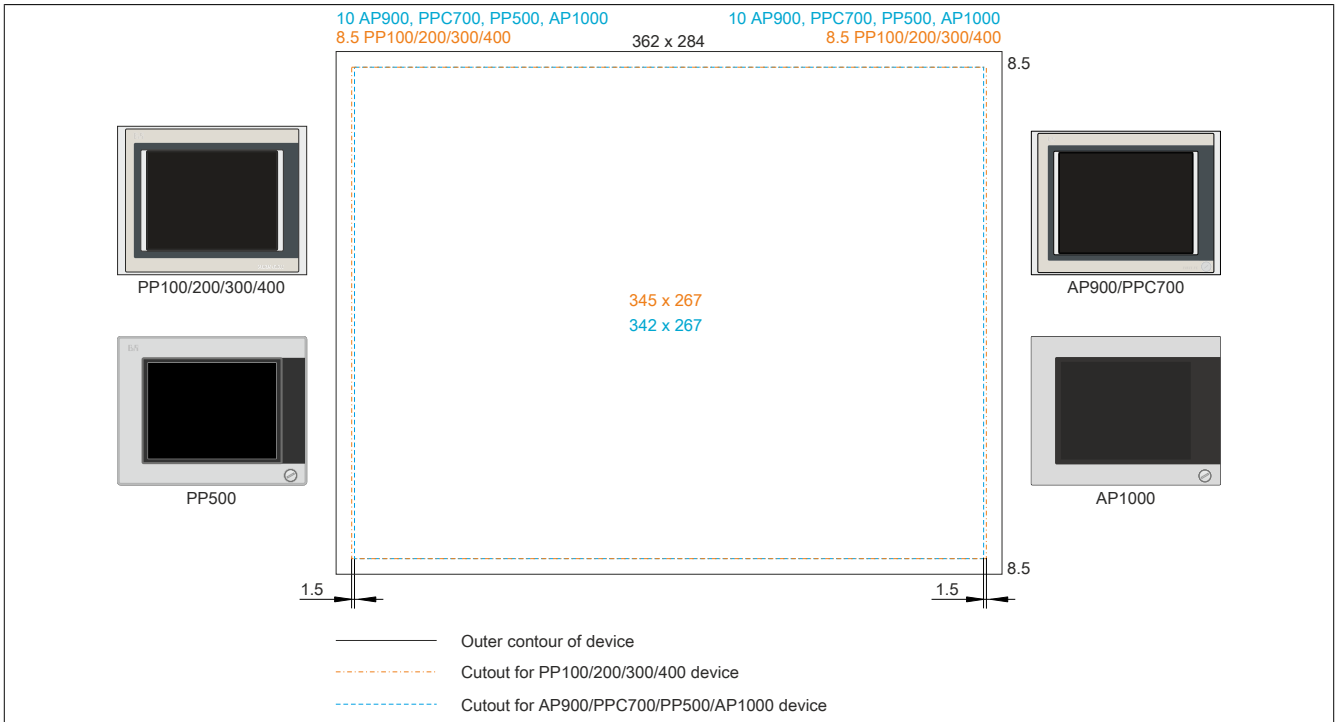

Figure 35: Mounting compatibility - 12.1" device - Horizontal1

12.1" Automation Panel 1000, Automation Panel 900, Panel PC 700 and Power Panel 500 devices are not 100% mounting compatible with Power Panel 100/200/300/400 devices in Horizontal1 format. The Power Panel 300/400 and Power Panel 100/200 devices require a cut that is 1.5 mm wider (left and right).

The larger cutout can be used for all devices under certain conditions:

- When mounting, make sure that the AP1000, AP900, PPC700 and PP500 devices are placed and mounted as close to the center of the cutout as possible.

2.9.2.6 17" devices

The cutout tolerance for PP100/200, PP300/400, PP500, AP900, PPC700 and PPC800 systems is ± 0.5 mm. The cutout tolerance for the AP1000 is $+0$ mm / -0.5 mm.

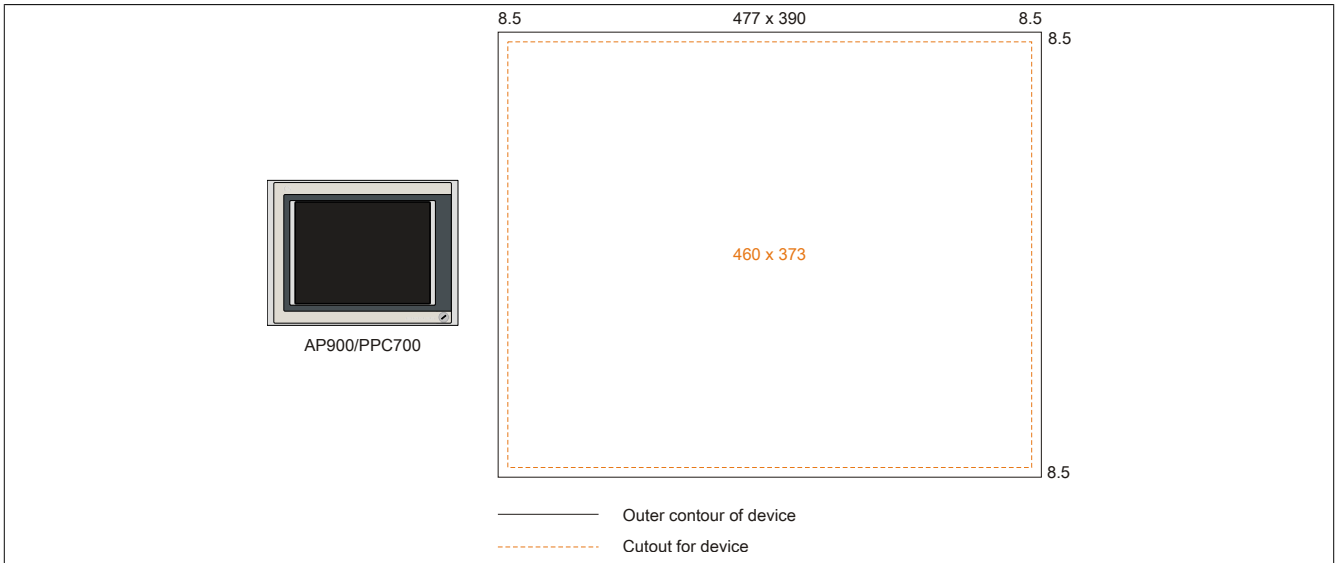

Figure 38: Mounting compatibility - 17" device - Horizontal1

17" Automation Panel 900 devices are 100% mounting compatible with Panel PC 700 devices in the Horizontal1 format.

2.9.2.7 19" devices

The cutout tolerance for PP100/200, PP300/400, PP500, AP900, PPC700 and PPC800 systems is ± 0.5 mm. The cutout tolerance for the AP1000 is $+0$ mm / -0.5 mm.

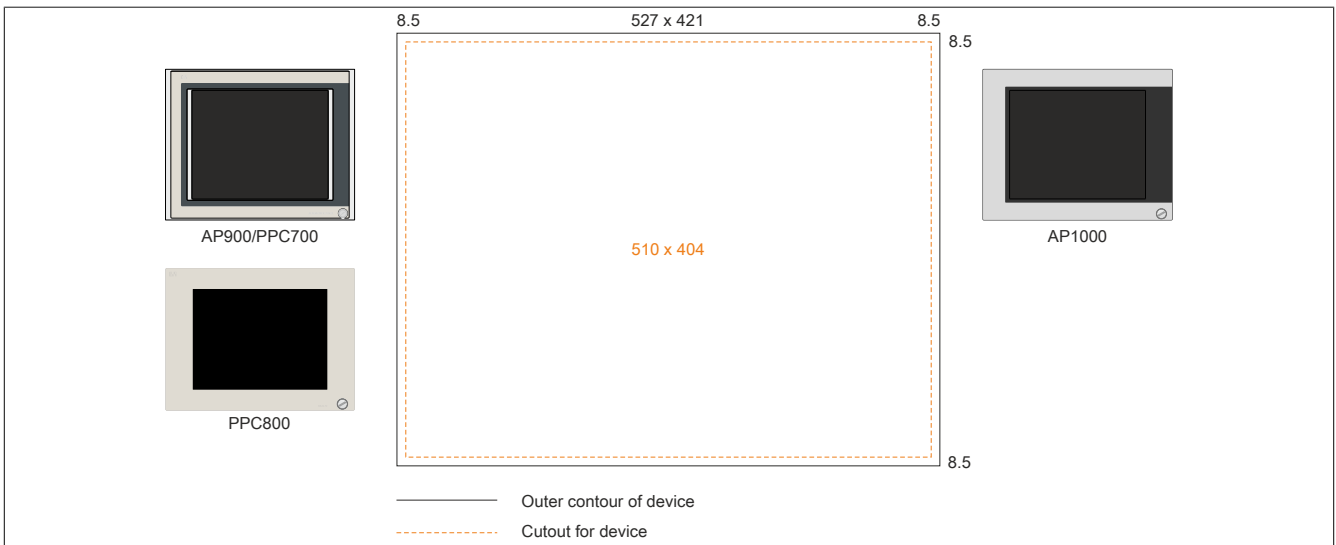

Figure 39: Mounting compatibility - 19" device - Horizontal1

19" Automation Panel 1000, Automation Panel 900, Panel PC 700 and Panel PC 800 are 100% mounting compatible in the Horizontal1 format.

2.9.2.8 21.3" devices

The cutout tolerance for PP100/200, PP300/400, PP500, AP900, PPC700 and PPC800 systems is ± 0.5 mm. The cutout tolerance for the AP1000 is +0 mm / -0.5 mm.

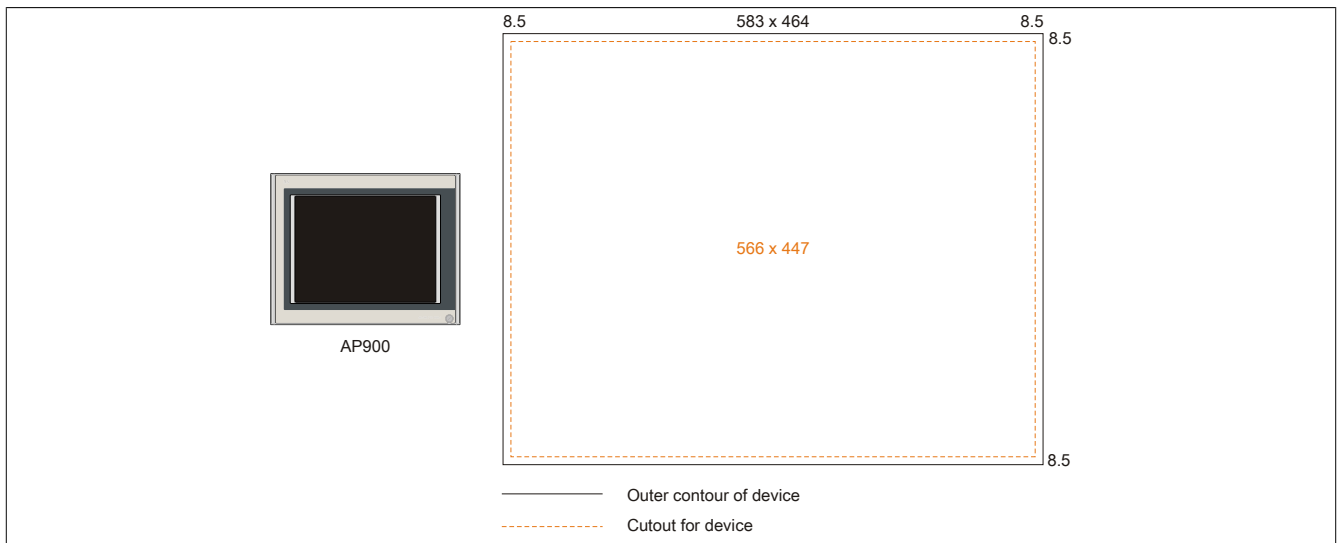

Figure 40: Mounting compatibility - 21.3" device - Horizontal1

3 Individual components

3.1 Panels

3.1.1 5AP1120.0573-000

3.1.1.1 General information

- Panel for AP1000 or PPC2100
- 5.7" TFT VGA color display
- Single-touch (analog resistive)
- Control cabinet installation

3.1.1.2 Order data

Model number	Short description	Figure
5AP1120.0573-000	Automation Panel 5.7" VGA TFT - 640 x 480 pixels (4:3) - Single-touch (analog resistive) - Control cabinet installation - Landscape format - For PPC2100 / link modules - Installation compatible with 5PP520.0573-00	

Table 45: 5AP1120.0573-000 - Order data

3.1.1.3 Technical data

Information:

The following specifications, properties and limit values apply only to this individual component and may deviate from those that apply to the complete system. For the complete system in which this individual component is used, for example, the data specified for that complete system applies.

Product ID	5AP1120.0573-000	
Revision	D0	E0
General information		
B&R ID code	0xE7AA	
Certifications		
CE	Yes	
UL	cULus E115267 Industrial control equipment	
HazLoc	cULus HazLoc E180196 Industrial control equipment for hazardous locations Class I, Division 2, Groups ABCD, T4 ¹⁾	
Display		
Type	TFT color	
Diagonal	5.7"	
Colors	262,144	
Resolution	VGA, 640 x 480 pixels	
Contrast	850:1	800:1
Viewing angles		
Horizontal	Direction R = 80° / Direction L = 80°	Direction R = 80° / Direction L = 80°
Vertical	Direction U = 80° / Direction D = 80°	Direction U = 70° / Direction D = 70°
Backlight		
Type	LED	
Brightness (dimnable)	Typ. 20 to 400 cd/m ²	Typ. 22.5 to 450 cd/m ²
Half-brightness time ²⁾	50,000 h	
Touch screen ³⁾		
Type	AMT	
Technology	Analog, resistive	
Controller	B&R, serial, 12-bit	
Transmittance	81% ±3%	

Table 46: 5AP1120.0573-000, 5AP1120.0573-000 - Technical data

Product ID	5AP1120.0573-000	
Revision	D0	E0
General information		
Operating conditions		
Pollution degree per EN 61131-2	Pollution degree 2	
Degree of protection per EN 60529	Front: IP65 Back: IP20 (only with installed link module or installed system unit)	
Protection per UL 50	Front: Type 4X indoor use only	
Mechanical characteristics		
Front ⁴⁾		
Frame	Aluminum, naturally anodized	
Panel overlay		
Material	Polyester	
Light background	RAL 9006	
Dark gray border around display	RAL 7024	
Gasket	3 mm built-in gasket	
Dimensions		
Width	212 mm	
Height	156 mm	
Weight	1100 g	

Table 46: 5AP1120.0573-000, 5AP1120.0573-000 - Technical data

- 1) Yes, although applies only if all components installed in the complete system have this certification and the complete system bears the corresponding mark.
- 2) At an ambient temperature of 25°C. Reducing the brightness by 50% can increase the half-brightness time by approximately 50%.
- 3) Touch screen drivers for approved operating systems are available for download in the Downloads section of the B&R website (www.br-automation.com).
- 4) There may be visible deviations in the color and surface appearance depending on the process or batch.

3.1.1.4 Dimensions

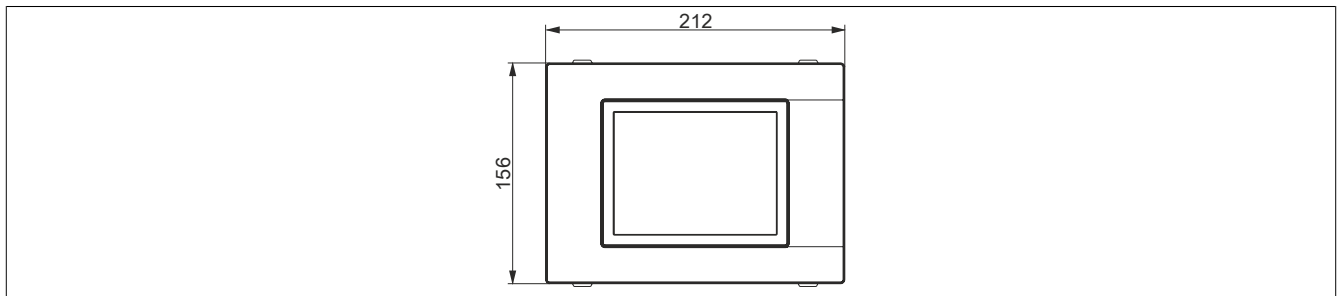

Figure 41: 5AP1120.0573-000 - Dimensions

3.1.1.5 Prerequisites and requirements

5.7" AP1000 panels are supported beginning with the following firmware versions:

- V3.11 for the 5DLSDL.1001-00 SDL/DVI receiver
- V4.08 for the 5DLSD3.1001-00 SDL3 receiver
- V1.03 for the 5PPC2100.BYxx-000 PPC2100 system unit

3.1.1.6 Temperature/Humidity diagram

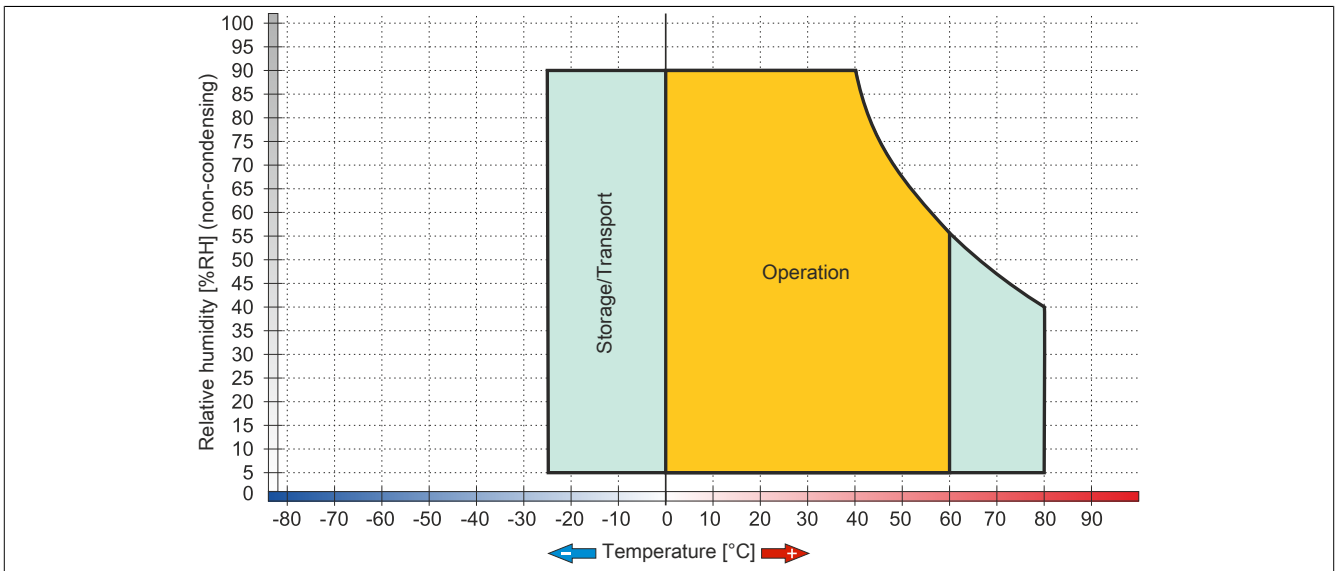

Figure 42: 5AP1120.0573-000 ≤ Rev. D0 - Temperature/Humidity diagram

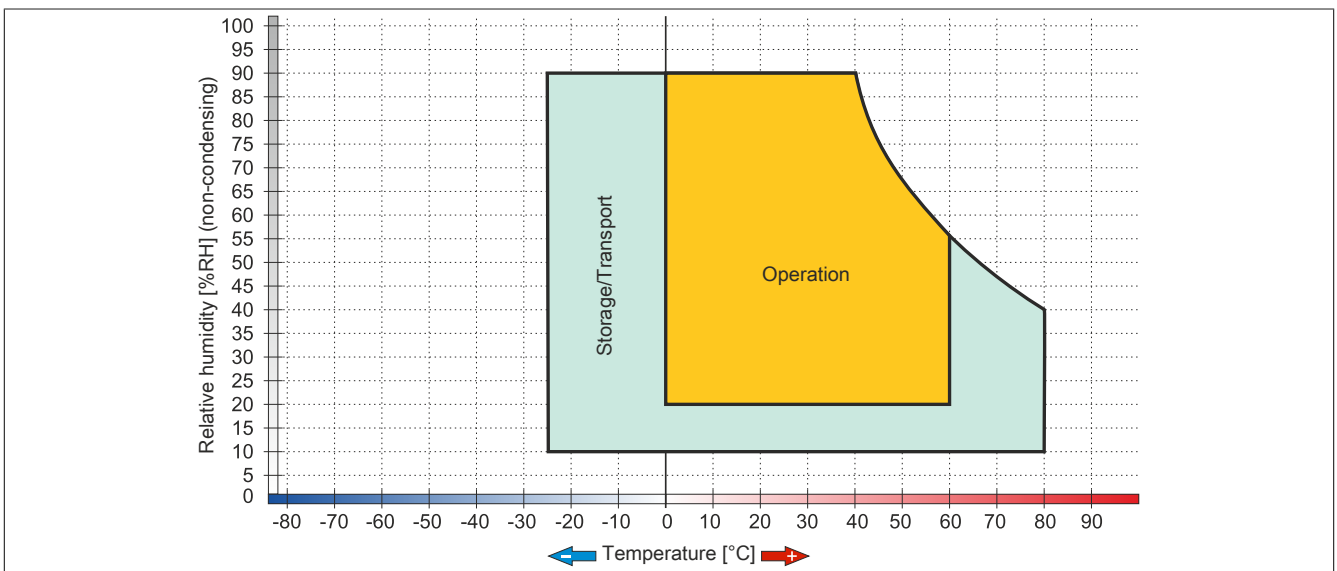

Figure 43: 5AP1120.0573-000 ≥ Rev. E0 - Temperature/Humidity diagram

3.1.2 5AP1151.0573-000

3.1.2.1 General information

- Panel for AP1000 or PPC2100
- 5.7" TFT VGA color display
- 22 function keys and 20 system keys
- Control cabinet installation

3.1.2.2 Order data

Model number	Short description	Figure
5AP1151.0573-000	Panels Automation Panel 5.7" VGA TFT - 640 x 480 pixels (4:3) - Single-touch (analog resistive) - Control cabinet cable installation - Portrait format - 22 function keys and 20 system keys - For PPC2100 / link modules - Compatible with 5PP551.0573-00	

Table 47: 5AP1151.0573-000 - Order data

3.1.2.3 Technical data

Information:

The following specifications, properties and limit values apply only to this individual component and may deviate from those that apply to the complete system. For the complete system in which this individual component is used, for example, the data specified for that complete system applies.

Product ID	5AP1151.0573-000	
Revision	D0	E0
General information		
B&R ID code	0xE7AB	
Certifications		
CE	Yes	
UL	cULus E115267 Industrial control equipment	
HazLoc	cULus HazLoc E180196 Industrial control equipment for hazardous locations Class I, Division 2, Groups ABCD, T4 ¹⁾	
Display		
Type	TFT color	
Diagonal	5.7"	
Colors	262,144	
Resolution	VGA, 640 x 480 pixels	
Contrast	850:1	800:1
Viewing angles		
Horizontal	Direction R = 80° / Direction L = 80°	Direction R = 80° / Direction L = 80°
Vertical	Direction U = 80° / Direction D = 80°	Direction U = 70° / Direction D = 70°
Backlight		
Type	LED	
Brightness (dimnable)	Typ. 20 to 400 cd/m ²	Typ. 22.5 to 450 cd/m ²
Half-brightness time ²⁾	50,000 h	
Keys		
Function keys	22 with LED (yellow)	
System keys	Numeric keys, cursor block	
Service life	>1,000,000 actuations at 1 ±0.3 N to 3 ±0.3 N actuating force	
LED brightness		
Yellow	Typ. 38 mcd	

Table 48: 5AP1151.0573-000, 5AP1151.0573-000 - Technical data

Product ID	5AP1151.0573-000	
Revision	D0	E0
Operating conditions		
Pollution degree per EN 61131-2	Pollution degree 2	
Degree of protection per EN 60529	Front: IP65 Back: IP20 (only with installed link module or installed system unit)	
Protection per UL 50	Front: Type 4X indoor use only	
Mechanical characteristics		
Front ³⁾		
Frame	Aluminum, naturally anodized	
Panel overlay		
Material	Polyester	
Light background	RAL 9006	
Dark gray border around display	RAL 7024	
Gasket	3 mm built-in gasket	
Dimensions		
Width	212 mm	
Height	245 mm	
Weight	1400 g	

Table 48: 5AP1151.0573-000, 5AP1151.0573-000 - Technical data

- 1) Yes, although applies only if all components installed in the complete system have this certification and the complete system bears the corresponding mark.
- 2) At an ambient temperature of 25°C. Reducing the brightness by 50% can increase the half-brightness time by approximately 50%.
- 3) There may be visible deviations in the color and surface appearance depending on the process or batch.

3.1.2.4 Dimensions

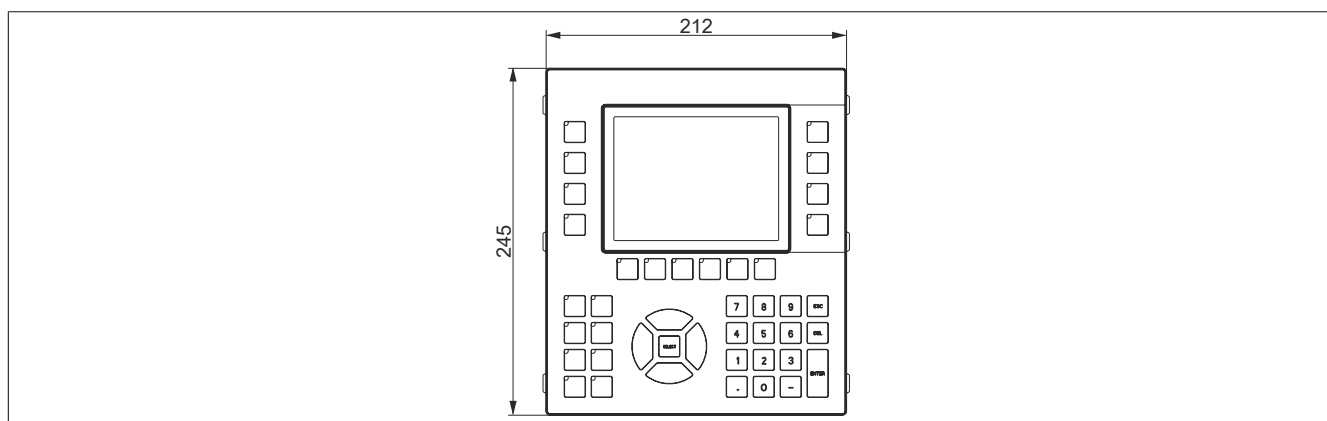

Figure 44: 5AP1151.0573-000 - Dimensions

3.1.2.5 Prerequisites and requirements

5.7" AP1000 panels are supported beginning with the following firmware versions:

- V3.11 for the 5DLSDL.1001-00 SDL/DVI receiver
- V4.08 for the 5DLSD3.1001-00 SDL3 receiver
- V1.03 for the 5PPC2100.BYxx-000 PPC2100 system unit

3.1.2.6 Temperature/Humidity diagram

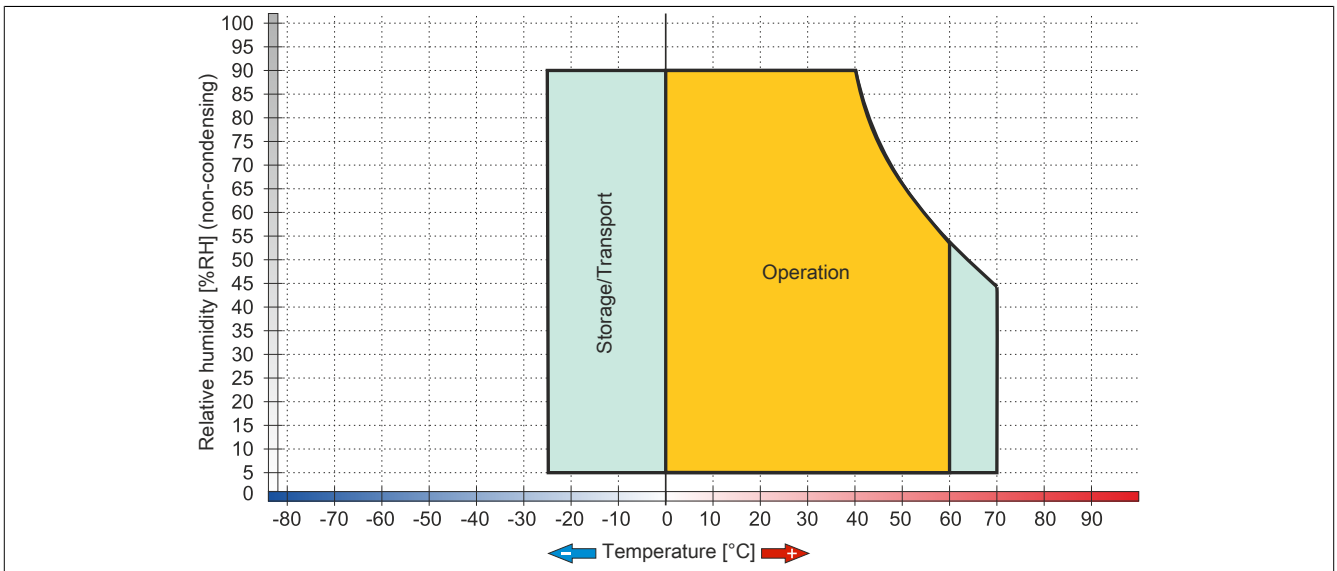

Figure 45: 5AP1151.0573-000 ≤Rev. D0 - Temperature/Humidity diagram

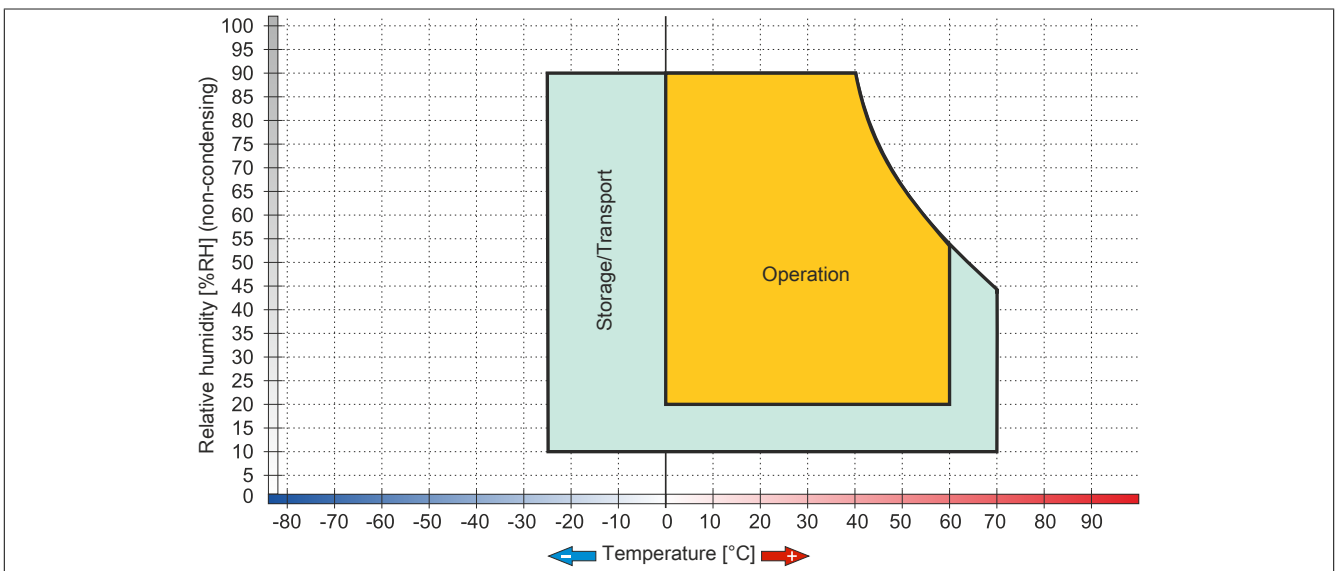

Figure 46: 5AP1151.0573-000 ≥Rev. E0 - Temperature/Humidity diagram

3.1.3 5AP1120.0702-000

3.1.3.1 General information

- Panel for AP1000 or PPC2100
- 7.0" TFT WVGA color display
- Single-touch (analog resistive)
- Control cabinet installation

3.1.3.2 Order data

Model number	Short description	Figure
5AP1120.0702-000	Automation Panel 7" WVGA TFT - 800 x 480 pixels (16:10) - Single-touch (analog resistive) - Control cabinet installation - Landscape format - For PPC2100 / link modules - Compatible with 5PP520.0702-00	

Table 49: 5AP1120.0702-000 - Order data

3.1.3.3 Technical data

Information:

The following specifications, properties and limit values apply only to this individual component and may deviate from those that apply to the complete system. For the complete system in which this individual component is used, for example, the data specified for that complete system applies.

Model number	5AP1120.0702-000
General information	
B&R ID code	0xE7AC
Certifications	
CE	Yes
UL	cULus E115267 Industrial control equipment
HazLoc	cULus HazLoc E180196 Industrial control equipment for hazardous locations Class I, Division 2, Groups ABCD, T4 ¹⁾
Display	
Type	Color TFT
Diagonal	7.0"
Colors	16.7 million
Resolution	WVGA, 800 x 480 pixels
Contrast	600:1
Viewing angles	
Horizontal	Direction R = 70° / Direction L = 70°
Vertical	Direction U = 60° / Direction D = 60°
Backlight	
Type	LED
Brightness (dimnable)	Typ. 80 to 500 cd/m ²
Half-brightness time ²⁾	50,000 h
Touch screen ³⁾	
Type	AMT
Technology	Analog, resistive
Controller	B&R, serial, 12-bit
Transmittance	81% ±3%
Operating conditions	
Pollution degree per EN 61131-2	Pollution degree 2
Degree of protection per EN 60529	Front: IP65 Back: IP20 (only with installed link module or installed system unit)
Protection per UL 50	Front: Type 4X indoor use only

Table 50: 5AP1120.0702-000 - Technical data

Model number	5AP1120.0702-000
Mechanical characteristics	
Front ⁴⁾	
Frame	Naturally anodized aluminum
Keypad overlay	
Material	Polyester
Light background	RAL 9006
Dark gray border around display	RAL 7024
Gasket	3 mm built-in gasket
Dimensions	
Width	212 mm
Height	156 mm
Weight	Approx. 900 g

Table 50: 5AP1120.0702-000 - Technical data

- 1) Yes, although applies only if all components installed within the complete system have this certification and the complete system itself carries the corresponding mark.
- 2) At an ambient temperature of 25°C. Reducing the brightness by 50% can result in an approximately 50% increase in the half-brightness time.
- 3) Touch screen drivers for approved operating systems are available in the Downloads section of the B&R website.
- 4) There may be visible deviations in the color and surface appearance depending on the process or batch.

3.1.3.4 Dimensions

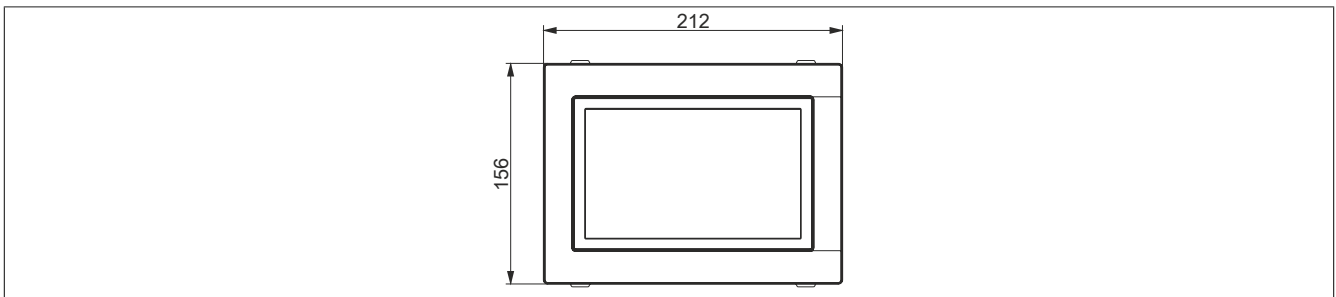

Figure 47: 5AP1120.0702-000 - Dimensions

3.1.3.5 Temperature/Humidity diagram

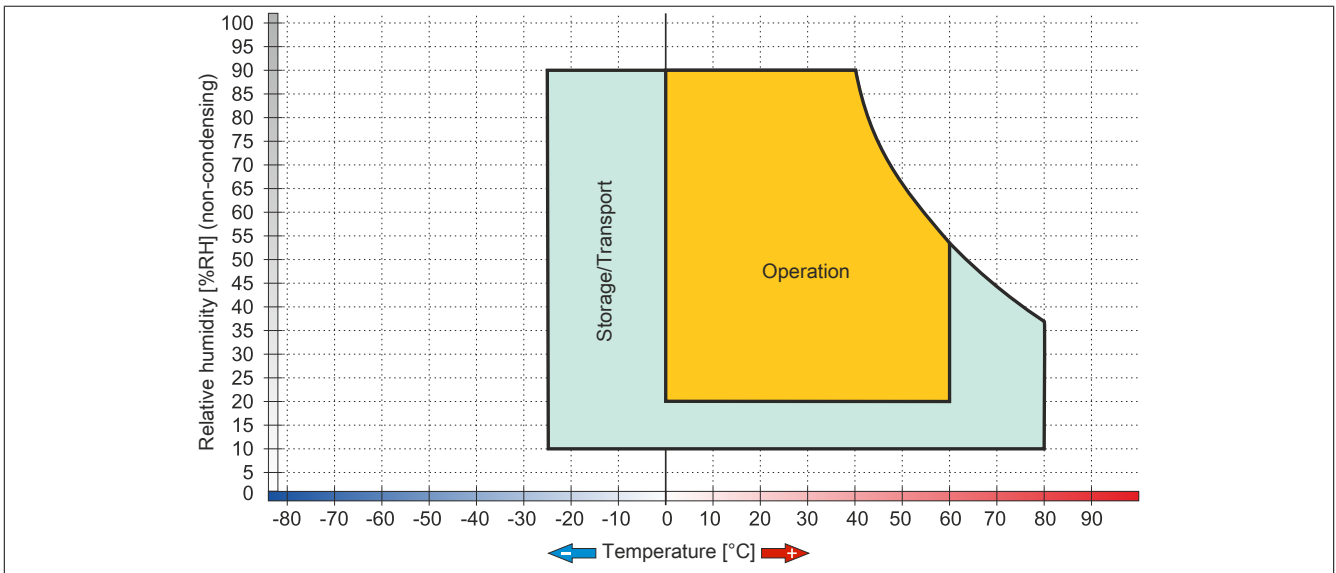

Figure 48: 5AP1120.0702-000 - Temperature/Humidity diagram

3.1.4 5AP1130.0702-000

3.1.4.1 General information

- Panel for AP1000 or PPC2100
- 7.0" TFT WVGA color display
- Multi-touch (projected capacitive)
- Control cabinet installation

3.1.4.2 Order data

Model number	Short description	Figure
5AP1130.0702-000	Panels Automation Panel 7.0" WVGA TFT - 800 x 480 pixels (16:10) - Multi-touch (projected capacitive) - Control cabinet installation - Landscape format - For PPC2100 / link modules - Installation compatible with 5PP520.0702-00	

Table 51: 5AP1130.0702-000 - Order data

3.1.4.3 Technical data

Information:

The following specifications, properties and limit values apply only to this individual component and may deviate from those that apply to the complete system. For the complete system in which this individual component is used, for example, the data specified for that complete system applies.

Model number	5AP1130.0702-000
General information	
B&R ID code	0xEB61
Certifications	
CE	Yes
UL	cULus E115267 Industrial control equipment
HazLoc	cULus HazLoc E180196 Industrial control equipment for hazardous locations Class I, Division 2, Groups ABCD, T4 ¹⁾
Display	
Type	Color TFT
Diagonal	7.0"
Colors	16.7 million
Resolution	WVGA, 800 x 480 pixels
Contrast	600:1
Viewing angles	
Horizontal	Direction R = 70° / Direction L = 70°
Vertical	Direction U = 60° / Direction D = 60°
Backlight	
Type	LED
Brightness (dimnable)	Typ. 80 to 500 cd/m ²
Half-brightness time ²⁾	50,000 h
Touch screen ³⁾	
Type	3M
Technology	Projected capacitive touch (PCT)
Controller	3M
Transmittance	See appendix A "Touch screen".
Operating conditions	
Pollution degree per EN 61131-2	Pollution degree 2
Degree of protection per EN 60529	Front: IP65 Back: IP20 (only with installed link module or installed system unit)
Protection per UL 50	Front: Type 4X indoor use only

Table 52: 5AP1130.0702-000 - Technical data

Model number	5AP1130.0702-000
Mechanical characteristics	
Front ⁴⁾	
Frame	Coated aluminum
Design	Black
Gasket	3 mm built-in gasket
Dimensions	
Width	209 mm
Height	153 mm
Weight	1200 g

Table 52: 5AP1130.0702-000 - Technical data

- 1) Yes, although applies only if all components installed within the complete system have this certification and the complete system itself carries the corresponding mark.
- 2) At an ambient temperature of 25°C. Reducing the brightness by 50% can result in an approximately 50% increase in the half-brightness time.
- 3) The specifications for the touch screen driver must be taken into consideration. See chapter 4 "Software", section 2 "Multi-touch drivers".
- 4) There may be visible deviations in the color and surface appearance depending on the process or batch.

3.1.4.4 Dimensions

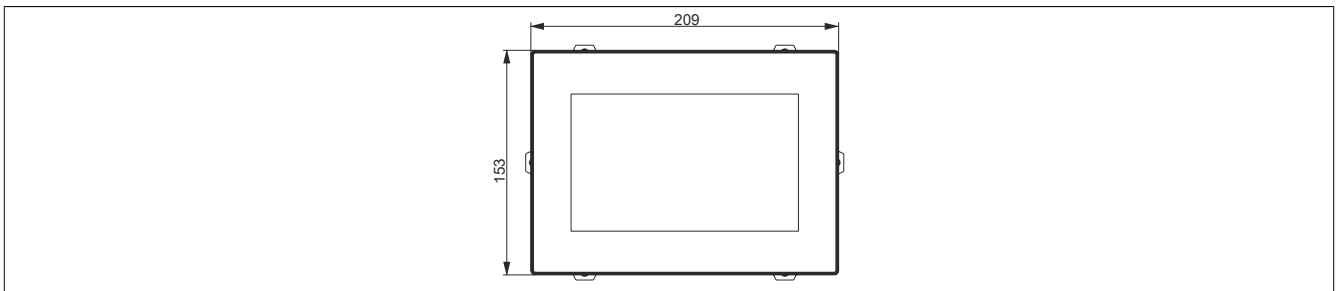

Figure 49: 5AP1130.0702-000 - Dimensions

3.1.4.5 Temperature/Humidity diagram

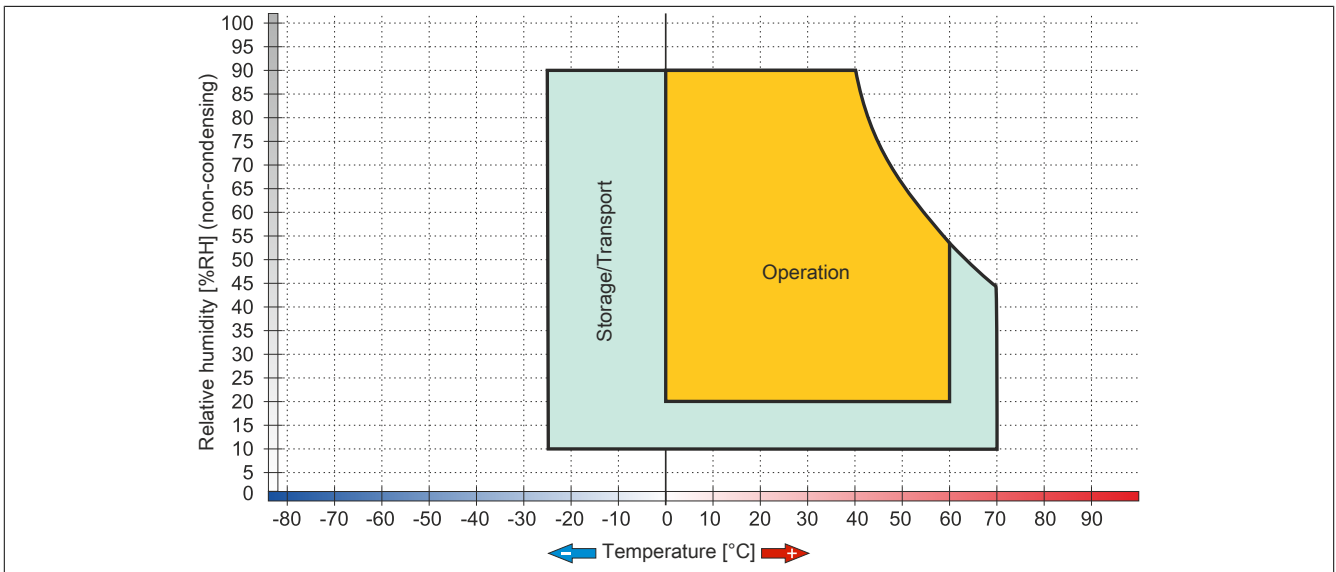

Figure 50: 5AP1130.0702-000 - Temperature/Humidity diagram

3.1.5 5AP1120.101E-000

3.1.5.1 General information

- Panel for AP1000, PPC2100 or PPC3100
- 10.1" TFT WXGA color display
- Single-touch (analog resistive)
- Control cabinet installation

3.1.5.2 Order data

Model number	Short description	Figure
5AP1120.101E-000	Panels Automation Panel 10.1" WXGA TFT - 1280 x 800 pixels (16:10) - Single-touch (analog resistive) - Control cabinet installation - Landscape format - For PPC2100 / PPC3100 / link modules	

Table 53: 5AP1120.101E-000 - Order data

3.1.5.3 Technical data

Information:

The following specifications, properties and limit values apply only to this individual component and may deviate from those that apply to the complete system. For the complete system in which this individual component is used, for example, the data specified for that complete system applies.

Model number	5AP1120.101E-000
General information	
B&R ID code	0xE93D
Certifications	
CE	Yes
UL	cULus E115267 Industrial control equipment
HazLoc	cULus HazLoc E180196 Industrial control equipment for hazardous locations Class I, Division 2, Groups ABCD, T4 ¹⁾
Display	
Type	Color TFT
Diagonal	10.1"
Colors	16.7 million
Resolution	WXGA, 1280 x 800 pixels
Contrast	1000:1
Viewing angles	
Horizontal	Direction R = 85° / Direction L = 85°
Vertical	Direction U = 85° / Direction D = 85°
Backlight	
Type	LED
Brightness (dimnable)	Typ. 25 to 500 cd/m ²
Half-brightness time ²⁾	50,000 h
Touch screen ³⁾	
Type	AMT
Technology	Analog, resistive
Controller	B&R, serial, 12-bit
Transmittance	81% ±3%
Operating conditions	
Pollution degree per EN 61131-2	Pollution degree 2
Degree of protection per EN 60529	Front: IP65 Back: IP20 (only with installed link module or installed system unit)
Protection per UL 50	Front: Type 4X indoor use only

Table 54: 5AP1120.101E-000 - Technical data

Model number	5AP1120.101E-000
Mechanical characteristics	
Front ⁴⁾	
Frame	Coated aluminum
Keypad overlay	
Material	Polyester
Light background	RAL 9006
Dark gray border around display	RAL 7024
Gasket	3 mm built-in gasket
Dimensions	
Width	279 mm
Height	191 mm
Weight	1900 g

Table 54: 5AP1120.101E-000 - Technical data

- 1) Yes, although applies only if all components installed within the complete system have this certification and the complete system itself carries the corresponding mark.
- 2) At an ambient temperature of 25°C. Reducing the brightness by 50% can result in an approximately 50% increase in the half-brightness time.
- 3) Touch screen drivers for approved operating systems are available in the Downloads section of the B&R website.
- 4) There may be visible deviations in the color and surface appearance depending on the process or batch.

3.1.5.4 Dimensions

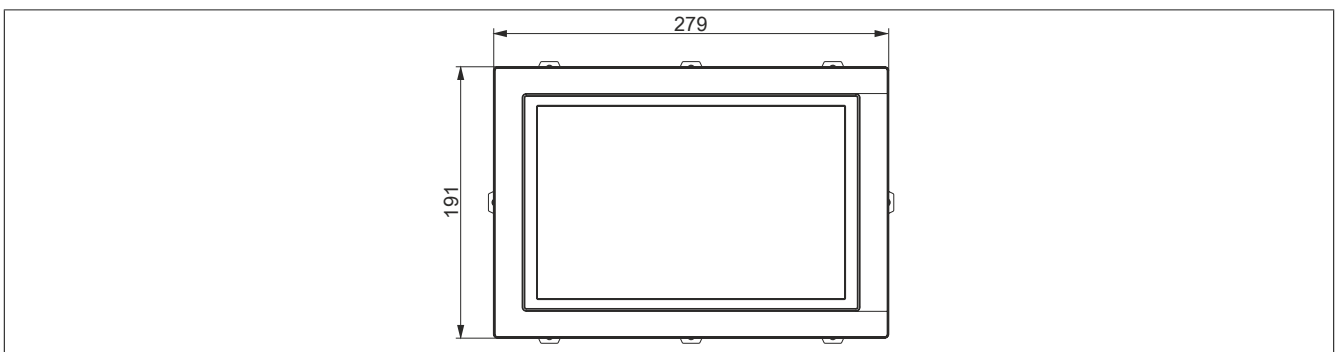

Figure 51: 5AP1120.101E-000 - Dimensions

3.1.5.5 Temperature/Humidity diagram

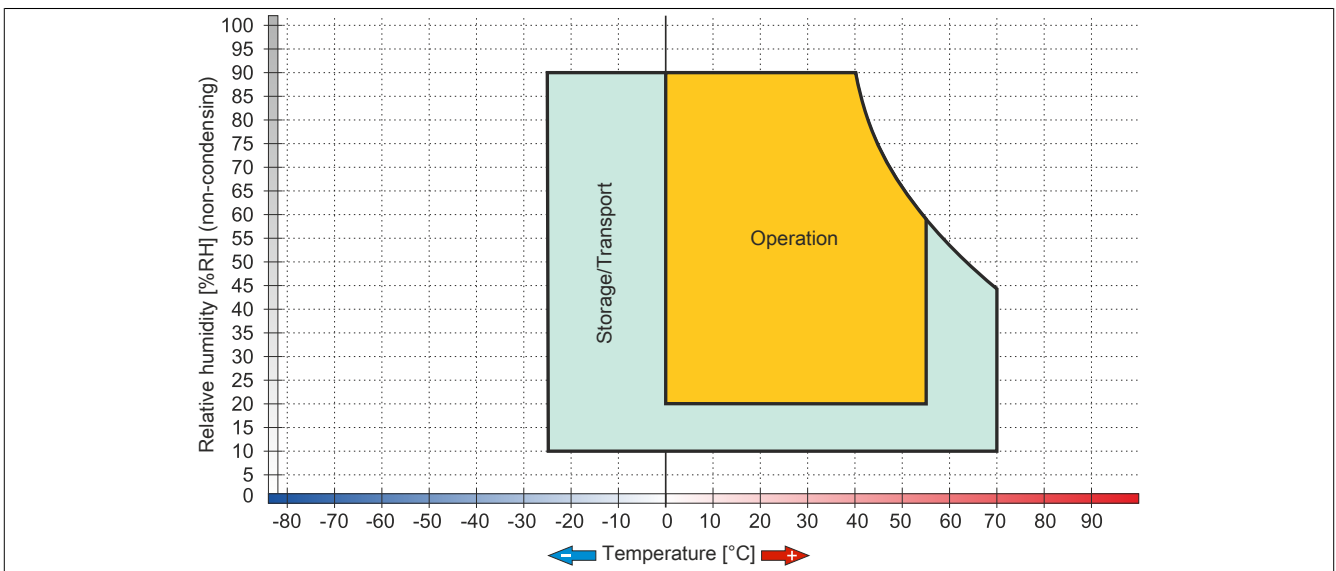

Figure 52: 5AP1120.101E-000 - Temperature/Humidity diagram

3.1.6 5AP1130.101E-000

3.1.6.1 General information

- Panel for AP1000, PPC2100 or PPC3100
- 10.1" TFT WXGA color display
- Multi-touch (projected capacitive)
- Control cabinet installation

3.1.6.2 Order data

Model number	Short description	Figure
5AP1130.101E-000	Panels Automation Panel 10.1" WXGA TFT - 1280 x 800 pixels (16:10) - Multi-touch (projected capacitive) - Control cabinet installation - Landscape format - For PPC2100 / PPC3100 / link modules	

Table 55: 5AP1130.101E-000 - Order data

3.1.6.3 Technical data

Information:

The following specifications, properties and limit values apply only to this individual component and may deviate from those that apply to the complete system. For the complete system in which this individual component is used, for example, the data specified for that complete system applies.

Model number	5AP1130.101E-000
General information	
B&R ID code	0xEB62
Certifications	
CE	Yes
UL	cULus E115267 Industrial control equipment
HazLoc	cULus HazLoc E180196 Industrial control equipment for hazardous locations Class I, Division 2, Groups ABCD, T4 ¹⁾
Display	
Type	Color TFT
Diagonal	10.1"
Colors	16.7 million
Resolution	WXGA, 1280 x 800 pixels
Contrast	1000:1
Viewing angles	
Horizontal	Direction R = 85° / Direction L = 85°
Vertical	Direction U = 85° / Direction D = 85°
Backlight	
Type	LED
Brightness (dimnable)	Typ. 25 to 500 cd/m ²
Half-brightness time ²⁾	50,000 h
Touch screen ³⁾	
Type	3M
Technology	Projected capacitive touch (PCT)
Controller	3M
Transmittance	See appendix A "Touch screen".
Operating conditions	
Pollution degree per EN 61131-2	Pollution degree 2
Degree of protection per EN 60529	Front: IP65 Back: IP20 (only with installed link module or installed system unit)
Protection per UL 50	Front: Type 4X indoor use only

Table 56: 5AP1130.101E-000 - Technical data

Model number	5AP1130.101E-000
Mechanical characteristics	
Front ⁴⁾	
Frame	Coated aluminum
Design	Black
Gasket	3 mm built-in gasket
Dimensions	
Width	279 mm
Height	191 mm
Weight	2000 g

Table 56: 5AP1130.101E-000 - Technical data

- 1) Yes, although applies only if all components installed within the complete system have this certification and the complete system itself carries the corresponding mark.
- 2) At an ambient temperature of 25°C. Reducing the brightness by 50% can result in an approximately 50% increase in the half-brightness time.
- 3) The specifications for the touch screen driver must be taken into consideration. See chapter 4 "Software", section 2 "Multi-touch drivers".
- 4) There may be visible deviations in the color and surface appearance depending on the process or batch.

3.1.6.4 Dimensions

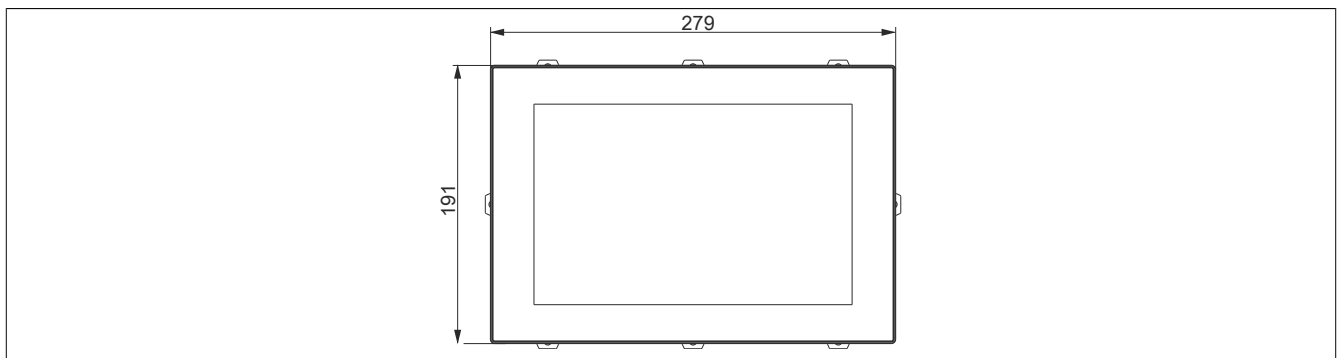

Figure 53: 5AP1130.101E-000 - Dimensions

3.1.6.5 Temperature/Humidity diagram

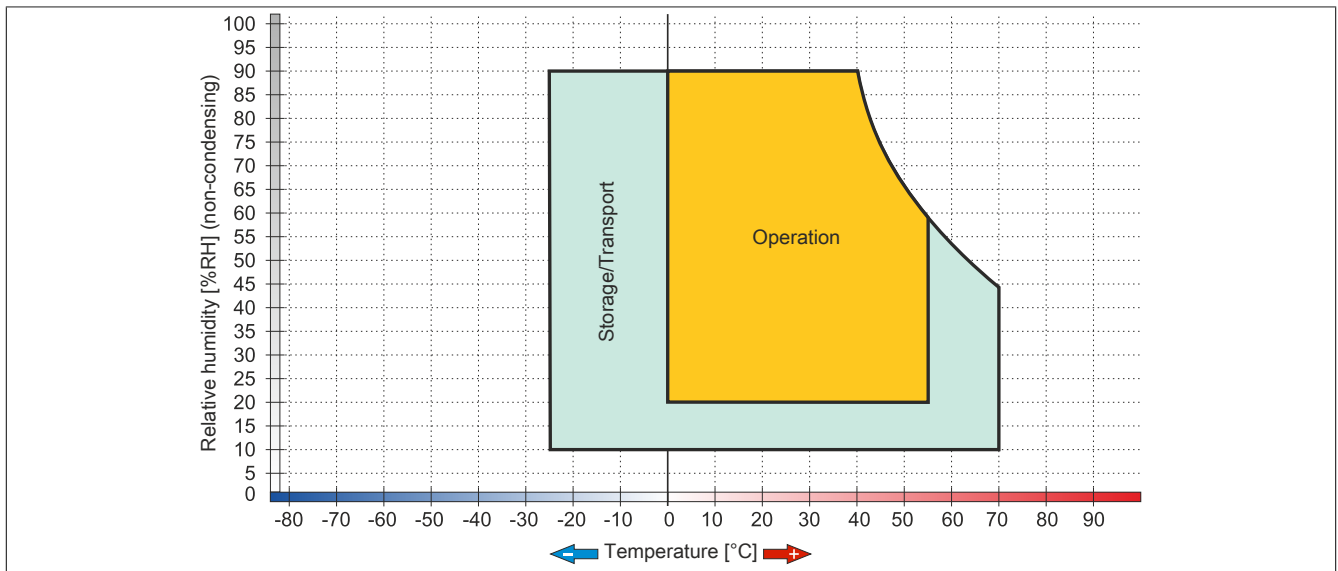

Figure 54: 5AP1130.101E-000 - Temperature/Humidity diagram

3.1.7 5AP1120.1043-000

3.1.7.1 General information

- Panel for AP1000, PPC900, PPC2100 or PPC3100
- 10.4" TFT VGA color display
- Single-touch (analog resistive)
- Front USB interface
- Control cabinet installation

3.1.7.2 Order data

Model number	Short description	Figure
5AP1120.1043-000	Panels Automation Panel 10.4" VGA TFT - 640 x 480 pixels (4:3) - Single-touch (analog resistive) - Control cabinet installation - Landscape format - Front USB - For PPC900 / PPC2100 / PPC3100 - For link modules - Compatible with 5PP520.1043-00	

Table 57: 5AP1120.1043-000 - Order data

3.1.7.3 Technical data

Information:

The following specifications, properties and limit values apply only to this individual component and may deviate from those that apply to the complete system. For the complete system in which this individual component is used, for example, the data specified for that complete system applies.

Model number	5AP1120.1043-000
General information	
B&R ID code	0xE7AD
Certifications	
CE	Yes
UL	cULus E115267 Industrial control equipment
HazLoc	cULus HazLoc E180196 Industrial control equipment for hazardous locations Class I, Division 2, Groups ABCD, T4 ¹⁾
Interfaces	
USB	
Quantity	1
Type	USB 2.0
Design	Type A
Transfer rate	Low speed (1.5 Mbit/s), full speed (12 Mbit/s), high speed (480 Mbit/s)
Current-carrying capacity	Max. 500 mA
Display	
Type	TFT color
Diagonal	10.4"
Colors	16.7 million
Resolution	VGA, 640 x 480 pixels
Contrast	900:1
Viewing angles	
Horizontal	Direction R = 80° / Direction L = 80°
Vertical	Direction U = 80° / Direction D = 80°
Backlight	
Type	LED
Brightness (dimnable)	Typ. 22.5 to 450 cd/m ²
Half-brightness time ²⁾	70,000 h

Table 58: 5AP1120.1043-000 - Technical data

Model number	5AP1120.1043-000
Touch screen ³⁾	
Type	AMT
Technology	Analog, resistive
Controller	B&R, serial, 12-bit
Transmittance	81% ±3%
Operating conditions	
Pollution degree per EN 61131-2	Pollution degree 2
Degree of protection per EN 60529	Front: IP65 Back: IP20 (only with installed link module or installed system unit)
Protection per UL 50	Front: Type 4X indoor use only
Mechanical characteristics	
Front ⁴⁾	
Frame	Naturally anodized aluminum
Keypad overlay	
Material	Polyester
Light background	RAL 9006
Dark gray border around display	RAL 7024
Gasket	3 mm built-in gasket
Dimensions	
Width	323 mm
Height	260 mm
Weight	2800 g

Table 58: 5AP1120.1043-000 - Technical data

- 1) Yes, although applies only if all components installed in the complete system have this certification and the complete system bears the corresponding mark.
- 2) At an ambient temperature of 25°C. Reducing the brightness by 50% can increase the half-brightness time by approximately 50%.
- 3) Touch screen drivers for approved operating systems are available for download in the Downloads section of the B&R website.
- 4) There may be visible deviations in the color and surface appearance depending on the process or batch.

3.1.7.4 Dimensions

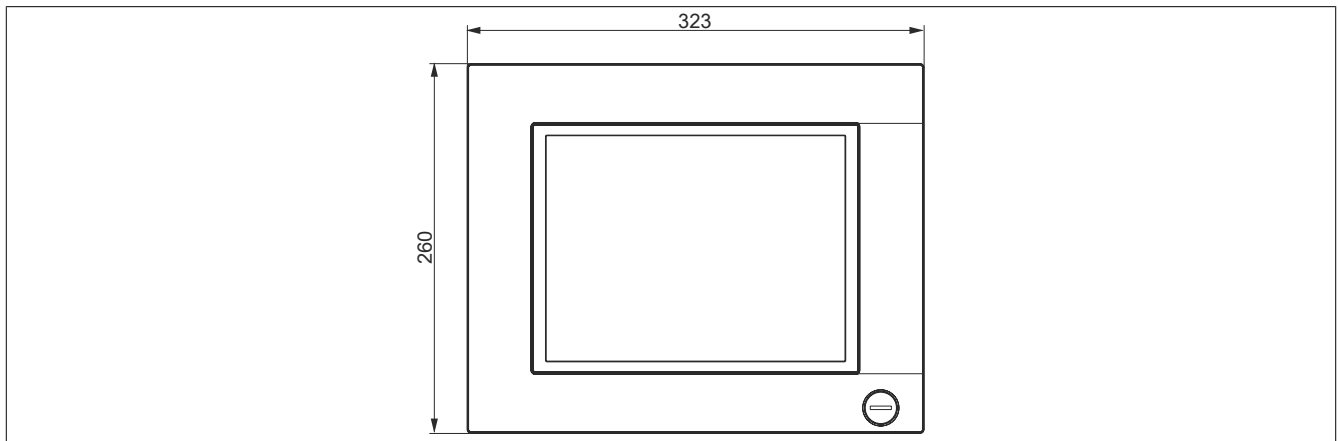

Figure 55: 5AP1120.1043-000 - Dimensions

3.1.7.5 Requirements

10.4" AP1000 panels are supported starting with the following firmware versions:

- Firmware V3.11 or later for SDL/DVI receiver 5DLSDL.1001-00
- Firmware V4.08 or later for SDL3 receiver 5DLSD3.1001-00
- Firmware V1.03 or later for PPC2100 system unit 5PPC2100.BYxx-000
- Firmware V1.18 or later for PPC900 system unit 5PC901.TS77-xx

3.1.7.6 Temperature/Humidity diagram

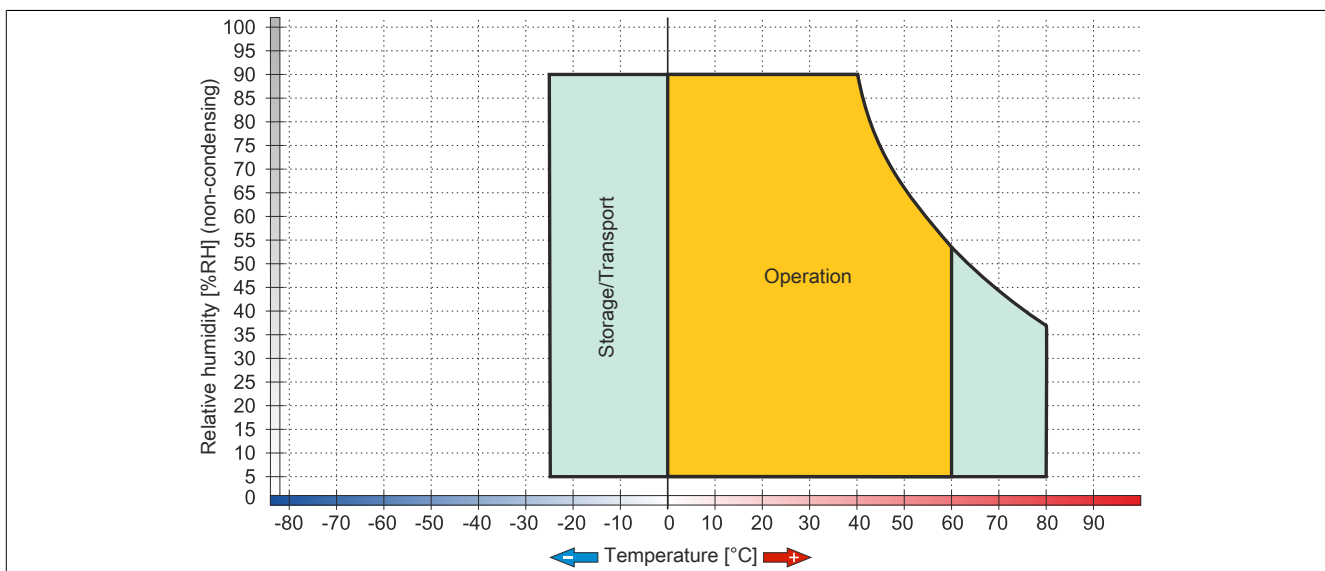

Figure 56: 5AP1120.1043-000 - Temperature/Humidity diagram

3.1.8 5AP1180.1043-000

3.1.8.1 General information

- Panel for AP1000, PPC900, PPC2100 or PPC3100
- 10.4" TFT VGA color display
- Single-touch (analog resistive)
- 22 function keys
- Front USB interface
- Control cabinet installation

3.1.8.2 Order data

Model number	Short description	Figure
	Panels	
5AP1180.1043-000	Automation Panel 10.4" VGA TFT - 640 x 480 pixels (4:3) - Single-touch (analog resistive) - Control cabinet installation - Landscape format - Front USB - 22 function keys - For PPC900/PPC2100/PPC3100- For link modules - Compatible with 5PP580.1043-00, 5AP980.1043-01	

Table 59: 5AP1180.1043-000 - Order data

3.1.8.3 Technical data

Information:

The following specifications, properties and limit values apply only to this individual component and may deviate from those that apply to the complete system. For the complete system in which this individual component is used, for example, the data specified for that complete system applies.

Model number	5AP1180.1043-000
General information	
B&R ID code	0xE7AE
Certifications	
CE	Yes
UL	cULus E115267 Industrial control equipment
HazLoc	cULus HazLoc E180196 Industrial control equipment for hazardous locations Class I, Division 2, Groups ABCD, T4 ¹⁾
Interfaces	
USB	
Quantity	1
Type	USB 2.0
Design	Type A
Transfer rate	Low speed (1.5 Mbit/s), full speed (12 Mbit/s), high speed (480 Mbit/s)
Current-carrying capacity	Max. 500 mA
Display	
Type	TFT color
Diagonal	10.4"
Colors	16.7 million
Resolution	VGA, 640 x 480 pixels
Contrast	900:1
Viewing angles	
Horizontal	Direction R = 80° / Direction L = 80°
Vertical	Direction U = 80° / Direction D = 80°
Backlight	
Type	LED
Brightness (dimnable)	Typ. 22.5 to 450 cd/m ²
Half-brightness time ²⁾	70,000 h

Table 60: 5AP1180.1043-000 - Technical data

Model number	5AP1180.1043-000
Touch screen ³⁾	
Type	AMT
Technology	Analog, resistive
Controller	B&R, serial, 12-bit
Transmittance	81% ±3%
Keys	
Function keys	22 with LED (yellow)
System keys	No
Service life	>1,000,000 actuations at 1 ±0.3 N to 3 ±0.3 N actuating force
LED brightness	
Yellow	Typ. 38 mcd
Operating conditions	
Pollution degree per EN 61131-2	Pollution degree 2
Degree of protection per EN 60529	Front: IP65 Back: IP20 (only with installed link module or installed system unit)
Protection per UL 50	Front: Type 4X indoor use only
Mechanical characteristics	
Front ⁴⁾	
Frame	Naturally anodized aluminum
Keypad overlay	
Material	Polyester
Light background	RAL 9006
Dark gray border around display	RAL 7024
Gasket	3 mm built-in gasket
Dimensions	
Width	323 mm
Height	260 mm
Weight	2800 g

Table 60: 5AP1180.1043-000 - Technical data

- 1) Yes, although applies only if all components installed in the complete system have this certification and the complete system bears the corresponding mark.
- 2) At an ambient temperature of 25°C. Reducing the brightness by 50% can increase the half-brightness time by approximately 50%.
- 3) Touch screen drivers for approved operating systems are available for download in the Downloads section of the B&R website.
- 4) There may be visible deviations in the color and surface appearance depending on the process or batch.

3.1.8.4 Dimensions

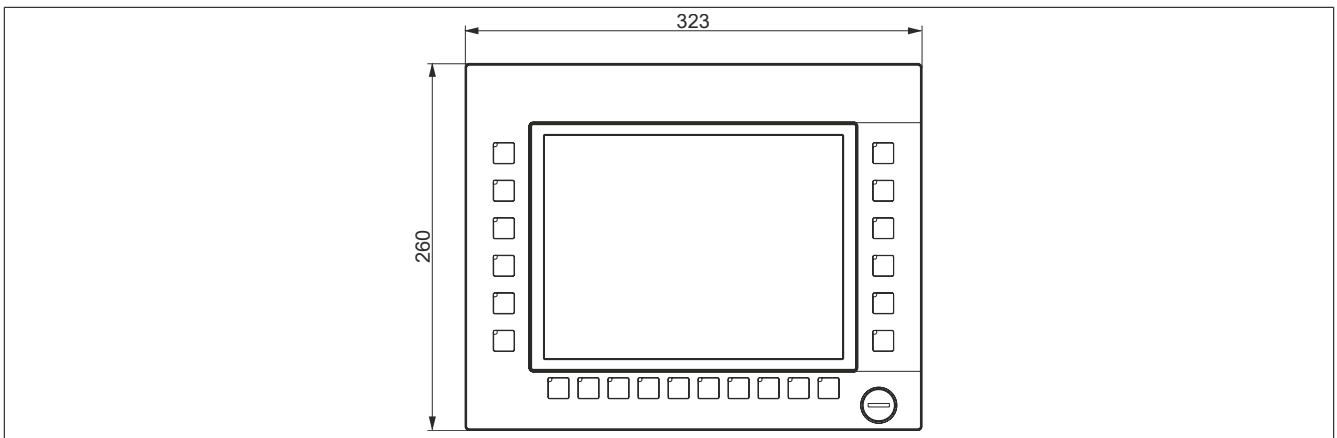

Figure 57: 5AP1180.1043-000 - Dimensions

3.1.8.5 Requirements

10.4" AP1000 panels are supported starting with the following firmware versions:

- Firmware V3.11 or later for SDL/DVI receiver 5DLSDL.1001-00
- Firmware V4.08 or later for SDL3 receiver 5DLSD3.1001-00
- Firmware V1.03 or later for PPC2100 system unit 5PPC2100.BYxx-000
- Firmware V1.18 or later for PPC900 system unit 5PC901.TS77-xx

3.1.8.6 Temperature/Humidity diagram

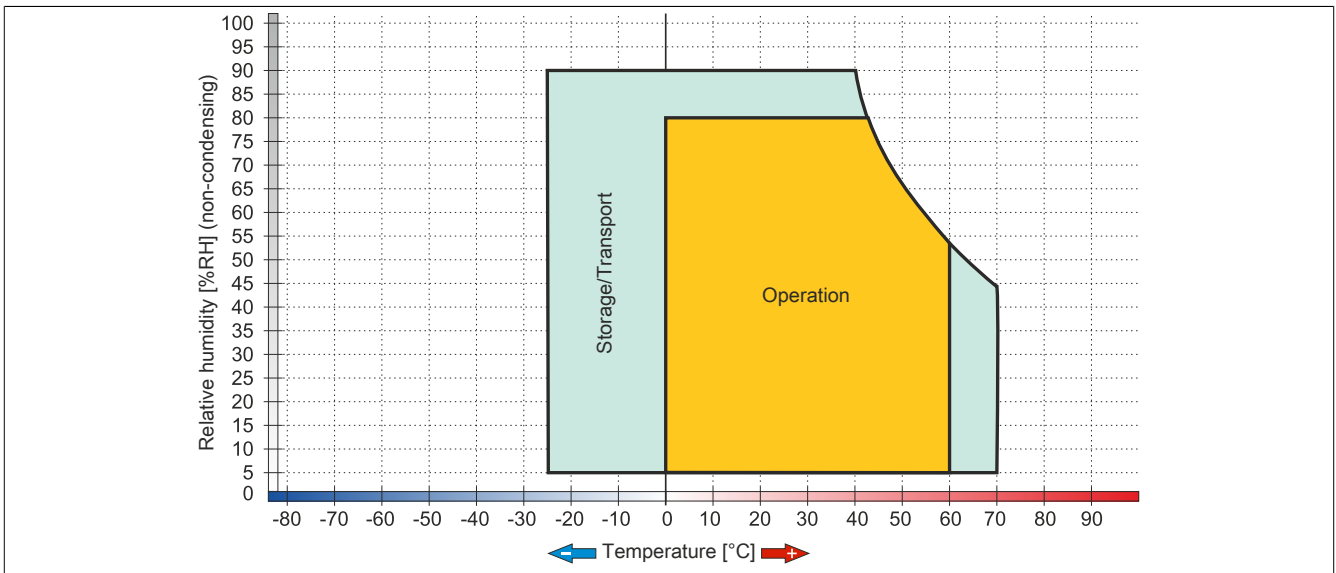

Figure 58: 5AP1180.1043-000 - Temperature/Humidity diagram

3.1.9 5AP1181.1043-000

3.1.9.1 General information

- Panel for AP1000, PPC900, PPC2100 or PPC3100
- 10.4" TFT VGA color display
- Single-touch (analog resistive)
- 38 function keys and 20 system keys
- Front USB interface
- Control cabinet installation

3.1.9.2 Order data

Model number	Short description	Figure
	Panels	
5AP1181.1043-000	Automation Panel 10.4" VGA TFT - 640 x 480 pixels (4:3) - Single-touch (analog resistive) - Control cabinet installation - Portrait format - Front USB - 38 function keys and 20 system keys - For PPC900/PPC2100/PPC3100 - For link modules - Compatible with 5PP581.1043-00, 5AP981.1043-01, 5PC781.1043-00	

Table 61: 5AP1181.1043-000 - Order data

3.1.9.3 Technical data

Information:

The following specifications, properties and limit values apply only to this individual component and may deviate from those that apply to the complete system. For the complete system in which this individual component is used, for example, the data specified for that complete system applies.

Model number	5AP1181.1043-000
General information	
B&R ID code	0xE7AF
Certifications	
CE	Yes
UL	cULus E115267 Industrial control equipment
HazLoc	cULus HazLoc E180196 Industrial control equipment for hazardous locations Class I, Division 2, Groups ABCD, T4 ¹⁾
Interfaces	
USB	
Quantity	1
Type	USB 2.0
Design	Type A
Transfer rate	Low speed (1.5 Mbit/s), full speed (12 Mbit/s), high speed (480 Mbit/s)
Current-carrying capacity	Max. 500 mA
Display	
Type	TFT color
Diagonal	10.4"
Colors	16.7 million
Resolution	VGA, 640 x 480 pixels
Contrast	900:1
Viewing angles	
Horizontal	Direction R = 80° / Direction L = 80°
Vertical	Direction U = 80° / Direction D = 80°

Table 62: 5AP1181.1043-000 - Technical data

Model number	5AP1181.1043-000
Backlight	
Type	LED
Brightness (dimnable)	Typ. 22.5 to 450 cd/m ²
Half-brightness time ²⁾	70,000 h
Touch screen ³⁾	
Type	AMT
Technology	Analog, resistive
Controller	B&R, serial, 12-bit
Transmittance	81% ±3%
Keys	
Function keys	38 with LED (yellow)
System keys	Numeric keys, cursor block
Service life	>1,000,000 actuations at 1 ±0.3 N to 3 ±0.3 N actuating force
LED brightness	
Yellow	Typ. 38 mcd
Operating conditions	
Pollution degree per EN 61131-2	Pollution degree 2
Degree of protection per EN 60529	Front: IP65 Back: IP20 (only with installed link module or installed system unit)
Protection per UL 50	Front: Type 4X indoor use only
Mechanical characteristics	
Front ⁴⁾	
Frame	Naturally anodized aluminum
Keypad overlay	
Material	Polyester
Light background	RAL 9006
Dark gray border around display	RAL 7024
Gasket	3 mm built-in gasket
Dimensions	
Width	323 mm
Height	358 mm
Weight	3400 g

Table 62: 5AP1181.1043-000 - Technical data

- 1) Yes, although applies only if all components installed in the complete system have this certification and the complete system bears the corresponding mark.
- 2) At an ambient temperature of 25°C. Reducing the brightness by 50% can increase the half-brightness time by approximately 50%.
- 3) Touch screen drivers for approved operating systems are available for download in the Downloads section of the B&R website.
- 4) There may be visible deviations in the color and surface appearance depending on the process or batch.

3.1.9.4 Dimensions

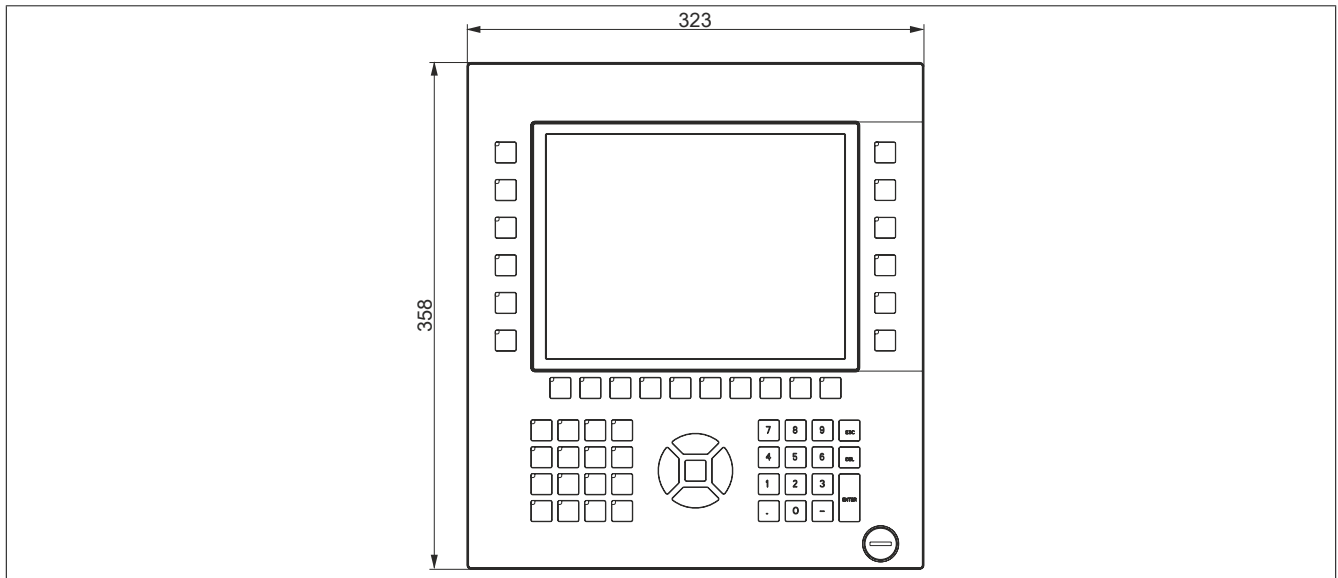

Figure 59: 5AP1181.1043-000 - Dimensions

3.1.9.5 Requirements

10.4" AP1000 panels are supported starting with the following firmware versions:

- Firmware V3.11 or later for SDL/DVI receiver 5DLSDL.1001-00
- Firmware V4.08 or later for SDL3 receiver 5DLSD3.1001-00

- Firmware V1.03 or later for PPC2100 system unit 5PPC2100.BYxx-000
- Firmware V1.18 or later for PPC900 system unit 5PC901.TS77-xx

3.1.9.6 Temperature/Humidity diagram

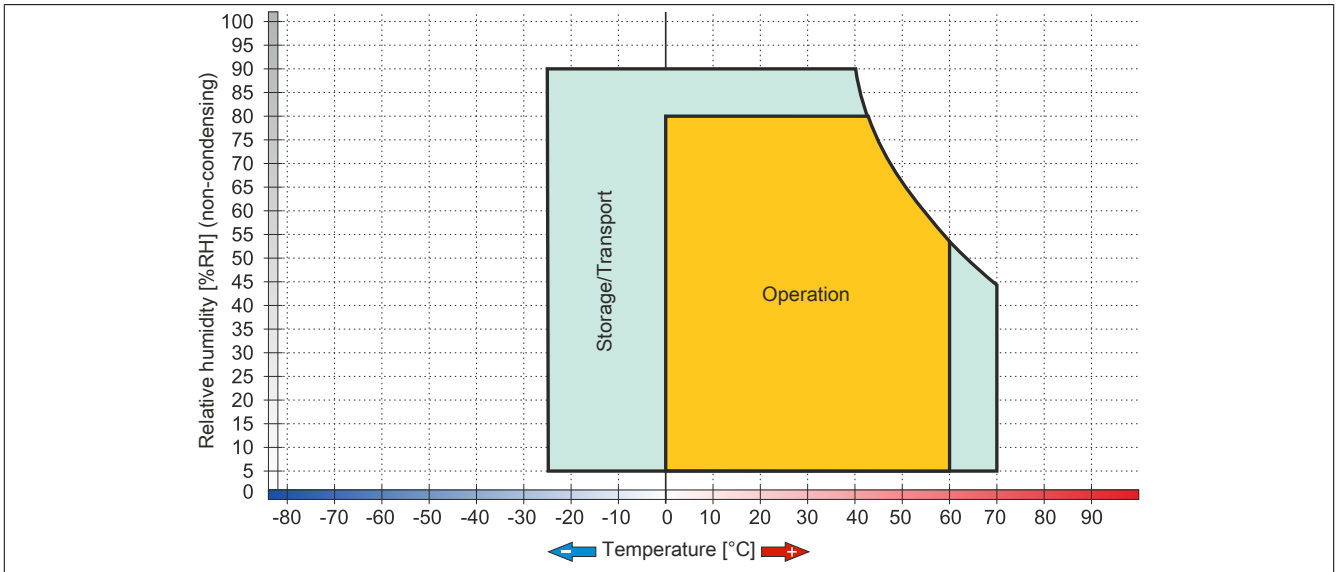

Figure 60: 5AP1181.1043-000 - Temperature/Humidity diagram

3.1.10 5AP1182.1043-000

3.1.10.1 General information

- Panel for AP1000, PPC900, PPC2100 or PPC3100
- 10.4" TFT VGA color display
- Single-touch (analog resistive)
- 44 function keys and 20 system keys
- Front USB interface
- Control cabinet installation

3.1.10.2 Order data

Model number	Short description	Figure
	Panels	
5AP1182.1043-000	Automation Panel 10.4" VGA TFT - 640 x 480 pixels (4:3) - Single-touch (analog resistive) - Control cabinet installation - Landscape format - Front USB - 44 function keys and 20 system keys - For PPC900/PPC2100/PPC3100 - For link modules - Compatible with 5PP582.1043-00, 5AP982.1043-01, 5PC782.1043-00	

Table 63: 5AP1182.1043-000 - Order data

3.1.10.3 Technical data

Information:

The following specifications, properties and limit values apply only to this individual component and may deviate from those that apply to the complete system. For the complete system in which this individual component is used, for example, the data specified for that complete system applies.

Model number	5AP1182.1043-000
General information	
B&R ID code	0xE7B0
Certifications	
CE	Yes
UL	cULus E115267 Industrial control equipment
HazLoc	cULus HazLoc E180196 Industrial control equipment for hazardous locations Class I, Division 2, Groups ABCD, T4 ¹⁾
Interfaces	
USB	
Quantity	1
Type	USB 2.0
Design	Type A
Transfer rate	Low speed (1.5 Mbit/s), full speed (12 Mbit/s), high speed (480 Mbit/s)
Current-carrying capacity	Max. 500 mA
Display	
Type	TFT color
Diagonal	10.4"
Colors	16.7 million
Resolution	VGA, 640 x 480 pixels
Contrast	900:1
Viewing angles	
Horizontal	Direction R = 80° / Direction L = 80°
Vertical	Direction U = 80° / Direction D = 80°
Backlight	
Type	LED
Brightness (dimnable)	Typ. 22.5 to 450 cd/m ²
Half-brightness time ²⁾	70,000 h

Table 64: 5AP1182.1043-000 - Technical data

Model number	5AP1182.1043-000
Touch screen ³⁾	
Type	AMT
Technology	Analog, resistive
Controller	B&R, serial, 12-bit
Transmittance	81% ±3%
Keys	
Function keys	44 with LED (yellow)
System keys	Numeric keys, cursor block
Service life	>1,000,000 actuations at 1 ±0.3 N to 3 ±0.3 N actuating force
LED brightness	
Yellow	Typ. 38 mcd
Operating conditions	
Pollution degree per EN 61131-2	Pollution degree 2
Degree of protection per EN 60529	Front: IP65 Back: IP20 (only with installed link module or installed system unit)
Protection per UL 50	Front: Type 4X indoor use only
Mechanical characteristics	
Front ⁴⁾	
Frame	Naturally anodized aluminum
Keypad overlay	
Material	Polyester
Light background	RAL 9006
Dark gray border around display	RAL 7024
Gasket	3 mm built-in gasket
Dimensions	
Width	423 mm
Height	288 mm
Weight	3500 g

Table 64: 5AP1182.1043-000 - Technical data

- 1) Yes, although applies only if all components installed in the complete system have this certification and the complete system bears the corresponding mark.
- 2) At an ambient temperature of 25°C. Reducing the brightness by 50% can increase the half-brightness time by approximately 50%.
- 3) Touch screen drivers for approved operating systems are available for download in the Downloads section of the B&R website.
- 4) There may be visible deviations in the color and surface appearance depending on the process or batch.

3.1.10.4 Dimensions

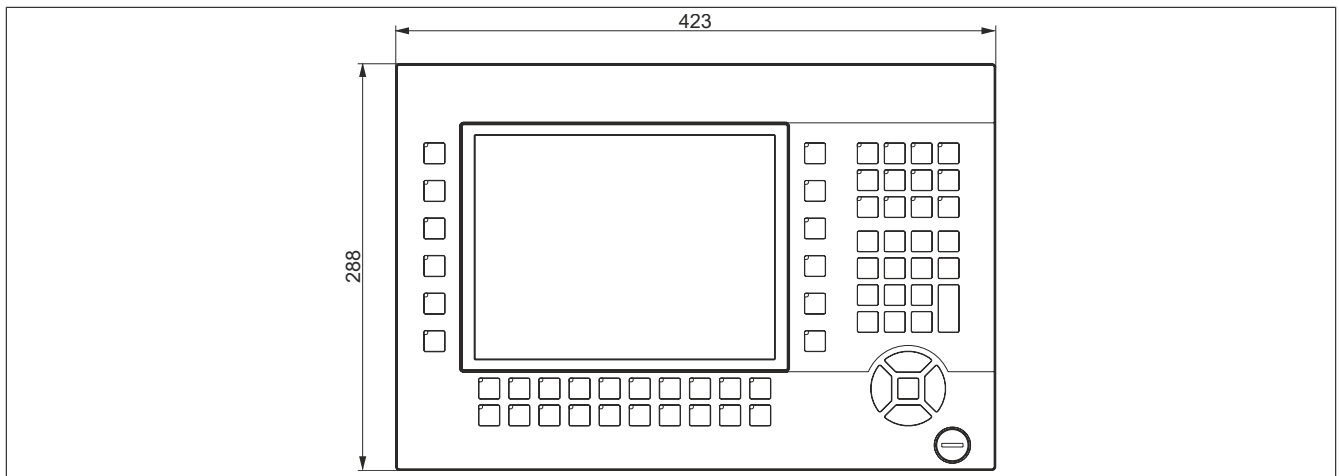

Figure 61: 5AP1182.1043-000 - Dimensions

3.1.10.5 Requirements

10.4" AP1000 panels are supported starting with the following firmware versions:

- Firmware V3.11 or later for SDL/DVI receiver 5DLSDL.1001-00
- Firmware V4.08 or later for SDL3 receiver 5DLSD3.1001-00
- Firmware V1.03 or later for PPC2100 system unit 5PPC2100.BYxx-000
- Firmware V1.18 or later for PPC900 system unit 5PC901.TS77-xx

3.1.10.6 Temperature/Humidity diagram

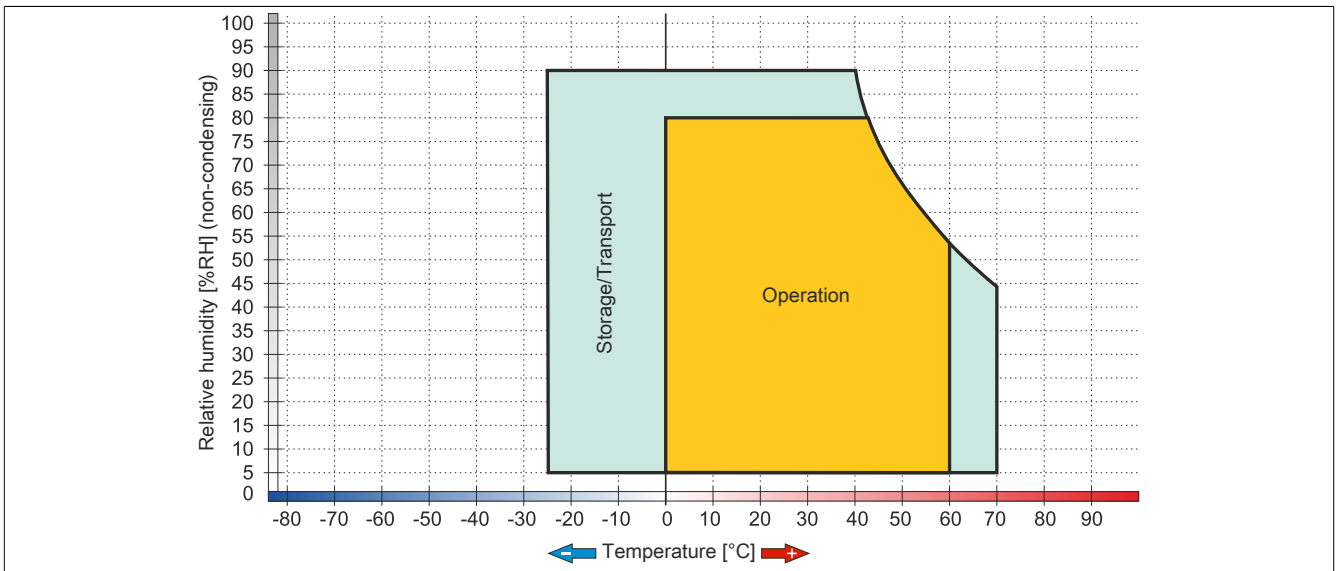

Figure 62: 5AP1182.1043-000 - Temperature/Humidity diagram

3.1.11 5AP1120.1214-000

3.1.11.1 General information

- Panel for AP1000, PPC900, PPC2100 or PPC3100
- 12.1" TFT SVGA color display
- Single-touch (analog resistive)
- Front USB interface
- Control cabinet installation

3.1.11.2 Order data

Model number	Short description	Figure
5AP1120.1214-000	Panels Automation Panel 12.1" SVGA TFT - 800 x 600 pixels (4:3) - Single-touch (analog resistive) - Control cabinet installation - Landscape format - Front USB - For PPC900 / PPC2100 / PPC3100 - For link modules - Compatible with 5PP520.1043-00	

Table 65: 5AP1120.1214-000 - Order data

3.1.11.3 Technical data

Information:

The following specifications, properties and limit values apply only to this individual component and may deviate from those that apply to the complete system. For the complete system in which this individual component is used, for example, the data specified for that complete system applies.

Model number	5AP1120.1214-000
General information	
B&R ID code	0xE7BB
Certifications	
CE	Yes
UL	cULus E115267 Industrial control equipment
HazLoc	cULus HazLoc E180196 Industrial control equipment for hazardous locations Class I, Division 2, Groups ABCD, T4 ¹⁾
Interfaces	
USB	
Quantity	1
Type	USB 2.0
Design	Type A
Transfer rate	Low speed (1.5 Mbit/s), full speed (12 Mbit/s), high speed (480 Mbit/s)
Current-carrying capacity	Max. 500 mA
Display	
Type	Color TFT
Diagonal	12.1"
Colors	16.7 million
Resolution	SVGA, 800 x 600 pixels
Contrast	1500:1
Viewing angles	
Horizontal	Direction R = 89° / Direction L = 89°
Vertical	Direction U = 89° / Direction D = 89°
Backlight	
Type	LED
Brightness (dimnable)	Typ. 22.5 to 450 cd/m ²
Half-brightness time ²⁾	50,000 h

Table 66: 5AP1120.1214-000 - Technical data

Model number	5AP1120.1214-000
Touch screen ³⁾	
Type	AMT
Technology	Analog, resistive
Controller	B&R, serial, 12-bit
Transmittance	81% ±3%
Operating conditions	
Pollution degree per EN 61131-2	Pollution degree 2
Degree of protection per EN 60529	Front: IP65 Back: IP20 (only with installed link module or installed system unit)
Protection per UL 50	Front: Type 4X indoor use only
Mechanical characteristics	
Front ⁴⁾	
Frame	Naturally anodized aluminum
Keypad overlay	
Material	Polyester
Light background	RAL 9006
Dark gray border around display	RAL 7024
Gasket	3 mm built-in seal
Dimensions	
Width	362 mm
Height	284 mm
Weight	3200 g

Table 66: 5AP1120.1214-000 - Technical data

- 1) Yes, although applies only if all components installed within the complete system have this certification and the complete system itself carries the corresponding mark.
- 2) At an ambient temperature of 25°C. Reducing the brightness by 50% can result in an approximately 50% increase in the half-brightness time.
- 3) Touch screen drivers for approved operating systems are available in the Downloads section of the B&R website.
- 4) There may be visible deviations in the color and surface appearance depending on the process or batch.

3.1.11.4 Dimensions

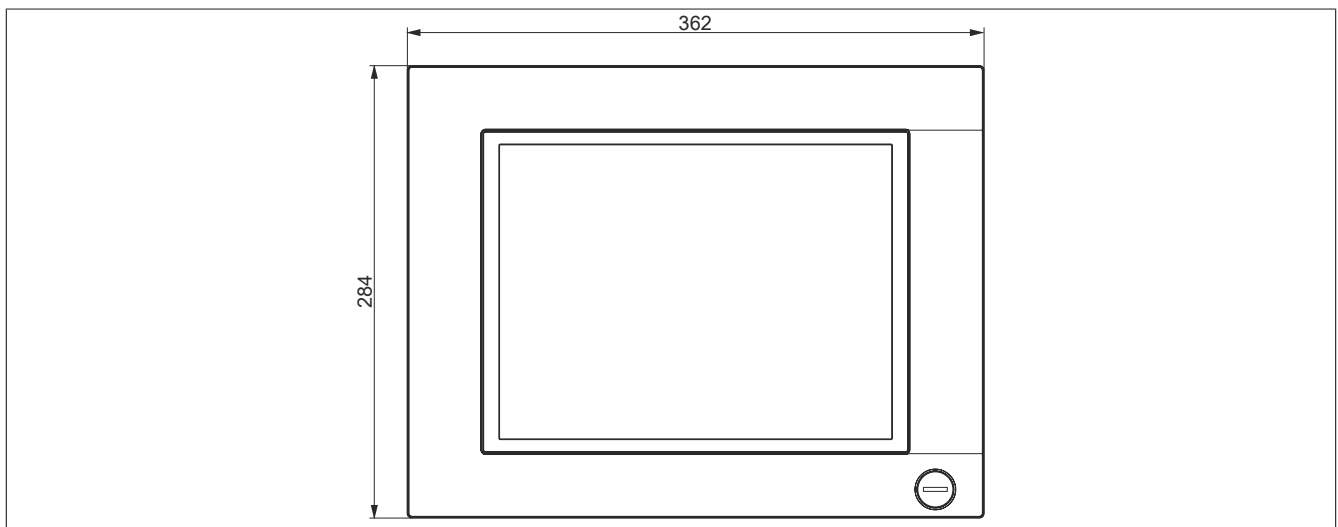

Figure 63: 5AP1120.1214-000 - Dimensions

3.1.11.5 Temperature/Humidity diagram

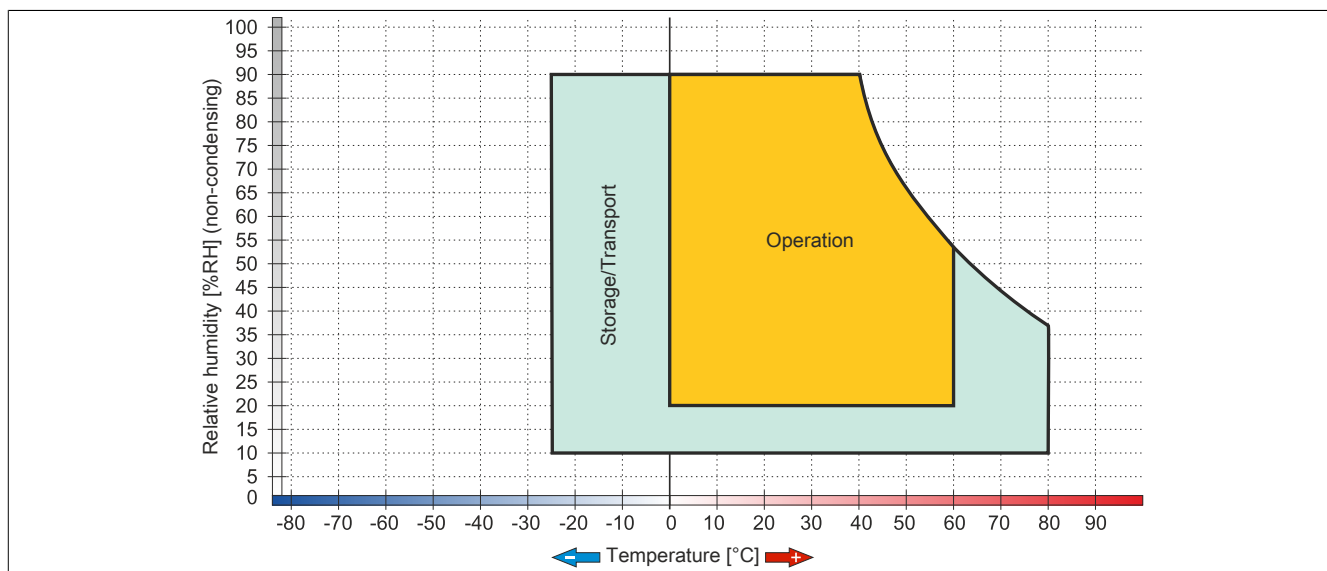

Figure 64: 5AP1120.1214-000 - Temperature/Humidity diagram

3.1.12 5AP1120.121E-000

3.1.12.1 General information

- Panel for AP1000, PPC2100 or PPC3100
- 12.1" TFT WXGA color display
- Single-touch (analog resistive)
- Control cabinet installation

3.1.12.2 Order data

Model number	Short description	Figure
5AP1120.121E-000	Panels Automation Panel 12.1" WXGA TFT - 1280 x 800 pixels (16:10) - Single-touch (analog resistive) - Control cabinet installation - Landscape format - For PPC2100 / PPC3100 / link modules	

Table 67: 5AP1120.121E-000 - Order data

3.1.12.3 Technical data

Information:

The following specifications, properties and limit values apply only to this individual component and may deviate from those that apply to the complete system. For the complete system in which this individual component is used, for example, the data specified for that complete system applies.

Model number	5AP1120.121E-000
General information	
B&R ID code	0xE8E4
Certifications	
CE	Yes
UL	cULus E115267 Industrial control equipment
HazLoc	cULus HazLoc E180196 Industrial control equipment for hazardous locations Class I, Division 2, Groups ABCD, T4 ¹⁾
Display	
Type	Color TFT
Diagonal	12.1"
Colors	16.7 million
Resolution	WXGA, 1280 x 800 pixels
Contrast	900:1
Viewing angles	
Horizontal	Direction R = 80° / Direction L = 80°
Vertical	Direction U = 65° / Direction D = 80°
Backlight	
Type	LED
Brightness (dimnable)	Typ. 40 to 400 cd/m ²
Half-brightness time ²⁾	50,000 h
Touch screen ³⁾	
Type	AMT
Technology	Analog, resistive
Controller	B&R, serial, 12-bit
Transmittance	81% ±3%
Operating conditions	
Pollution degree per EN 61131-2	Pollution degree 2
Degree of protection per EN 60529	Front: IP65 Back: IP20 (only with installed link module or installed system unit)
Protection per UL 50	Front: Type 4X indoor use only

Table 68: 5AP1120.121E-000 - Technical data

Model number	5AP1120.121E-000
Mechanical characteristics	
Front ⁴⁾	
Frame	Coated aluminum
Keypad overlay	
Material	Polyester
Light background	RAL 9006
Dark gray border around display	RAL 7024
Gasket	3 mm built-in gasket
Dimensions	
Width	324 mm
Height	221.5 mm
Weight	2300 g

Table 68: 5AP1120.121E-000 - Technical data

- 1) Yes, although applies only if all components installed within the complete system have this certification and the complete system itself carries the corresponding mark.
- 2) At an ambient temperature of 25°C. Reducing the brightness by 50% can result in an approximately 50% increase in the half-brightness time.
- 3) Touch screen drivers for approved operating systems are available in the Downloads section of the B&R website.
- 4) There may be visible deviations in the color and surface appearance depending on the process or batch.

3.1.12.4 Dimensions

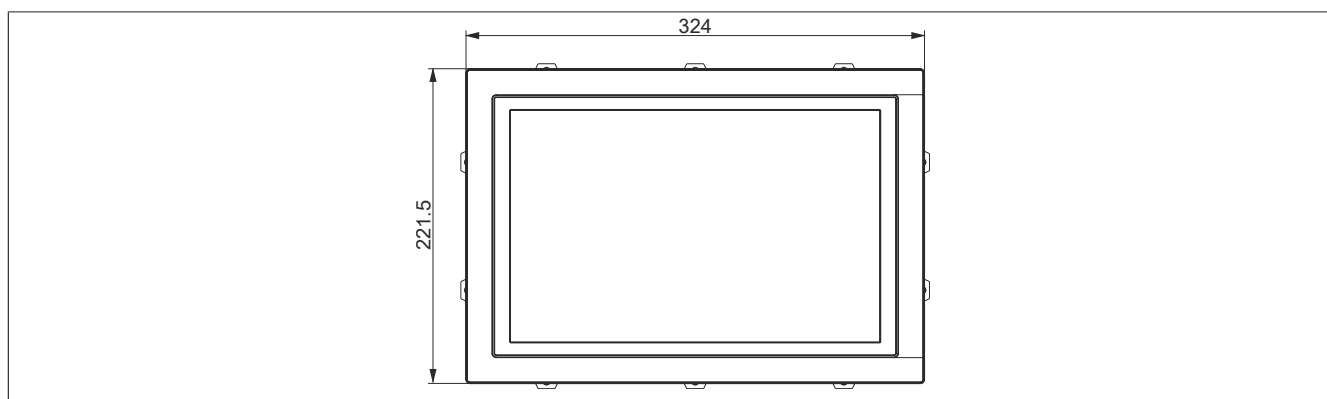

Figure 65: 5AP1120.121E-000 - Dimensions

3.1.12.5 Temperature/Humidity diagram

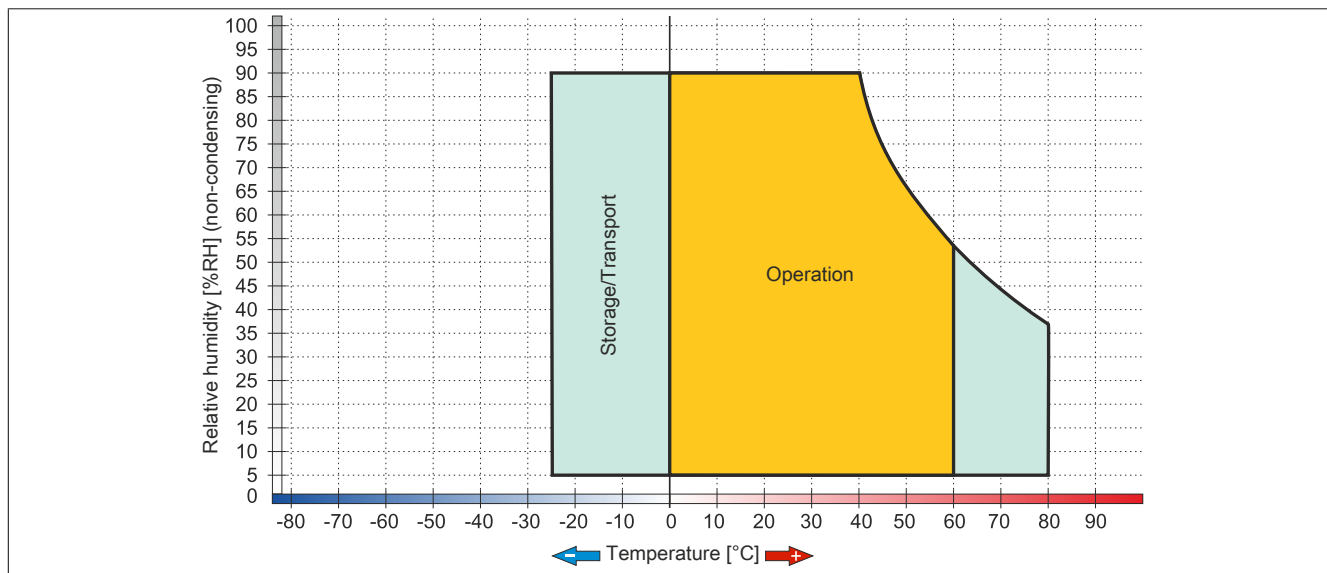

Figure 66: 5AP1120.121E-000 - Temperature/Humidity diagram

3.1.13 5AP1130.121E-000

3.1.13.1 General information

- Panel for AP1000, PPC2100 or PPC3100
- 12.1" TFT WXGA color display
- Multi-touch (projected capacitive)
- Control cabinet installation

3.1.13.2 Order data

Model number	Short description	Figure
5AP1130.121E-000	Panels Automation Panel 12.1" WXGA TFT - 1280 x 800 pixels (16:10) - Multi-touch (projected capacitive) - Control cabinet installation - Landscape format - For PPC2100 / PPC3100 / link modules	

Table 69: 5AP1130.121E-000 - Order data

3.1.13.3 Technical data

Information:

The following specifications, properties and limit values apply only to this individual component and may deviate from those that apply to the complete system. For the complete system in which this individual component is used, for example, the data specified for that complete system applies.

Model number	5AP1130.121E-000
General information	
B&R ID code	0xEB63
Certifications	
CE	Yes
UL	cULus E115267 Industrial control equipment
HazLoc	cULus HazLoc E180196 Industrial control equipment for hazardous locations Class I, Division 2, Groups ABCD, T4 ¹⁾
Display	
Type	Color TFT
Diagonal	12.1"
Colors	16.7 million
Resolution	WXGA, 1280 x 800 pixels
Contrast	900:1
Viewing angles	
Horizontal	Direction R = 80° / Direction L = 80°
Vertical	Direction U = 65° / Direction D = 80°
Backlight	
Type	LED
Brightness (dimnable)	Typ. 40 to 400 cd/m ²
Half-brightness time ²⁾	50,000 h
Touch screen ³⁾	
Type	3M
Technology	Projected capacitive touch (PCT)
Controller	3M
Transmittance	See appendix A "Touch screen".
Operating conditions	
Pollution degree per EN 61131-2	Pollution degree 2
Degree of protection per EN 60529	Front: IP65 Back: IP20 (only with installed link module or installed system unit)
Protection per UL 50	Front: Type 4X indoor use only

Table 70: 5AP1130.121E-000 - Technical data

Model number	5AP1130.121E-000
Mechanical characteristics	
Front ⁴⁾	
Frame	Coated aluminum
Design	Black
Gasket	3 mm built-in gasket
Dimensions	
Width	324 mm
Height	221.5 mm
Weight	2400 g

Table 70: 5AP1130.121E-000 - Technical data

- 1) Yes, although applies only if all components installed within the complete system have this certification and the complete system itself carries the corresponding mark.
- 2) At an ambient temperature of 25°C. Reducing the brightness by 50% can result in an approximately 50% increase in the half-brightness time.
- 3) The specifications for the touch screen driver must be taken into consideration. See chapter 4 "Software", section 2 "Multi-touch drivers".
- 4) There may be visible deviations in the color and surface appearance depending on the process or batch.

3.1.13.4 Dimensions

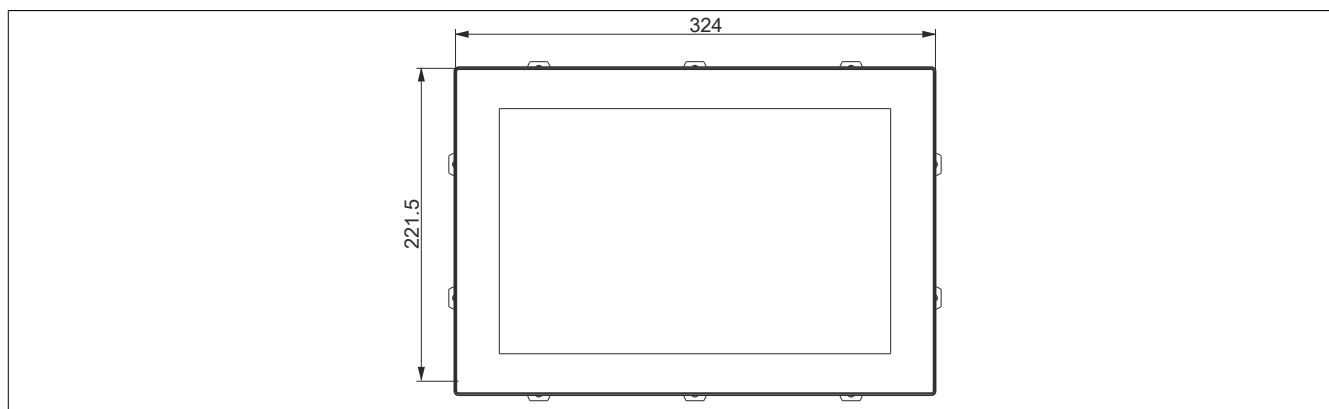

Figure 67: 5AP1130.121E-000 - Dimensions

3.1.13.5 Temperature/Humidity diagram

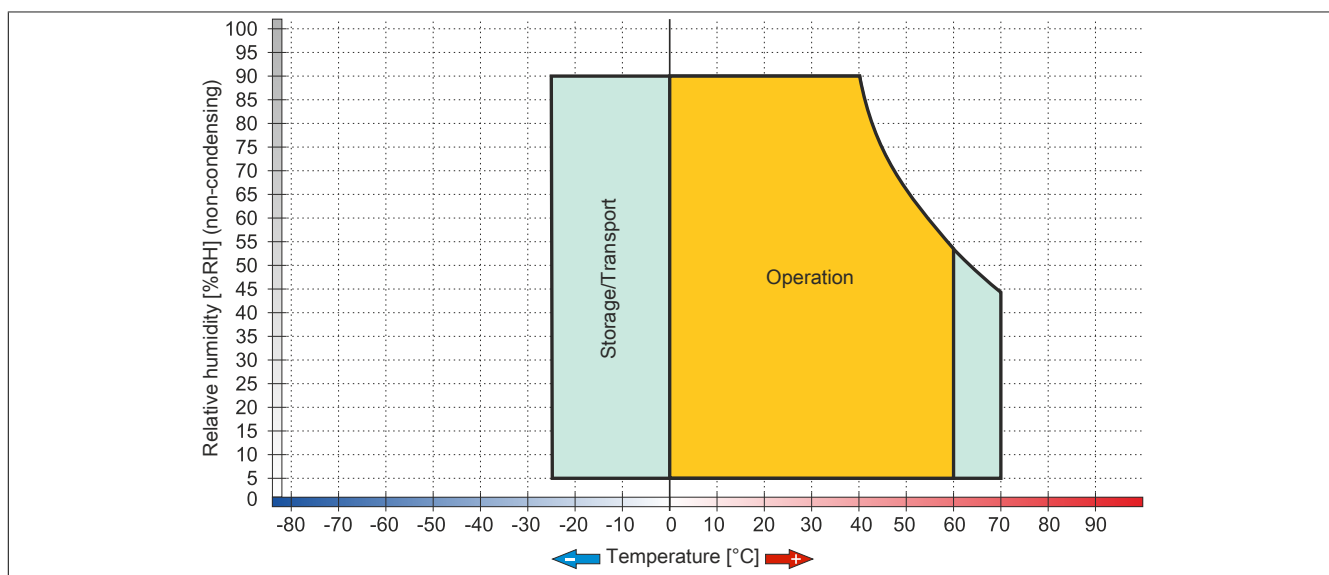

Figure 68: 5AP1130.121E-000 - Temperature/Humidity diagram

3.1.14 5AP1120.1505-000

3.1.14.1 General information

- Panel for AP1000, PPC900, PPC2100 or PPC3100
- 15.0" TFT XGA color display
- Single-touch (analog resistive)
- Front USB interface
- Control cabinet installation

3.1.14.2 Order data

Model number	Short description	Figure
5AP1120.1505-000	Panels Automation Panel 15.0" XGA TFT - 1024 x 768 pixels (4:3) - Single-touch (analog resistive) - Control cabinet installation - Landscape format - Front USB - For PPC900 / PPC2100 / PPC3100 - For link modules - Compatible with 5PP520.1505-00, 5AP920.1505-01, 5PC720.1505-xx, 5PC820.1505-00	

Table 71: 5AP1120.1505-000 - Order data

3.1.14.3 Technical data

Information:

The following specifications, properties and limit values apply only to this individual component and may deviate from those that apply to the complete system. For the complete system in which this individual component is used, for example, the data specified for that complete system applies.

Model number	5AP1120.1505-000
General information	
B&R ID code	0xE7BC
Certifications	
CE	Yes
UL	cULus E115267 Industrial control equipment
HazLoc	cULus HazLoc E180196 Industrial control equipment for hazardous locations Class I, Division 2, Groups ABCD, T4 ¹⁾
Interfaces	
USB	
Quantity	1
Type	USB 2.0
Design	Type A
Transfer rate	Low speed (1.5 Mbit/s), full speed (12 Mbit/s), high speed (480 Mbit/s)
Current-carrying capacity	Max. 500 mA
Display	
Type	Color TFT
Diagonal	15.0"
Colors	16.7 million
Resolution	XGA, 1024 x 768 pixels
Contrast	700:1
Viewing angles	
Horizontal	Direction R = 80° / Direction L = 80°
Vertical	Direction U = 70° / Direction D = 70°
Backlight	
Type	LED
Brightness (dimnable)	Typ. 20 to 400 cd/m ²
Half-brightness time ²⁾	50,000 h

Table 72: 5AP1120.1505-000 - Technical data

Model number	5AP1120.1505-000
Touch screen ³⁾	
Type	AMT
Technology	Analog, resistive
Controller	B&R, serial, 12-bit
Transmittance	81% ±3%
Operating conditions	
Pollution degree per EN 61131-2	Pollution degree 2
Degree of protection per EN 60529	Front: IP65 Back: IP20 (only with installed link module or installed system unit)
Protection per UL 50	Front: Type 4X indoor use only
Mechanical characteristics	
Front ⁴⁾	
Frame	Naturally anodized aluminum
Keypad overlay	
Material	Polyester
Light background	RAL 9006
Dark gray border around display	RAL 7024
Gasket	3 mm built-in seal
Dimensions	
Width	435 mm
Height	330 mm
Weight	5000 g

Table 72: 5AP1120.1505-000 - Technical data

- 1) Yes, although applies only if all components installed within the complete system have this certification and the complete system itself carries the corresponding mark.
- 2) At an ambient temperature of 25°C. Reducing the brightness by 50% can result in an approximately 50% increase in the half-brightness time.
- 3) Touch screen drivers for approved operating systems are available in the Downloads section of the B&R website.
- 4) There may be visible deviations in the color and surface appearance depending on the process or batch.

3.1.14.4 Dimensions

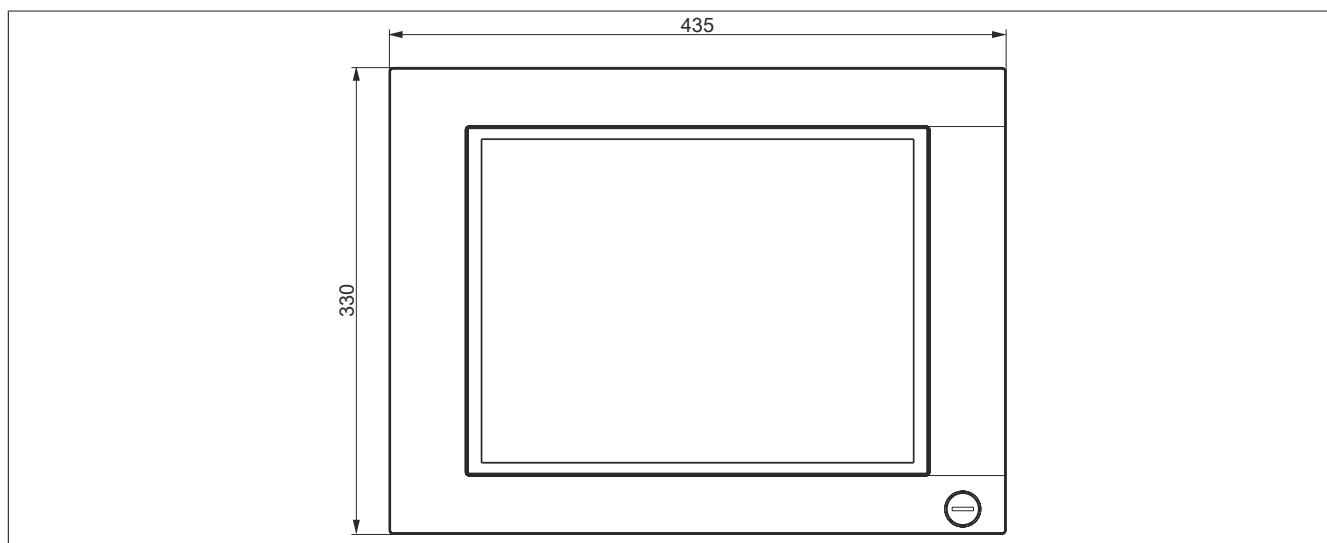

Figure 69: 5AP1120.1505-000 - Dimensions

3.1.14.5 Temperature/Humidity diagram

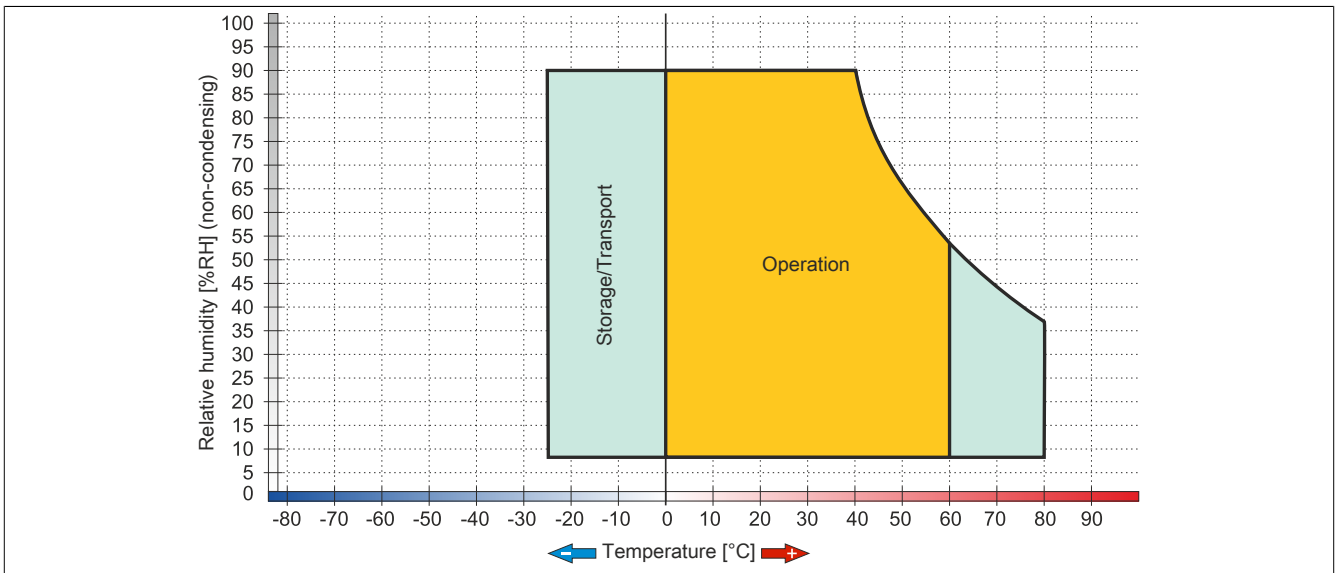

Figure 70: 5AP1120.1505-000 - Temperature/Humidity diagram

3.1.15 5AP1180.1505-000

3.1.15.1 General information

- Panel for AP1000, PPC900, PPC2100 or PPC3100
- 15.0" TFT XGA color display
- Single-touch (analog resistive)
- 32 function keys
- Front USB interface
- Control cabinet installation

3.1.15.2 Order data

Model number	Short description	Figure
	Panels	
5AP1180.1505-000	Automation Panel 15.0" XGA TFT - 1024 x 768 pixels (4:3) - Single-touch (analog resistive) - Control cabinet installation - Landscape format - Front USB - For PPC900/PPC2100/ PPC3100 - For link modules - Compatible with 5PP580.1505-00, 5AP980.1505-01	

Table 73: 5AP1180.1505-000 - Order data

3.1.15.3 Technical data

Information:

The following specifications, properties and limit values apply only to this individual component and may deviate from those that apply to the complete system. For the complete system in which this individual component is used, for example, the data specified for that complete system applies.

Model number	5AP1180.1505-000
General information	
B&R ID code	0xE7BD
Certifications	
CE	Yes
UL	cULus E115267 Industrial control equipment
HazLoc	cULus HazLoc E180196 Industrial control equipment for hazardous locations Class I, Division 2, Groups ABCD, T4 ¹⁾
Interfaces	
USB	
Quantity	1
Type	USB 2.0
Design	Type A
Transfer rate	Low speed (1.5 Mbit/s), full speed (12 Mbit/s), high speed (480 Mbit/s)
Current-carrying capacity	Max. 500 mA
Display	
Type	Color TFT
Diagonal	15.0"
Colors	16.7 million
Resolution	XGA, 1024 x 768 pixels
Contrast	700:1
Viewing angles	
Horizontal	Direction R = 80° / Direction L = 80°
Vertical	Direction U = 70° / Direction D = 70°
Backlight	
Type	LED
Brightness (dimnable)	Typ. 20 to 400 cd/m ²
Half-brightness time ²⁾	50,000 h

Table 74: 5AP1180.1505-000 - Technical data

Model number	5AP1180.1505-000
Touch screen ³⁾	
Type	AMT
Technology	Analog, resistive
Controller	B&R, serial, 12-bit
Transmittance	81% ±3%
Keys	
Function keys	32 with LED (yellow)
System keys	No
Service life	>1,000,000 actuations at 1 ±0.3 N to 3 ±0.3 N actuating force
LED brightness	
Yellow	Typ. 38 mcd
Operating conditions	
Pollution degree per EN 61131-2	Pollution degree 2
Degree of protection per EN 60529	Front: IP65 Back: IP20 (only with installed link module or installed system unit)
Protection per UL 50	Front: Type 4X indoor use only
Mechanical characteristics	
Front ⁴⁾	
Frame	Naturally anodized aluminum
Keypad overlay	
Material	Polyester
Light background	RAL 9006
Dark gray border around display	RAL 7024
Gasket	3 mm built-in gasket
Dimensions	
Width	435 mm
Height	330 mm
Weight	4900 g

Table 74: 5AP1180.1505-000 - Technical data

- 1) Yes, although applies only if all components installed within the complete system have this certification and the complete system itself carries the corresponding mark.
- 2) At an ambient temperature of 25°C. Reducing the brightness by 50% can result in an approximately 50% increase in the half-brightness time.
- 3) Touch screen drivers for approved operating systems are available in the Downloads section of the B&R website.
- 4) There may be visible deviations in the color and surface appearance depending on the process or batch.

3.1.15.4 Dimensions

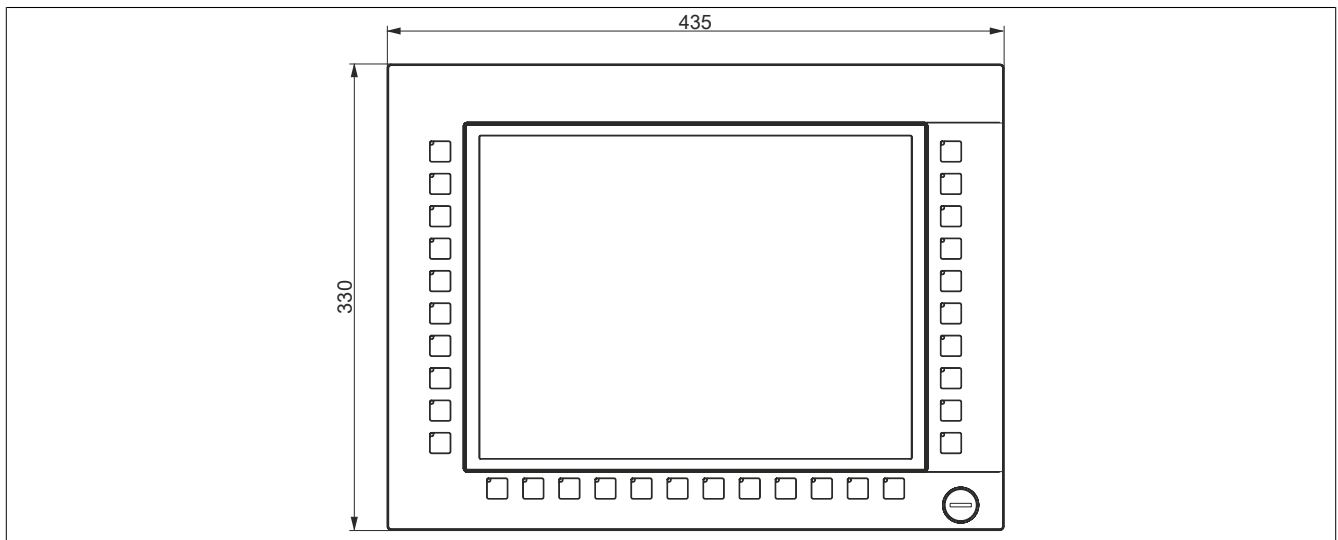

Figure 71: 5AP1180.1505-000 - Dimensions

3.1.15.5 Temperature/Humidity diagram

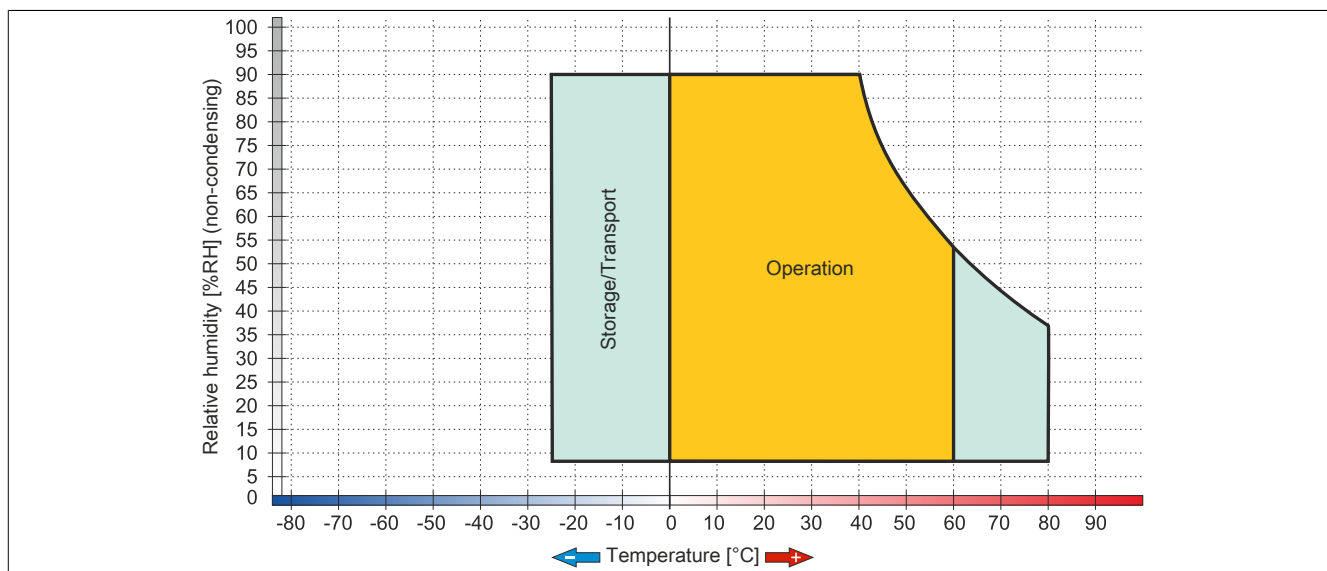

Figure 72: 5AP1180.1505-000 - Temperature/Humidity diagram

3.1.16 5AP1181.1505-000

3.1.16.1 General information

- Panel for AP1000, PPC900, PPC2100 or PPC3100
- 15.0" TFT XGA color display
- Single-touch (analog resistive)
- 32 function keys
- 92 system keys
- Front USB interface
- Control cabinet installation

Information:

This Automation Panel is not enabled for DVI mode.

3.1.16.2 Order data

Model number	Short description	Figure
5AP1181.1505-000	Panels Automation Panel 15" XGA TFT - 1024 x 768 pixels (4:3) - Single-touch (analog resistive) - Control cabinet installation - Landscape format - Front USB interface - 32 function keys and 92 system keys - For PPC900 / PPC2100 / PPC3100 / link modules - Compatible with 5PP581.1505-000	

Table 75: 5AP1181.1505-000 - Order data

3.1.16.3 Technical data

Information:

The following specifications, properties and limit values apply only to this individual component and may deviate from those that apply to the complete system. For the complete system in which this individual component is used, for example, the data specified for that complete system applies.

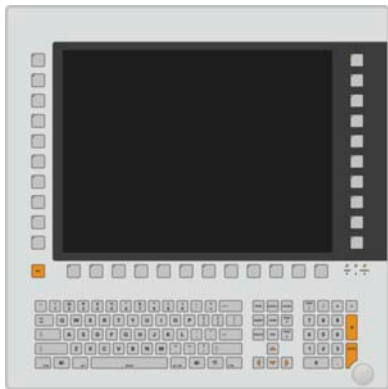
Model number	5AP1181.1505-000
General information	
B&R ID code	0xEF61
Certifications	
UL	cULus E115267 Industrial control equipment
HazLoc	cULus HazLoc E180196 Industrial control equipment for hazardous locations Class I, Division 2, Groups ABCD, T4 ¹⁾
Interfaces	
USB	
Quantity	1
Type	USB 2.0
Design	Type A
Transfer rate	Low speed (1.5 Mbit/s), full speed (12 Mbit/s), high speed (480 Mbit/s)
Current-carrying capacity	Max. 500 mA
Display	
Type	TFT color
Diagonal	15.0"
Colors	16.7 million
Resolution	XGA, 1024 x 768 pixels
Contrast	700:1

Table 76: 5AP1181.1505-000 - Technical data

Model number	5AP1181.1505-000
Viewing angles	
Horizontal	Direction R = 80° / Direction L = 80°
Vertical	Direction U = 70° / Direction D = 70°
Backlight	
Type	LED
Brightness (dimnable)	Typ. 20 to 400 cd/m ²
Half-brightness time ²⁾	50,000 h
Touch screen ³⁾	
Type	AMT
Technology	Analog, resistive
Controller	B&R, serial, 12-bit
Transmittance	81% ±3%
Keys	
Function keys	32 with LED (yellow)
System keys	Alphanumeric keys, numeric keys, cursor block
Service life	>1,000,000 actuations at 1 ±0.3 N to 3 ±0.3 N actuating force
LED brightness	
Yellow	Typ. 38 mcd
Operating conditions	
Pollution degree per EN 61131-2	Pollution degree 2
Degree of protection per EN 60529	Front: IP65 Back: IP20 (only with installed link module or installed system unit)
Protection per UL 50	Front: Type 4X indoor use only
Mechanical characteristics	
Front ⁴⁾	
Frame	Aluminum, naturally anodized
Keypad overlay	
Material	Polyester
Light background	RAL 9006
Dark gray border around display	RAL 7024
Gasket	3 mm built-in gasket
Dimensions	
Width	435 mm
Height	430 mm
Weight	6000 g

Table 76: 5AP1181.1505-000 - Technical data

- 1) Yes, although applies only if all components installed in the complete system have this certification and the complete system bears the corresponding mark.
- 2) At an ambient temperature of 25°C. Reducing the brightness by 50% can increase the half-brightness time by approximately 50%.
- 3) Touch screen drivers for approved operating systems are available for download in the Downloads section of the B&R website (www.br-automation.com).
- 4) There may be visible deviations in the color and surface appearance depending on the process or batch.

3.1.16.4 Dimensions

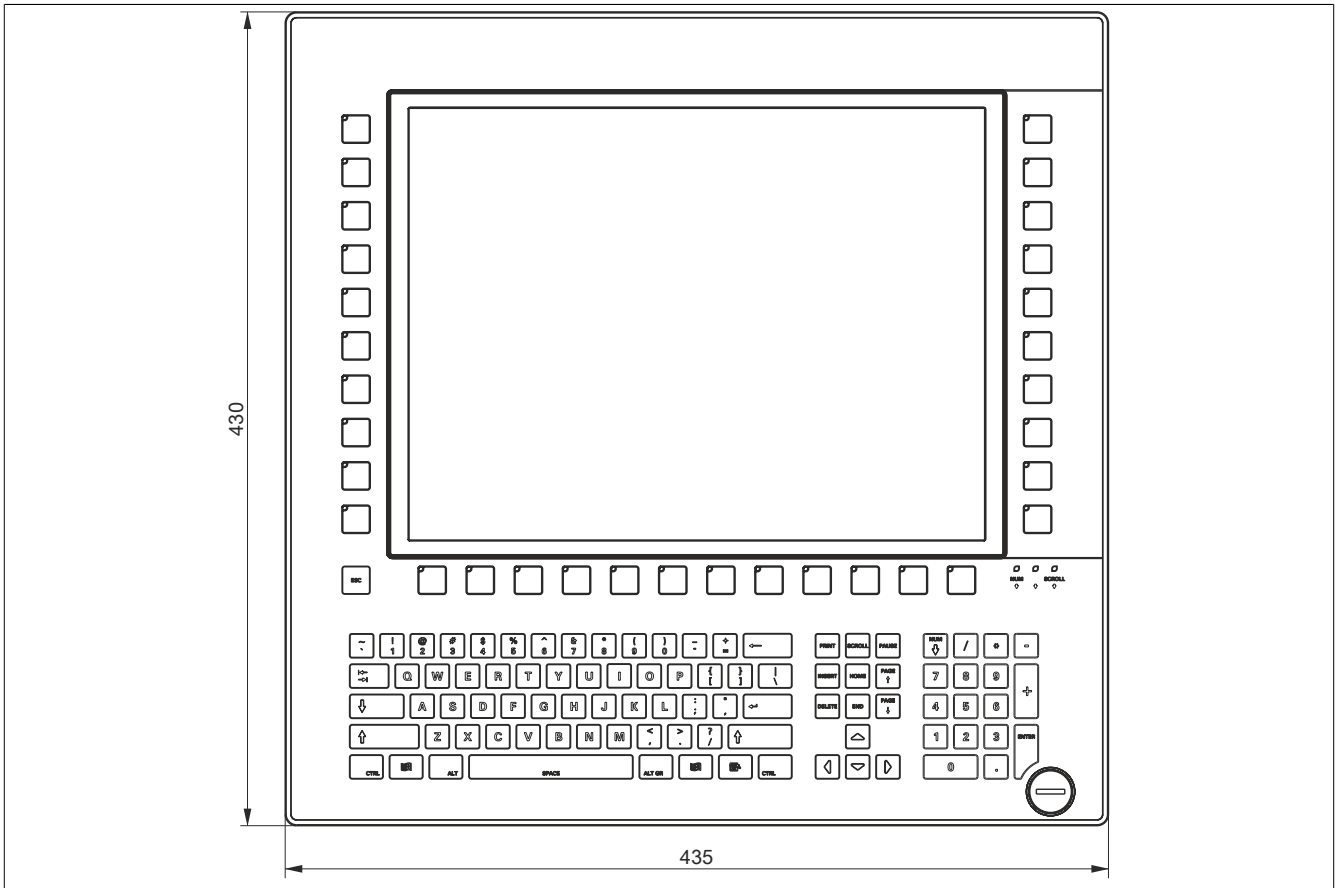

Figure 73: 5AP1181.1505-000 - Dimensions

3.1.16.5 Requirements

5AP1181.1505-000 is supported starting with the following firmware versions:

- Firmware V03.15 or later for SDL/DVI receiver 5DLSDL.1001-00
- Firmware V04.11 or later for SDL3 receiver 5DLSD3.1001-00
- Firmware V06.12 or later for SDL4 receiver 5DLSD4.1001-00

3.1.16.6 Temperature/Humidity diagram

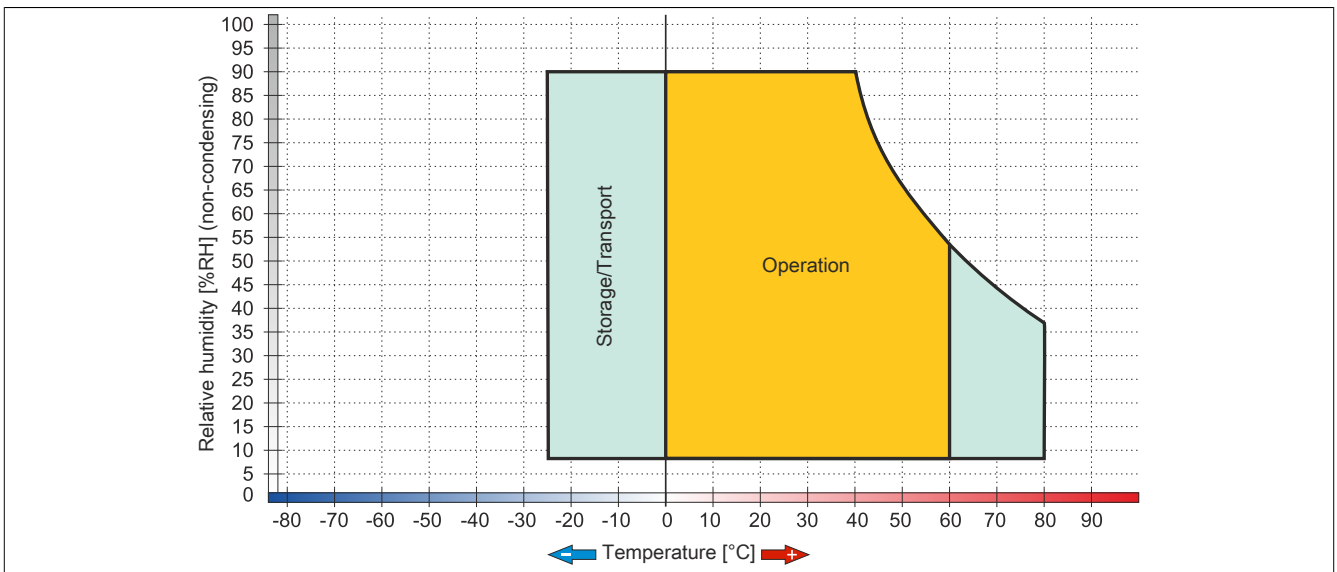

Figure 74: 5AP1181.1505-000 - Temperature/Humidity diagram

3.1.16.7 Cutout installation

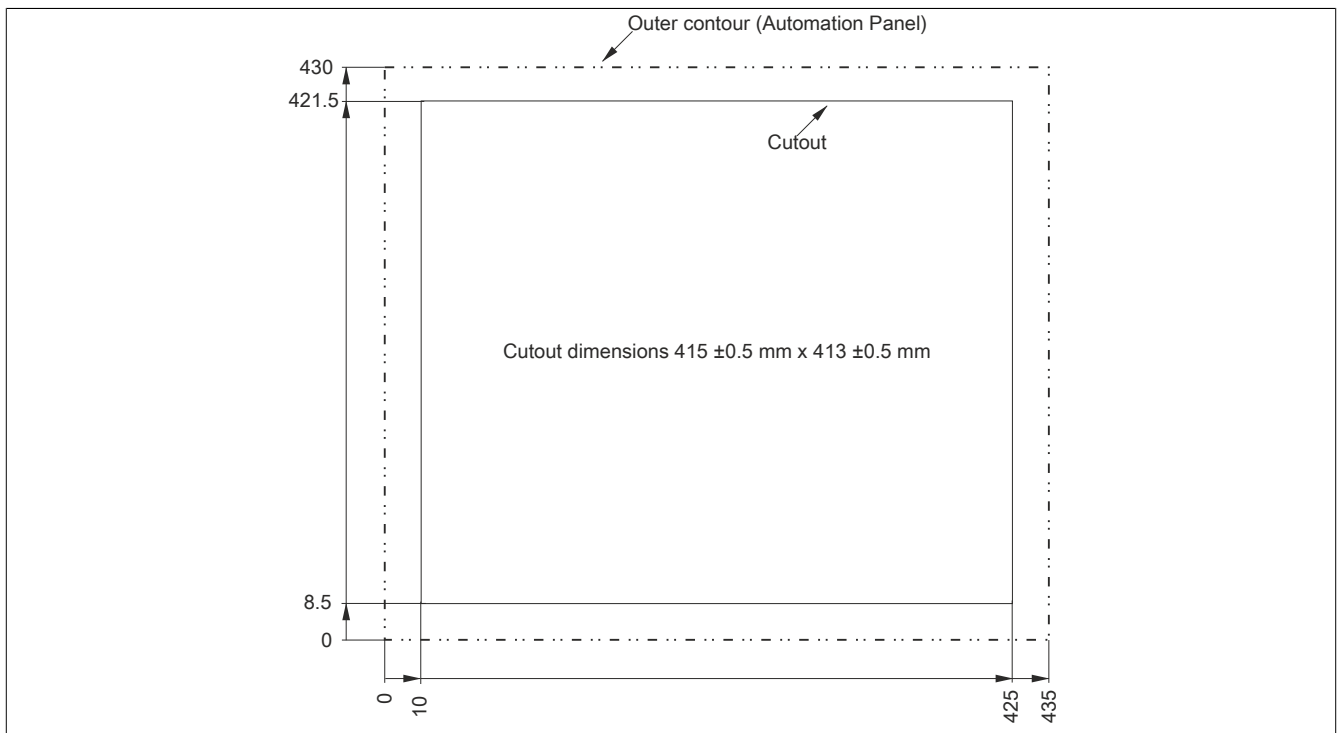

Figure 75: 5AP1181.1505-000 - Cutout installation

3.1.17 5AP1120.156B-000

3.1.17.1 General information

- Panel for AP1000, PPC900, PPC2100 or PPC3100
- 15.6" TFT HD color display
- Single-touch (analog resistive)
- Control cabinet installation

3.1.17.2 Order data

Model number	Short description	Figure
5AP1120.156B-000	Automation Panel 15.6" HD TFT - 1366 x 768 pixels (16:9) - Single-touch (analog resistive) - Control cabinet installation - Landscape format - For PPC900 / PPC2100 / PPC3100 / link modules	

Table 77: 5AP1120.156B-000 - Order data

3.1.17.3 Technical data

Information:

The following specifications, properties and limit values apply only to this individual component and may deviate from those that apply to the complete system. For the complete system in which this individual component is used, for example, the data specified for that complete system applies.

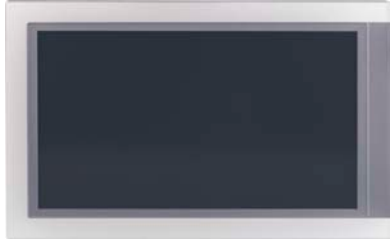
Model number	5AP1120.156B-000
General information	
B&R ID code	0xE8E5
Certifications	
CE	Yes
UL	cULus E115267 Industrial control equipment
HazLoc	cULus HazLoc E180196 Industrial control equipment for hazardous locations Class I, Division 2, Groups ABCD, T4 ¹⁾
Display	
Type	Color TFT
Diagonal	15.6"
Colors	16.7 million
Resolution	HD, 1366 x 768 pixels
Contrast	1000:1
Viewing angles	
Horizontal	Direction R = 85° / Direction L = 85°
Vertical	Direction U = 85° / Direction D = 85°
Backlight	
Type	LED
Brightness (dimnable)	Typ. 40 to 400 cd/m ²
Half-brightness time ²⁾	70,000 h
Touch screen ³⁾	
Type	AMT
Technology	Analog, resistive
Controller	B&R, serial, 12-bit
Transmittance	81% ±3%
Operating conditions	
Pollution degree per EN 61131-2	Pollution degree 2
Degree of protection per EN 60529	Front: IP65 Back: IP20 (only with installed link module or installed system unit)
Protection per UL 50	Front: Type 4X indoor use only

Table 78: 5AP1120.156B-000 - Technical data

Model number	5AP1120.156B-000
Mechanical characteristics	
Front ⁴⁾	
Frame	Coated aluminum
Keypad overlay	
Material	Polyester
Light background	RAL 9006
Dark gray border around display	RAL 7024
Gasket	3 mm built-in gasket
Dimensions	
Width	414 mm
Height	258.5 mm
Weight	4200 g

Table 78: 5AP1120.156B-000 - Technical data

- 1) Yes, although applies only if all components installed within the complete system have this certification and the complete system itself carries the corresponding mark.
- 2) At an ambient temperature of 25°C. Reducing the brightness by 50% can result in an approximately 50% increase in the half-brightness time.
- 3) Touch screen drivers for approved operating systems are available in the Downloads section of the B&R website.
- 4) There may be visible deviations in the color and surface appearance depending on the process or batch.

3.1.17.4 Dimensions

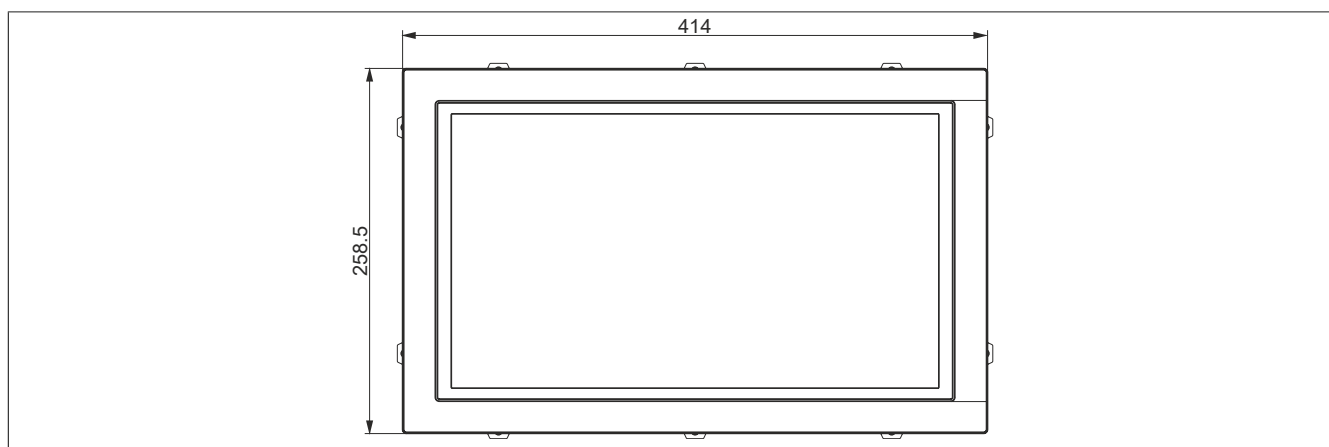

Figure 76: 5AP1120.156B-000 - Dimensions

3.1.17.5 Temperature/Humidity diagram

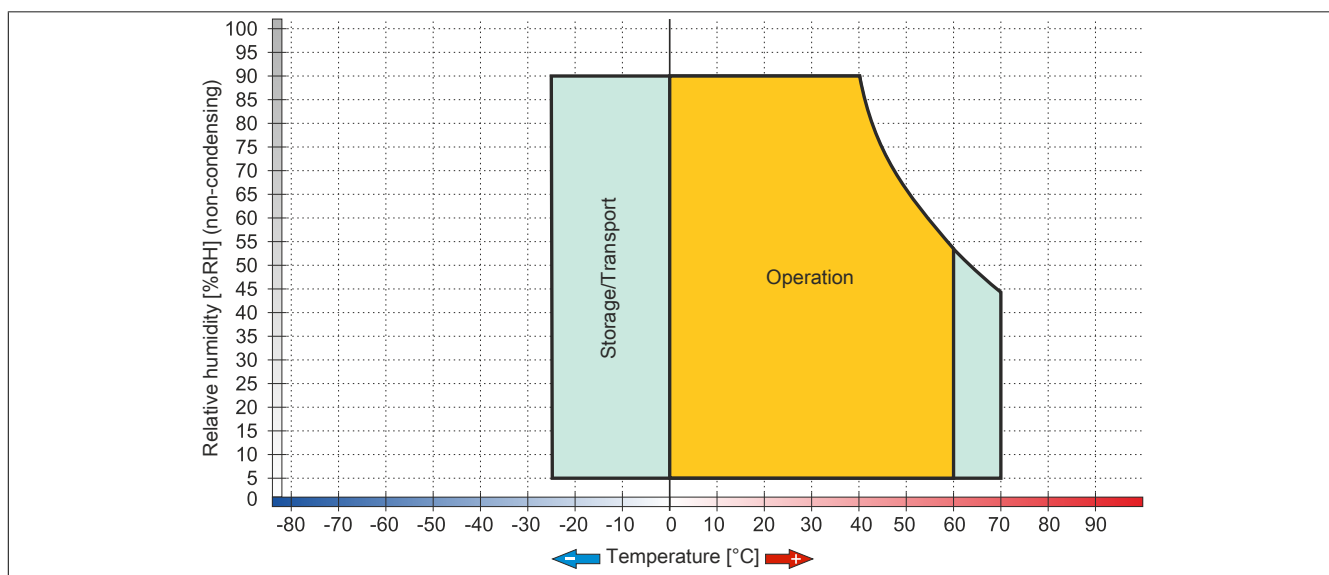

Figure 77: 5AP1120.156B-000 - Temperature/Humidity diagram

3.1.18 5AP1130.156C-000

3.1.18.1 General information

- Panel for AP1000, PPC900, PPC2100 or PPC3100
- 15.6" FHD color display
- Multi-touch (projected capacitive)
- Control cabinet installation

3.1.18.2 Order data

Model number	Short description	Figure
5AP1130.156C-000	Panels Automation Panel 15.6" Full HD TFT - 1920 x 1080 pixels (16:9) - Multi-touch (projected capacitive) - Control cabinet installation - Landscape format - For PPC900 / PPC2100 / PPC3100 / link modules	

Table 79: 5AP1130.156C-000 - Order data

3.1.18.3 Technical data

Information:

The following specifications, properties and limit values apply only to this individual component and may deviate from those that apply to the complete system. For the complete system in which this individual component is used, for example, the data specified for that complete system applies.

Model number	5AP1130.156C-000
General information	
B&R ID code	0xEC5D
Certifications	
CE	Yes
UL	cULus E115267 Industrial control equipment
HazLoc	cULus HazLoc E180196 Industrial control equipment for hazardous locations Class I, Division 2, Groups ABCD, T4 ¹⁾
DNV GL	Temperature: B (0 - 55°C) Humidity: B (up to 100%) Vibration: A (0.7 g) EMC: B (Bridge and open deck) ²⁾
Display	
Type	TFT color
Diagonal	15.6"
Colors	16.7 million
Resolution	FHD, 1920 x 1080 pixels
Contrast	1500:1
Viewing angles	
Horizontal	Direction R = 85° / Direction L = 85°
Vertical	Direction U = 85° / Direction D = 85°
Backlight	
Type	LED
Brightness (dimnable)	Typ. 40 to 400 cd/m ²
Half-brightness time ³⁾	70,000 h
Touch screen ⁴⁾	
Type	3M
Technology	Projected capacitive touch (PCT)
Controller	3M
Transmittance	See section "Touch screen" in appendix A.

Table 80: 5AP1130.156C-000 - Technical data

Model number	5AP1130.156C-000
Operating conditions	
Pollution degree per EN 61131-2	Pollution degree 2
Degree of protection per EN 60529	Front: IP65 Back: IP20 (only with installed link module or installed system unit)
Protection per UL 50	Front: Type 4X indoor use only
Mechanical characteristics	
Front ⁵⁾	
Frame	Aluminum, coated
Design	Black
Gasket	3 mm built-in gasket
Dimensions	
Width	414 mm
Height	258.5 mm
Weight	3700 g

Table 80: 5AP1130.156C-000 - Technical data

- 1) Yes, although applies only if all components installed in the complete system have this certification and the complete system bears the corresponding mark.
- 2) Yes, although applies only if all components installed in the complete system have this certification and are listed on the associated DNV GL certificate for the product family.
- 3) At an ambient temperature of 25°C. Reducing the brightness by 50% can increase the half-brightness time by approximately 50%.
- 4) The values for the touch screen driver must be taken into account. See chapter 4 "Software", section 2 "Multi-touch drivers".
- 5) There may be visible deviations in the color and surface appearance depending on the process or batch.

3.1.18.4 Dimensions

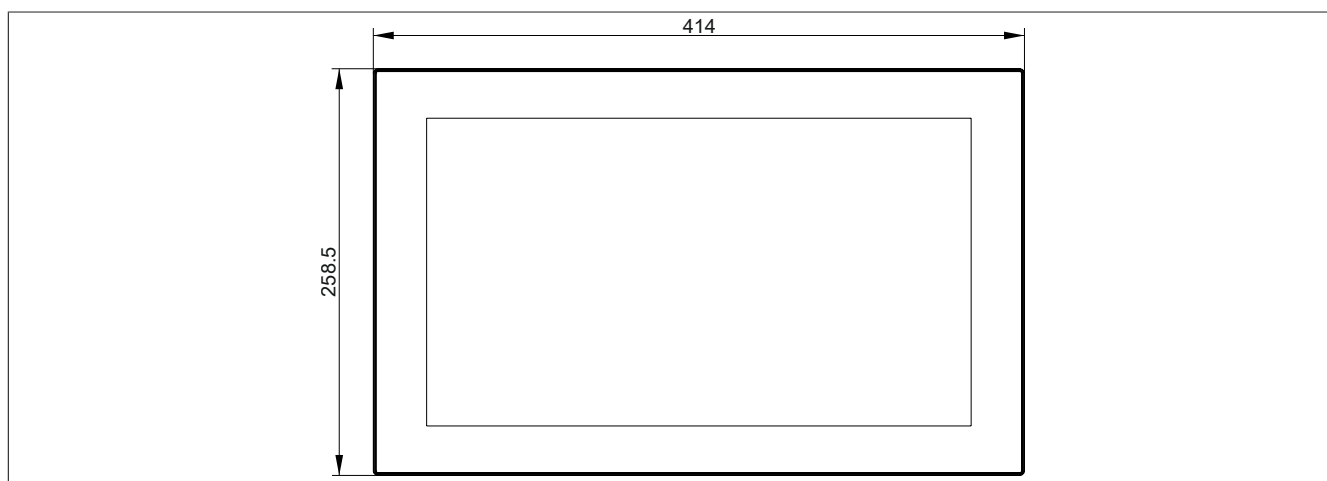

Figure 78: 5AP1130.156C-000 - Dimensions

3.1.18.5 Temperature/Humidity diagram

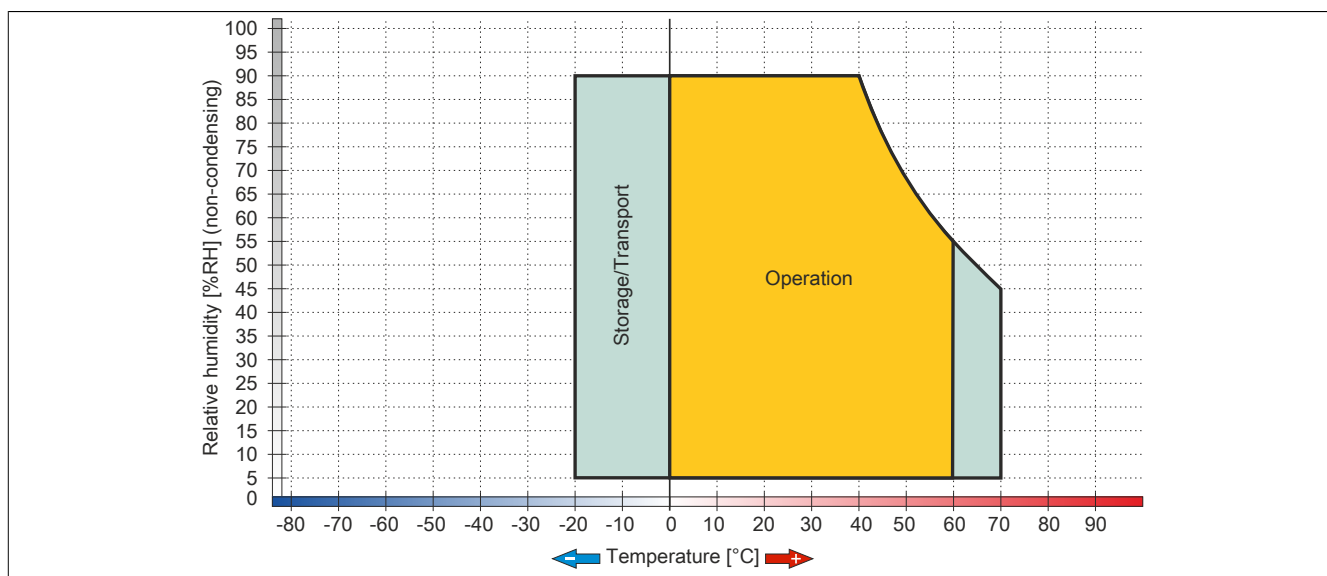

Figure 79: 5AP1130.156C-000 - Temperature/Humidity diagram

3.1.19 5AP1130.185C-000

3.1.19.1 General information

- Panel for AP1000, PPC900, PPC2100 or PPC3100
- 18.5" FHD color display
- Multi-touch (projected capacitive)
- Control cabinet installation

3.1.19.2 Order data

Model number	Short description	Figure
5AP1130.185C-000	Panels Automation Panel 18.5" Full HD TFT - 1920 x 1080 pixels (16:9) - Multi-touch (projected capacitive) - Control cabinet installation - Landscape format - For PPC900 / PPC2100 / PPC3100 / link modules	

Table 81: 5AP1130.185C-000 - Order data

3.1.19.3 Technical data

Information:

The following specifications, properties and limit values apply only to this individual component and may deviate from those that apply to the complete system. For the complete system in which this individual component is used, for example, the data specified for that complete system applies.

Model number	5AP1130.185C-000
General information	
B&R ID code	0xEC5E
Certifications	
CE	Yes
UL	cULus E115267 Industrial control equipment
HazLoc	cULus HazLoc E180196 Industrial control equipment for hazardous locations Class I, Division 2, Groups ABCD, T4 ¹⁾
Display	
Type	TFT color
Diagonal	18.5"
Colors	16.7 million
Resolution	FHD, 1920 x 1080 pixels
Contrast	1500:1
Viewing angles	
Horizontal	Direction R = 85° / Direction L = 85°
Vertical	Direction U = 85° / Direction D = 85°
Backlight	
Type	LED
Brightness (dimnable)	Typ. 40 to 400 cd/m ²
Half-brightness time ²⁾	50,000 h
Touch screen ³⁾	
Type	3M
Technology	Projected capacitive touch (PCT)
Controller	3M
Transmittance	See section "Touch screen" in appendix A.
Operating conditions	
Pollution degree per EN 61131-2	Pollution degree 2
Degree of protection per EN 60529	Front: IP65 Back: IP20 (only with installed link module or installed system unit)
Protection per UL 50	Front: Type 4X indoor use only

Table 82: 5AP1130.185C-000 - Technical data

Model number	5AP1130.185C-000
Mechanical characteristics	
Front ⁴⁾	
Frame	Aluminum, coated
Design	Black
Gasket	3 mm built-in gasket
Dimensions	
Width	475 mm
Height	295 mm
Weight	4700 g

Table 82: 5AP1130.185C-000 - Technical data

- 1) Yes, although applies only if all components installed in the complete system have this certification and the complete system bears the corresponding mark.
- 2) At an ambient temperature of 25°C. Reducing the brightness by 50% can increase the half-brightness time by approximately 50%.
- 3) The values for the touch screen driver must be taken into account. See chapter 4 "Software", section 2 "Multi-touch drivers".
- 4) There may be visible deviations in the color and surface appearance depending on the process or batch.

3.1.19.4 Dimensions

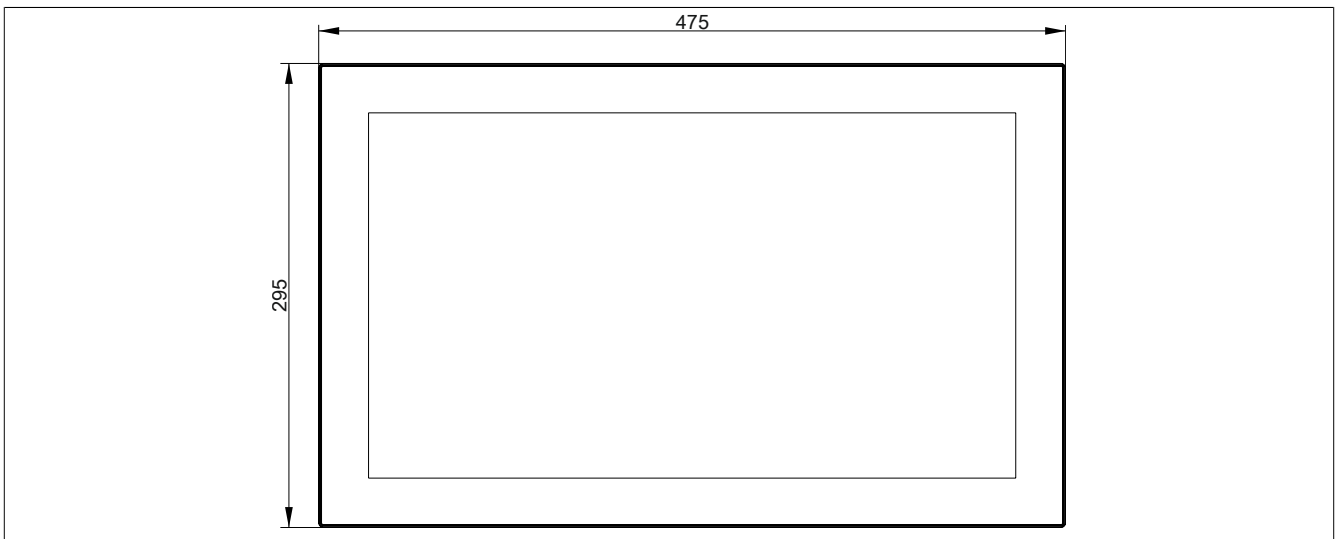

Figure 80: 5AP1130.185C-000 - Dimensions

3.1.19.5 Temperature/Humidity diagram

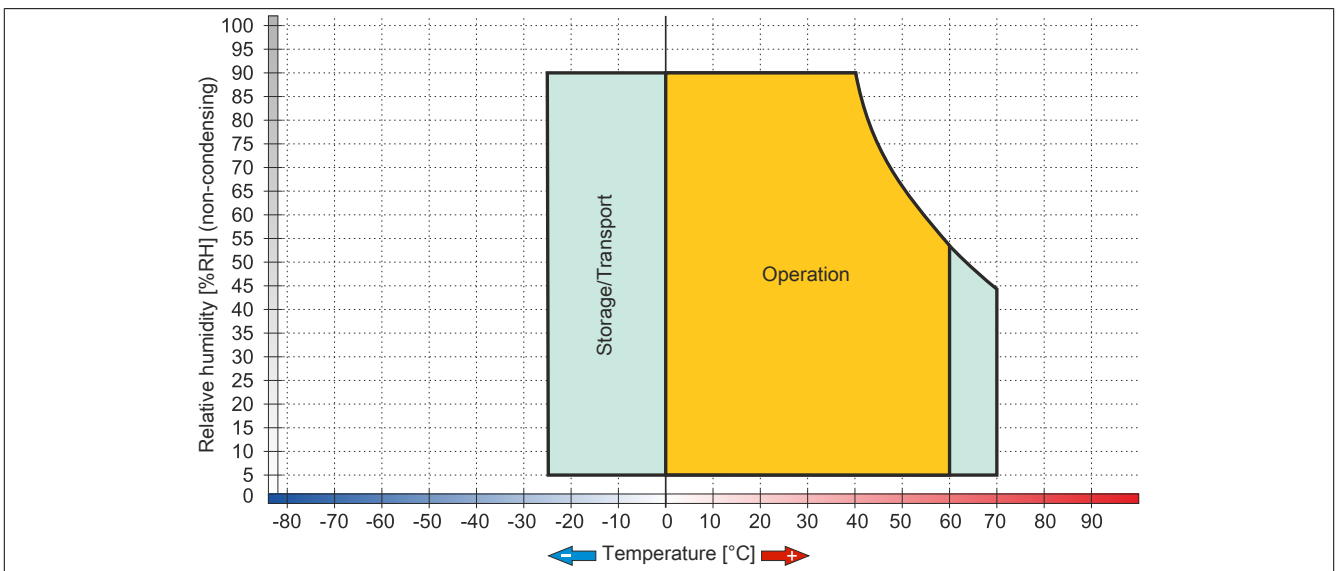

Figure 81: 5AP1130.185C-000 - Temperature/Humidity diagram

3.1.20 5AP1120.1906-000

3.1.20.1 General information

- Panel for AP1000, PPC900, PPC2100 or PPC3100
- 19.0" TFT SXGA color display
- Single-touch (analog resistive)
- Front USB interface
- Control cabinet installation

3.1.20.2 Order data

Model number	Short description	Figure
5AP1120.1906-000	Panels Automation Panel 19.0" SXGA TFT - 1280 x 1024 pixels (5:4) - Single-touch (analog resistive) - Control cabinet installation - Landscape format - Front USB - For PPC900 / PPC2100 / PPC3100 / link modules - Compatible with 5AP920.1906-01, 5PC720.1906-00, 5PC820.1906-00	

Table 83: 5AP1120.1906-000 - Order data

3.1.20.3 Technical data

Information:

The following specifications, properties and limit values apply only to this individual component and may deviate from those that apply to the complete system. For the complete system in which this individual component is used, for example, the data specified for that complete system applies.

Model number	5AP1120.1906-000
General information	
B&R ID code	0xE7BE
Certifications	
CE	Yes
UL	cULus E115267 Industrial control equipment
HazLoc	cULus HazLoc E180196 Industrial control equipment for hazardous locations Class I, Division 2, Groups ABCD, T4 ¹⁾
DNV GL	Temperature: B (0 - 55°C) Humidity: B (up to 100%) Vibration: A (0.7 g) EMC: B (Bridge and open deck) ²⁾
Interfaces	
USB	
Quantity	1
Type	USB 2.0
Design	Type A
Transfer rate	Low speed (1.5 Mbit/s), full speed (12 Mbit/s), high speed (480 Mbit/s)
Current-carrying capacity	Max. 500 mA
Display	
Type	TFT color
Diagonal	19.0"
Colors	16.2 million
Resolution	SXGA, 1280 x 1024 pixels
Contrast	1500:1
Viewing angles	
Horizontal	Direction R = 85° / Direction L = 85°
Vertical	Direction U = 85° / Direction D = 85°

Table 84: 5AP1120.1906-000 - Technical data

Model number	5AP1120.1906-000
Backlight	
Type	LED
Brightness (dimnable)	Typ. 35 to 350 cd/m ²
Half-brightness time ³⁾	70,000 h
Touch screen ⁴⁾	
Type	AMT
Technology	Analog, resistive
Controller	B&R, serial, 12-bit
Transmittance	81% ±3%
Operating conditions	
Pollution degree per EN 61131-2	Pollution degree 2
Degree of protection per EN 60529	Front: IP65 Back: IP20 (only with installed link module or installed system unit)
Protection per UL 50	Front: Type 4X indoor use only
Mechanical characteristics	
Front ⁵⁾	
Frame	Aluminum, naturally anodized
Keypad overlay	
Material	Polyester
Light background	RAL 9006
Dark gray border around display	RAL 7024
Gasket	3 mm built-in gasket
Dimensions	
Width	527 mm
Height	421 mm
Weight	7300 g

Table 84: 5AP1120.1906-000 - Technical data

- 1) Yes, although applies only if all components installed in the complete system have this certification and the complete system bears the corresponding mark.
- 2) Yes, although applies only if all components installed in the complete system have this certification and are listed on the associated DNV GL certificate for the product family.
- 3) At an ambient temperature of 25°C. Reducing the brightness by 50% can increase the half-brightness time by approximately 50%.
- 4) Touch screen drivers for approved operating systems are available for download in the Downloads section of the B&R website (www.br-automation.com).
- 5) There may be visible deviations in the color and surface appearance depending on the process or batch.

3.1.20.4 Dimensions

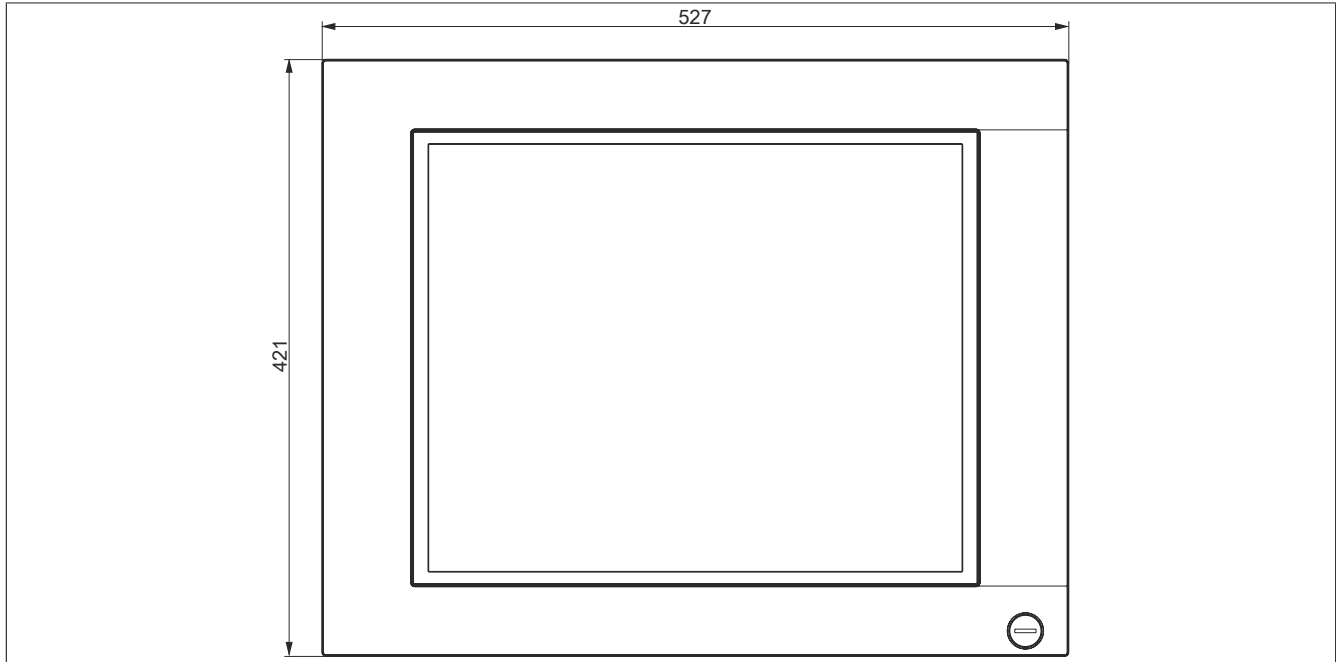

Figure 82: 5AP1120.1906-000 - Dimensions

3.1.20.5 Temperature/Humidity diagram

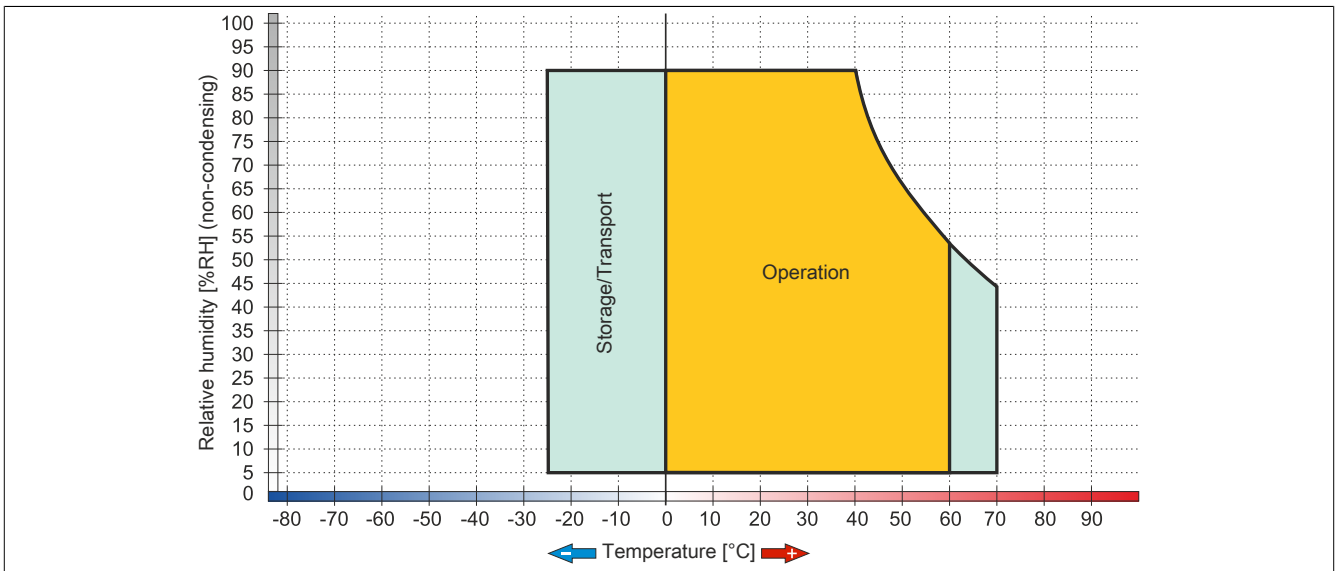

Figure 83: 5AP1120.1906-000 - Temperature/Humidity diagram

3.2 Link modules

3.2.1 5DLSDL.1001-00

3.2.1.1 General information

- Link module for Automation Panel 9x3/1000/5000
- 1x SDL/DVI Panel In interface
- 2x USB 2.0 type A
- 1x USB In (USB type B)
- 1x RS232 interface
- Display brightness buttons

3.2.1.2 Order data

Model number	Short description	Figure
	Link modules	
5DLSDL.1001-00	Automation Panel link module - SDL/DVI receiver - For Automation Panel 923/933/1000 - For Automation Panel 5000	
	Required accessories	
	Accessories	
0TB103.9	Connector 24 VDC - 3-pin female - Screw clamp terminal block 3.31 mm ²	
0TB103.91	Connector 24 VDC - 3-pin female - Cage clamp terminal block 3.31 mm ²	

Table 85: 5DLSDL.1001-00 - Order data

3.2.1.3 Technical data

Information:

The following specifications, properties and limit values apply only to this individual component and may deviate from those that apply to the complete system. For the complete system in which this individual component is used, for example, the data specified for that complete system applies.

Model number	5DLSDL.1001-00
General information	
B&R ID code	0xE1A4
Brightness buttons	Yes ¹⁾
Certifications	
CE	Yes
UL	cULus E115267 Industrial control equipment
HazLoc	cULus HazLoc E180196 Industrial control equipment for hazardous locations Class I, Division 2, Groups ABCD, T4 ²⁾
DNV GL	Temperature: B (0 - 55°C) Humidity: B (up to 100%) Vibration: A (0.7 g) EMC: B (Bridge and open deck) ³⁾
GOST-R	Yes
Interfaces	
COM	
Type	RS232, modem supported, not electrically isolated
Design	DSUB, 9-pin, female
UART	16550-compatible, 16-byte FIFO
Max. baud rate	115 kbit/s
USB	
Quantity	3 (2x Type A; 1x Type B)
Type	USB 2.0 ⁴⁾
Design	2x type A 1x type B
Transfer rate	Low speed (1.5 Mbit/s), full speed (12 Mbit/s), high speed (480 Mbit/s)
Current-carrying capacity	Total max. 1 A ⁵⁾
Panel In	
Design	DVI-D
Type	SDL/DVI
Electrical characteristics	
Nominal voltage	24 VDC ±25%, SELV ⁶⁾

Table 86: 5DLSDL.1001-00 - Technical data

Model number	5DLSDL.1001-00
Nominal current	Max. 3 A
Overvoltage category per EN 61131-2	II
Electrical isolation	Yes
Operating conditions	
Pollution degree per EN 61131-2	Pollution degree 2
Mechanical characteristics	
Dimensions	
Width	190 mm
Height	110 mm
Depth	23.6 mm
Weight	538 g

Table 86: 5DLSDL.1001-00 - Technical data

- 1) The brightness controls can be used to configure the brightness of the backlight on the Automation Panel in DVI mode.
- 2) Yes, although applies only if all components installed in the complete system have this certification and the complete system bears the corresponding mark.
- 3) Yes, although applies only if all components installed in the complete system have this certification and are listed on the associated DNV GL certificate for the product family.
- 4) In "SDL mode 1", USB 1.1 transfer rates are the highest possible.
- 5) For the 2 USB type A female connectors.
- 6) EN 60950 requirements must be observed; see section "+24 VDC power supply" of the user's manual.

3.2.2 5DLSD3.1001-00

3.2.2.1 General information

- Link module for Automation Panel 9x3/1000/5000
- 1x SDL3 Panel In interface
- 2x USB 2.0 type A

3.2.2.2 Order data

Model number	Short description	Figure
	Link modules	
5DLSD3.1001-00	Automation Panel link module - SDL3 receiver - For Automation Panel 923/933/1000 - For Automation Panel 5000	
	Required accessories	
	Accessories	
0TB103.9	Connector 24 VDC - 3-pin female - Screw clamp terminal block 3.31 mm ²	
0TB103.91	Connector 24 VDC - 3-pin female - Cage clamp terminal block 3.31 mm ²	
	Optional accessories	
	SDL3/SDL4 cables	
5CASD3.0030-00	SDL3/SDL4 cable - 3 m	
5CASD3.0050-00	SDL3/SDL4 cable - 5 m	
5CASD3.0100-00	SDL3/SDL4 cable - 10 m	
5CASD3.0150-00	SDL3/SDL4 cable - 15 m	
5CASD3.0200-00	SDL3/SDL4 cable - 20 m	
5CASD3.0300-00	SDL3/SDL4 cable - 30 m	
5CASD3.0500-00	SDL3/SDL4 cable - 50 m	
5CASD3.1000-00	SDL3/SDL4 cable - 100 m	

Table 87: 5DLSD3.1001-00 - Order data

3.2.2.3 Technical data

Information:

The following specifications, properties and limit values apply only to this individual component and may deviate from those that apply to the complete system. For the complete system in which this individual component is used, for example, the data specified for that complete system applies.

Model number	5DLSD3.1001-00
General information	
LED status indicators	Status, Link
B&R ID code	0xE3FC
Certifications	
CE	Yes
UL	cULus E115267 Industrial control equipment
HazLoc	cULus HazLoc E180196 Industrial control equipment for hazardous locations Class I, Division 2, Groups ABCD, T4 ¹⁾
Interfaces	
USB	
Quantity	2
Type	USB 2.0
Design	2x type A
Transfer rate	Low speed (1.5 Mbit/s), full speed (12 Mbit/s), high speed (30 Mbit/s)
Current-carrying capacity	Total max. 1 A
SDL3 In	
Design	Shielded RJ45
Type	SDL3
Electrical characteristics	
Nominal voltage	24 VDC ±25%, SELV ²⁾
Nominal current	Max. 3 A
Overvoltage category per EN 61131-2	II
Electrical isolation	Yes
Operating conditions	
Pollution degree per EN 61131-2	Pollution degree 2

Table 88: 5DLSD3.1001-00 - Technical data

Model number	5DLSD3.1001-00
Mechanical characteristics	
Dimensions	
Width	190 mm
Height	110 mm
Depth	23.6 mm
Weight	527 g

Table 88: 5DLSD3.1001-00 - Technical data

- 1) Yes, although applies only if all components installed within the complete system have this certification and the complete system itself carries the corresponding mark.
- 2) EN 60950 requirements must be observed, see section "+24 VDC power supply" in the user's manual.

3.2.3 5DLSD4.1001-00

3.2.3.1 General information

- Link module for Automation Panel 9x3/1000/5000
- 1x SDL4 Panel In interface
- 2x USB 2.0 type A

3.2.3.2 Order data

Model number	Short description	Figure
	Link modules	
5DLSD4.1001-00	Automation Panel link module - SDL4 receiver - For Automation Panel 923/933/1000 - For Automation Panel 5000	
	Required accessories	
	Accessories	
0TB103.9	Connector 24 VDC - 3-pin female - Screw clamp terminal block 3.31 mm ²	
0TB103.91	Connector 24 VDC - 3-pin female - Cage clamp terminal block 3.31 mm ²	
	Optional accessories	
	SDL3/SDL4 cables	
5CASD3.0030-00	SDL3/SDL4 cable - 3 m	
5CASD3.0050-00	SDL3/SDL4 cable - 5 m	
5CASD3.0100-00	SDL3/SDL4 cable - 10 m	
5CASD3.0150-00	SDL3/SDL4 cable - 15 m	
5CASD3.0200-00	SDL3/SDL4 cable - 20 m	
5CASD3.0300-00	SDL3/SDL4 cable - 30 m	
5CASD3.0500-00	SDL3/SDL4 cable - 50 m	
5CASD3.1000-00	SDL3/SDL4 cable - 100 m	

Table 89: 5DLSD4.1001-00 - Order data

3.2.3.3 Technical data

Information:

The following specifications, properties and limit values apply only to this individual component and may deviate from those that apply to the complete system. For the complete system in which this individual component is used, for example, the data specified for that complete system applies.

Model number	5DLSD4.1001-00
General information	
LED status indicators	Status, Link
B&R ID code	0xECE3
Certifications	
CE	Yes
Interfaces	
USB	
Quantity	2
Type	USB 2.0
Design	2x type A
Transfer rate	Low speed (1.5 Mbit/s), full speed (12 Mbit/s), high speed (150 Mbit/s)
Current-carrying capacity	Total max. 1 A
SDL4 In	
Design	Shielded RJ45
Type	SDL4
Electrical characteristics	
Nominal voltage	24 VDC ±25%, SELV ¹⁾
Nominal current	Max. 3 A
Overvoltage category per EN 61131-2	II
Electrical isolation	Yes
Operating conditions	
Pollution degree per EN 61131-2	Pollution degree 2
Mechanical characteristics	
Dimensions	
Width	190 mm
Height	110 mm
Depth	23.6 mm
Weight	525 g

Table 90: 5DLSD4.1001-00 - Technical data

1) EN 60950 requirements must be observed; see section "+24 VDC power supply" of the user's manual.

Chapter 3 • Commissioning

1 Installation

Danger!

- All power supplies must be disconnected before removing device covers or components and installing/removing accessories, hardware or cables.
- The power cable must be disconnected from the device and from the power supply.
- All covers, components, accessories, hardware and cables must be installed or connected before the device can be connected to the power supply and switched on.

1.1 Important information concerning installation/commissioning

- Checking the delivery
 - When receiving the delivery, check the packaging for any visible transport damage.
 - Any visible transport damage must be documented and reported immediately, or the damage must be confirmed by the shipping/delivery company.
 - Keep the original packaging in the event that goods must be reshipped.

Information:

If a device is transported or stored without packaging, it is unprotected against all environmental factors such as impacts, vibration, pressure, moisture, etc. Damaged packaging indicates that environmental conditions have already heavily affected and possibly damaged the device.

This can result in malfunctions on the device, machine or manufacturing system.

- Check the packaging contents and any ordered optional accessories for completeness and damage.
- If the packaging contents are incomplete, damaged or do not match your order, inform your local sales office or B&R headquarters immediately.

Danger!

A damaged device is subject to unpredictable properties and states. The unintentional installation or operation of a damaged device must be prevented. The damaged device must be marked as such and removed from the productive environment or sent immediately for repairs.

- The environmental conditions must be observed, see "[Environmental characteristics](#)".

Caution!

Before the device is put into service, it must slowly be acclimated to room temperature! Subjecting it to thermal radiation is not permitted. If transported at low temperatures or if there are large temperature fluctuations, the device is not permitted to be subjected to any type of moisture. Moisture can cause short circuits in the electrical circuits and damages the device.

- You must observe the permissible mounting orientations when installing the device, [Mounting orientations](#).

Caution!

When installed at an angle, the convection of air through the device is reduced, which decreases the maximum permissible ambient temperature for operation. If sufficient external cooling is present when the device is installed at an angle, the limit of the maximum permissible ambient temperature must be checked in each case. Otherwise, the device can become damaged and the certifications and warranty for the device nullified.

- The requirements for device standards and certifications must be observed - see "[Standards and certifications](#)".
- The device is only certified for operation in enclosed rooms.
- The device is not permitted to be subjected to direct sunlight.
- Ventilation holes are not permitted to be covered.
- When installed in a closed housing, enough space must be available for air to circulate sufficiently, see [2.2.3 "Spacing for air circulation"](#).

Information:

Additional space needed to operate or service the device must be taken into account during installation.

- The device must be installed on a flat, clean and burr-free surface. The specified IP ratings of the device are only ensured if the following requirements for the surface / installation cutout / mounting surface are met:
 - Permissible deviation from the evenness on the installation cutout: ≤ 0.5 mm.
 - Permissible surface roughness in the area of the mounting seal: ≤ 120 μm (Rz 120).
 - Material thickness of the installation cutout: Min. 1.5 mm steel sheet
- It is important to ensure that the wall or control cabinet plate can hold four times the total weight of the device. If necessary, the interior of the installation cutout must be reinforced in order to strengthen the installation surface.

Caution!

In the event of insufficient load-carrying capacity of the installation surface, inadequate mounting or improper mounting materials, the device may fall and become damaged.

- The device is not permitted to be positioned next to other heat sources that could cause overheating.
- When connecting cables (DVI, SDL, USB, etc.), the bend radius must be taken into account.
- When connecting built-in or connected peripherals, the instructions in the documentation of the peripheral device must be followed.

Caution!

Built-in or connected peripherals (e.g. a USB drive) are not permitted to bring any voltage into the device. Energy regeneration is generally not permitted and can damage the device.

- The device must be installed in a position that minimizes glare on the screen.
- The device must be installed such that viewing is optimized for the user.

- Loss of seal

Caution!

- The gasket must be inspected before initial installation, subsequent installation as well as at regular intervals appropriate to the requirements of the operating environment.
- Replace the entire device if visible scratches, cracks, collected dirt or excessive wear is detected during inspection.
- Do not unnecessarily stretch the gasket.
- Avoid contact between the gasket and the corners and edges of the frame.
- It is important to ensure that the gasket is completely inserted into the installation notch.
- The housing components must be secured using the specified tightening torque.

Failure to follow these instructions can result in damage to property.

1.2 Mounting an Automation Panel 1000 with retaining clips

The Automation Panel 1000 is mounted in the cutout using retaining clips. The number of retaining clips depends on the panel.

The following Automation Panel 1000 systems are mounted using retaining clips:

- 5AP1120.0573-000
- 5AP1151.0573-000
- 5AP1120.0702-000
- 5AP1130.0702-000
- 5AP1120.101E-000
- 5AP1130.101E-000
- 5AP1120.1043-000
- 5AP1180.1043-000
- 5AP1120.121E-000
- 5AP1130.121E-000
- 5AP1120.156B-000
- 5AP1130.156C-000
- 5AP1130.185C-000

The thickness of the wall or control cabinet plate must be at least 1 mm and is not permitted to exceed 6 to 10 mm (depending on the Panel used).

A 2.5 mm hex socket screwdriver is needed to tighten and loosen the screws on the retaining clips. The maximum tightening torque for the retaining clips is 1 Nm.

Devices must be installed on a flat, clean and burr-free surface; uneven areas can cause damage to the display when the screws are tightened or the intrusion of dust and water.

Procedure

1. Check whether the included mounting screws are screwed into the retaining clips. If not, then the mounting screws must be screwed into the retaining clips with a 2.5 mm hex key screwdriver. The mounting screws only need to be screwed in far enough that they no longer protrude above the retaining clip.

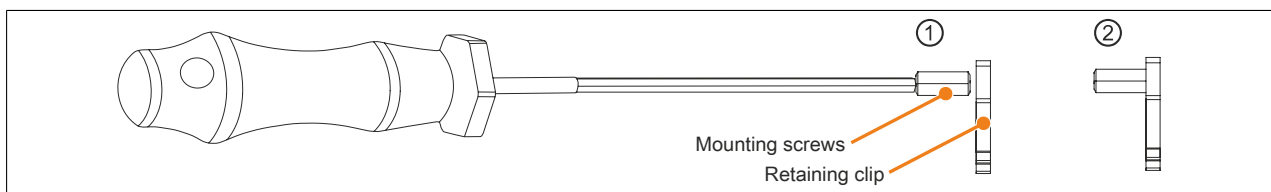

Figure 84: Preparing the retaining clips

2. Insert the device into the front side of the smooth, flat installation cutout. The dimensions for the cutout can be found in [Fig. X "AP1000 panels with retaining clips - Installation diagrams" on page](#) .

3. Install the retaining clips on the device. This is done by inserting the clips into the openings on the sides of the device (indicated by the orange circles). The number of retaining clips may vary depending on the panel. The exact number can be found in [Fig. X "AP1000 panels with retaining clips - Installation diagrams" on page](#)

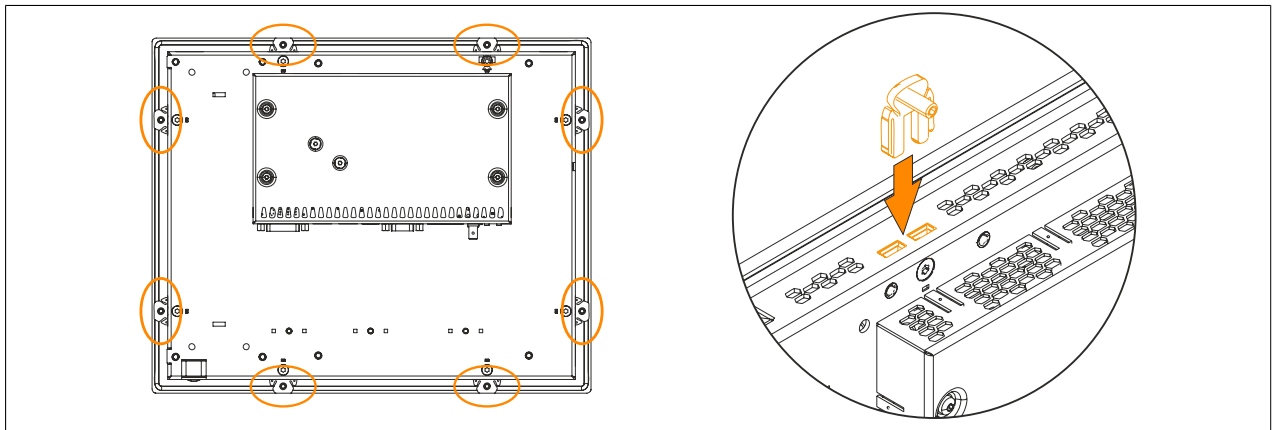

Figure 85: Inserting the retaining clips

4. Fasten the retaining clips to the wall or control cabinet by alternately tightening the screws with a 2.5 hex key screwdriver. The tightening torque should be max. 1 Nm to provide an optimal seal.

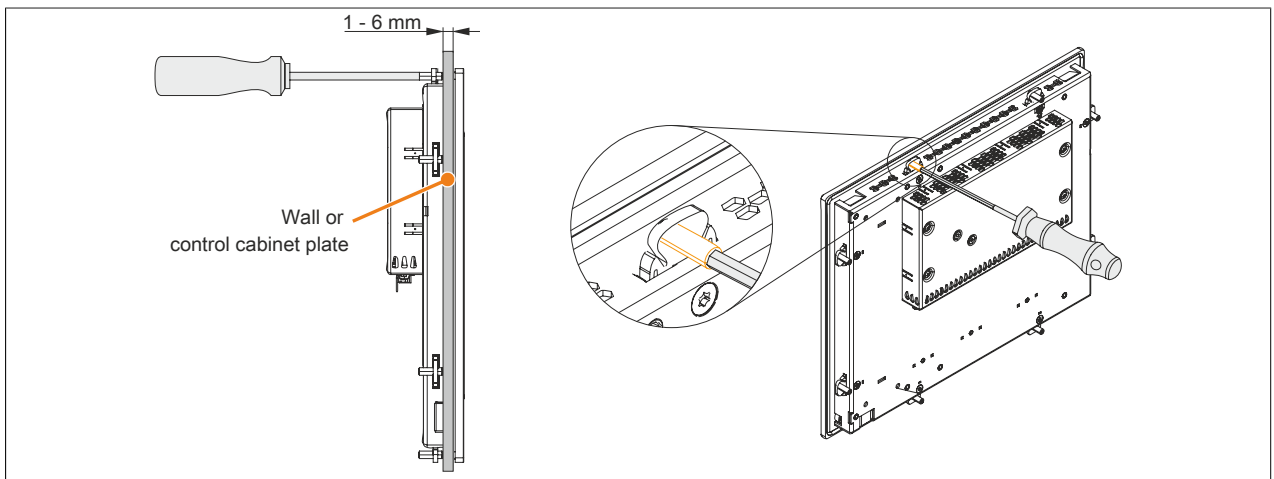

Figure 86: Fastening the retaining clips

1.3 Mounting an Automation Panel 1000 with clamping blocks

The Automation Panel 1000 is mounted in the cutout using clamping blocks. The number of clamping blocks depends on the panel.

The following Automation Panel 1000 systems are mounted using clamping blocks:

- 5AP1181.1043-000
- 5AP1182.1043-000
- 5AP1120.1214-000
- 5AP1120.1505-000
- 5AP1180.1505-000
- 5AP1181.1505-000
- 5AP1120.1906-000

The thickness of the wall or cabinet plate must be between 2 mm and 10 mm.

A 3 mm hex socket screwdriver is needed to tighten and loosen the screw on the clamping block. The maximum tightening torque for the screw is 0.5 Nm.

Devices must be installed on a flat, clean and burr-free surface; uneven areas can cause damage to the display when the screws are tightened or the intrusion of dust and water.

Procedure

1. Insert the device into the front side of the smooth, flat installation cutout. The dimensions for the cutout can be found in [Tab. 9 "AP1000 panels with clamping blocks - Installation diagrams" on page 26](#). The number of clamping blocks may vary depending on the panel. The exact number can be found in [Tab. 9 "AP1000 panels with clamping blocks - Installation diagrams" on page 26](#).

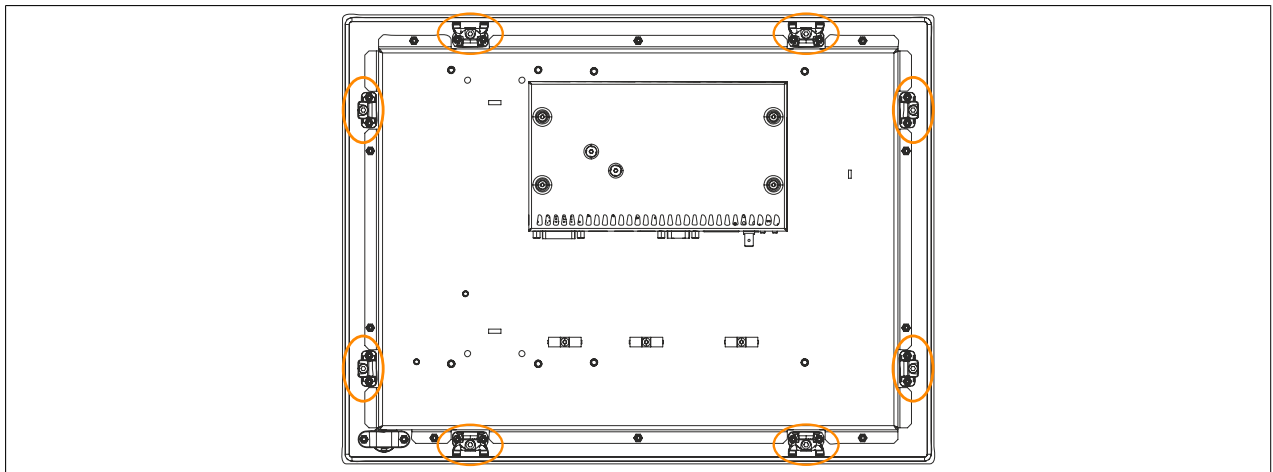

Figure 87: Position of the clamping blocks

2. Fasten the clamping blocks to the wall or control cabinet by alternately tightening the screws with a 3 mm hex key screwdriver. Tightening the screw presses down the integrated clamping lever to hold the device securely in place. The tightening torque should be max. 0.5 Nm to provide an optimal seal.

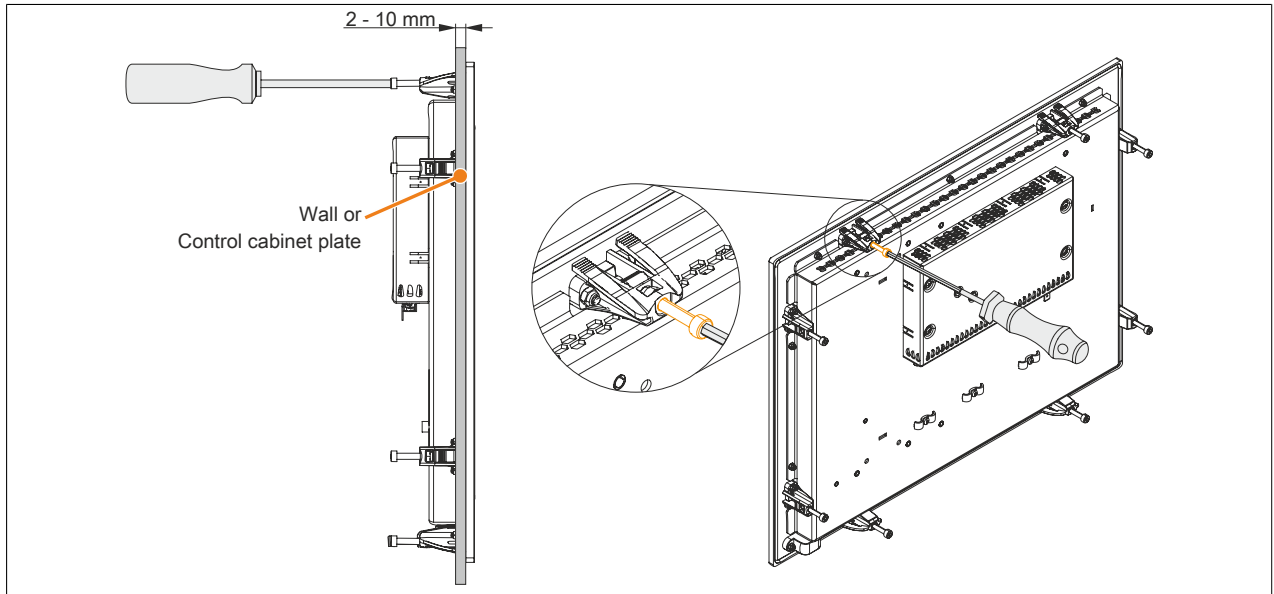

Figure 88: Fastening the clamping blocks

1.4 Replacing link modules

1. Disconnect the power supply to the Automation Panel (disconnect the power cable). Isolate the system from all potential sources of electrical power!
2. Discharge any electrostatic charge on the ground connection.
3. Remove the Automation Panel from the control cabinet by following the installation steps in reverse order.
4. Place the Automation Panel on a clean, flat surface.
5. Remove the Torx screws (T10) indicated in the following image.

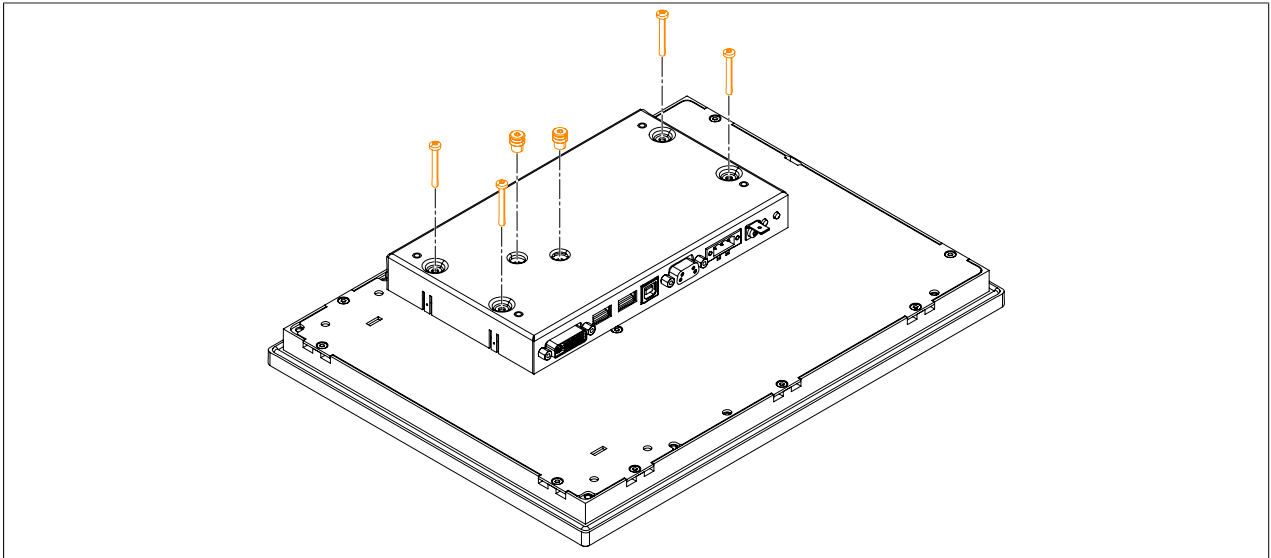

Figure 89: Removing the Torx screws

6. The link module can now be removed by pulling it straight up.

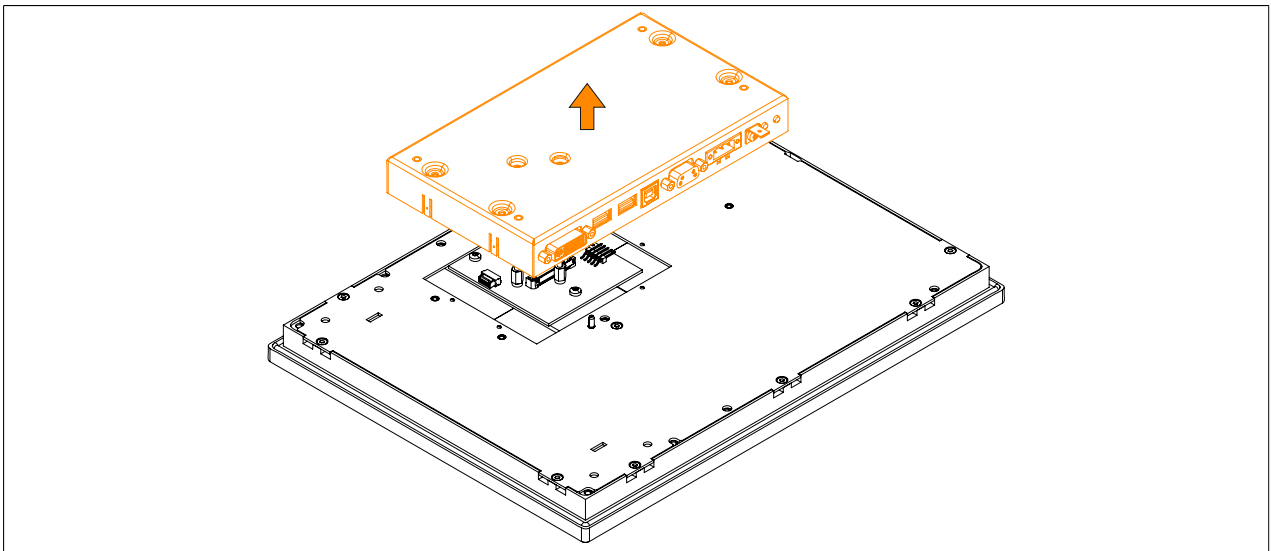

Figure 90: Removing the link module

7. The link module can now be replaced by following these steps in reverse order. The maximum tightening torque of the Torx screws (T10) is 0.5 Nm.

2 Connecting to the power grid

Danger!

- All power supplies must be disconnected before removing device covers or components and installing/removing accessories, hardware or cables.
- The power cable must be disconnected from the device and from the power supply.
- All covers, components, accessories, hardware and cables must be installed or connected before the device can be connected to the power supply and switched on.

2.1 Installing the DC power cable

Danger!

All power supplies to the B&R industrial PC and B&R Automation Panel must be interrupted. Before connecting the DC power cable, it is necessary to check whether it has been disconnected from the power source (e.g. power supply).

2.1.1 Wiring

The DC power cable must be installed in the terminal block (power supply connector) as shown in the image below. Wires with a cross section of 0.75 mm² to 1.5 mm² and wire end sleeves must be used.

Installing screw clamp terminal block 0TB103.9

Fasten the wires with wire end sleeves into the terminal contacts ② as shown in the image below and tighten the screw clamp terminals ① with a screwdriver (max. tightening torque 0.4 Nm).

Observe the pinout of the power supply connection on the device during wiring!

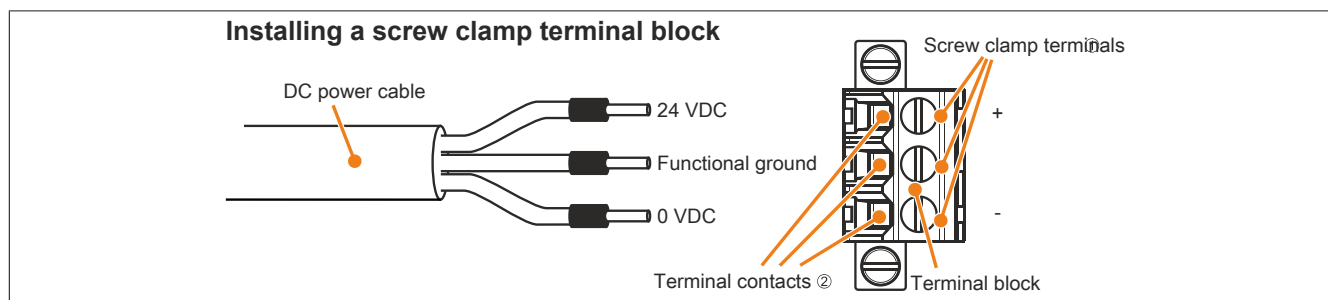

Figure 91: Installing a screw clamp terminal block

Installing cage clamp terminal block 0TB103.91

Insert a screwdriver into the cage clamp terminals ① and secure the wires with wire end sleeves in the terminal contacts ② as shown in the image below. Close the terminal contact by removing the screwdriver.

Observe the pinout of the power supply connection on the device during wiring!

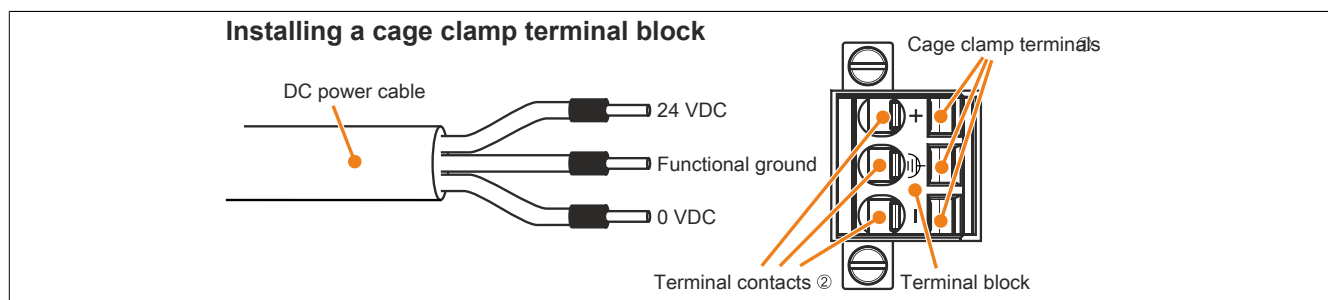

Figure 92: Installing a cage clamp terminal block

2.2 Connecting the power supply to a B&R device

Danger!

The power supply to the B&R device must be completely interrupted. Before connecting the power cable, it is necessary to check whether it has been disconnected from the power source (e.g. power supply).

1. Discharge any electrostatic charge on the housing or ground connection.
2. Connect the power supply connector to the B&R device and tighten the mounting screws (max. tightening torque 0.5 Nm).

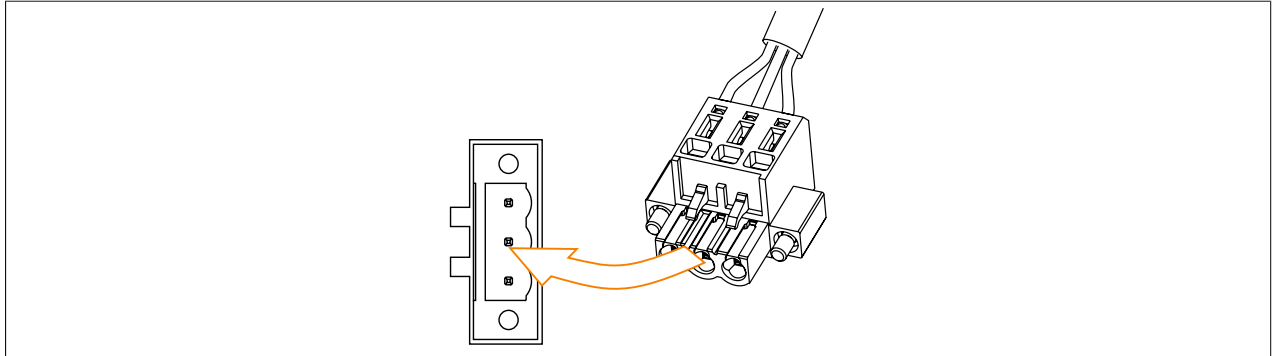

Figure 93: Connecting the power supply connector to a B&R device

2.3 Functional ground - Grounding concept

Functional ground is a current path of low impedance between electrical circuits and ground. It is used to improve immunity to interference, for example, and not necessarily as a protective measure. It therefore serves only to conduct interference, not to provide any kind of protection against electric shock.

This device comes equipped with 2 functional ground connections:

- Power supply
- Ground connection

To ensure the safe conductance of electrical interference, the following points must be observed:

- The device must be connected to the central grounding point in the control cabinet using the shortest route possible.
- A cable with a minimum cross section of 2.5 mm^2 per connection must be used. If a cable with wire end sleeves is connected to terminal block 0TB103.9 or 0TB103.91, then a cable with maximum 1.5 mm^2 per connection is possible.
- Observe the line shielding concept. All data cables connected to the device must be shielded.

The following symbol is used to indicate functional ground on the B&R device: 

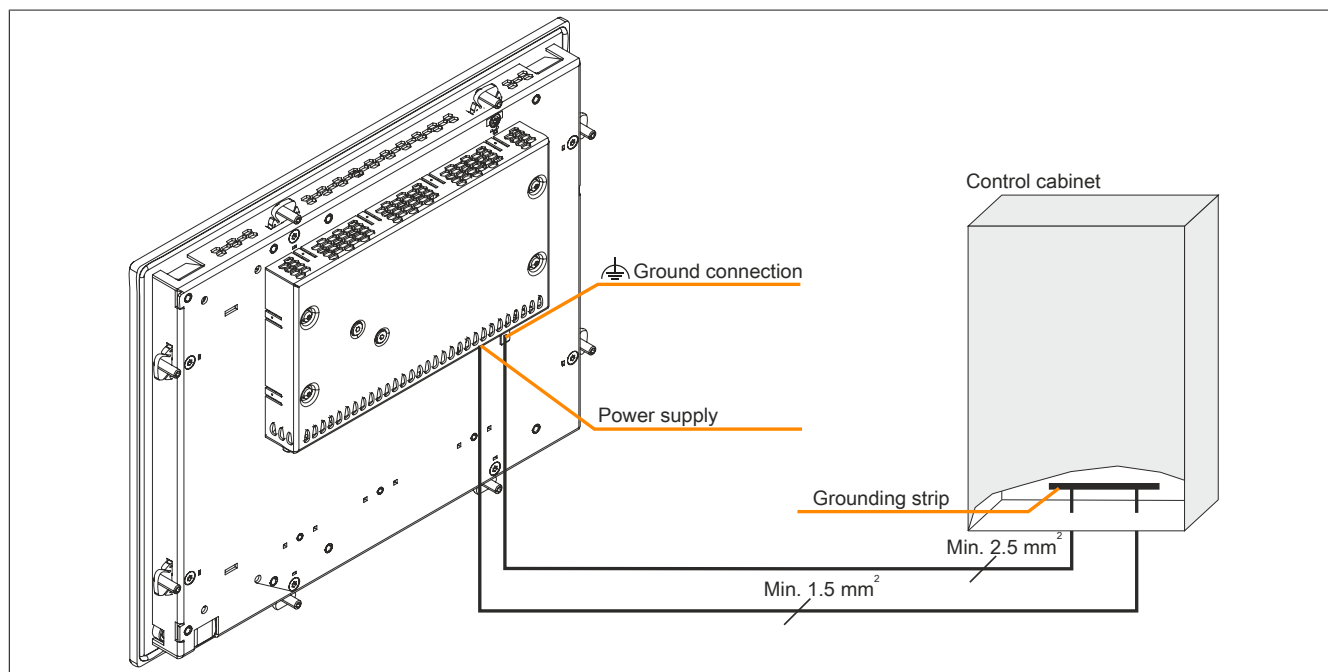

Figure 94: Automation Panel 1000 - Grounding concept

3 Cable connections

The bend radius specifications must be taken into account when installing or connecting cables.

Information:

The maximum tightening torque for the locating screws is 0.5 Nm.

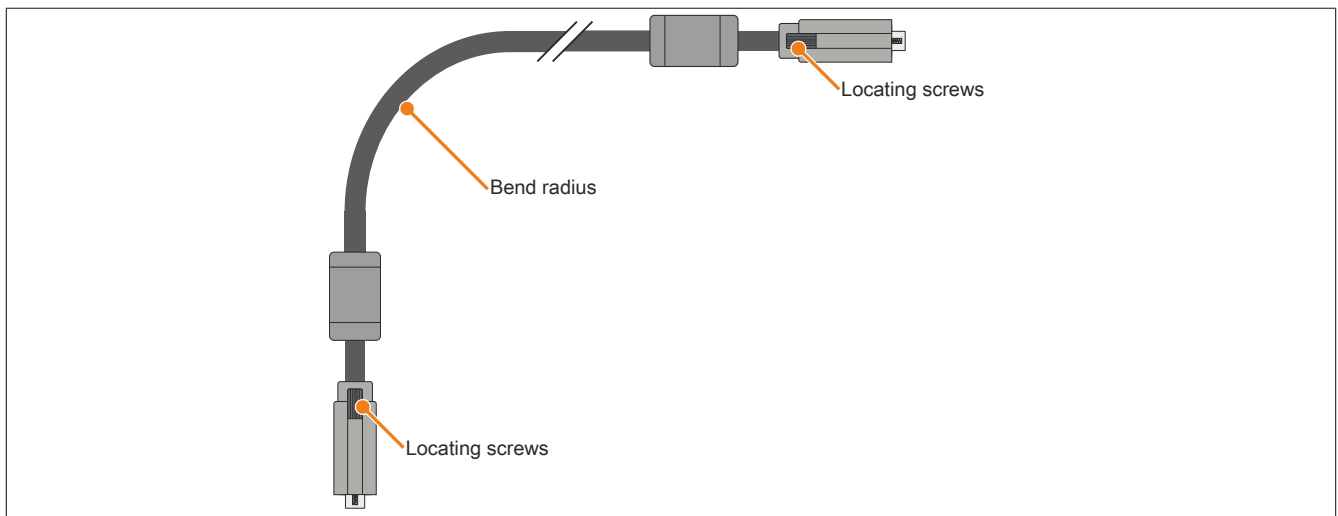

Figure 95: Bend radius - Cable connection

Information:

For the specified bend radius, see the technical data for the respective cable.

4 Switching on the device for the first time

4.1 General information before switching on the device

Checklist

The following items must be checked before the device is put into service for the first time:

- Have the installation notes specified in "Installation" on page 127 been observed?
- Have the permissible environmental conditions for the device been taken into account?
- Is the power supply connected correctly, and have the values been checked?
- Is the ground cable connected correctly to the ground connection?
- The device must first be put into service before additional hardware is installed.

Caution!

Before the device is put into service, it must slowly be acclimated to room temperature! Subjecting it to thermal radiation is not permitted.

If transported at low temperatures or if there are large temperature fluctuations, the device is not permitted to be subjected to any type of moisture.

Moisture can cause short circuits in the electrical circuits and damages the device.

Requirements

The following requirements must be fulfilled before the device is switched on for the first time:

- The protective film has been removed from the panel.
- The functional ground connections must be kept as short as possible and connected to the central grounding point using the largest possible wire cross section.
- All connection cables must be connected correctly.
- A USB keyboard and USB mouse are connected (optional).
- An Automation PC or Panel PC is connected (via DVI, SDL, SDL3 or SDL4).

4.2 Switching on the Automation Panel

Procedure

1. Connect and switch on the voltage supply (e.g. power supply).
2. The device is operational.

5 Touch screen calibration

B&R touch screen devices are equipped with a B&R touch controller that supports hardware calibration. This means that devices are pre-calibrated when delivered. This is a beneficial property when replacing devices of the same model or type since the new device does not require recalibration. Nevertheless, calibrating the device is still recommended in order to achieve the best results and to better adapt the touch screen to the user's preferences.

5.1 Single-touch (analog resistive)

5.1.1 Windows 10 IoT Enterprise 2016 LTSC

After starting Windows 10 IoT Enterprise 2016 LTSC on a Panel PC for the first time, the appropriate touch screen driver is installed automatically.

On all other devices, the touch screen driver must be subsequently installed to operate the touch screen. The appropriate driver is available for download in the Downloads section of the B&R website (www.br-automation.com).

5.1.2 Windows 10 IoT Enterprise 2015 LTSC

After starting Windows 10 IoT Enterprise 2015 LTSC on the Panel PC for the first time, the corresponding touch screen driver is installed automatically.

On all other devices, the touch screen driver must be subsequently installed to operate the touch screen. The appropriate driver is available for download in the Downloads section of the B&R website (www.br-automation.com).

5.1.3 Windows Embedded 8.1 Industry Pro

After starting Windows Embedded 8.1 Industry Pro on the Panel PC for the first time, the corresponding touch screen driver is installed automatically.

On all other devices, the touch screen driver must be subsequently installed to operate the touch screen. The appropriate driver is available for download in the Downloads section of the B&R website (www.br-automation.com).

5.1.4 Windows 7 Professional / Ultimate

After installing Windows 7 on the device, the touch screen driver must be installed in order to operate the touch screen. The appropriate driver is available for download in the Downloads section of the B&R website (www.br-automation.com).

5.1.5 Windows Embedded Standard 7 Embedded / Premium

A touch screen driver will be installed automatically if a touch controller is detected during the Windows Embedded Standard 7 installation.

The touch screen driver must be installed manually if a touch controller was not detected when installing Windows Embedded Standard 7 or if an Automation Panel has been connected after installation. The appropriate driver is available for download in the Downloads section of the B&R website (www.br-automation.com).

5.1.6 Windows XP Professional

After installing Windows XP Professional on the device, the touch screen driver must be installed in order to operate the touch screen. The appropriate driver is available for download in the Downloads section of the B&R website (www.br-automation.com).

5.1.7 Windows Embedded Standard 2009

After starting Windows Embedded Standard 2009 on the Panel PC or Power Panel for the first time (first boot agent), the corresponding touch screen driver is installed automatically.

On all other devices, the touch screen driver must be subsequently installed to operate the touch screen. The appropriate driver is available for download in the Downloads section of the B&R website (www.br-automation.com).

5.2 Multi-touch (projected capacitive - PCT)

5.2.1 Windows 10 IoT Enterprise 2016 LTSC

Microsoft multi-touch drivers are installed when Windows 10 IoT Enterprise 2016 LTSC is installed on the device. After the successful installation of Windows 10 IoT Enterprise 2016 LTSC, the device is immediately ready for operation.

5.2.2 Windows 10 IoT Enterprise 2015 LTSC

Microsoft multi-touch drivers are installed when Windows 10 IoT Enterprise 2015 LTSC is installed on the device. Once the installation of Windows 10 IoT Enterprise 2015 LTSC has completed, the device can be operated immediately.

5.2.3 Windows Embedded 8.1 Industry Pro

Microsoft multi-touch drivers are installed when Windows Embedded 8.1 Industry Pro is installed on the device. Once the installation of Windows Embedded 8.1 Industry Pro has completed, the device can be operated immediately.

5.2.4 Windows 7 Professional / Ultimate

Microsoft multi-touch drivers are installed when Windows 7 is installed on the device. Once the installation of Windows 7 has completed, the device can be operated immediately.

5.2.5 Windows Embedded Standard 7 Premium

Microsoft multi-touch drivers are installed when Windows Embedded Standard 7 Premium is installed on the device. Once the installation of Windows Embedded Standard 7 Premium has completed, the device can be operated immediately.

6 Adjusting the display brightness

In SDL, SDL3 or SDL4 mode, the brightness of the display can be configured using the Control Center on the connected B&R industrial PC, for example. In DVI mode, the brightness can only be controlled using the two brightness controls provided on the SDL/DVI receiver.

6.1 Adjusting in SDL / SDL3 / SDL4 mode

1. Open the **Control Center** in the Control Panel.
2. Select the **Display** tab.
3. Select the Automation Panel from the list.
4. Set the desired brightness using the slider control.

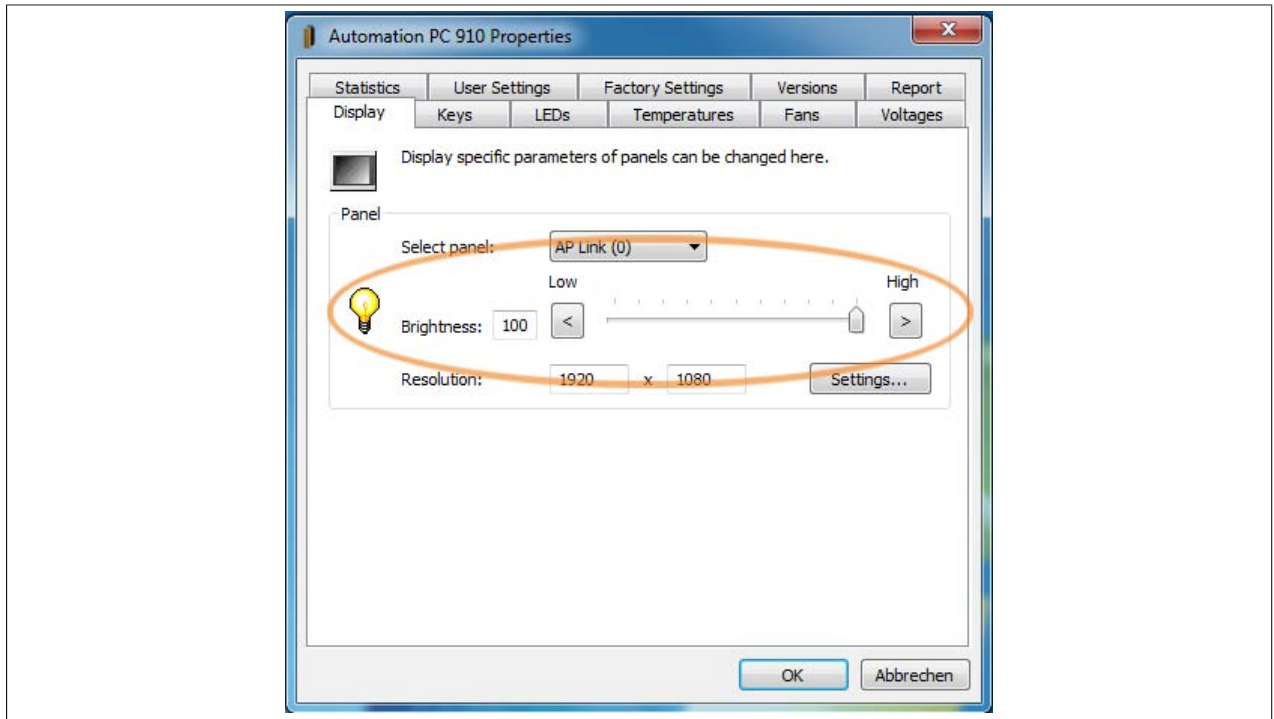

Figure 96: Adjusting the display brightness

Information:

Changes to these settings are displayed online but are only applied by the system (and applied during the next restart) if the Control Center is closed with **OK**.

The configured brightness is separate from the value configured in BIOS Setup, i.e. the value in BIOS is used until Windows boots. The value from BIOS is only applied the first time the Control Center is launched.

6.2 Adjusting in DVI mode

1. Use the two brightness controls on the SDL/DVI receiver to set the brightness.

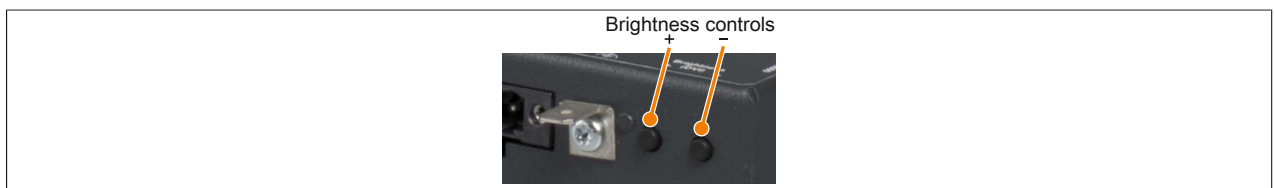

Figure 97: Brightness controls

Chapter 4 • Software

1 Upgrade information

Warning!

The BIOS and firmware on B&R devices must be kept current. New versions can be downloaded from the B&R website (www.br-automation.com).

1.1 Upgrading the firmware on the Automation Panel

The "Firmware upgrade (Automation Panel, SDL3 Converter)" software makes it possible to update the firmware for multiple controllers (SDLR, SDL3R, SDL4R, SDL3 Converter) depending on how the system is designed.

The latest firmware upgrade is available in the Downloads section of the B&R website (www.br-automation.com).

Caution!

The PC is not permitted to be switched off or reset while performing an update!

2 Multi-touch drivers

Multi-touch panels are approved as human-interface devices (i.e. multi-touch support from the operating system) for the following operating systems:

- Windows 10 IoT Enterprise 2016 LTSC
- Windows 10 IoT Enterprise 2015 LTSC
- Windows Embedded 8.1 Industry Pro
- Windows 7 Professional/Ultimate
- Windows Embedded Standard 7 Premium
- Debian 8 (B&R versions)

No guarantee can be made regarding multi-touch or single-touch operation, compatibility and functionality when using other operating systems and/or individual touch screen drivers.

3 Automation Runtime

3.1 General information

An integral component of Automation Studio is the Automation Runtime real-time operating system. This real-time operating system is the software kernel that allows applications to run on a target system.

- Guaranteed highest possible performance for the hardware being used
- Runs on all B&R target systems
- Makes the application hardware-independent
- Easy portability of applications between B&R target systems
- Deterministic behavior guaranteed by cyclic system
- Configurable jitter tolerance in all task classes
- Supports all relevant programming language such as IEC 61131-3 and C
- Extensive function library conforming to IEC 61131-3 as well as the expanded B&R Automation library
- Integrated into Automation NET. Access to all networks and bus systems via function calls or the Automation Studio™ configuration

B&R Automation Runtime is fully embedded in the corresponding target system (the hardware where Automation Runtime is installed). It allows application programs to access I/O systems (e.g. via the fieldbus) and other devices (interfaces, networks, etc.).

3.2 Automation Runtime Embedded (ARemb)

The following software versions (or higher) are required to operate Automation Runtime Embedded with an Automation Panel 1000:

- Automation Studio V4.0.17.x
 - There is support starting from this version exclusively for 5AP1120* single-touch panels.
- Automation Studio V4.1.4.x
 - There is support with single-touch functionality starting with this version for single-touch Panel 5AP1120.101E-000.
- Automation Studio V4.2.5 and ARemb upgrade AR M4.10 or AR I4.25
 - There is support with single-touch functionality starting with this version for multi-touch panels 5AP1130.0702-000, 5AP1130.101E-000 and 5AP1130.121E-000.
- Automation Studio V4.2.5 and ARemb upgrade AR N4.10 or AR A4.26
 - There is support with single-touch functionality starting with this version for multi-touch panels 5AP1130.156C-000 and 5AP1130.185C-000.

Information:

Exact information regarding model numbers and Automation Runtime Windows (ARwin) support can be found in the respective user's manual of the B&R Industrial PC being used. This is available in the Downloads section of the B&R website (www.br-automation.com).

4 B&R Automation Device Interface (ADI) Control Center

The Automation Device Interface (ADI) makes it possible access specific functions of B&R devices. In Windows, the settings for these devices can be viewed and modified using the B&R Control Center in the Control Panel.

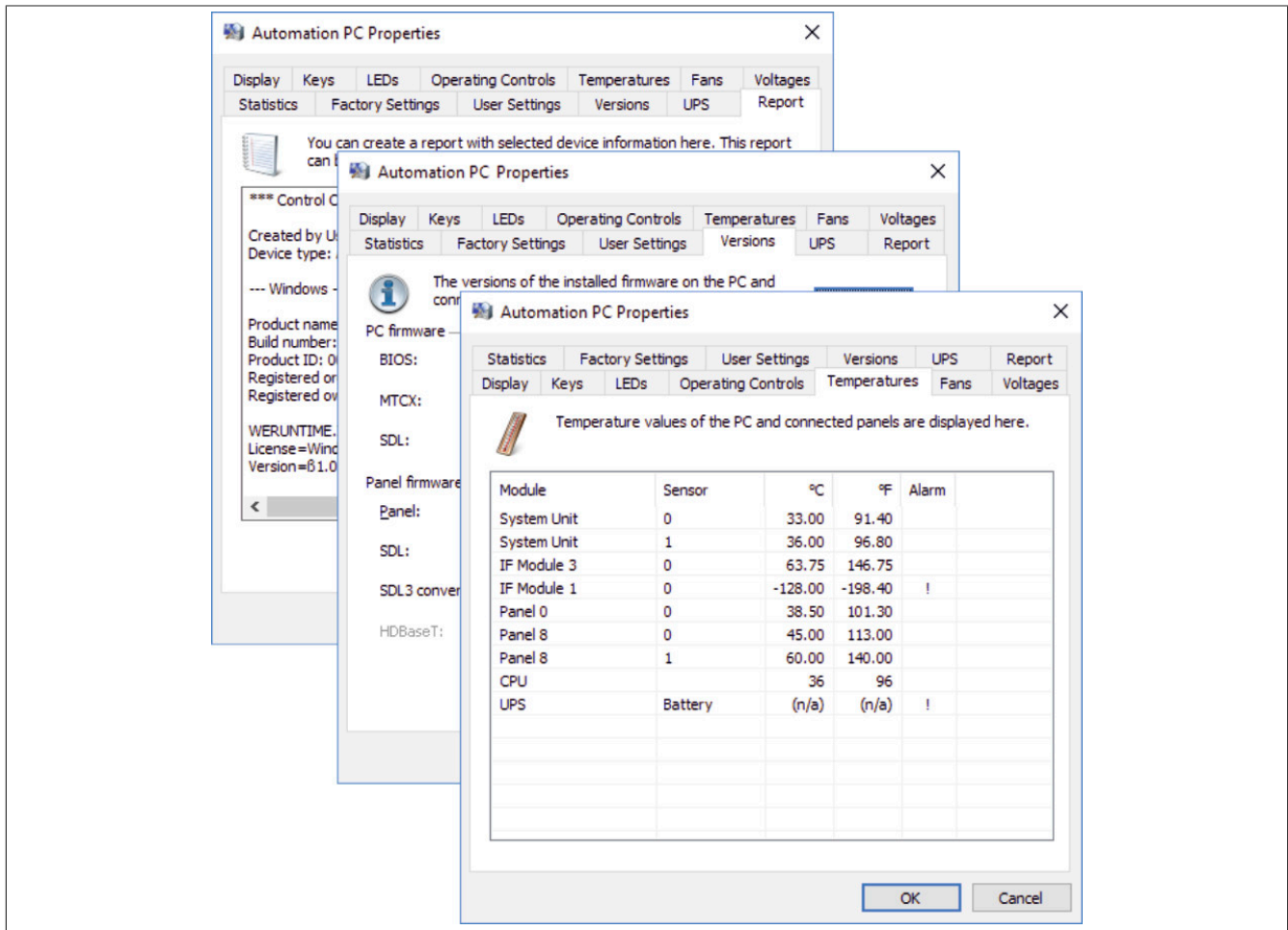

Figure 98: ADI Control Center screenshots - Examples

Information:

The temperature and voltage values (e.g. CPU temperature, core voltage, battery voltage) displayed represent uncalibrated values for informational purposes. They cannot be used to draw conclusions about possible hardware alarms or error states. The hardware components being used include automatic diagnostic functions in the event of error.

4.1 Functions

Information:

The functions provided by the Control Center depend on the device family.

- Changing display-specific parameters
- Reading device-specific keys
- Updating the key configuration
- Enabling device-specific LEDs on a membrane keypad or keys
- Reading and calibrating control devices (e.g. key switches, handwheels, joysticks, potentiometers)
- Reading temperatures, fan speeds, statistical data and switch positions
- Reading operating hours (power-on hours)
- Reading user settings and factory settings
- Reading software versions
- Updating and backing up BIOS and firmware
- Creating reports about the current system (support assistance)

- Setting the SDL equalizer value when adjusting SDL cables
- Changing the user serial ID

For a detailed description of the Control Center, see Automation Help or the user documentation (depends on the version).

4.2 Installation

The B&R Automation Device Interface (ADI) driver (also includes the Control Center) and user documentation can be downloaded at no cost from the Downloads section of the B&R website (www.br-automation.com).

Information:

The ADI driver is included in most B&R Windows operating systems; it can also be installed on demand. If a more current ADI driver version exists (see the Downloads section of the B&R website), it can be installed later. Note that the write filter must be disabled during installation.

5 B&R Automation Device Interface (ADI) Development Kit

This software can be used to access B&R Automation Device Interface (ADI) functions directly from Windows applications created in Microsoft Visual Studio, for example.

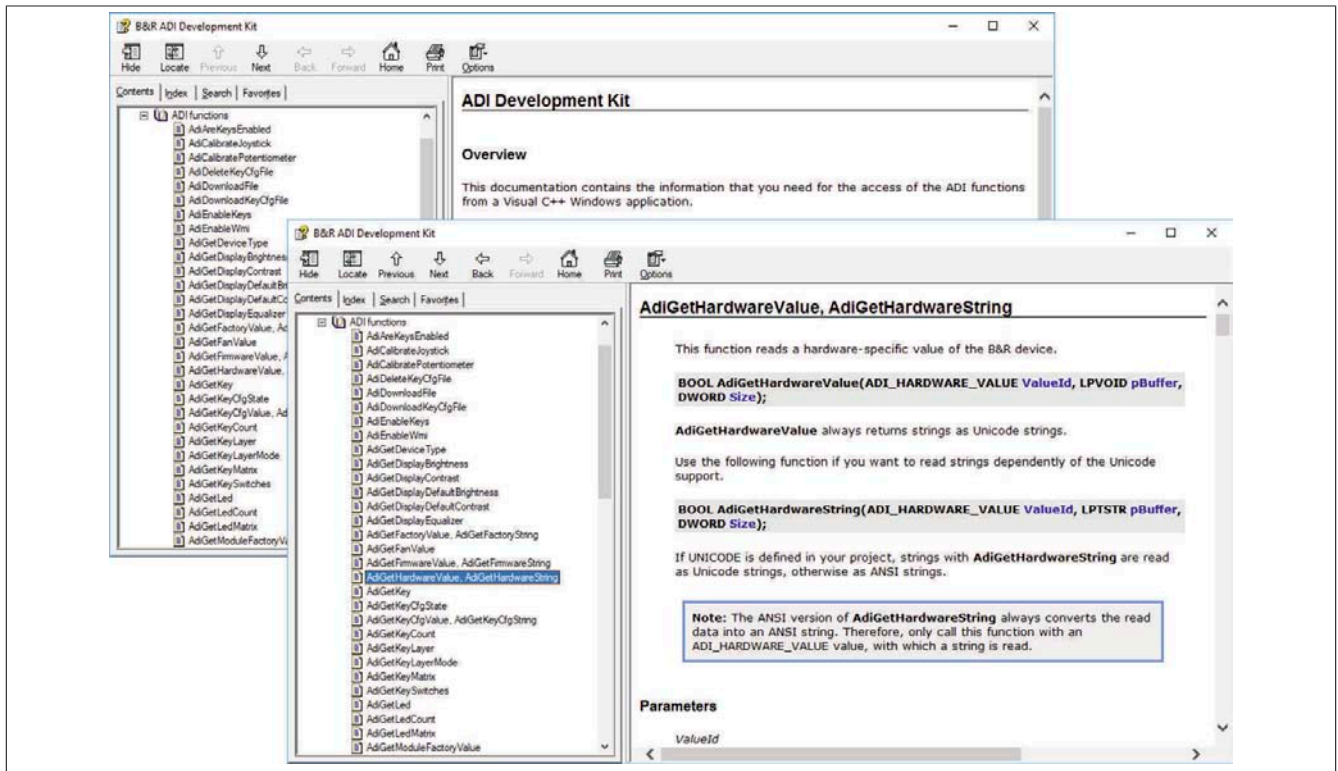

Figure 99: ADI Development Kit Screenshots (Symbolbild)

Features:

- Header files and import libraries
- Help files
- Sample projects
- ADI DLL (for testing applications if no ADI driver is installed)

The appropriate ADI driver must be installed for the specified product family. The ADI driver is already included in the embedded operating system images from B&R.

For a detailed description of how to use ADI functions, see Automation Help.

The B&R Automation Device Interface (ADI) Development Kit can be downloaded at no cost from the Downloads section of the B&R website (www.br-automation.com).

6 B&R Automation Device Interface (ADI) .NET SDK

This software can be used to access B&R Automation Device Interface (ADI) functions directly from .NET applications created in Microsoft Visual Studio.

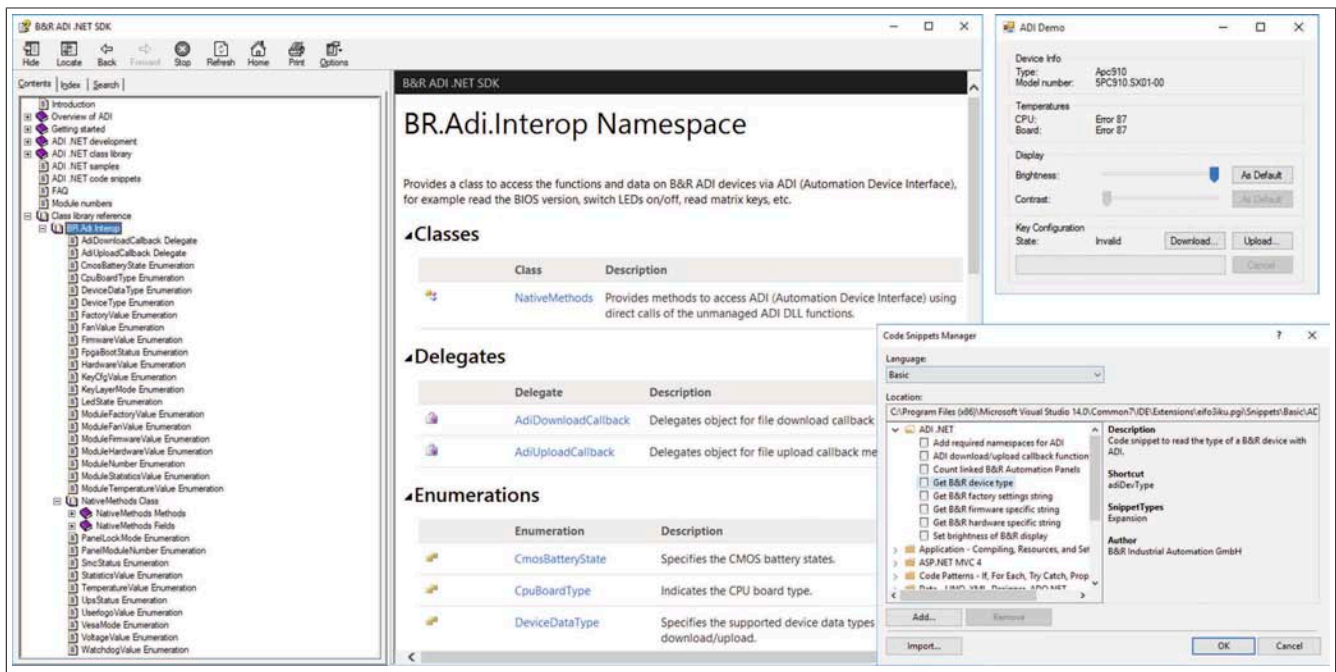

Figure 100: ADI .NET SDK screenshots

Features:

- ADI .NET class library
- Help files (the help documentation is in English)
- Sample projects and code snippets.
- ADI DLL (for testing applications if no ADI driver is installed).

The appropriate ADI driver must be installed for the specified product family. The ADI driver is already included in the embedded operating system images from B&R.

For a detailed description of how to use ADI functions, see Automation Help.

The ADI .NET SDK can be downloaded at no cost from the Downloads section of the B&R website (www.br-automation.com).

7 B&R Key Editor

A common panel requirement is to adapt function keys and LEDs directly to the application software. The B&R Key Editor makes this individual adaptation to the application quick and easy.

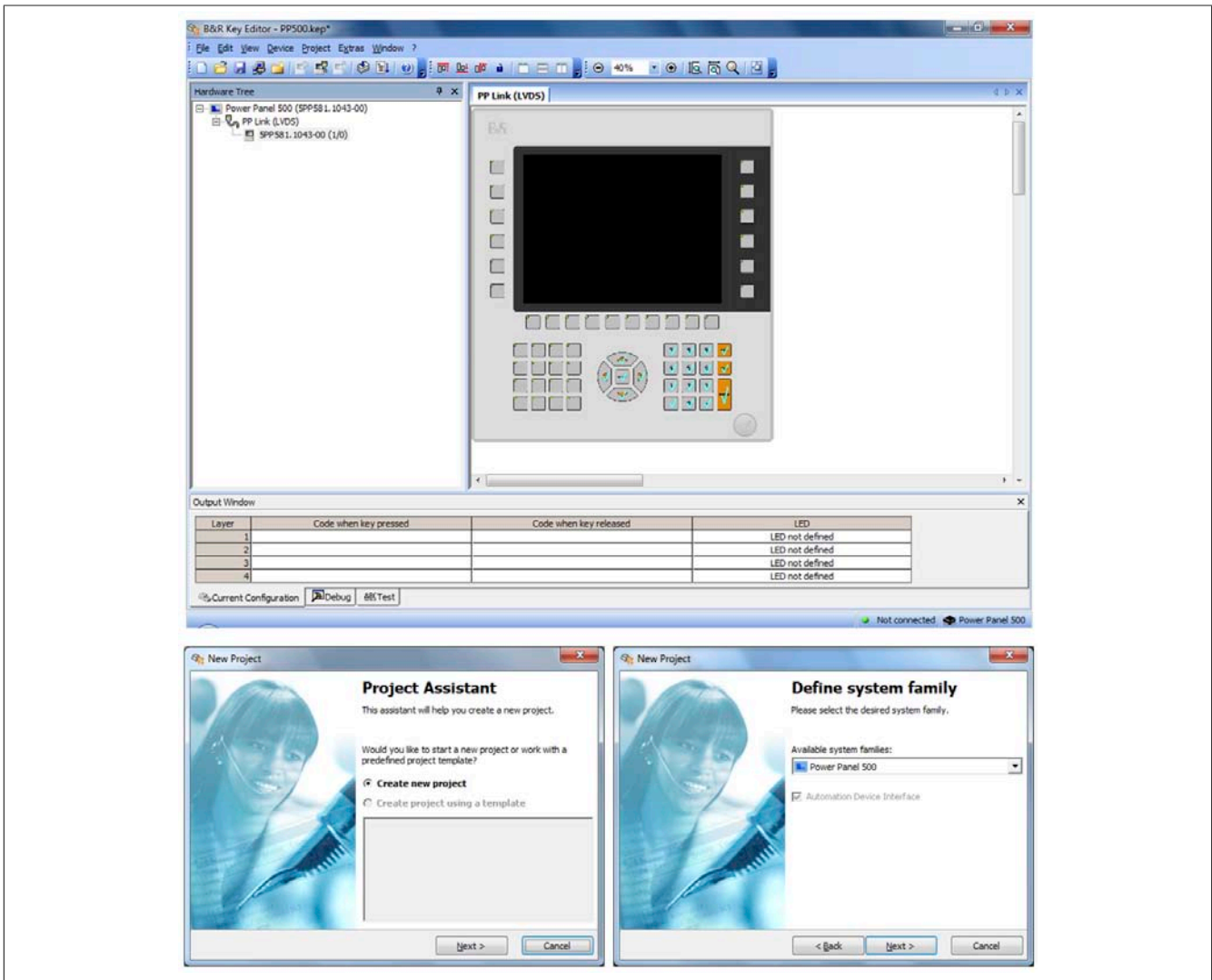

Figure 101: B&R Key Editor screenshots

Features:

- Configuration of normal keyboard keys (A, B, C, etc.)
- Keyboard shortcuts (CTRL+C, SHIFT+DEL, etc.) using a single key
- Special key functions (change brightness, etc.)
- Assignment of functions to LEDs (HDD access, power, etc.)
- 4 assignments possible per key (using layers)
- Configuration of the panel locking time when connecting multiple Automation Panel devices to Automation PCs and Panel PCs.

For a detailed guide on configuring keys and LEDs as well as installing the key configuration on the target system, see the help documentation for the B&R Key Editor. The B&R Key Editor and its help documentation can be downloaded at no cost from the Downloads section of the B&R website (www.br-automation.com).

8 B&R KCF Editor

The B&R KCF Editor can be used as a simple alternative to B&R Key Editor. This tool also allows function keys and LEDs to be adapted to the application software. Unlike the B&R Key Editor, operation takes place in a simple Windows dialog box instead of on a visual representation of the device. This makes it possible to use the B&R KCF Editor for devices that are not yet supported by the B&R Key Editor. The B&R KCF Editor is a portable application and can be launched on the target device without prior installation (directly from a USB flash drive, for example). An installed ADI driver is required to use the software's full range of functions.

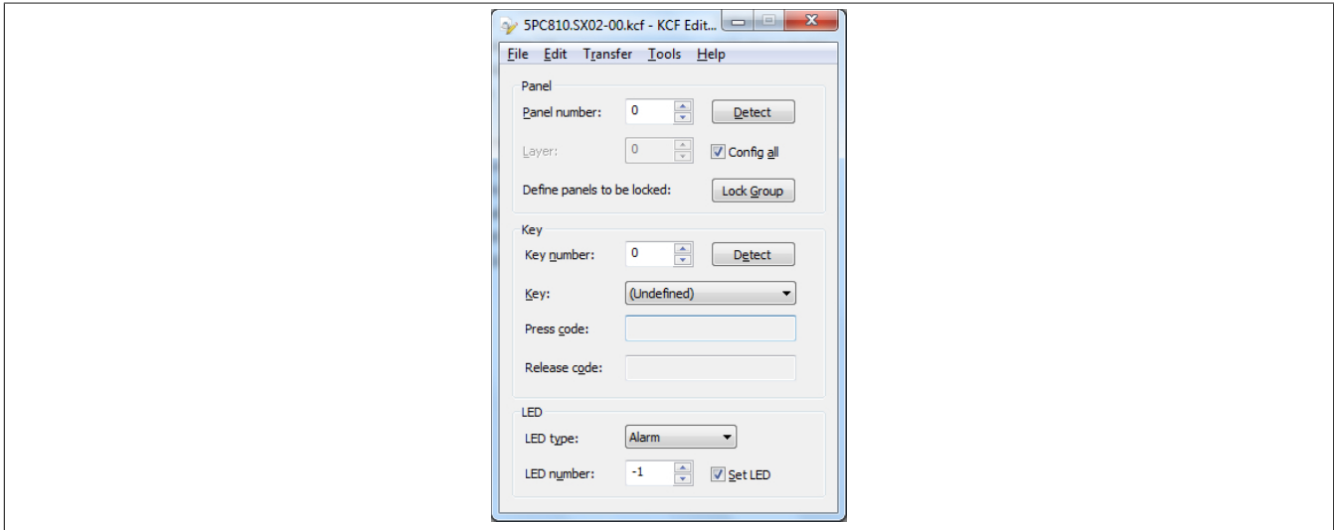

Figure 102: B&R KCF Editor V1.0 screenshot

Features

- Configuration of normal keyboard keys (A, B, C, etc.)
- Special key functions (change brightness, etc.)
- Assignment of functions to LEDs (HDD access, power, etc.)
- 4 assignments possible per key (using layers)
- Configuration of the panel locking time when connecting multiple Automation Panel devices to B&R PCs.
- Exporting and importing configurations (INI files)
- Saving configurations as a report (text file)

Additional features if the B&R KCF Editor is executed on the target device³⁾

- Panel and key detection
- LED test
- Configuration uploads/downloads

9 HMI Service Center

9.1 5SWUTI.0001-000

9.1.1 General information

The HMI Service Center is software for testing B&R industrial PCs and Automation Panels. Various categories such as COM interfaces, network connectivity and SRAM are tested.

The test system consists of a USB flash drive with an installed Windows PE operating system and the HMI Service Center.

For details about the HMI Service Center, see the HMI Service Center user's manual. This can be downloaded at no cost from the B&R website (www.br-automation.com).

³⁾ The ADI driver must be installed on the B&R PC to use these features.

9.1.2 Order data

Model number	Short description	Figure
5SWUTI.0001-000	Accessories HMI Service Center USB flash drive - Hardware diagnostic software - For APC810/PPC800 - For APC910/PPC900 - For APC2100/PPC2100 - For APC51x/PP500 - For Automation Panel 800/900	

Table 91: 5SWUTI.0001-000 - Order data

Chapter 5 • Standards and certifications

1 Standards and guidelines

1.1 CE marking



All guidelines applicable to the product and their harmonized EN standards are fulfilled.

1.2 EMC directive

These products meet the requirements of EU directive "Electromagnetic compatibility 2014/30/EU" and are designed for industrial use:

EN 61131-2:2007	Programmable logic controllers - Part 2: Equipment requirements and tests
EN 61000-6 -2:2005	Electromagnetic compatibility (EMC) - Part 6-2: Generic standards - Immunity for industrial environments
EN 61000-6 -4:2007	Electromagnetic compatibility (EMC) - Part 6-4: Generic standards - Emission standard for industrial environments

Information:

Declarations of conformity are available on the B&R website under [Downloads - Certificates - Declarations of conformity](#).

2 Certifications

Danger!

A complete system can only receive certification if ALL of the individual components installed therein have the corresponding certifications. If an individual component is used that DOES NOT have a corresponding certification, then the complete system also DOES NOT have certification.

Products and services from B&R comply with applicable standards. This includes international standards from organizations such as ISO, IEC and CENELEC, as well as national standards from organizations such as UL, CSA, FCC, VDE, ÖVE, etc. We are committed to ensuring the reliability of our products in industrial environments.

Information:

Applicable certifications for the respective product are available on the website, under section "Certifications" of the technical data in the user's manual or in the associated certificates.

2.1 UL certification



Products with this mark are tested by Underwriters Laboratories and listed as "industrial control equipment". This mark is valid for the USA and Canada and simplifies the certification of your machines and manufacturing systems in this economic region.

Underwriters Laboratories (UL) per standard UL 508
Canadian (CSA) standard per C22.2 No. 142-M1987

UL certificates are available on the B&R website under [Downloads - Certificates - UL](#).

It is important to note that the device is classified as "open type" when used in the area of "Industrial control equipment" per UL 508. The device must therefore be installed in a UL508-compliant housing as a requirement for certification or operation per UL 508.

Ind.Cont.Eq.
E115267

2.2 GOST-R



Products with this mark are tested by an accredited testing laboratory and permitted for import to the Russian Federation (based on EU compliance).

2.3 EAC



Products with this mark are tested by an accredited testing laboratory and permitted for import to the Eurasian Economic Union (based on EU compliance).

2.4 KC



Products with this mark are tested by an accredited testing laboratory and permitted for import to the Korean market (based on EU compliance).

2.5 RCM



Products with this mark are tested by an accredited testing laboratory and certified by the ACMA. This mark is valid in Australia/Oceania and simplifies the certification of your machines and systems in this economic region (based on EU compliance).

2.6 DNV GL certification (Det Norske Veritas Germanischer Lloyd)



Products with this certification have been certified by classification society DNV GL and are suitable for maritime environments. DNV GL certificates (type approval) are generally accepted by other classification societies during ship acceptance procedures.

DNV GL per standard DNVGL-CG-0339 from November 2016
IACS E10
EN 60945 section 1c

These products are suitable for the following DNV GL environmental conditions (DNV GL classes):

Temperature	B
Moisture	B
Vibration	A
EMC	B
Housing	When installing on board, the guidelines for meeting the required protection level must be observed.

Products used on a ship's bridge must be dimmable using software in accordance with the regulations and guidelines from the respective classification society.

Windows 7 operating systems are only permitted to be used as embedded variants. For all other B&R-approved operating systems there are no restrictions.

The following table lists the revisions from which DNV GL certification applies to individual components.

Model number	Description	DNV GL beginning with rev.
5AP1120.1906-000	Automation Panel 19.0" SXGA TFT - 1280 x 1024 pixels (5:4) - Single-touch (analog resistive) - Control cabinet installation - Landscape format - Front USB interface - For PPC900 / PPC2100 / Link module - Installation compatible with 5AP920.1906-01 5PC720.1906-00/5PC820.1906-00	D0
5AP1130.156C-000	Automation Panel 15.6" Full HD TFT - 1920 x 1080 pixels (16:9) - Multi-touch (projected capacitive) - Control cabinet installation - Landscape format - For PPC900 / PPC2100 / PPC3100 / link modules	C0
5CADVI.0018-00	DVI-D cable - 1.8 m	D0
5CADVI.0050-00	DVI-D cable - 5 m	D0
5CADVI.0100-00	DVI-D cable - 10 m	D0
5CASDL.0008-00	SDL cable - 0.8 m	A0
5CASDL.0010-03	SDL flex cable - 1 m	D0
5CASDL.0018-00	SDL cable - 1.8 m	D0
5CASDL.0018-01	SDL cable- 45 degree connector- 1.8 m	D0

Model number	Description	DNV GL beginning with rev.
5CASDL.0018-03	SDL flex cable - 1.8 m	D0
5CASDL.0050-00	SDL cable - 5 m	D0
5CASDL.0050-01	SDL cable- 45 degree connector- 5 m	D0
5CASDL.0050-03	SDL flex cable - 5 m	D0
5CASDL.0070-03	SDL flex cable - 7.0 m	D0
5CASDL.0100-00	SDL cable - 10 m	D0
5CASDL.0100-01	SDL cable- 45 degree connector- 10 m	D0
5CASDL.0100-03	SDL flex cable - 10 m	D0
5CASDL.0150-00	SDL cable - 15 m	D0
5CASDL.0150-01	SDL cable- 45 degree connector- 15 m	D0
5CASDL.0150-03	SDL flex cable - 15 m	D0
5CASDL.0200-00	SDL cable - 20 m	D0
5CASDL.0200-03	SDL flex cable - 20 m	D0
5CASDL.0250-00	SDL cable - 25 m	D0
5CASDL.0250-03	SDL flex cable - 25 m	D0
5CASDL.0300-00	SDL cable - 30 m	D0
5CASDL.0300-03	SDL flex cable - 30 m	D0
5CASDL.0300-13	SDL flex cable with extender- 30 m	D0
5CASDL.0400-13	SDL flex cable with extender- 40 m	D0
5CASDL.0430-13	SDL flex cable with extender- 43 m	D0
5CAUSB.0018-00	USB 2.0 connection cable - Type A - Type B connector - 1.8 m	D0
5CAUSB.0050-00	USB 2.0 connection cable - Type A - Type B connector - 5 m	D0
5DLSL.1001-00	Automation Panel link module- SDL/DVI receiver- For Automation Panel 923/933/1000	E0
0TB103.9	Connector 24 VDC - 3-pin female - Screw clamp terminal block 3.31 mm ²	D0
0TB103.91	Connector 24 VDC- 3-pin female- Cage clamp terminal block 3.31 mm ²	D0
5AC804.MFLT-00	Line filter	D0

DNV GL certificates with specifications for permitted environmental conditions are available on the B&R website at [Downloads - Certificates - Maritime - DNV GL](#).

Certificates for compass safe distance are available at [Downloads - Certificates - Maritime - Compass safe distance](#).

2.7 UL Haz. Loc. certification



Products with this mark are tested by Underwriters Laboratories and listed as "industrial control equipment for use in hazardous locations". This mark is valid for the USA and Canada and simplifies the certification of your machines and manufacturing systems in this economic region.

Underwriters Laboratories (UL) per standard ANSI/ISA 12.12.01
Canadian (CSA) standard per C22.2 No. 213-16

UL HazLoc certificates are available on the B&R website under [Downloads - Certificates - HazLoc](#).

Ind.Cont.Eq.
for Haz.Locs.
Cl. I, Div. 2,
Groups ABCD
E180196 (T4)

2.7.1 General safety guidelines

AP1000 panels with SDL or SDL3 link module that are certified for use in potentially explosive environments and carry the marking above are suitable for use in Class 1, Division 2, Groups A, B, C and D or in nonexplosive environments and correspond to the following standards: UL Std. 508 - 17th Edition, ANSI/ISA 12.12.01:2015, CSA Std. C22.2 No. 213-16.

2.7.2 Mounting and installation

Devices with explosion protection are to be used as intended and are only permitted to be operated by knowledgeable and qualified personnel according to these operating instructions and the other information contained in the corresponding user's manual. Operation in any other way endangers the safety and functionality of the devices and the connected systems. The operator is responsible for following all applicable safety and accident prevention regulations, as well as adhering to standards.

Devices must be installed in a suitable protective housing that can only be opened by using a tool. In order to guarantee sufficient air circulation, allow the specified amount of space around the device. Use only in environments with pollution degree 2. The maximum ambient temperature varies depending on the individual components being used, see section "[Temperature specifications](#)" on page 31.

The certification marking on the device must be checked before each installation or use of the device in potentially explosive environments. Additional equipment must be suitable for the operating location. Final assembly must be approved by the relevant local authorities. Wiring must follow national regulations and meet all legal requirements.

Devices must remain voltage-free until installation work is complete. The tightening torque for the power supply terminals is 0.5 Nm. Cables must be able to handle a surface temperature of 75°C. AP1000 panels with SDL or SDL3 link module are only permitted to be operated with 24 VDC.

Unshielded/Ungrounded cables are never permitted to be used in potentially explosive areas. Devices must be securely connected to the potential offset. Power supply, communication and accessory cables must be secured on the device or control cabinet. Power supply, communication and accessory cables are not permitted to exert excessive tensile stress on the interfaces. Possible vibrations in the environment must be taken into account for this.

2.7.3 Operation

To switch AP1000 panels with SDL or SDL3 link modules on/off in a potentially explosive area, either the switch must be located outside the explosive area or a switch certified for use in potentially explosive areas must be used.

Danger!

Explosion hazard: Accessories are not permitted to be connected or disconnected with voltage applied unless the area is considered nonhazardous and is free of ignitable concentrations!

Explosion hazard: Replacing components may impair eligibility for Class I, Division 2!

Danger !

Risque d'explosion – Ne pas connecter ou déconnecter un quelconque équipement lorsque le circuit est sous tension, à moins que la zone soit connue comme étant sans risque et sans concentrations inflammables!

Risque d'explosion – Le remplacement de composants peut compromettre l'aptitude au respect de la Classe I, Division 2!

With the exception of USB dongle OTG1000.01 or in line with the requirements set forth in "[USB connection with the Automation Panel 1000](#)", USB interfaces are not certified for operation in potentially explosive areas and may only be used for service purposes.

2.7.4 Maintenance, breakdowns and disassembly

Devices must be shut down and protected against accidental startup. A voltmeter must be used to verify that the power supply is cut off.

Before removing or installing accessories, components or cables, all power supplies to AP1000 panels with SDL or SDL3 link module and power supply must be interrupted. Defective devices must only be replaced by knowledgeable and qualified personnel. Before switching on or connecting the power supply, all covers and system components must be reinstalled and secured.

Danger!

Failure to follow these instructions can result in death, serious injury or damage to property!

Danger !

Le non-respect de ces instructions peut entraîner des blessures graves ou mortelles!

2.7.5 USB connection with the Automation Panel 1000

2.7.5.1 Introduction

The information below describes the use of USB peripheral devices on the front USB interface of the B&R Automation Panel 1000 in Hazardous locations Class I, Division 2, Groups A, B, C and D.

Danger!

DANGER OF EXPLOSION

- Before installation or use in a potentially explosive atmosphere, the explosion protection class of the device must be checked per ANSI/ISA 12.12.01 and CSA C22.2 No. 213.
- The following must be used to switch on/off B&R devices installed in a potentially explosive atmosphere:
 - A switch outside the potentially explosive atmosphere, or
 - A switch that is certified in accordance with the hazardous location class and division for "tube use"
- As long as the electrical circuit is activated, cables or wires are not permitted to be connected or disconnected unless the area is known to be free of ignitable concentrations of vapors, gases and other flammable or combustible materials. This applies to all connections and switches. This includes electrical, ground and network connections as well as series and parallel connections.
- Unshielded/Ungrounded cables are not permitted to be used in potentially explosive atmospheres under any circumstances.
- Only configurations with nonincendive USB devices are permitted to be used.
- Doors and openings on housings must remain closed. This prevents the accumulation of foreign bodies within the workstation.

Failure to follow these instructions can result in death, serious injury or damage to property!

2.7.5.2 Description

Nonincendive devices (keyboards, mouse) are certified for use on the front USB interface of the B&R Automation Panel 1000 (connected device) and are permitted to be connected and disconnected during operation. In addition to the nonincendive property, devices that can be connected to the front USB interface must meet the following criteria.

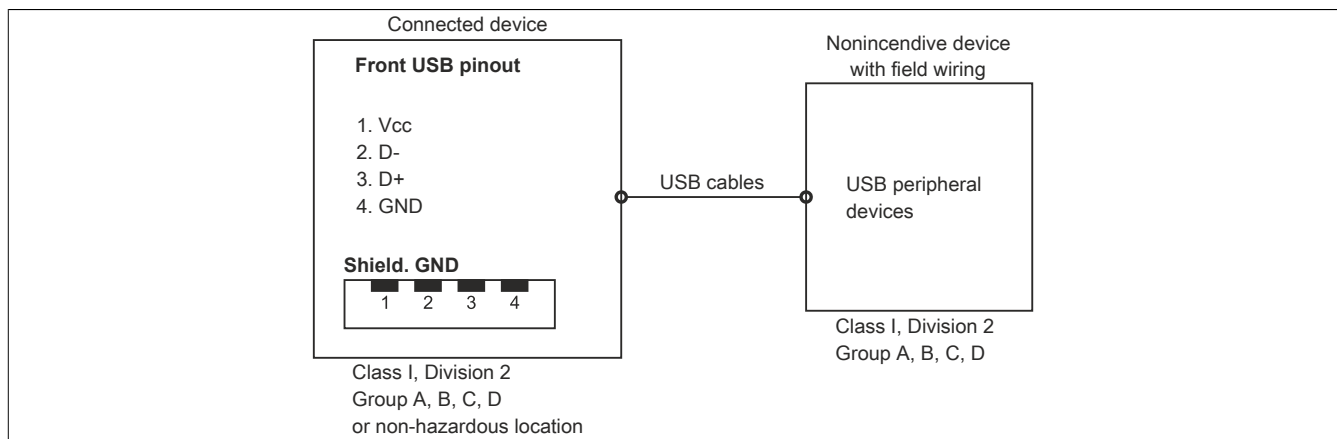

Front USB interface (USB 2.0):	
No-load voltage [V_{oc}]	5.04 V
Short circuit current [I_{sc}]	1170 mA
Associated capacitance [C_a]	20 μ F
Associated inductance [L_a]	16.8 μ H

Table 92: Nonincendive electrical circuit parameters for the front USB interface

The entity concept allows interconnection of nonincendive devices with connected devices with not specifically inspected combinations as a system. For this, the permissible values of V_{oc} (or U_o) and I_{sc} (or I_o) for the connected device must be less than or equal to V_{max} (U_i) and I_{max} (I_i) for the nonincendive device, and the permissible values of C_a (C_o) and L_a (L_o) for the connected device must be greater than or equal to $C_i + C_{Cable}$ and $L_i + L_{Cable}$ for the nonincendive device with field wiring.

The nonincendive device with field wiring must satisfy the following criteria:

B&R device (connected device)	-	Connected nonincendive device with field wiring (mouse, keyboard)
V_{oc}	\leq	V_{max}
I_{sc}	\leq	I_{max}
C_a	\geq	$C_i + C_{Cable}$
L_a	\geq	$L_i + L_{Cable}$

Table 93: Connected nonincendive device with field wiring

If the electrical parameters of the cable are unknown, the following values can be used:

Where $C_{Cable} = 196.85$ pF/m (60 pF/ft), if unknown

Where $L_{Cable} = 0.656$ μ H/m (0.20 μ H/ft), if unknown

Wiring must be performed in accordance with national regulations and the requirements of the authorities.

The B&R device must be installed in a suitable protective housing. For installations in Class I, Division 2 hazardous locations, the housing must be capable of accepting one or more Division 2 wiring methods.

Warning!

- Replacing components may impair eligibility for Division 2 hazardous (classified) locations.
- The device is not permitted to be switched on or off if the area is known to represent an explosion hazard.
- The nonincendive device with field wiring is not permitted to be connected via a parallel connection. This applies unless the device has received express approval for this.

This B&R device is suitable for use in Class I, Division 2, Groups A, B, C and D. In addition, it offers nonincendive field wiring for devices in Class I, Division 2, Groups A, B, C and D.

2.7.6 USB connection with the SDL or SDL3 link module

2.7.6.1 Introduction

The information below describes the use of USB peripheral devices on the USB interfaces on the B&R SDL or SDL3 link module in Hazardous Locations Class I, Division 2, Groups A, B, C and D.

Danger!

DANGER OF EXPLOSION

- Before installation or use in a potentially explosive atmosphere, the explosion protection class of the device must be checked per ANSI/ISA 12.12.01 and CSA C22.2 No. 213.
- The following must be used to switch on/off B&R devices installed in a potentially explosive atmosphere:
 - A switch outside the potentially explosive atmosphere, or
 - A switch that is certified in accordance with the hazardous location class and division for "tube use"
- As long as the electrical circuit is activated, cables or wires are not permitted to be connected or disconnected unless the area is known to be free of ignitable concentrations of vapors, gases and other flammable or combustible materials. This applies to all connections and switches. This includes electrical, ground and network connections as well as series and parallel connections.
- Unshielded/Ungrounded cables are not permitted to be used in potentially explosive atmospheres under any circumstances.
- Only configurations with nonincendive USB devices are permitted to be used.
- Doors and openings on housings must remain closed. This prevents the accumulation of foreign bodies within the workstation.

Failure to follow these instructions can result in death, serious injury or damage to property!

2.7.6.2 Description

Nonincendive devices (keyboards, mouse) are certified for use on the USB interfaces of the B&R SDL or SDL3 link module (connected device) and are permitted to be connected and disconnected during operation. In addition to the nonincendive property, devices that can be connected to the USB interfaces must meet the following criteria.

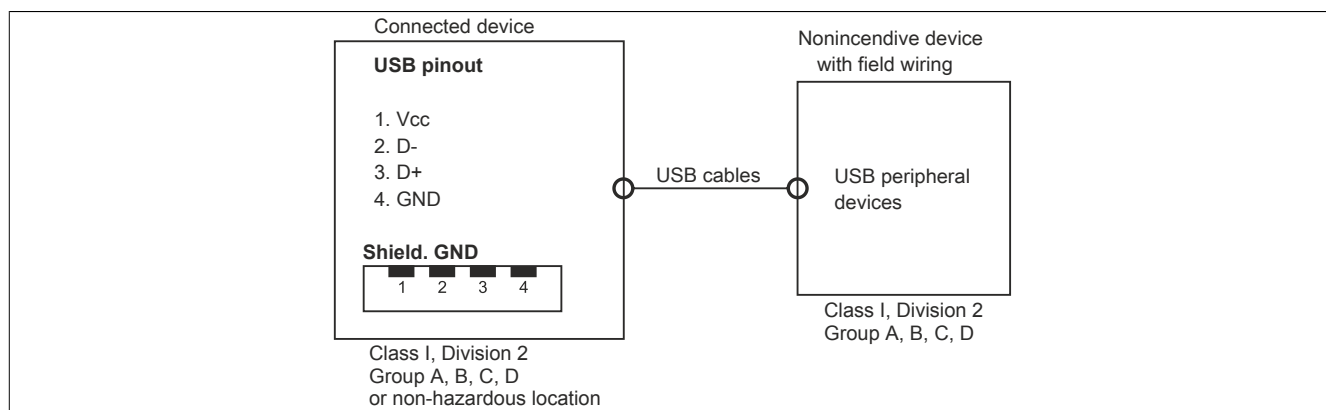

USB interfaces (USB 2.0):	
No load voltage [V _{oc}]	5.12 V
Short circuit current [I _{sc}]	2131 mA
Associated capacitance [C _a]	20 μF
Associated inductance [L _a]	16.8 μH

Table 94: Nonincendive circuit parameters for the USB interfaces

The entity concept allows interconnection of nonincendive devices with connected devices with not specifically inspected combinations as a system. For this, the permissible values of V_{oc} (or U_o) and I_{sc} (or I_o) for the connected device must be less than or equal to V_{max} (U_i) and I_{max} (I_i) for the nonincendive device, and the permissible values of C_a (C_o) and L_a (L_o) for the connected device must be greater than or equal to $C_i + C_{Cable}$ and $L_i + L_{Cable}$ for the nonincendive device with field wiring.

The nonincendive device with field wiring must satisfy the following criteria:

B&R device (connected device)	-	Connected nonincendive device with field wiring (mouse, keyboard)
V_{oc}	\leq	V_{max}
I_{sc}	\leq	I_{max}
C_a	\geq	$C_i + C_{Cable}$
L_a	\geq	$L_i + L_{Cable}$

Table 95: Connected nonincendive device with field wiring

If the electrical parameters of the cable are unknown, the following values can be used:

Where $C_{Cable} = 196.85$ pF/m (60 pF/ft), if unknown

Where $L_{Cable} = 0.656$ μ H/m (0.20 μ H/ft), if unknown

Wiring must be performed in accordance with national regulations and the requirements of the authorities.

The B&R device must be installed in a suitable protective housing. For installations in Class I, Division 2 hazardous locations, the housing must be capable of accepting one or more Division 2 wiring methods.

Warning!

- Replacing components may impair eligibility for Division 2 hazardous (classified) locations.
- The device is not permitted to be switched on or off if the area is known to represent an explosion hazard.
- The nonincendive device with field wiring is not permitted to be connected via a parallel connection. This applies unless the device has received express approval for this.

This B&R device is suitable for use in Class I, Division 2, Groups A, B, C and D. In addition, it offers nonincendive field wiring for devices in Class I, Division 2, Groups A, B, C and D.

Chapter 6 • Accessories

The functionality of the following accessories has been tested and approved by B&R in connection with this device. Nevertheless, there may be possible limitations with regard to operation with other individual components as part of the complete system. For the operation of the complete system, all individual specifications of the components must be observed.

All components listed in this manual have been subjected to extensive system and compatibility testing and approved accordingly. B&R cannot guarantee the functionality of non-approved accessories.

1 Power connectors

1.1 0TB103.9x

1.1.1 General information

This 1-row, 3-pin 0TB103 terminal block is used for the power supply.

1.1.2 Order data

Model number	Short description	Figure
	Accessories	
0TB103.9	Connector 24 VDC - 3-pin female - Screw clamp terminal block 3.31 mm ²	
0TB103.91	Connector 24 VDC - 3-pin female - Cage clamp terminal block 3.31 mm ²	

Table 96: 0TB103.9, 0TB103.91 - Order data

1.1.3 Technical data

Information:

The following specifications, properties and limit values apply only to this accessory and may deviate from those that apply to the complete system. For the complete system in which this accessory is installed, for example, the data specified for that complete system applies.

Model number	0TB103.9	0TB103.91
General information		
Certification	Yes	
CE	cULus E115267	
UL	Industrial control equipment	
HazLoc	cULus HazLoc E180196 Industrial control equipment for hazardous locations Class I, Division 2, Groups ABCD, T4 ¹⁾	
DNV GL	Temperature: B (0 - 55°C) Humidity: B (up to 100%) Vibration: A (0.7 g) EMC: B (Bridge and open deck) ²⁾	
Terminal block		
Note	Protected against vibration by the screw flange Nominal values according to UL	
Number of pins	3 (female)	
Type of terminal block	Screw clamp terminal block	Cage clamp terminal block ³⁾
Cable type	Only copper wires (no aluminum wires!)	
Distance between contacts	5.08 mm	

Table 97: 0TB103.9, 0TB103.91 - Technical data

Model number	0TB103.9	0TB103.91
Connection cross section		
AWG wire	26 to 14 AWG	26 to 12 AWG
Wire end sleeves with plastic covering		0.20 to 1.50 mm ²
Solid wires		0.20 to 2.50 mm ²
Fine strand wires	0.20 to 1.50 mm ²	0.20 to 2.50 mm ²
With wire end sleeves		0.20 to 1.50 mm ²
Tightening torque	0.4 Nm	-
Electrical characteristics		
Nominal voltage		300 V
Nominal current ⁴⁾		10 A / contact
Contact resistance		≤5 mΩ
Operating conditions		
EN 61131 pollution degree		Pollution degree 2

Table 97: 0TB103.9, 0TB103.91 - Technical data

- 1) Yes, although applies only if all components installed within the complete system have this certification and the complete system itself carries the corresponding mark.
- 2) Yes, although applies only if all components installed in the complete system have this certification and are listed on the associated DNV GL certificate for the product family.
- 3) Cage clamp terminal blocks cannot be used side-by-side.
- 4) The limit data for each I/O module must be taken into consideration.

2 USB flash drives

2.1 5MMUSB.xxxx-01

2.1.1 General information

USB flash drives are easily exchangeable data storage devices. Because of their high-speed data transfer (USB 2.0), USB flash drives are ideal for use as portable storage media. Without additional drivers ("hot plugging", except in Windows 98SE), the USB flash drive is immediately registered as a drive for reading and writing data.

Information:

Due to the large number of USB flash drives available on the market as well as their short product lifecycle, we reserve the right to provide alternative products. The following measures may therefore be necessary in order to also boot from these USB flash drives:

- The USB flash drive must be reformatted or in some cases also repartitioned (set partition as active).
- The USB flash drive must be in the first position of the BIOS boot order; alternatively, the IDE controllers can be disabled in BIOS. This can be avoided in most cases if command "fdisk / mbr" is additionally executed on the USB flash drive.

2.1.2 Order data

Model number	Short description	Figure
	USB accessories	
5MMUSB.2048-01	USB 2.0 flash drive 2048 MB B&R	
5MMUSB.4096-01	USB 2.0 flash drive 4096 MB B&R	

Table 98: 5MMUSB.2048-01, 5MMUSB.4096-01 - Order data

2.1.3 Technical data

Information:

The following specifications, properties and limit values apply only to this accessory and may deviate from those that apply to the complete system. For the complete system in which this accessory is installed, for example, the data specified for that complete system applies.

Model number	5MMUSB.2048-01	5MMUSB.4096-01
General information		
Capacity	2 GB	4 GB
LED status indicators	1 LED (green) ¹⁾	
MTBF	>3,000,000 hours	
Type	USB 1.1, USB 2.0	
Maintenance	None	
Default file system	FAT32	
Certification		
CE	Yes	
GOST-R	Yes	
Interfaces		
USB		
Type	USB 1.1, USB 2.0	
Connection	To any USB type A interface	
Transfer rate	Low speed (1.5 Mbit/s), full speed (12 Mbit/s), high speed (480 Mbit/s)	
Sequential reading	Full speed max. 1 MB/s, high speed max. 32 MB/s	
Sequential writing	Full speed max. 0.9 MB/s, high speed max. 23 MB/s	
Endurance		
SLC flash	Yes	
Data retention	>10 years	
Data reliability	<1 unrecoverable error per 10 ¹⁴ bits read	
Connection cycles	>1500	

Table 99: 5MMUSB.2048-01, 5MMUSB.4096-01 - Technical data

Model number	5MMUSB.2048-01	5MMUSB.4096-01
Support		
Operating systems		
Windows 7		Yes
Windows XP Professional		Yes
Windows XP Embedded		Yes
Windows ME		Yes
Windows 2000		Yes
Windows CE 5.0		Yes
Windows CE 4.2		Yes
Electrical characteristics		
Current consumption	Max. 500 µA in sleep mode, max. 120 mA read/write	
Environmental conditions		
Temperature		
Operation	0 to 70°C	
Storage	-50 to 100°C	
Transport	-50 to 100°C	
Relative humidity		
Operation	85%, non-condensing	
Storage	85%, non-condensing	
Transport	85%, non-condensing	
Vibration		
Operation	20 to 2000 Hz: 20 g (peak)	
Storage	20 to 2000 Hz: 20 g (peak)	
Transport	20 to 2000 Hz: 20 g (peak)	
Shock		
Operation	Max. 1500 g (peak)	
Storage	Max. 1500 g (peak)	
Transport	Max. 1500 g (peak)	
Elevation		
Operation	Max. 3048 m	
Storage	Max. 12192 m	
Transport	Max. 12192 m	
Mechanical characteristics		
Dimensions		
Width	17.97 mm	
Length	67.85 mm	
Height	8.35 mm	

Table 99: 5MMUSB.2048-01, 5MMUSB.4096-01 - Technical data

1) Indicates data transfer (receiving and transmitting).

2.1.4 Temperature/Humidity diagram

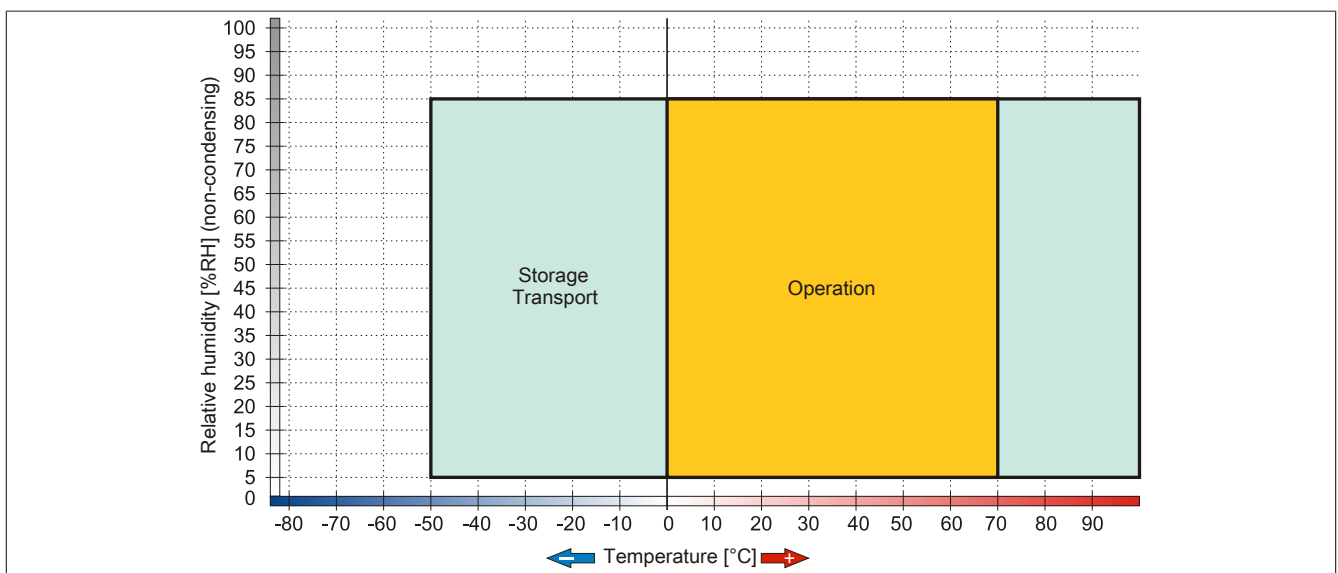

Figure 103: 5MMUSB.xxxx-01 - Temperature/Humidity diagram

2.2 5MMUSB.032G-02

2.2.1 General information

USB flash drives are easily exchangeable data storage devices. Because of their high-speed data transfer (USB 3.0), USB flash drives are ideal for use as portable storage media. Without additional drivers ("hot plugging", except in Windows 98SE), the USB flash drive is immediately registered as a drive for reading and writing data. USB 3.0 (XHCI) is supported starting with Windows 7 (USB 3.0 driver required).

Information:

Due to the large number of USB flash drives available on the market as well as their short product lifecycle, we reserve the right to provide alternative products. The following measures may therefore be necessary in order to also boot from these USB flash drives:

- The USB flash drive must be reformatted or in some cases also repartitioned (set partition as active).
- The USB flash drive must be in the first position of the BIOS boot order; alternatively, the IDE controllers can be disabled in BIOS. This can be avoided in most cases if command "fdisk / mbr" is additionally executed on the USB flash drive.

2.2.2 Order data

Model number	Short description	Figure
	USB accessories	
5MMUSB.032G-02	USB 3.0 flash drive 32 GB MLC	

Table 100: 5MMUSB.032G-02 - Order data

2.2.3 Technical data

Information:

The following specifications, properties and limit values apply only to this accessory and may deviate from those that apply to the complete system. For the complete system in which this accessory is installed, for example, the data specified for that complete system applies.

Model number	5MMUSB.032G-02
General information	
Capacity	32 GB
LED status indicators	1 LED (green) ¹⁾
MTBF	>3,000,000 hours
Type	USB 2.0, USB 3.0
Maintenance	None
Certification	
CE	Yes
Interfaces	
USB	
Type	USB 2.0, USB 3.0
Connection	To any USB type A interface
Transfer rate	High speed (480 Mbit/s) to SuperSpeed (4 Gbit/s)
Sequential reading	USB 3.0 max. 100 MB/s
Sequential writing	USB 3.0 max. 50 MB/s
Endurance	
MLC flash	Yes
Data reliability	<1 unrecoverable error per 10 ¹⁴ bits read
Connection cycles	>1500
Electrical characteristics	
Current consumption	Max. 67 mA in sleep mode, max. 122 mA read, max. 141 mA write
Environmental conditions	
Temperature	
Operation	0 to 70°C
Storage	-55 to 95°C
Transport	-55 to 95°C

Table 101: 5MMUSB.032G-02 - Technical data

Model number	5MMUSB.032G-02
Relative humidity	
Operation	10 to 95%, non-condensing
Storage	10 to 95%, non-condensing
Transport	10 to 95%, non-condensing
Vibration	
Operation	7 to 2000 Hz: 20 g
Storage	7 to 2000 Hz: 20 g
Transport	7 to 2000 Hz: 20 g
Shock	
Operation	1500g, 0.5 ms
Storage	1500g, 0.5 ms
Transport	1500g, 0.5 ms
Elevation	
Operation	Max. 3048 m
Storage	Max. 12192 m
Transport	Max. 12192 m
Mechanical characteristics	
Dimensions	
Width	16.58 mm
Length	48.30 mm
Height	7.60 mm
Weight	10 g
Manufacturer information	
Manufacturer	Innodisk
Manufacturer's product ID	DEUA1-32G161BCH88 (USB drive 3ME)

Table 101: 5MMUSB.032G-02 - Technical data

1) Indicates data transfer (receiving and transmitting).

2.2.4 Temperature/Humidity diagram

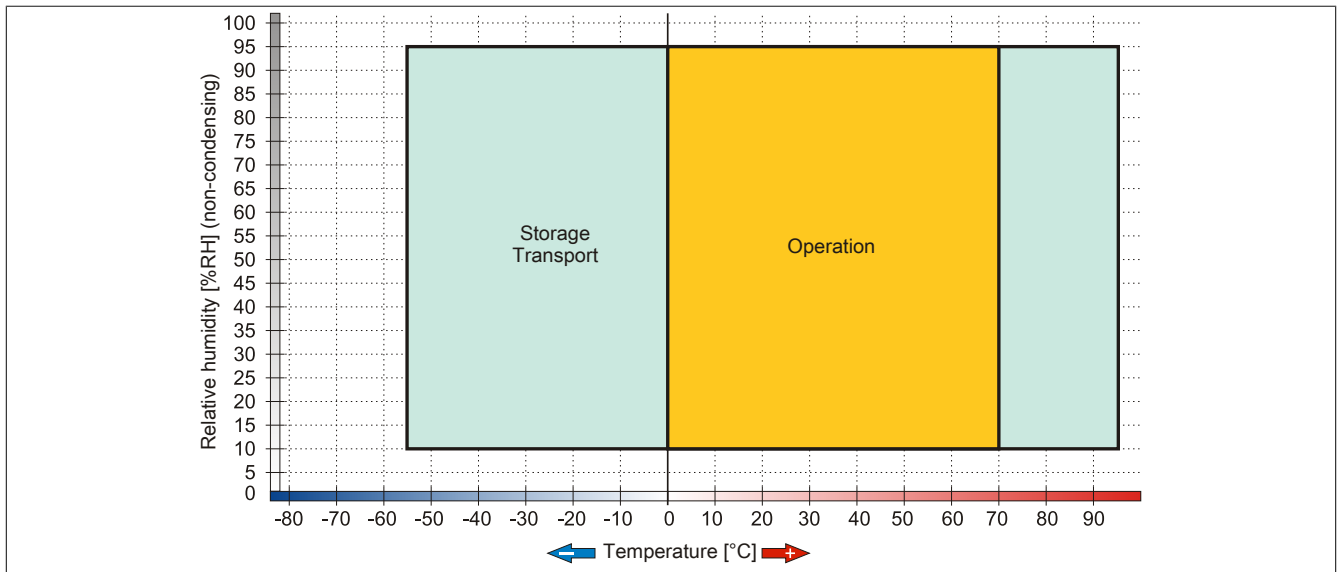

Figure 104: 5MMUSB.032G-02 - Temperature/Humidity diagram

3 Cables

3.1 DVI cables

3.1.1 5CADVI.0xxx-00

3.1.1.1 General information

5CADVI.0xxx-00 DVI cables are designed for use in fixed installations.

Caution!

The cable is only permitted to be connected or disconnected when the power is switched off.

3.1.1.2 Order data

Model number	Short description	Figure
	DVI cables	
5CADVI.0018-00	DVI-D cable - 1.8 m	
5CADVI.0050-00	DVI-D cable - 5 m	
5CADVI.0100-00	DVI-D cable - 10 m	

Table 102: 5CADVI.0018-00, 5CADVI.0050-00, 5CADVI.0100-00 - Order data

3.1.1.3 Technical data

Information:

The following specifications, properties and limit values apply only to this accessory and may deviate from those that apply to the complete system. For the complete system in which this accessory is installed, for example, the data specified for that complete system applies.

Model number	5CADVI.0018-00	5CADVI.0050-00	5CADVI.0100-00
General information			
Certifications			
CE	Yes		
UL	cULus E115267 Industrial control equipment		
DNV GL	Temperature: B (0 - 55°C) Humidity: B (up to 100%) Vibration: A (0.7 g) EMC: B (Bridge and open deck) ¹⁾		
GOST-R	Yes		
Cable construction			
Wire cross section	28 AWG		
Shield	Individual cable pairs, entire cable		
Complete shielding	Tinned copper braiding, optical coverage >86%		
Outer jacket			
Material	PVC		
Color	Beige		
Labeling	AWM STYLE 20276 80°C 30 V VW1 DVI DIGITAL SINGLE LINK DER AN		
Connector			
Type	2x DVI-D (18+1), male		
Connection cycles	100		
Locating screw tightening torque	Max. 0.5 Nm		
Electrical characteristics			
Conductor resistance	Max. 237 Ω/km		
Insulation resistance	Min. 100 MΩ/km		
Operating conditions			
Pollution degree per EN 61131	Pollution degree 2		
Mechanical characteristics			
Dimensions			
Length	1.8 m ±50 mm	5 m ±80 mm	10 m ±100 mm
Diameter	Max. 8.5 mm		
Bend radius	≥5x cable diameter (male connector - ferrite bead and ferrite bead - ferrite bead)		
Weight	Approx. 260 g	Approx. 460 g	Approx. 790 g

Table 103: 5CADVI.0018-00, 5CADVI.0050-00, 5CADVI.0100-00 - Technical data

1) Yes, although applies only if all components installed in the complete system have this certification and are listed on the associated DNV GL certificate for the product family.

3.1.1.4 Bend radius specifications

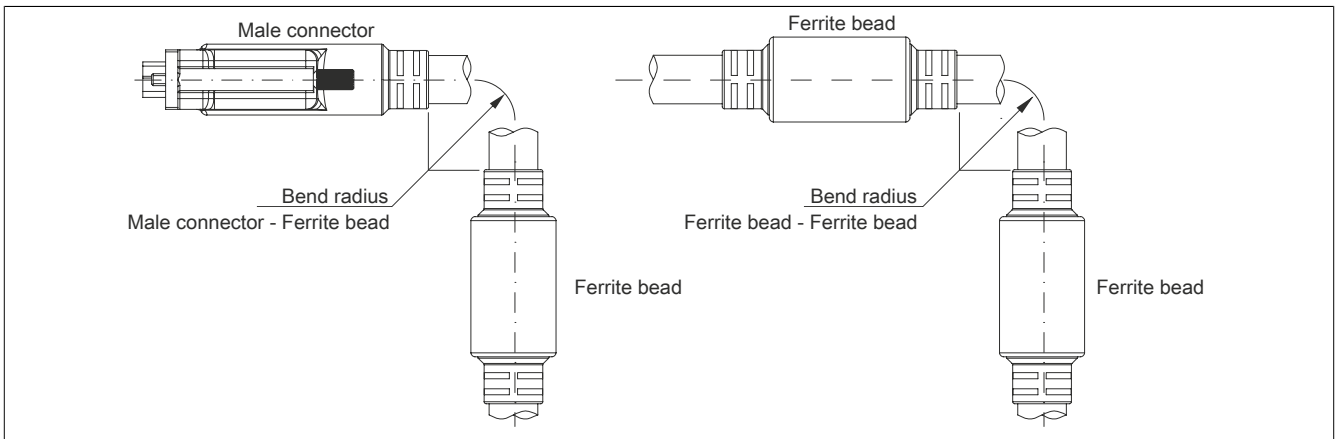

Figure 105: Bend radius specifications

3.1.1.5 Dimensions

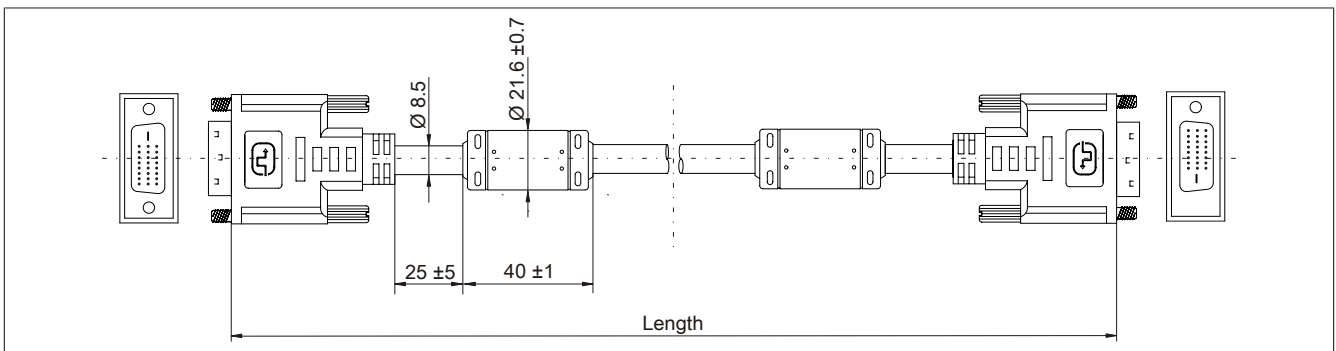

Figure 106: 5CADVI.0xxx-00 - Dimensions

3.1.1.6 Cable pinout

Warning!

If a field-assembled cable is desired, it must be wired according to this pinout.

If a field-assembled cable is used, B&R cannot make any guarantee as to its functionality. Functionality is only ensured with cables provided by B&R.

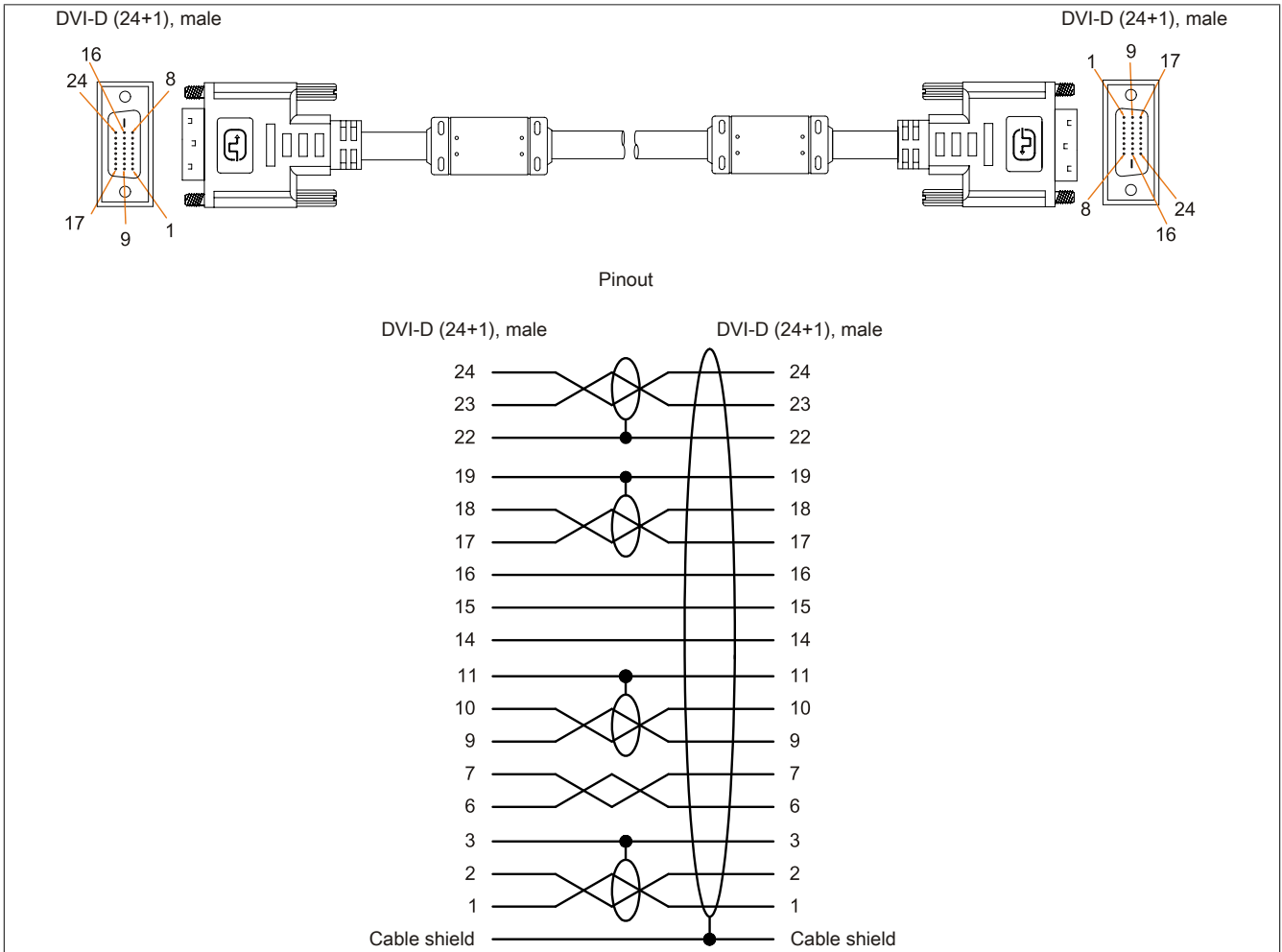

Figure 107: 5CADVI.0xxx-00 - Pinout

3.2 SDL cables

3.2.1 5CASDL.0xxx-00

3.2.1.1 General information

5CASDL.0xxx-00 SDL cables are designed for use in fixed installations. 5CASDL.0xxx-03 SDL flex cables are required for flexible installations (e.g. swing arm systems).

Caution!

The cable is only permitted to be connected or disconnected when the power is switched off.

3.2.1.2 Order data

Model number	Short description	Figure
	SDL cables	
5CASDL.0008-00	SDL cable - 0.8 m	
5CASDL.0018-00	SDL cable - 1.8 m	
5CASDL.0050-00	SDL cable - 5 m	
5CASDL.0100-00	SDL cable - 10 m	
5CASDL.0150-00	SDL cable - 15 m	
5CASDL.0200-00	SDL cable - 20 m	
5CASDL.0250-00	SDL cable - 25 m	
5CASDL.0300-00	SDL cable - 30 m	

Table 104: 5CASDL.0008-00, 5CASDL.0018-00, 5CASDL.0050-00, 5CASDL.0100-00, 5CASDL.0150-00, 5CASDL.0200-00, 5CASDL.0250-00, 5CASDL.0300-00 - Order data

3.2.1.3 Technical data

Information:

The following specifications, properties and limit values apply only to this accessory and may deviate from those that apply to the complete system. For the complete system in which this accessory is installed, for example, the data specified for that complete system applies.

Model number	5CASDL.0008-00	5CASDL.0018-00	5CASDL.0050-00	5CASDL.0100-00	5CASDL.0150-00	5CASDL.0200-00	5CASDL.0250-00	5CASDL.0300-00
General information								
Certification	Yes							
CE	Yes							
UL	cULus E115267 Industrial control equipment							
HazLoc	cULus HazLoc E180196 Industrial control equipment for hazardous locations Class I, Division 2, Groups ABCD, T4 ¹⁾					cULus HazLoc E180196 Industrial control equipment for hazardous locations Class I, Division 2, Groups ABCD, T4 ²⁾		
DNV GL	Temperature: B (0 - 55°C) Humidity: B (up to 100%) Vibration: A (0.7 g) EMC: B (Bridge and open deck) ³⁾							
GOST-R	-	Yes						
Cable construction								
Wire cross section	28 AWG	AWG 28	28 AWG	AWG 24		24 AWG	AWG 24	
Shield	Individual cable pairs, entire cable							
Complete shielding	Tinned copper braiding, optical coverage >85%							
Outer sheathing								
Material	PVC							
Color	Black							
Labeling	E74020-C (UL) AWM STYLE 20176 80°C 30V VW-1 DVI DIGITAL LINK							
Connector								
Type	2x DVI-D (24+1), male							
Connection cycles	100							
Contacts	Gold-plated							
Mechanical protection	Metal cover with crimped strain relief	Metal cover with crimped stress relief	Metal cover with crimped strain relief	Metal cover with crimped stress relief			Metal cover with crimped strain relief	Metal cover with crimped stress relief
Locating screw tightening torque	Max. 0.5 Nm							

Table 105: 5CASDL.0008-00, 5CASDL.0018-00, 5CASDL.0050-00, 5CASDL.0100-00, 5CASDL.0150-00, 5CASDL.0200-00, 5CASDL.0250-00, 5CASDL.0300-00 - Technical data

Model number	5CASDL.0008-00	5CASDL.0018-00	5CASDL.0050-00	5CASDL.0100-00	5CASDL.0150-00	5CASDL.0200-00	5CASDL.0250-00	5CASDL.0300-00
Electrical characteristics								
Conductor resistance	-		≤93 Ω/km					
24 AWG	-		-					
28 AWG	≤237 Ω/km		-					
Insulation resistance	Min. 10 MΩ/km							
Operating conditions								
EN 61131 pollution degree	Pollution degree 2							
Mechanical characteristics								
Dimensions								
Length	0.8 m ±25 mm	1.8 m ±30 mm	5 m ±30 mm	10 m ±50 mm	15 m ±100 mm	20 m ±100 mm	25 m ±100 mm	30 m ±100 mm
Diameter	Typ. 8.6 ±0.2 mm Max. 9 mm			Typ. 11 ±0.2 mm Max. 11.5 mm				
Bend radius	≥5x cable diameter (male connector - ferrite bead and ferrite bead - ferrite bead)							
Flexibility	Limited flexibility, valid for ferrite bead - ferrite bead (tested 100 cycles with 5x cable diameter, 20 cycles/minute)							
Weight	Approx. 206 g	Approx. 300 g	Approx. 580 g	Approx. 1500 g	Approx. 2250 g	Approx. 2880 g	Approx. 4800 g	Approx. 5520 g

Table 105: 5CASDL.0008-00, 5CASDL.0018-00, 5CASDL.0050-00, 5CASDL.0100-00, 5CASDL.0150-00, 5CASDL.0200-00, 5CASDL.0250-00, 5CASDL.0300-00 - Technical data

- 1) Yes, although applies only if all components installed within the complete system have this certification and the complete system itself carries the corresponding mark.
- 2) Yes, although applies only if all components installed in the complete system have this certification and the complete system bears the corresponding mark.
- 3) Yes, although applies only if all components installed in the complete system have this certification and are listed on the associated DNV GL certificate for the product family.

3.2.1.4 Bend radius specifications

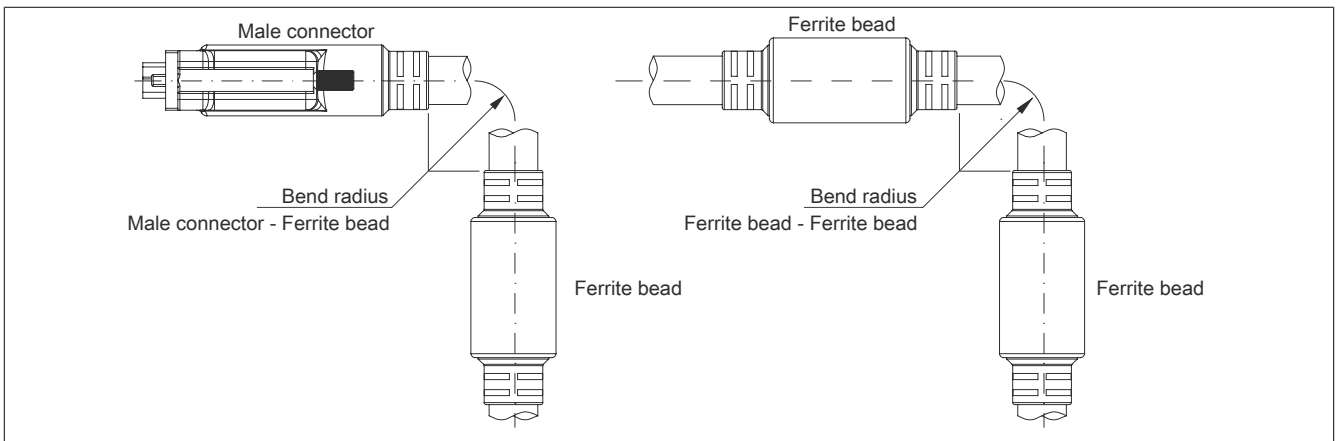

Figure 108: Bend radius specifications

3.2.1.5 Dimensions

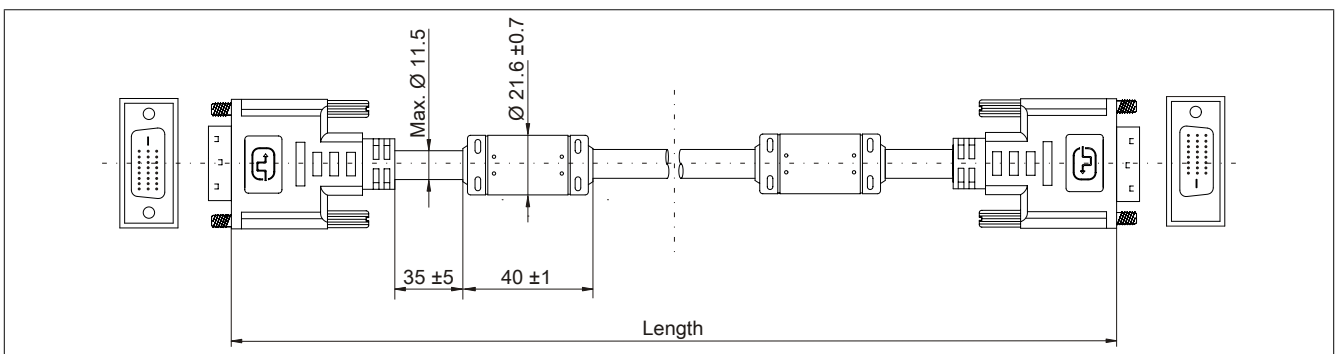

Figure 109: 5CASDL.0xxx-00 - Dimensions

3.2.1.6 Cable pinout

Warning!

If a field-assembled cable is desired, it must be wired according to this pinout.

If a field-assembled cable is used, B&R cannot make any guarantee as to its functionality. Functionality is only ensured with cables provided by B&R.

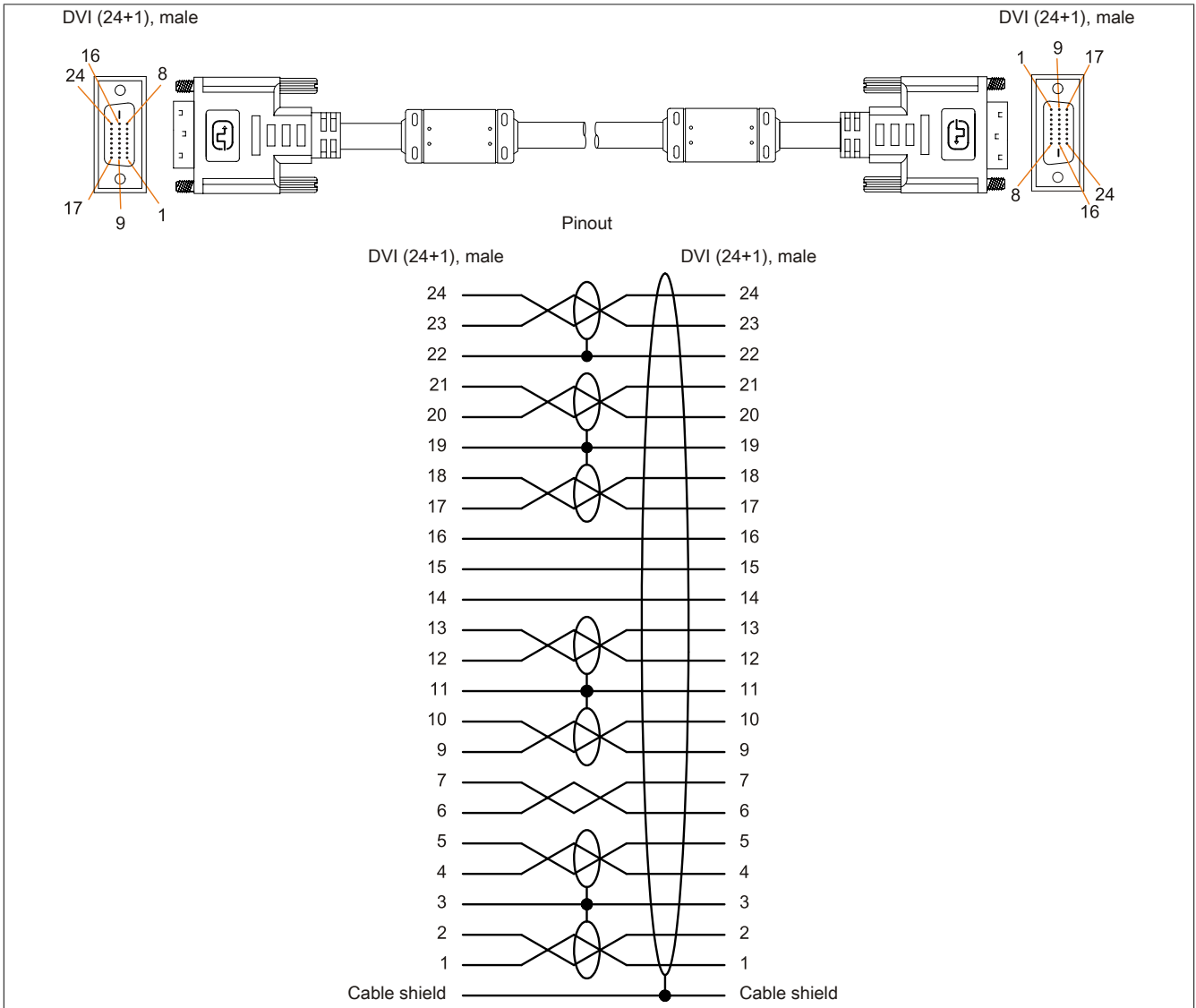

Figure 110: 5CASDL.0xxx-00 - Pinout

3.3 SDL cables with 45° male connector

3.3.1 5CASDL.0xxx-01

3.3.1.1 General information

5CASDL.0xxx-01 SDL cables with 45° connector are designed for use in fixed installations.

Caution!

The cable is only permitted to be connected or disconnected when the power is switched off.

3.3.1.2 Order data

Model number	Short description	Figure
	SDL cables 45° connection	
5CASDL.0018-01	SDL cable - 45 degree connector - 1.8 m	
5CASDL.0050-01	SDL cable - 45 degree connector - 5 m	
5CASDL.0100-01	SDL cable - 45 degree connector - 10 m	
5CASDL.0150-01	SDL cable - 45 degree connector - 15 m	

Table 106: 5CASDL.0018-01, 5CASDL.0050-01, 5CASDL.0100-01, 5CASDL.0150-01 - Order data

3.3.1.3 Technical data

Information:

The following specifications, properties and limit values apply only to this accessory and may deviate from those that apply to the complete system. For the complete system in which this accessory is installed, for example, the data specified for that complete system applies.

Model number	5CASDL.0018-01	5CASDL.0050-01	5CASDL.0100-01	5CASDL.0150-01
General information				
Certifications				
CE	Yes			
UL	cULus E115267 Industrial control equipment			
HazLoc	cULus HazLoc E180196 Industrial control equipment for hazardous locations Class I, Division 2, Groups ABCD, T4 ¹⁾	cULus HazLoc E180196 Industrial control equipment for hazardous locations Class I, Division 2, Groups ABCD, T4 ²⁾	cULus HazLoc E180196 Industrial control equipment for hazardous locations Class I, Division 2, Groups ABCD, T4 ¹⁾	
DNV GL	Temperature: B (0 - 55°C) Humidity: B (up to 100%) Vibration: A (0.7 g) EMC: B (Bridge and open deck) ³⁾			
GOST-R	Yes			
Cable construction				
Wire cross section	28 AWG		24 AWG	
Shield	Individual cable pairs, entire cable			
Complete shielding	Tinned copper braiding, optical coverage >85%			
Outer jacket				
Material	PVC			
Color	Black			
Connector				
Type	2x DVI-D (24+1), male			
Connection cycles	100			
Contacts	Gold-plated			
Mechanical protection	Metal cover with crimped strain relief			
Locating screw tightening torque	Max. 0.5 Nm			
Electrical characteristics				
Conductor resistance				
24 AWG	-		≤93 Ω/km	
28 AWG	≤237 Ω/km		-	
Insulation resistance	Min. 10 MΩ/km			
Operating conditions				
Pollution degree per EN 61131	Pollution degree 2			
Mechanical characteristics				
Dimensions				
Length	1.8 m ±30 mm	5 m ±50 mm	10 m ±100 mm	15 m ±100 mm
Diameter	Max. 9 mm		Max. 11.5 mm	

Table 107: 5CASDL.0018-01, 5CASDL.0050-01, 5CASDL.0100-01, 5CASDL.0150-01 - Technical data

Model number	5CASDL.0018-01	5CASDL.0050-01	5CASDL.0100-01	5CASDL.0150-01
Bend radius				
Fixed installation	≥5x cable diameter (male connector - ferrite bead and ferrite bead - ferrite bead)			
Flexibility	Limited flexibility, valid for ferrite bead - ferrite bead (tested 100 cycles with 5x cable diameter, 20 cycles/minute)			
Weight	Approx. 300 g	Approx. 590 g	Approx. 2800 g	Approx. 2860 g

Table 107: 5CASDL.0018-01, 5CASDL.0050-01, 5CASDL.0100-01, 5CASDL.0150-01 - Technical data

- 1) Yes, although applies only if all components installed in the complete system have this certification and the complete system bears the corresponding mark.
- 2) Yes, although applies only if all components installed within the complete system have this certification and the complete system itself carries the corresponding mark.
- 3) Yes, although applies only if all components installed in the complete system have this certification and are listed on the associated DNV GL certificate for the product family.

3.3.1.4 Bend radius specifications

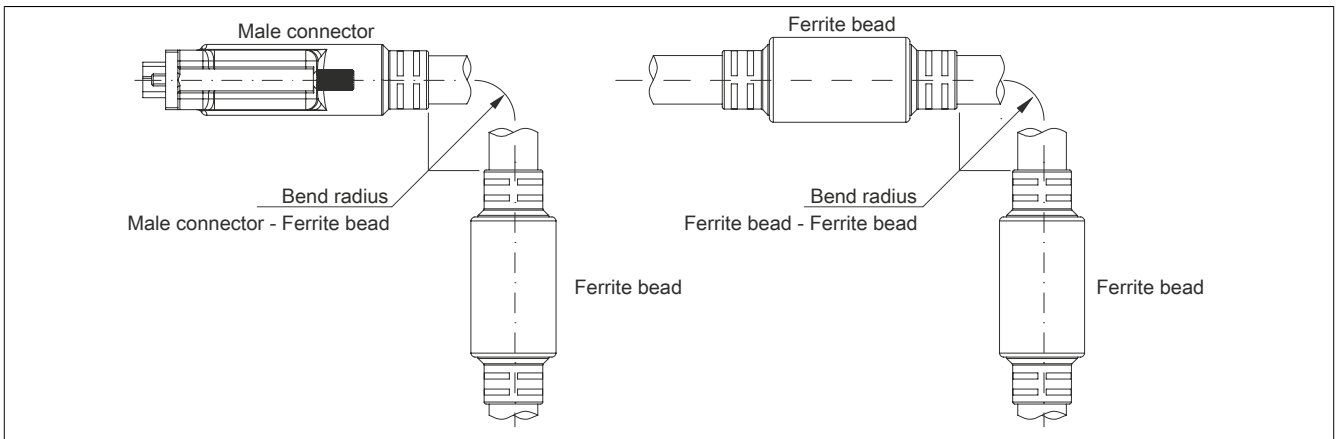

Figure 111: Bend radius specifications

3.3.1.5 Dimensions

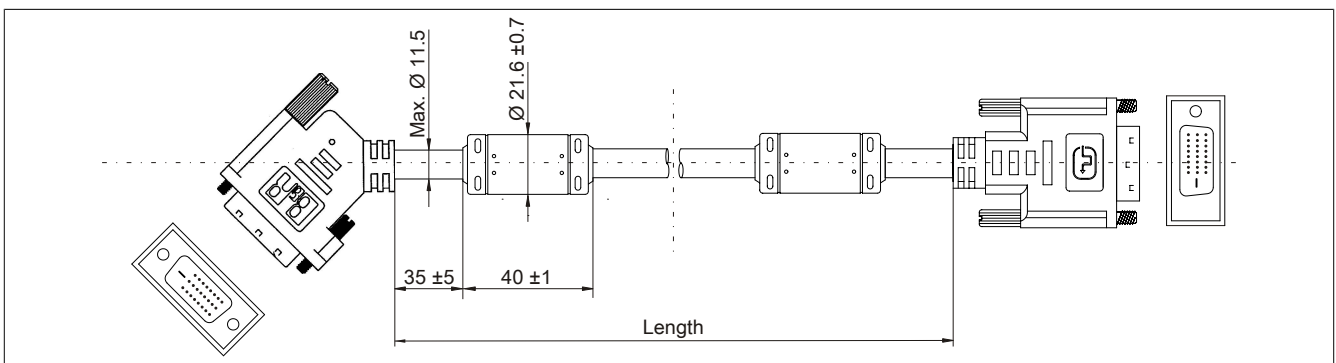

Figure 112: 5CASDL.0xxx-01 - Dimensions

3.3.1.6 Cable pinout

Warning!

If a field-assembled cable is desired, it must be wired according to this pinout.

If a field-assembled cable is used, B&R cannot make any guarantee as to its functionality. Functionality is only ensured with cables provided by B&R.

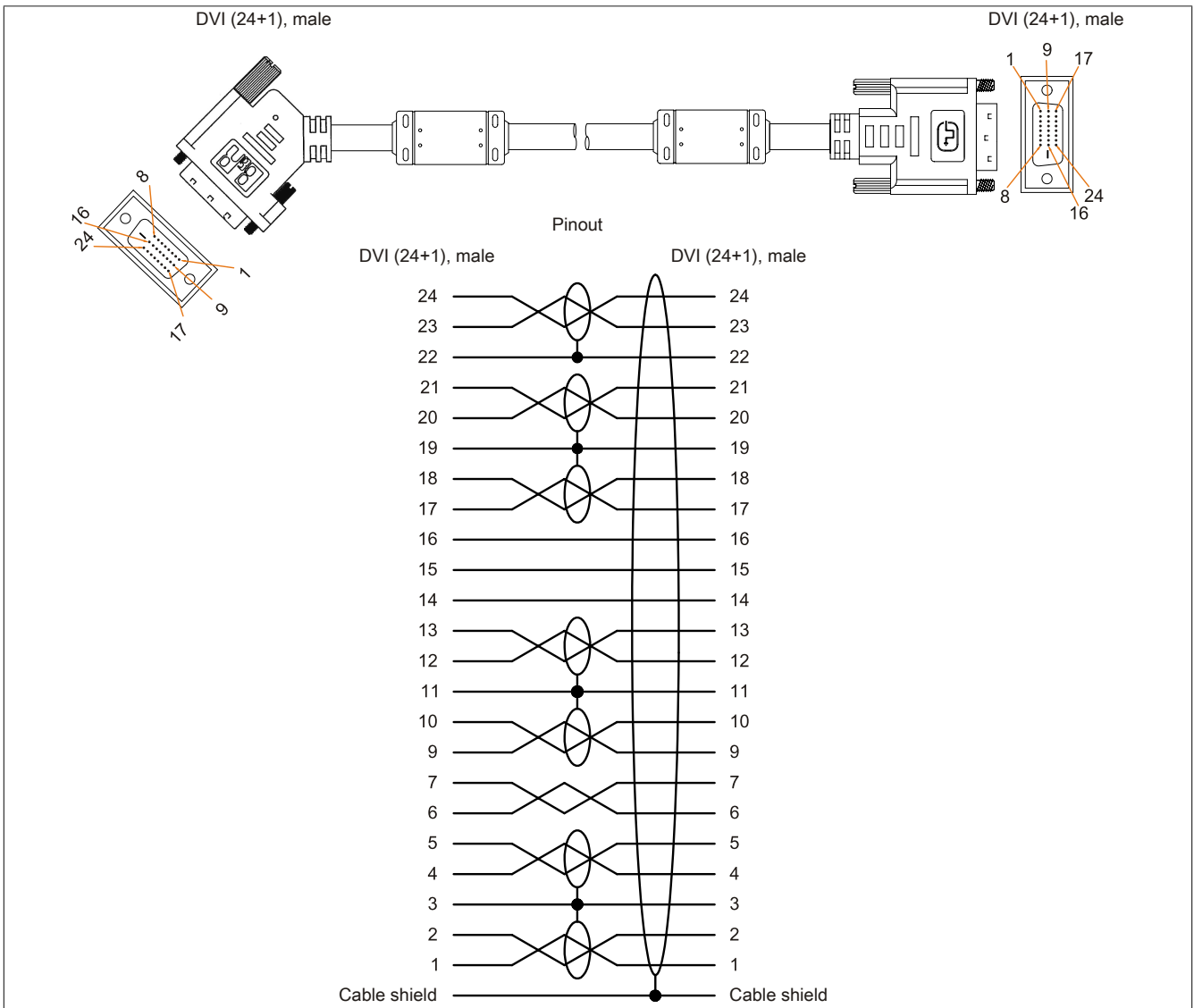

Figure 113: 5CASDL.0xxx-01 - Pinout

3.4 SDL flex cables

3.4.1 5CASDL.0xxx-03

3.4.1.1 General information

5CASDL.0xxx-03 SDL flex cables are designed for use in both fixed and flexible installations (e.g. swing arm systems).

Caution!

The cable is only permitted to be connected or disconnected when the power is switched off.

3.4.1.2 Order data

Model number	Short description	Figure
	SDL cables flex	
5CASDL.0018-03	SDL flex cable - 1.8 m	
5CASDL.0050-03	SDL flex cable - 5 m	
5CASDL.0100-03	SDL flex cable - 10 m	
5CASDL.0150-03	SDL flex cable - 15 m	
5CASDL.0200-03	SDL flex cable - 20 m	
5CASDL.0250-03	SDL flex cable - 25 m	
5CASDL.0300-03	SDL flex cable - 30 m	

Table 108: 5CASDL.0018-03, 5CASDL.0050-03, 5CASDL.0100-03, 5CASDL.0150-03, 5CASDL.0200-03, 5CASDL.0250-03, 5CASDL.0300-03 - Order data

3.4.1.3 Technical data

Information:

The following specifications, properties and limit values apply only to this accessory and may deviate from those that apply to the complete system. For the complete system in which this accessory is installed, for example, the data specified for that complete system applies.

Model number	5CASDL.0018-03	5CASDL.0050-03	5CASDL.0100-03	5CASDL.0150-03	5CASDL.0200-03	5CASDL.0250-03	5CASDL.0300-03
General information							
Certifications	Yes						
CE	Yes						
UL	cULus E115267 Industrial control equipment						
HazLoc	cULus HazLoc E180196 Industrial control equipment for hazardous locations Class I, Division 2, Groups ABCD, T4 ¹⁾		cULus HazLoc E180196 Industrial control equipment for hazardous locations Class I, Division 2, Groups ABCD, T4 ²⁾				
DNV GL	Temperature: B (0 - 55°C) Humidity: B (up to 100%) Vibration: A (0.7 g) EMC: B (Bridge and open deck) ³⁾						
GOST-R	Yes						
Cable construction							
Wire cross section	24 AWG (control wires) 26 AWG (DVI, USB, data)	AWG 24 (control wires) AWG 26 (DVI, USB, data)	24 AWG (control wires) 26 AWG (DVI, USB, data)				
Properties	Silicone- and halogen-free						
Shield	Individual cable pairs, entire cable						
Complete shielding	Aluminum-clad foil and tinned copper braiding						
Outer jacket							
Material	Special semi-glossy TMPU	Special semi-matte TMPU	Special semi-glossy TMPU	Special semi-matte TMPU			
Color	Black						
Labeling	(B&R) SDL Cable (UL) AWM 20236 80°C 30V E 63216	(B&R) SDL cable (UL) AWM 20236 80°C 30 V E 63216	(B&R) SDL Cable (UL) AWM 20236 80°C 30V E 63216	(B&R) SDL cable (UL) AWM 20236 80°C 30 V E 63216			
Connector							
Type	2x DVI-D (24+1), male						

Table 109: 5CASDL.0018-03, 5CASDL.0050-03, 5CASDL.0100-03, 5CASDL.0150-03, 5CASDL.0200-03, 5CASDL.0250-03, 5CASDL.0300-03 - Technical data

Model number	5CASDL.0018-03	5CASDL.0050-03	5CASDL.0100-03	5CASDL.0150-03	5CASDL.0200-03	5CASDL.0250-03	5CASDL.0300-03
Connection cycles	Min. 200						
Contacts	Gold-plated						
Mechanical protection	Metal cover with crimped strain relief	Metal cover with crimped stress relief	Metal cover with crimped strain relief				
Locating screw tightening torque	Max. 0.5 Nm						
Electrical characteristics							
Operating voltage	≤30 V						
Test voltage							
Wire/Wire	1 kV						
Wire/Shield	0.5 kV						
Wave impedance	100 ±10 Ω						
Conductor resistance							
24 AWG	≤95 Ω/km						
26 AWG	≤145 Ω/km						
Insulation resistance	>200 MΩ/km						
Operating conditions							
Pollution degree per EN 61131	Pollution degree 2						
Approbation	UL AWM 20236 80°C 30 V						
Flame-retardant	In accordance with UL758 (cable vertical flame test)	Per UL 758 (cable vertical flame test)	In accordance with UL758 (cable vertical flame test)	Per UL 758 (cable vertical flame test)			
Oil and hydrolysis resistance	In accordance with VDE 0282-10	Per VDE 0282-10	In accordance with VDE 0282-10	Per VDE 0282-10			
Environmental conditions							
Temperature							
Storage	-20 to 80°C						
Fixed installation	-20 to 80°C						
Flexible installation	-5 to 60°C						
Mechanical characteristics							
Dimensions							
Length	1.8 m ±20 mm	5 m ±45 mm	10 m ±90 mm	15 m ±135 mm	20 m ±180 mm	25 m ±225 mm	30 m ±270 mm
Diameter	Max. 12 mm						
Bend radius							
Fixed installation	≥3.5x cable diameter						
Flexible installation	≥15x cable diameter (from ferrite bead - ferrite bead)	≥15x cable diameter (ferrite bead - ferrite bead)	≥15x cable diameter (from ferrite bead - ferrite bead)	≥15x cable diameter (ferrite bead - ferrite bead)			
Flexibility	Flexible, valid for ferrite bead - ferrite bead (tested 300,000 cycles with 15x cable diameter, 4800 cycles/hour)	Flexible, applies to ferrite bead - ferrite bead (tested 300000 cycles with 15x cable diameter, 4800 cycles/hour)	Flexible, valid for ferrite bead - ferrite bead (tested 300,000 cycles with 15x cable diameter, 4800 cycles/hour)	Flexible, applies to ferrite bead - ferrite bead (tested 300000 cycles with 15x cable diameter, 4800 cycles/hour)			
Drag chain data							
Flex cycles	300,000						
Speed	4800 cycles/hour						
Bend radius	180 mm, 15x cable diameter						
Hub	460 mm						
Weight	Approx. 460 g	Approx. 1020 g	Approx. 1940 g	Approx. 2840 g	Approx. 3740 g	Approx. 4560 g	Approx. 5590 g
Tension							
During operation	≤50 N						
During installation	≤400 N						

Table 109: 5CASDL.0018-03, 5CASDL.0050-03, 5CASDL.0100-03, 5CASDL.0150-03, 5CASDL.0200-03, 5CASDL.0250-03, 5CASDL.0300-03 - Technical data

- 1) Yes, although applies only if all components installed within the complete system have this certification and the complete system itself carries the corresponding mark.
- 2) Yes, although applies only if all components installed in the complete system have this certification and the complete system bears the corresponding mark.
- 3) Yes, although applies only if all components installed in the complete system have this certification and are listed on the associated DNV GL certificate for the product family.

3.4.1.4 Bend radius specifications

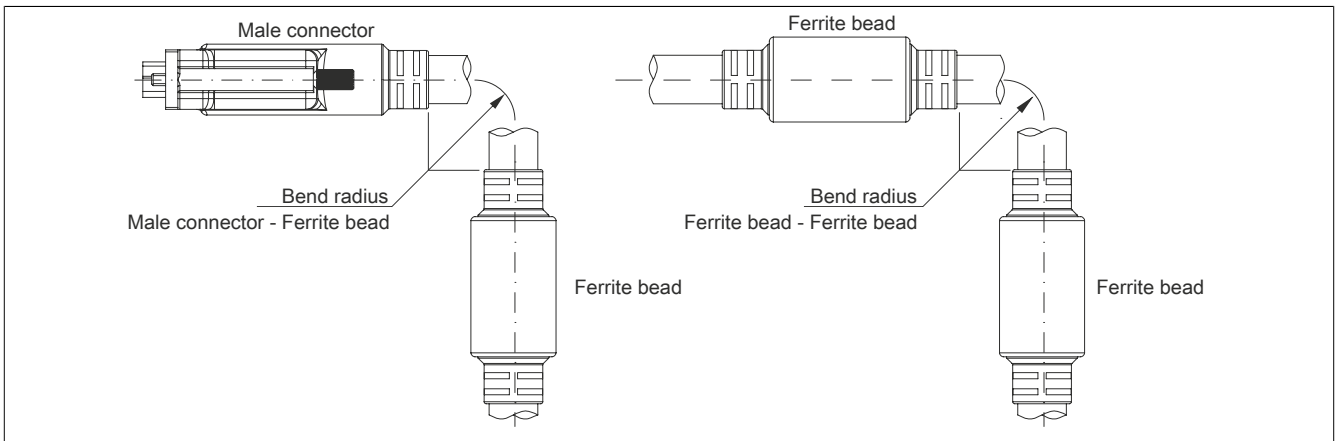

Figure 114: Bend radius specifications

3.4.1.5 Dimensions

All dimensions are specified in mm.

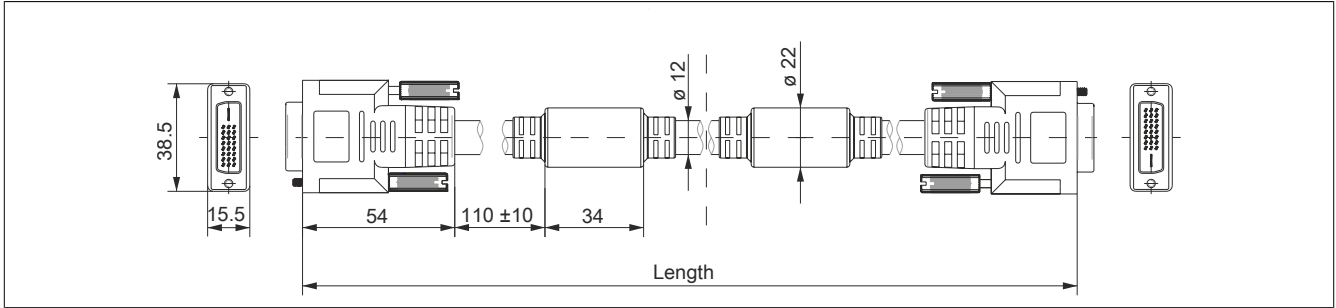

Figure 115: 5CASDL.0xxx-03 ≥Rev. E0 - Dimensions

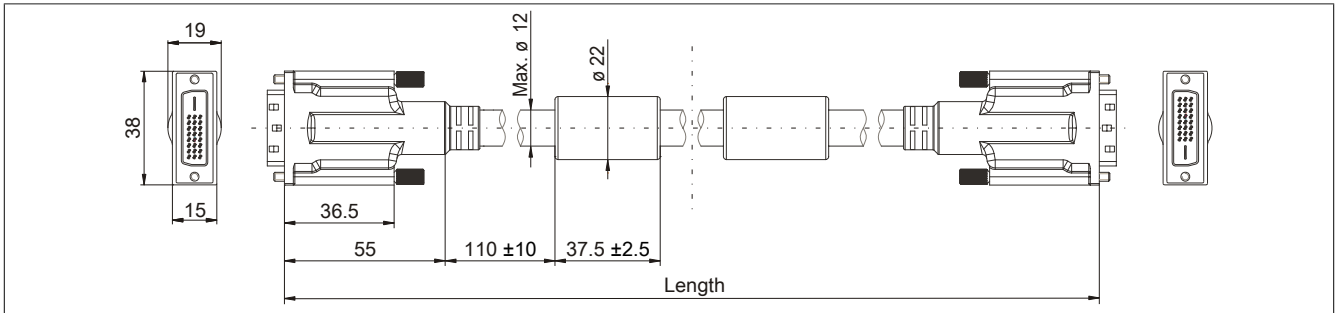

Figure 116: 5CASDL.0xxx-03 ≤Rev. D0 - Dimensions

3.4.1.6 Construction

Element	Assignment	Cross section	
DVI	TMDS data 0	26 AWG	
	TMDS data 1	26 AWG	
	TMDS data 2	26 AWG	
	TMDS cycle	26 AWG	
USB	XUSB0	26 AWG	
	XUSB1	26 AWG	
Data	SDL	26 AWG	
Control wires	DDC cycle	24 AWG	
	DDC data	24 AWG	
	+5 V	24 AWG	
	Ground	24 AWG	
	Hot plug detect	24 AWG	

Table 110: 5CASDL.0xxx-03 SDL flex cables - Construction

3.4.1.7 Cable pinout

Warning!

If a field-assembled cable is desired, it must be wired according to this pinout.

If a field-assembled cable is used, B&R cannot make any guarantee as to its functionality. Functionality is only ensured with cables provided by B&R.

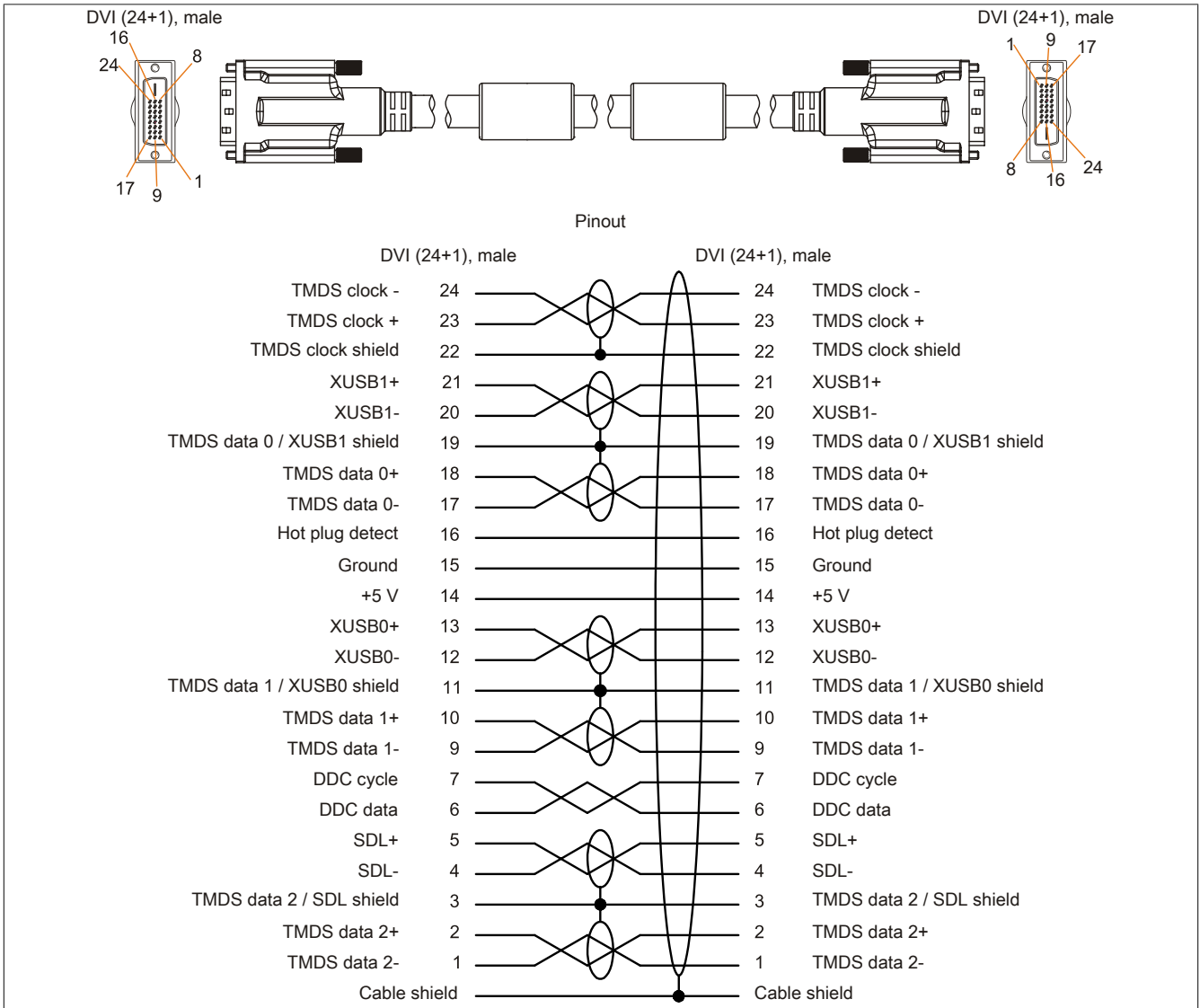

Figure 117: 5CASDL.0xxx-03 - Pinout

3.5 SDL flex cables with extender

3.5.1 5CASDL.0xx0-13

3.5.1.1 General information

5CASDL.0xx0-13 SDL flex cables with extender are designed for use in both fixed and flexible installations (e.g. swing arm systems).

Caution!

The cable is only permitted to be connected or disconnected when the power is switched off.

3.5.1.2 Order data

Model number	Short description	Figure
	SDL cables flex	
5CASDL.0300-13	SDL flex cable with extender - 30 m	
5CASDL.0400-13	SDL flex cable with extender - 40 m	
5CASDL.0430-13	SDL flex cable with extender - 43 m	

Table 111: 5CASDL.0300-13, 5CASDL.0400-13, 5CASDL.0430-13 - Order data

3.5.1.3 Technical data

Information:

The following specifications, properties and limit values apply only to this accessory and may deviate from those that apply to the complete system. For the complete system in which this accessory is installed, for example, the data specified for that complete system applies.

Model number	5CASDL.0300-13	5CASDL.0400-13	5CASDL.0430-13
General information			
Certifications			
CE		Yes	
UL		cULus E115267	
HazLoc		Industrial control equipment cULus HazLoc E180196	
DNV GL		Industrial control equipment for hazardous locations Class I, Division 2, Groups ABCD, T4 ¹⁾	
GOST-R		Temperature: B (0 - 55°C) Humidity: B (up to 100%) Vibration: A (0.7 g) EMC: B (Bridge and open deck) ²⁾	
		Yes	
Cable construction			
Wire cross section		24 AWG (control wires) 26 AWG (DVI, USB, data)	
Properties		Silicone- and halogen-free	
Shield		Individual cable pairs, entire cable	
Complete shielding		Aluminum-clad foil and tinned copper braiding	
Outer jacket			
Material		Special semi-matte TMPU	
Color		Black	
Labeling		(B&R) SDL cable (UL) AWM 20236 80°C 30 V E63216	
Connector			
Type		2x DVI-D (24+1), male	
Connection cycles		Min. 200	
Contacts		Gold-plated	
Mechanical protection		Metal cover with crimped strain relief	
Locating screw tightening torque		Max. 0.5 Nm	
Electrical characteristics			
Operating voltage		≤30 V	
Test voltage			
Wire/Wire		1 kV	
Wire/Shield		0.5 kV	
Wave impedance		100 ±10 Ω	
Conductor resistance			
24 AWG		≤95 Ω/km	
26 AWG		≤145 Ω/km	
Insulation resistance		>200 MΩ/km	

Table 112: 5CASDL.0300-13, 5CASDL.0400-13, 5CASDL.0430-13 - Technical data

Model number	5CASDL.0300-13	5CASDL.0400-13	5CASDL.0430-13
Operating conditions			
Pollution degree per EN 61131		Pollution degree 2	
Approbation		UL AWM 20236 80°C 30 V	
Flame-retardant		Per UL 758 (cable vertical flame test)	
Oil and hydrolysis resistance		Per VDE 0282-10	
Environmental conditions			
Temperature			
Storage		-20 to 60°C	
Fixed installation		-20 to 60°C	
Flexible installation		-5 to 60°C	
Mechanical characteristics			
Dimensions			
Length	30 m ±280 mm	40 m ±380 mm	43 m ±410 mm
Diameter		Max. 12 mm	
Extender box			
Width		35 mm	
Length		125 mm	
Height		18.5 mm	
Bend radius			
Fixed installation		≥6x cable diameter (male connector - ferrite bead) ≥10x cable diameter (ferrite bead - ferrite bead)	
Flexible installation		≥15x cable diameter (ferrite bead - ferrite bead)	
Flexibility		Flexible, applies to ferrite bead - ferrite bead (tested 300000 cycles with 15x cable diameter, 4800 cycles/hour)	
Drag chain data			
Flex cycles		300,000	
Speed		4800 cycles/hour	
Bend radius		180 mm, 15x cable diameter	
Hub		460 mm	
Weight	Approx. 5430 g	Approx. 7200 g	Approx. 7790 g
Tension			
During operation		≤50 N	
During installation		≤400 N	

Table 112: 5CASDL.0300-13, 5CASDL.0400-13, 5CASDL.0430-13 - Technical data

- 1) Yes, although applies only if all components installed in the complete system have this certification and the complete system bears the corresponding mark.
- 2) Yes, although applies only if all components installed in the complete system have this certification and are listed on the associated DNV GL certificate for the product family.

3.5.1.4 Bend radius specifications

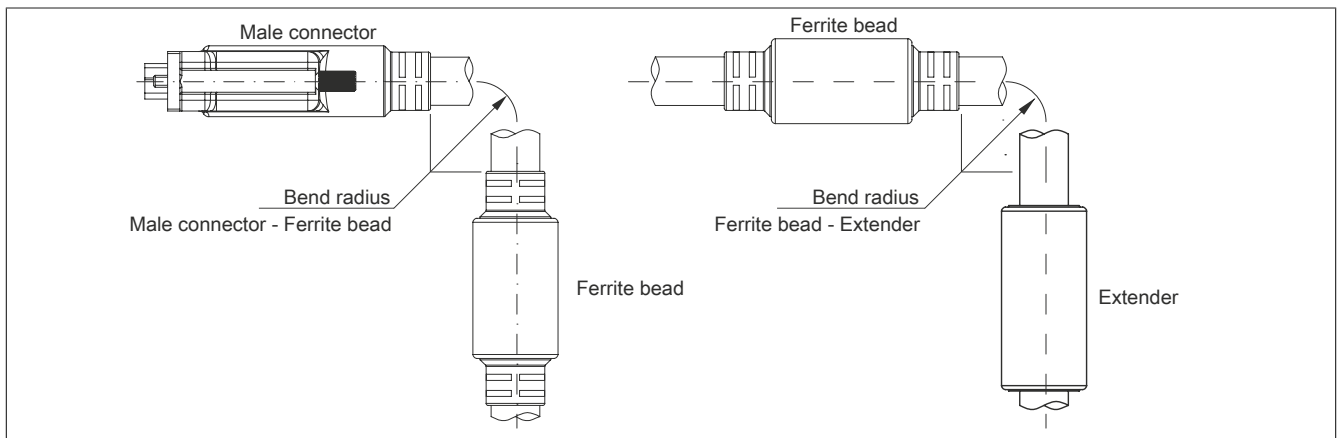

Figure 118: Bend radius specification with extender

3.5.1.5 Dimensions

All dimensions are specified in mm.

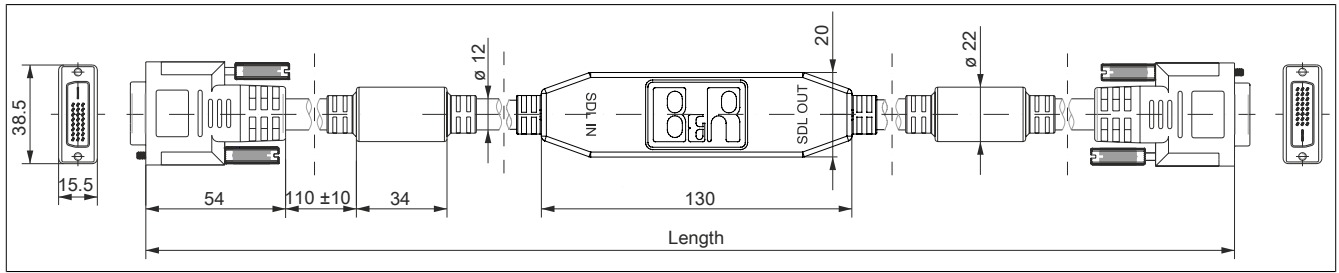

Figure 119: 5CASDL.xxxx-13 ≥Rev. E0 - Dimensions

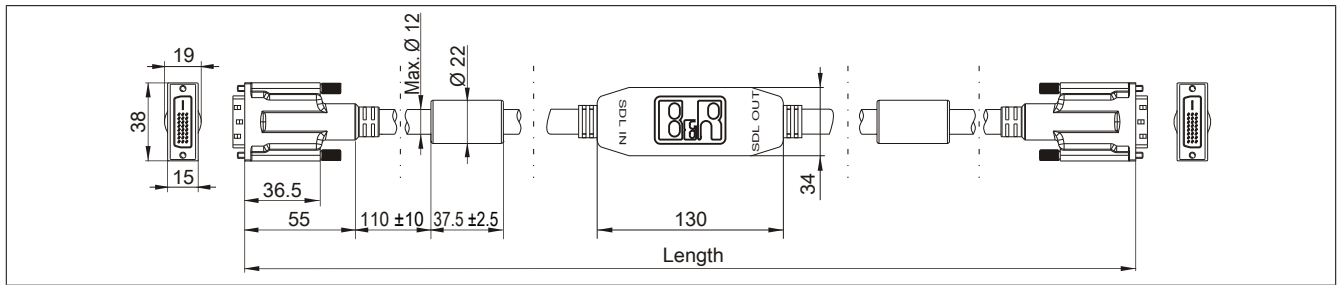

Figure 120: 5CASDL.0xx0-13 ≤Rev. D0 - Dimensions

3.5.1.6 Cable pinout

Warning!

If a field-assembled cable is desired, it must be wired according to this pinout.

If a field-assembled cable is used, B&R cannot make any guarantee as to its functionality. Functionality is only ensured with cables provided by B&R.

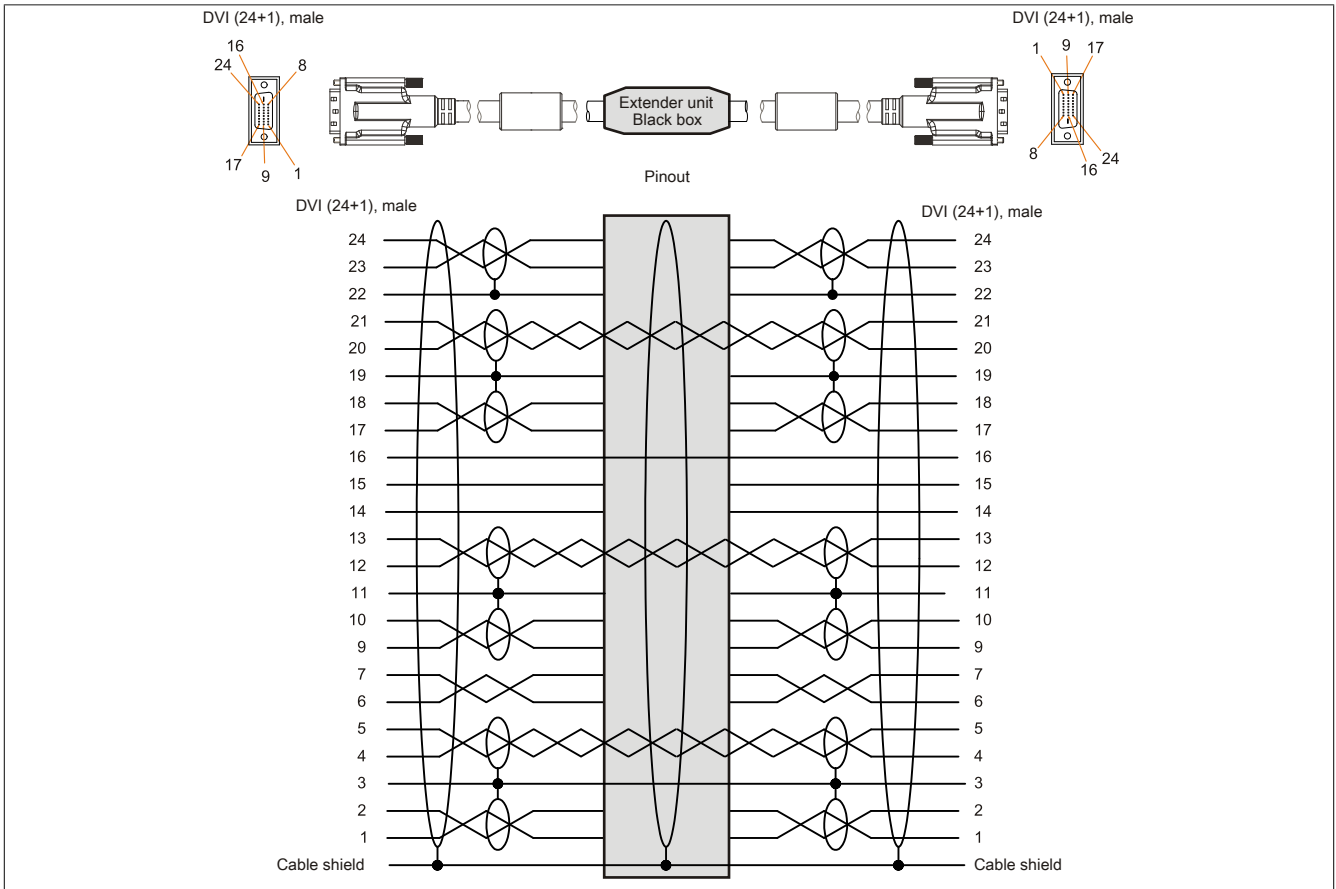

Figure 121: 5CASDL.0xx0-13 - Pinout

3.5.1.7 Cable connection

SDL flex cables with extender must be connected between the B&R industrial PC and Automation Panel in the correct direction. The correct signal direction is indicated on the extender.

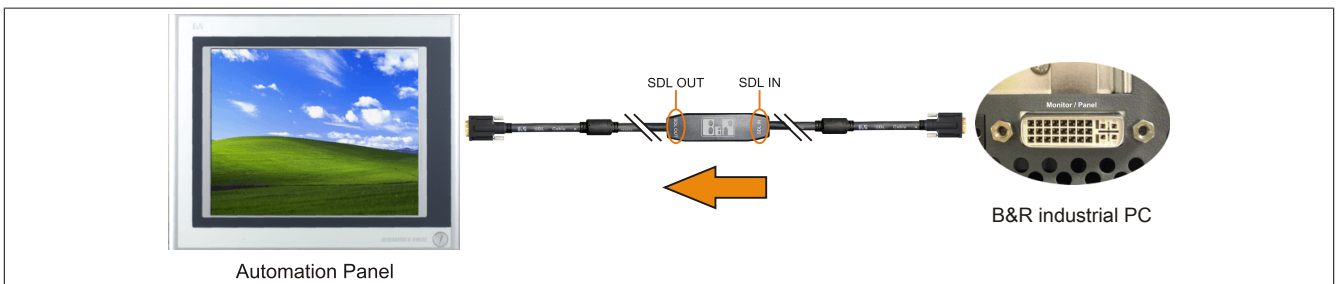

Figure 122: Signal direction for SDL flex cable with extender - Example

3.6 SDL3/SDL4 cables

3.6.1 5CASD3.xxxx-00

3.6.1.1 General information

5CASD3.xxxx-00 SDL3/SDL4 cables are designed to transfer SDL3/SDL4 data and simplify cable installation. The RJ45 connector allows these cables to be connected in very narrow spaces, for example in swing arm shafts.

Caution!

The cable is only permitted to be connected or disconnected when the power is switched off.

3.6.1.2 Order data

Model number	Short description	Figure
	SDL3/SDL4 cables	
5CASD3.0030-00	SDL3 cable - 3 m	
5CASD3.0050-00	SDL3 cable - 5 m	
5CASD3.0100-00	SDL3 cable - 10 m	
5CASD3.0150-00	SDL3 cable - 15 m	
5CASD3.0200-00	SDL3 cable - 20 m	
5CASD3.0300-00	SDL3 cable - 30 m	
5CASD3.0500-00	SDL3 cable - 50 m	
5CASD3.1000-00	SDL3 cable - 100 m	

Table 113: 5CASD3.0030-00, 5CASD3.0050-00, 5CASD3.0100-00, 5CASD3.0150-00, 5CASD3.0200-00, 5CASD3.0300-00, 5CASD3.0500-00, 5CASD3.1000-00 - Order data

3.6.1.3 Technical data

Information:

The following specifications, properties and limit values apply only to this accessory and may deviate from those that apply to the complete system. For the complete system in which this accessory is installed, for example, the data specified for that complete system applies.

Model number	5CASD3.0030-00	5CASD3.0050-00	5CASD3.0100-00	5CASD3.0150-00	5CASD3.0200-00	5CASD3.0300-00	5CASD3.0500-00	5CASD3.1000-00
General information								
Certifications								
CE	Yes							
UL	cULus E115267 Industrial control equipment							
HazLoc	cULus HazLoc E180196 Industrial control equipment for hazardous locations Class I, Division 2, Groups ABCD, T4 ¹⁾							
Cable construction								
Wire cross section	4x 2x 26/7 AWG				4x 2x 23/1 AWG			
Properties	Flame-retardant, halogen-free, lead-free							
Outer jacket								
Material	Polyurethane (PUR)							
Color	Yellow, RAL 1021							
Labeling	HARTING INDUSTRIAL CABLE S/FTP CAT 6A PUR 4x2xAWG26/7				HARTING INDUSTRIAL INSTALLATION CABLE S/FTP CAT 7 PUR 4x2xAWG23/1			
Lines								
Wire insulation	Polyethylene (PE)							
Wire colors	Green/White-green, orange/white-orange, blue/white-blue, brown/white-brown							
Shield	Aluminum foil and braided wire shield made of tinned copper wires							
Type	Unprotected copper wire, 4x 2x 26/7 AWG				Unprotected copper wire, 4x 2x 23/1 AWG			
Connector								
Type	2x RJ45, male							
Connection cycles	Min. 750							
Contacts	8							
Electrical characteristics ²⁾								
Operating voltage	≤100 V				≤125 V			
Conductor resistance	≤290 Ω/km				≤75 Ω/km			
Wave impedance	100 ±5 Ω (at 100 MHz)							

Table 114: 5CASD3.0030-00, 5CASD3.0050-00, 5CASD3.0100-00, 5CASD3.0150-00, 5CASD3.0200-00, 5CASD3.0300-00, 5CASD3.0500-00, 5CASD3.1000-00 - Technical data

Model number	5CASD3.0030-00	5CASD3.0050-00	5CASD3.0100-00	5CASD3.0150-00	5CASD3.0200-00	5CASD3.0300-00	5CASD3.0500-00	5CASD3.1000-00
Transfer properties	Category 6A / Class EA up to 500 MHz per ISO/IEC 11801 (EN 50173-1), ISO/IEC 24702 (EN 50173-3)					Category 7 / Class F up to 600 MHz per ISO/IEC 11801 (EN 50173-1), ISO/IEC 24702 (EN 50173-3)		
Insulation resistance	≥500 MΩ/km					≥5 GΩ/km		
Operating conditions								
Pollution degree per EN 61131	Pollution degree 2							
Flame-retardant	IEC 60332-1-2							
Oil and hydrolysis resistance	EN 60811-2-1 (90°C / 7x24 h)							
Protection per EN 60529	IP20							
Cables	IP20							
RJ45 connector	IP20, only when properly connected							
Environmental conditions								
Temperature								
Storage	-40 to 70°C							
Fixed installation	-40 to 70°C							
Flexible installation	-40 to 70°C					-10 to 50°C		
Mechanical characteristics								
Dimensions								
Length	3 m	5 m	10 m	15 m	20 m	30 m	50 m	100 m
Diameter	6.7 mm					8.3 mm		
Bend radius								
Fixed installation	≥5x diameter					≥4x diameter		
Flexible installation	≥10x diameter					≥8x diameter		
Weight	250 g	500 g	700 g	950 g	2150 g	3500 g	6950 g	
Tension								
During operation	≤70 N					≤110 N		
During installation	≤70 N					≤110 N		

Table 114: 5CASD3.0030-00, 5CASD3.0050-00, 5CASD3.0100-00, 5CASD3.0150-00, 5CASD3.0200-00, 5CASD3.0300-00, 5CASD3.0500-00, 5CASD3.1000-00 - Technical data

- 1) Yes, although applies only if all components installed in the complete system have this certification and the complete system bears the corresponding mark.
- 2) At an ambient temperature of 20°C.

3.6.1.4 Bend radius specifications

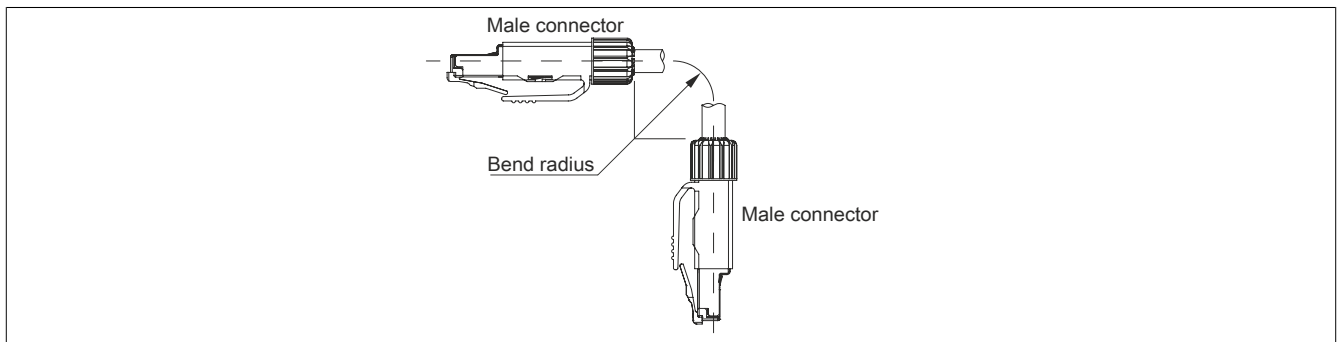

Figure 123: SDL3 - Bend radius specifications

3.6.1.5 Dimensions

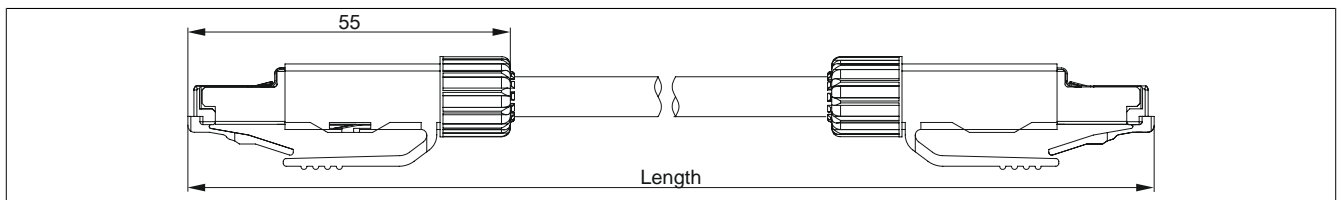

Figure 124: 5CASD3.xxxx-00 - Dimensions

3.6.1.6 Cable pinout

Warning!

If a field-assembled cable is desired, it must be wired according to this pinout.

If a field-assembled cable is used, B&R cannot make any guarantee as to its functionality. Functionality is only ensured with cables provided by B&R.

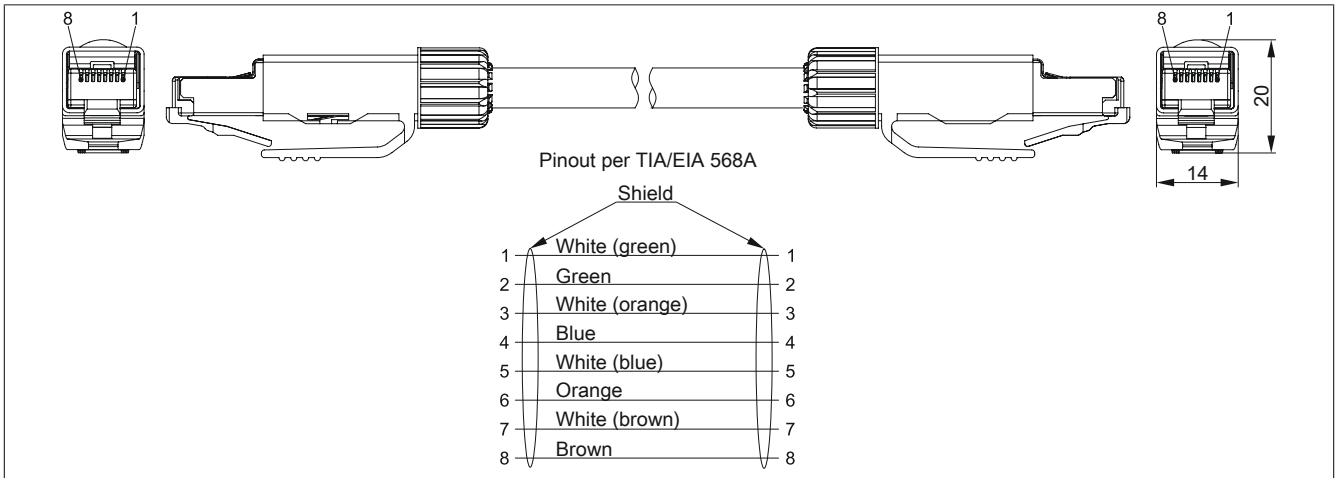

Figure 125: 5CASD3.xxxx-00 - Pinout

3.6.1.7 Wiring

The following information and figure apply when using a field-assembled cable that is not directly connected to a B&R device, but to an RJ45 network interface (e.g. patch panel).

Wiring must meet category 6a (Cat 6a) or category 7 (Cat 7) requirements. Exceeding the maximum total length of 100 m is not permitted.

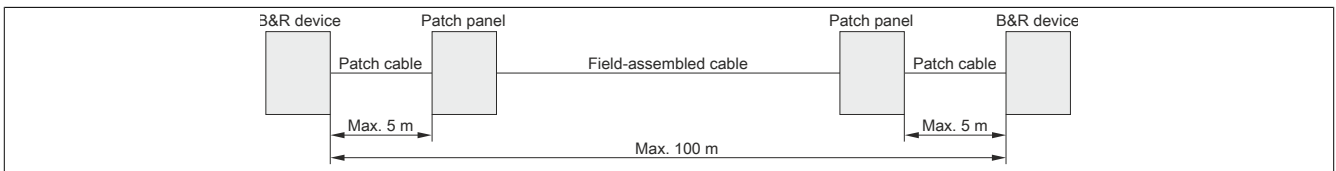

Figure 126: Wiring with a field-assembled cable

3.7 USB cables

3.7.1 5CAUSB.00xx-00

3.7.1.1 General information

USB cables are designed for a USB 2.0 transfer rate.

3.7.1.2 Order data

Model number	Short description	Figure
	USB cables	
5CAUSB.0018-00	USB 2.0 connection cable - Type A - type B connector - 1.8 m	
5CAUSB.0050-00	USB 2.0 connection cable - Type A - type B connector - 5 m	

Table 115: 5CAUSB.0018-00, 5CAUSB.0050-00 - Order data

3.7.1.3 Technical data

Information:

The following specifications, properties and limit values apply only to this accessory and may deviate from those that apply to the complete system. For the complete system in which this accessory is installed, for example, the data specified for that complete system applies.

Model number	5CAUSB.0018-00	5CAUSB.0050-00
General information		
Certifications		
CE	Yes	
UL	cULus E115267 Industrial control equipment	
DNV GL	Temperature: B (0 - 55°C) Humidity: B (up to 100%) Vibration: A (0.7 g) EMC: B (Bridge and open deck) ¹⁾	
GOST-R	Yes	
Cable construction		
Wire cross section	24, 28 AWG	
Shield	Entire cable	
Outer jacket		
Color	Beige	
Connector		
Type	USB type A male and USB type B male	
Operating conditions		
Pollution degree per EN 61131	Pollution degree 2	
Mechanical characteristics		
Dimensions		
Length	1.8 m ±30 mm	5 m ±50 mm
Diameter	Max. 5 mm	
Bend radius	Min. 100 mm	

Table 116: 5CAUSB.0018-00, 5CAUSB.0050-00 - Technical data

- 1) Yes, although applies only if all components installed in the complete system have this certification and are listed on the associated DNV GL certificate for the product family.

3.7.1.4 Cable pinout

Warning!

If a field-assembled cable is desired, it must be wired according to this pinout.

If a field-assembled cable is used, B&R cannot make any guarantee as to its functionality. Functionality is only ensured with cables provided by B&R.

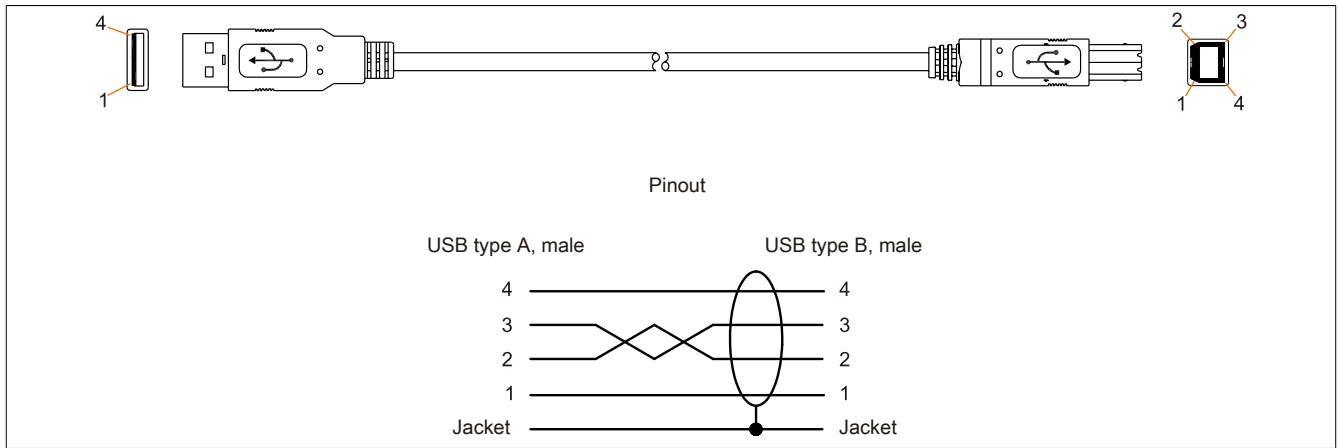

Figure 127: 5CAUSB.00xx-00 USB cables - Pinout

3.8 RS232 cables

3.8.1 9A0014.xx

3.8.1.1 General information

RS232 cables are used as extension cables between two RS232 interfaces.

3.8.1.2 Order data

Model number	Short description	Figure
	RS232 cables	
9A0014.02	RS232 extension cable for operation of a remote display unit with touch screen, 1.8 m	
9A0014.05	RS232 extension cable for operation of a remote display unit with touch screen, 5 m	
9A0014.10	RS232 extension cable for operation of a remote display unit with touch screen, 10 m	

Table 117: 9A0014.02, 9A0014.05, 9A0014.10 - Order data

3.8.1.3 Technical data

Information:

The following specifications, properties and limit values apply only to this accessory and may deviate from those that apply to the complete system. For the complete system in which this accessory is installed, for example, the data specified for that complete system applies.

Model number	9A0014.02	9A0014.05	9A0014.10
General information			
Certification		Yes	
CE		Yes	
GOST-R	-		Yes
Cable construction			
Wire cross section		26 AWG	
Shield		Entire cable	
Outer sheathing			
Color		Beige	
Connector			
Type		9-pin DSUB connector, male/female	
Locating screw tightening torque		Max. 0.5 Nm	
Operating conditions			
EN 61131 pollution degree		Pollution degree 2	
Mechanical characteristics			
Dimensions			
Length	1.8 m ±50 mm	5 m ±80 mm	10 m ±100 mm
Diameter		Max. 5 mm	
Bend radius		Min. 70 mm	

Table 118: 9A0014.02, 9A0014.05, 9A0014.10 - Technical data

3.8.1.4 Cable pinout

Warning!

If a field-assembled cable is desired, it must be wired according to this pinout.

If a field-assembled cable is used, B&R cannot make any guarantee as to its functionality. Functionality is only ensured with cables provided by B&R.

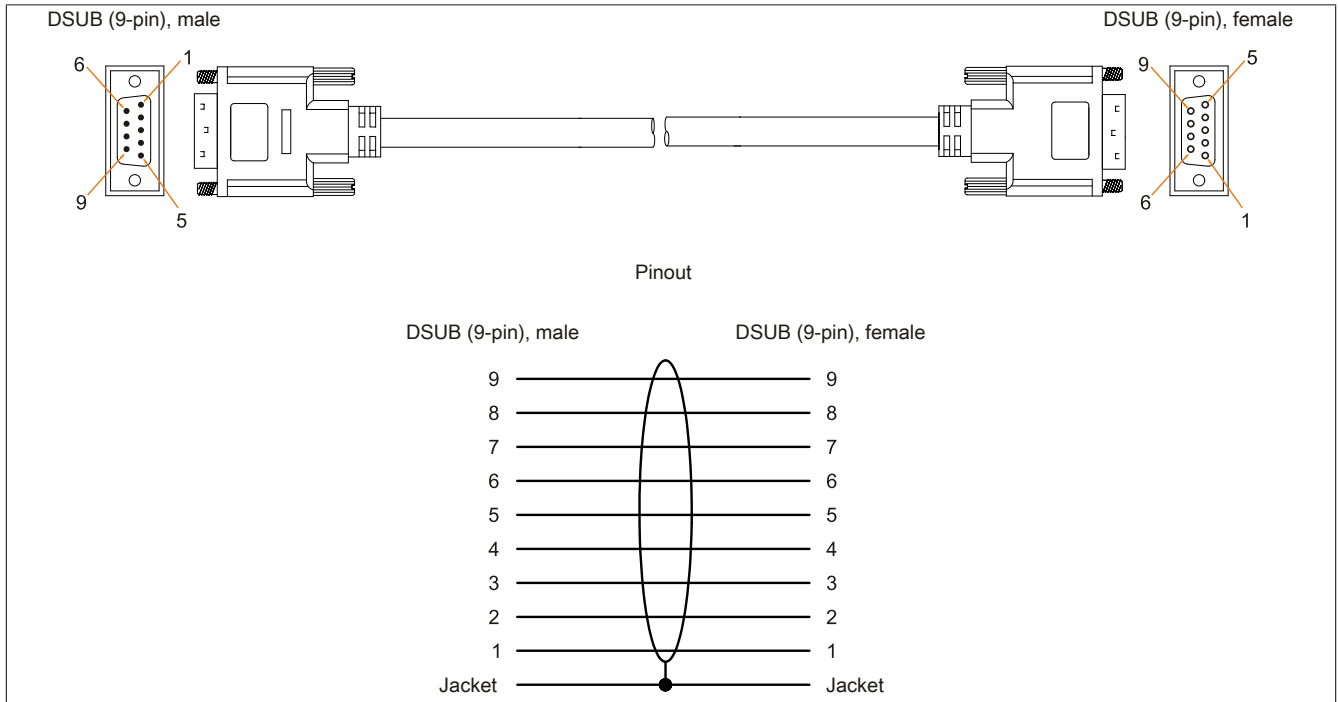

Figure 128: 9A0014.xx RS232 cables - Pinout

4 Line filter

4.1 5AC804.MFLT-00

4.1.1 General information

Line filter 5AC804.MFLT-00 may be necessary to satisfy requirements regarding conducted disturbances in supply lines in accordance with the 2003 edition of GL EMC1 (Germanischer Lloyd) or DNVGL-CG-0339 from November 2015.

The line filter should be installed as close to the end device as possible; the supply line from the end device to the line filter should be kept as short as possible.

4.1.2 Order data

Model number	Short description	Figure
5AC804.MFLT-00	Line filter	

Table 119: 5AC804.MFLT-00 - Order data

4.1.3 Technical data

Information:

The following specifications, properties and limit values apply only to this accessory and may deviate from those that apply to the complete system. For the complete system in which this accessory is installed, for example, the data specified for that complete system applies.

Model number	5AC804.MFLT-00
General information	
Certifications	
CE	Yes
UL	cULus E115267 Industrial control equipment
HazLoc	cULus HazLoc E180196 Industrial control equipment for hazardous locations Class I, Division 2, Groups ABCD, T4 ¹⁾
DNV GL	Temperature: B (0 - 55°C) Humidity: B (up to 100%) Vibration: A (0.7 g) EMC: B (Bridge and open deck) ²⁾
GOST-R	Yes
Terminal block	
Connection cross section	
With wire end sleeves	1.5 mm ²
Flexible	0.2 to 1.5 mm ²
Inflexible	0.2 to 2.5 mm ²
Electrical characteristics	
Nominal voltage	24 VDC -25% / +30%, SELV ³⁾
Nominal current	8 A
Overvoltage category per EN 61131-2	II
Operating conditions	
Pollution degree per EN 61131	Pollution degree 2
Environmental conditions	
Temperature	
Operation	-25 to 65°C
Storage	-25 to 65°C
Transport	-25 to 65°C
Mechanical characteristics	
Housing	
Material	Galvanized steel plate

Table 120: 5AC804.MFLT-00 - Technical data

Model number	5AC804.MFLT-00
Dimensions	
Width	54 mm
Length	94 mm
Depth	32.15 mm
Weight	205 g

Table 120: 5AC804.MFLT-00 - Technical data

- 1) Yes, although applies only if all components installed within the complete system have this certification and the complete system itself carries the corresponding mark.
- 2) Yes, although applies only if all components installed in the complete system have this certification and are listed on the associated DNV GL certificate for the product family.
- 3) EN 60950 requirements must be observed; see section "+24 VDC power supply" in the user's manual.

4.1.4 Dimensions

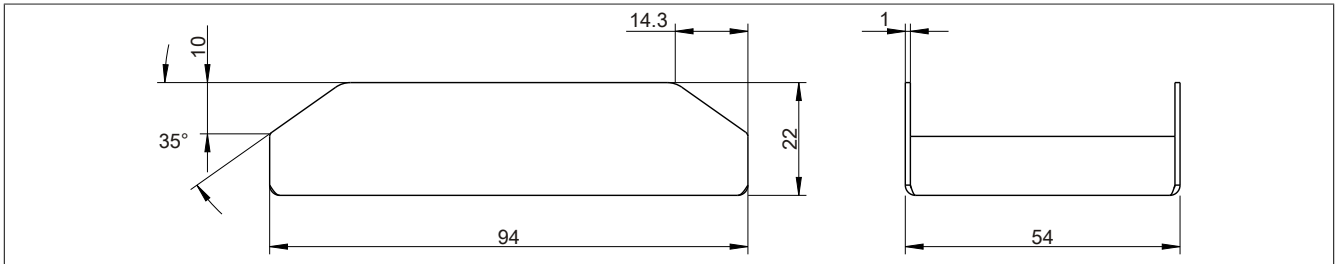

Figure 129: 5AC804.MFLT-00 - Dimensions

4.1.5 Drilling template

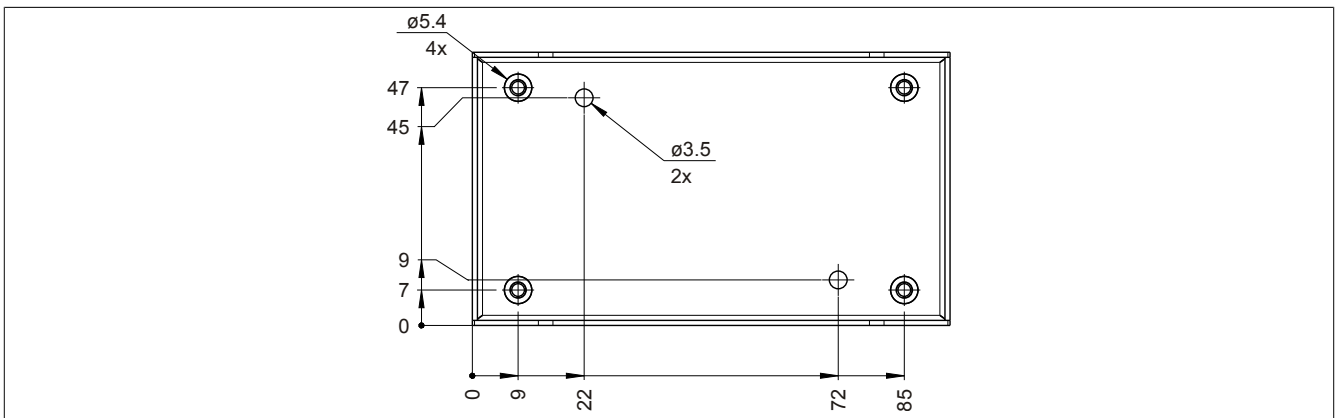

Figure 130: 5AC804.MFLT-00 - Drilling template

4.1.6 Connecting to the end device

The line filter must be connected between the voltage supply and the end device.

The following points must be observed:

- Use shielded, twisted wires.
- Keep the lines as short as possible (voltage supply - line filter - end device).
- The line filter must be installed on an uncoated, oil-free metallic surface.

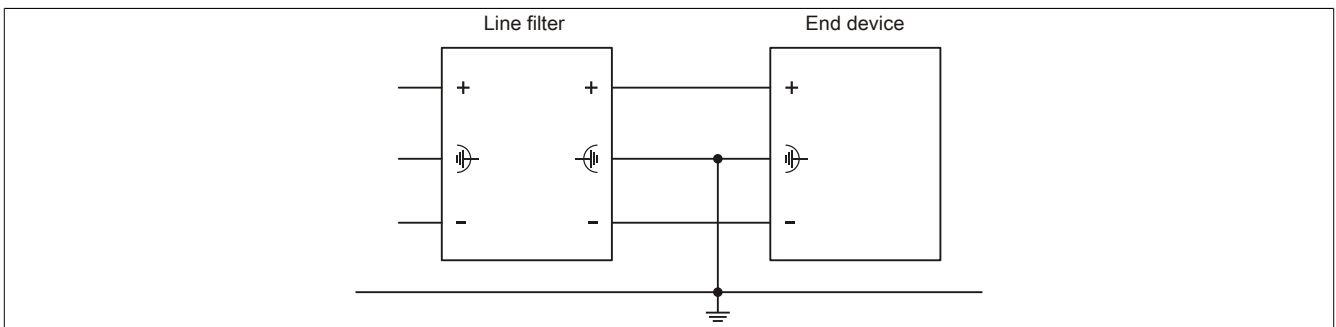

Figure 131: Connection example

5 Clamping blocks

5.1 5AC900.BLOC-00

5.1.1 General information

These replacement clamping blocks are used to mount B&R panel devices.

5.1.2 Order data

Model number	Short description	Figure
	Accessories	
5AC900.BLOC-00	Terminal block with brackets, 10 pcs.; replacement part	

Table 121: 5AC900.BLOC-00 - Order data

5.2 5AC900.BLOC-01

5.2.1 General information

These replacement clamping blocks are used to mount B&R panel devices.

5.2.2 Order data

Model number	Short description	Figure
	Accessories	
5AC900.BLOC-01	Clamping block without brackets, 10 pcs.; replacement part	

Table 122: 5AC900.BLOC-01 - Order data

6 USB interface cover

6.1 5AC900.1201-00

6.1.1 General information

Flat front-side USB interface cover for Automation Panel 1000, Automation Panel 900, Power Panel 500, Panel PC 700 and Panel PC 800 devices.

6.1.2 Order data

Model number	Short description	Figure
	Accessories	
5AC900.1201-00	USB interface cover M20 IP65 flat	

Table 123: 5AC900.1201-00 - Order data

6.2 5AC900.1201-01

6.2.1 General information

Round front-side knurled USB interface cover (with anti-loss strap) for Automation Panel 1000, Automation Panel 900, Power Panel 500, Panel PC 700 and Panel PC 800 devices.

6.2.2 Order data

Model number	Short description	Figure
	Accessories	
5AC900.1201-01	USB interface cover M20 IP65 curved	

Table 124: 5AC900.1201-01 - Order data

Chapter 7 • Servicing and maintenance

This chapter describes the servicing/maintenance work that is possible to be carried out by a trained and qualified end user.

1 Cleaning

Danger!

The device is only permitted to be cleaned when power is switched off in order to prevent unintended functions from being triggered by touching the touch screen or pressing keys.

Use a moist cloth to clean the device. Only use water with detergent, a screen cleaning agent or alcohol (ethanol) to moisten the cleaning cloth. Apply the cleaning agent to the cloth beforehand; do not spray it directly on the device! Never use aggressive solvents, chemicals, scouring agents, pressurized air or steam-jet air ejectors.

Information:

Displays with a touch screen should be cleaned at regular intervals.

2 Tips for extending the service life of the display

2.1 Backlight

The service life of the backlight is specified by its "half-brightness time". An operating time of 50,000 would mean that the display would still retain 50% of its brightness after this time.

2.1.1 How can the service life of backlights be extended?

- Setting the display brightness to the lowest value that is still comfortable for the eyes
- Using dark images
- Reducing the brightness by 50% can increase the half-brightness time by approximately 50%.

2.2 Image persistence

Image persistence refers to the "burning in" of a static image on a display after being displayed for a prolonged period of time. This not only occurs with static images, however. Image persistence is also referred to in the technical literature as burn-in effect, image retention, memory effect, memory sticking or ghost image.

There are basically 2 types:

- Area type: This type is characterized by a dark gray image. The effect disappears if the display is switched off for a long period of time.
- Line type: Can result in permanent damage.

2.2.1 What causes image persistence?

- Static images
- No screensaver
- Sharp transitions in contrast (e.g. black/white)
- High ambient temperatures
- Operation outside of specifications

2.2.2 How can image persistence be reduced?

- Constantly switching between static and dynamic images
- Avoiding excessive brightness differences between foreground and background elements
- Using colors with similar brightness
- Using complementary colors in consecutive images
- Using screensavers

3 Pixel errors

Information:

Displays may contain defective pixels (pixel errors) that result from the manufacturing process. They are not grounds for initiating a complaint or warranty claim.

4 Repairs, complaints and replacement parts

Danger!

The unauthorized opening or repair of the device can result in injury and/or extensive damage to property. Therefore, do not attempt to perform repairs yourself. Repairs are only permitted to be performed by authorized qualified personnel at the place of manufacture.

To process a repair/complaint, please create a repair order or complaint using the B&R Material Return Portal on the B&R website at www.br-automation.com.

Appendix A

1 Abbreviations

Abbreviation	Stands for	Description
NC	Normally closed	Normally closed relay contact.
	Not connected	Used in pinout descriptions if a terminal or pin is not connected on the module side.
ND	Not defined	In technical data tables, this stands for a value that is not defined. This may be because a cable manufacturer does not provide a value for certain technical data, for example.
NO	Normally open	Normally open relay contact.
TBD	To be defined	Used in technical data tables when there is currently no value for specific technical data. The value will be provided at a later point in time.

Table 125: Abbreviations used in this user's manual

2 Viewing angles

For the viewing angle values of display types (R, L, U, D), see the technical data of the individual components.

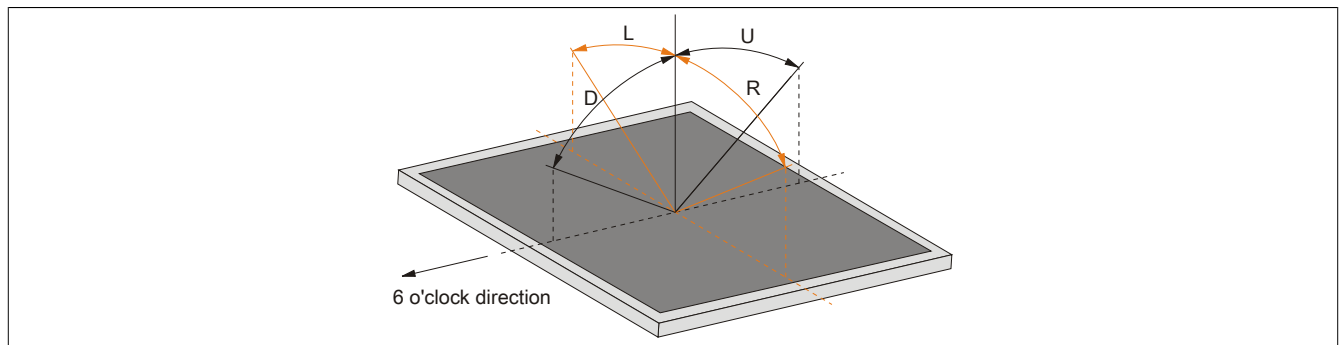

3 Chemical resistance

Single-touch panels are equipped with the Autotex panel overlay.

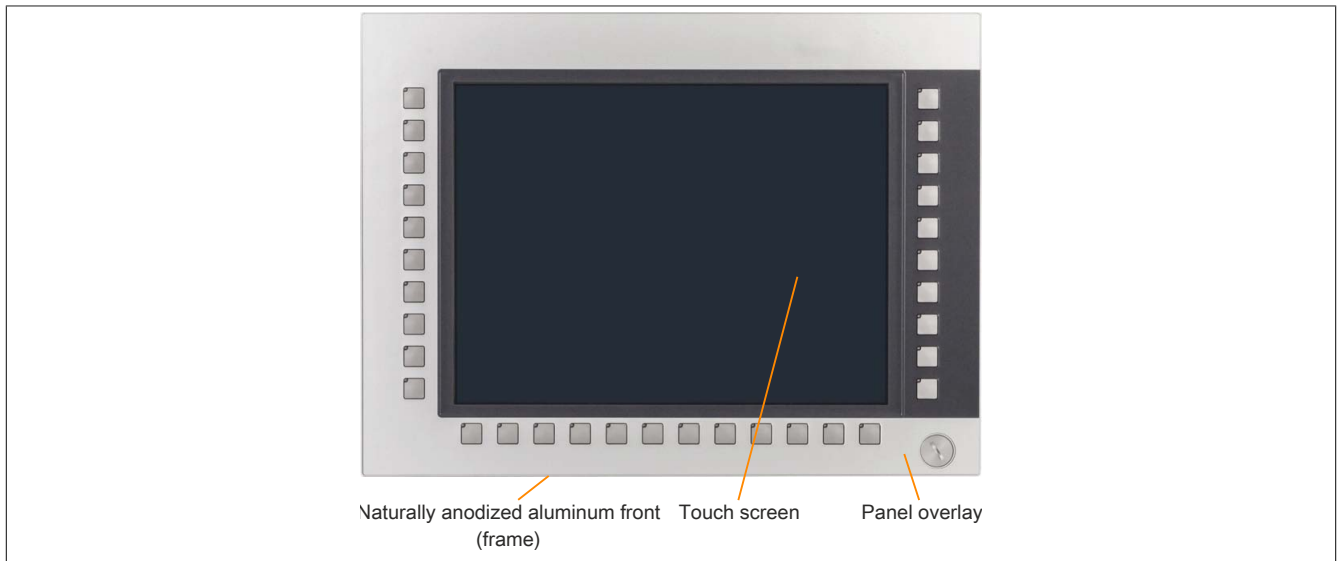

Figure 132: Single-touch panel with Autotex panel overlay, naturally anodized

The front of the following single-touch panels are coated:

- 5AP1120.101E-000
- 5AP1120.121E-000
- 5AP1120.156B-000

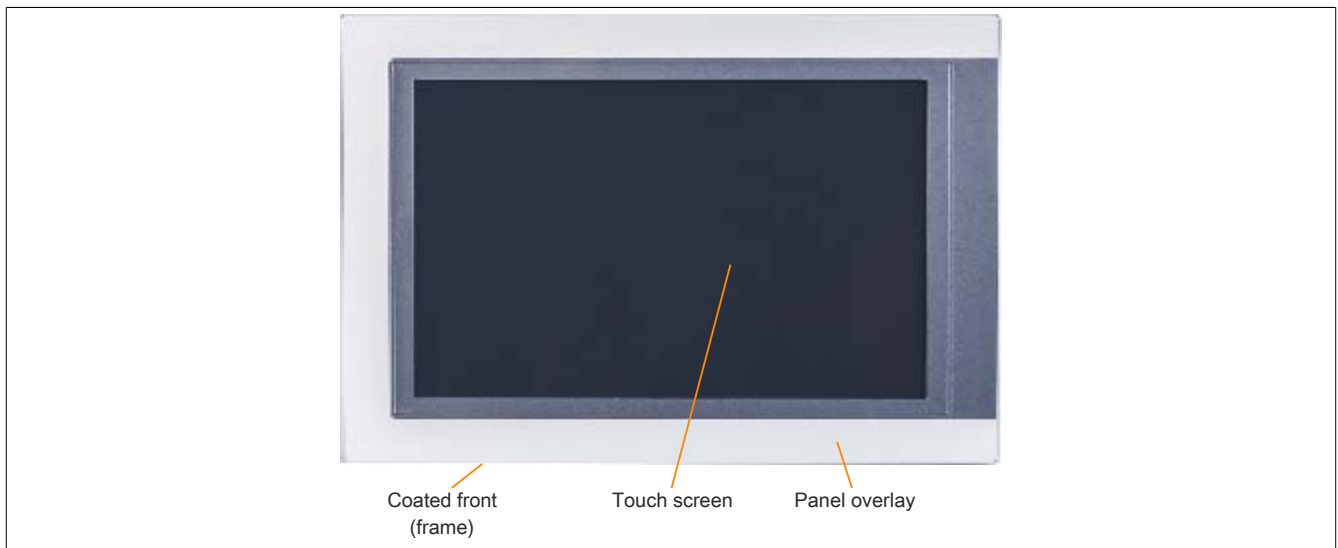

Figure 133: Single-touch panel with Autotex panel overlay, coated

Multi-touch panels feature an edge-to-edge glass surface.

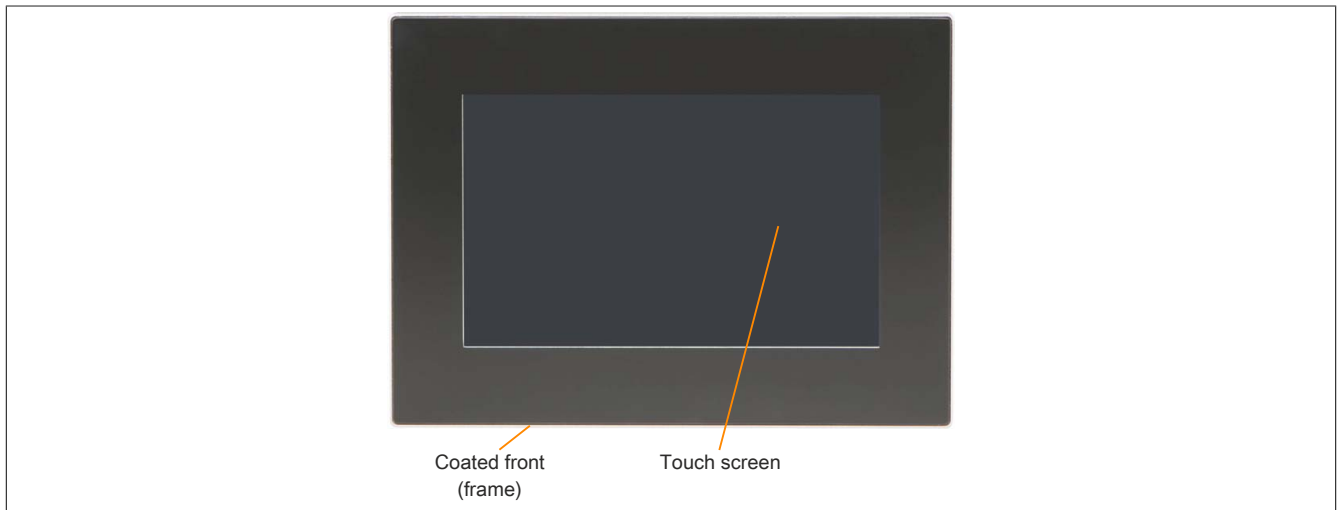

Figure 134: Multi-touch panel with glass surface

3.1 Autotex panel overlay (polyester)

Unless otherwise specified, the panel overlay is resistant to exposure to the following chemicals for up to 24 hours with no visible signs of damage per DIN 42115 Part 2:

- Acetaldehyde
- Acetone
- Acetonitrile
- Aliphatic hydrocarbons
- Alkali carbonate
- Formic acid <50%
- Ammonia <40%
- Amyl acetate
- Ethanol
- Ether
- Gasoline
- Bichromate
- Potassium
- Cutting oil
- Brake fluid
- Butylcellosolve
- Sodium hypochlorite <20%
- Cyclohexanol
- Cyclohexanone
- Decon
- Diacetone alcohol
- Dibutyl phthalate
- Diesel
- Diethyl ether
- Diethyl phthalate
- Dioxan
- Dowandol
- DRM/PM
- Iron chloride (FeCl₂)
- Iron chloride (FeCl₃)
- Acetic acid <50%
- Ethyl acetate
- Linseed oil
- Aviation fuel
- Formaldehyde 37 to 42%
- Glycerine
- Glycol
- Isophorone
- Isopropanol
- Potassium hydroxide
- Potassium carbonate
- Methanol
- Methylisobutylketone
- MIBK
- Sodium bisulphate
- Sodium carbonate
- Caustic soda <40%
- N-Butyl acetate
- Paraffin oil
- Phosphoric acid <30%
- Blown castor oil
- Nitric acid <10%
- Hydrochloric acid <36%
- Sea water
- Sulphuric acid <10%
- Silicon oil
- Tenside
- Turpentine oil replacement
- Toluene
- Triacetin
- Trichloroacetic acid <50%
- Trichloroethane
- White spirits
- Washing agents
- Water
- Hydrogen peroxide <25%
- Fabric conditioner
- Xylene

The panel overlay is resistant to exposure to glacial acetic acid for less than one hour without visible damage per DIN 42115 Part 2.

3.2 Coated aluminum front

Unless otherwise specified, the coated aluminum front is resistant to exposure to the following chemicals for up to 24 hours with no visible signs of damage per DIN 42115 Part 2:

- Formic acid <50%
- Ammonia <40%
- Brake fluid
- Hydrochloric acid <10%
- Diesel
- Acetic acid <50%
- Transmission fluid
- Lactic acid <10%
- Isopropanol
- Coolant <4%
- Sodium hydroxide <40%
- Petroleum
- Phosphoric acid <25%
- Saline <10%
- Sulphuric acid <25%
- Sidolin
- Skydrol

The coated aluminum front is not resistant to the following chemicals:

- Acetone
- Ethyl acetate

3.3 Touch screen

AMT touch screen (single-touch)

Unless otherwise specified, the AMT touch screen is resistant to exposure to the following chemicals for a 1-hour period (at 25°C) with no visible signs of damage:

- Acetone
- Ammonia-based glass cleaner
- Beer
- Unleaded gasoline
- Chemical cleaning agents
- Hydrochloric acid <6%
- Coca-Cola
- Diesel
- Dimethylbenzene
- Vinegar
- Ethanol
- Antifreeze
- Transmission fluid
- Household cleaning agents
- Hexane
- n-hexane
- Isopropanol
- Coffee
- Methylbenzene
- Methylene chloride
- Methyl ethyl ketone
- Mineral spirits
- Motor oil
- Nitric acid <70%
- Salt solution <5%
- Tea
- Turpentine
- Grease
- Sulphuric acid <40%
- Cooking oil

3M touch screen (multi-touch)

Unless otherwise specified, the 3M touch screen is resistant to exposure to the following chemicals for up to 24 hours without visible changes per ASTM D 1308-02 and ASTM F 1598-95:

- Acetone
- Ammonia <5%
- Gasoline
- Beer
- Lead
- Brake fluid
- Hydrochloric acid <6%
- Coca-Cola
- Dimethylbenzene
- Ethanol
- Rubber cement
- Isopropanol
- Coffee
- Ink
- Lipstick
- Lysol
- Methylbenzene
- Methyl ethyl ketone
- Naphtha
- Nitric acid <70%
- Grease
- Sulphuric acid <40%
- Stamping ink
- Tea
- Trichloroethylene
- Water
- White wine vinegar
- Windex Original

4 Touch screen

4.1 5-wire AMT touch screen (single-touch)

4.1.1 Technical data

Information:

The following specifications, properties and limit values apply only to this individual component and may deviate from those that apply to the complete system. For the complete system in which this individual component is used, for example, the data specified for that complete system applies.

Product ID	5-wire AMT touch screen
General information	
Certifications	
CE	Yes
c-UL-us	Yes
Manufacturer	AMT
Technology	Analog, resistive
Release pressure	<1 N
Light transmission	81% ±3%
Environmental conditions	
Temperature	
Operation	- 20 to 70°C
Storage	- 40 to 80°C
Transport	- 40 to 80°C
Relative humidity	
Operation	90% at max. 50°C
Storage	90% RH at max. 60°C for 504 hours
Transport	90% RH at max. 60°C for 504 hours
Operating conditions	
Service life	36 million touch operations at the same position (release pressure: 250 g, interval: 2x per second)
Activation	Finger, pointer, credit card, glove
Drivers	Touch screen drivers for approved operating systems are available for download in the Downloads section of the B&R website (www.br-automation.com).

Table 126: 5-wire AMT touch screen - Technical data

4.1.2 Temperature/Humidity diagram

All values apply to non-condensing operation.

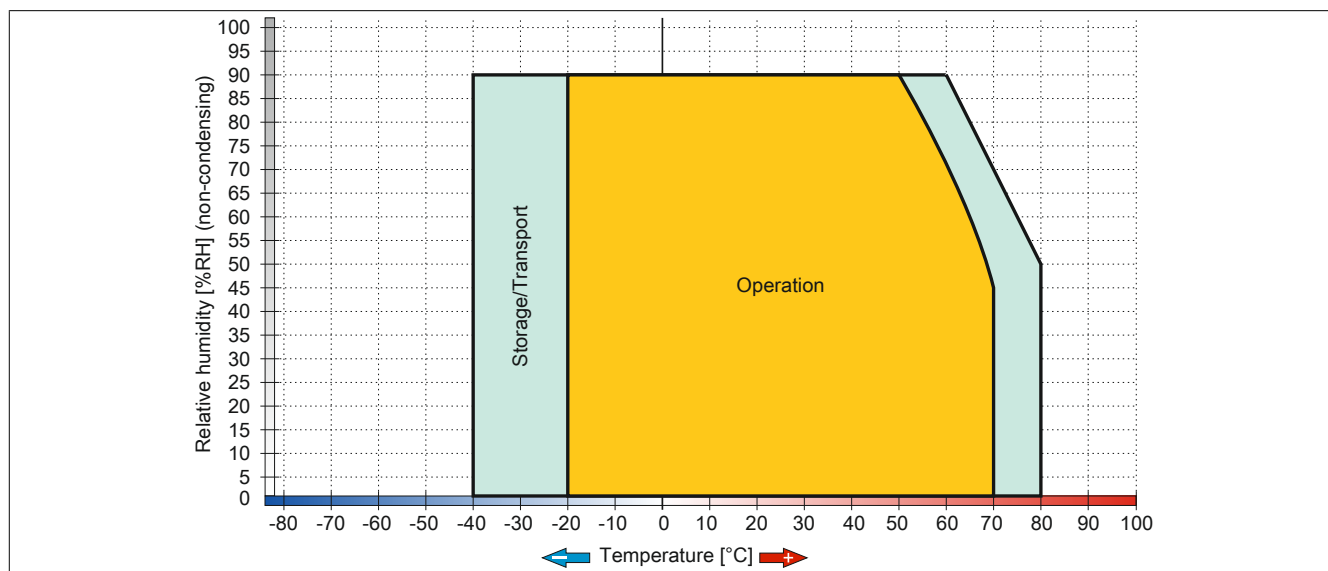

Figure 135: 5-wire AMT touch screen - Temperature/Humidity diagram

4.2 3M touch screen (multi-touch generation 3)

4.2.1 Technical data

Information:

The following specifications, properties and limit values apply only to this individual component and may deviate from those that apply to the complete system. For the complete system in which this individual component is used, for example, the data specified for that complete system applies.

Product ID	3M touch screen	
General information		
Certifications		
CE	Yes	
Manufacturer	3M	
Technology	Projected capacitive touch (PCT)	
Light transmission	>90%	
Anti-reflective coating	Optical/Gloss=80	
Environmental conditions		
Temperature		
Operation	-10 to 70°C	
Storage	-40 to 70°C	
Transport	-40 to 70°C	
Relative humidity		
Operation	Up to 90% at max. 35°C, for >35°C see diagram	
Storage	Up to 90% at max. 35°C, for >35°C see diagram	
Transport	Up to 90% at max. 35°C, for >35°C see diagram	
Operating conditions		
Activation	Finger, thin glove, 3M Smart Pen	

Table 127: 3M touch screen - Technical data

4.2.2 Temperature/Humidity diagram

All values apply to non-condensing operation/storage/transport.

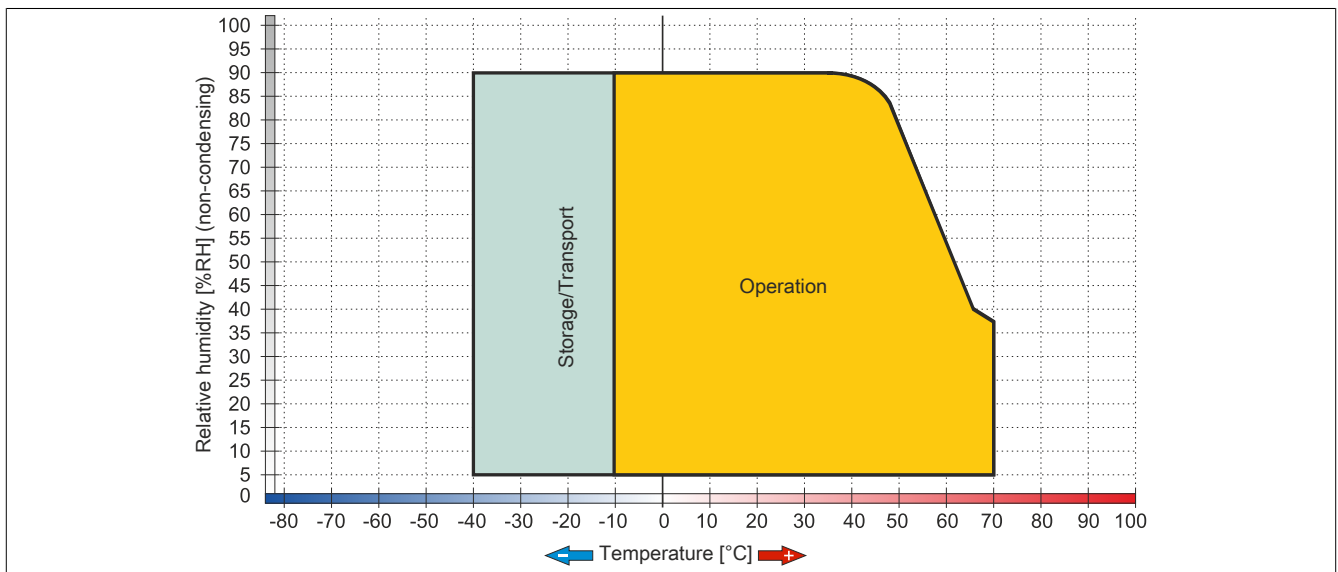

Figure 136: 3M touch screen - Temperature/Humidity diagram

Figure 1:	Automation Panel 1000 - Configuration.....	17
Figure 2:	Automation Panel 1000 with retaining clips - Dimensions.....	23
Figure 3:	Automation Panel 1000 with clamping blocks - Dimensions.....	24
Figure 4:	Automation Panel 1000 with retaining clips - Installation diagram.....	25
Figure 5:	Automation Panel 1000 with clamping blocks - Installation diagram.....	26
Figure 6:	Automation Panel 1000 - Spacing for air circulation.....	27
Figure 7:	Automation Panel 1000 - Mounting orientation.....	28
Figure 8:	Automation Panel 1000 - Temperature sensor position.....	34
Figure 9:	SDL/DVI receiver link module - Block diagram.....	39
Figure 10:	SDL3 receiver link module - Block diagram.....	39
Figure 11:	SDL4 receiver link module - Block diagram.....	39
Figure 12:	Overview of interfaces - SDL/DVI receiver link module.....	40
Figure 13:	Ground connection.....	41
Figure 14:	Brightness controls.....	45
Figure 15:	Overview of interfaces - SDL3 receiver link module.....	46
Figure 16:	Ground connection.....	47
Figure 17:	Overview of interfaces - SDL4 receiver link module.....	50
Figure 18:	Ground connection.....	51
Figure 19:	Features of AP1000 panels.....	54
Figure 20:	Hardware numbers in the B&R Key Editor and B&R Control Center.....	55
Figure 21:	Representation of keys and LEDs.....	55
Figure 22:	5AP1151.0573-000 - Key and LED configuration.....	55
Figure 23:	5AP1180.1043-000 - Key and LED configuration.....	56
Figure 24:	5AP1181.1043-000 - Key and LED configuration.....	56
Figure 25:	5AP1182.1043-000 - Key and LED configuration.....	57
Figure 26:	5AP1180.1505-000 - Key and LED configuration.....	57
Figure 27:	5AP1181.1505-000 - Key and LED configuration.....	58
Figure 28:	Compatibility details - Figure layout.....	62
Figure 29:	Mounting compatibility - 5.7" device - Horizontal1.....	62
Figure 30:	Mounting compatibility - 5.7" device - Horizontal2.....	63
Figure 31:	Mounting compatibility - 5.7" device - Vertical1.....	63
Figure 32:	Mounting compatibility - 10.4" device - Horizontal1.....	64
Figure 33:	Mounting compatibility - 10.4" device - Horizontal2.....	64
Figure 34:	Mounting compatibility - 10.4" device - Vertical1.....	65
Figure 35:	Mounting compatibility - 12.1" device - Horizontal1.....	66
Figure 36:	Mounting compatibility - 15" device - Horizontal1.....	67
Figure 37:	Mounting compatibility - 15" device - Vertical1.....	67
Figure 38:	Mounting compatibility - 17" device - Horizontal1.....	68
Figure 39:	Mounting compatibility - 19" device - Horizontal1.....	68
Figure 40:	Mounting compatibility - 21.3" device - Horizontal1.....	69
Figure 41:	5AP1120.0573-000 - Dimensions.....	71
Figure 42:	5AP1120.0573-000 ≤Rev. D0 - Temperature/Humidity diagram.....	72
Figure 43:	5AP1120.0573-000 ≥Rev. E0 - Temperature/Humidity diagram.....	72
Figure 44:	5AP1151.0573-000 - Dimensions.....	74
Figure 45:	5AP1151.0573-000 ≤Rev. D0 - Temperature/Humidity diagram.....	75
Figure 46:	5AP1151.0573-000 ≥Rev. E0 - Temperature/Humidity diagram.....	75
Figure 47:	5AP1120.0702-000 - Dimensions.....	77
Figure 48:	5AP1120.0702-000 - Temperature/Humidity diagram.....	77
Figure 49:	5AP1130.0702-000 - Dimensions.....	79
Figure 50:	5AP1130.0702-000 - Temperature/Humidity diagram.....	79
Figure 51:	5AP1120.101E-000 - Dimensions.....	81
Figure 52:	5AP1120.101E-000 - Temperature/Humidity diagram.....	81
Figure 53:	5AP1130.101E-000 - Dimensions.....	83
Figure 54:	5AP1130.101E-000 - Temperature/Humidity diagram.....	83
Figure 55:	5AP1120.1043-000 - Dimensions.....	85
Figure 56:	5AP1120.1043-000 - Temperature/Humidity diagram.....	86
Figure 57:	5AP1180.1043-000 - Dimensions.....	88

Figure 58:	5AP1180.1043-000 - Temperature/Humidity diagram.....	89
Figure 59:	5AP1181.1043-000 - Dimensions.....	91
Figure 60:	5AP1181.1043-000 - Temperature/Humidity diagram.....	92
Figure 61:	5AP1182.1043-000 - Dimensions.....	94
Figure 62:	5AP1182.1043-000 - Temperature/Humidity diagram.....	95
Figure 63:	5AP1120.1214-000 - Dimensions.....	97
Figure 64:	5AP1120.1214-000 - Temperature/Humidity diagram.....	98
Figure 65:	5AP1120.121E-000 - Dimensions.....	100
Figure 66:	5AP1120.121E-000 - Temperature/Humidity diagram.....	100
Figure 67:	5AP1130.121E-000 - Dimensions.....	102
Figure 68:	5AP1130.121E-000 - Temperature/Humidity diagram.....	102
Figure 69:	5AP1120.1505-000 - Dimensions.....	104
Figure 70:	5AP1120.1505-000 - Temperature/Humidity diagram.....	105
Figure 71:	5AP1180.1505-000 - Dimensions.....	107
Figure 72:	5AP1180.1505-000 - Temperature/Humidity diagram.....	108
Figure 73:	5AP1181.1505-000 - Dimensions.....	111
Figure 74:	5AP1181.1505-000 - Temperature/Humidity diagram.....	111
Figure 75:	5AP1181.1505-000 - Cutout installation.....	112
Figure 76:	5AP1120.156B-000 - Dimensions.....	114
Figure 77:	5AP1120.156B-000 - Temperature/Humidity diagram.....	114
Figure 78:	5AP1130.156C-000 - Dimensions.....	116
Figure 79:	5AP1130.156C-000 - Temperature/Humidity diagram.....	116
Figure 80:	5AP1130.185C-000 - Dimensions.....	118
Figure 81:	5AP1130.185C-000 - Temperature/Humidity diagram.....	118
Figure 82:	5AP1120.1906-000 - Dimensions.....	120
Figure 83:	5AP1120.1906-000 - Temperature/Humidity diagram.....	121
Figure 84:	Preparing the retaining clips.....	129
Figure 85:	Inserting the retaining clips.....	130
Figure 86:	Fastening the retaining clips.....	130
Figure 87:	Position of the clamping blocks.....	131
Figure 88:	Fastening the clamping blocks.....	132
Figure 89:	Removing the Torx screws.....	133
Figure 90:	Removing the link module.....	133
Figure 91:	Installing a screw clamp terminal block.....	134
Figure 92:	Installing a cage clamp terminal block.....	134
Figure 93:	Connecting the power supply connector to a B&R device.....	135
Figure 94:	Automation Panel 1000 - Grounding concept.....	136
Figure 95:	Bend radius - Cable connection.....	137
Figure 96:	Adjusting the display brightness.....	141
Figure 97:	Brightness controls.....	141
Figure 98:	ADI Control Center screenshots - Examples.....	144
Figure 99:	ADI Development Kit Screenshots (Symbolbild).....	146
Figure 100:	ADI .NET SDK screenshots.....	147
Figure 101:	B&R Key Editor screenshots.....	148
Figure 102:	B&R KCF Editor V1.0 screenshot.....	149
Figure 103:	5MMUSB.xxxx-01 - Temperature/Humidity diagram.....	163
Figure 104:	5MMUSB.032G-02 - Temperature/Humidity diagram.....	165
Figure 105:	Bend radius specifications.....	167
Figure 106:	5CADVI.0xxx-00 - Dimensions.....	167
Figure 107:	5CADVI.0xxx-00 - Pinout.....	168
Figure 108:	Bend radius specifications.....	170
Figure 109:	5CASDL.0xxx-00 - Dimensions.....	170
Figure 110:	5CASDL.0xxx-00 - Pinout.....	171
Figure 111:	Bend radius specifications.....	173
Figure 112:	5CASDL.0xxx-01 - Dimensions.....	173
Figure 113:	5CASDL.0xxx-01 - Pinout.....	174
Figure 114:	Bend radius specifications.....	177

Figure 115:	5CASDL.0xxx-03 ≥Rev. E0 - Dimensions.....	178
Figure 116:	5CASDL.0xxx-03 ≤Rev. D0 - Dimensions.....	178
Figure 117:	5CASDL.0xxx-03 - Pinout.....	179
Figure 118:	Bend radius specification with extender.....	181
Figure 119:	5CASDL.xxxx-13 ≥Rev. E0 - Dimensions.....	182
Figure 120:	5CASDL.0xx0-13 ≤Rev. D0 - Dimensions.....	182
Figure 121:	5CASDL.0xx0-13 - Pinout.....	183
Figure 122:	Signal direction for SDL flex cable with extender - Example.....	183
Figure 123:	SDL3 - Bend radius specifications.....	185
Figure 124:	5CASD3.xxxx-00 - Dimensions.....	185
Figure 125:	5CASD3.xxxx-00 - Pinout.....	186
Figure 126:	Wiring with a field-assembled cable.....	186
Figure 127:	5CAUSB.00xx-00 USB cables - Pinout.....	188
Figure 128:	9A0014.xx RS232 cables - Pinout	190
Figure 129:	5AC804.MFLT-00 - Dimensions.....	192
Figure 130:	5AC804.MFLT-00 - Drilling template.....	192
Figure 131:	Connection example.....	192
Figure 132:	Single-touch panel with Autotex panel overlay, naturally anodized.....	198
Figure 133:	Single-touch panel with Autotex panel overlay, coated.....	198
Figure 134:	Multi-touch panel with glass surface.....	199
Figure 135:	5-wire AMT touch screen - Temperature/Humidity diagram.....	202
Figure 136:	3M touch screen - Temperature/Humidity diagram.....	203

Table 1:	Environmentally friendly disposal.....	12
Table 2:	Description of the safety notices used in this documentation.....	13
Table 3:	Range of nominal sizes.....	13
Table 4:	AP1000 panels with retaining clips - Dimensions.....	23
Table 5:	Link modules - Dimensions.....	23
Table 6:	AP1000 panels with clamping blocks - Dimensions.....	24
Table 7:	Link modules - Dimensions.....	24
Table 8:	AP1000 panels with retaining clips - Installation diagrams.....	25
Table 9:	AP1000 panels with clamping blocks - Installation diagrams.....	26
Table 10:	Automation Panel 1000 with SDL/DVI receiver - Mounting orientations.....	28
Table 11:	Automation Panel 1000 with SDL3 receiver - Mounting orientations.....	29
Table 12:	Automation Panel 1000 with SDL4 receiver - Mounting orientations.....	29
Table 13:	AP1000 panels - Weight.....	30
Table 14:	Link modules - Weight.....	30
Table 15:	Maximum ambient temperature during operation.....	31
Table 16:	AP1000 panels - Ambient temperature during storage and transport.....	32
Table 17:	Link modules - Ambient temperature during storage and transport.....	32
Table 18:	Temperature sensor position.....	34
Table 19:	AP1000 panels - Relative humidity.....	35
Table 20:	Link modules - Humidity.....	35
Table 21:	Vibration.....	35
Table 22:	Shock.....	35
Table 23:	+24 VDC voltage supply connection.....	37
Table 24:	Link modules - Power calculation.....	38
Table 25:	AP1000 panels - Power calculation.....	38
Table 26:	+24 VDC voltage supply connection.....	41
Table 27:	Panel In interface - SDL, DVI.....	42
Table 28:	DVI interface - Pinout.....	42
Table 29:	Cable lengths and resolutions for SDL transmission.....	43
Table 30:	Cable lengths and resolutions for DVI transfer.....	43
Table 31:	USB1/USB2 interface.....	44
Table 32:	USB In interface.....	45
Table 33:	COM - Pinout.....	45
Table 34:	+24 VDC voltage supply connection.....	47
Table 35:	SDL3 In interface.....	48
Table 36:	SDL3 In LEDs.....	48
Table 37:	USB1/USB2 interface.....	49
Table 38:	+24 VDC voltage supply connection.....	51
Table 39:	SDL4 In interface.....	52
Table 40:	SDL4 In LEDs.....	52
Table 41:	USB1/USB2 interface.....	53
Table 42:	Front USB interface.....	59
Table 43:	Shortened product names.....	60
Table 44:	Overview of device compatibility.....	60
Table 45:	5AP1120.0573-000 - Order data.....	70
Table 46:	5AP1120.0573-000, 5AP1120.0573-000 - Technical data.....	70
Table 47:	5AP1151.0573-000 - Order data.....	73
Table 48:	5AP1151.0573-000, 5AP1151.0573-000 - Technical data.....	73
Table 49:	5AP1120.0702-000 - Order data.....	76
Table 50:	5AP1120.0702-000 - Technical data.....	76
Table 51:	5AP1130.0702-000 - Order data.....	78
Table 52:	5AP1130.0702-000 - Technical data.....	78
Table 53:	5AP1120.101E-000 - Order data.....	80
Table 54:	5AP1120.101E-000 - Technical data.....	80
Table 55:	5AP1130.101E-000 - Order data.....	82
Table 56:	5AP1130.101E-000 - Technical data.....	82
Table 57:	5AP1120.1043-000 - Order data.....	84

Table 58:	5AP1120.1043-000 - Technical data.....	84
Table 59:	5AP1180.1043-000 - Order data.....	87
Table 60:	5AP1180.1043-000 - Technical data.....	87
Table 61:	5AP1181.1043-000 - Order data.....	90
Table 62:	5AP1181.1043-000 - Technical data.....	90
Table 63:	5AP1182.1043-000 - Order data.....	93
Table 64:	5AP1182.1043-000 - Technical data.....	93
Table 65:	5AP1120.1214-000 - Order data.....	96
Table 66:	5AP1120.1214-000 - Technical data.....	96
Table 67:	5AP1120.121E-000 - Order data.....	99
Table 68:	5AP1120.121E-000 - Technical data.....	99
Table 69:	5AP1130.121E-000 - Order data.....	101
Table 70:	5AP1130.121E-000 - Technical data.....	101
Table 71:	5AP1120.1505-000 - Order data.....	103
Table 72:	5AP1120.1505-000 - Technical data.....	103
Table 73:	5AP1180.1505-000 - Order data.....	106
Table 74:	5AP1180.1505-000 - Technical data.....	106
Table 75:	5AP1181.1505-000 - Order data.....	109
Table 76:	5AP1181.1505-000 - Technical data.....	109
Table 77:	5AP1120.156B-000 - Order data.....	113
Table 78:	5AP1120.156B-000 - Technical data.....	113
Table 79:	5AP1130.156C-000 - Order data.....	115
Table 80:	5AP1130.156C-000 - Technical data.....	115
Table 81:	5AP1130.185C-000 - Order data.....	117
Table 82:	5AP1130.185C-000 - Technical data.....	117
Table 83:	5AP1120.1906-000 - Order data.....	119
Table 84:	5AP1120.1906-000 - Technical data.....	119
Table 85:	5DLSDL.1001-00 - Order data.....	122
Table 86:	5DLSDL.1001-00 - Technical data.....	122
Table 87:	5DLSD3.1001-00 - Order data.....	124
Table 88:	5DLSD3.1001-00 - Technical data.....	124
Table 89:	5DLSD4.1001-00 - Order data.....	126
Table 90:	5DLSD4.1001-00 - Technical data.....	126
Table 91:	5SWUTI.0001-000 - Order data.....	150
Table 92:	Nonincendive electrical circuit parameters for the front USB interface.....	156
Table 93:	Connected nonincendive device with field wiring.....	157
Table 94:	Nonincendive circuit parameters for the USB interfaces.....	158
Table 95:	Connected nonincendive device with field wiring.....	159
Table 96:	0TB103.9, 0TB103.91 - Order data.....	160
Table 97:	0TB103.9, 0TB103.91 - Technical data.....	160
Table 98:	5MMUSB.2048-01, 5MMUSB.4096-01 - Order data.....	162
Table 99:	5MMUSB.2048-01, 5MMUSB.4096-01 - Technical data.....	162
Table 100:	5MMUSB.032G-02 - Order data.....	164
Table 101:	5MMUSB.032G-02 - Technical data.....	164
Table 102:	5CADVI.0018-00, 5CADVI.0050-00, 5CADVI.0100-00 - Order data.....	166
Table 103:	5CADVI.0018-00, 5CADVI.0050-00, 5CADVI.0100-00 - Technical data.....	166
Table 104:	5CASDL.0008-00, 5CASDL.0018-00, 5CASDL.0050-00, 5CASDL.0100-00, 5CASDL.0150-00, 5CASDL.0200-00, 5CASDL.0250-00, 5CASDL.0300-00 - Order data.....	169
Table 105:	5CASDL.0008-00, 5CASDL.0018-00, 5CASDL.0050-00, 5CASDL.0100-00, 5CASDL.0150-00, 5CASDL.0200-00, 5CASDL.0250-00, 5CASDL.0300-00 - Technical data.....	169
Table 106:	5CASDL.0018-01, 5CASDL.0050-01, 5CASDL.0100-01, 5CASDL.0150-01 - Order data.....	172
Table 107:	5CASDL.0018-01, 5CASDL.0050-01, 5CASDL.0100-01, 5CASDL.0150-01 - Technical data..	172
Table 108:	5CASDL.0018-03, 5CASDL.0050-03, 5CASDL.0100-03, 5CASDL.0150-03, 5CASDL.0200-03, 5CASDL.0250-03, 5CASDL.0300-03 - Order data.....	175
Table 109:	5CASDL.0018-03, 5CASDL.0050-03, 5CASDL.0100-03, 5CASDL.0150-03, 5CASDL.0200-03, 5CASDL.0250-03, 5CASDL.0300-03 - Technical data.....	175
Table 110:	5CASDL.0xxx-03 SDL flex cables - Construction.....	178
Table 111:	5CASDL.0300-13, 5CASDL.0400-13, 5CASDL.0430-13 - Order data.....	180

Table 112:	5CASDL.0300-13, 5CASDL.0400-13, 5CASDL.0430-13 - Technical data.....	180
Table 113:	5CASD3.0030-00, 5CASD3.0050-00, 5CASD3.0100-00, 5CASD3.0150-00, 5CASD3.0200-00, 5CASD3.0300-00, 5CASD3.0500-00, 5CASD3.1000-00 - Order data.....	184
Table 114:	5CASD3.0030-00, 5CASD3.0050-00, 5CASD3.0100-00, 5CASD3.0150-00, 5CASD3.0200-00, 5CASD3.0300-00, 5CASD3.0500-00, 5CASD3.1000-00 - Technical data.....	184
Table 115:	5CAUSB.0018-00, 5CAUSB.0050-00 - Order data.....	187
Table 116:	5CAUSB.0018-00, 5CAUSB.0050-00 - Technical data.....	187
Table 117:	9A0014.02, 9A0014.05, 9A0014.10 - Order data.....	189
Table 118:	9A0014.02, 9A0014.05, 9A0014.10 - Technical data.....	189
Table 119:	5AC804.MFLT-00 - Order data.....	191
Table 120:	5AC804.MFLT-00 - Technical data.....	191
Table 121:	5AC900.BLOC-00 - Order data.....	193
Table 122:	5AC900.BLOC-01 - Order data.....	193
Table 123:	5AC900.1201-00 - Order data.....	194
Table 124:	5AC900.1201-01 - Order data.....	194
Table 125:	Abbreviations used in this user's manual.....	197
Table 126:	5-wire AMT touch screen - Technical data.....	202
Table 127:	3M touch screen - Technical data.....	203

0TB103.9.....	160
0TB103.91.....	160
5AC804.MFLT-00.....	191
5AC900.1201-00.....	194
5AC900.1201-01.....	194
5AC900.BLOC-00.....	193
5AC900.BLOC-01.....	193
5AP1120.0573-000.....	70
5AP1120.0702-000.....	76
5AP1120.101E-000.....	80
5AP1120.1043-000.....	84
5AP1120.1214-000.....	96
5AP1120.121E-000.....	99
5AP1120.1505-000.....	103
5AP1120.156B-000.....	113
5AP1120.1906-000.....	119
5AP1130.0702-000.....	78
5AP1130.101E-000.....	82
5AP1130.121E-000.....	101
5AP1130.156C-000.....	115
5AP1130.185C-000.....	117
5AP1151.0573-000.....	73
5AP1180.1043-000.....	87
5AP1180.1505-000.....	106
5AP1181.1043-000.....	90
5AP1181.1505-000.....	109
5AP1182.1043-000.....	93
5CADVI.0018-00.....	166
5CADVI.0050-00.....	166
5CADVI.0100-00.....	166
5CASD3.0030-00.....	184
5CASD3.0050-00.....	184
5CASD3.0100-00.....	184
5CASD3.0150-00.....	184
5CASD3.0200-00.....	184
5CASD3.0300-00.....	184
5CASD3.0500-00.....	184
5CASD3.1000-00.....	184
5CASDL.0008-00.....	169
5CASDL.0018-00.....	169
5CASDL.0018-01.....	172
5CASDL.0018-03.....	175
5CASDL.0050-00.....	169
5CASDL.0050-01.....	172
5CASDL.0050-03.....	175
5CASDL.0100-00.....	169
5CASDL.0100-01.....	172
5CASDL.0100-03.....	175
5CASDL.0150-00.....	169
5CASDL.0150-01.....	172
5CASDL.0150-03.....	175
5CASDL.0200-00.....	169
5CASDL.0200-03.....	175
5CASDL.0250-00.....	169
5CASDL.0250-03.....	175
5CASDL.0300-00.....	169
5CASDL.0300-03.....	175
5CASDL.0300-13.....	180
5CASDL.0400-13.....	180
5CASDL.0430-13.....	180
5CAUSB.0018-00.....	187
5CAUSB.0050-00.....	187

5DLSD3.1001-00.....	124
5DLSD4.1001-00.....	126
5DLSDL.1001-00.....	122
5MMUSB.032G-02.....	164
5MMUSB.2048-01.....	162
5MMUSB.4096-01.....	162
5SWUTI.0001-000.....	150
9A0014.02.....	189
9A0014.05.....	189
9A0014.10.....	189

A

Accessories.....	160
ADI.....	144
.NET SDK.....	147
Development Kit.....	146
Adjusting the display brightness.....	141
Ambient temperature during operation.....	31
AP1000.....	60
AP900.....	60
Automation Runtime.....	143

B

B&R Automation Device Interface.....	144
B&R Control Center.....	144
B&R KCF Editor.....	149
B&R Key Editor.....	148
Backlight.....	45
Bend radius.....	137
Bend radius specifications.....	137
Block diagrams.....	39
Brightness.....	45
Brightness controls.....	45

C

Cable connections.....	137
Cable lengths.....	43, 43
Cables.....	166
DVI.....	166
RS232.....	189
SDL.....	169
SDL3.....	184
SDL flex.....	175
SDL flex cables with extender.....	180
SDL with 45° male connector.....	172
USB.....	187
CE marking.....	151
Certifications.....	152, 153, 153
EAC.....	152
Germanischer Lloyd.....	153
GOST-R.....	152
UL.....	152
UL Haz. Loc.....	154
Chemical resistance.....	198
Clamping blocks.....	193
Cleaning.....	195
COM.....	45
Compatibility.....	60
Compatibility overview.....	60
Complaints.....	196
Complete system.....	18
Conduct interference.....	136
Configuration.....	17
Control Center.....	144
Creating reports.....	144
Cutout tolerance.....	60, 62, 64, 66, 67, 68, 68, 69

D	
DC power cable.....	134
Defective pixels.....	196
Det Norske Veritas Germanischer Lloyd.....	153
Device compatibility.....	60, 60
Dimensions.....	23, 24, 23, 24
Dimension standards.....	13
Display brightness.....	141
Disposal.....	12, 12
DNV GL certification.....	153
DVI cables.....	166
DVI mode	
With multi-touch Automation Panel.....	20
DVI operation.....	20
With single-touch Automation Panel.....	20
DVI transfer.....	43, 43
E	
EAC.....	152
Electrical characteristics.....	37
Block diagrams.....	39
Power calculation.....	38
Electromagnetic compatibility.....	151
EMC directive.....	151
Environmental characteristics.....	31
Ambient temperature during storage and transport.....	32
Humidity.....	35
Maximum ambient temperature during operation.....	31
Minimum ambient temperature during operation.....	32
Protection.....	36
Shock.....	35
Temperature.....	31
Temperature sensors.....	34
Vibration.....	35
ESD.....	10
Electrical components with a housing.....	10
Electrical components without a housing.....	10
Individual components.....	10
Packaging.....	10
F	
Front USB.....	59
Front USB interface.....	59
Functional ground.....	41, 47, 51, 136
G	
General tolerance.....	13
GOST-R.....	152
Gosudarstvenny standard.....	152
Ground connection.....	41, 47, 51
Grounding.....	41, 47, 51, 136
Guidelines.....	13
H	
HMI Service Center.....	149
Humidity.....	35

I	
Image persistence.....	196
Immunity to interference.....	136
Installation	
Link module.....	133
Installation diagrams.....	25, 26, 25, 26
Installing the DC power cable.....	134
Interfaces	
+24 VDC power supply.....	37, 41, 47, 51
Grounding.....	41, 47, 51
Panel In.....	42
SDL3 In.....	48
SDL4 In.....	52
USB.....	44, 49, 59
USB In interface.....	45
K	
KC.....	153
KCF Editor.....	149
Key Editor.....	148
L	
LEDs.....	48, 52
Line filter.....	191
Link module.....	16, 17
Link modules.....	122
M	
Mechanical characteristics.....	23
Dimensions.....	23
Installation diagrams.....	25
Mounting orientations.....	28
Spacing for air circulation.....	27
Weight specifications.....	30
Mounting an Automation Panel 1000 with clamping blocks.....	131
Mounting an Automation Panel 1000 with retaining clips.....	129
Mounting compatibility.....	60
Multi-touch.....	140
Multi-touch drivers.....	142
Multi-touch generation 3.....	203
P	
Panel.....	16
Panel In interface.....	42
Panel overlay.....	199
Panels.....	70
Pixel errors.....	196
Power calculation.....	38, 38
Power connectors.....	160
Power grid connection	
DC power cable.....	134
Power rating.....	38
Power supply.....	37, 41, 47, 51
PP100/200.....	60
PP300/400.....	60
PP500.....	60

PPC700.....	60
PPC800.....	60
Proper ESD handling.....	10
Protection.....	36

R

RCM.....	153
Relative humidity.....	35
Repairs.....	196
Replacement parts.....	196
Replacing link modules.....	133
Resolution for DVI transfer.....	43
RS232 cables.....	189

S

Safety guidelines.....	10, 11
Environmental conditions.....	11
Environmentally friendly disposal.....	12
Installation.....	11
Intended use.....	10
Operation.....	11
Policies and procedures.....	10
Protection against electrostatic discharge.....	10
Separation of materials.....	12
Transport and storage.....	11
Screen burn-in.....	196
SDL3/SDL4 cables.....	184
SDL3 In interface.....	48
SDL3 In LEDs.....	48
SDL3 mode.....	21
With SDL3 transmitter.....	21
SDL3 resolution.....	48
SDL4 In interface.....	52
SDL4 In LEDs.....	52
SDL cables.....	169
SDL cables with 45° male connector.....	172
SDL flex cables.....	175
SDL flex cables with extender.....	180
SDL operation.....	18
Mode 1.....	18
Mode 2.....	19
SDL resolution.....	43
SDL transmission.....	43, 43
Serial interface.....	45
Service Center.....	149
Service life of the display.....	196
Shock.....	35, 35
Shortened name.....	60
Shortened product names.....	60
Single-touch.....	202
Software versions.....	144
Space for air circulation.....	25
Spacing specifications for air circulation.....	27
Standards and guidelines.....	151
Switching on the device for the first time.....	138

T

Temperature monitoring.....	33
-----------------------------	----

Temperature sensor positions.....	34
Temperature specifications.....	3, 3
Tolerance.....	60, 62, 64, 66, 67, 68, 68, 69
Total power.....	38
Touch screen.....	202, 203
Touch screen calibration.....	139
Type 4X indoor use only.....	36

U

UL 50.....	36
UL certification.....	152
UL Haz. Loc. certification.....	154
Universal Serial Bus 2.0.....	53
Upgrade	
Firmware.....	142
Upgrade information.....	142
Upgrading the firmware.....	142
USB.....	53
USB 2.0.....	44, 49, 59
USB cables.....	187
USB flash drive.....	162
USB In interface.....	45
USB interface.....	59
USB interfaces.....	44, 49, 53
User serial ID.....	145

V

Vibration.....	35, 35
Video signal.....	42, 48, 52
Viewing angles.....	197

W

Wiring.....	134
-------------	-----