

SA1U Heavy-duty Photoelectric Sensor

Features

- Four sensing methods:
 - Through-beam
 - Polarized retro-reflective
 - Diffuse
 - Background suppression
- Up to 50m sensing range
- Universal voltage type: 24 to 240V AC / 12 to 240V DC
- DC voltage type: 12 - 24V DC
- IP67
- Adjustable time delay: 0.1 to 5 seconds
- Operation and stable LED indicators
- NO/NC relay output, 3A
- Interference prevention allows two units to be mounted in close proximity (polarized retro-reflective, diffuse and background suppression)
- Spring-up terminal block structure enables easy wiring



Part Numbers

Sensing Method	Detectable Object	Sensing Range	Power Voltage	Control Output	Included Accessories	Time Delay Functions	Part Numbers
Through-beam 	Opaque	50m max.	24 to 240V AC (50/60Hz) 12 to 240V DC	Relay contact SPDT 250V AC/3A, 30V DC/3A (resistive load)	Sensitivity control screwdriver Mounting bracket Gland, gland washer Gland gaskets*	Without	SA1U-T50M
			12 to 24V DC	NPN/PNP open collector		With	SA1U-T50MT
Polarized Retro-reflective 	Opaque Mirror surface	7m max.	24 to 240V AC (50/60Hz) 12 to 240V DC	Relay contact SPDT 250V AC/3A, 30V DC/3A (resistive load)	Sensitivity control screwdriver Reflector (IAC-R5) Mounting bracket Gland, gland washer Gland gaskets*	Without	SA1U-P07M
			12 to 24V DC	NPN/PNP open collector		With	SA1U-P07MT
Diffuse 	Opaque Transparent	1m max.	24 to 240V AC (50/60Hz) 12 to 240V DC	Relay contact SPDT 250V AC/3A, 30V DC/3A (resistive load)	Sensitivity control screwdriver Mounting bracket Gland, gland washer Gland gaskets*	Without	SA1U-D01M
			12 to 24V DC	NPN/PNP open collector		With	SA1U-D01MT
Background Suppression 	Opaque	2m max.	24 to 240V AC (50/60Hz) 12 to 240V DC	Relay contact SPDT 250V AC/3A, 30V DC/3A (resistive load)	Sensitivity control screwdriver Mounting bracket Gland, gland washer Gland gaskets*	Without	SA1U-B02M
			12 to 24V DC	NPN/PNP open collector		With	SA1U-B02MT

*Two different-size gland gaskets are supplied. Select according to the cable diameter.

Small hole gasket: cable diameter ø8 to ø9 mm

Large hole gasket: cable diameter ø9 to ø10 mm

Specifications

Universal Voltage

Sensing Method	Through-beam	Polarized Retro-reflective	Diffuse	Background Suppression
Part Number	SA1U-T50M, SA1U-T50MT	SA1U-P07M, SA1U-P07MT	SA1U-D01M, SA1U-D01MT	SA1U-B02M, SA1U-B02MT
Power Voltage	24 to 240V AC (21.6 to 264V AC) 50/60Hz, 12 to 240V DC (10.8 to 264V DC)			
Power Consumption	Projector: 3 VA maximum Receiver: 3 VA maximum		3 VA maximum	
Control Output	Relay contact SPDT, switching capacity: 250V AC/3A (resistive load), 30V DC/3A (resistive load) Electrical life (minimum operations): 100,000 (NO contact), 50,000 (NC contact) Mechanical life (minimum operations): 50,000,000			
Minimum Applicable Load	5V DC, 10 mA minimum (reference value)			
Response Time	20 ms maximum			
Insulation Resistance	Between power and output terminals: 20 MΩ minimum (500V DC megger)			
Dielectric Strength	Between power and output terminals: 1500V AC, 1 minute, Between output terminals: 750V AC, 1 minute			
Weight (approx.)	Projector: 115g, Receiver: 130g		130g	

DC Power Type

Sensing Method	Through-Beam	Polarized Retro-reflective	Diffuse	Background Suppression
Part Number	SA1U-T50MW SA1U-T50MWT	SA1U-P07MW SA1U-P07MWT	SA1U-D01MW SA1U-D01MWT	SA1U-B02MW SA1U-B02MWT
Power Voltage	12 to 24V DC (10 to 30V DC) ripple rate 10% p-p maximum			
Current Draw	Projector: 20mA max Receiver: 25mA max	30mA maximum		
Control Output	Type	NPN, PNP open collector (dual output)		
	Load Current	NPN: 100 mA maximum, PNP: 100mA maximum		
	Applied Voltage	30V DC maximum		
	Voltage Drop	NPN: 2.4V maximum, PNP: 2.4V maximum		
Response Time	1 ms maximum			
Insulation Resistance	Between live and dead parts: 20MΩ minimum (500V DC megger)			
Dielectric Strength	Between live and dead parts: 1000V AC, 1 minute			
Weight (approx.)	Projector: 105g, Receiver: 110g	110g		

General Specifications

Sensing Method	Through-beam	Polarized Retro-reflective	Diffuse	Background Suppression
Sensing Distance	50m maximum	0.2 to 7m (when using supplied reflector IAC-R5)	1m maximum (200 × 200mm white matte paper)	0.2 to 2m (200 × 200 mm white matte paper)
Preset Distance		—		0.4 to 2m (200 × 200 mm white matte paper)
Detectable Object	Opaque	Opaque/Mirror surface	Opaque/Transparent	Opaque
Hysteresis	—	—	20% of sensing distance max.	15% of sensing distance max.
Operation Mode	Light ON or Dark ON (mode selector)			
Control Output	[Projector]Power LED: Green [Receiver] Operation LED: Yellow Stable LED: Green	Operation LED: Yellow Stable LED: Green		Operation LED: Yellow
Light Emitting Element	Infrared LED (870nm)	Red LED (660 nm)	Infrared LED (870 nm)	
Sensitivity Adjustment	1-turn control knob			8-turn control knob
Extraneous Light Immunity	Sunlight: 10,000 lux maximum, Incandescent lamp: 5,000 lux maximum			
Vibration Resistance	Damage limits: 10 to 55Hz, amplitude 1.5mm, 30 minutes in each axis			
Shock Resistance	Damage limits: 500 m/s ² (50G), 3 shocks each in 6 axes 3 consecutive times			
Operating Temperature	-25 to +60°C (no freezing), storage temperature: -40 to +70°C			
Operating Humidity	35 to 85% RH (no condensation), storage humidity: 35 to 85% RH			
Connection Method	Terminal block with M3 spring-up terminals			
Applicable Cable	Outside diameter ø8 to ø10 mm (core 0.3 to 0.75mm ²)			
Cable Extension	Extendable up to 100m with a cable of 0.3mm ² minimum			
Housing Material	PBT (indicator cover: PC)			
Lens Material	PC/PET	PMMA	PC/PET	
Degree of Protection	IP67 (IEC/EN60529)			

Time Delay Specifications

Sensing Method	Through-beam	Polarized Retro-reflective	Diffuse	Background Suppression
Part Number	SA1U-T50MT	SA1U-P07MT	SA1U-D01MT	SA1U-B02MT
Time Range	0.1 to 5.0 sec (adjusted with a 1-turn control knob)			
Time Delay Function	One shot, ON delay, OFF delay, and normal (no time delay operation) modes			
Temperature Effect of Time Delay	±10% maximum of the time delay at 20°C temperature rise within the operating temperature range			
Repetitive Accuracy of Time Delay	±1.0% maximum of the time delay for repetitive inputs at 10 seconds or more			

Dimensions (mm)

SA1U

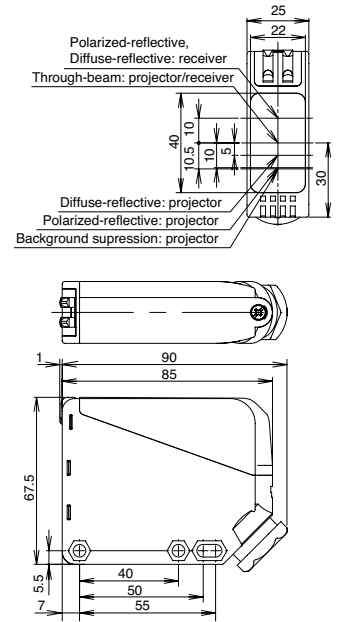

SA1U with Mounting Bracket

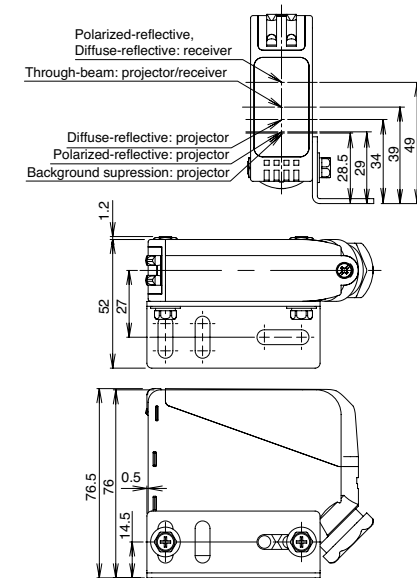

Mounting Bracket

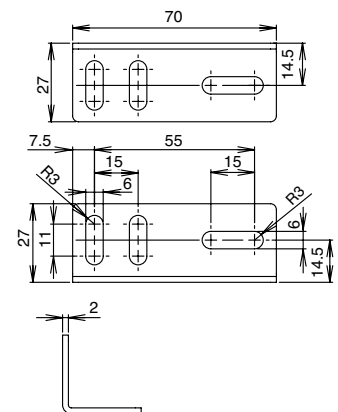

Models

Without Time Delay

SA1U-T50M
SA1U-P07M
SA1U-D01M

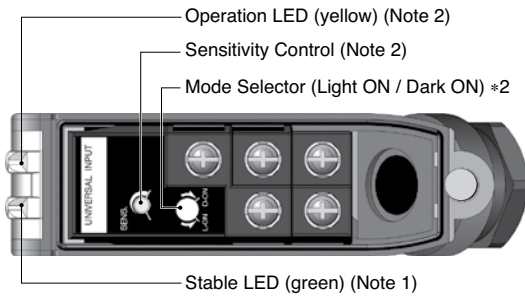

SA1U-B02M

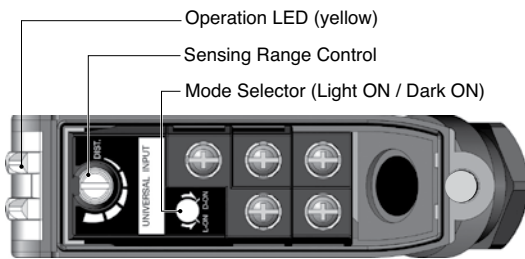

*1: Power LED for through-beam projector
*2: Not available on through-beam projector

Output Circuit / Connection Diagram

Universal Voltage Type

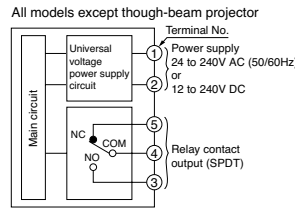

DC Voltage Type

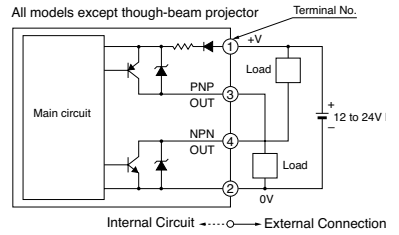

Though-beam projector

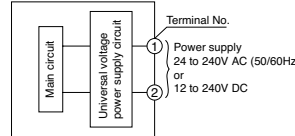

Though-beam projector

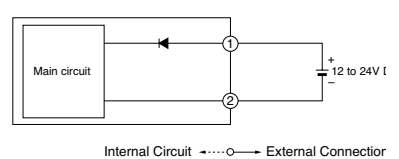

Terminal Arrangement

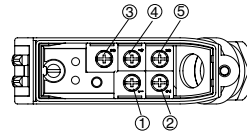

Operation Chart

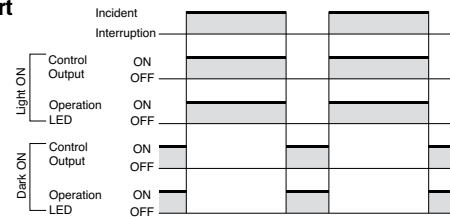

With Time Delay

SA1U-T50MT
SA1U-P07MT
SA1U-D01MT

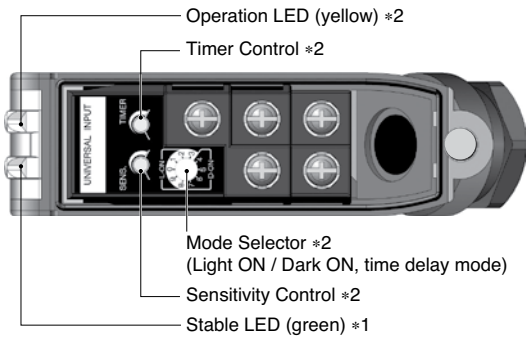

SA1U-B02MT

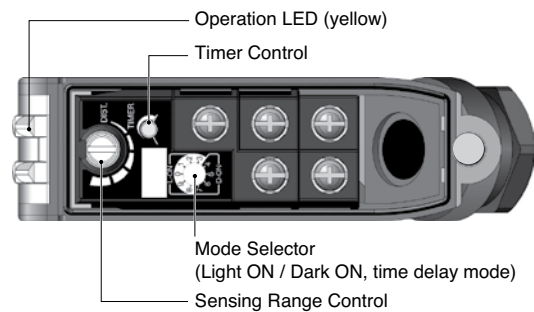

*1: Power LED for through-beam projector
*2: Not available on through-beam projector

Output Circuit / Connection Diagram

See the "Output Circuit / Connection Diagram" diagram above.

Terminal Arrangement

See the "Terminal Arrangement" diagram above.

Operation Chart

Operation Mode	Mode Selector Position	Incident Interruption	Control Output	Operation LED
Light ON	OFF delay (0)	ON	ON (delay T)	ON (delay T)
	Normal (1)	ON	ON	ON
	One shot (2)	ON	ON (pulse T)	ON (pulse T)
	ON delay (3)	ON	ON (delay T)	ON (delay T)
Dark ON	OFF delay (4)	ON	OFF (delay T)	OFF (delay T)
	Normal (5)	ON	OFF	OFF
	One shot (6)	ON	OFF (pulse T)	OFF (pulse T)
	ON delay (7)	ON	OFF (delay T)	OFF (delay T)
Light ON	Normal (8)	ON	ON	ON
	Normal (9)	OFF	ON	ON

Characteristics (Typical)

Through-beam SA1U-T50M

Excess Gain
(transparency 1% ND filter is used)

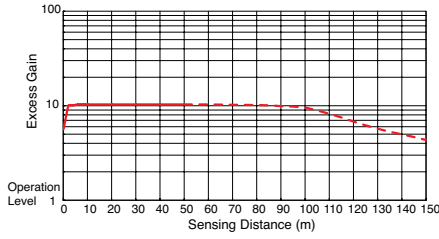

Lateral Displacement
(transparency 2.8% ND filter is used)

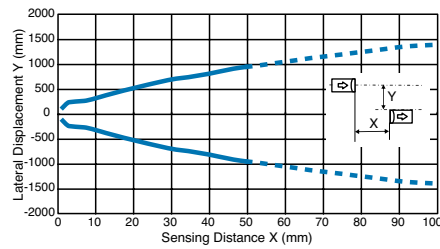

Angle

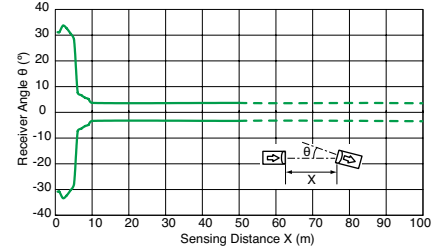

Polarized Retro-reflective SA1U-P07M

Excess Gain

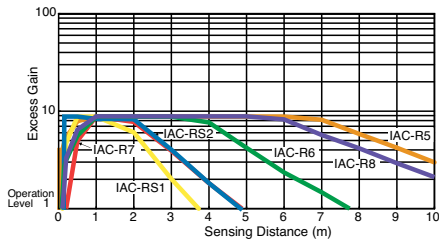

Lateral Displacement

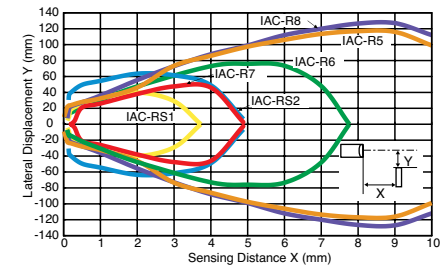

Angle

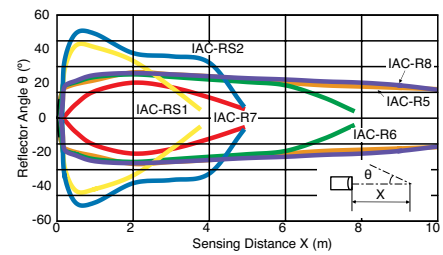

Diffuse SA1U-D01M

Excess Gain

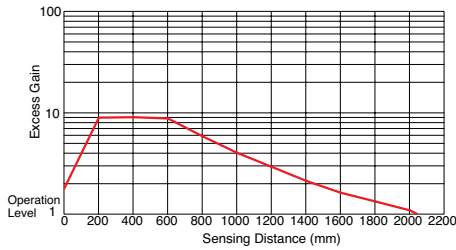

Lateral Displacement

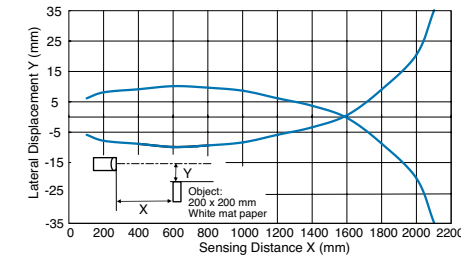

Object Size vs. Sensing Distance

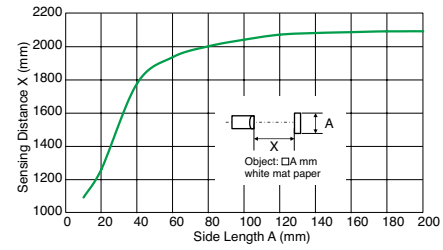

Background Suppression SA1U-B02M

Lateral Displacement (preset 1m)

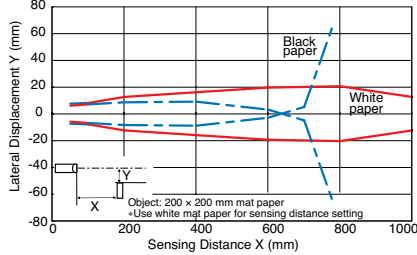

Lateral Displacement (preset 2m)

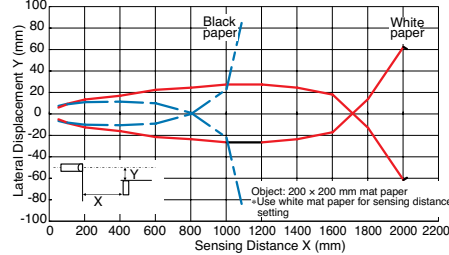

Light Beam Diameter

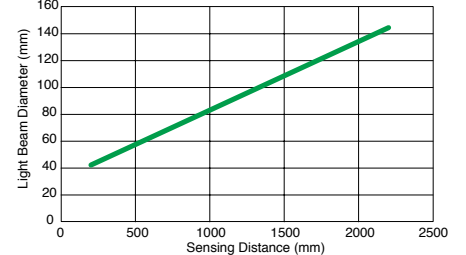

Sensing Distance vs. Hysteresis

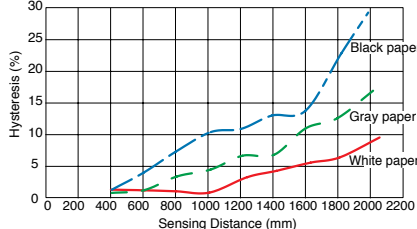

Control Knob vs. Sensing Distance

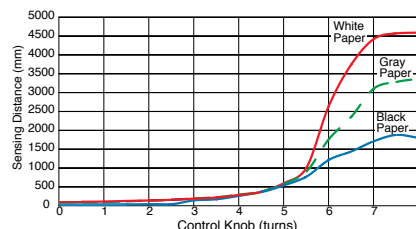

Colored Matte Paper and Other Materials

