



RJ Series Relays

Features

- Compact size:
Blade: 12.7 x 27 x 28.8 mm
PCB: 12.7 x 25.5 x 28.8 mm
- Contact rating:
Blade: 8A (DPDT), 12A (SPDT)
PCB: 8A (DPDT & DPST-NO), 12A (SPDT & SPST-NO),
16A (SPDT & SPST-NO)
- Operational life:
200K cycles at full resistive AC load;
50 million cycles, no load
- Blade model has optional green, non-polarized LED
- RoHS compliant



Specifications

	Blade Models		PCB Models		
	RJ1S	RJ2S	RJ1V	RJ1V (High Capacity)	RJ2V
No. of poles	1	2	1	1	2
Contact Configuration	SPDT	DPDT	SPDT, SPST-NO		DPDT, DPST-NO
Contact Rating	12A	8A	12A	16A	8A
Contact Material	AgNi		AgNi	AgSnIn	AgNi
Enclosure Ratings	-		Flux protection		
Contact Resistance	50 milliohms max		50 milliohms max ^{Note 1}		
Operating Time	15ms max		15ms max ^{Note 2}		
Release Time	10ms max		10ms max ^{Note 2}		
Dielectric Strength	Between contact & coil		5,000V AC, 1 minute		
	Between contacts of same poles		1,000V AC, 1 minute		
	Between contacts of different poles		-	3,000V AC, 1 min.	-
Vibration Resistance	Damage limits		10-55Hz, amplitude 0.75mm		
	Operating extremes		10-55Hz, amplitude 0.75mm		
Shock Resistance	Damage limits		100m/s ² min (10G)		
	Operating extremes		1,000m/s ² min (100G)		
Mechanical Life	AC		30,000,000 operations		
	DC		50,000,000 operations		
Electrical Life @ Full Rated Load	AC		200,000 operations		
	DC		100,000 operations		
Operating Temperature	-40 to 70° C		-40 to 70° C ^{Note 3}		
Operating Humidity	5 to 85% RH		5 to 85% RH		
Dimensions (H x W x D mm)	12.7 x 27 x 28.8		12.7 x 25.5 x 28.8		
Weight (Approx.)	19g		SPDT: 17g, SPST-NO: 16g		DPDT: 17g, DPST-NO: 16g

General Information



- Notes:
1. Measured using 5V DC, 1A voltage drop method.
 2. Measured at the rated voltage (at 20°C), excluding contact bounce time.
 3. 100% rated voltage.

Ordering Information

Blade Models

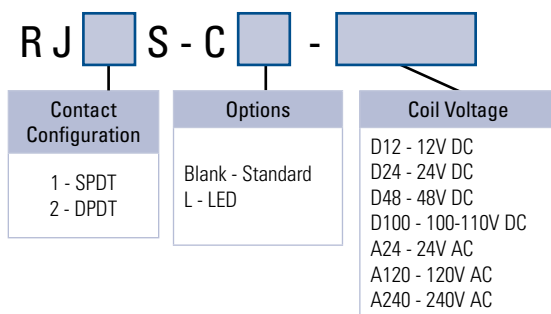

PCB Models

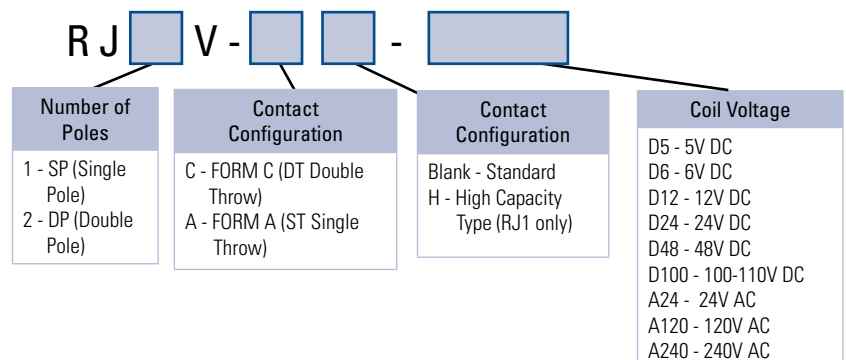

Contact Ratings

Contact Ratings	Type	Contact	Allowable Contact Power		Rated Load			Allowable Switching Current	Allowable Switching Voltage	Minimum Applicable Load				
			Resistive Load	Inductive Load	Voltage	Resistive Load	Inductive Load cos _φ =0.3 L/R=7ms							
Blade Models	1 pole	NO	AC3000V	AC1875VA	250V AC	12A	7.5A	6A	AC250V DC30V	DC5V 100mA				
		NC	AC3000V	AC1875VA	250V AC	12A	7.5A	6A/3A						
	2 poles	NO	AC2000V	AC1000VA	250V AC	8A	4A	4A	AC250V DC30V	DC5V 100mA				
		NC	AC2000V	AC1000VA	250V AC	8A	4A	4A/2A						
PCB Models	1 pole	Standard Type	NO	AC3000V	AC1875VA	AC250V	12A	7.5A	12A	AC250V DC125V	DC5V 100mA			
			DC360W	DC180W	DC30V	12A	6A							
			NC	AC3000V	AC1875VA	AC250V	12A	7.5A						
		DC180W	DC90W	DC30V	6A	3A								
		High Capacity Type	NO	AC4000V	AC2000VA	AC250V	16A	8A				16A	AC250V DC125V	DC5V 100mA
			DC480W	DC240W	DC30V	16A	8A							
	NC		AC4000V	AC2000VA	AC250V	16A	8A							
	DC240W	DC120W	DC30V	8A	4A									
	2 poles	NO	AC2000V	AC1000VA	AC250V	8A	4A	8A	AC250V DC125V	DC5V 10mA				
			DC240W	DC120W	DC30V	8A	4A							
			NC	AC2000V	AC1000VA	AC250V	8A				4A			
		DC240W	DC120W	DC30V	8A	4A								
NC		AC2000V	AC1000VA	AC250V	8A	4A								
		DC240W	DC120W	DC30V	8A	4A								
	DC120W	DC60W	DC30V	4A	2A									

Coil Ratings

Coil Ratings	Rated Voltage	Coil Voltage Code	Rated Current (mA) ±15% (at 20°C)				Coil Resistance (ohms)±10% (at 20°C)	Operating Characteristics ²			Power Consumption	
			Without LED ¹		With LED ¹			Minimum Pickup Voltage	Dropout Voltage	Maximum Allowable Voltage ³		
			50Hz	60Hz	50Hz	60Hz						
AC	Blade & PCB Models	24V	A24	43.9	37.5	47.5	41.1	243	80% max	30% min	140%	0.9VA (60Hz)
	120V	A120	8.8	7.5	8.7	7.4	6,400					
	240V	A240	4.3	3.7	4.3	3.7	25,570					
DC	Blade Models	12V	D12	44.2		48.0		271	70% max	10% min	170%	0.53W
		24V	D24	22.1		25.7		1,080				
		48V	D48	11.0		10.7		4,340				
		100-110V	D100	5.3 - 5.8		5.2 - 5.7		18,870				
	PCB Models	5V	D5	106		-		47.2	70% max	10% min	170%	0.53-0.64W
		6V	D6	88.3		-		67.9				
		12V	D12	44.2		-		271				
		24V	D24	22.1		-		1,080				
		48V	D48	11.0		-		4,340				
		100-110V	D100	5.3 - 5.8		-		18,870				

Notes:

- LED Indicator is only available on Blade relays.
- Operating characteristics are against rated values at 20°C.
- The maximum allowable voltage is the maximum value which can be applied to the relay coils.

Accessories

Socket Part Numbers

	Relay Type	Socket Type	Socket Part Number
Blade Models	RJ1S (Std)	DIN Rail Standard	SJ1S-05B
		DIN Rail Fingersafe	SJ1S-07L
	PCB Mount	SJ1S-61	
		DIN Rail Standard	SJ2S-05B
RJ1S-□H (HC), RJ2S	DIN Rail Fingersafe	SJ2S-07L	
	PCB Mount	SJ2S-61	
	DIN Rail Fingersafe	SQ1V-07B*	
PCB Models	RJ1V (Std)	PCB Mount	SQ1V-63
		DIN Rail Fingersafe	SQ2V-07B*
	RJ1V-□H (HC), RJ2V	PCB Mount	SQ2V-63

*Hold-down clip or spring must be removed to use with RJ relays.

Socket Specifications

	SJ1S	SJ2S
Rated Insulation Voltage	250V AC/DC	
Applicable Wire	Max up to 2 - #14 AWG	
Applicable Crimping Terminal	2mm ² x 2	
Screw Size	M3 Slotted-Phillips screw	
Weight	30g	34g



Socket Dimensions - for Blade Relays (mm)

SJ1S-05B

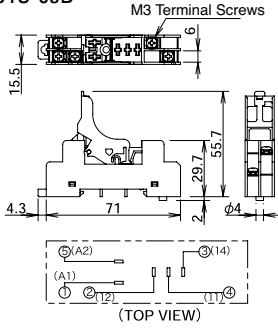

SJ1S-07L

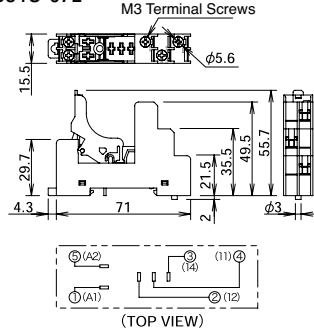

SJ1S-61

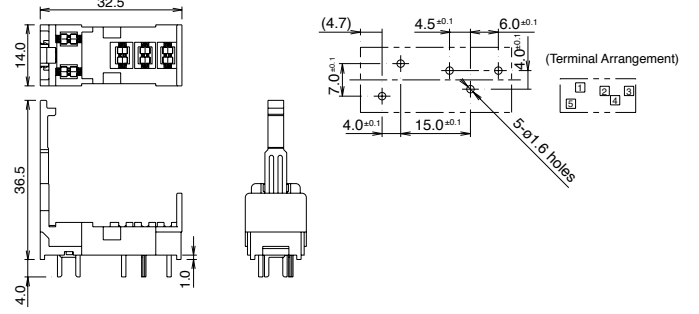

SJ2S-05B

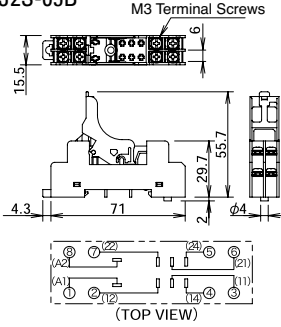

SJ2S-07L

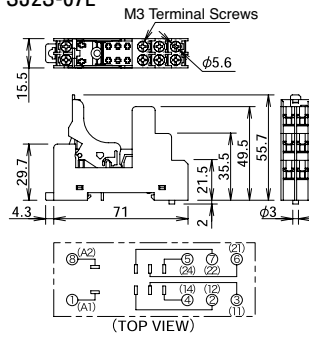

SJ1S-61

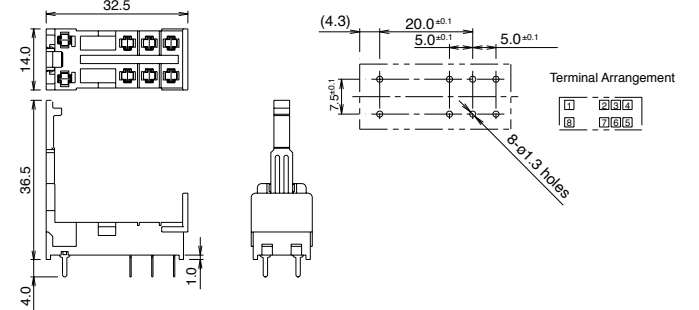

Blade Relay Dimensions (mm)

RJ1S

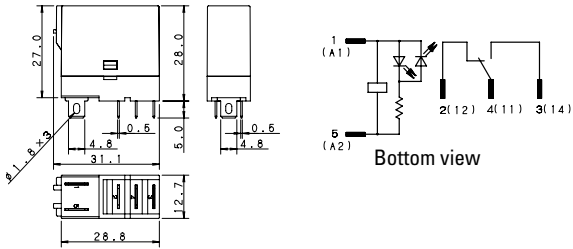

RJ2S

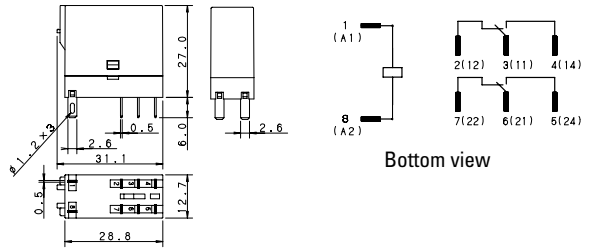

SQ Socket Dimensions - for PCB Relays (mm)

SQ1V-07B

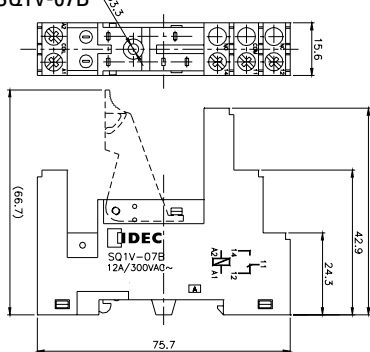

SQ2V-07B

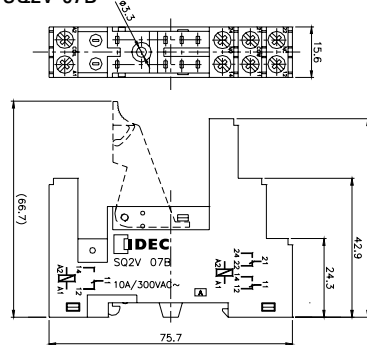

SQ1V-63

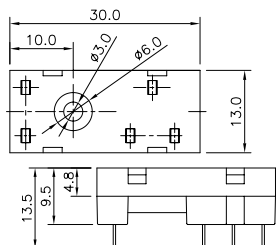

SQ1V-63 PCB pin layout

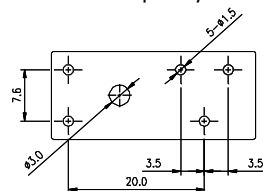

SQ2V-63

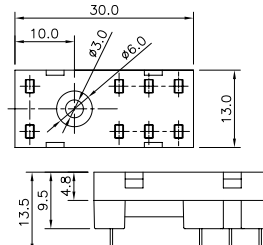

SQ2V-63 PCB pin layout

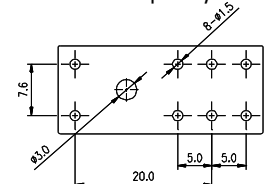

PCB Relay Dimensions (mm)

**PCB Mounting Hole Layout
(Bottom View)**

**PCB Internal Circuit Diagrams
(Bottom View)**

RJ1V-C-*
SPDT

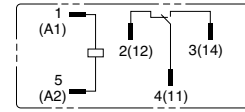
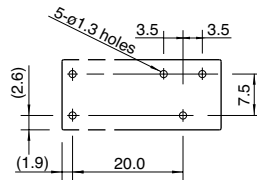
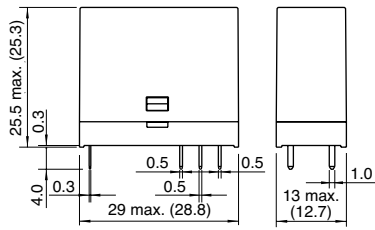

RJ1V-A-*
SPST-NO

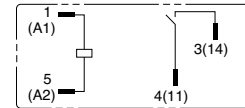
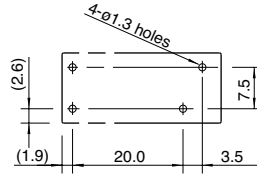
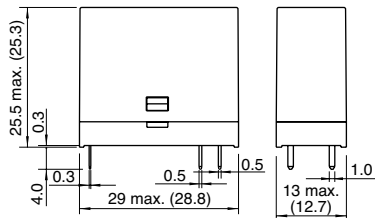

RJ1V-CH-*
SPDT
High Capacity

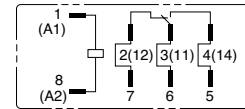
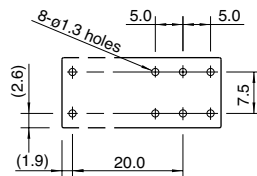
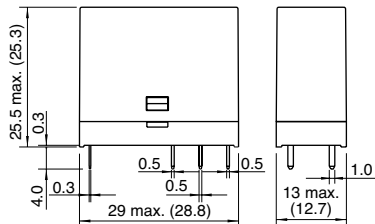

RJ1V-AH-*
SPST-NO
High Capacity

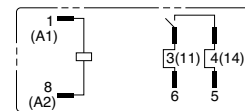
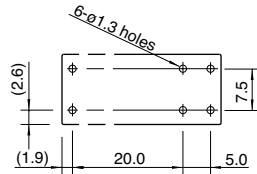
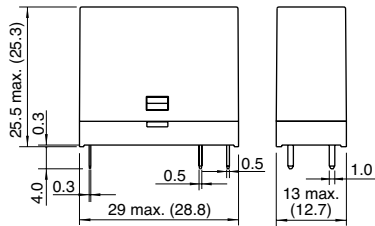

RJ2V-C-*
DPDT

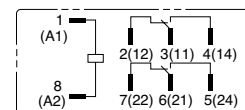
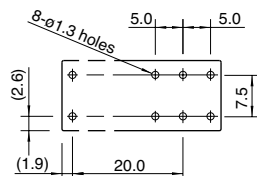
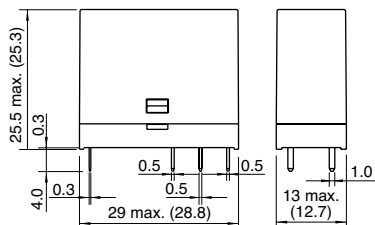

RJ1V-A-*
DPST-NO

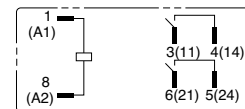
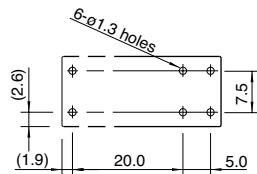
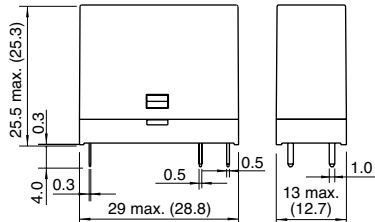

For more information on the these
and other IDEC relays, visit:

www.idec.com/relay