

RU Series — General Purpose Relays

Key features of the RU series include:

- Non-polarized LED indicator standard
- Solder-free construction (spot welded, no solder points, lead-free)
- No internal wires
- Mechanical flag indicator standard
- Manual latching lever with color coding for AC or DC coil
- Available without latching lever (or with momentary check button)
- Snap-on marking plate standard
- Cadmium-free contacts - RoHS compliant
- Color coded coils for visual distinction
- Contact rating 6A: 4PDT
10A: DPDT



Relays

	RU2	RU4
Contact Material	AgSn0In (silver tin oxide indium)	AuAg/Ag (gold-silver alloy on silver)
Contact Resistance	50 mΩ maximum	
Minimum Applicable Load	24VDC, 5mA (reference value)	1V DC, 1mA (standard) 1V DC, 0.1mA (bifurcated)
Operating Time	20 msec maximum	
Release Time	20 msec maximum	
Maximum Continuous Applied Voltage (AC/DC) at 20°C	110%	
Minimum Operating Voltage (AC/DC) at 20°C	80%	
Drop-Out Voltage (AC) at 20°C	30%	
Drop-Out Voltage (DC) at 20°C	10%	
Power Consumption	1.1-1.4VA (AC); 0.9-1.0W (DC)	
Dielectric Strength	Between contact and coil: 2,500VAC, 1 minute Between poles: 2,500VAC, 1 minute Between contacts of the same pole: 1,000VAC, 1 minute	Between contact and coil: 2,500VAC, 1 minute Between poles: 2,000VAC, 1 minute Between contacts of the same pole: 1,000VAC, 1 minute
Frequency Response	1,800 operations/hr	
Vibration Resistance	Operating extremes: 10 to 55Hz, Amplitude 1.0 mm p-p Damage limits: 10 to 55Hz, Amplitude 1.0 mm p-p	
Shock Resistance	Operating extremes: 150 m/s ² (15G) Damage limits: 1,000 m/s ² (100G)	
Life Expectancy	Mechanical: AC: 20,000,000 operations minimum DC: 30,000,000 operations minimum Electrical: see electrical life curve	
Degree of Protection	IP40	
Operating Temperature	-55 to +70°C (no freezing)	
Weight	35g	

Specifications

UL Recognized
File No. E66043, Vol 8, sec. 1
Vol 8, sec. 2

TÜV
PRODUCT SERVICE
B020813332451

CSA Certified
File No. LR35144-135844



Ordering Information

Consult factory for other voltages.

Basic Part No. **Coil Voltage:**
RU 4 S - () - D12

of Contacts **Coil Voltage Code****

2 = DPDT
4 = 4PDT
42 = 4PDT bifurcated contacts

Option*

(Blank) = with latching check button
C = without check button
M = momentary check button
D = surge suppression diode (DC coils only)

D12 = 12V DC
D24 = 24V DC
D110 = 110V DC
A24 = 24V AC
A110 = 110-120V AC
A220 = 220-240V AC

- *All come with bi-polar LED, mechanical flag indicator, marking plate.
- **Contact IDEC for other voltages.

Part Numbers

Part Numbers: RU Series with Options

Termination		Contact Configuration	Standard	Without Latching Lever	With Momentary Check Button	With Diode*
S: Solder/plugin	Standard	DPDT	RU2S	RU2S-C	RU2S-M	RU2S-D
		4PDT	RU4S	RU4S-C	RU4S-M	RU4S-D
	Bifurcated	4PDT	RU42S	RU42S-C	RU42S-M	RU42S-D



*DC coils only.

Part Numbers: Sockets

Relays	Spring Clamp DIN Rail Mount	Standard DIN Rail Mount	Finger-Safe DIN Rail Mount	Panel Mount	PC Mount	Springs & Clips (optional)	
						Part Number	Use With
RU2S	SU2S-11L	SM2S-05	SM2S-05C	SY4S-51	SY4S-61 SY4S-62	SFA-101① SFA-202② SY4S-02F1③	use with SY4S-05, -05C SM2S-05, -05C SU4S-11L, SU2S-11L
RU4S	SU4S-11L	SY4S-05	SY4S-05C			SFA-301① SFA-302② SY4S-51F1③	use with SY4S-51, -61

E
Relays



See Section F for details on sockets. All DIN rail mount sockets shown above can be mounted using DIN rail BNDN1000.



- ① Top latch
- ② Side latch
- ③ Pullover spring

Part Numbers: Marking Strip

Item	Part Number	Quantity
RU Marking Strip	RU9Z-P①PN10,	10 pieces per package



In place of ①, insert color code from chart at right.

Marking Strip Color Code

Color	Code	Color	Code
Yellow*	Y	Blue	S
Green	G	White	W
Amber	A		



*yellow marking strip standard on all RU relays.

Ratings

Coil Ratings

Rated Voltage	Voltage Code	Coil Tape Colors	Rated Current ±15% at 20°C	Coil Resistance ±10% at 20°C	Inrush Current	Inductance		
						Energizing	De-Energizing	
AC	24V	A24	white	37.5mA	164 Ω	60mA	1.8H	0.96H
	110-120V	A110	dark blue	8.4mA	4,550 Ω	14mA	36H	22H
	220-240V	A220	red	4.2mA	18,230Ω	7mA	144H	87H
DC	12V	D12	yellow*	83.3mA	160 Ω	N/A		
	24V	D24	green	41.7mA	605 Ω			
	110V	D110	yellow*	9.1mA	12, 100 Ω			



*Voltage printed in black.

Contact Ratings (Standard)

Voltage		Resistive	Inductive
30V DC	DPDT	10A	5A
	4PDT	6A	3A
110V DC	DPDT	0.6A	0.3A
	4PDT	0.4A	0.2A
120V AC	DPDT	10A	5A
	4PDT	6A	3A
240V AC	DPDT	10A	5A
	4PDT	6A	3A

Contact Ratings (Bifurcated)

Voltage		Resistive	Inductive
30V DC	4PDT	3A	1.5A
110V DC	4PDT	—	—
120V DC	4PDT	3A	0.8A
250V DC	4PDT	3A	0.8A

Internal Circuit*

RU2S Standard

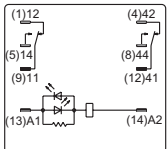

Over 24V AC/DC

RU2S-D with Diode

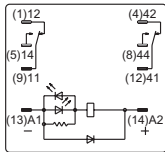

Over 24V DC

RU4S/RU42S Standard

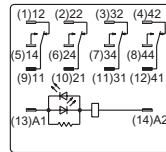

Over 24V AC/DC

RU4S-D/RU42S-D with Diode

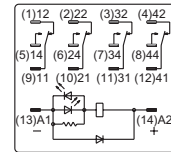

Over 24V DC

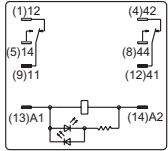

24V AC/DC or less

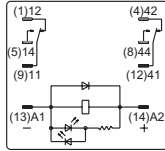

24V DC or less

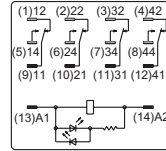

24V AC/DC or less

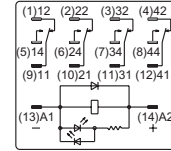

24V DC or less



Image as viewed from bottom of relay. Refer to socket for exact wiring layout (Section F).



Numbers not in parenthesis follow international system of labeling terminals.

Electrical Life Curves

RU2 (Resistive Load)

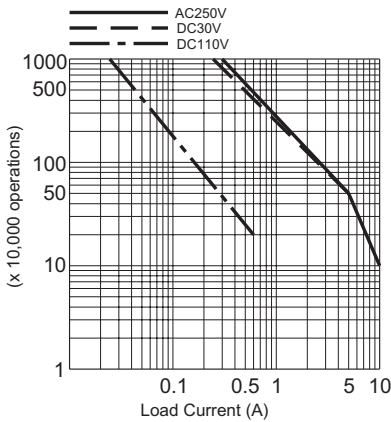

RU4 (Resistive Load)

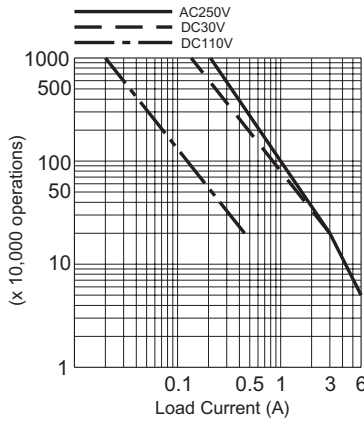

RU42 (Resistive Load)

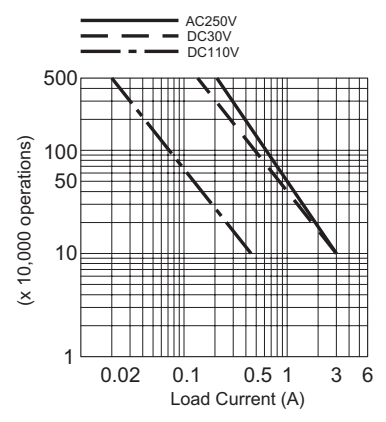

RU2 (Inductive Load)

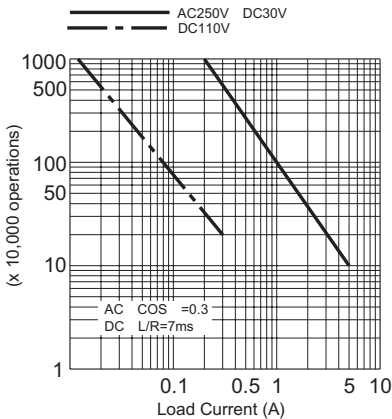

RU4 (Inductive Load)

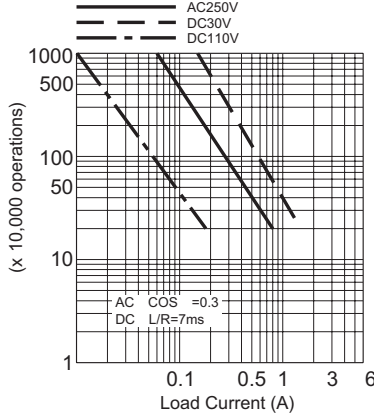

RU42 (Inductive Load)

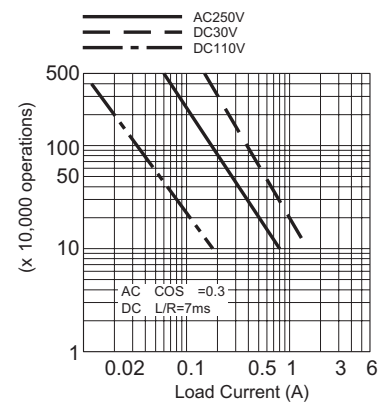

Maximum Switching Capacity

RU2 (Maximum Load)

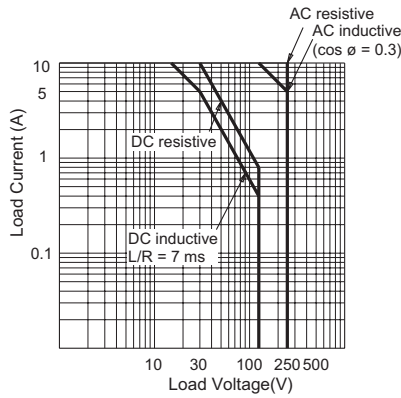

RU4 (Maximum Load)

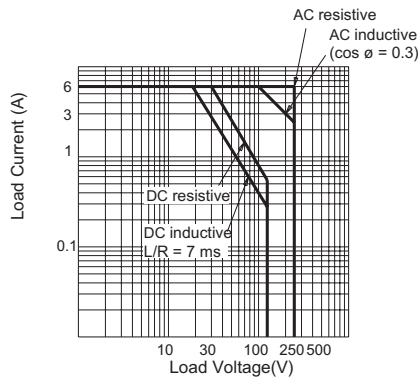

RU42 (Maximum Load)

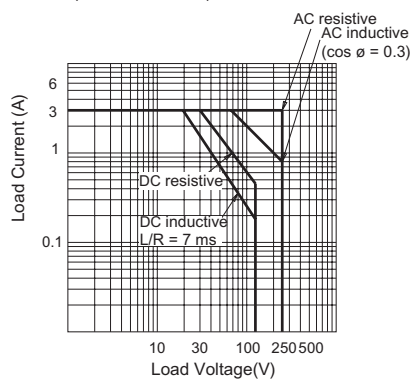

Dimensions & Mounting Hole Layouts

RU2 Dimensions

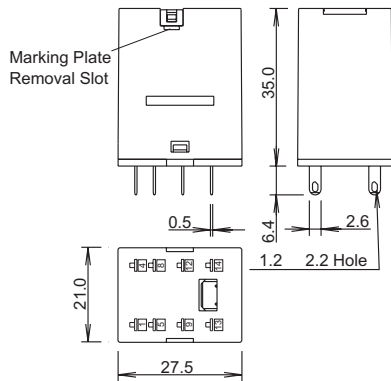

Marking plate removal slot is provided only on one side. Insert a flat screwdriver into the slot to remove the marking plate.

RU4/RU42 Dimensions

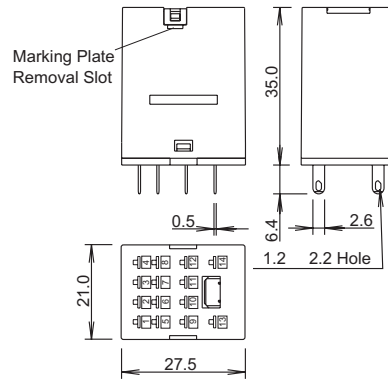

Marking plate removal slot is provided only on one side. Insert a flat screwdriver into the slot to remove the marking plate.

Dimensions are in mm.