

<b>BASIC CHARACTERISTICS</b> ( $T_{amb} = 25\text{ }^{\circ}\text{C}$ , unless otherwise specified)							
PARAMETER	TEST CONDITION	PART	SYMBOL	MIN.	TYP.	MAX.	UNIT
<b>INPUT (EMITTER)</b>							
Forward voltage	$I_F = 60\text{ mA}$		$V_F$		1.25	1.6	V
Junction capacitance	$V_R = 0\text{ V}$ , $f = 1\text{ MHz}$		$C_j$		50		pF
<b>OUTPUT (DETECTOR)</b>							
Collector emitter voltage	$I_C = 1\text{ mA}$		$V_{CEO}$	70			V
Emitter collector voltage	$I_E = 10\text{ }\mu\text{A}$		$V_{ECO}$	7			V
Collector dark current	$V_{CE} = 25\text{ V}$ , $I_F = 0\text{ A}$ , $E = 0\text{ lx}$		$I_{CEO}$			100	nA
<b>SWITCHING CHARACTERISTICS</b>							
Turn-on time	$I_C = 2\text{ mA}$ , $V_S = 5\text{ V}$ , $R_L = 100\text{ }\Omega$ (see figure 2)		$t_{on}$		10		$\mu\text{s}$
Turn-off time	$I_C = 2\text{ mA}$ , $V_S = 5\text{ V}$ , $R_L = 100\text{ }\Omega$ (see figure 2)		$t_{off}$		8		$\mu\text{s}$

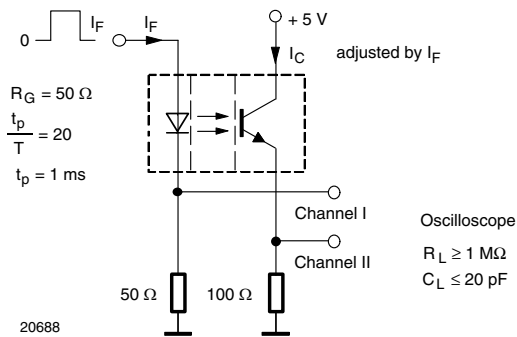
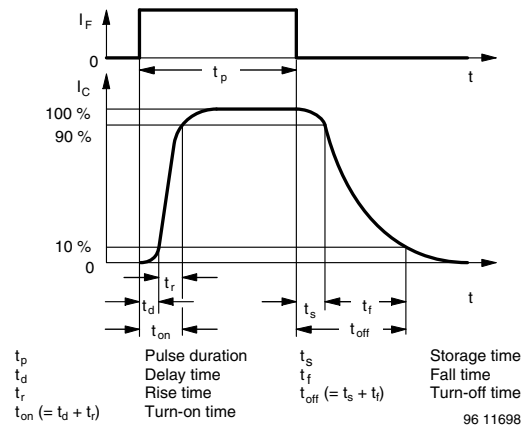

 Fig. 2 - Test Circuit for  $t_{on}$  and  $t_{off}$ 


Fig. 3 - Switching Times

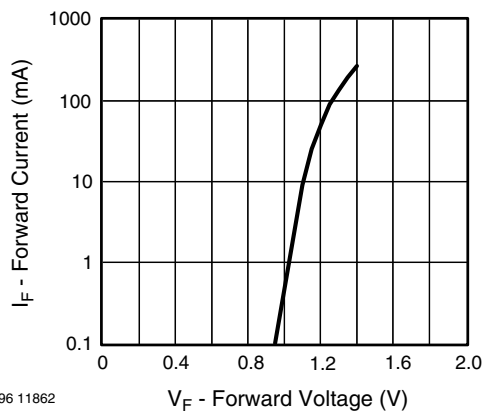
**BASIC CHARACTERISTICS** ( $T_{amb} = 25\text{ }^{\circ}\text{C}$ , unless otherwise specified)


Fig. 4 - Forward Current vs. Forward Voltage

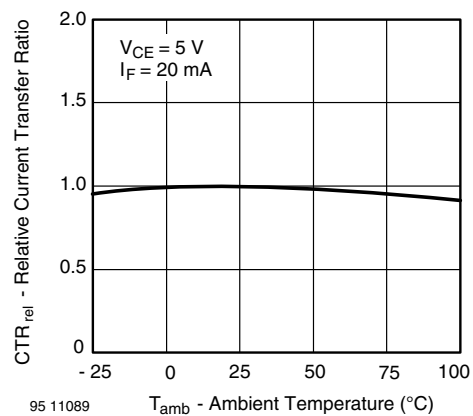


Fig. 5 - Relative Current Transfer Ratio vs. Ambient Temperature

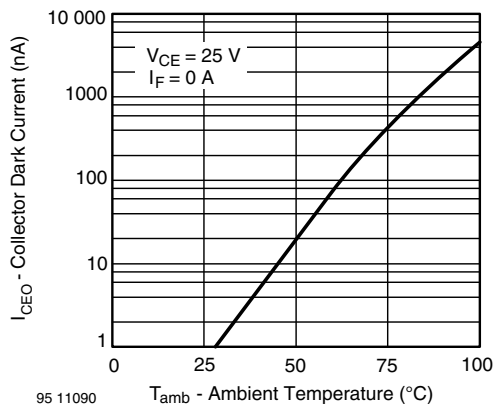


Fig. 6 - Collector Dark Current vs. Ambient Temperature

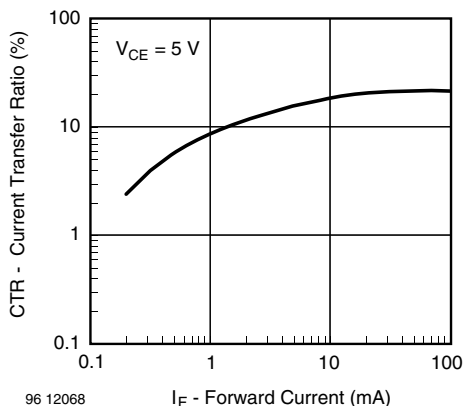


Fig. 9 - Current Transfer Ratio vs. Forward Current

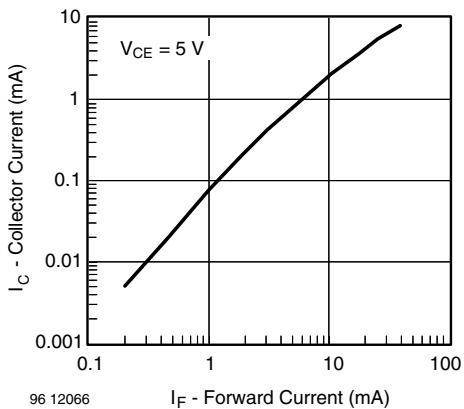


Fig. 7 - Collector Current vs. Forward Current

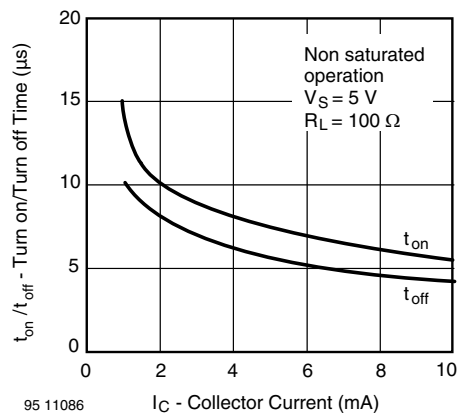


Fig. 10 - Turn-off/Turn-on Time vs. Collector Current

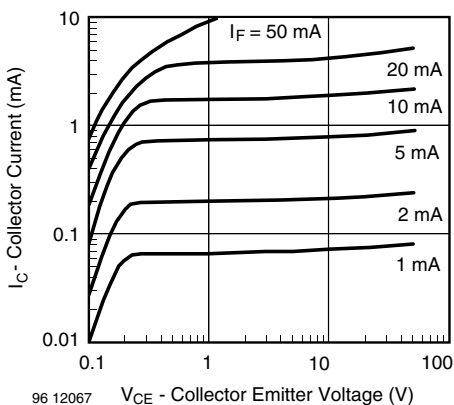


Fig. 8 - Collector Current vs. Collector Emitter Voltage

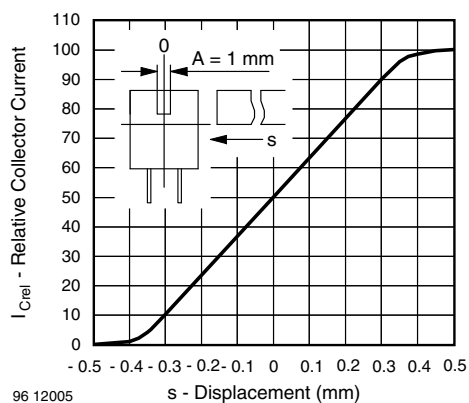


Fig. 11 - Relative Collector Current vs. Displacement