



157T Series – Standard Nano²® Fuse and Clip Assembly



Agency Approvals

AGENCY	AGENCY FILE NUMBER	AMPERE RANGE
	E14721	0.375A ~ 5A
	NBK030205-E10480B	1A - 5A

Electrical Characteristics for Series

% of Ampere Rating	% of Ampere Rating	Opening Time at 25°C
100%	0.375A ~ 5A	4 hours, Minimum
200%	0.375A ~ 5A	1 sec. Minimum, 60 secs. Maximum
300%	0.375A ~ 5A	0.20 secs. Minimum, 3.00 secs. Maximum
800%	0.375A ~ 5A	0.02 secs. Minimum, 0.10 secs. Maximum

Description

The 157T Series Fuse/Clip assembly is a small, square, Time-Lag, surface mount fuse that is assembled in surface mountable fuse clips. The unique time delay feature of this fuse design helps solve the problem of nuisance “opening” by accommodating inrush currents that normally cause a fast acting fuse to open.

The fuse clip and pre-installed fuse combination can be automatically placed in PC Board in one efficient manufacturing operation. It permits quick and easy replacement of fuses without performing desoldering process, even in the field and without exposing the PC Board to detrimental effects of rework solder heat.

Features

- Surface Mountable, Time-Lag Fuse.
- Fully compatible with RoHS/Pb-Free solder alloys and higher temperature profiles associated with leadfree assembly.
- Easily replaceable on PC Board (Field Replaceable)
- RoHS Compliant and Halogen-free
- Available in ratings of 0.375 ~ 5 Amperes.

Applications

- Instrumentations
- Base Stations
- Telecommunications

Additional Information



Datasheet





Resources



Samples

Electrical Specifications by Item

Ampere Rating (A)	Amp Code	Max Voltage Rating (V)	Interrupting Rating (A)	Fuse Furnished	Nominal Cold Resistance (Ohms)	Nominal Melting I ² t (A ² sec)	Agency Approvals	
								
0.375	.375	125	50A @ 125VAC/VDC	0454.375	1.2214	0.101	X	
0.500	.500	125		0454.500	0.7047	0.240	X	
0.750	.750	125		0454.750	0.3602	0.904	X	
1.00	001	125		0454001.	0.2245	1.98	X	X
1.50	01.5	125		045401.5	0.0934	3.65	X	X
2.00	002	125		0454002.	0.0629	8.20	X	X
2.50	02.5	125		045402.5	0.0452	15.0	X	X
3.00	003	125		0454003.	0.0342	20.16	X	X
3.50	03.5	125		045403.5	0.0226	26.53	X	X
4.00	004	125		0454004.	0.0188	34.40	X	X
5.00	005	125		0454005.	0.0138	53.72	X	X

1. Cold resistance measured at less than 10% of rated current at 23°C.
2. I²t values stated for 8ms opening time.
3. Agency Approval Table Key: X=Approved or Certified, P=Pending and Blank=Not Approved
4. Have special electrical characteristic needs? Contact Littelfuse to learn more about application specific options

Temperature Re-rating Curve

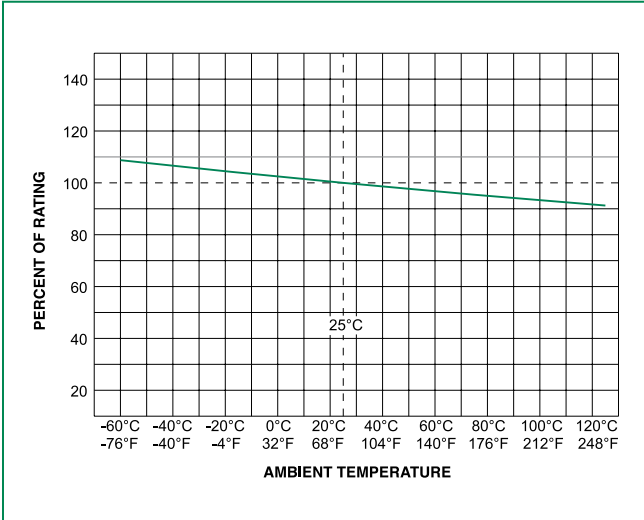

Note:
1. Rerating depicted in this curve is in addition to the standard derating of 25% for continuous operation.

Average Time Current Curves

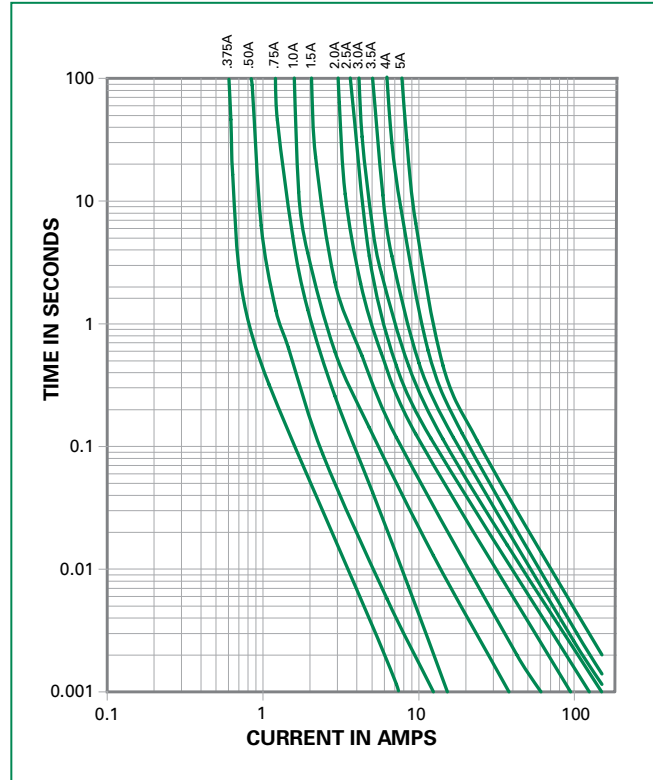

Soldering Parameters

Reflow Condition		Pb – Free assembly
Pre Heat	- Temperature Min ($T_{s(min)}$)	150°C
	- Temperature Max ($T_{s(max)}$)	200°C
	- Time (Min to Max) (t_s)	60 – 120 secs
Average ramp up rate (Liquidus Temp (T_L) to peak)		5°C/second max
$T_{s(max)}$ to T_L - Ramp-up Rate		5°C/second max
Reflow	- Temperature (T_L) (Liquidus)	217°C
	- Temperature (t_L)	60 – 90 seconds
Peak Temperature (T_p)		250 ^{+0/-5} °C
Time within 5°C of actual peak Temperature (t_p)		20 – 40 seconds
Ramp-down Rate		5°C/second max
Time 25°C to peak Temperature (T_p)		8 minutes Max.
Do not exceed		260°C

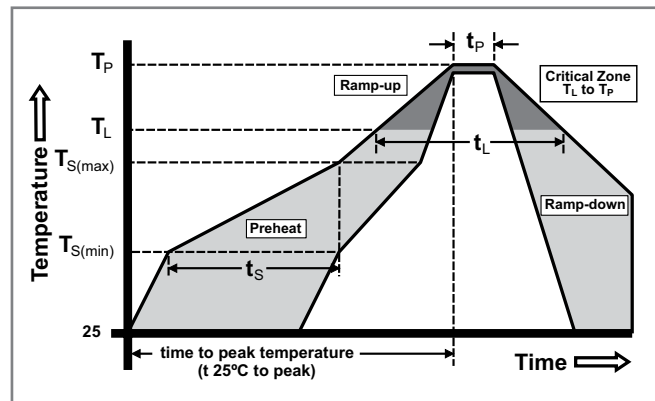

Product Characteristics

Materials	Body: Ceramic Cap: For 0.375A ~ 5A – Silver plated Brass Clip Plating: Matte Tin
Product Marking	Body: Brand Logo, Current Rating, "T" for Time-Lag
Clip Retention	Force applied at fuse center, perpendicular to the long axis (@0.75 lbs. MIN)
Solderability	MIL-STD-202, Method 208 / IPC/ EIA / JEDEC J-STD-002, Test Condition A
Humidity Test	MIL-STD-202, Method 103 @ 85°C / 85%RH, 1000 hours
Resistance to Solvents	MIL-STD-202, Method 215 (3 solvent types)

Operating Temperature	-55°C to 125°C with proper derating
Thermal Shock	MIL-STD-202, Method 107, Test Condition B (5 cycles -65°C to +125°C)
Vibration	MIL-STD-202, Method 201 (10-55 Hz)
Moisture Resistance	MIL-STD-202, Method 106, 10 cycles
Salt Spray/ Atmosphere	MIL-STD-202, Method 101, Test Condition B (48 hrs.), 5% NaCl in De-ionized Water
Shock	MIL-STD-202, Method 213, Test Condition I (100 G's peak for 6 milliseconds)

Dimensions

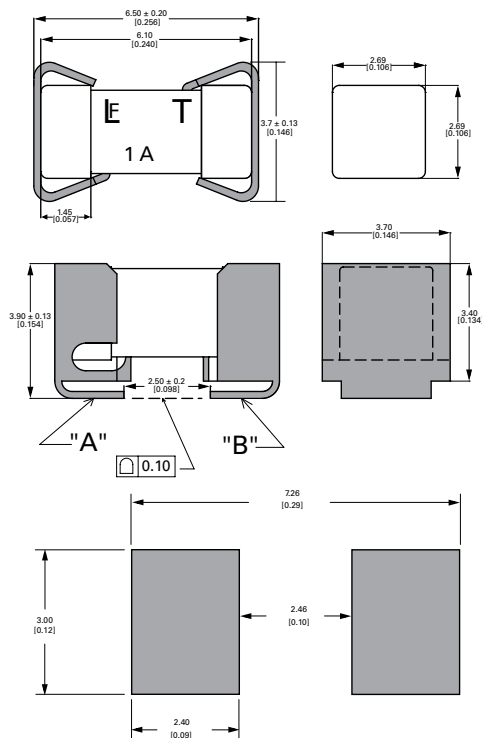

PCB Recommendation for Thermal Management

1. Minimum Copper Layer Thickness = 100um
2. Minimum Copper Trace Width = 10mm

Note:

Alternate methods of thermal management may be used. In such cases, under normal operations, the maximum temperature of the fuse body should not exceed 80°C in a 25°C ambient environment.

Part Numbering System

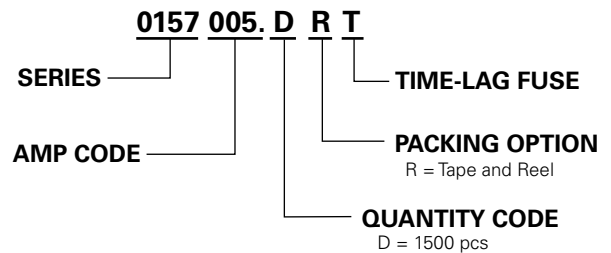

Packaging

Packaging Option	Packaging Specification	Quantity	Quantity & Packaging Code
Tape and Reel	Surface Mount	1500	DRT