

# Solenoid-Actuated Vacuum Generators

Features and Benefits

## Solenoid-Actuated Vacuum Generators

Types VADM-... / VADMI-...

- 1 Integral Filter, Silencer, Manual Override
- 1 Integral Solenoid Valve for Controlling Air Supply
- 1 Vacuum Range up to approximately 25 in Hg depending on application
- 1 Venturi Nozzle Diameters: 0.45, 0.70, 0.95, 1.4, 2.0, 3.0 mm
- 1 Vacuum Ports: M5 to G 3/8
- 1 Supply Ports: M5 to G 1/4
- 1 Available Features:
  - Vacuum Switch (-P, -N)
  - Ejector Pulse (VADMI)
  - Air-Saving Vacuum Switch (VADMI-...-LS-...)

Pages 25-38

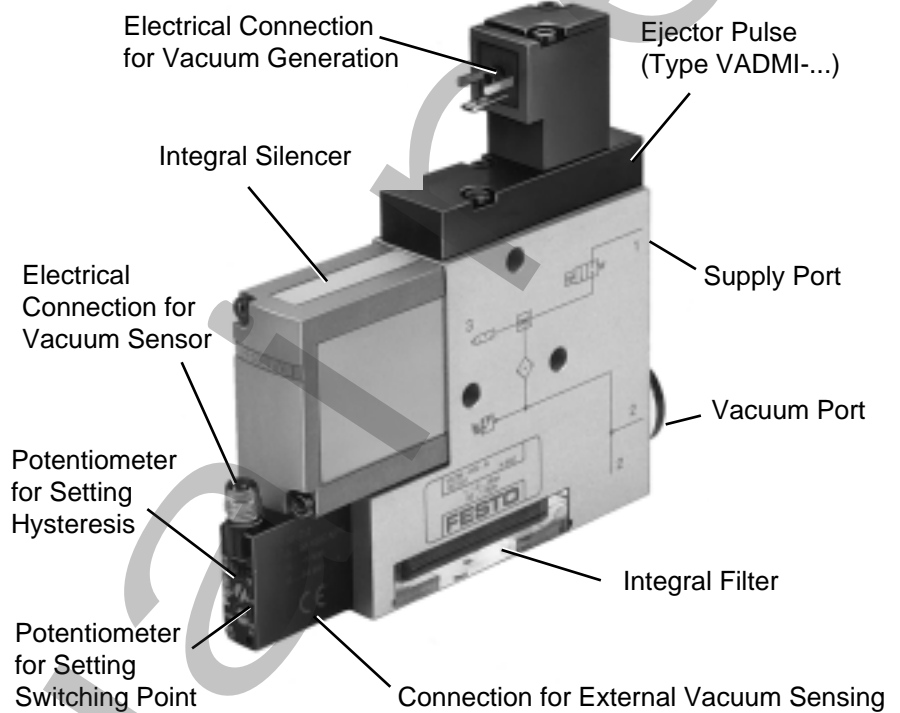

## Solenoid-Actuated Vacuum Generators

Type VAD-M-...

- 1 Integral Silencer, Manual Override
- 1 Integral Solenoid Valve for Controlling Air Supply
- 1 Vacuum Range up to approximately 25 in Hg depending on application
- 1 Venturi Nozzle Diameters: 0.45, 0.70, 0.95, 1.4, 2.0 mm
- 1 Vacuum Ports: M5 to G 3/8
- 1 Supply Ports: M5 to G 1/4
- 1 Available with Ejector Pulse (VAD-...-I-...)

Pages 39-47

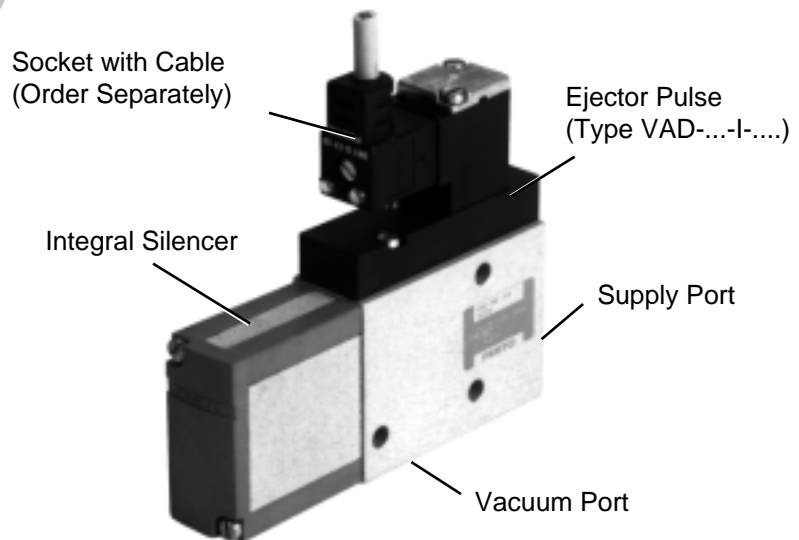

# Solenoid-Actuated Vacuum Generators

With Integral Filter and Silencer, Optional Vacuum Switch, Type VADM-...

## Solenoid-Actuated Vacuum Generator

with integral filter and silencer

### Type VADM-...

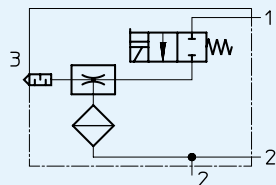

with integral filter, silencer and vacuum switch

### Type VADM-...-P (PNP output) VADM-...-N (NPN output)

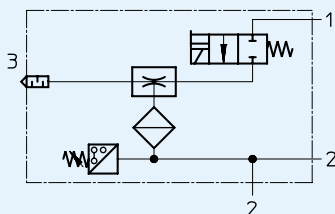

1 = Supply Port  
2 = Vacuum Connection  
3 = Exhaust

Type VADM-...



Type VADM-...-P/N

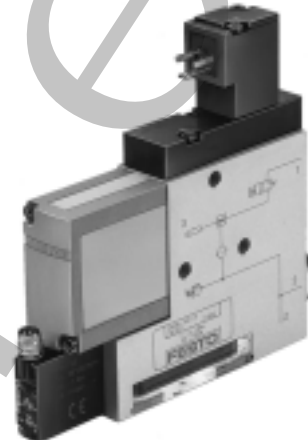

Air supply to these vacuum generators is controlled by the internal solenoid valve. When electrical power energizes the solenoid, the valve is actuated and compressed air flows from port 1 to port 3. This generates a vacuum at port 2 by means of the venturi principle. Suction cups can be connected to vacuum connection (2).

Air entering vacuum connection (2) passes through an internal filter and is discharged to atmosphere, together with the supply air, via exhaust port 3. An integrated silencer reduces exhaust-air noise. When the solenoid valve is deenergized, vacuum generation ceases.

Types VADM-...-P/N includes a vacuum switch which allows the vacuum level to be monitored. (See page 38 for technical data on the vacuum switch.)

Ordering Information, see pages 8-10  
KMYZ, KMEB, MSSD-EB, Solenoid Sockets, see pages 84-89

Order Number Part No./Type	Solenoid-Actuated Vacuum Generator						
	162500 VADM-45	162501 VADM-70	162502 VADM-95	162503 VADM-140	162504 VADM-200	162505 VADM-300	
	With Vacuum Switch (PNP Output) VADM-45-P	162512 VADM-70-P	162514 VADM-95-P	162516 VADM-140-P	162518 VADM-200-P	162520 VADM-300-P	
With Vacuum Switch (NPN Output)	162513 VADM-45-N	162515 VADM-70-N	162517 VADM-95-N	162519 VADM-140-N	162521 VADM-200-N	162523 VADM-300-N	
Replacement Filters	348145	348146	348149	348147	348147	348148	
Venturi Nozzle Diameter	0.018 in / 0.45 mm	0.028 in / 0.7 mm	0.037 in / 0.95 mm	0.055 in / 1.4 mm	0.079 in / 2.0 mm	0.118 in / 3.0 mm	
Medium	Compressed air, filtered (40 µm), unlubricated						
Integral Vacuum Filter	40 µm						
Design	Venturi principle, single solenoid valve, manual override						
Mounting	Through holes in housing, threaded						
Connection Ports 1 / 2	M5 / M5	M5 / G 1/8	G 1/8 / G 1/8	G 1/8 / G 1/4	G 1/4 / G 3/8	G 1/4 / G 3/8	
Pressure Range	15 to 120 psi / 1 to 8 bar (Optimum operating pressure 75 to 105 psi / 5 to 7 bar)						
Air Consumption, Vacuum, Evacuation Time, Efficiency, Noise Level	See graphs on pages 36-37						
Ambient Temperature	32 to 122°F / 0 to +50°C						
Medium Temperature	32 to 122°F / 0 to +50°C						
Materials	Housing: anodized aluminum; Silencer: polymethylene oxide, polyethylene; Filter: polyethylene, polyamid 66, post-chlorinated; Seals: Buna N						
Weight	without Vacuum Switch	0.132 lb / 0.060 kg	0.309 lb / 0.140 kg	0.463 lb / 0.210 kg	0.639 lb / 0.290 kg	0.706 lb / 0.320 kg	0.750 lb / 0.340 kg
	with Vacuum Switch	0.143 lb / 0.065 kg	0.320 lb / 0.145 kg	0.485 lb / 0.220 kg	0.661 lb / 0.300 kg	0.728 lb / 0.330 kg	0.772 lb / 0.350 kg
Type of Protection	IP 65						
Solenoid Valve							
Switching Voltage	24 VDC						
Power Consumption	1.4 W			1.5 W, pilot actuated			
Switch-on Time	5 ms						
Duty Cycle	100% per VDE 0580						
Connection	Socket with Cable	Type KMYZ-2-24-...-LED		Type KMEB-1-24-...-LED			
	Socket without Cable	-		Type MSSD-EB			

# Solenoid-Actuated Vacuum Generators

## Dimensions, Type VADM-...

Type VADM-45  
VADM-70

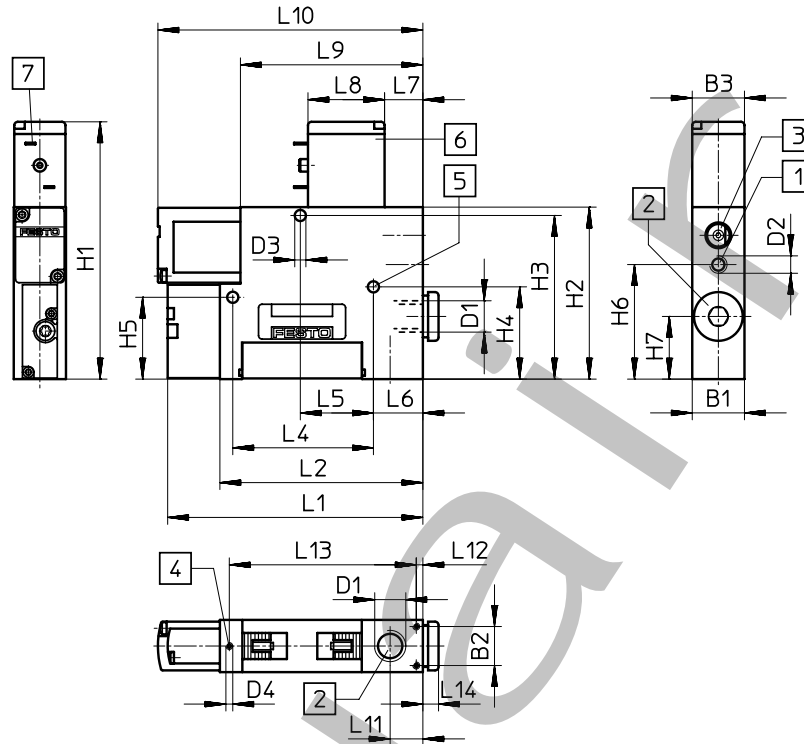

- ① Supply Port
- ② Vacuum Connection
- ③ Manual Override
- ④ Mounting Thread
- ⑤ Mounting Hole
- ⑥ Solenoid coil can be repositioned by 180°
- ⑦ Suitable for Socket Type KMYZ-...

Type	B1 in / mm	B2 in / mm	B3 in / mm	D1	D2	D3 in / mm	D4	H1 in / mm	H2 in / mm
VADM-45	0.39 / 10	0.24 / 6.2	0.39 / 10	M5	M5	0.13 / 3.2	M2	2.54 / 64.4	1.75 / 44.4
VADM-70	0.59 / 15	0.44 / 11.2	0.59 / 15	G 1/8	M5	0.13 / 3.2	M2	2.91 / 73.9	1.94 / 49.4
Type	H3 in / mm	H4 in / mm	H5 in / mm	H6 in / mm	H7 in / mm	L1 in / mm	L2 in / mm	L4 in / mm	L5 in / mm
VADM-45	1.61 / 40.8	0.94 / 23.8	0.94 / 23.8	1.16 / 29.6	0.71 / 18	2.20 / 56	1.61 / 41	1.32 / 33.6	0.98 / 25
VADM-70	1.85 / 47	1.04 / 26.5	0.92 / 23.5	1.30 / 32.9	0.71 / 18	2.89 / 73.3	2.30 / 58.3	1.59 / 40.4	0.83 / 21
Type	L6 in / mm	L7 in / mm	L8 in / mm	L9 in / mm	L10 in / mm	L11 in / mm	L12 in / mm	L13 in / mm	L14 in / mm
VADM-45	0.14 / 3.6	0.43 / 11	0.63 / 16	1.61 / 41	2.20 / 56	0.31 / 7.9	0.08 / 1.9	1.43 / 36.3	0.16 / 4
VADM-70	0.56 / 14.2	0.43 / 11	0.87 / 22	2.06 / 52.4	3.00 / 76.1	0.37 / 9.4	0.08 / 1.9	2.11 / 53.7	0.18 / 4.5

# Solenoid-Actuated Vacuum Generators

Dimensions, Type VADM-...

Type VADM-95  
VADM-140  
VADM-200  
VADM-300

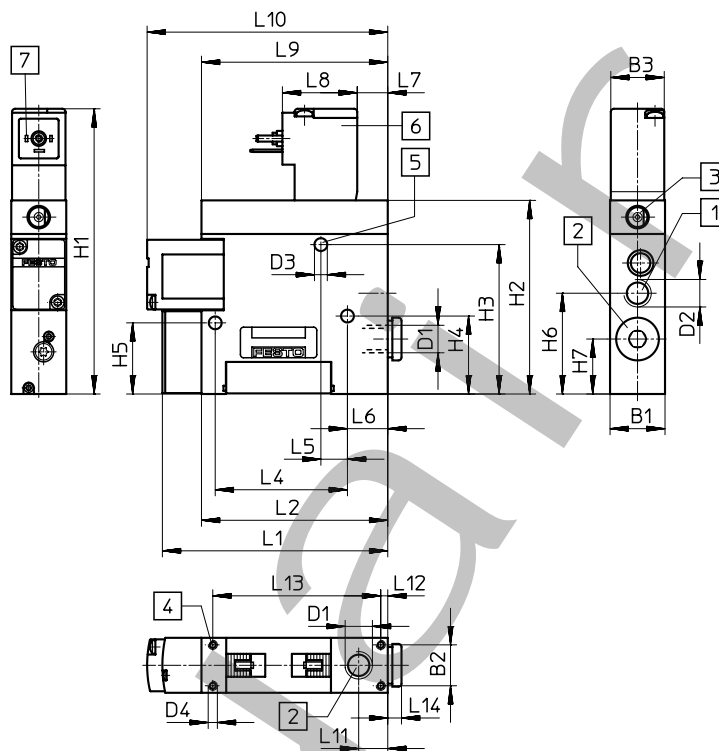

- 1 Supply Port
- 2 Vacuum Connection
- 3 Manual Override
- 4 Mounting Thread
- 5 Mounting Hole
- 6 Solenoid coil can be repositioned by 180°
- 7 Suitable for Socket Type KMEB-... and MSSD-EB

Type	B1 in / mm	B2 in / mm	B3 in / mm	D1	D2	D3 in / mm	D4	H1 in / mm	H2 in / mm
VADM-95	0.71 / 18	0.53 / 13.4	0.71 / 18	G 1/8	G 1/8	0.16 / 4.2	M3	3.68 / 93.4	2.50 / 63.4
VADM-140	0.87 / 22	0.65 / 16.6	0.71 / 18	G 1/4	G 1/8	0.20 / 5.2	M3	4.23 / 107.4	3.05 / 77.4
VADM-200	0.87 / 22	0.65 / 16.6	0.71 / 18	G 3/8	G 1/4	0.20 / 5.2	M3	4.46 / 113.4	3.28 / 83.4
VADM-300	0.87 / 22	0.65 / 16.6	0.71 / 18	G 3/8	G 1/4	0.20 / 5.2	M3	4.46 / 113.4	3.28 / 83.4
Type	H3 in / mm	H4 in / mm	H5 in / mm	H6 in / mm	H7 in / mm	L1 in / mm	L2 in / mm	L4 in / mm	L5 in / mm
VADM-95	1.92 / 48.9	1.00 / 25.5	0.92 / 23.3	1.30 / 33	0.71 / 18	2.91 / 73.8	2.40 / 61	1.70 / 43.3	0.34 / 8.7
VADM-140	2.42 / 61.4	1.63 / 41.4	1.63 / 41.4	1.42 / 36	0.69 / 17.5	3.81 / 96.8	3.31 / 84	1.02 / 26	0.49 / 12.5
VADM-200	2.66 / 67.7	1.63 / 41.4	1.63 / 41.4	1.58 / 40	0.75 / 19	3.81 / 96.8	3.31 / 84	1.02 / 26	0.49 / 12.5
VADM-300	2.66 / 67.7	1.63 / 41.4	1.63 / 41.4	1.58 / 40	0.75 / 19	5.24 / 133.2	4.74 / 120.4	1.02 / 26	0.49 / 12.5
Type	L6 in / mm	L7 in / mm	L8 in / mm	L9 in / mm	L10 in / mm	L11 in / mm	L12 in / mm	L13 in / mm	L14 in / mm
VADM-95	0.52 / 13.2	0.38 / 9.7	0.96 / 24.5	2.40 / 61	3.10 / 78.8	0.37 / 9.5	0.09 / 2.3	2.16 / 55	0.18 / 4.5
VADM-140	1.12 / 28.5	0.38 / 9.7	0.96 / 24.5	2.40 / 61	3.81 / 96.8	0.54 / 13.8	0.09 / 2.3	3.13 / 79.4	0.20 / 5
VADM-200	1.12 / 28.5	0.38 / 9.7	0.96 / 24.5	2.40 / 61	4.01 / 101.8	0.49 / 12.5	0.09 / 2.3	3.13 / 79.4	0.20 / 5
VADM-300	1.12 / 28.5	0.38 / 9.7	0.96 / 24.5	2.40 / 61	5.41 / 137.4	0.49 / 12.5	0.09 / 2.3	4.56 / 115.8	0.20 / 5

# Solenoid-Actuated Vacuum Generators

Dimensions, Type VADM-...

Type VADM-45-P/N  
VADM-70-P/N

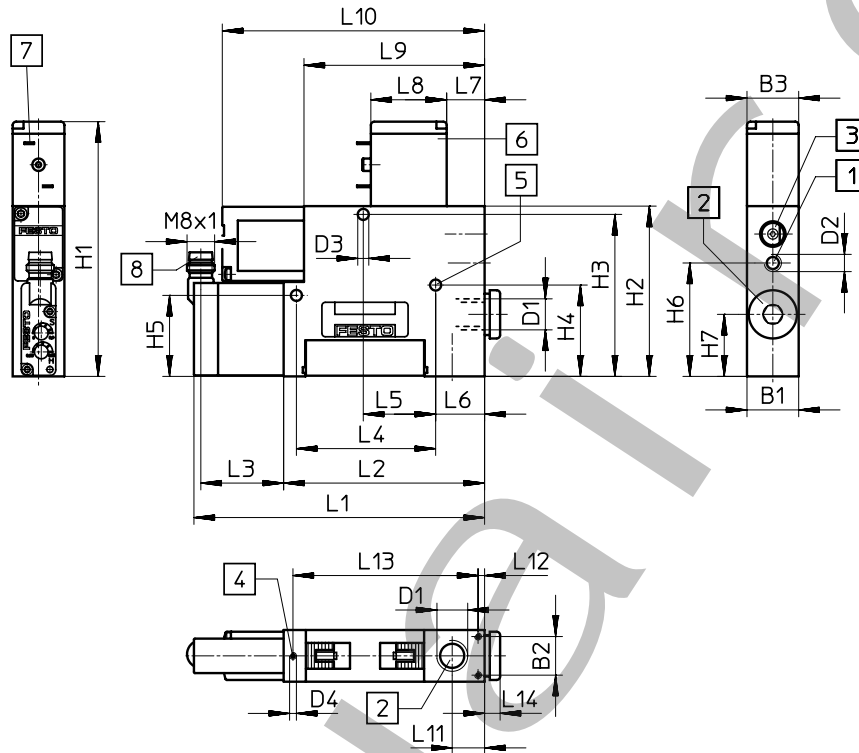

- 1 Supply Port
- 2 Vacuum Connection
- 3 Manual Override
- 4 Mounting Thread
- 5 Mounting Hole
- 6 Solenoid coil can be repositioned by 180°
- 7 Suitable for Socket Type KMYZ-...
- 8 Connection for Socket Type SIM-...

Type	B1 in / mm	B2 in / mm	B3 in / mm	D1	D2	D3 in / mm	D4	H1 in / mm	H2 in / mm	H3 in / mm
VADM-45-P/N	0.39 / 10	0.24 / 6.2	0.39 / 10	M5	M5	0.13 / 3.2	M2	2.54 / 64.4	1.75 / 44.4	1.61 / 40.8
VADM-70-P/N	0.59 / 15	0.44 / 11.2	0.59 / 15	G 1/8	M5	0.13 / 3.2	M2	2.91 / 73.9	1.94 / 49.4	1.85 / 47
Type	H4 in / mm	H5 in / mm	H6 in / mm	H7 in / mm	L1 in / mm	L2 in / mm	L3 in / mm	L4 in / mm	L5 in / mm	L6 in / mm
VADM-45-P/N	0.94 / 23.8	0.94 / 23.8	1.16 / 29.6	0.71 / 18	2.64 / 67	1.61 / 41	0.94 / 24	1.32 / 33.6	0.98 / 25	0.14 / 3.6
VADM-70-P/N	1.04 / 26.5	0.92 / 23.5	1.30 / 32.9	0.71 / 18	3.32 / 84.3	2.30 / 58.3	0.94 / 24	1.59 / 40.4	0.83 / 21	0.56 / 14.2
Type	L7 in / mm	L8 in / mm	L9 in / mm	L10 in / mm	L11 in / mm	L12 in / mm	L13 in / mm	L14 in / mm		
VADM-45-P/N	0.43 / 11	0.63 / 16	1.61 / 41	2.20 / 56	0.31 / 7.9	0.08 / 1.9	1.43 / 36.3	0.16 / 4		
VADM-70-P/N	0.43 / 11	0.87 / 22	2.06 / 52.4	3.00 / 76.1	0.37 / 9.4	0.08 / 1.9	2.11 / 53.7	0.18 / 4.5		

# Solenoid-Actuated Vacuum Generators

Dimensions, Type VADM-...

Type VADM-95-P/N  
 VADM-140-P/N  
 VADM-200-P/N  
 VADM-300-P/N

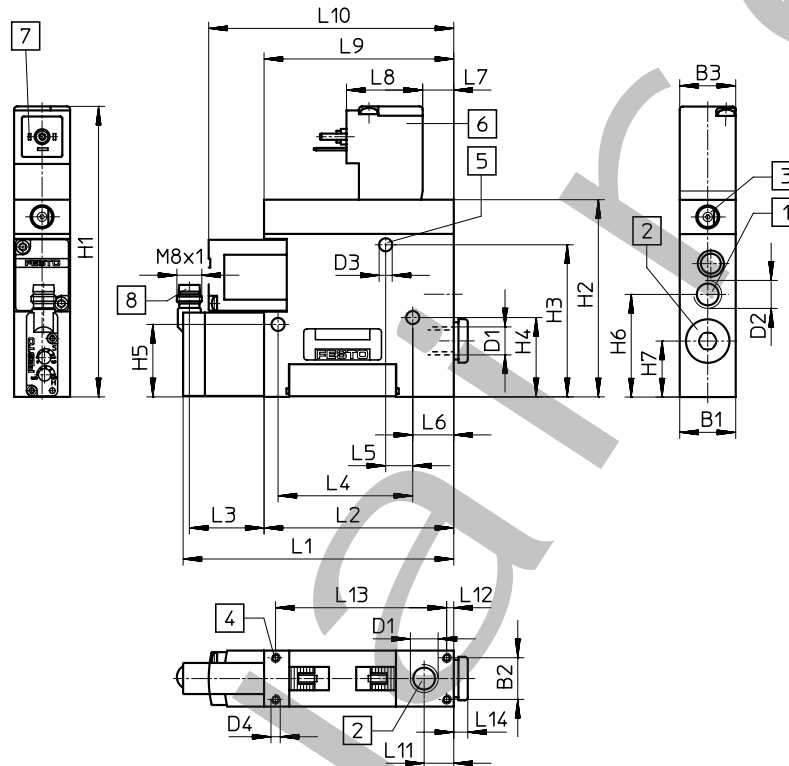

- 1 Supply Port
- 2 Vacuum Connection
- 3 Manual Override
- 4 Mounting Thread
- 5 Mounting Hole
- 6 Solenoid coil can be repositioned by 180°
- 7 Suitable for Socket Type KMEB-... and MSSD-EB
- 8 Connection for Socket Type SIM-...

Type	B1 in / mm	B2 in / mm	B3 in / mm	D1	D2	D3 in / mm	D4	H1 in / mm	H2 in / mm	H3 in / mm
VADM-95-P/N	0.71 / 18	0.53 / 13.4	0.71 / 18	G 1/8	G 1/8	0.16 / 4.2	M3	3.68 / 93.4	2.50 / 63.4	1.92 / 48.9
VADM-140-P/N	0.87 / 22	0.65 / 16.6	0.71 / 18	G 1/4	G 1/8	0.20 / 5.2	M3	4.23 / 107.4	3.05 / 77.4	2.42 / 61.4
VADM-200-P/N	0.87 / 22	0.65 / 16.6	0.71 / 18	G 3/8	G 1/4	0.20 / 5.2	M3	4.46 / 113.4	3.28 / 83.4	2.66 / 67.7
VADM-300-P/N	0.87 / 22	0.65 / 16.6	0.71 / 18	G 3/8	G 1/4	0.20 / 5.2	M3	4.46 / 113.4	3.28 / 83.4	2.66 / 67.7
Type	H4 in / mm	H5 in / mm	H6 in / mm	H7 in / mm	L1 in / mm	L2 in / mm	L3 in / mm	L4 in / mm	L5 in / mm	L6 in / mm
VADM-95-P/N	1.00 / 25.5	0.92 / 23.3	1.30 / 33	0.71 / 18	3.42 / 87	2.40 / 61	0.94 / 24	1.70 / 43.3	0.34 / 8.7	0.52 / 13.2
VADM-140-P/N	1.63 / 41.4	1.63 / 41.4	1.42 / 36	0.69 / 17.5	4.33 / 110	3.31 / 84	0.94 / 24	1.02 / 26	0.49 / 12.5	1.12 / 28.5
VADM-200-P/N	1.63 / 41.4	1.63 / 41.4	1.58 / 40	0.75 / 19	4.33 / 110	3.31 / 84	0.94 / 24	1.02 / 26	0.49 / 12.5	1.12 / 28.5
VADM-300-P/N	1.63 / 41.4	1.63 / 41.4	1.58 / 40	0.75 / 19	4.98 / 126.4	4.74 / 120.4	0.94 / 24	1.02 / 26	0.49 / 12.5	1.12 / 28.5
Type	L7 in / mm	L8 in / mm	L9 in / mm	L10 in / mm	L11 in / mm	L12 in / mm	L13 in / mm	L14 in / mm		
VADM-95-P/N	0.38 / 9.7	0.96 / 24.5	2.40 / 61	3.10 / 78.8	0.37 / 9.5	0.09 / 2.3	2.16 / 55	0.18 / 4.5		
VADM-140-P/N	0.38 / 9.7	0.96 / 24.5	2.40 / 61	3.81 / 96.8	0.54 / 13.8	0.09 / 2.3	3.13 / 79.4	0.20 / 5		
VADM-200-P/N	0.38 / 9.7	0.96 / 24.5	2.40 / 61	4.01 / 101.8	0.49 / 12.5	0.09 / 2.3	3.13 / 79.4	0.20 / 5		
VADM-300-P/N	0.38 / 9.7	0.96 / 24.5	2.40 / 61	5.41 / 137.4	0.49 / 12.5	0.09 / 2.3	4.56 / 115.8	0.20 / 5		

# Solenoid-Actuated Vacuum Generators

With Integral Filter, Silencer, Ejector Pulse, Optional Vacuum Switch and Air Saving Circuit

## Solenoid-Actuated Vacuum Generator

with integral filter, silencer, and ejector pulse

### Type VADMI-...

- 1 = Supply Port
- 2 = Vacuum Connection
- 3 = Exhaust

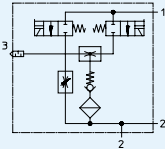

with vacuum switch:  
PNP output

### Type VADMI-...-P

NPN output

### Type VADMI-...-N

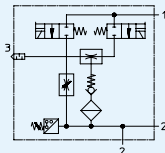

with air-saving circuit (PNP output):

### Type VADMI-...-LS-P

This vacuum generator incorporates a vacuum switch with an air-saving function.

The vacuum switch has two potentiometers which allow two points to be defined between which the vacuum level is adequate to securely hold a workpiece.

Connecting cables, sockets for solenoid coils, and vacuum switch are included.

See page 31.

Air supply to these vacuum generators is controlled by the built-in solenoid valves. When electrical power energizes the first solenoid, the valve is actuated and compressed air flows from port 1 to port 3. This generates a vacuum at port 2 by means of the venturi principle. Suction cups can be connected to vacuum connection (2).

Type VADMI-...



Type VADMI-...-P/N

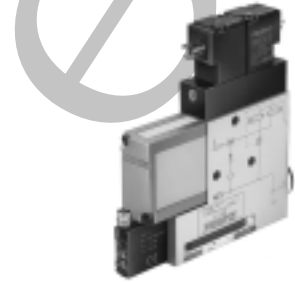

Air entering vacuum connection (2) passes through a built-in filter and is discharged to atmosphere, together with the supply air, via exhaust port 3. An integrated silencer reduces exhaust-air noise.

When the first solenoid valve is deenergized, vacuum generation ceases. Vacuum level is maintained by an integral non-return valve. Vacuum can be dissipated quickly by energizing the second solenoid of the double-solenoid ejector valve. The supply air is then redirected to port (2). This applied ejector pulse of positive pressure breaks the vacuum and quickly releases the part being held.

Types VADMI-...-P/N and VADMI-...-LS-P include a vacuum switch which allows the vacuum level to be monitored. (See page 38 for technical data on the vacuum switch.)

Ordering Information, see pages 8-10  
KMYZ, KMEB, MSSD-EB Solenoid Sockets, see pages 85-87

Order Number Part No./Type	Solenoid-Actuated Vacuum Generator	162506 VADMI-45	162507 VADMI-70	162508 VADMI-95	162509 VADMI-140	162510 VADMI-200	162511 VADMI-300
	With Vacuum Switch (PNP Output)	162524 VADMI-45-P	162526 VADMI-70-P	162528 VADMI-95-P	162530 VADMI-140-P	162532 VADMI-200-P	162534 VADMI-300-P
	With Vacuum Switch (NPN Output)	162525 VADMI-45-N	162527 VADMI-70-N	162529 VADMI-95-N	162531 VADMI-140-N	162533 VADMI-200-N	162535 VADMI-300-N
	Air Saving Circuit (PNP Output)	171053 VADMI-45-LS-P	171055 VADMI-70-LS-P	171057 VADMI-95-LS-P	171059 VADMI-140-LS-P	171061 VADMI-200-LS-P	171063 VADMI-300-LS-P
Replacement Filters		348145	348146	348149	348147	348147	348148
Venturi Nozzle Diameter		0.018 in / 0.45 mm	0.028 in / 0.7 mm	0.037 in / 0.95 mm	0.055 in / 1.4 mm	0.079 in / 2.0 mm	0.118 in / 3.0 mm
Medium		Compressed air, filtered (40 µm), unlubricated					
Integral Vacuum Filter		40 µm					
Design		Venturi principle, solenoid valve, manual override					
Mounting		Through holes in housing, threaded					
Connection Ports 1 / 2		M5 / M5	M5 / G 1/8	G 1/8 / G 1/8	G 1/8 / G 1/4	G 1/4 / G 3/8	G 1/4 / G 3/8
Pressure Range		15 to 120 psi / 1 to 8 bar (Optimum operating pressure 75 to 105 psi / 5 to 7 bar)					
Air Consumption, Vacuum, Evacuation Time, Efficiency, Noise Level		See graphs on pages 36 and 37					
Ambient Temperature		32 to 122°F / 0 to +50°C					
Medium Temperature		32 to 122°F / 0 to +50°C					
Materials		Housing: anodized aluminum; Silencer: polymethylene oxide, polyethylene; Filter: polyethylene, polyamide 66, post-chlorinated PVC; Seals: Buna N					
Weight	without Vacuum Switch	0.187 lb / 0.085 kg	0.375 lb / 0.170 kg	0.529 lb / 0.240 kg	0.706 lb / 0.320 kg	0.772 lb / 0.350 kg	0.816 lb / 0.370 kg
	with Vacuum Switch	0.198 lb / 0.090 kg	0.397 lb / 0.180 kg	0.551 lb / 0.250 kg	0.728 lb / 0.330 kg	0.794 lb / 0.360 kg	0.838 lb / 0.380 kg
Type of Protection		IP 65					
Solenoid Valve							
Switching Voltage		24 VDC					
Power Consumption		2 x 1.4 W			2 x 1.5 W, pilot actuated		
Switch-on Time		5 ms					
Duty Cycle		100% per VDE 0580					
Connection	Socket with Cable	Type KMYZ-2-24-...-LED			Type KMEB-1-24-...-LED		
	Socket without Cable	-	-	Type MSSD-EB			



# Solenoid-Actuated Vacuum Generators

## Vacuum Switch with Air Saving Circuit

### Vacuum Switch with Air Saving Circuit

for Type VADMI...-LS-P

This switch generates a pulse signal (A2) only when the vacuum level falls to an insufficient preset threshold value, for example due to leakage. The pulse signal activates the suction solenoid of the vacuum generator, thus restoring the vacuum to another preset value. During the remaining cycle time, vacuum is maintained by the integral non-return valve eliminating the need to activate the suction solenoid.

It is also possible to monitor a signal (A1) which is normally at +24V but which falls to 0V if the vacuum falls below the lower preset threshold by a further 65 mbar. This will, for example, occur if a workpiece falls off a suction cup, with the result that the desired vacuum level can no longer be generated.

Connecting cables, sockets for solenoid coils, and vacuum switch are included.

The switch must be operated only with the cable set supplied.

Connections 1, 3 and 4 can be interchanged without causing damage to the switch.

This unit is supplied complete with socket and cable assembly as shown below.

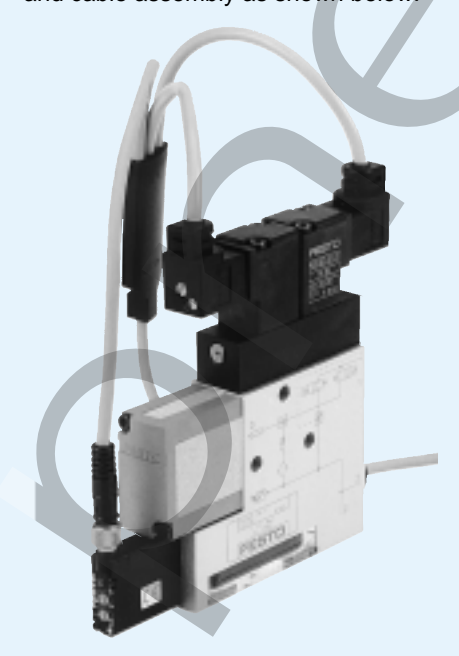
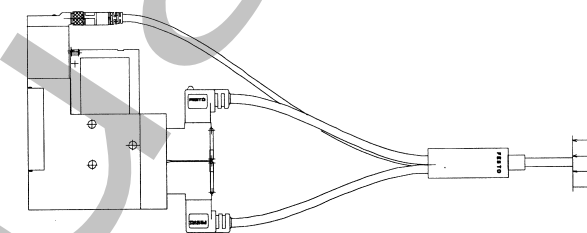
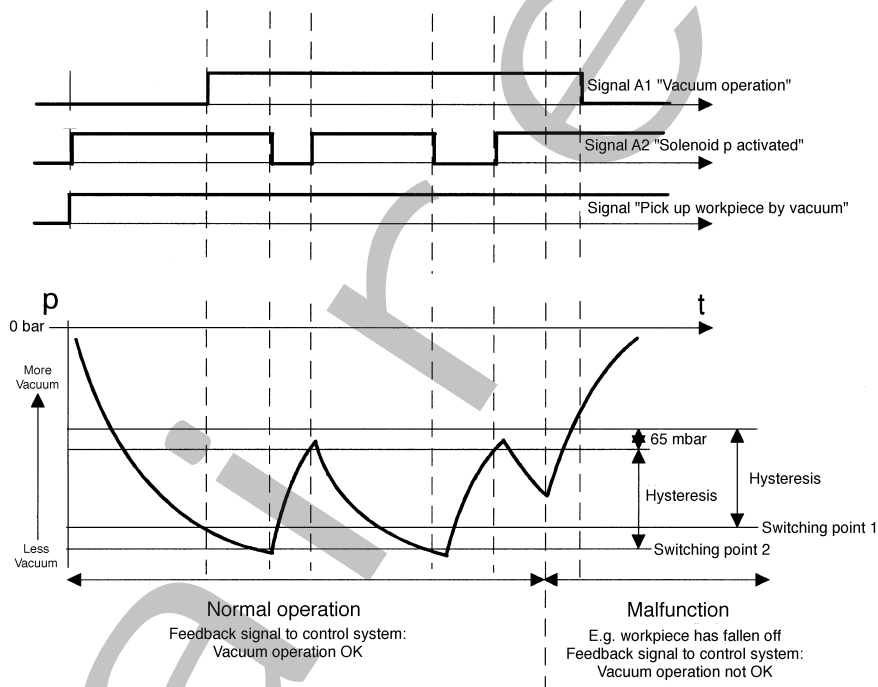

Circuit diagram for vacuum switch

PNP switching output

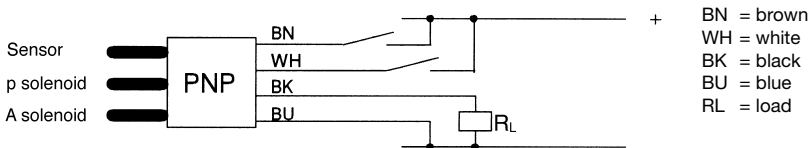



# Solenoid-Actuated Vacuum Generators

Dimensions, Type VADMI-...

Type VADMI-45-P/N  
VADMI-70-P/N

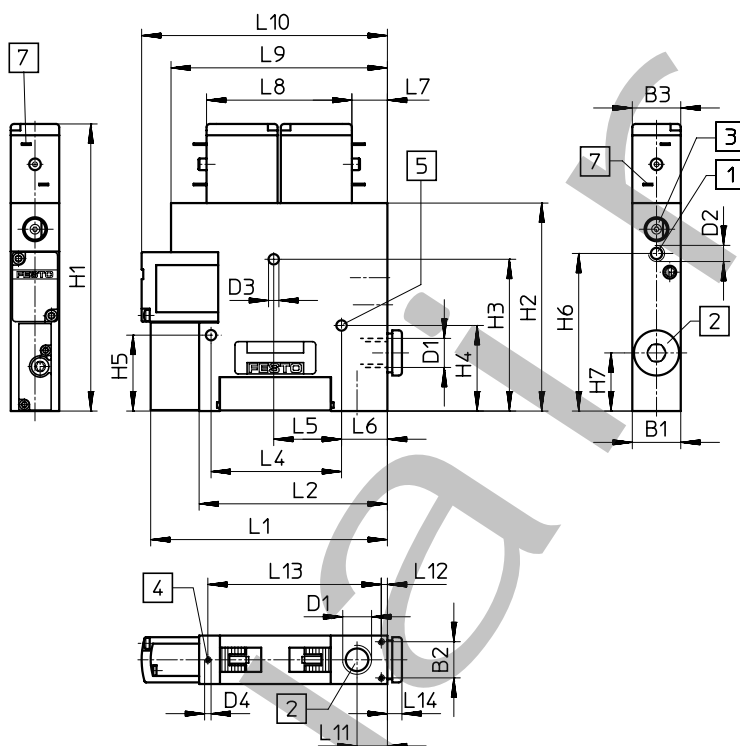

- 1 Supply Port
- 2 Vacuum Connection
- 3 Manual Override
- 4 Mounting Thread
- 5 Mounting Hole
- 7 Suitable for Socket Type KMYZ-...

Type	B1 in / mm	B2 in / mm	B3 in / mm	D1	D2	D3 in / mm	D4	H1 in / mm	H2 in / mm
VADMI-45	0.39 / 10	0.24 / 6.2	0.39 / 10	M5	M5	0.13 / 3.2	M2	3.08 / 78.2	2.29 / 58.2
VADMI-70	0.59 / 15	0.44 / 11.2	0.59 / 15	G 1/8	M5	0.13 / 3.2	M2	3.50 / 88.9	2.54 / 64.4
Type	H3 in / mm	H4 in / mm	H5 in / mm	H6 in / mm	H7 in / mm	L1 in / mm	L2 in / mm	L4 in / mm	L5 in / mm
VADMI-45	1.61 / 40.8	0.94 / 23.8	0.94 / 23.8	1.71 / 43.4	0.71 / 18	2.20 / 56	1.61 / 41	1.32 / 33.6	0.98 / 25
VADMI-70	1.85 / 47	1.04 / 26.5	0.92 / 23.5	1.92 / 48.8	0.71 / 18	2.89 / 73.3	2.30 / 58.3	1.59 / 40.4	0.83 / 21
Type	L6 in / mm	L7 in / mm	L8 in / mm	L9 in / mm	L10 in / mm	L11 in / mm	L12 in / mm	L13 in / mm	L14 in / mm
VADMI-45	0.14 / 3.6	0.43 / 11	1.30 / 33	2.16 / 55	2.20 / 56	0.31 / 7.9	0.08 / 1.9	1.43 / 36.3	0.16 / 4
VADMI-70	0.56 / 14.2	0.43 / 11	1.77 / 45	2.64 / 67	3.00 / 76.1	0.37 / 9.4	0.08 / 1.9	2.11 / 53.7	0.18 / 4.5

# Solenoid-Actuated Vacuum Generators

Dimensions, Type VADMI-...

Type VADMI-95  
VADMI-140  
VADMI-200  
VADMI-300

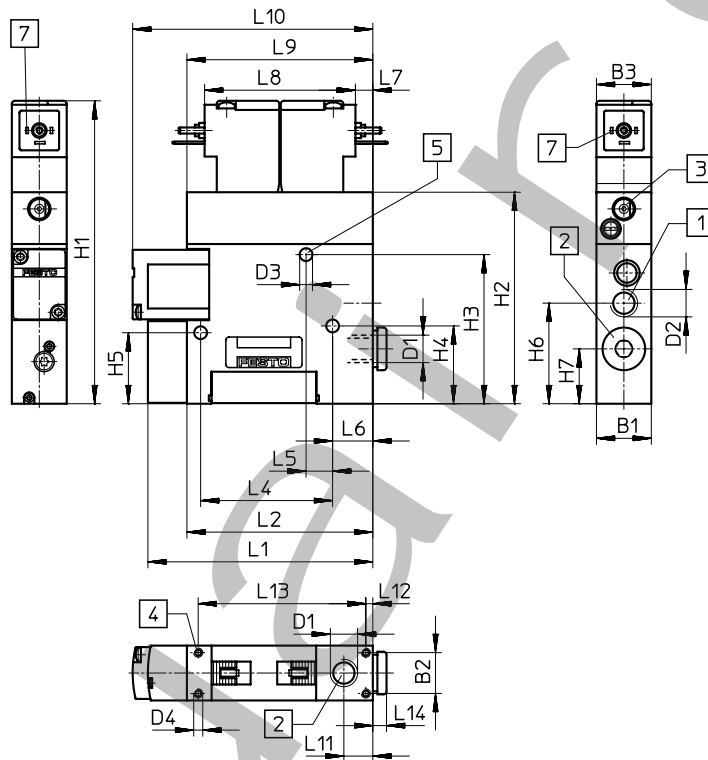

- 1 Supply Port
- 2 Vacuum Connection
- 3 Manual Override
- 4 Mounting Thread
- 5 Mounting Hole
- 7 Suitable for Socket Type KMEB-... and MSSD-EB

Type	B1 in / mm	B2 in / mm	B3 in / mm	D1	D2	D3 in / mm	D4	H1 in / mm	H2 in / mm
VADMI-95	0.71 / 18	0.53 / 13.4	0.71 / 18	G 1/8	G 1/8	0.16 / 4.2	M3	3.91 / 99.4	2.73 / 69.4
VADMI-140	0.87 / 22	0.65 / 16.6	0.71 / 18	G 1/4	G 1/8	0.20 / 5.2	M3	4.46 / 113.4	3.28 / 83.4
VADMI-200	0.87 / 22	0.65 / 16.6	0.71 / 18	G 3/8	G 1/4	0.20 / 5.2	M3	4.70 / 119.4	3.52 / 89.4
VADMI-300	0.87 / 22	0.65 / 16.6	0.71 / 18	G 3/8	G 1/4	0.20 / 5.2	M3	4.70 / 119.4	3.52 / 89.4
Type	H3 in / mm	H4 in / mm	H5 in / mm	H6 in / mm	H7 in / mm	L1 in / mm	L2 in / mm	L4 in / mm	L5 in / mm
VADMI-95	1.92 / 48.9	1.00 / 25.5	0.92 / 23.3	1.30 / 33	0.71 / 18	2.91 / 73.8	2.40 / 61	1.70 / 43.3	0.34 / 8.7
VADMI-140	2.42 / 61.4	1.63 / 41.4	1.63 / 41.4	1.42 / 36	0.69 / 17.5	3.81 / 96.8	3.31 / 84	1.02 / 26	0.49 / 12.5
VADMI-200	2.66 / 67.7	1.63 / 41.4	1.63 / 41.4	1.58 / 40	0.75 / 19	3.81 / 96.8	3.31 / 84	1.02 / 26	0.49 / 12.5
VADMI-300	2.66 / 67.7	1.63 / 41.4	1.63 / 41.4	1.58 / 40	0.75 / 19	5.24 / 133.2	4.74 / 120.4	1.02 / 26	0.49 / 12.5
Type	L6 in / mm	L7 in / mm	L8 in / mm	L9 in / mm	L10 in / mm	L11 in / mm	L12 in / mm	L13 in / mm	L14 in / mm
VADMI-95	0.52 / 13.2	0.22 / 5.7	1.95 / 49.5	2.40 / 61	3.10 / 78.8	0.37 / 9.5	0.09 / 2.3	2.16 / 55	0.18 / 4.5
VADMI-140	1.12 / 28.5	0.22 / 5.7	1.95 / 49.5	2.40 / 61	3.81 / 96.8	0.54 / 13.8	0.09 / 2.3	3.13 / 79.4	0.20 / 5
VADMI-200	1.12 / 28.5	0.22 / 5.7	1.95 / 49.5	2.40 / 61	4.01 / 101.8	0.49 / 12.5	0.09 / 2.3	3.13 / 79.4	0.20 / 5
VADMI-300	1.12 / 28.5	0.22 / 5.7	1.95 / 49.5	2.40 / 61	5.41 / 137.4	0.49 / 12.5	0.09 / 2.3	4.56 / 115.8	0.20 / 5

# Solenoid-Actuated Vacuum Generators

Dimensions, Type VADMI-...

Type VADMI-45-P/N  
VADMI-70-P/N  
VADMI-45-LS-P  
VADMI-70-LS-P

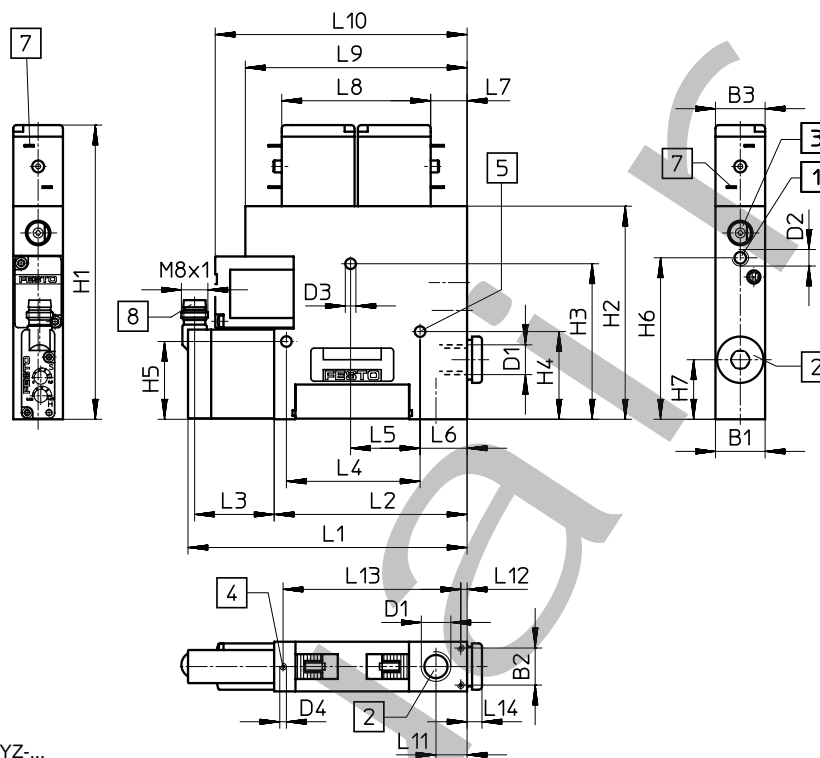

- 1 Supply Port
- 2 Vacuum Connection
- 3 Manual Override
- 4 Mounting Thread
- 5 Mounting Hole
- 7 Suitable for Socket Type KMYZ-...
- 8 Connection for Socket Type SIM-...

Type	B1 in / mm	B2 in / mm	B3 in / mm	D1	D2	D3 in / mm	D4	H1 in / mm	H2 in / mm	H3 in / mm
VADMI-45-P/N	0.39 / 10	0.24 / 6.2	0.39 / 10	M5	M5	0.13 / 3.2	M2	3.08 / 78.2	2.29 / 58.2	1.61 / 40.8
VADMI-70-P/N	0.59 / 15	0.44 / 11.2	0.59 / 15	G 1/8	M5	0.13 / 3.2	M2	3.50 / 88.9	2.54 / 64.4	1.85 / 47
VADMI-45-LS-P	0.39 / 10	0.24 / 6.2	0.39 / 10	M5	M5	0.13 / 3.2	M2	3.08 / 78.2	2.29 / 58.2	1.61 / 40.8
VADMI-70-LS-P	0.59 / 15	0.44 / 11.2	0.59 / 15	G 1/8	M5	0.13 / 3.2	M2	3.50 / 88.9	2.54 / 64.4	1.85 / 47
Type	H4 in / mm	H5 in / mm	H6 in / mm	H7 in / mm	L1 in / mm	L2 in / mm	L3 in / mm	L4 in / mm	L5 in / mm	L6 in / mm
VADMI-45-P/N	0.94 / 23.8	0.94 / 23.8	1.71 / 43.4	0.71 / 18	2.64 / 67	1.61 / 41	0.94 / 24	1.32 / 33.6	0.98 / 25	0.14 / 3.6
VADMI-70-P/N	1.04 / 26.5	0.92 / 23.5	1.92 / 48.8	0.71 / 18	3.32 / 84.3	2.30 / 58.3	0.94 / 24	1.59 / 40.4	0.83 / 21	0.56 / 14.2
VADMI-45-LS-P	0.94 / 23.8	0.94 / 23.8	1.71 / 43.4	0.71 / 18	2.81 / 71.4	1.61 / 41	1.12 / 28.4	1.32 / 33.6	0.98 / 25	0.14 / 3.6
VADMI-70-LS-P	1.04 / 26.5	0.92 / 23.5	1.92 / 48.8	0.71 / 18	3.49 / 88.7	2.30 / 58.3	1.12 / 28.4	1.59 / 40.4	0.83 / 21	0.56 / 14.2
Type	L7 in / mm	L8 in / mm	L9 in / mm	L10 in / mm	L11 in / mm	L12 in / mm	L13 in / mm	L14 in / mm		
VADMI-45-P/N	0.43 / 11	1.30 / 33	2.16 / 55	2.20 / 56	0.31 / 7.9	0.08 / 1.9	1.43 / 36.3	0.16 / 4		
VADMI-70-P/N	0.43 / 11	1.77 / 45	2.64 / 67	3.00 / 76.1	0.37 / 9.4	0.08 / 1.9	2.11 / 53.7	0.18 / 4.5		
VADMI-45-LS-P	0.43 / 11	1.30 / 33	2.16 / 55	2.20 / 56	0.31 / 7.9	0.08 / 1.9	1.43 / 36.3	0.16 / 4		
VADMI-70-LS-P	0.43 / 11	1.77 / 45	2.64 / 67	3.00 / 76.1	0.37 / 9.4	0.08 / 1.9	2.11 / 53.7	0.18 / 4.5		

# Solenoid-Actuated Vacuum Generators

Dimensions, Type VADMI-...

- Type VADMI-95-P/N
- VADMI-140-P/N
- VADMI-200-P/N
- VADMI-300-P/N
- VADMI-95-LS-P
- VADMI-140-LS-P
- VADMI-200-LS-P
- VADMI-300-LS-P

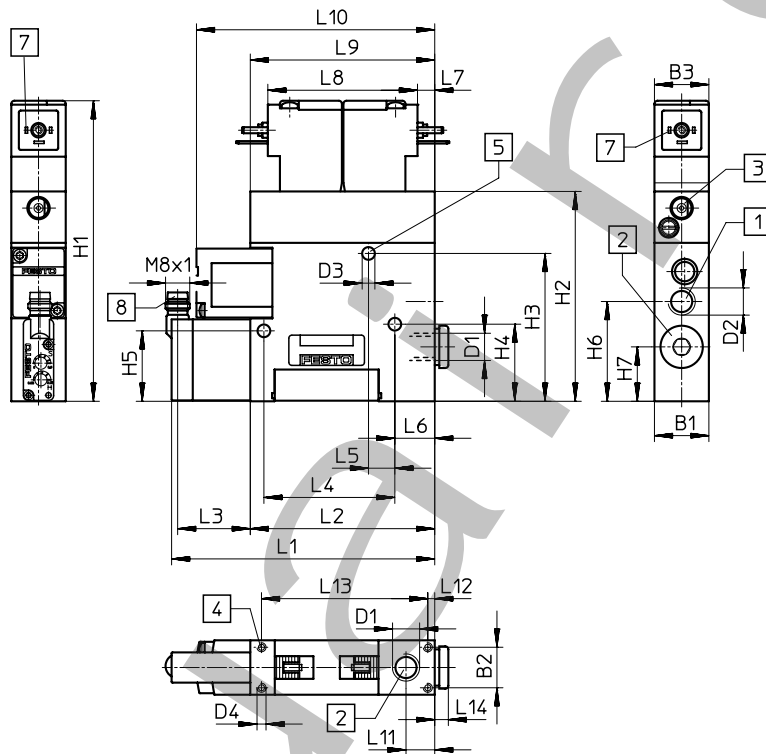

- 1 Supply Port
- 2 Vacuum Connection
- 3 Manual Override
- 4 Mounting Thread
- 5 Mounting Hole
- 7 Suitable for Socket Type KMEB... and MSSD-EB
- 8 Connection for Socket Type SIM...

Type	B1 in / mm	B2 in / mm	B3 in / mm	D1	D2	D3 in / mm	D4	H1 in / mm	H2 in / mm	H3 in / mm
VADMI-95-P/N	0.71 / 18	0.53 / 13.4	0.71 / 18	G 1/8	G 1/8	0.16 / 4.2	M3	3.91 / 99.4	2.73 / 69.4	1.92 / 48.9
VADMI-140-P/N	0.87 / 22	0.65 / 16.6	0.71 / 18	G 1/4	G 1/8	0.20 / 5.2	M3	4.46 / 113.4	3.28 / 83.4	2.42 / 61.4
VADMI-200-P/N	0.87 / 22	0.65 / 16.6	0.71 / 18	G 3/8	G 1/4	0.20 / 5.2	M3	4.70 / 119.4	3.52 / 89.4	2.66 / 67.7
VADMI-300-P/N	0.87 / 22	0.65 / 16.6	0.71 / 18	G 3/8	G 1/4	0.20 / 5.2	M3	4.70 / 119.4	3.52 / 89.4	2.66 / 67.7
VADMI-95-LS-P	0.71 / 18	0.53 / 13.4	0.71 / 18	G 1/8	G 1/8	0.16 / 4.2	M3	3.91 / 99.4	2.73 / 69.4	1.92 / 48.9
VADMI-140-LS-P	0.87 / 22	0.65 / 16.6	0.71 / 18	G 1/4	G 1/8	0.20 / 5.2	M3	4.46 / 113.4	3.28 / 83.4	2.42 / 61.4
VADMI-200-LS-P	0.87 / 22	0.65 / 16.6	0.71 / 18	G 3/8	G 1/4	0.20 / 5.2	M3	4.70 / 119.4	3.52 / 89.4	2.66 / 67.7
VADMI-300-LS-P	0.87 / 22	0.65 / 16.6	0.71 / 18	G 3/8	G 1/4	0.20 / 5.2	M3	4.70 / 119.4	3.52 / 89.4	2.66 / 67.7
Type	H4 in / mm	H5 in / mm	H6 in / mm	H7 in / mm	L1 in / mm	L2 in / mm	L3 in / mm	L4 in / mm	L5 in / mm	L6 in / mm
VADMI-95-P/N	1.00 / 25.5	0.92 / 23.3	1.30 / 33	0.71 / 18	3.42 / 87	2.40 / 61	0.94 / 24	1.70 / 43.3	0.34 / 8.7	0.52 / 13.2
VADMI-140-P/N	1.63 / 41.4	1.63 / 41.4	1.42 / 36	0.69 / 17.5	4.33 / 110	3.31 / 84	0.94 / 24	1.02 / 26	0.49 / 12.5	1.12 / 28.5
VADMI-200-P/N	1.63 / 41.4	1.63 / 41.4	1.58 / 40	0.75 / 19	4.33 / 110	3.31 / 84	0.94 / 24	1.02 / 26	0.49 / 12.5	1.12 / 28.5
VADMI-300-P/N	1.63 / 41.4	1.63 / 41.4	1.58 / 40	0.75 / 19	5.76 / 146.4	4.74 / 120.4	0.94 / 24	1.02 / 26	0.49 / 12.5	1.12 / 28.5
VADMI-95-LS-P	1.00 / 25.5	0.92 / 23.3	1.30 / 33	0.71 / 18	3.60 / 91.4	2.40 / 61	1.12 / 28.4	1.70 / 43.3	0.34 / 8.7	0.52 / 13.2
VADMI-140-LS-P	1.63 / 41.4	1.63 / 41.4	1.42 / 36	0.69 / 17.5	4.50 / 114.4	3.31 / 84	1.12 / 28.4	1.02 / 26	0.49 / 12.5	1.12 / 28.5
VADMI-200-LS-P	1.63 / 41.4	1.63 / 41.4	1.58 / 40	0.75 / 19	4.50 / 114.4	3.31 / 84	1.12 / 28.4	1.02 / 26	0.49 / 12.5	1.12 / 28.5
VADMI-300-LS-P	1.63 / 41.4	1.63 / 41.4	1.58 / 40	0.71 / 18	5.94 / 150.8	4.74 / 120.4	1.12 / 28.4	1.02 / 26	0.49 / 12.5	1.12 / 28.5
Type	L7 in / mm	L8 in / mm	L9 in / mm	L10 in / mm	L11 in / mm	L12 in / mm	L13 in / mm	L14 in / mm		
VADMI-95-P/N	0.22 / 5.7	1.95 / 49.5	2.40 / 61	3.10 / 78.8	0.37 / 9.5	0.09 / 2.3	2.16 / 55	0.18 / 4.5		
VADMI-140-P/N	0.22 / 5.7	1.95 / 49.5	2.40 / 61	3.81 / 96.8	0.54 / 13.8	0.09 / 2.3	3.13 / 79.4	0.20 / 5		
VADMI-200-P/N	0.22 / 5.7	1.95 / 49.5	2.40 / 61	4.01 / 101.8	0.49 / 12.5	0.09 / 2.3	3.13 / 79.4	0.20 / 5		
VADMI-300-P/N	0.22 / 5.7	1.95 / 49.5	2.40 / 61	5.41 / 137.4	0.49 / 12.5	0.09 / 2.3	4.56 / 115.8	0.20 / 5		
VADMI-95-LS-P	0.22 / 5.7	1.95 / 49.5	2.40 / 61	3.10 / 78.8	0.37 / 9.5	0.09 / 2.3	2.16 / 55	0.18 / 4.5		
VADMI-140-LS-P	0.22 / 5.7	1.95 / 49.5	2.40 / 61	3.81 / 96.8	0.54 / 13.8	0.09 / 2.3	3.13 / 79.4	0.20 / 5		
VADMI-200-LS-P	0.22 / 5.7	1.95 / 49.5	2.40 / 61	4.01 / 101.8	0.49 / 12.5	0.09 / 2.3	3.13 / 79.4	0.20 / 5		
VADMI-300-LS-P	0.22 / 5.7	1.95 / 49.5	2.40 / 61	5.41 / 137.4	0.49 / 12.5	0.09 / 2.3	4.56 / 115.8	0.20 / 5		

# Solenoid-Actuated Vacuum Generators

## Performance Graphs, Type VADM and VADMI

Air consumption as a function of operating pressure

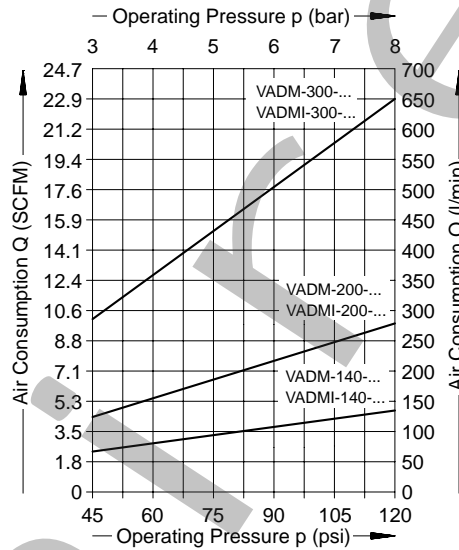
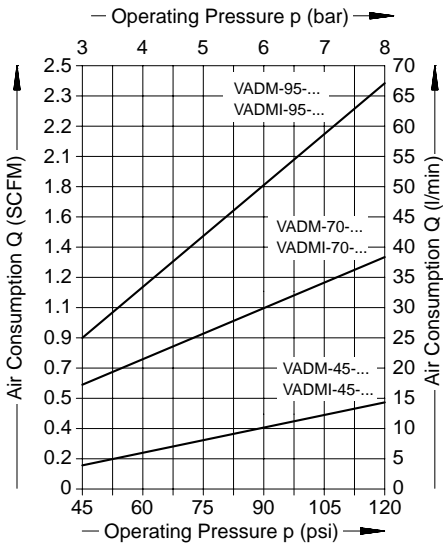

Vacuum as a function of operating pressure

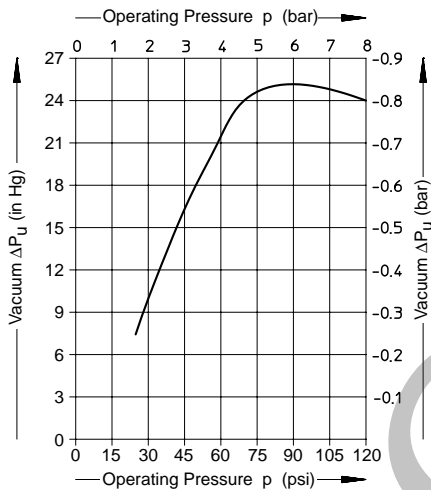

Noise level as a function of operating pressure

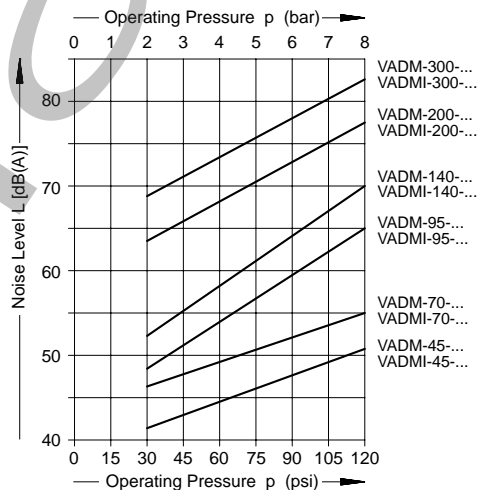

Efficiency as a function of vacuum at rated pressure

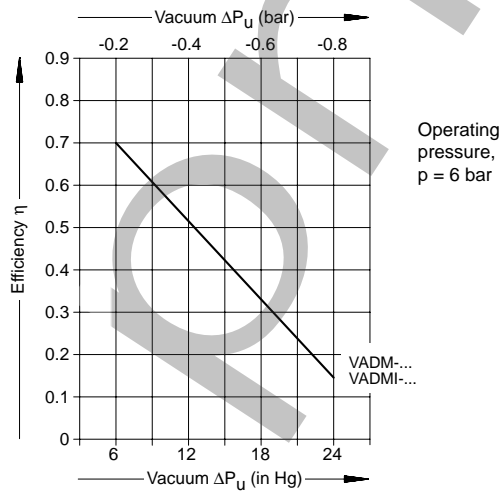

The degree of efficiency is a criterion for making an objective comparison between vacuum generators of very different designs (single stage or multistage).

$$\eta(\Delta p_u) = \frac{1}{1 + \frac{t(\Delta p_u) \cdot Q}{V \cdot 60 \text{ s/min}}}$$

$\eta(\Delta p_u)$  Degree of efficiency of vacuum generator relative to vacuum

$t(\Delta p_u)$  Evacuation Time (s)

$Q$  Air consumption (l/min)

$V$  Volume to be evacuated standard volume (l)

# Solenoid-Actuated Vacuum Generators

## Performance Graphs, Type VADM and VADMI

Evacuation time for a 1 liter volume with an operating pressure of 90 psi / 6 bar

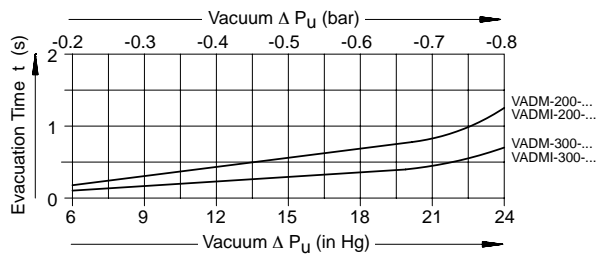
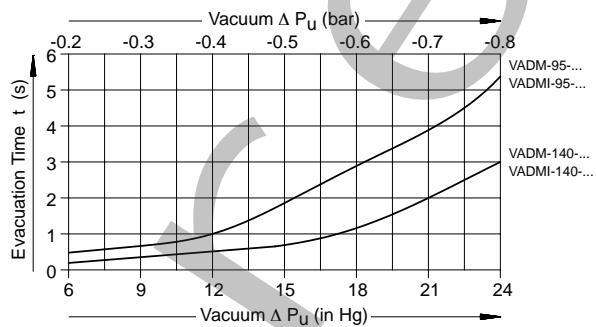
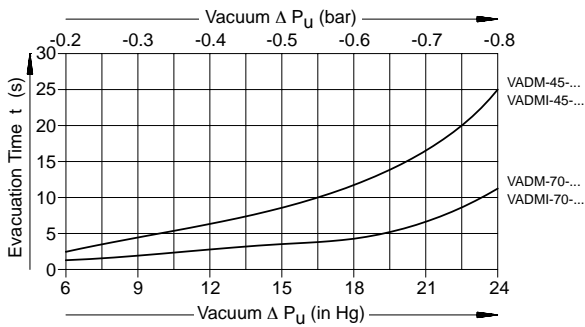

Noise level as a function of operating pressure

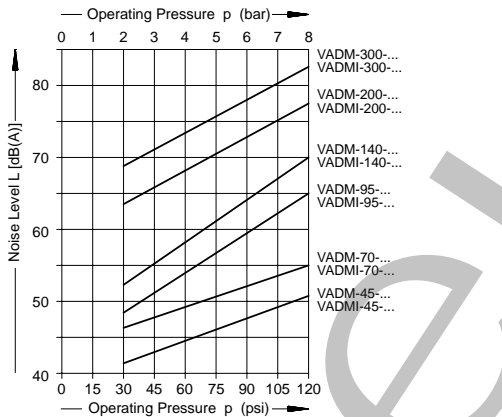

Sound pressure level as a function of operating pressure (in gripped mode)

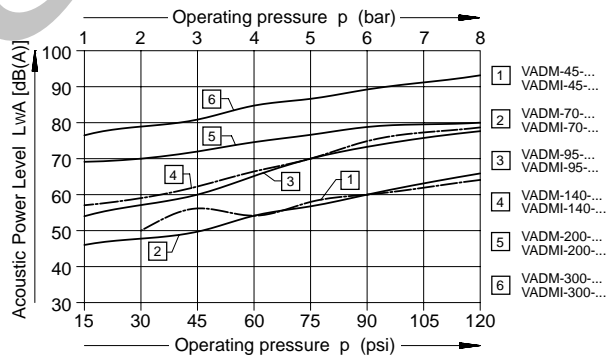

Air supply time for 1 liter volume with operating pressure of 90 psi / 6 bar

Suction flow rate as a function of vacuum level

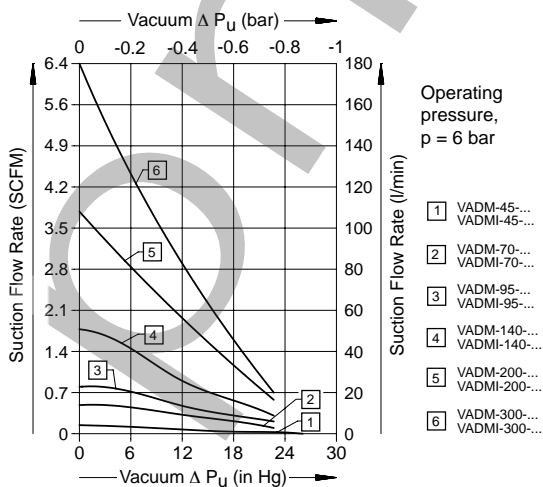

Type	With Ejector Pulses	Without Ejector Pulses	Max. Flow Rate of Ejector Pulse scfm / l/min
VADM-45-..		5.9 s	
VADMI-45-..	1.9 s		0.68 / 19.2
VADM-70-..		2.2 s	
VADMI-70-..	0.59 s		2.4 / 68
VADM-95-..		1.18 s	
VADMI-95-..	0.24 s		4.8 / 135
VADM-140-..		0.69 s	
VADMI-140-..	0.19 s		7.1 / 200
VADM-200-..		0.29 s	
VADMI-200-..	0.15 s		6.2 / 175
VADM-300-..		0.26 s	
VADMI-300-..	0.2 s		5.6 / 160

# Solenoid-Actuated Vacuum Generators

## Vacuum Switch

### Vacuum Switch

For Type VADM-...-P  
VADM-...-N  
VADMI-...-P  
VADMI-...-N

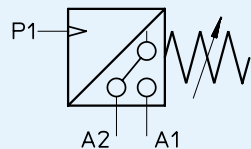

In a piezoresistive pressure switch, application of a vacuum results in the output of an electric signal. If the predetermined threshold pressure is exceeded, an electrical signal at switch output A1 (normally open) or A2 (normally closed) is generated.

### Accessories:

Socket with cable for vacuum switch  
see pages 88-89  
Type SIM-K-4-GD-...  
Type SIM-K-4-WD-...  
Type SIM-M8-4GD-...  
Type SIM-M8-4WD-...

### Control Panel for Vacuum Switches

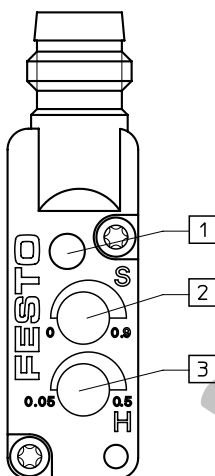

- 1 Operating status display LED (yellow)
- 2 Switching point adjustment
- 3 Hysteresis adjustment

### Circuit diagrams for vacuum switches

#### PNP-Switching output

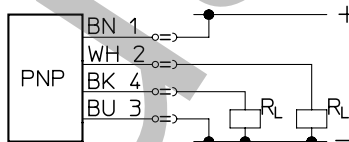

#### NPN-Switching output

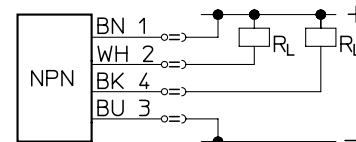

### Pin-Allocation

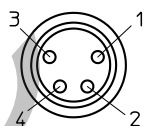

- 1 = Positive
- 2 = Normally closed contact (NC)
- 3 = Negative
- 4 = Normally open contact (NO)
- BN = brown
- WH = white
- BK = black
- BU = blue
- RL = Load

Vacuum Switch	381016 VADM-...-P (PNP) 381017 VADM-...-N (NPN)
Design	Piezoresistive vacuum switch with adjustable switching point and adjustable hysteresis
Pressure Range	0 to 28.4 in Hg / 0 to -0.95 bar
Overload Pressure	max. 120 psi / 8 bar for t < 1 min
Operating Voltage	10 to 30 VDC, Nominal Operating Voltage 24 VDC
Voltage Drop at Switching Output	1.2 V
Switching Output Current	130 mA
Input Current Consumption	max. 25 mA
Electrical Connection	Polarity protected
Switching Point	Adjustable 0 psi to 26.9 in Hg / 0 to -0.9 bar
Impact of Temperature on Switching Point	$\leq \pm 0.075$ psi / 10 K / $\leq \pm 5$ mbar / 10 K
Hysteresis	Adjustable 0.75 to 7.5 psi / 0.05 to 0.5 bar
Time Delay	max. 5 ms
Type of Protection	IP 65
Optical Display	A yellow LED illuminates when the adjusted pressure threshold is exceeded and the output is switched
Connection	Socket with cable Type SIM-...



# Solenoid-Actuated Vacuum Generators

With Integral Silencer and Manual Override, Type VAD-M..-(I)-...

## Solenoid-Actuated Vacuum Generator

with integral silencer and manual override  
Type VAD-M..-...

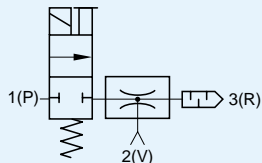

with ejector pulse, integral silencer and manual override

Type VAD-M..-I-...

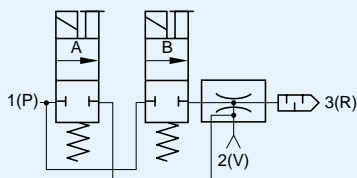

Ordering Information, see pages 8-10

### Accessories:

Sockets with cables  
for Type VAD-MZB-... and VAD-MYB-...  
34997 KMYZ-2-24-2.5-LED, cable 2.5 m  
34998 KMYZ-2-24-5-LED, cable 5 m

for Type VAD-ME-...  
30943 KME-1-24-2.5-LED, cable 2.5 m  
30945 KME-1-24-5-LED, cable 5 m  
See pages 85-86

Type VAD-M..-...



Type VAD-M..-I-...

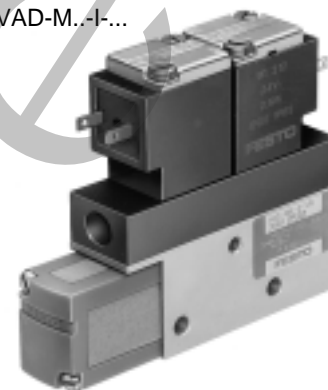

With these vacuum generators, the compressed air supply is controlled via an integral solenoid valve or valves.

When power is applied to the solenoid, the valve shifts and compressed air flows from the supply port 1(P), through nozzle, and out port 3(R). As the air passes through the nozzle, the Venturi principle creates vacuum at the suction port 2(V). Suction cups can be screwed into the suction port 2(V). When the solenoid is de-energized, the vacuum at suction port 2(V) stops.

VAD-M..-I-... vacuum generators have two control valves to allow for fast release of parts. When the solenoid in valve "B" is energized, compressed air flows from the supply port 1(P) and out 3(R) creating a vacuum at suction port 2(V). When the "B" solenoid is de-energized and the "A" solenoid is energized, the vacuum stops and the compressed air is redirected to 2(V), quickly releasing the part(s) being held. (Note: The solenoids should not be energized at the same time.)

All VAD-M..-... vacuum generators have an integral silencer at the exhaust port 3(R) to muffle exhaust noise.

Order Number Part Number/Type	Vacuum Generators With One Control Valve		Vacuum Generators/Ejectors With Two Control Valves			
	35552 VAD-MZB-M5	35553 VAD-MYB-1/8	35554 VAD-ME-1/8	35555 VAD-ME-1/4	35556 VAD-ME-3/8	35531 VAD-ME-I-1/8
Venturi Nozzle Diameter	0.02 in / 0.45 mm	0.03 in / 0.7 mm	0.04 in / 0.95 mm	0.06 in / 1.4 mm	0.08 in / 2 mm	0.05533 VAD-ME-I-3/8
Medium	Compressed air, filtered (40 µm), unlubricated					
Design	Venturi principle, solenoid valve controlled					
Mounting	Through holes in housing					
Connection Ports 1/2	M5 / M5	M5 / G 1/8	G 1/8 / G 1/8	G 1/8 / G 1/4	G 1/4 / G 3/8	
Pressure Range	15 to 120 psi / 1 to 8 bar (Optimum operating pressure 75 to 105 psi / 5 to 7 bar)					
Air Consumption, Vacuum, Evacuation Time, Efficiency, Noise Level	See graphs on pages 42-43					
Switching Time	10 ms					
Ambient Temperature	+32 to +104°F / 0 to +40°C					
Medium Temperature	+32 to +104°F / 0 to +40°C					
Materials	Housing: Anodized aluminum; Seals: Buna N					
Weight	0.070 lb / 0.032 kg	0.176 lb / 0.080 kg	0.276 lb / 0.125 kg	0.463 lb / 0.210 kg	0.529 lb / 0.240 kg	
	0.121 lb / 0.055 kg	0.298 lb / 0.135 kg	0.353 lb / 0.160 kg	0.551 lb / 0.250 kg	0.617 lb / 0.280 kg	
Solenoid Valve						
Operating Voltage	24 V					
Solenoid Power Consumption, Vacuum/Release	1.4 / 1.4 W	1.4 / 1.4 W	2.5 / 2.5 W	1.5 / 2.5 W	1.5 / 2.5 W	
Duty Cycle	100%					
Type of Protection with Socket	IP 65					

# Solenoid-Actuated Vacuum Generators

Dimensions, Type VAD-M...-...

Type VAD-MZB-M5  
VAD-MYB-1/8

Type VAD-ME-...

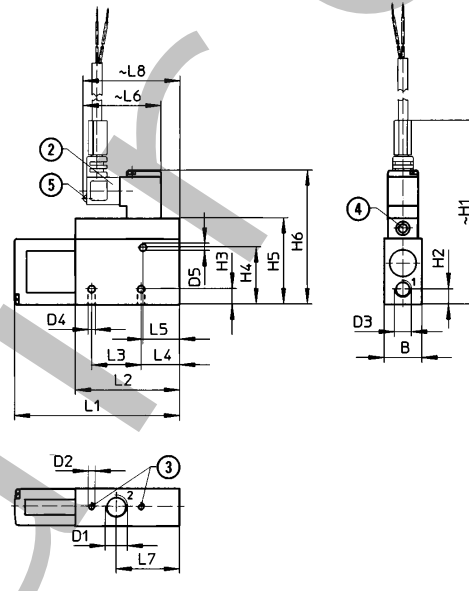
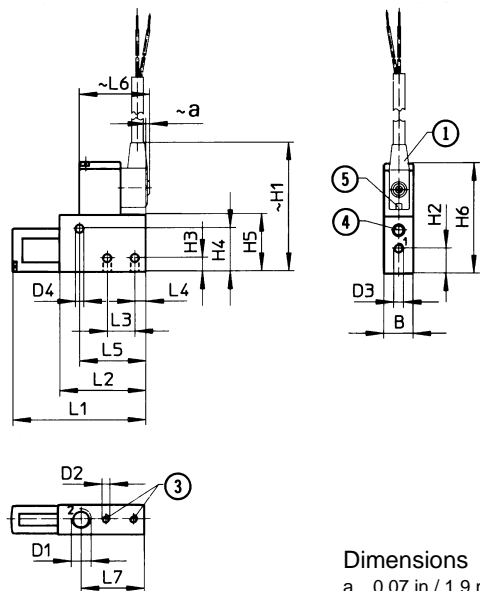

Dimensions  
a 0.07 in / 1.9 mm

- ① Socket Type KMYZ-2-24-... with two conductor cables 8.2 ft (2.5 m) or 16.4 ft (5 m) long, diameter (22 gauge) 3.6 mm (2 x 0.35 mm<sup>2</sup>)
- ② Socket Type KME-1-24-... with two conductor cables 8.2 ft (2.5 m) or 16.4 ft (5 m) long, diameter (18 gauge) 5.6 mm (2 x 0.75 mm<sup>2</sup>)
- ③ Mounting thread
- ④ Manual override
- ⑤ Yellow LED

Type	B in / mm	D1	D2	D3	D4 in / mm	D5 in / mm	H1 in / mm
VAD-MZB-M5	0.39 / 10	M5	M3	M5	0.13 / 3.2	—	2.16 / 55
VAD-MYB-1/8	0.59 / 15	G 1/8	M4	M5	0.16 / 4.2	—	2.46 / 62.5
VAD-ME-1/8	0.71 / 18	G 1/8	M4	G 1/8	0.16 / 4.2	0.13 / 3.2	3.66 / 93
VAD-ME-1/4	0.87 / 22	G 1/4	M4	G 1/8	0.16 / 4.2	0.16 / 4.2	4.20 / 106.8
VAD-ME-3/8	0.87 / 22	G 3/8	M5	G 1/4	0.20 / 5.2	0.20 / 5.2	4.45 / 113.1
Type	H2 in / mm	H3 in / mm	H4 in / mm	H5 in / mm	H6 in / mm	L1 in / mm	L2 in / mm
VAD-MZB-M5	0.39 / 9.8	0.20 / 5	0.57 / 14.5	0.98 / 25	1.77 / 45	1.91 / 48.5	1.32 / 33.5
VAD-MYB-1/8	0.50 / 12.7	0.28 / 7	0.87 / 22	1.14 / 29	2.20 / 56	2.65 / 67.2	1.71 / 43.5
VAD-ME-1/8	0.56 / 14.2	0.26 / 6.5	0.79 / 20	1.42 / 36	2.52 / 64	2.99 / 76	2.40 / 61
VAD-ME-1/4	0.34 / 8.7	0.35 / 9	1.30 / 33	1.97 / 50	3.06 / 77.8	3.80 / 96.6	2.40 / 61
VAD-ME-3/8	0.43 / 11	0.39 / 10	1.54 / 39	2.20 / 56	3.31 / 84.1	4.01 / 101.8	2.40 / 61
Type	L3 in / mm	L4 in / mm	L5 in / mm	L6 in / mm	L7 in / mm	L8 in / mm	
VAD-MZB-M5	0.43 / 11	0.26 / 6.5	1.06 / 27	1.12 / 28.5	1.00 / 25.5	—	
VAD-MYB-1/8	0.55 / 14	0.22 / 5.5	1.32 / 33.5	1.36 / 34.6	1.26 / 32	—	
VAD-ME-1/8	1.06 / 27	0.75 / 19	1.20 / 30.5	1.89 / 48	1.28 / 32.5	2.28 / 58	
VAD-ME-1/4	1.14 / 29	0.89 / 22.5	0.85 / 21.5	1.89 / 48	1.46 / 37	2.28 / 58	
VAD-ME-3/8	1.26 / 32	0.92 / 23.5	0.85 / 21.5	1.89 / 48	1.56 / 39.5	2.28 / 58	

# Solenoid-Actuated Vacuum Generators

Dimensions, Type VAD-M.-I-...

Type VAD-MZB-I-M5  
VAD-MYB-I-1/8

Type VAD-ME-I-...

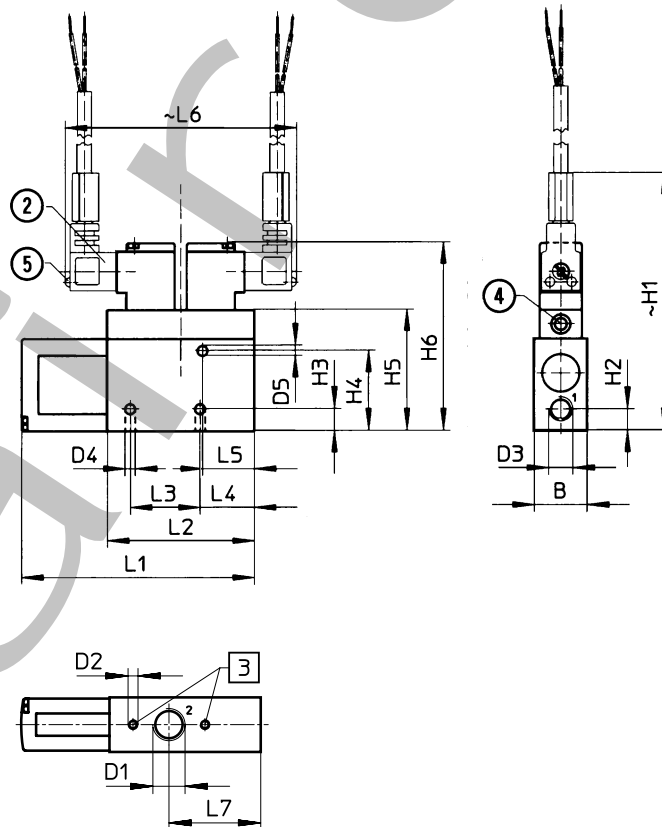
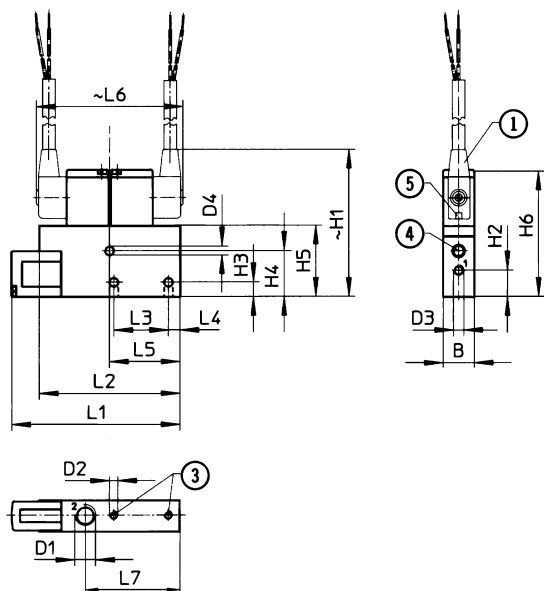

- ① Socket Type KMYZ-2-24-... with two conductor cables 8.2 ft (2.5 m) or 16.4 ft (5 m) long, diameter (22 gauge) 3.6 mm (2 x 0.35 mm<sup>2</sup>)
- ② Socket Type KME-1-24-... with two conductor cables 8.2 ft (2.5 m) or 16.4 ft (5 m) long, diameter (18 gauge) 5.6 mm (2 x 0.75 mm<sup>2</sup>)
- ③ Mounting thread
- ④ Manual override
- ⑤ Yellow LED

Type	B in / mm	D1	D2	D3	D4 in / mm	D5 in / mm	H1 in / mm
VAD-MZB-I-M5	0.39 / 10	M5	M3	M5	0.13 / 3.2	—	2.28 / 58
VAD-MYB-I-1/8	0.59 / 15	G 1/8	M4	M5	0.16 / 4.2	—	2.66 / 67.5
VAD-ME-I-1/8	0.71 / 18	G 1/8	M4	G 1/8	0.16 / 4.2	0.13 / 3.2	3.66 / 93
VAD-ME-I-1/4	0.87 / 22	G 1/4	M4	G 1/8	0.16 / 4.2	0.16 / 4.2	4.20 / 106.8
VAD-ME-I-3/8	0.87 / 22	G 3/8	M5	G 1/4	0.20 / 5.2	0.20 / 5.2	4.45 / 113.1
Type	H2 in / mm	H3 in / mm	H4 in / mm	H5 in / mm	H6 in / mm	L1 in / mm	L2 in / mm
VAD-MZB-I-M5	0.39 / 9.8	0.20 / 5	0.57 / 14.5	1.10 / 28	1.89 / 48	2.32 / 59	2.16 / 55
VAD-MYB-I-1/8	0.50 / 12.7	0.28 / 7	0.87 / 22	1.34 / 34	2.30 / 58.5	3.16 / 80.2	2.64 / 67
VAD-ME-I-1/8	0.56 / 14.2	0.26 / 6.5	0.79 / 20	1.42 / 36	2.52 / 64	2.99 / 76	2.40 / 61
VAD-ME-I-1/4	0.34 / 8.7	0.35 / 9	1.30 / 33	1.97 / 50	3.06 / 77.8	3.80 / 96.6	2.40 / 61
VAD-ME-I-3/8	0.43 / 11	0.39 / 10	1.54 / 39	2.20 / 56	3.31 / 84	4.01 / 101.8	2.40 / 61
Type	L3 in / mm	L4 in / mm	L5 in / mm	L6 in / mm	L7 in / mm		
VAD-MZB-I-M5	0.79 / 20	0.26 / 6.5	1.06 / 27	2.28 / 58	1.42 / 36		
VAD-MYB-I-1/8	1.02 / 26	0.22 / 5.5	1.32 / 33.5	2.76 / 70	1.77 / 45		
VAD-ME-I-1/8	1.06 / 27	0.75 / 19	1.20 / 30.5	3.78 / 96	1.28 / 32.5		
VAD-ME-I-1/4	1.14 / 29	0.89 / 22.5	0.85 / 21.5	3.78 / 96	1.46 / 37		
VAD-ME-I-3/8	1.26 / 32	0.92 / 23.5	0.85 / 21.5	3.78 / 96	1.56 / 39.5		

# Solenoid-Actuated Vacuum Generators

Performance Graphs, Type VAD-M...-

Air consumption as a function of operating pressure

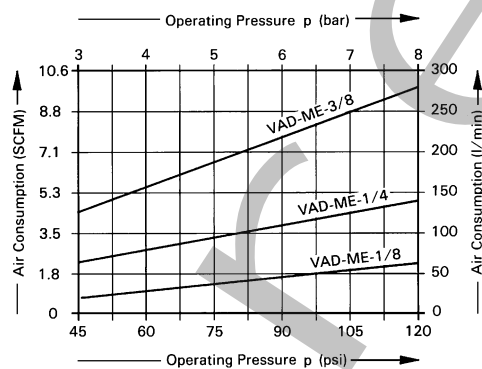
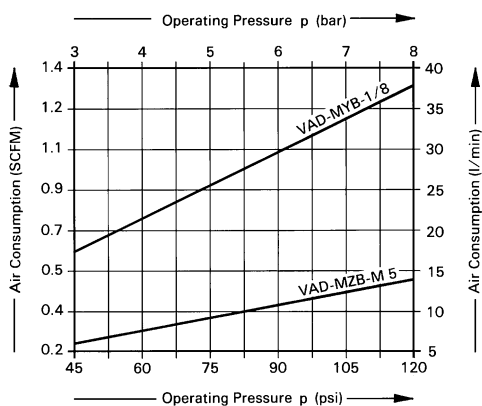

Vacuum as a function of operating pressure

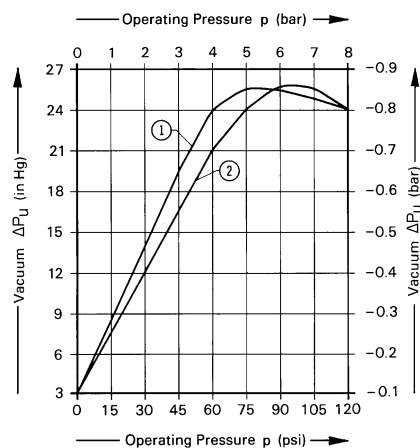

- ① VAD-MZB-M5  
VAD-MYB-1/8  
VAD-ME-1/4  
VAD-ME-3/8
- ② VAD-ME-1/8

Noise level as a function of operating pressure (without suction flow)

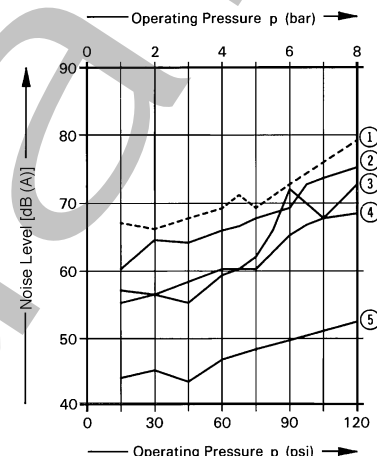

- ① VAD-ME-3/8
- ② VAD-ME-1/8
- ③ VAD-M3-1/4
- ④ VAD-MYB
- ⑤ VAD-MZB

Efficiency as a function of vacuum at rated pressure

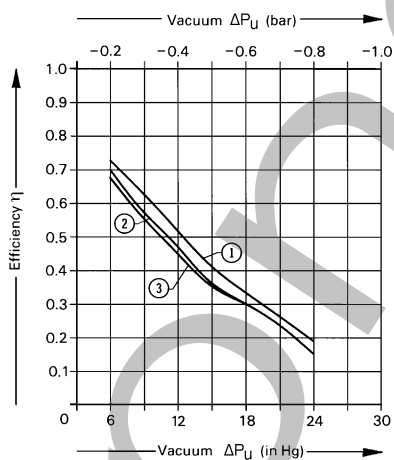

- ① VAD-ME-...
- ② VAD-MYB-...
- ③ VAD-MZB-...

The degree of efficiency is a criterion for making an objective comparison between vacuum generators of very different designs (single stage or multistage).

$$\eta(\Delta p_U) = \frac{1}{1 + \frac{t(\Delta p_U) \cdot Q}{V \cdot 60 \text{ s/min}}}$$

$\eta(\Delta p_U)$  Degree of efficiency of vacuum generator relative to vacuum

$t(\Delta p_U)$  Evacuation Time (s)

$Q$  Air consumption (l/min)

$V$  Volume to be evacuated standard volume (l)

Evacuation time for a two liter volume with an operating pressure of 90 psi (6 bar)

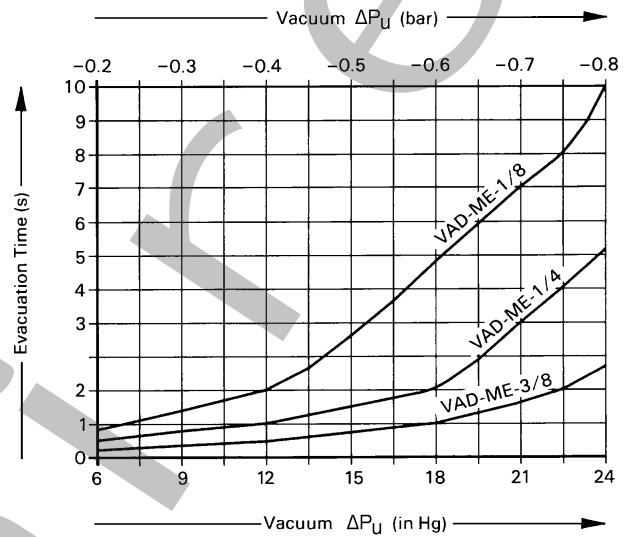
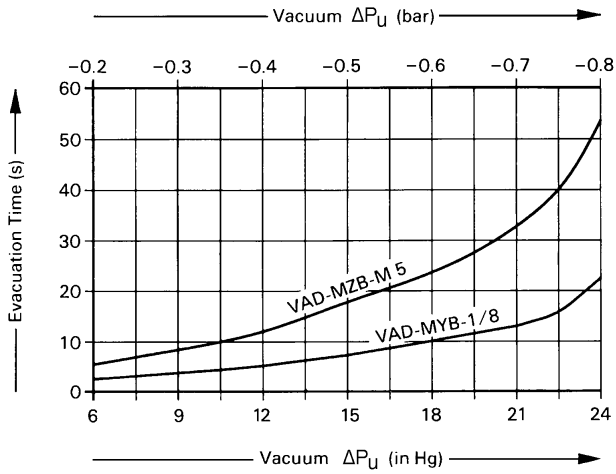

Evacuation volume as a function of the number of suction cups (VAS) and tubing (PU)

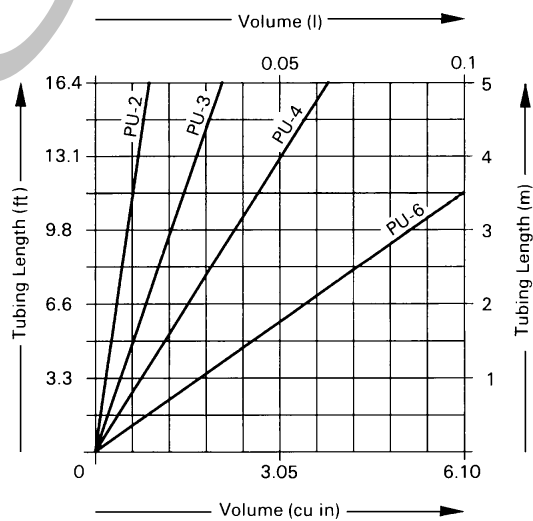
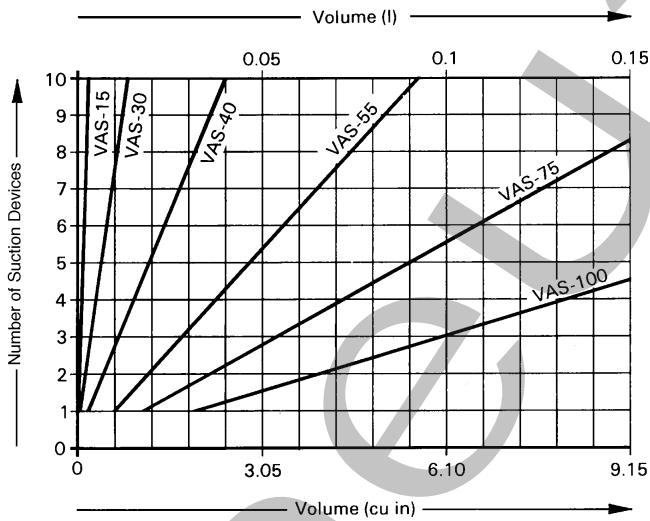

PU... = Festo polyurethane tubing

# All-Pneumatic Vacuum Generators

Features and Benefits

## All-Pneumatic Vacuum Generators

Types VAD-...  
with Ejector Pulse, Type VAK-...

- 1 No moving parts for virtually maintenance free operation
- 1 Vacuum Ports:  
M5 to G 3/8
- 1 Supply Ports:  
M5 to G 3/8
- 1 Exhaust Ports:  
M5 to G 3/8
- 1 Lightweight corrosion resistant Aluminum housing
- 1 Pressure Range:  
22 to 150 psi / 1.5 to 10 bar

Pages 45-47



Type VAD-...



Type VAK-...

Built-in Reservoir  
(Type VAK) for  
Rapid Part Ejection

Connection for  
External Reservoir

Exhaust Port

Vacuum via  
Venturi Principle

Supply Port

Vacuum Port

Shown with Suction Cup,  
(Ordered Separately)

# All-Pneumatic Vacuum Generators

Vacuum Generators, Type VAD-..., VAK-...

## All-Pneumatic Vacuum Generators

### Type VAD-...

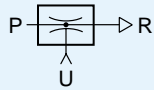

Type VAD-1/4

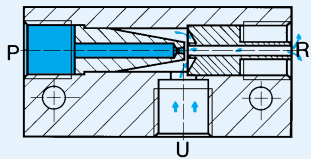

### with ejector pulse Type VAK-1/4

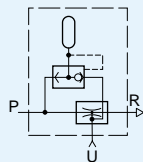

Type VAK-1/4

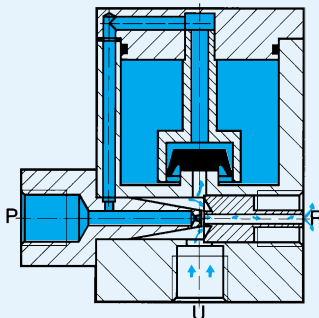

Ordering Information, see pages 8-10

#### Accessories:

Vacuum Suction Cups and Adapters, see pages 48-65

Silencers, see pages 90-92

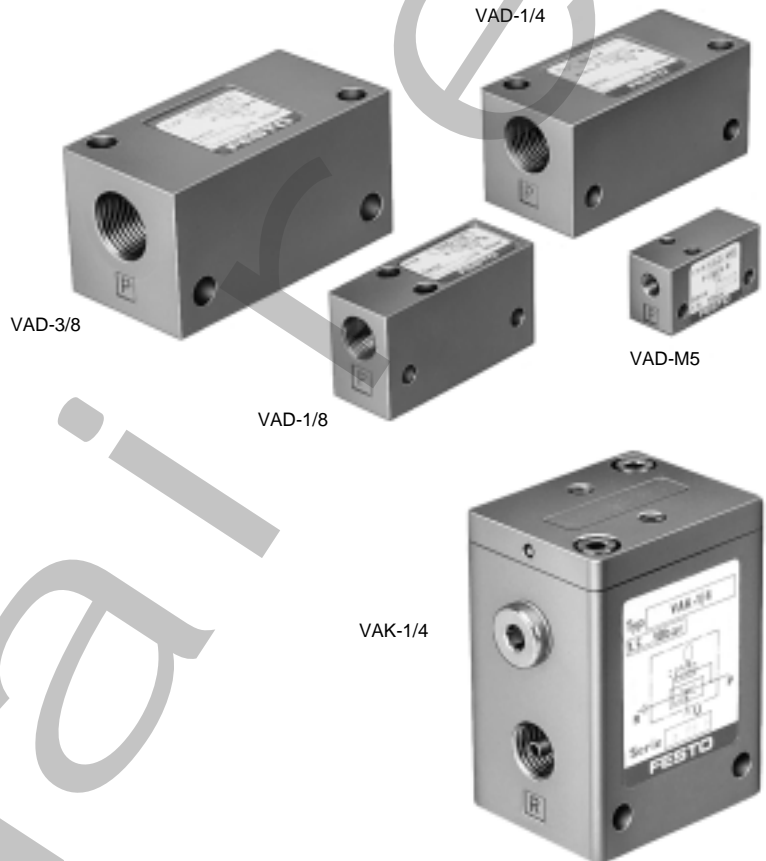

Festo vacuum generators utilize a Venturi principle to generate vacuum without the use of expensive vacuum pumps. The vacuum is achieved using shop air (filtered, lubricated or non-lubricated) obtained directly from the compressed air network.

The design of the system assures minimal air consumption. Silencers can be connected at port R to muffle exhaust noise. Vacuum generators, Type VAK, feature ejector pulse capability for fast ejection. When the intake is closed, air stored in the built-in air chamber surges through port U, ejecting the object being held.

Supply air can be controlled by an additional 2- or 3-way, 2-position directional control valve to save air.

Order Number	Part No./Type	19293 VAD-M5	14015 VAD-1/8	9394 VAD-1/4	19294 VAD-3/8	6890 VAK-1/4
Nozzle Diameter	Venturi Nozzle	0.02 in / 0.5 mm	0.03 in / 0.8 mm	0.04 in / 1.1 mm	0.06 in / 1.5 mm	0.04 in / 1.1 mm
	Receiver Nozzle	0.05 in / 1.3 mm	0.08 in / 2.1 mm	0.11 in / 2.8 mm	0.16 in / 4.0 mm	0.11 in / 2.8 mm
Medium		Compressed air				
Design		Venturi principle				
Mounting		Through holes in housing				M6 threading
Connection		M5	G 1/8	G 1/4	G 3/8	G 1/4
Pressure Range		22 to 150 psi / 1.5 to 10 bar				
Vacuum Level, Air Consumption, Noise Level		See graphs on page 47				
Air Reservoir Volume		1.95 cu in / 32 cm <sup>3</sup>				
Temperature Range		-4 to +176°F / -20 to +80°C				
Materials		Housing: Anodized aluminum				
Weight		0.031 lb / 0.014 kg	0.086 lb / 0.039 kg	0.201 lb / 0.091 kg	0.340 lb / 0.154 kg	0.580 lb / 0.263 kg



# All-Pneumatic Vacuum Generators

Dimensions, Type VAD-..., VAK-...

Type VAD-M5

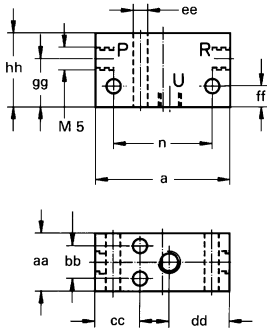

Type VAD-1/8

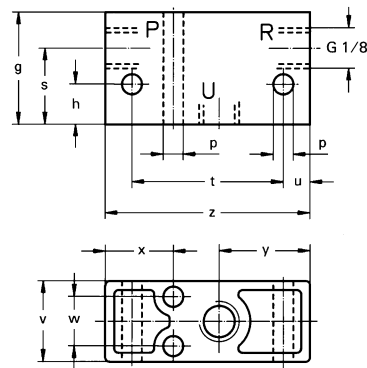

Type VAD-1/4

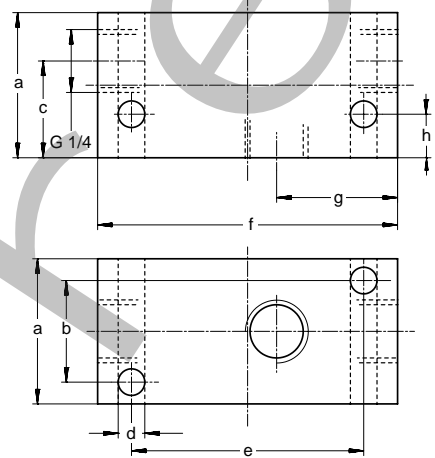

Type VAD-3/8

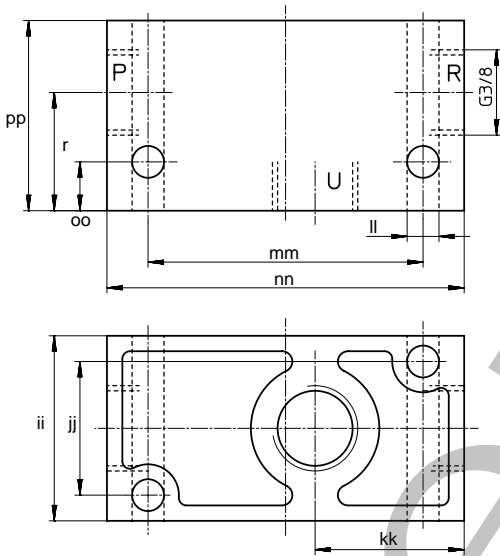

Type VAK-1/4

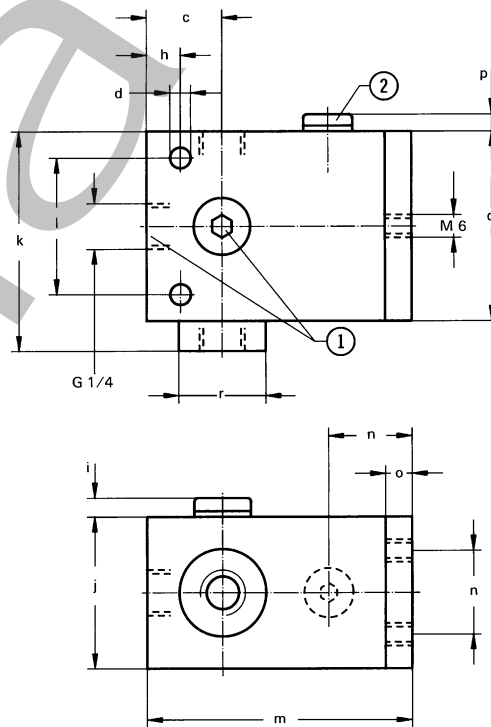

## Dimensions

a	1.18 in / 30 mm	v	0.71 in / 18 mm
b	0.83 in / 21 mm	w	0.43 in / 11 mm
c	0.79 in / 20 mm	x	0.60 in / 15.3 mm
d	0.22 in / 5.5 mm	y	0.80 in / 20.4 mm
e	1.89 in / 48 mm	z	1.81 in / 46 mm
f	2.44 in / 62 mm	aa	0.51 in / 13 mm
g	0.98 in / 25 mm	bb	0.29 in / 7.3 mm
h	0.35 in / 9 mm	cc	0.39 in / 10 mm
i	0.20 in / 5 mm	dd	0.53 in / 13.5 mm
j	1.58 in / 40 mm	ee	0.13 in / 3.2 mm
k	2.28 in / 58 mm	ff	0.18 in / 4.7 mm
l	1.42 in / 36 mm	gg	0.42 in / 10.8 mm
m	2.76 in / 70 mm	hh	0.65 in / 16.5 mm
n	0.87 in / 22 mm	ii	1.42 in / 36 mm
o	0.28 in / 7 mm	jj	1.02 in / 26 mm
p	0.18 in / 4.5 mm	kk	1.14 in / 29 mm
q	1.97 in / 50 mm	ll	0.24 in / 6.2 mm
r	0.91 in / 23 mm	mm	2.11 in / 53.5 mm
s	0.67 in / 17 mm	nn	2.74 in / 69.5 mm
t	1.34 in / 34 mm	oo	0.37 in / 9.5 mm
u	0.24 in / 6 mm	pp	1.46 in / 37 mm

P = Supply  
U = Vacuum Connection  
R = Exhaust

- ① Port U
- ② Port for additional ejector pulse air volume

Air consumption as a function of operating pressure

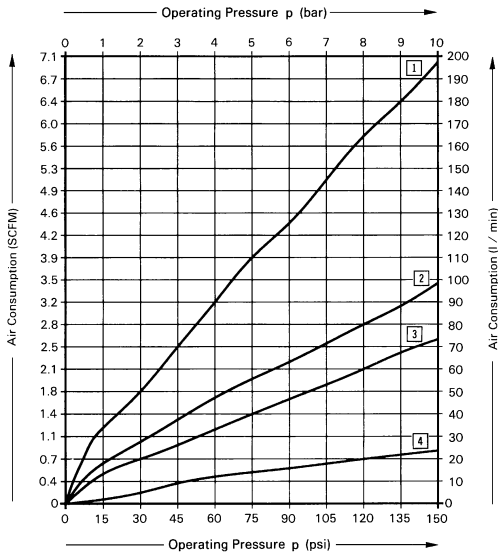

Vacuum flow as a function of operating pressure

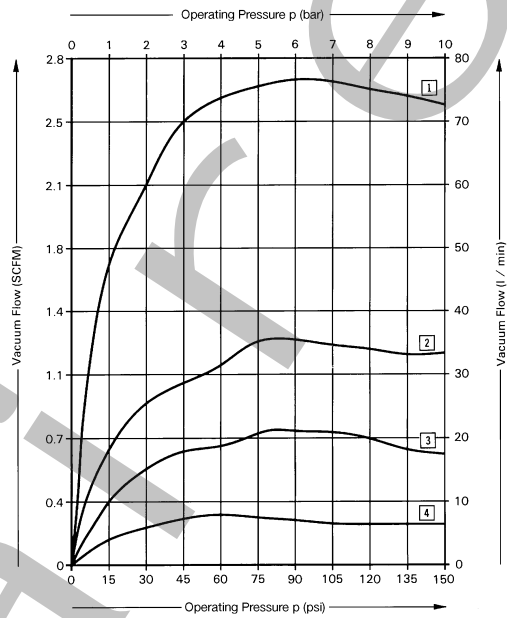

Vacuum as a function of operating pressure

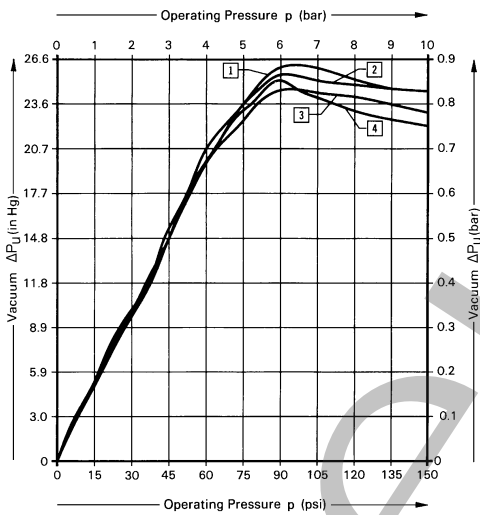

- 1 VAD-3/8
- 2 VAD-1/4  
VAK-1/4
- 3 VAD-1/8
- 4 VAD-M5

Noise level as a function of operating pressure

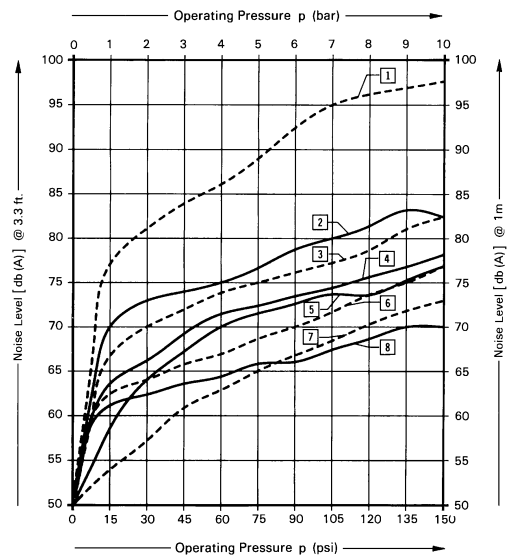

Suction flow rate as a function of vacuum level

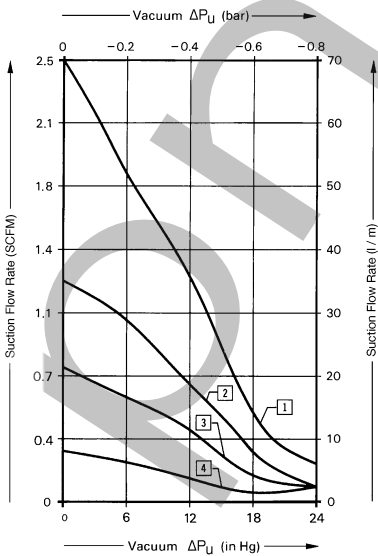

- 1 VAD-3/8
- 2 VAD-1/4
- 3 VAD-1/8
- 4 VAD-M5

- 1 VAD-3/8\*
- 2 VAD-3/8†
- 3 VAD-1/4\*
- 4 VAD-1/4†
- 5 VAD-M5†
- 6 VAD-1/8\*
- 7 VAD-M5†
- 8 VAD-1/8†

\* = without silencer  
† = with silencer