

MOVIDYN[®] Servo Controllers

Edition

11/2000



Operating Instructions



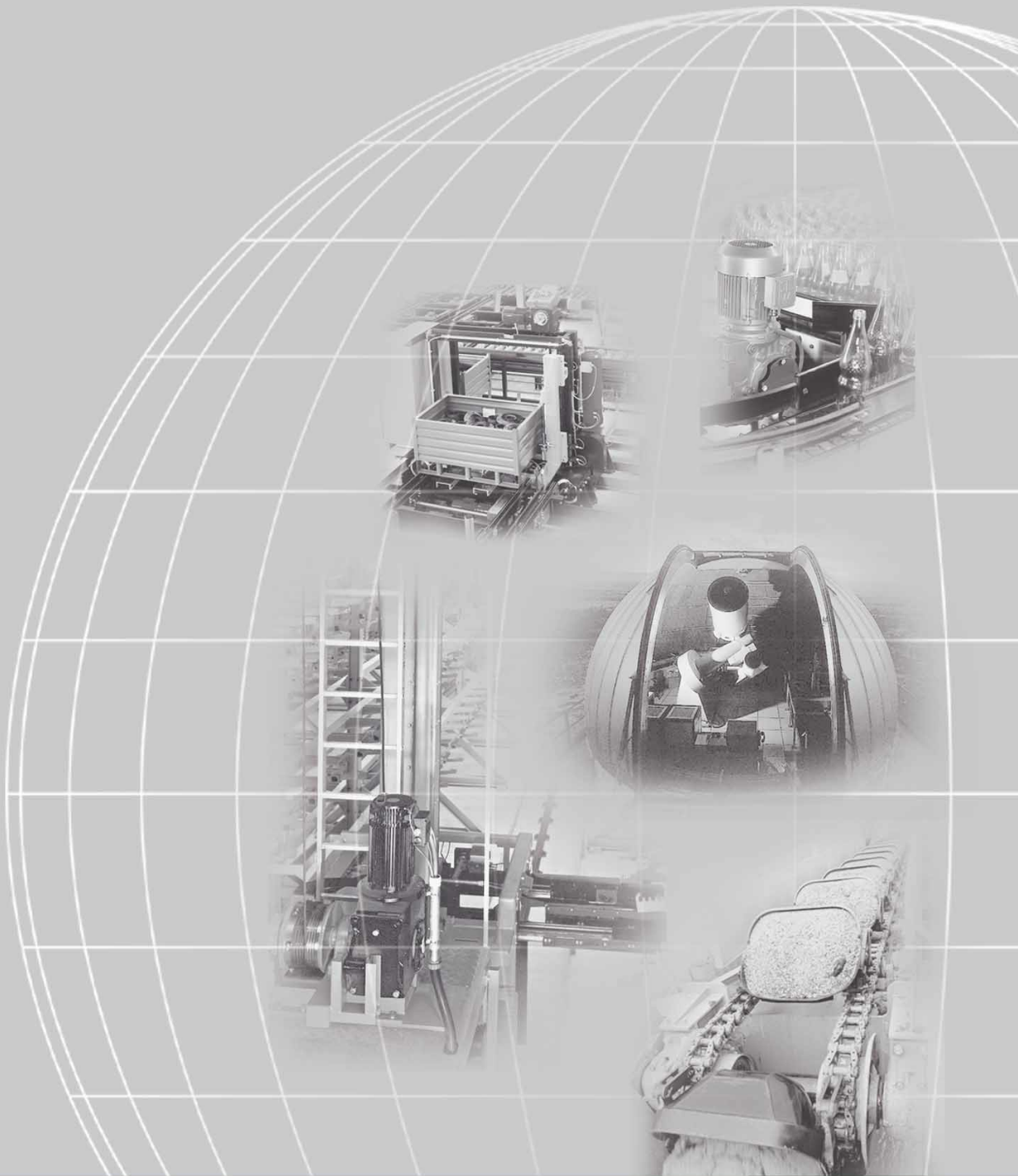





09223711 / EN



SEW-EURODRIVE





	1 Important Notes	4
	2 Safety Instructions	6
	3 Unit Design	7
	3.1 MPR / MPB	7
	3.2 MAS / MKS	8
	3.3 Unit Designation	9
	3.4 Type Designations	9
	4 Mechanical Installation	10
	4.1 Design of an Axis System.....	10
	4.2 Installation of Option Cards	11
	5 Electrical Installation	13
	5.1 Assembly Instructions for Shield Clamps	13
	5.2 Supply, Inverter, and Motor Connection	14
	5.3 Control of the Mechanical Brake.....	17
	5.4 Electronic Lines and Signal Generation.....	19
	5.5 EMC-Compliant Installation	19
	5.6 UL-Compliant Installation.....	22
	5.7 Wiring Diagrams	23
	5.8 Description of Terminal Functions	26
	5.9 RS-485 Interface Connection	29
	6 Startup	30
	6.1 Initial Settings	30
	6.2 List of Parameters.....	34
	7 Operation and Service	38
	7.1 Status LEDs.....	38
	7.2 Reset Options	38
	7.3 List of Fault Messages.....	39
	7.4 SEW Electronics Service	41
	8 Technical data	42
	8.1 General Technical Data	42
	8.2 Technical Data of Basic Units.....	43
	9 Index	46
	Addresses	49



1 Important Notes

Warnings and Safety Instructions

Always follow warnings and safety instructions in this publication!

	Electrical hazard Possible effects: Serious or fatal injury.
	Immediate danger Possible effects: Serious or fatal injury.
	Dangerous situation Possible effects: Minor injury.
	Harmful situation Possible effects: Damage to equipment or surroundings.
	Application hints and useful information.

Operating Instructions

It is required to follow these instructions for fault-free operation and fulfillment of any rights to claim under warranty. Read these instructions carefully before you start working with the unit!



These operating instructions contain vital servicing information and should be kept in close proximity to the drive unit.

Intended Use

MOVIDYN[®] servo controllers are devices for industrial and commercial systems for operation of permanent-field AC servomotors. These motors must be suitable for operation with frequency inverters. Other loads must not be operated with these inverters.



MOVIDYN[®] servo controllers are units intended for stationary installation in switch cabinets. All information pertaining to technical data and required conditions at the site must strictly be followed.

Startup (beginning of normal use) is not permitted until it is determined that the machine meets the EMC directive 89/336/EEG and the conformity of the finished product with the machine directive 89/392/EEG is established (observe EN 60204).



The following are prohibited unless expressly stated otherwise:

- operation in areas subjected to explosion hazards
- operation in the vicinity of harmful oils, acids, gases, vapors, dust, radiation, etc.
- operation in non-stationary systems where mechanical vibration and impact loads occur that exceed the requirements of EN50178
- operation in applications in which the inverter itself (without higher-level safety systems) performs safety functions that must ensure the protection of equipment and life

Disposal



Please observe all applicable waste disposal regulations:

Carry out the disposal according to the materials used and relevant regulations, such as: Electronics waste (circuit boards), plastic (housing), sheet metal, copper, etc.

Documentation

Title	Order no.
DFS/DFY Synchronous Motors Operating Instructions	0922 7113
Communications Interfaces Manual	0922 8764
Parameter List Manual	0921 2868
IPOS Positioning Control Manual	0922 341X
APA12 / API12 Single-Axis Positioning Control Manual	0922 8713
MD_SHELL Manual	0921 9315
MD_SCOPE Manual	0921 9412
Fieldbus Unit Profile Manual	0922 761X
"CAN-Bus" AFC11A Option Manual	0922 6567
"INTERBUS" AFI11A Option Manual	0922 7717
"PROFIBUS" AFP11A Option Manual	0922 856X
"DeviceNet" AFD11A Option Manual	0919 6818
Fieldbus Interfaces Documentation Package	0922 7814
APA12/API12 Positioning Control Documentation Package	0921 6774
Drive Engineering – Practical Implementation, Volume 7, "Servo Drives: Basics, Characteristics, Project Planning"	0922 4610

This documentation can be obtained from SEW by using the respective order number.



2 Safety Instructions

Installation and Startup



- In compliance with existing regulations (e.g., EN 60204, VBG 4, DIN-VDE 0100/0113/0160), only electrical specialists with accident prevention training are permitted to perform installation, startup, and service work on the unit.
- Observe the respective instructions for installation and startup of motor and brake!
- Preventive measures and protection devices must correspond to the existing regulations (e.g., VDE 0100 T410 / VDE 0112 T1 or DIN 60204 / VDE 0160).

Necessary protective measures: Grounding of unit

Necessary protection devices: Overcurrent protective device (fuses)

- Use appropriate measures (e.g., removing the electronic terminal block) to ensure that the connected motor does not start automatically when the inverter is powered up.

Operation and Service



- Before removing the protective cover, disconnect the unit from the supply system. Dangerous voltages may still be present for up to 10 minutes after shutdown.

- If the protective cover is removed, the unit enclosure type is IP 00. All modules except for the control electronics feature dangerous voltages. During operation, the unit must be closed.

- In the energized state, dangerous voltages occur at the output terminals and the attached cables and motor terminals. This also applies if the unit is inhibited and the motor is stopped.

- The fact that the Status LED and other display elements are no longer illuminated does not indicate that the unit has been disconnected from the power supply and does not carry any voltage.



- Unit-based safety functions or mechanical blocking can result in motor standstill. Removing the cause of this problem or resetting the drive can result in the drive restarting on its own. If this is not permissible for safety reasons: Before correcting the fault, the unit must be disconnected from the supply system. In these cases it is also prohibited to activate the function "Auto-Reset" (P630).



3 Unit Design

3.1 MPR / MPB

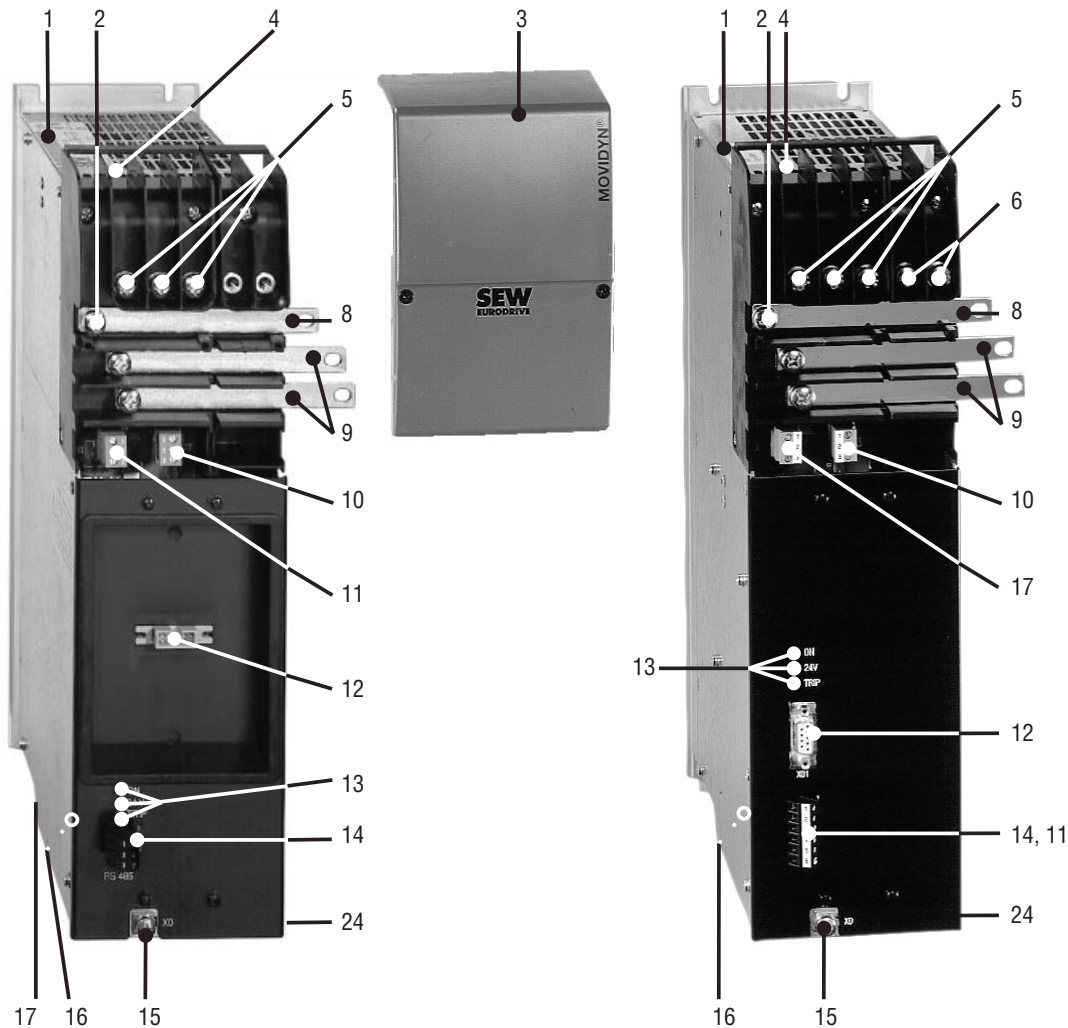

Figure 1: System overview of MPR / MPB power supply module

00249CXX

- 1 Nameplate
- 2 Protective conductor connection
- 3 Protective cover
- 4 Shield ground connection
- 5 Supply system connection (X1; MPx: 1, 2, 3; MKS: L1, L2, L3)
- 6 Braking resistor connection (MPB: X4; MKS: X1; +, R)
- 7 DFS/DFY motor connection (X1; MAS: 1, 2, 3; MKS: U, V, W)
- 8 Protective conductor connection
- 9 DC link connection (X1)
- 10 24 V bus (MPx: X3 (output); MAS: X2 (input), X3 (output))
- 11 External 24 V connection (MPR: X2; MPB: X02 (5, 6); MKS: X41 (5, 6))
- 12 MKS: X2/MPR: X01: ABG11 or USS11A can be connected; MPB: X01: RS-232 serial interface
- 13 Status LEDs



3.2 MAS / MKS

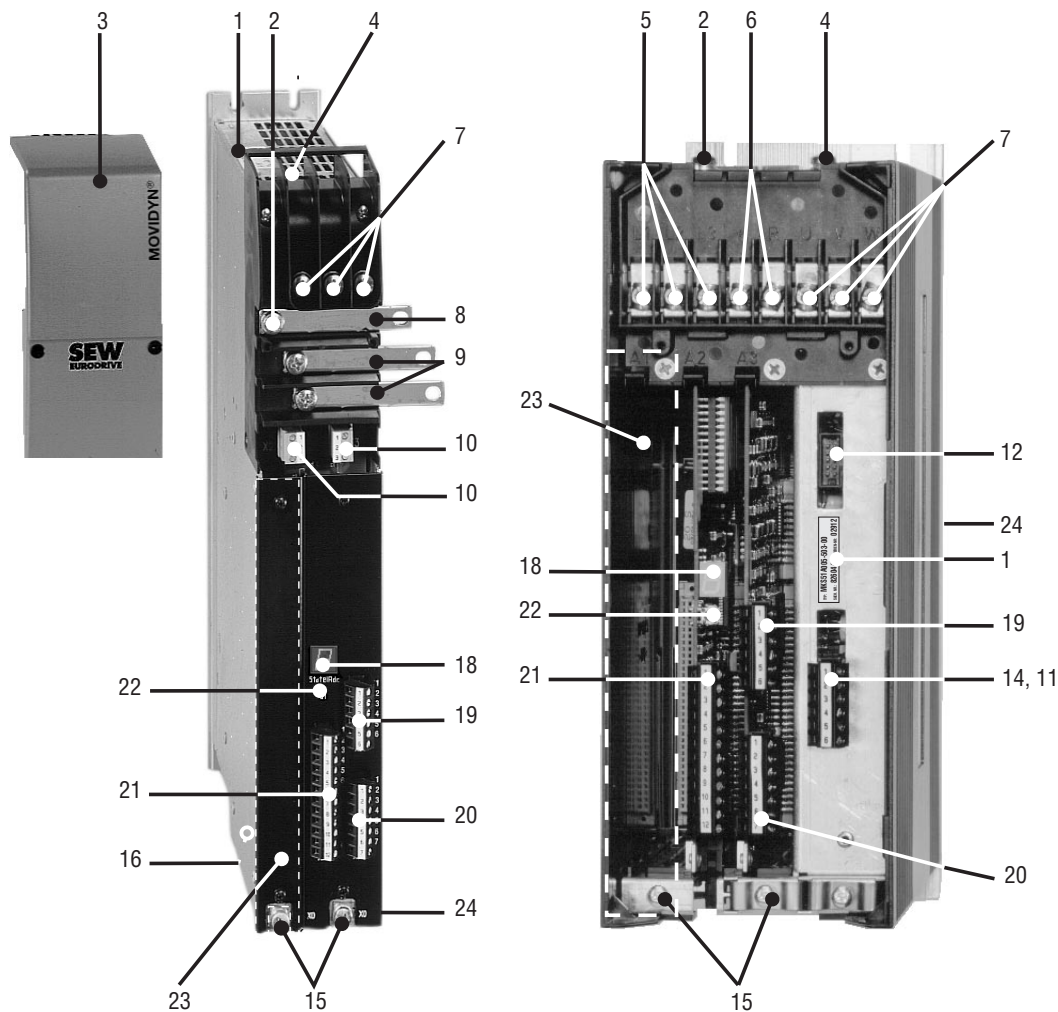

Figure 2: System overview of MAS axis module / MKS compact servo controller

00250BXX

- 14 RS-485 serial interface (MPR: X02; MPB X02 (1, 2, 3); MKS: X41 (1, 2, 3))
- 15 Shield ground connection (electronic leads) (X0)
- 16 Data bus connector (underside of unit) (X5)
- 17 Heat sink fan connector (MPR: X6; MPB: X2)
- 18 7-segment display
- 19 Resolver connection (X31)
- 20 Encoder simulation output (X32)
- 21 X21: output 10 V (1, 4), analog differential input (2, 3), binary inputs (5 ... 8), binary outputs (9, 10), output 24 V (11, 12)
- 22 S1 button
- 23 Option card slot
- 24 Service label

MKS: Illustration without protective cover



3.3 Unit Designation

Nameplate Example:

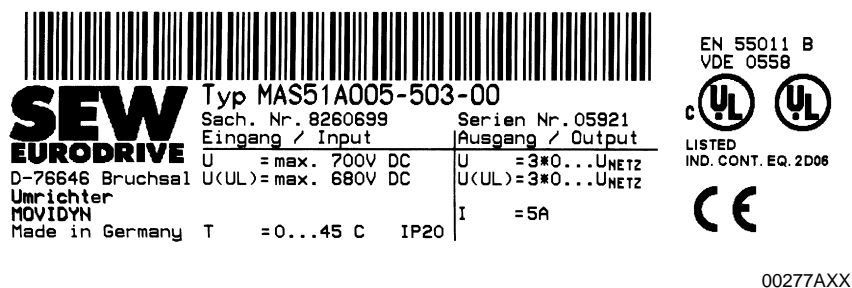
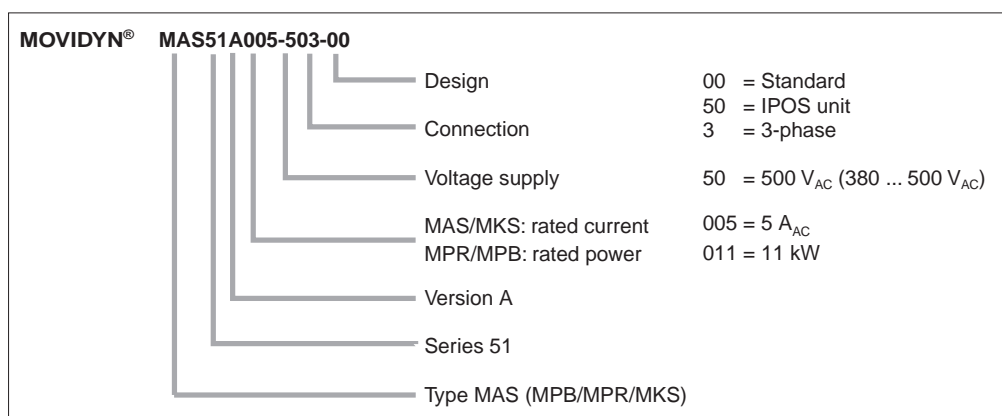

Figure 3: Sample nameplate

CE Designation MOVIDYN® servo controllers meet the guidelines of the low voltage directive 73/23/EWG and the EMC directive 89/336/EWG.

3.4 Type Designations



00278DEN

Figure 4: Sample type designation

Examples:

- MAS 51A 015-503-00 axis module with 15 A rated output current, 3 x 500 V, standard design
- MPB 51A 027-503-00 power supply module with brake chopper with 27 kW rated output power, 3 x 500 V, standard design



4 Mechanical Installation

4.1 Design of an Axis System

Switch Cabinet

Installation in a switch cabinet with application-specific enclosure

Avoid dust accumulation and moisture condensation. Provide for installation of ventilation filter mats in the case of forced air-cooling.

Minimum Clearance for Cooling

Above and below the units: at least 100 mm (3.94 in)

Heat Sink

Clean the surfaces of the heat sinks and the backs of the power supply and axis modules with a dry cloth.

Fasten the power supply and axis modules onto the heat sinks. The heat sinks feature tapped holes in a 35-mm (1.38 inch) grid for this purpose. Mounting is carried out without heat sink compound.

Tightening torque of screws: max. 3.5 Nm.

Each module must be installed completely on **one** heat sink, i.e., do not mount a module over the joint of two heat sinks.

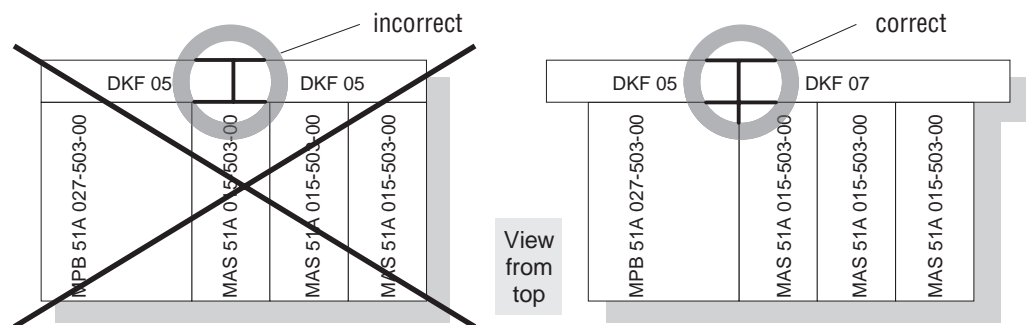

MD0018BE

Figure 5: Installation of heat sinks

The MKS compact servo controllers feature integrated heat sinks.

If several heat sinks are used in a multi-axis block, care must also be taken that they feature a (large-size, $\geq 10 \text{ mm}^2$ [0.155 in²]) conducting connection. If this is not the case with coated mounting surfaces, the connection must be ensured by using a bridge (litz wire with corresponding cross-section) between the mounting screws of the MOVIDYN[®] modules from one heat sink to the next one.

Line Chokes

Mount the line chokes close to the corresponding unit, but outside of the minimum cooling clearance.

The MKS compact servo controllers do not require line chokes.

Braking Resistors

They should be mounted in a well-ventilated location, e.g., on top of the switch cabinet. The resistor surface reaches high temperatures under load with rated power.

Axis Modules

Mount the axis modules to the right of the power supply modules; otherwise, the 24 V_{DC} connection is difficult to mount.



4.2 Installation of Option PCBs

Before You Begin

- Keep the option pcb in its original packaging and remove it only when you are ready to exchange it.
- Grasp only the edge of the pcb and do not handle it too often. Do not touch any components.
- Also observe the addendum to the operating instructions that accompanies the pcb.
- The pcb is supplied with the necessary voltage via rear panel connector. The required power may make it necessary to connect an external 24 V supply.
- Disconnect the supply voltage of the servo controller. Switch off the supply voltage and the 24 V supply, if necessary.

Installation of Option PCB

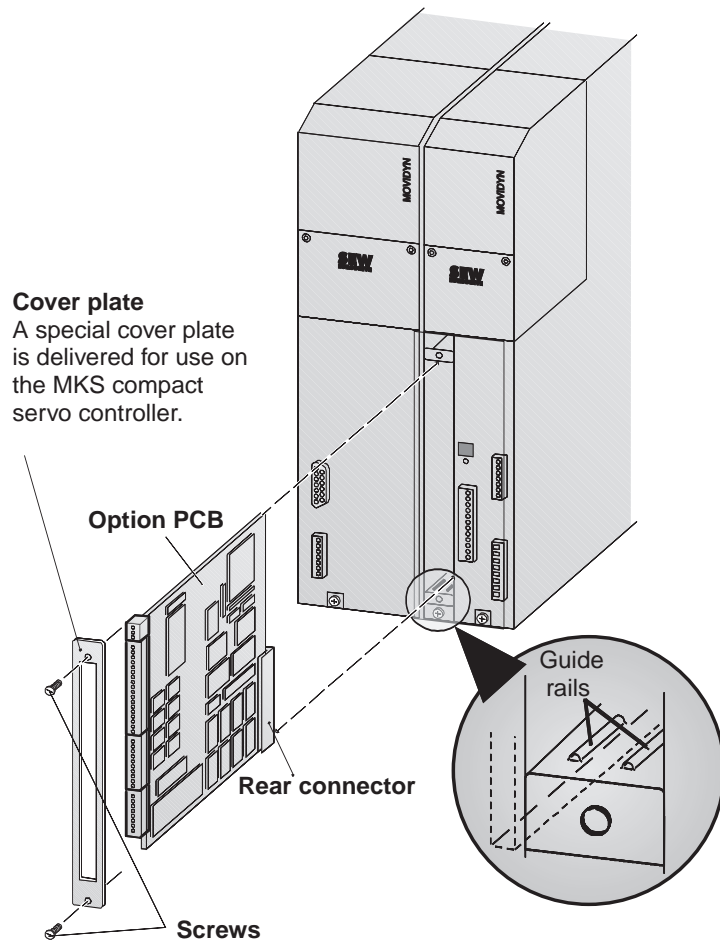

Figure 6: Installation of option pcb

MD0054CE



- **MAS:** Remove the black front left cover plate: Remove both the crosstip screws.
- **MKS:** Remove the lower part of the protective cover.



Caution: In its open state, the unit features enclosure rating IP00. Dangerous voltages may still be present for up to 10 minutes after shutdown.

- Take appropriate ESD measures (anti-static band, conductive shoes, etc.) before touching the option pcb. Insert the pcb into the guide rails of the slot with the back of the connector pointing backwards. Ensure that the pcb is also properly inserted in the rear guide rails.
- Press the rear connectors on the pcb into the sockets in the housing.
The connector housings of the front of the pcb must be flush with the cover of the axis module / compact servo controller.
- **MAS:** Fit the included cover plate over the pcb slot (2 screws).
MKS: Depending on the option pcb, the protective cover may not be mountable for the compact servo controller. In this case, affix the included cover plate instead.
- Detach connector X21 (binary inputs/binary outputs) to prevent unintentional motor start.
- Connect the unit to supply voltage or 24 V supply.
- Verify by means of the corresponding menu items whether the computer “recognized” the option card (if necessary, check the function of the pcb).
- Program the terminal assignment to the corresponding function before startup of the drive.

Startup of Option Card



- If necessary, switch off the supply voltage and the 24 V supply.
- Attach connector X21.



5 Electrical Installation



For electrical installation, the section on *Safety Notes* must be strictly observed!

The following sections describe the installation of MOVIDYN® servo controllers.

To achieve interference-free operation under all conditions, it is recommended to perform EMC-compliant installation.

5.1 Assembly Instructions for Shield Clamps

Shield clamps provide for simple connection of motor, braking resistor, and signal cable shields. Assembly can be especially simplified with EMC-compliant cabling. In addition, the shields are flat and, therefore, placed very effectively.

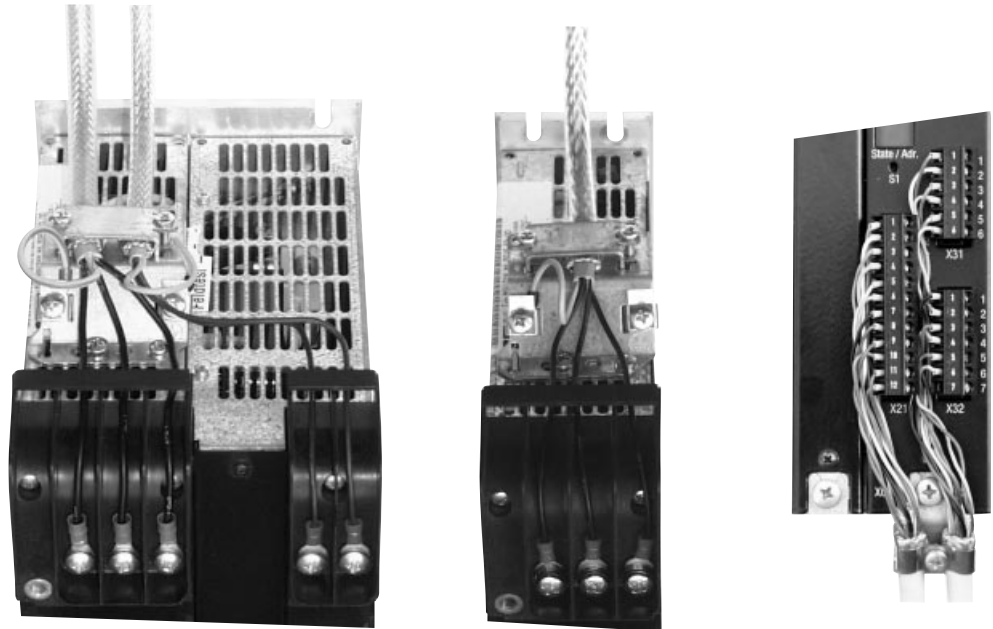

03843AXX

Figure 7: Shield clamps

Assembly

- The illustration shows correctly installed shield clamps for supply and brake connection on a power supply module, motor connection on an axis module, and connection of electronic cables on an axis module. The shield clamps on a compact servo controller should be connected in the same way.



- Do not perform the assembly of motor and braking resistor cable with the terminal attached as parts of the braid shield may fall into the unit.



- Expose approximately 30 mm of the shield so that the cable has the correct connection length. Prefabricated cable from SEW is correctly exposed.
- Fasten the shield clamp onto the unit using the supplied screws. Do not use longer screws.
- Connect the cable at this time only. This prevents the shield from being stressed and parts of the shield from becoming detached.

5.2 Supply, Inverter, and Motor Connection

Power Supply Module – Axis Module Connection

Connect the power supply module and axis module(s) to the supplied conductor rail.

Firmly tighten all connections, including PE protective conductor.

Tightening torque: max. 3.5 Nm

- For the electronics voltage supply, attach connector X3 of a module to connector X2 of the following module using the supplied cables.

Cross-section: 1.5 mm² (AWG#16)

- Attach the X5 connectors of the module (bottom side of unit) with the DBK data bus cable.



Important: Do not cut off the unused connectors of the DBK but, instead, fold them over and tie them down.

Braking Resistor Connection

Connect the braking resistor to terminals X4.+ and X4.R at the MPB... power supply module or to terminals X1.+ and X1.R at the compact servo controller.

Use two cables located close to each other (e.g., twisted pair).

The line cross section should be dimensioned for maximum brake current.



Caution: The leads to the braking resistor carry high DC voltages (up to approx. 900 V_{DC}) in rated operation!

DKF Heat Sink

Connect the fan to terminals X2.2 and X2.3 of the MPB... power supply module or to terminals X6.1 and X6.2 of the MPR... power supply module.



Important: Observe the polarity: X2.2 / X6.2: black cable / X2.3 / X6.1: red cable

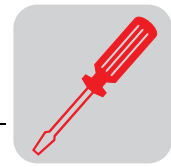

24 V_{DC} Supply

The MPB and MPR power supply modules and the MKS compact servo controller have their own internal 24 V_{DC} voltage supply which can provide the following power levels:

Type	MPB51A	MPR51A	MKS51A
P _{max, 24 v} [W]	240	50	29

The 24 Vdc supply in the MPB/MPR supplies the MAS axis modules connected, whereas in the MKS, only the option pcbs are supplied.

To provide the supply for the output stage, the MAS51A axis modules require the following power supply which they always draw from the internal 24 V_{DC} supply of the power supply module.

MAS51A type	005	010	015	030	060
P _{24 v, internal} [W]	5	5	5	7.5	15

If the fans in the DKF heat sinks are supplied via a power supply module, the required power must also be taken into consideration.

Type	DKF05	DKF07	DKF09
P _{24 v} [W]	6		9

The control and evaluation pcb present in every MAS/MKS or the option pcb in MAS/MKS have the following power consumptions:

Type	Control / evaluation	AIO11	AFC11	AFI11	AFP11	AFD11	APA/ API11/12
P _{24 v} [W] typ./max. ¹⁾	12 / 16.3	8 / 13.1	1 / 1.5	1.5 / 2.3	1.3 / 1.8	0.8 / 1.0	10 / 110 ²⁾

- 1) A relay current of approximately 30 mA was used as an example for a typical load of a binary output.
- 2) In general, an external 24 V supply is necessary if the binary outputs of the API are loaded correspondingly!

Internal 24 V_{DC} supply insufficient

If the power of the internal 24 V_{DC} voltage supply is insufficient, an external 24 V_{DC} power supply must be connected. It should be noted that the 24 V_{DC} switch cabinet supply is frequently insufficient in the case of larger systems. If the capacity of the internal 24 V_{DC} voltage supply is insufficient, the voltage range of the external voltage supply measures 24 ... 30 V_{DC}.

24 V_{DC} supply for power off

If the capacity of the internal 24 V_{DC} voltage supply is sufficient and the external 24 V_{DC} voltage supply is used, for example, to maintain communication, position detection, etc., during power off, then the voltage range of the external supply voltage measures 18 ... 30 V_{DC}.

Example

The power demand of a system consisting of MPB, MAS51A010 with AIO11 and MAS51A030 with API12 is calculated as follows:

$$5 + 12 + 8 + 7.5 + 12 + 10 = 54.5 \text{ W typical}$$

$$5 + 16.3 + 13.1 + 7.5 + 16.3 + 110 = 168.2 \text{ W max.}$$



24 V_{DC} supply of MPR...

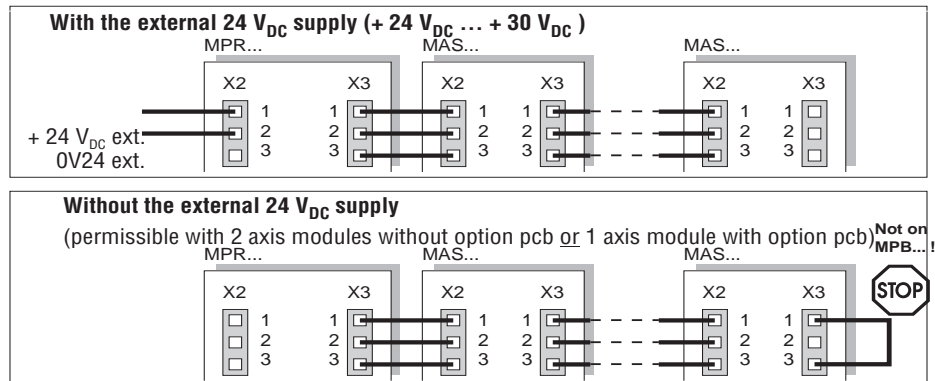

MD0164DE

Figure 8: 24 V_{DC} supply of MPR...

SEW strongly recommends using a separate 24 V_{DC} power supply for the MPR modules since the 24 V_{DC} switch cabinet supply is frequently insufficient, especially in the case of extended systems.

Supply System Lead, Input Fuses

- Designate supply system leads with L1, L2, L3 in accordance with IEC 445.
- Firmly tighten all connections, including PE protective conductor.
Tightening torque: max. 3.5 Nm.
- Install the F1/F2/F3 input fuses directly behind the conductor branch of the supply system cable.
- Always install the supply contactor in front of an input filter, if present (→ EMC-compliant installation).

Motor Lead

- Cable length: max. 100 m (325 ft).
- Designate motor leads with U, V, W in accordance with IEC 445.
- Firmly tighten all connections, including PE. Tightening torque: max. 3.5 Nm.



Important: Observe the phase sequence (→ wiring diagrams)!

- The motor lead must be routed separately from all other lines. If a minimum distance of 20 cm (8 in) cannot be maintained over longer distances (20 m [65 ft]), it is recommended to shield the motor lead. If shielding cannot be achieved, please consult SEW.
- Output filters between servo controller and motor are not permitted.

**Resolver Cable**

- Use a shielded cable with twisted pairs (1/2, 3/4, 5/6) (→ wiring diagrams).
Length: max. 100 m (325 ft) 8-core: 3 x 2 for resolver, 1 x 2 for motor protection
Cross-section: $l > 50$ m (164 ft): 0.50 mm^2 (AWG#20)
 $l \leq 50$ m (164 ft): 0.25 mm^2 (AWG#24)
- Ground the shield flat on both sides. For this purpose, connect the complete cross-section of the braid shield as a short section, i.e., without extension, to the X0 shield terminal.

Motor and Device Protection

- To protect the motor, connect the TH winding thermostat or TF PTC thermistor (→ wiring diagrams). A motor protection switch is not suitable.
- Protect the braking resistor (not for MPR... power supply module) with a thermal overcurrent protection switch (F16) from an excessive cyclic duration factor. The thermal overcurrent protection switch must act directly on the K11 supply system contactor.

5.3 Control of the Mechanical Brake**(only for operation with motor types DFS/DFY ... B)**

Important: Observe the operating instructions for DFS/DFY motor and the following block diagram!

In addition, observe the following notes to ensure proper functioning of the mechanical brake.

- Control the brake via X21.9 binary output “brake” and not via PLC (brake control system by the PLC can lead to uncontrolled system conditions)!
- The binary output X21.9 is not suited for direct activation of the brake! It is implemented as a relay driver with a control voltage of $24 \text{ V} / 3.6 \text{ W} / \text{max. } 150 \text{ mA}$. It is recommended to connect the following (observe the switching capability of the brake relay or the miniature contactor):
 - an external K13 braking relay that is suitable for control of K12 auxiliary contactors (e.g., contact rating of $250 \text{ V}_{\text{AC}} / 0.25 \text{ A}_{\text{AC}} / \text{AC11}$ or $24 \text{ V}_{\text{DC}} / 0.6 \text{ A}_{\text{DC}} / \text{DC11}$ in accordance with IEC 337-1). The contact of K13 braking relay is connected in series with the other closure contacts on the system side that control the K12 auxiliary contactor for brake excitation. It is also possible to use relays with internal rectifiers.
The braking relay may not be used for direct switching of the brake excitation without using an auxiliary contactor!
 - or a K12 miniature contactor (= auxiliary contactor) ($24 \text{ V} / 3.6 \text{ W} / 150 \text{ mA}$) as direct brake control system.
- If **BME brake rectifiers** are used:
Connect the BME to a separate supply system lead; do not supply it via motor voltage!
Route the connecting line brake - BME **separately from the motor lead** and shield it, if possible.
- If the **BSG brake control unit** (24 V_{DC} supply voltage) is used:
The voltage supply for terminals X21.. of the unit and for the BSG must be implemented separately!
- The reaction of the brake through cut-off of the brake rectifier can be carried out in the AC circuit (reaction time t_{21}) or in the DC and AC circuit (reaction time t_{211}).



For hoists, use only the disconnection on the DC side and the AC side!

Brake Reaction Times

DFS/DFY type brake motor		56B ¹⁾					71B					90B				112B			
Brake torque	[Nm] [in-lb]	2.5 22	3 26	6 53	10 88	15 133	6 53	12 106	20 177	30 265	40 354	17.5 155	35 309	60 530	90 796				
Releasing the brake Response time $t_1^{2)}$	[ms]	7	10	12	16	20	11	13	15	18	22	11	14	22	35				
Reaction of the brake Reaction time $t_{2I}^{3)}$	[ms]	5	400	220	120	65	200	140	90	55	42	440	315	230	170				
Reaction time $t_{2II}^{4)}$	[ms]		95	45	20	8	40	28	20	13	10	130	60	32	20				

- 1) For type DFS56B, use disconnection on DC side only since 24 V brake without brake rectifier is used.
- 2) With BME brake rectifier or BSG brake control unit
- 3) Disconnection on AC side
- 4) Disconnection on DC and AC side

Block Diagram

DY..B brake motor with BME brake rectifier via K13 brake relay and K12 auxiliary contactor.

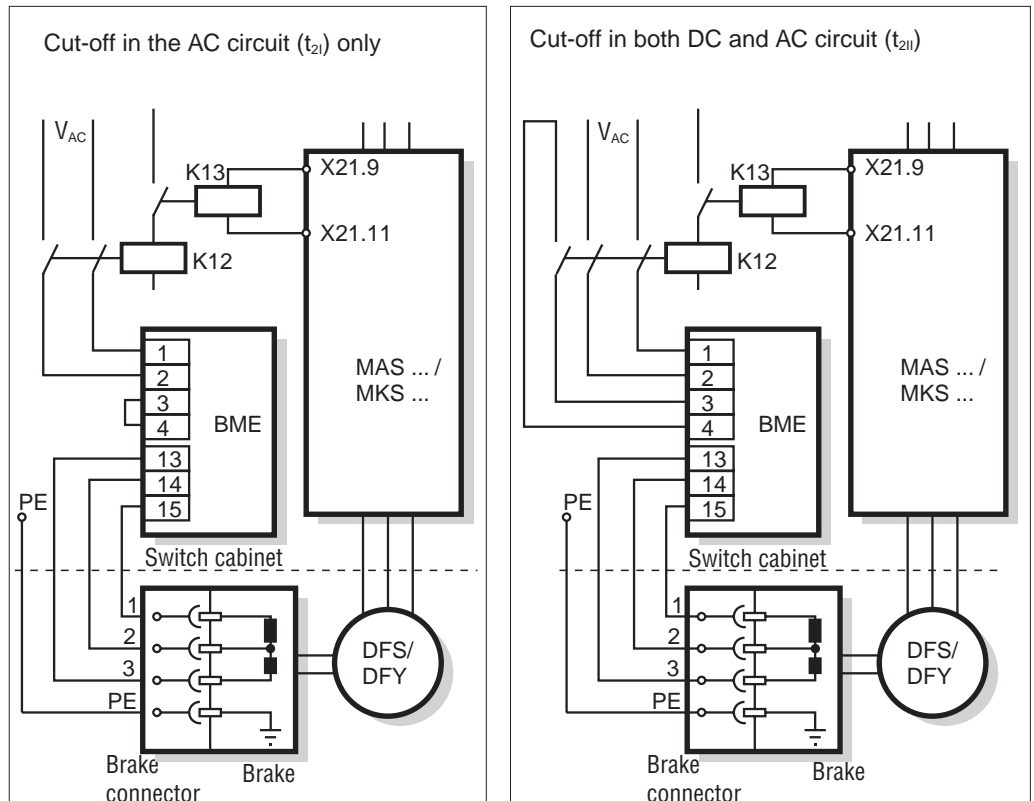

Figure 9: Brake control system

MD0032CE



5.4 Electronic Lines and Signal Generation

- The electronic terminals are suitable for line cross-sections up to 1.5 mm² (AWG16).
- **Unshielded lines** should only be used with twisted-pair wires for feed and return lines. Route them separately from power-carrying lines, auxiliary control lines or braking resistor lines.
- **OV lines** should **never be connected** for signal generation.
- **OV lines** inside an axis system are connected via the data bus (0V5, X5) and the 24 V bus (0V24, X2).
- **OV lines** of several axis systems should not be looped from system to system but, instead, **wired point-to-point**.
- Binary input instructions can be issued from machine control as a direct “0”↔“1” instruction. For this purpose, connect the reference potential of binary input X21/11 with the reference potential (0V) of the machine control.
- If coupling relays are necessary, use only those featuring enclosed, **dust-proof electronic contacts**.

The coupling relays must be able to switch small voltages and currents (5 - 20 V; 0.1 - 20 mA).

5.5 EMC-Compliant Installation

The MOVIDYN[®] units meet the requirements for maintaining the EMC directive 89/336/EC if the instructions for EMC-compliant installation are observed.

Interference Immunity

MOVIDYN[®] servo controllers meet all requirements of EN50082-2 with interference immunity.

Interference Emission

Higher interference levels are permissible in industrial areas. Dependent upon the condition of the supply system and the system configuration, some or several of the measures described below may be omitted.

Maintaining interference limits

SEW recommends the following measures in order to adhere to the limits of interference emission in residential, commercial, and industrial areas (Limit Class B in accordance with EN55011):

Input Filter

- For all MOVIDYN[®], use a suitable NF input filter on the input side and an HD00X output choke or shielded motor lead on the output side.
- Install NF input filters close to the MOVIDYN[®] outside of the minimum clearance area.
- Limit the line between input filter and MOVIDYN[®] to the absolute minimum length required; maximum permissible length is 400 mm (15.75 in). Unshielded twisted cables are sufficient. Also use only unshielded cables for the supply system lead.
- If several inverters are connected to an input filter, this input filter must be mounted directly at the cable entry of the switch cabinet or in the immediate proximity of the inverter. The selection of the input filter is determined by the total current of the inverter.
- Carry out HF-compliant earthing of the MOVIDYN[®] (flat metallic contact of the unit housings with earth, e.g., uncoated mounting plate of switch cabinet).

*Shielding*

- The control lines and motor leads must be shielded. If an HD00X output choke is used, the shielding is not mandatory.
- Routing all lines separately in individual, earthed metal ducts or metal pipes also qualifies as shielding.
- Earth the shield on both sides using the shortest distance and flat contacts.
- To avoid ground loops, one end of the shield can be earthed via a suppression capacitor. With double-shielded cable, earth the outer shield on the MOVIDYN[®] side and the inner shield at the other end.



EMV-Compliant Connection

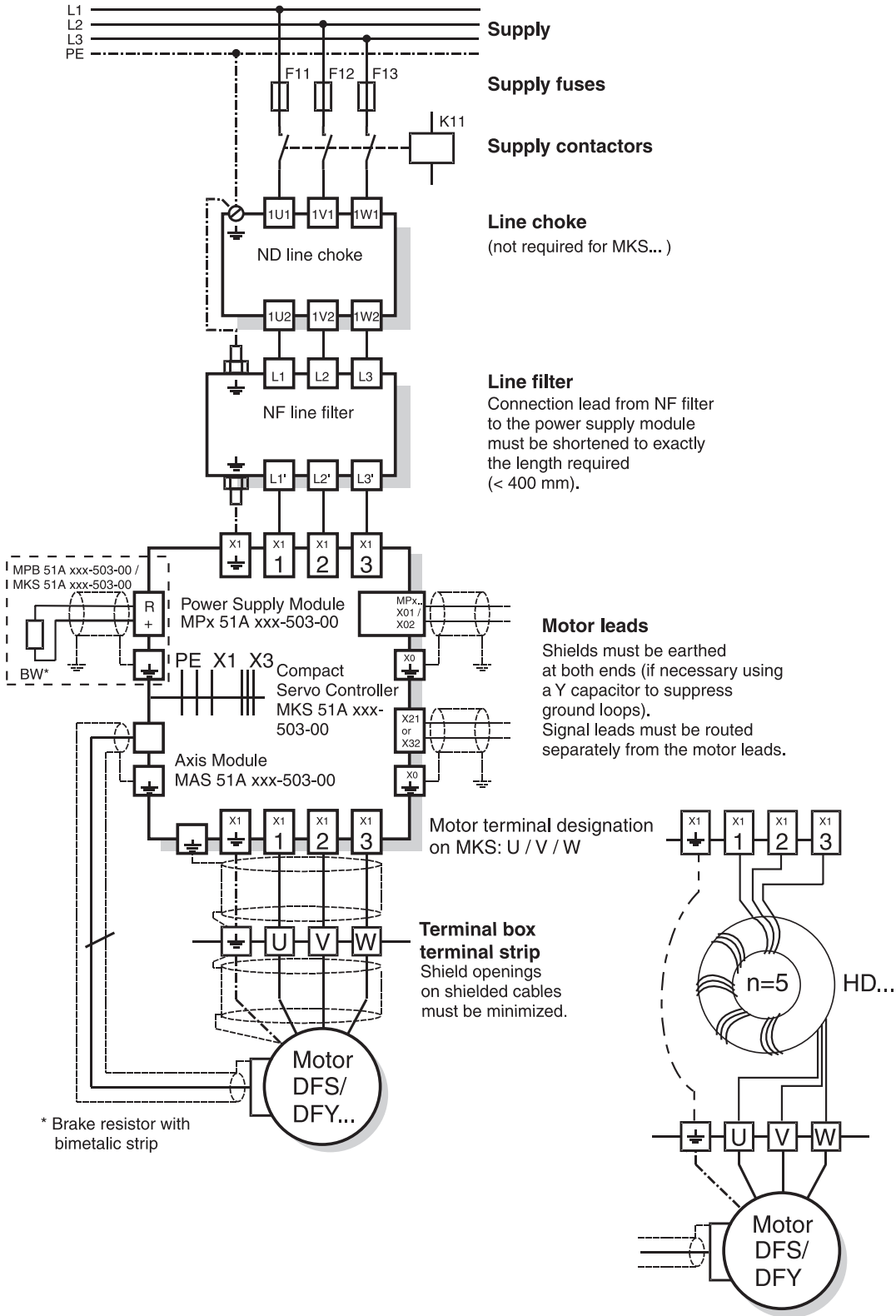

Figure 10: EMC-compliant installation in residential areas (in accordance with Limit Class B)

MD0033FE

On the output side, a regular cable with HD00X output choke can be used for the motor connection instead of the shielded cable.



HD00X Output Choke for Motor Lead

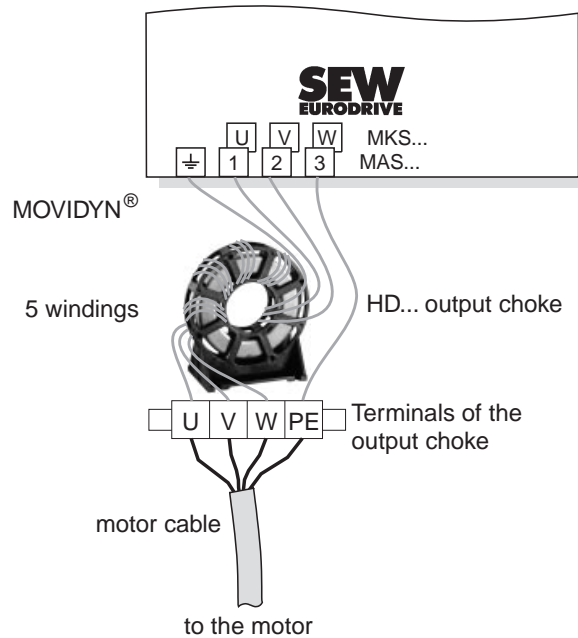

03859ADE

Figure 11: HD00X output choke

All three output phases must always be routed together through the toroid core. PE and the shield of shielded cables are not routed through the toroid core!

5.6 UL-Compliant Installation



The following information applies only in connection with UL-listed devices that are identified by the UL designation on the nameplate. Observe the following information for UL-compliant installation:

- Only use copper cables with the temperature range 60/75 °C as connection lead:
- The permissible tightening torques of the MOVIDYN® power terminals are:
MPB51A, MPR51A, MAS51A → 3.5 Nm (31 in.-lbs.)
MKS51A → 1.5 Nm (13.3 in.-lbs.)
- MOVIDYN® drive inverters are suitable for operation in voltage networks that can deliver a maximum current according to the following table and carry a maximum voltage of 500 V_{AC}. The rating for the fuses is not to exceed the values listed in the table:

**Maximum Values
for Installation in
Accordance with
UL/cUL**

MOVIDYN® type	Max. current	Max. supply voltage	Fuses
MPB51Axxx-503-xx MPR51Axxx-503-xx MAS51Axxx-503-xx MKS51A005-503-xx MKS51A010-503-xx	5000 A	500 V	-
MKS51A015-503-xx	10000 A	500 V	30 A / 600 V



5.7 Wiring Diagrams

MPB.../ MAS... Wiring Diagram

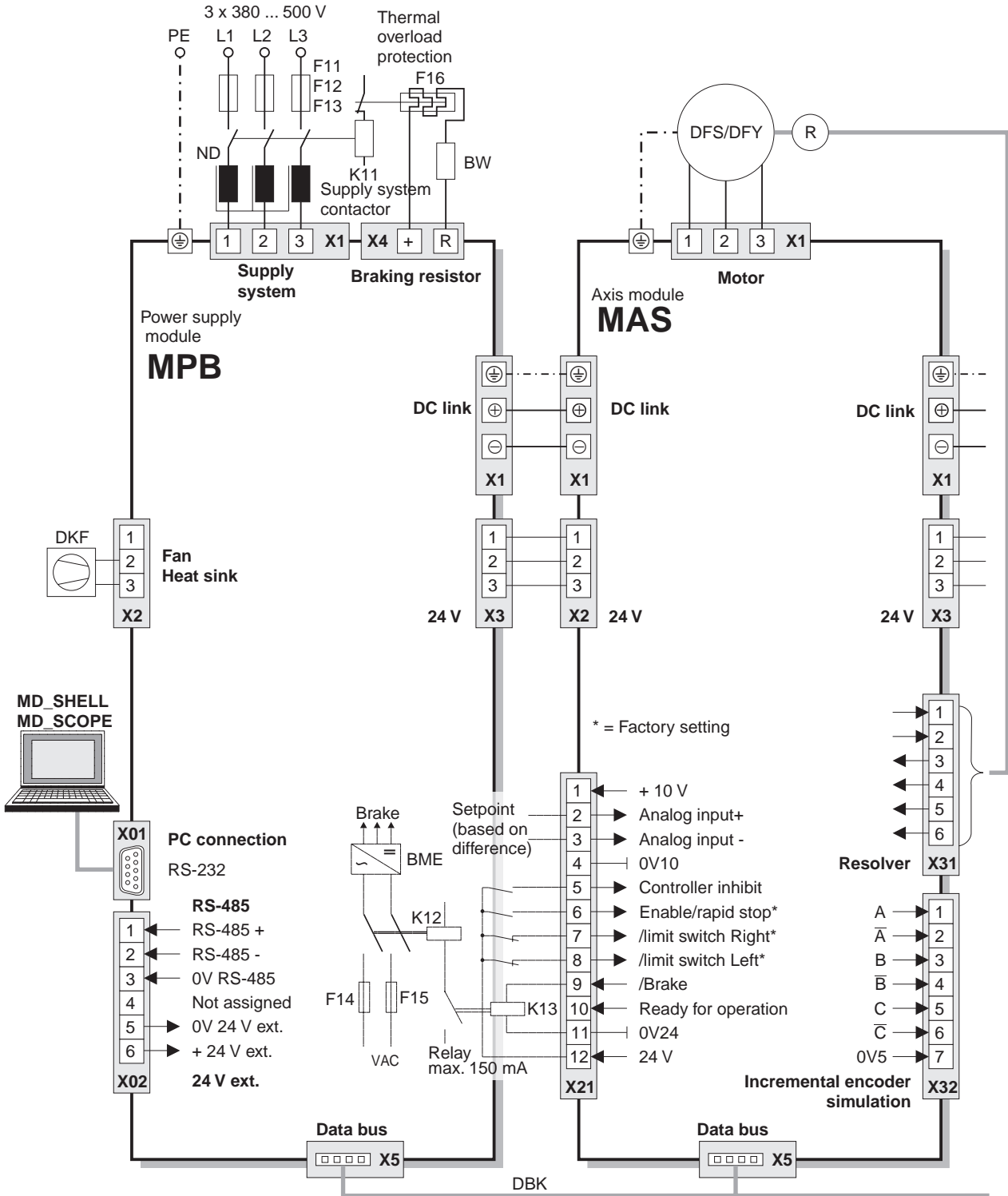

Figure 12: MPB/MAS wiring diagram

02991BEN



MPR.../MAS... Wiring Diagram

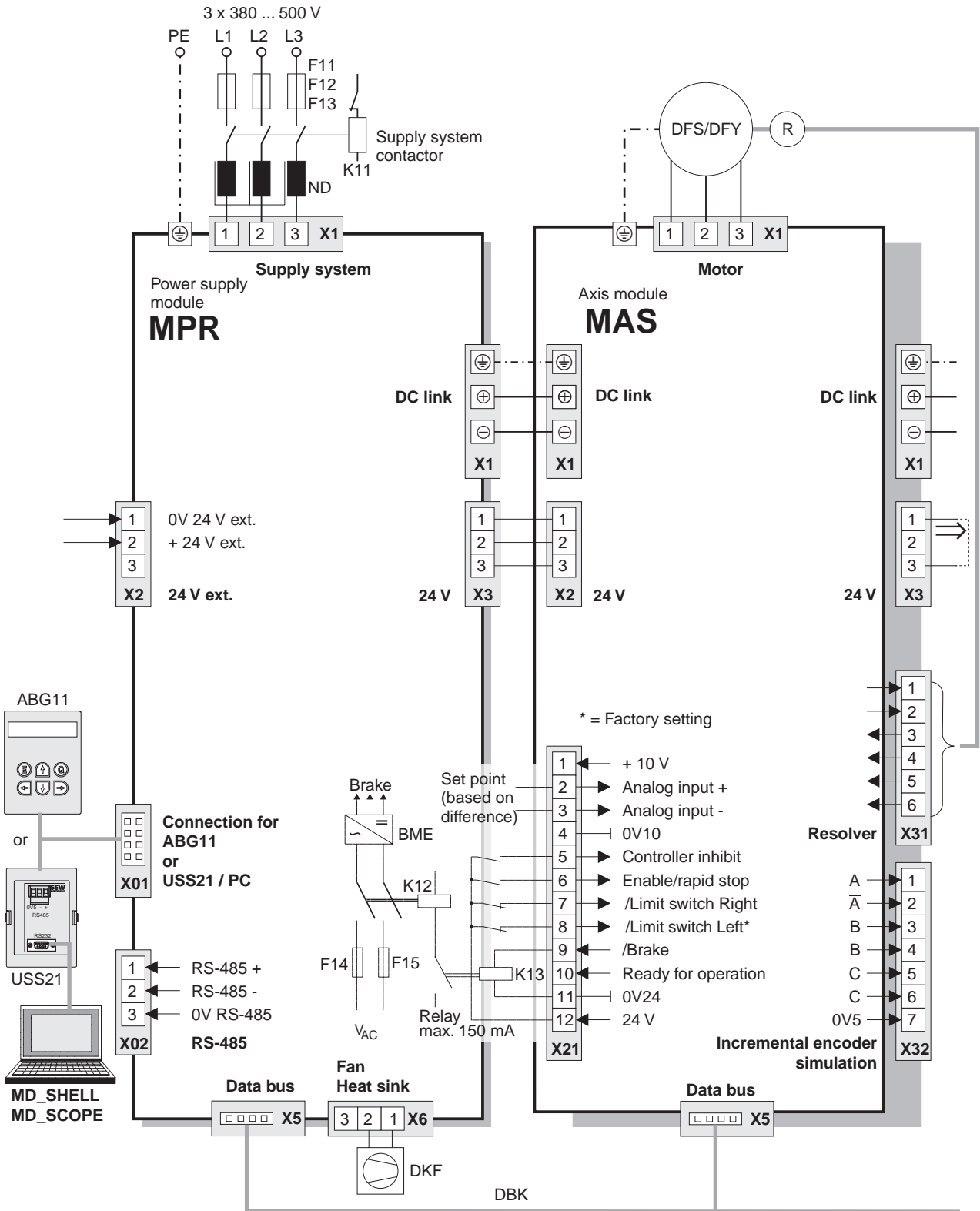

Figure 13: MPR/MAS wiring diagram

02992BEN

⇒ Bridge required on last axis module if no external 24 V is present.



MKS... Wiring Diagram

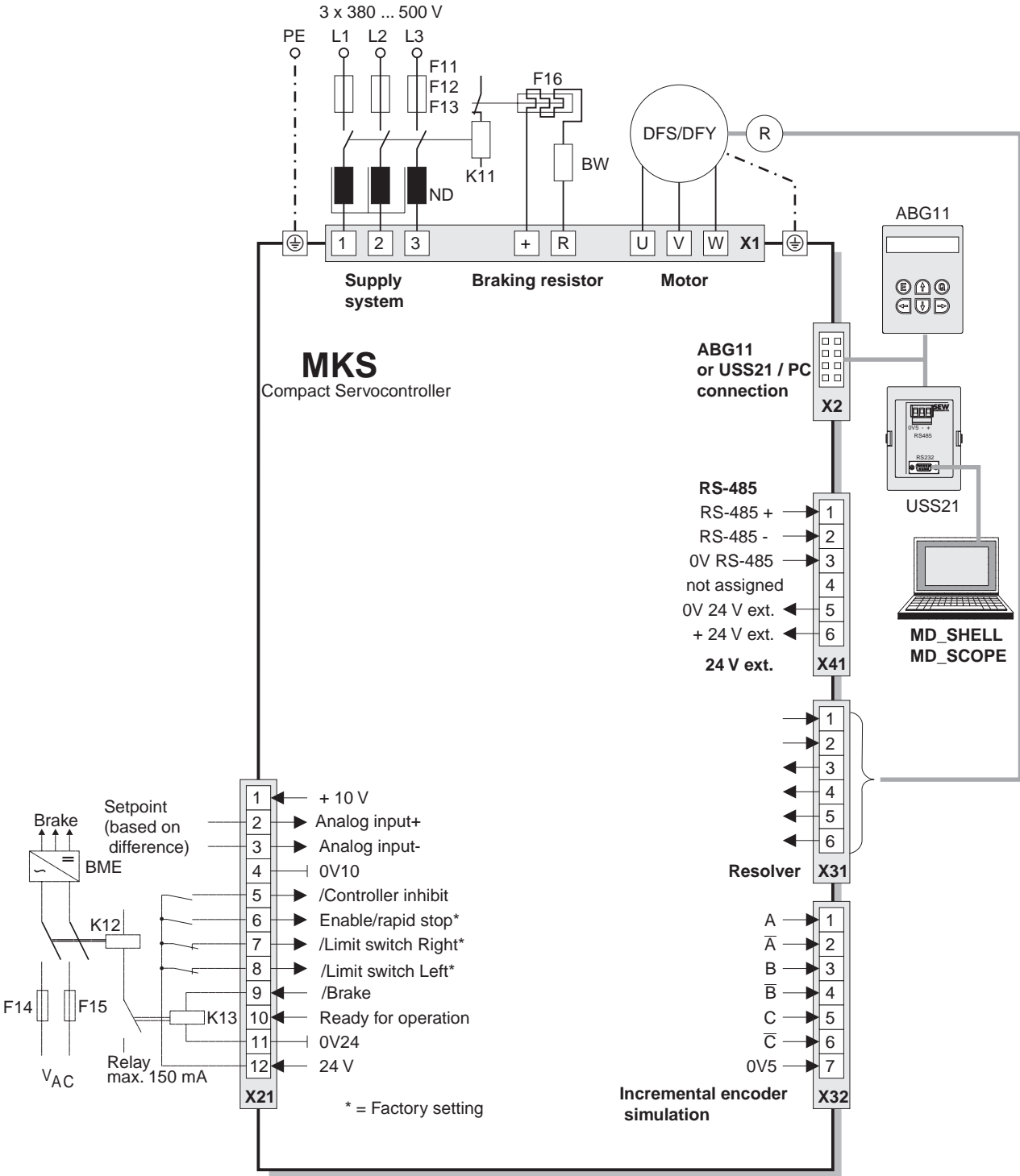

Figure 14: MKS wiring diagram

02993BEN



5.8 Description of Terminal Functions

Terminals on the MPB Power Supply Module 51A xxx-503-00

Function	Plug	Terminal	Data	
Shield earth	X0			
RS-232 serial interface PC connection 9-pole sub D connector	X01	2 3 4 5	TXD = transmit data line RXD = receive data line DTR = send/receive switchover 0V5 = RS-232 reference potential	Shielded cable, max. length 5 m (15 ft)
RS-485 serial interface alternative PC connection	X02	1 2 3	RS-485 + RS-485 - 0V5 = RS-485 reference potential	Shielded cable, max. length 200 m (650 ft)
Not assigned		4		
Connection of external 24 V supply		5 6	0V24 = external 24 V reference potential + 24 V (+ 18 V _{DC} ... + 30 V _{DC})	Power consumption: see <i>Electrical Installation</i>
Supply voltage connection	X1	1 2 3	$V_{in} = 3 \times 380 \dots 500 V_{AC} 10 \%$	
DC link potentials Axis module connection with bus bars		+V _Z -V _Z ⊕	$V_Z = 700 V_{DC} / V_{Zmax} = 900 V_{DC}$ PE (protective conductor)	
Internal voltage	X2	1	Connection not allowed, unit may be damaged	
Fan connection for DKF.. type heat sink		2 3	0V24 +24 V _{DC}	
Axis modules electronics voltage supply output (24 V bus)	X3		Supplied cable	
BW braking resistor connection	X4	+R	Select type according to technical data	Cable length: max. 100 m (325 ft)
Data bus connector (underside of unit)	X5		Data bus cable connection	

Terminals on the MPR Power Supply Module 51A xxx-503-00

Function	Plug	Terminal	Data	
Shield earth	X0			
RS-485 serial interface alternative PC connection	X02	1 2 3	RS-485+ RS-485- 0V5 = RS-485 reference potential	shielded cable, max. length 200 m (650 ft)
Supply voltage connection	X1	1 2 3	$V_{in} = 3 \times 380 \dots 500 V_{AC} 10 \%$	
DC link potentials Axis module connection with bus bars		+V _Z -V _Z ⊕	$V_Z = 700 V_{DC} / V_{Zmax} = 900 V_{DC}$ PE (protective conductor)	
Connection of external 24 V supply	X2	1 2 3	24 V (+18 V _{DC} ... + 30 V _{DC}) (see Ch. xx) (VDE 19240) 0V24 = 24 V reference potential not assigned	Power consumption: see <i>Electrical Installation</i>
Axis modules electronics voltage supply output (24 V bus)	X3		Supplied cable	
Data bus connector (underside of unit)	X5		DBK.. data bus cable connection	
Fan connection for DKF type heat sink	X6	1 2	+24 V _{DC} 0V24	
Internal voltage		3	Connection not allowed, unit may be damaged	



Terminals on the MAS Axis Module 51A xxx-503-xx

Function	Plug	Terminal	Data	
Shield earth	X0			
DC link potentials Connection with bus bars	X1	+V _Z -V _Z ⊕	V _Z = 700 V _{DC} / V _{Zmax} = 900 V _{DC} PE (protective conductor)	
Connection of DFS/DFY permanent-field synchronous motor		1 2 3 ⊕	V _{max} = V _{in} PE (protective conductor)	Max. length 100 m (325 ft)
Electronics voltage supply input (24 V bus)	X2		Supplied cable	
10 V voltage supply, e.g., for setpoints	X21	1 4	+10 V _{DC} , max. 3 mA 0 V 10 = reference potential 10 V _{DC}	
Analog differential input		2 3	V _{A1} setpoint 1: -10 V _{DC} ... + 10 V _{DC} R _i ≥ 20 kΩ	
Binary inputs			Selection of 10 functions: Enable / ramp generator switchover / controller inhibit / hold control / external fault / reset / external trigger / limit switch CCW / limit switch CW / no function (with IPOS also: reference travel / ref. cam)	
Fixed		5	/Controller inhibit	"1" : +13 V _{DC} .. + 30.2 V _{DC} typically + 24 V (6 mA) "0" : -3 V _{DC} .. +5 V _{DC} (DIN 19240)
User-programmable	6	Enable ¹⁾		
User-programmable	7	/Limit switch CW ¹⁾		
User-programmable	8	/Limit switch CCW ¹⁾		
Binary Outputs			Selection of 9 functions: lxt warning / ready for operation / failure / brake / speed reference / current reference / setpoint actual value comparison / motor standstill / no function (with IPOS also: in position / pos. output 1 ... 8 / IPOS reference)	
Fixed		9	Relay driver for brake relay "1": + 24 V _{DC} ; max.150 mA	
User-programmable		10	Ready for operation ¹⁾ "1": + 24 V _{DC} ; max. 50 mA	
Voltage output 24 V, e.g., for binary inputs		11 12	0V24 = 24 V _{DC} reference potential + 24 V _{DC} max. 200 mA	
Electronics voltage supply output (24 V bus)	X3		Supplied cable	
Motor resolver connection	X31	1, 2 3, 4 5, 6	Resolver signals	Twisted pair, shielded, max. length 100 m (325 ft)
Output incremental encoder simulation	X32	1, 2 3, 4 5, 6 7	A, /A B, /B C, /C 0V5 = incremental encoder simulation reference potential	RS-422 level, 1024 pulses/revolution
Data bus connector (underside of unit)	X5		DBK.. data bus cable	

1) Factory Setting



Terminals on the MKS Compact Servo Controller 51A xxx-503-xx

Function	Plug	Terminal	Data	
Power connection	X1	L1 L2 L3	Supply system: $V_{in} = 3 \times 380 \dots 500 V_{AC} 10 \%$	
		+ R	Braking resistor	
Connection of DFS/DFY permanent-field synchronous motor		U V W	$V_{max} = V_{in}$	Max. length 100 m (325 ft)
Connection for hand-held terminal or serial interface	X2			
10 V voltage supply, e.g., for setpoints	X21	1 4	+10 V_{DC} , max. 3 mA 0V10 = 10 V_{DC} reference potential	
Analog differential input		2 3	V_{A1} setpoint 1: -10 $V_{DC} \dots +10 V_{DC}$	$R_i \geq 20 k\Omega$
Binary inputs			Selection of 10 functions: Enable / ramp generator switchover / controller inhibit / hold control / external fault / reset / external trigger / limit switch CCW / limit switch CW / no function (with IPOS also: reference travel / ref. cam)	
Fixed		5	/Controller inhibit	"1": +13 $V_{DC} \dots +30.2 V_{DC}$ Typically: +24 V_{DC} (6mA) "0": -3 $V_{DC} \dots +5 V_{DC}$ (DIN 19240)
User-programmable		6	Enable ¹⁾	
User-programmable		7	/Limit switch CW ¹⁾	
User-programmable		8	/Limit switch CCW ¹⁾	
Binary Outputs				Selection of 9 functions: lxt warning / ready for operation / failure / brake / speed reference / current reference / setpoint actual value comparison / motor standstill / no function (with IPOS also: in position / pos. output 1 ... 8 / IPOS reference)
Fixed	9	Relay driver for brake relay "1": +24 V_{DC} ; max. 150 mA		
User-programmable	10	Ready for operation ¹⁾ "1": +24 V_{DC} ; max. 50 mA		
24 V voltage output, e.g., for binary inputs		11 12	0V24 = 24 V_{DC} reference potential +24 V_{DC}	max. 200 mA
Motor resolver connection	X31	1, 2 3, 4 5, 6	Resolver signals	Twisted pair Shielded cable Max. length 100 m (325 ft)
Output incremental encoder simulation	X32	1, 2 3, 4 5, 6 7	A, /A B, /B C, /C 0V5 = incremental encoder simulation reference potential	RS-422 level, 1024 pulses/revolution
RS-485 serial interface	X41	1 2 3	RS-485+ RS-485- 0 V reference potential	
Connection of external 24 V supply		4 5 6	Not assigned 0 V reference potential +24 V_{DC} (18... 30 V_{DC})	Power consumption: see <i>Electrical Installation</i>

1) Factory setting



5.9 RS-485 Interface Connection

Using the RS-485 interface, a maximum of 32 MOVIDYN[®] units, for example, for master-slave operation, or a maximum of 31 MOVIDYN[®] units and a higher-level control system (PLC) can be connected with each other.

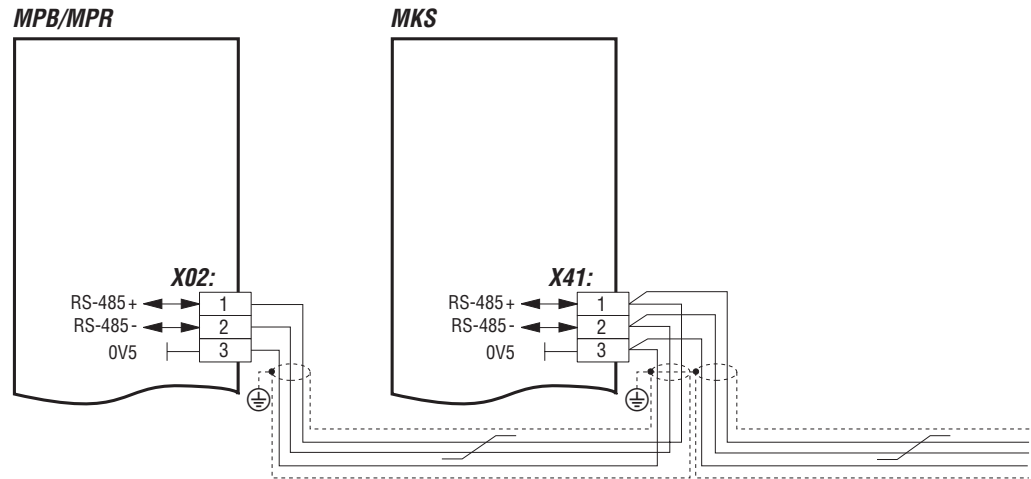

02241AXX

Figure 15: RS-485 cabling

Important

- Use a 4-core and shielded cable, twist the two signal cables, and place the shield flat on both sides of the electronic shield clamp of MOVIDYN[®] or earth it at the higher-level control system.
- Route the 0V5 reference potential through the second cable pair. Potential shift may occur between the units connected by RS-485.
- The maximum total line length is 200 m (660 ft).
- Dynamic terminating resistors are permanently built in. Do not connect **any external terminating resistors!**



6 Startup

Observe the *Safety Notes!*

6.1 Initial Settings

Perform the following to be able to program the units and set parameters:

- Connect the power supply module or compact servo controller and PC with the interface cable (compact servo controller via USS21A option).



Important: Power supply module/compact servo controller and PC must be disconnected.

- Ensure that the cabling complies with the wiring diagram!
- Set the axis address at the axis modules or the compact servo controllers. Each axis module must have a unique address.
- Install and start the MD_SHELL PC user interface (→ *Configuring MD_SHELL User Interface*).



Setting the Axis Address

On delivery and after calling up the factory setting (→ P610, *Set parameters*), the units feature the address “00.” For multi-axis operation, SEW does not recommend using the axis address “00.” After calling up the factory setting, avoid using axis modules with identical addresses.

The S1 button is used to set the address to address 0 ... 59:

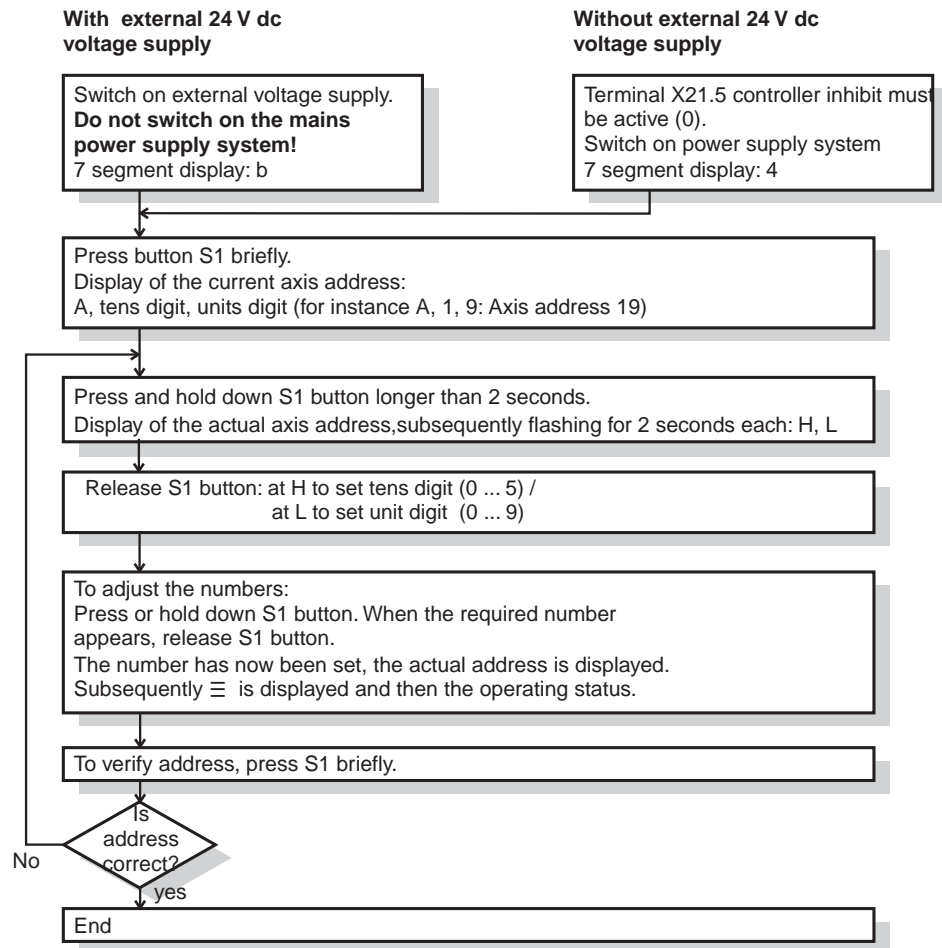

Figure 16: Setting or changing the address

02153AEN

Configuring the MD_SHELL User Interface

- Install and start MD_SHELL.
- Select the [Interface] menu.
 - Under the “PC Interface” menu item, select the serial interface on which the axis system is connected to the PC (COM1, COM2).
 - Under the “Inverter Interface” menu item, select the serial interface that is used for communication on the axis system.
 - RS-232 via USS, RS-485
 - RS-232 via MP/MPB
 - RS-232 via AIO
- Under the “Inverter Address” menu item, set the address that is used by the PC.



Limit Switch



Important:

On delivery, the terminals X21.7 and X21.8 are programmed as limit switch inputs. If you do not connect any limit switches, you must change the programming of the terminals in MD_SHELL or bridge both terminals to X21.12 (+ 24 V); otherwise, fault 27 occurs (→ *List of Fault Messages*).

Setting the Controller

MD_SHELL allows for a rapid startup. For this purpose, MD_SHELL calculates an initial setting of the speed controller using system-specific data (→ MD_SHELL).

- In the [Parameter] menu, select the “Startup” menu item.
- Enter the required data completely:

Menu item	Comment
“Motor Type”	Enter the motor type (nameplate).
“Rated Motor Voltage”	Enter the correct rated voltage of the motor (nameplate).
“Rated Speed”	Enter the correct rated speed of the motor (nameplate).
“Brake”	This entry is used for correct determination of the motor moment of inertia (nameplate).
“Speed Control Loop Damping” 	The damping is a measure for the transient response of the speed control loop. The standard setting is 1.0 (aperiodic transient condition); range of values: 0.5...2.0. Small values lead to higher overshooting (the inherent instability increases), larger values to a creeping shape (the inherent instability decreases).
“Speed Control Loop Stiffness” 	The stiffness is a measure for the velocity of the speed control loop. The standard setting is 1.0; range of values is 0.5...2.0. Increasing the stiffness leads to an increase in the control speed; the control system starts oscillating at a critical value. Reducing the stiffness leads to a slowdown of the control, and the lag fault increases. Recommendation: Increase the stiffness in small steps (e.g., 0.05) (practical range of values: 0.8 – 1.2)!
“Positioning Control Time Interval”	Corresponds to the cycle time of a higher level positioning control and, therefore, to the resulting time-discrete setpoint changes.
“Drive”	Only enter “Backlash-Free” if the drive is truly backlash-free; otherwise, it may result in uneven running.
“Moment of Inertia at Motor Shaft”	Enter the resulting load moment of inertia referenced to the motor shaft using the listed unit. If the value is not known, you must enter an estimated value; a more exact value may be determined later using MD_SCOPE.
“Shortest Required Ramp Time”	The ramp generators are set to the listed value if the acceleration capacity of the drive allows for this option. It is practical to enter the next shortest time than the one preset by the higher-level positioning control.
“Rated Current”	Indicates the rated current.



- Pressing [F5] opens the parameter list. Pressing [F2] performs a calculation of all required parameters and the setting of limits (Setting parameters). The drive can be started up using the displayed initial setting of the speed controller.
- Transfer the calculated values to the inverter by pressing [F3].

In general, the initial setting delivers satisfactory results.

However, the following aids are available if further optimization is required:

There are two options available to optimize the initial setting of the controller parameters and to visualize the process data:

- You are using the MD_SCOPE program. It is used to display the time characteristic of setpoints, actual values, etc. on the PC monitor, save and print them, as well as change controller parameters.
- Without the MD_SCOPE utility program, the AIO11 option pcb and an oscilloscope can be used to optimize the controller parameters. For this purpose, you must program the analog outputs on the AIO11 option pcb accordingly (→ Param. 340).

*Checking and
optimizing
controller
setting, visualizing
process data*

**Programming the
Terminals**

If any other than the factory terminal assignment is to be used, you must reprogram the terminals (→ MD_SHELL; → Param. 300).



6.2 List of Parameters

*) The marked parameters can automatically be determined and transferred by executing the MD_SHELL startup function.

A forward slash "/" in front of the assignment designates a "0" active function.

Param. No.	Designation	Adjustment range min. ... increment ... max.	Factory setting
0__	Display values		
000...084	Process values for monitoring during operation		
1__	Setpoints/ramp generators		
10_	Operating mode		
100	Operating mode	SPEED CONTROL · TORQUE CONTROL (with IPOS also: POSITIONING)	SPEED CONTROL
101	Factor for analog setpoints	0.10 ... 0.01 ... 10.00	1.00
102	Offset for analog value 1 [mV]	-500 ... 1 ... 500	0
103	Operating mode of analog input 2	EXT. I-LIMIT · NO FUNCTION · RESERVED	EXT. I-LIMIT
11_	Setpoint source		
110	Setpoint source	ANALOG INPUT · OPT. API-APA · PC INTERFACE · FIELDBUS	ANALOG INPUT
111	PC setpoint speed [1/min]	-5000.00 ... 0.20 ... +5000.00	0.00
12_	Ramp generator 1		
120	Ramp 1 up CW [s]*	0.00 ... 0.02 ... 0.50 0.50 ... 0.10 ... 3.00 3.00 ... 0.50 ... 10.00 10.00 ... 2 ... 30	1.00
121	Ramp 1 down CW [s]*		
122	Ramp 1 up CCW [s]*		
123	Ramp 1 down CCW [s]*		
13_	Ramp generator 2		
130	Ramp 2 up CW [s]*	0.00 ... 0.02 ... 0.50 0.50 ... 0.10 ... 3.00 3.00 ... 0.50 ... 10.00 10.00 ... 2 ... 30	1.00
131	Ramp 2 down CW [s]*		
132	Ramp 2 up CCW [s]*		
133	Ramp 2 down CCW [s]*		
14_	Rapid stop ramp		
140	Rapid stop ramp [s]	0.00 ... 0.02 ... 0.50 0.50 ... 0.10 ... 3.00 3.00 ... 0.50 ... 10.00 10.00 ... 2 ... 30	1.00
15_	Emergency stop ramp		
150	Emergency stop ramp [s]	0.00 ... 0.02 ... 0.50 0.50 ... 0.10 ... 3.00 3.00 ... 0.50 ... 10.00	0.10
2__	Controller parameter		
20_	Speed controller		
200	Gain n-controller*	0.10 ... 0.01 ... 32.00	2.00
201	Time constant n-controller [ms]*	0 ... 0.50 ... 0.50 0.50 ... 0.10 ... 50.00 50.00 ... 1 ... 300	10.00
202	D component n-controller*	0.00 ... 0.10 ... 32.00	0.00
203	Feedforward threshold [1/min/ms]*	0 ... 0.2 ... 3000	3000
204	Gain accel. feedforward*	0.00 ... 0.01 ... 1.00 1.00 ... 0.02 ... 80.00	0.00
205	Filter accel. feedforward [ms]*	0 ... 1 ... 1	0
206	Filter speed setpoint [ms]*	1 ... 0.10 ... 100.00	

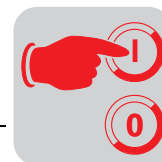

Param. No.	Designation	Adjustment range min. ... increment ... max.	Factory setting
207	Filter speed actual value [ms]*	0 ... 1 ... 1 1 ... 0.10 ... 32.00	0
208	7-segment test display	OFF · ON	OFF
209	Controller test function	OFF · ON	OFF
21_	Limitings		
210	Max. speed CW [1/min]*	0 ... 1 ... 5000	3000
211	Max. speed CCW [1/min]*		
212	Maximum current [%I _N]*	5 ... 1 ... 150	100
22_	Hold controller		
220	Gain of hold controller*	0.10 ... 0.10 ... 32.00	0.50
3_	Terminal assignment		
30_	Binary inputs of basic unit		
300	Terminal X21.6	ENABLE · RAMP GEN. SWITCH MODE · / CONTROLLER INHIBIT · HOLD CONTROL · / EXT. FAULT · RESET · EXT. TRIGGER · /LIMIT SWITCH CW · /LIMIT SWITCH CCW · NO FUNCTION (with IPOS also: REF. CAM · REFERENCE TRAVEL)	ENABLE
301	Terminal X21.7		/LIMIT SWITCH CW
302	Terminal X21.8		/LIMIT SWITCH CCW
31_	Binary inputs AIO		
310	Terminal X13.2	same as P300	RESET
311	Terminal X13.3		INTEG. SWITCH MODE
312	Terminal X13.4		NO FUNCTION
313	Terminal X13.5		NO FUNCTION
314	Terminal X13.6		NO FUNCTION
315	Terminal X13.7		NO FUNCTION
316	Terminal X13.8		EXT. TRIGGER
32_	Binary outputs of basic unit		
320	Terminal X21.10	IxT WARNING · READY FOR OPERATION · / FAILURE · /BRAKE · SPEED REFERENCE · CURRENT REFERENCE · SETPOINT ACTUAL VALUE COMP. · MOTOR STANDSTILL · NO FUNCTION (with IPOS also: IN POSITION · POS. OUTPUT 1 ... 8 · IPOS REFERENCE)	READY FOR OPERATION
33_	Binary outputs AIO		
330	Terminal X12.1	same as P320	/FAILURE
331	Terminal X12.2		IxT WARNING
332	Terminal X12.3		IxT WARNING
333	Terminal X12.4		IxT WARNING
334	Terminal X12.5		IxT WARNING
335	Terminal X12.6		IxT WARNING
34_	Analog outputs AIO		
340	Analog output 1 (X14.6)	CURRENT SETPOINT · SPEED ACTUAL VALUE · INTEGR. SETPOINT · INTEGR. ACTUAL VALUE · IxT CAPACITY UTILIZATION	CURRENT SETPOINT
341	Assessment factor 1	-5.00 ... 0.10 ... 5.00	1.00
342	Analog output 2 (X14.7)	same as P340	SPEED ACTUAL VALUE
343	Assessment factor 2	-5.00 ... 0.10 ... 5.00	1.00
4_	Reference messages		
40_	Speed reference value		
400	Reference speed [1/min]	0 ... 1 ... 5000	1500
401	Hysteresis 1 [+/- 1/min]	0 ... 1 ... 500	100



Param. No.	Designation	Adjustment range min. ... increment ... max.	Factory setting
402	Deceleration [s]	0.00 ... 0.10 ... 9.00	1.00
403	Message = "1" at:	n < n ref · n > n ref	n < n ref
41_	Current reference value		
410	Reference current I _{ref} [%I _N]	0 ... 1 ... 150	100
411	Hysteresis 2 [+/- %]	0.00 ... 1.00 ... 10	2.00
412	Deceleration [s]	0.00 ... 0.10 ... 9.00	1.00
413	Message = "1" at:	I < I ref · I > I ref	I < I ref
42_	Setpoint actual value comparison		
420	Deceleration [s]	0.00 ... 0.10 ... 9.00	1.00
421	Message = "1" at:	n <> n setpoint · n = n setpoint	n <> n setpoint
43_	Ixt reference value		
430	Ixt reference value [%I _n]	0 ... 1 ... 100	100
5_	Control functions		
50_	Brake function		
500	Brake function	NO · YES	NO
501	Brake reaction time [ms]	0 ... 1 ... 1000	200
51_	Speed monitoring		
510	Speed monitoring	NO · YES	YES
511	Control time n-monitoring [s]	0.00 ... 0.10 ... 10.00	1.00
6_	Special functions		
60_	Ready for operation message		
600	Message delay [s]	0 ... 1 ... 9	1
61_	Factory setting		
610	Factory setting	NO · YES	NO
62_	Fault reaction		
620	Fault reaction	INSTANT DISCONNECT · EMERGENCY STOP RAMP	INSTANT DISCONNECT
63_	Reset behavior		
630	Auto reset	NO · YES	NO
631	Restart time [s]	3 ... 1 ... 30	3.0
632	Manual reset	NO · YES	NO
633	Reaction to MP reset	NONE · RESET	NONE
634	RESET button of axis module	ENABLED · INHIBITED	ENABLED
64_	Parameter lock		
640	Parameter lock	NO · YES	NO
65_	Save EEPROM		
650	Save EEPROM	OFF · ON	ON
66_	MOVIDYN response time		
660	Response time [ms]	0 ... 5 ... 200	0.0
7_	Control functions		
78_	Fieldbus PD description		
780	PO1 Setpoint description	NO FUNCTION · SPEED · CURRENT · POSITION LOW · POSITION HIGH · MAX. SPEED · MAX. CURRENT · SLIP · RAMP · CONTROL WORD 1 · CONTROL WORD 2 · SPEED [%]	CONTROL WORD 1



Param. No.	Designation	Adjustment range min. ... increment ... max.	Factory setting
781	PI1 Actual value description	NO FUNCTION · SPEED · APPARENT CURRENT · ACTIVE CURRENT · POSITION LOW · POSITION HIGH · STATUS WORD 1 · STATUS WORD 2 · SPEED [%]	STATUS WORD 1
782	PO2 Setpoint Description	same as P780	SPEED
783	PI2 Actual value description	same as P781	SPEED
784	PO3 Setpoint description	same as P780	NO FUNCTION
785	PI3 Actual value description	same as P781	NO FUNCTION
79_	Fieldbus parameter		
790	Enable fieldbus setpoints	YES · NO	YES
791	Fieldbus timeout [s]	0.01 ... 0.01 ... 1.00 1 ... 1 ... 650	0.50
792	Timeout response	RAPID STOP · EMERGENCY STOP · INSTANT DISCONNECT · RAPID STOP/FAILURE · EMERGENCY STOP/FAILURE · INSTANT DISCONNECT/FAILURE · STANDARD MODE · NO RESPONSE	RAPID STOP
793	CAN synchronization ID	0 ... 1 ... 2047	1
794	DeviceNet PD configuration	1 PD + PARAM · 1 PD · 2 PD + PARAM · 2 PD · 3 PD + PARAM · 3 PD	3 PD + PARAM



7 Operation and Service

7.1 Status LEDs

Power Supply Module (LEDs)

LED		Meaning
ON (green)	ON	Ready for operation, no fault and DC link voltage and internal 24 V electronic voltage supply within permissible limits
	OFF	Not ready for operation
24 V (green)	ON	24 V electronic voltage supply (internal or external) ensured
	OFF	No 24 V supply
TRIP (red)	ON	Failure (fault is displayed at the axis modules and in MD_SHELL)
	OFF	No failure

Axis Module / Compact Servo Controller (7-Segment Display)

Status	Display	Meaning
Operating state	1	Speed control, enabled
	2	Torque control, enabled
	3	Rapid stop is carried out
	4	Controller inhibit is active (output stage is inhibited)
	5	Approached limit switch CW
	6	Approached limit switch CCW
	7	Option card API/APA 11 positioning control in operation
	8	Executing factory setting (only displayed with operational axis module)
	9	Hold control is active
	b	Not ready for operation
IPOS	A	IPOS in operation
	c	IPOS performs reference travel
Fault	F	A fault is indicated by a flashing "F" and the two digits of the fault code. The display remains until the fault is reset (P63. and <i>List of Fault Messages</i>)

7.2 Reset Options

- Power supply module
 - Switch power supply on/off
 - A reset at any of the axis modules also resets the power supply module. **Observe P633!**
- Axis module / Compact servo controller
 - Switch power supply on/off and, if present, also switch external 24 V voltage supply on/off
 - Reset command via binary input terminal (→ P30.)
 - Auto reset (→ P630)
 - Reset via serial interface (→ P632)
 - Pressing S1 (→ P634)



7.3 List of Fault Messages

Important

All fault messages can be reset with a reset command.

Faults recognized in the power supply module (F03, F06, F07, F15) are displayed by all attached axis modules!

Other fault numbers may occur during the operation with options (→ corresponding documentation).

With a fault reset, the incremental encoder simulation is also reset. A review of the position encoder information is necessary.

Fault Reaction

The “Reaction” column contains the reaction of the drive to the respective fault:

S = Instant disconnect, i.e., the output stage is inhibited (controller inhibit), and the brake is applied.

N = Emergency stop ramp (→ P150)

P = Programmable



Caution:

Motors **without a mechanical brake** can continue moving uncontrolled (e.g., coast to stop) because of load conditions!

Display		Fault	Reaction	
Unit	MD_SHELL	Cause	Solution	
F01	MAS... / MKS... overcurrent	Overcurrent in output stage due to: <ul style="list-style-type: none"> Short circuit in the motor/cable Ground fault Defective output stage 	Repair the short circuit. If the fault cannot be reset afterward, exchange the unit.	S
F03	MPx... overtemperature	Thermal overload of the power supply module	Reduce the power output and/or ensure sufficient cooling.	N
F05	Message bus connection	Data bus cable is not properly connected to X5	Check the connections.	S
F06	Earth fault	Earth fault in: <ul style="list-style-type: none"> Power supply module Axis module(s) Motor(s) 	Check motor leads or motor for earth fault.	S
F07	DC link	Generating power too high, overvoltage in the DC link	<ul style="list-style-type: none"> Check leads to the braking resistor Check technical data of the braking resistor Extend deceleration ramps, if necessary 	S
F08	Speed monitoring	Speed control operates through the adjusting limit <ul style="list-style-type: none"> Overload Phase fault in the power supply or motor Incorrect connection of resolver 	<ul style="list-style-type: none"> Extend ramps, increase P511, if necessary Check power limitation Check motor Check motor lead Check power supply phases Check cabling of resolver 	S
F09	S1 AI011 current	S1 slide switch on AIO11 is set incorrectly	Move S1 slide switch on AIO11 to “U” position.	S
F11	MAS... / MKS... overtemperature	Thermal overload of axis module / compact servo controller	Reduce the power output and/or ensure sufficient cooling.	N
F14	Resolver fault	<ul style="list-style-type: none"> Resolver cable or shield is not connected correctly Short circuit or cable break in resolver cable Resolver defective 	Check resolver cable and shield for correct connection, short circuit, and cable break	S
F15	Internal 24 V MPx... / MKS...	Internal supply voltage in the power supply module / compact servo controller is missing	Exchange the unit	S
F17... 24	Displays detailed fault indicators	System faults	Reset (→ Reset options) If the fault cannot be reset, please consult SEW. Indicate fault number and MD_SHELL fault message	S



Display		Fault		Reaction
Unit	MD_SHELL	Cause	Solution	
F25	EEPROM	Error while accessing EEPROM	Call up the factory setting (→ Observe P610!) and reset the fault. Perform a new startup. If the fault occurs again: Exchange the unit 	S
F26	External terminal	External fault signal was read in via programmable input	Remove the respective fault source, reprogram the terminal, if necessary	P
F27	ES cable missing	Cable break or both limit switches missing	Check cabling and limit switches, reprogram terminals, if necessary	N
F28	Fieldbus timeout	Fault during process data transfer	Check fieldbus connection, see the corresponding manual	P
F29	Limit switch reversed	Limit switches are reversed with respect to rotational direction of motor	Reverse connections of limit switches at X21.7 and X21.8.	N
F31	Short circuit output	Short circuit or overload of one or several binary outputs	Check cabling and wiring, limit current to 50 mA, if necessary	S
F32	Setpoint source n.a.	Setpoint source not defined	Set correct setpoint source with P110	S
F34	Fieldbus timeout	Fault during communication data transfer	Check fieldbus connection, see the corresponding manual	P
F36	Required hardware missing	Attempted to use a non-existing option card	<ul style="list-style-type: none"> • Insert correct option card or • Select correct setpoint source with P110 	S
F39, 41, 42, 58, 72, 76-78		Fault of IPOS positioning control	See IPOS manual	N
F40-42, 50-74		Fault of APA/API positioning control	See APA/API manual	N
F43	PC control time	Monitoring for communication of PC / axis system active, monitoring time exceeded	[Parameter] menu, "Panel" menu item: Increase the value for "PC time monitoring" or deactivate time monitoring by entering "0."	S
F87	Fieldbus timeout	Communications fault during fieldbus operation	Check fieldbus connection, see the corresponding manual	P
	Displays undefined messages	System fault	Reset (→ Reset options) Exchange the unit if this reoccurs.	S



7.4 SEW Electronics Service

If a fault cannot be solved, please consult the SEW Electronics Service (→ Addresses in “Customer and Spare Parts Service”).

Upon consulting the SEW Electronics Service, please indicate the digits of the service code which will help the service personnel to assist you more efficiently.



00276AEN

Figure 17: Service label

- If you send in the unit for testing or repair services, please provide the following information:
- Type of fault
 - Accompanying circumstances
 - Your own thoughts about the cause of the fault
 - preceding unusual circumstances, etc.

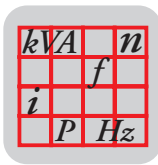

8 Technical data

8.1 General Technical Data

The following table lists the technical data that applies to all MOVIDYN[®] servo controllers, independent of type, design, and power.

MOVIDYN [®]	All types
Interference immunity	meets EN 61800-3
Interference emission with EMC-compliant installation	meets EN 61800-3 according to limit B pursuant to EN 55011 and EN 55014
Ambient temperature ϑ_{amb}	0 °C ... 45 °C without output reduction 45 °C ... max. 60 °C output reduction 3 % per K
Climatic category	EN 60721-3-3, class 3K3
Storage temperature ¹⁾ ϑ_{st}	-25 °C ... + 70 °C (EN 60721-3-3, class 3K3) ABG diagnostics and memory module: - 20 °C ... +60 °C
Enclosure	IP20 (EN 60529)
Operating mode	DB (continuous duty) (EN 60149-1-1 and -1-3)
Installation altitude	$h \leq 1,000$ m (3,300 ft) I_N reduction: 1 % per 100 m (330 ft) from 1,000 m (3,300 ft) up to 2,000 m (6,600 ft)

1) During long-term storage, connect the unit to supply voltage every two years for at least 5 minutes since the unit's useful life may otherwise be reduced.

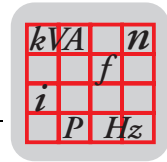

8.2 Technical Data of Basic Units

MPB... / MPR power supply module

MOVIDYN® power supply modules	MPB51A (brake chopper)			MPR51A (regenerative power supply unit)	
Basic unit	011-503-00	027-503-00	055-503-00	015-503-00	037-503-00
Part number	826 074 5	826 075 3	826 076 1	825 865 1	825 866 X
Supply system					
Nominal voltage V_{in}	3 x 380 V _{AC} -10% ... 500 V _{AC} +10% for UL: 380 V _{AC} -10 % ... 480 V _{AC} +10 %			3 x 380 V _{AC} -10% ... 500 V _{AC} +10%	
Frequency f_{in}	50 Hz/60 Hz 5 %				
Current I_{in}	16 A _{AC}	40 A _{AC}	80 A _{AC}	21 A _{AC}	53 A _{AC}
DC link $V_{in} = 400 V$					
No-load voltage V_Z	560 V _{DC} at 400 V _{AC}				
Peak current ¹⁾ I_{ZN}	20 A _{eff}	50 A _{eff}	100 A _{eff}	27 A _{eff}	67 A _{eff}
Rated current I_{Zmax}	40 A _{eff}	100 A _{eff}	200 A _{eff}	40 A _{eff}	100 A _{eff}
Rated power P_{ZN}	11 kW	27 kW	55 kW	15 kW	37 kW
Ratd power ¹⁾ P_{Zmax}	22 kW	54 kW	110 kW	22 kW	55 kW
Braking resistor external $R (\pm 10\%)$	47 Ω	18 Ω	15 Ω	not applicable	
Peak braking power P_{BRCMAX}	14 kW	38 kW	45 kW	not applicable	
internal 24 V supply (switch-mode power supply) ²⁾	240 W			50 W	
Type of cooling (DIN 41 751)	KF (forced-cooling)			KS (self-cooling)	
Chassis m_{MP}	5.5 kg (12.1 lb)	7 kg (15.4 lb)	7 kg (15.4 lb)	5.5 kg (12.1 lb)	7 kg (15.4 lb)
Dimensions					
Chassis dimensions $W \times H \times D$ [mm] [in]	105x380x250 (4.1x15.0x9.8)	140x380x250 (5.5x15.0x9.8)	140x380x250 (5.5x15.0x9.8)	105x380x250 (4.1x15.0x9.8)	140x380x250 (5.5x15.0x9.8)
Depth with heat sink D_K	340 mm (10.83 in) (DKF, DKS), 275 mm (10.83 in) (DKE)				
Width in component units W_{TE} (1 TE = 35 mm = 1.38 in)	3	4	4	3	4
Line choke type	ND 020-013	ND 045-013	ND 085-013	ND 045-013	ND 085-013
Braking resistor type	BW x47	BW 018-...	BW x15	not required	
Input filter type $V_{in} \leq 400 V$	NF 025-443	NF 050-443	NF 080-443	NF 036-443	NF 080-443
Input filter type $V_{in} \leq 500 V$	NF 025-503	NF 050-503	NF 080-503	NF 036-503	NF 080-503

- 1) The MPB power supply modules may be loaded with peak current/peak power for a maximum of 5 s. With an attached heat sink, the MPR power supply modules may be loaded continually with peak current/peak power.
- 2) The utilization of the switch-mode power supply and the connection of an external 24 V_{DC} voltage supply is covered in the chapter "Electrical Installation."

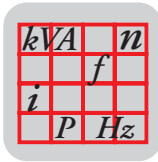
**MAS... axis module**

MOVIDYN [®] axis module	MAS51A				
	IPOS design: MAS51A xxx-503-50				
Basic unit	005-503-00	010-503-00	015-503-00	030-503-00	060-503-00
Part number	826 069 9	826 070 2	826 071 0	826 072 9	826 073 7
Part number of IPOS unit	826 255 1	826 256 X	826 257 8	826 258 6	826 259 4
Input voltage = DC link voltage V_Z	$V_Z = 700 V_{DC} (V_{in} = 500 V_{AC})$ $V_{Zmax} = 900 V_{DC}$ $V_Z = 680 V_{DC} (V_{in} = 480 V_{AC})$				
Output voltage V_S	0 ... V_{in}				
Rated output current with attached heat sink I_S	5 A _{AC}	10 A _{AC}	15 A _{AC}	30 A _{AC}	60 A _{AC}
Maximum output current I_{max} with attached heat sink, max 0.3 s for $n \leq 30$ 1/min, continually for $n > 30$ 1/min	7.5 A _{AC}	15 A _{AC}	22.5 A _{AC}	45 A _{AC}	90 A _{AC}
Type of cooling (DIN 4175)	KS (self-cooling)				
Chassis m_{MA}	3.5 kg (7.7lb)	3.5 kg (7.7 lb)	3.5 kg (7.7 lb)	5.5 kg (12.1 lb)	7 kg (15.4 lb)
Dimensions					
Chassis dimensions [mm] W x H x D [in]	70x380x250 (2.8x15.0x9.8)	70x380x25 (2.8x15.0x9.8)	70x380x250 (2.8x15.0x9.8)	105x380x250 (4.1x15.0x9.8)	140x380x250 (5.5x15.0x9.8)
Depth with heat sink D_K	340 mm (13.38 in) (DKF, DKS), 275 mm (10.83 in) (DKE)				
Width in component units W_{TE} (1 TE = 35 mm = 1.38 in)	2	2	2	3	4

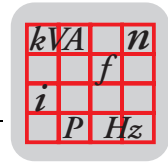

MKS... Compact Servo Controller

MOVIDYN® compact servo controller	MKS51A IPOS design: MKS51A xxx-503-50		
Basic unit	005-503-00	010-503-00	015-503-00
Part number	826 044 3	826 045 1	826 429 5
Part number of IPOS unit	826 260 8	826 261 6	826 430 9
Supply system			
Voltage V_{in}	3 x 380 V _{AC} -10% ... 500 V _{AC} +10 %		
Frequency f_{in}	50/60 Hz 5 %		
Rated current I_{in}	4.5 A _{AC}	9 A _{AC}	13.5 A _{AC}
Output			
Rated current I_N	5 A _{AC}	10 A _{AC}	15 A _{AC}
Maximum current I_{max} max. 0.3 s for $n \leq 30$ 1/min, continually for $n > 30$ 1/min	7.5 A _{AC}	15 A _{AC}	22.5 A _{AC}
Voltage V_O	0 ... V_{in}		
Braking resistor external R ($\pm 10\%$)	47 Ω		
Peak braking power P_{BRCMAX}	5 kW	10 kW	14 kW
Switch-mode power supply ¹⁾	29 W		
Type of cooling (DIN 41 751)	KF – forced-cooling		
Chassis m_{Ma}	4.5 kg (9.9 lb)	4.5 kg (9.9 lb)	6.5 kg (14.3 lb)
Chassis dimensions WxHxD [mm] [in]	105 x 275 x 275 (4.13 x 10.83 x 10.83)		130 x 336 x 325 (5.12 x 13.23 x 12.80)
Braking resistor type	BW 047-004 / BW 047-005 BW 147 / BW 247 / BW 347		
Input filter type $V_{in} \leq 400$ V	NF 008-443		NF 025-443
Input filter type $V_{in} \leq 500$ V	NF 008-503		NF 025-503

1) The utilization of the switch-mode power supply and the connection of an external 24 V_{DC} voltage supply is covered in section "Electrical Installation."



9 Index

0V lines 19
24 V (LED) 38
24 V supply 15, 43
7-segment display 38

A

AIO11 39
Ambient temperature 42
Analog outputs AIO P34_ 35
Auto reset 38
Axis address 31
Axis module 10
Axis module – power supply module connection 14
Axis module, 7-segment display 38

B

Binary inputs AIO P31_ 35
Binary inputs of basic unit P30_ 35
Binary outputs AIO P33_ 35
Binary outputs of basic unit P32_ 35
BME 17
BME brake rectifier 17
Brake circuit diagram 18
Brake function P50_ 36
Brake reaction times 18
Brake release time 18
Brake, block diagram 18
Braking relay 17
Braking resistor, connection 14
Braking resistors 10
Braking torque 18
BSG 17
BSG brake control unit 17

C

CE designation 9
Climatic category 42
Compact servo controller, 7-segment display 38
Connecting the PC 30
Connection, EMC-compliant 21
Control functions P5_ 36
Control functions P7_ 36
Controller parameter P2_ 34
Cooling 10
Current reference value P41_ 36

D

Data bus cable 14, 39
DC link (F07) 39
DC link connection 14
Device protection 17
Display values P0_ 34
Disposal 5

DKF heat sink, electrical connection 14
Documentation 5

E

EEPROM (F25) 40
Electronic lines 19
Electronic terminals 19
Electronics service 41
Electronics voltage supply, connection 14
EMC

Input filter 19
Interference emission 19
Interference immunity 19
Output choke 22
Shielding 20
Wiring diagram 21

EMC-compliant installation 19
Emergency stop ramp 39
Emergency stop ramp P15_ 34
Enclosure 42
ES cable missing (F27) 40
external 24 V supply 43
External terminal (F26) 40
External voltage supply 15

F

Factory setting P61_ 36
Fault messages 39
Fault reaction 39
Fault reaction P62_ 36
Fieldbus parameter P79_ 37
Fieldbus PD description P78_ 36
Fieldbus timeout (F28) 40
Fieldbus timeout (F34) 40
Fieldbus timeout (F87) 40

G

Ground fault (F06) 39

H

Heat sink 10
Heat sink installation 10
Heat sink mounting 10
Hoists, brake connection 18
Hold controller P22_ 35

I

Input filter 16, 19
Input fuse 16
Installation 10
Installation altitude 42
Installation of axis module 10
Installation of braking resistors 10
Installation of line chokes 10
Installation, EMC-compliant 19



Installation, UL-compliant 22
Installing an axis system 10
Instant disconnect 39
Intended Use 4
Interference emission 19, 42
Interference immunity 19, 42
Internal 24 V (F15) 39
Ixt reference value P43_ 36

L

LEDs, power supply module 38
Limit switch 32, 40
Limit switch reversed (F29) 40
Limitings P21_ 35
Line chokes 10
List of parameters 34

M

MAS terminals 27
MAS, technical data 44
MAS/MKS unit design 8
MAS/MKS, unit design 8
Master-slave function 29
MD_SCOPE 33
MD_SHELL 31
Mechanical installation 10
Message bus connection (F05) 39
Minimum clearance for cooling 10
MKS terminals 28
MKS, technical data 45
MKS, wiring diagram 25
Monitoring time 40
Motor lead 16
Motor protection 17
Mounting of axis module 10
Mounting of braking resistors 10
Mounting of line chokes 10
MOVIDYN response time P66_ 36
MPB terminals 26
MPB, technical data 43
MPB/MAS, wiring diagram 23
MPR terminals 26
MPR, technical data 43
MPR, voltage supply, external 16
MPR/MAS, wiring diagram 24
MPR/MPB unit design 7
MPR/MPB, unit design 7

N

Nameplate 9

O

ON (LED) 38
Operating mode 42
Operating mode P10_ 34
Option card 40
Option card, startup 12

Output choke 22
Output filter 16
Overcurrent (F01) 39
Overcurrent circuit breaker 17
Overtemperature (F02) 39
Overtemperature (F11) 39

P

Parameter

Control functions 36
 Brake function 36
 Fieldbus parameter 37
 Fieldbus PD description 36
 Speed monitoring 36
Controller parameter 34
 Hold controller 35
 Limitings 35
 Speed controller 34
Display values 34
Reference messages 35
 Current reference value 36
 Ixt reference value 36
 Setpoint actual value comparison 36
 Speed reference value 35
Setpoints/ramp generators 34
 Emergency stop ramp 34
 Operating mode 34
 Ramp generator 1/2 34
 Rapid stop ramp 34
 Setpoint source 34
Special functions 36
 Factory setting 36
 Fault reaction 36
 MOVIDYN response time 36
 Parameter lock 36
 Ready for operation message 36
 Reset behavior 36
 Save EEPROM 36
Terminal assignment 35
 Analog outputs AIO 35
 Binary inputs AIO 35
 Binary inputs of basic unit 35
 Binary outputs AIO 35
 Binary outputs of basic unit 35

Parameter lock P64_ 36

PC control time (F43) 40

PLC 29

Power demand of components 15

Power supply module – axis module connection 14

Power supply module, LEDs 38

Programmable fault reaction 39

Programming the terminals 33

R

Ramp generator 1/2 P12_/P13_ 34

Rapid stop ramp P14_ 34

Reaction time (brake) 17



Reaction time, brake 18
Ready for operation message P60_ 36
Reference messages P4__ 35
Required hardware missing (F36) 40
Reset 38
Reset behavior P63_ 36
Resolver cable 17
Resolver fault (F14) 39
RS-485 interface 29

S

S1 AIO11 current (F09) 39
Safety Notes 4, 6
Save EEPROM P65_ 36
Service 41
Setpoint actual value comparison P42_ 36
Setpoint source (F32) 40
Setpoint source P11_ 34
Setpoints/ramp generators P1__ 34
Setting the controller 32
Shield clamps 13
Shielding 13, 20
Short circuit output (F31) 40
Signal generation 19
Special functions P6__ 36
Speed controller 32
Speed controller P20_ 34
Speed monitoring (F08) 39
Speed monitoring P51_ 36
Speed reference value P40_ 35
Startup of option card 12
Status LEDs 38
Storage temperature 42
Supply contactor 16, 17
Supply system lead 16
Switch cabinet 10
Switch-mode power supply 43

T

Technical data
 MAS... axis module 44
 MKS 45
 MPB/MPR power supply module 43
Terminal assignment 33
Terminal assignment P3__ 35
Terminals
 MAS 27
 MKS 28
 MPB 26
 MPR 26
TF temperature sensor 17
TH thermostat 17
Tightening torque 14, 16
TRIP (LED) 38
Type designation 9

U

UL maximum values 22
UL-compliant installation 22
Use, intended 4
User interface 31

V

Visualizing process data 33
Voltage supply, external 15

W

Warning Instructions 4
Wiring diagram
 MKS 25
 MPB/MAS 23
 MPR/MAS 24



Address List

Germany			
Headquarters Production Sales Service	Bruchsal	SEW-EURODRIVE GmbH & Co Ernst-Blickle-Straße 42 D-76646 Bruchsal P.O. Box Postfach 3023 · D-76642 Bruchsal	Tel. (0 72 51) 75-0 Fax (0 72 51) 75-19 70 http://www.SEW-EURODRIVE.de sew@sew-eurodrive.de
Production	Graben	SEW-EURODRIVE GmbH & Co Ernst-Blickle-Straße 1 D-76676 Graben-Neudorf P.O. Box Postfach 1220 · D-76671 Graben-Neudorf	Tel. (0 72 51) 75-0 Fax (0 72 51) 75-29 70 Telex 7 822 276
Assembly Service	Garbsen (near Hannover)	SEW-EURODRIVE GmbH & Co Alte Ricklinger Straße 40-42 D-30823 Garbsen P.O. Box Postfach 110453 · D-30804 Garbsen	Tel. (0 51 37) 87 98-30 Fax (0 51 37) 87 98-55
	Kirchheim (near München)	SEW-EURODRIVE GmbH & Co Domagkstraße 5 D-85551 Kirchheim	Tel. (0 89) 90 95 52-10 Fax (0 89) 90 95 52-50
	Langenfeld (near Düsseldorf)	SEW-EURODRIVE GmbH & Co Siemensstraße 1 D-40764 Langenfeld	Tel. (0 21 73) 85 07-30 Fax (0 21 73) 85 07-55
	Meerane (near Zwickau)	SEW-EURODRIVE GmbH & Co Dänkritzter Weg 1 D-08393 Meerane	Tel. (0 37 64) 76 06-0 Fax (0 37 64) 76 06-30
Additional addresses for service in Germany provided on request!			
France			
Production Sales Service	Hagenau	SEW-USOCOME SAS 48-54, route de Soufflenheim B. P. 185 F-67506 Hagenau Cedex	Tel. 03 88 73 67 00 Fax 03 88 73 66 00 http://www.usocome.com sew@usocome.com
Assembly Sales Service	Bordeaux	SEW-USOCOME SAS Parc d'activités de Magellan 62, avenue de Magellan - B. P. 182 F-33607 Pessac Cedex	Tel. 05 57 26 39 00 Fax 05 57 26 39 09
	Lyon	SEW-USOCOME SAS Parc d'Affaires Roosevelt Rue Jacques Tati F-69120 Vaulx en Velin	Tel. 04 72 15 37 00 Fax 04 72 15 37 15
	Paris	SEW-USOCOME SAS Zone industrielle 2, rue Denis Papin F-77390 Verneuil l'Etang	Tel. 01 64 42 40 80 Fax 01 64 42 40 88
Additional addresses for service in France provided on request!			
Argentina			
Assembly Sales Service	Buenos Aires	SEW EURODRIVE ARGENTINA S.A. Centro Industrial Garin, Lote 35 Ruta Panamericana Km 37,5 1619 Garin	Tel. (3327) 45 72 84 Fax (3327) 45 72 21 sewar@sew-eurodrive.com.ar
Australia			
Assembly Sales Service	Melbourne	SEW-EURODRIVE PTY. LTD. 27 Beverage Drive Tullamarine, Victoria 3043	Tel. (03) 99 33 10 00 Fax (03) 99 33 10 03
	Sydney	SEW-EURODRIVE PTY. LTD. 9, Sleigh Place, Wetherill Park New South Wales, 2164	Tel. (02) 97 25 99 00 Fax (02) 97 25 99 05
Austria			
Assembly Sales Service	Wien	SEW-EURODRIVE Ges.m.b.H. Richard-Strauss-Strasse 24 A-1230 Wien	Tel. (01) 6 17 55 00-0 Fax (01) 6 17 55 00-30 sew@sew-eurodrive.at



Address list

Belgium			
Assembly Sales Service	Brüssel	CARON-VECTOR S.A. Avenue Eiffel 5 B-1300 Wavre	Tel. (010) 23 13 11 Fax (010) 2313 36 http://www.caron-vector.be info@caron-vector.be
Brazil			
Production Sales Service	Sao Paulo	SEW DO BRASIL Motores-Redutores Ltda. Rodovia Presidente Dutra, km 208 CEP 07210-000 - Guarulhos - SP	Tel. (011) 64 60-64 33 Fax (011) 64 80 33 28 sew@sew.com.br
Additional addresses for service in Brazil provided on request!			
Bulgaria			
Sales	Sofia	BEVER-DRIVE GMBH Bogdanovetz Str.1 BG-1606 Sofia	Tel. (92) 9 53 25 65 Fax (92) 9 54 93 45 bever@mbox.infotel.bg
Canada			
Assembly Sales Service	Toronto	SEW-EURODRIVE CO. OF CANADA LTD. 210 Walker Drive Bramalea, Ontario L6T3W1	Tel. (905) 7 91-15 53 Fax (905) 7 91-29 99
	Vancouver	SEW-EURODRIVE CO. OF CANADA LTD. 7188 Honeyman Street Delta. B.C. V4G 1 E2	Tel. (604) 9 46-55 35 Fax (604) 946-2513
	Montreal	SEW-EURODRIVE CO. OF CANADA LTD. 2555 Rue Leger Street LaSalle, Quebec H8N 2V9	Tel. (514) 3 67-11 24 Fax (514) 3 67-36 77
Additional addresses for service in Canada provided on request!			
Chile			
Assembly Sales Service	Santiago de Chile	SEW-EURODRIVE CHILE Motores-Reductores LTDA. Panamericana Norte No 9261 Casilla 23 - Correo Quilicura RCH-Santiago de Chile	Tel. (02) 6 23 82 03+6 23 81 63 Fax (02) 6 23 81 79
China			
Production Assembly Sales Service	Tianjin	SEW-EURODRIVE (Tianjin) Co., Ltd. No. 46, 7th Avenue, TEDA Tianjin 300457	Tel. (022) 25 32 26 12 Fax (022) 25 32 26 11
Colombia			
Assembly Sales Service	Bogotá	SEW-EURODRIVE COLOMBIA LTDA. Calle 22 No. 132-60 Bodega 6, Manzana B Santafé de Bogotá	Tel. (0571) 5 47 50 50 Fax (0571) 5 47 50 44 sewcol@andinet.com
Croatia			
Sales Service	Zagreb	KOMPEKS d. o. o. PIT Erdödy 4 II HR 10 000 Zagreb	Tel. +385 14 61 31 58 Fax +385 14 61 31 58
Czech Republic			
Sales	Praha	SEW-EURODRIVE S.R.O. Business Centrum Praha Luná 591 16000 Praha 6	Tel. 02/20 12 12 34 + 20 12 12 36 Fax 02/20 12 12 37 sew@sew-eurodrive.cz
Denmark			
Assembly Sales Service	Kopenhagen	SEW-EURODRIVEA/S Geminivej 28-30, P.O. Box 100 DK-2670 Greve	Tel. 4395 8500 Fax 4395 8509 http://www.sew-eurodrive.dk sew@sew-eurodrive.dk
Estonia			
Sales	Tallin	ALAS-KUUL AS Paldiski mnt.125 EE 0006 Tallin	Tel. 6 59 32 30 Fax 6 59 32 31



Finland			
Assembly Sales Service	Lahti	SEW-EURODRIVE OY Vesimäentie 4 FIN-15860 Hollola 2	Tel. (3) 589 300 Fax (3) 780 6211
Great Britain			
Assembly Sales Service	Normanton	SEW-EURODRIVE Ltd. Beckbridge Industrial Estate P.O. Box No.1 GB-Normanton, West- Yorkshire WF6 1QR	Tel. 19 24 89 38 55 Fax 19 24 89 37 02
Greece			
Sales Service	Athen	Christ. Boznos & Son S.A. 12, Mavromichali Street P.O. Box 80136, GR-18545 Piraeus	Tel. 14 22 51 34 Fax 14 22 51 59 Boznos@otenet.gr
Hong Kong			
Assembly Sales Service	Hong Kong	SEW-EURODRIVE LTD. Unit No. 801-806, 8th Floor Hong Leong Industrial Complex No. 4, Wang Kwong Road Kowloon, Hong Kong	Tel. 2-7 96 04 77 + 79 60 46 54 Fax 2-7 95-91 29 sew@sewhk.com
Hungary			
Sales Service	Budapest	SEW-EURODRIVE Kft. H-1037 Budapest Kunigunda u. 18	Tel. +36 1 437 06 58 Fax +36 1 437 06 50
India			
Assembly Sales Service	Baroda	SEW-EURODRIVE India Pvt. Ltd. Plot No. 4, Gidc Por Ramangamdi · Baroda - 391 243 Gujarat	Tel. 0 265-83 10 86 Fax 0 265-83 10 87 sew.baroda@gecsl.com
Ireland			
Sales Service	Dublin	Alperon Engineering Ltd. 48 Moyle Road Dublin Industrial Estate Glasnevin, Dublin 11	Tel. (01) 8 30 62 77 Fax (01) 8 30 64 58
Italy			
Assembly Sales Service	Milano	SEW-EURODRIVE di R. Blickle & Co.s.a.s. Via Bernini,14 I-20020 Solaro (Milano)	Tel. (02) 96 98 01 Fax (02) 96 79 97 81
Japan			
Assembly Sales Service	Toyoda-cho	SEW-EURODRIVE JAPAN CO., LTD 250-1, Shimoman-no, Toyoda-cho, Iwata gun Shizuoka prefecture, P.O. Box 438-0818	Tel. (0 53 83) 7 3811-13 Fax (0 53 83) 7 3814
Korea			
Assembly Sales Service	Ansan-City	SEW-EURODRIVE KOREA CO., LTD. B 601-4, Banweol Industrial Estate Unit 1048-4, Shingil-Dong Ansan 425-120	Tel. (031) 4 92-80 51 Fax (031) 4 92-80 56
Luxembourg			
Assembly Sales Service	Brüssel	CARON-VECTOR S.A. Avenue Eiffel 5 B-1300 Wavre	Tel. (010) 23 13 11 Fax (010) 2313 36 http://www.caron-vector.be info@caron-vector.be
Macedonia			
Sales	Skopje	SGS-Skopje / Macedonia "Teodosij Sinactaski" 6691000 Skopje / Macedonia	Tel. (0991) 38 43 90 Fax (0991) 38 43 90
Malaysia			
Assembly Sales Service	Johore	SEW-EURODRIVE SDN BHD No. 95, Jalan Seroja 39, Taman Johor Jaya 81000 Johor Bahru, Johor West Malaysia	Tel. (07) 3 54 57 07 + 3 54 94 09 Fax (07) 3 5414 04



Address list

Netherlands			
Assembly Sales Service	Rotterdam	VECTOR Aandrijftechniek B.V. Industrieweg 175 NL-3044 AS Rotterdam Postbus 10085 NL-3004 AB Rotterdam	Tel. +31 10 44 63 700 Fax +31 10 41 55 552 http://www.vector.nu info@vector.nu
New Zealand			
Assembly Sales Service	Auckland	SEW-EURODRIVE NEW ZEALAND LTD. P.O. Box 58-428 82 Greenmount drive East Tamaki Auckland	Tel. 0064-9-2 74 56 27 Fax 0064-9-2 74 01 65 sales@sew-eurodrive.co.nz
	Christchurch	SEW-EURODRIVE NEW ZEALAND LTD. 10 Settlers Crescent, Ferrymead Christchurch	Tel. (09) 3 84 62 51 Fax (09) 3 84 64 55 sales@sew-eurodrive.co.nz
Norway			
Assembly Sales Service	Moss	SEW-EURODRIVE A/S Solgaard skog 71 N-1599 Moss	Tel. (69) 2410 20 Fax (69) 2410 40 sew@sew-eurodrive.no
Peru			
Assembly Sales Service	Lima	SEW DEL PERU MOTORES REDUCTORES S.A.C. Los Calderos # 120-124 Urbanizacion Industrial Vulcano, ATE, Lima	Tel. (511) 349-52 80 Fax (511) 349-30 02 sewperu@terra.com.pe
Poland			
Sales	Lodz	SEW-EURODRIVE Polska Sp.z.o.o. ul. Pojezierska 63 91-338 Lodz	Tel. (042) 6 16 22 00 Fax (042) 6 16 22 10 sew@sew-eurodrive.pl
Portugal			
Assembly Sales Service	Coimbra	SEW-EURODRIVE, LDA. Apartado 15 P-3050-901 Mealhada	Tel. (0231) 20 96 70 Fax (0231) 20 36 85 infosew@sew-eurodrive.pt
Romania			
Sales Service	Bucuresti	Sialco Trading SRL str. Madrid nr.4 71222 Bucuresti	Tel. (01) 2 30 13 28 Fax (01) 2 30 71 70 sialco@mediasat.ro
Russia			
Sales	St. Petersburg	ZAO SEW-EURODRIVE P.O. Box 193 193015 St. Petersburg	Tel. (812) 3 26 09 41 + 5 35 04 30 Fax (812) 5 35 22 87 sewrus@post.spbnit.ru
Singapore			
Assembly Sales Service		SEW-EURODRIVE PTE. LTD. No 9, Tuas Drive 2 Jurong Industrial Estate Singapore 638644	Tel. 8 62 17 01-705 Fax 8 61 28 27 Telex 38 659
Slovenia			
Sales Service	Celje	Pakman - Pogonska Tehnika d.o.o. Ul. XIV. divizije 14 SLO – 3000 Celje	Tel. 00386 3 490 83 20 Fax 00386 3 490 83 21 pakman@siol.net



South Africa			
Assembly Sales Service	Johannesburg	SEW-EURODRIVE (PROPRIETARY) LIMITED Eurodrive House Cnr. Adcock Ingram and Aerodrome Roads Aeroton Ext. 2 Johannesburg 2013 P.O.Box 90004 Bertsham 2013	Tel. + 27 11 248 70 00 Fax +27 11 494 23 11
	Capetown	SEW-EURODRIVE (PROPRIETARY) LIMITED Rainbow Park Cnr. Racecourse & Omuramba Road Montague Gardens Cape Town P.O.Box 36556 Chempet 7442 Cape Town	Tel. +27 21 552 98 20 Fax +27 21 552 98 30 Telex 576 062
	Durban	SEW-EURODRIVE (PROPRIETARY) LIMITED 2 Monaceo Place Pinetown Durban P.O. Box 10433, Ashwood 3605	Tel. +27 31 700 34 51 Fax +27 31 700 38 47
Spain			
Assembly Sales Service	Bilbao	SEW-EURODRIVE ESPAÑA, S.L. Parque Tecnológico, Edificio, 302 E-48170 Zamudio (Vizcaya)	Tel. 9 44 31 84 70 Fax 9 44 31 84 71 sew.spain@sew-eurodrive.es
Sweden			
Assembly Sales Service	Jönköping	SEW-EURODRIVE AB Gnejsvägen 6-8 S-55303 Jönköping Box 3100 S-55003 Jönköping	Tel. (036) 34 42 00 Fax (036) 34 42 80 www.sew-eurodrive.se
Switzerland			
Assembly Sales Service	Basel	Alfred Imhof A.G. Jurastrasse 10 CH-4142 Münchenstein bei Basel	Tel. (061) 4 17 17 17 Fax (061) 4 17 17 00 http://www.imhof-sew.ch info@imhof-sew.ch
Thailand			
Assembly Sales Service	Chon Buri	SEW-EURODRIVE (Thailand) Ltd. Bangpakong Industrial Park 2 700/456, Moo.7, Tambol Donhuaroh Muang District Chon Buri 20000	Tel. 0066-38 21 40 22 Fax 0066-38 21 45 31
Turkey			
Assembly Sales Service	Istanbul	SEW-EURODRIVE Hareket Sistemleri San. ve Tic. Ltd. Sti Bagdat Cad. Koruma Cikmazi No. 3 TR-81540 Maltepe ISTANBUL	Tel. (0216) 4 41 91 63 + 4 41 91 64 + 3 83 80 14 + 3 83 80 15 Fax (0216) 3 05 58 67 seweurodrive@superonline.com.tr
USA			
Production Assembly Sales Service	Greenville	SEW-EURODRIVE INC. 1295 Old Spartanburg Highway P.O. Box 518 Lyman, S.C. 29365	Tel. (864) 4 39 75 37 Fax Sales (864) 439-78 30 Fax Manuf. (864) 4 39-99 48 Fax Ass. (864) 4 39-05 66 Telex 805 550
Assembly Sales Service	San Francisco	SEW-EURODRIVE INC. 30599 San Antonio St. Hayward, California 94544-7101	Tel. (510) 4 87-35 60 Fax (510) 4 87-63 81
	Philadelphia/PA	SEW-EURODRIVE INC. Pureland Ind. Complex 200 High Hill Road, P.O. Box 481 Bridgeport, New Jersey 08014	Tel. (856) 4 67-22 77 Fax (856) 8 45-31 79
	Dayton	SEW-EURODRIVE INC. 2001 West Main Street Troy, Ohio 45373	Tel. (9 37) 3 35-00 36 Fax (9 37) 4 40-37 99
	Dallas	SEW-EURODRIVE INC. 3950 Platinum Way Dallas, Texas 75237	Tel. (214) 3 30-48 24 Fax (214) 3 30-47 24



Address list

USA			
Additional addresses for service in the USA provided on request!			
Venezuela			
Assembly Sales Service	Valencia	SEW-EURODRIVE Venezuela S.A. Av. Norte Sur No. 3, Galpon 84-319 Zona Industrial Municipal Norte Valencia	Tel. +58 (241) 8 32 98 04 Fax +58 (241) 8 38 62 75 sewventas@cantr.net sewfinanzas@cantr.net



SEW-EURODRIVE GmbH & Co · P.O. Box 3023 · D-76642 Bruchsal/Germany · Phone +49-7251-75-0
Fax +49-7251-75-1970 · <http://www.sew-eurodrive.com> · sew@sew-eurodrive.com

SEW
EURODRIVE

