

TECHNICAL DATA MANUAL

HR / HRS BRUSHLESS AC SERVOMOTORS



Publication No. TD HRM 1.1
ISSUE NO.9.5 (Metric Series)

Date: November 2009

CONTENTS

- 1** Introduction
- 2** General information
 - Receiving and storage.
 - Environmental protection.
 - Mounting of motors.
 - Thermal protection.
 - Holding brake options.
 - Maintenance and servicing.
 - E.C. Directives.
- 3** Mechanical tolerance
- 4** Connection diagrams
- 5** Feedback device specification
- 6** Torque derating at high temperatures
- 7** HR55 Technical Information
- 8** HR70 Technical Information
- 9** HR92 Technical Information
- 9A** HRS92 Technical Information
- 10** HR115 Technical Information
- 10A** HRS115 Technical Information
- 11** HR142 Technical Information
- 11A** HRS142 Technical Information
- 12** HR190 Technical Information
- 13** Useful Formulae

INTRODUCTION

SEM has continuously developed its range of servo products to best serve the latest industry requirements. The new HR range of servomotors uses the long experience gained in the servomotor field to give cost effective performance.

The HR range is fitted with Neodymium-Iron-Boron magnets (NdFeB) and is ideally suited to the requirements of Machine Tools, Transfer Lines, Robotics, etc. A high torque to inertia ratio gives fast acceleration and rapid dynamic response. The motors are enclosed to IP65 as standard (other ratings on request).

WHY BRUSHLESS?

The optimum performance of a Brushless Servomotor is achievable without danger of Commutator 'Flashover'.

Speeds of up to 8000 rpm Direct Drive are possible.

SEM Brushless Servomotors are available with High Flux- Density Rare-Earth Magnets reducing the Rotor Inertia and allowing Higher Peak Torques for acceleration/deceleration.

As the winding is stationary we have been able to position a Thermal Protector here, where it is most effective. By using this Thermal Protector, together with a simple current limit, the risk of overheating or demagnetising a brushless servomotor can be virtually eliminated.

The motors are virtually maintenance free.

SEM BRUSHED SERVOMOTORS STILL HAVE THE FOLLOWING ADVANTAGES

- A. Minimum system cost Torque for Torque.
- B. Smoothest running at low speed.
- C. Brushed Tacho's have a lower ripple than brushless ones.

SINUSOIDAL AND TRAPEZOIDAL MOTORS







Sinusoidal (A.C.) - The motor back E.M.F. and current waveforms are sinusoidal. The Drive Amplifier continuously measures the Rotor position and adjusts the phase currents accordingly.

INTRODUCTION

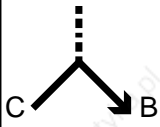
SEM Sinusoidal Motors are fitted as standard with a Resolver to give the Rotor position information. This has the added advantage that feedback for velocity and positional loops can be provided by the same Resolver.

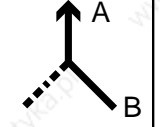
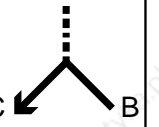
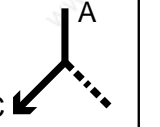
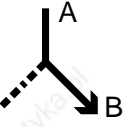
Trapezoidal (D.C.) - The motor back E.M.F. and current waveforms are Trapezoidal. The Drive Amplifier ensures 2 out of the 3 phases are on at each commutation point. As one phase turns off the third phase takes its place. The rotor will try to align itself with the new M.M.F. causing rotation.

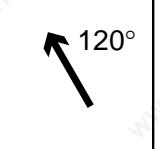
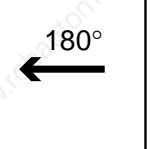
A diagram showing the switching sequence is shown below:-

STEP No.	1	2	3	4	5	6
CURRENT IN WINDING						
RESULTANT ROTATING FIELD						

The Drive Amplifier is performing the role of a Commutator in a conventional D.C. Motor, ensuring the Stator and Rotor m.m.f. are always approximately at right angles. This gives the maximum Torque for a given current.

SEM Trapezoidal Motors are fitted as standard with Hall Effect Sensors to give the Rotor position information and a Brushless Tachogenerator for the velocity feedback loop. An Encoder is optional for accurate positioning.

GENERAL INFORMATION

RECEIVING AND STORAGE

On receipt the motors should be inspected. Any damage found should be reported immediately to SEM and the carrier.

The shaft has been coated with a rust inhibitor, this can be removed with a suitable solvent.

ENVIRONMENTAL PROTECTION

All SEM brushless servomotors are protected to IP65 except at the shaft where the protection is to IP64.

Protection Class	Description
IP65	Totally protected against dust. Protected against low pressure jets of water from all directions with limited ingress permitted.
IP64	Totally protected against dust. Protected against water sprayed from all directions with limited ingress permitted.

MOUNTING OF MOTORS

Where a toothed belt drive is proposed the motors should be flange mounted to an angle bracket, or similar, as close as possible to the line of action of the drive. The motor pulley should be positioned as close as possible to the mounting face and the pulley diameter chosen to maintain dynamic shaft loading within the limits indicated on the loading graphs. Particular attention must be given to tension of drive belts, with reference to belt manufacturers instructions so that unnecessarily high shaft loads are avoided on installation.

When the motor is close coupled to a reduction gearbox, it is strongly recommended that the complete unit is fitted to the final product by attachment at the gearbox, not by foot mounting the motor.

By this method the unit will be better able to withstand the reaction of high output torques. Due to the nature of the NdFeB magnets used in HR motors, forced air ventilation is not available.

THERMAL PROTECTION

In all SEM brushless servomotors, the thermal sensor is embedded in the winding so that it can respond as quickly as possible to protect the winding from overheating.

The standard sensor is a switch. Various other sensors are available on request.

The thermal protector is not capable of switching motor line currents and must be used only in the drive amplifier circuitry.

SWITCH (STANDARD)

The thermal switch fitted to SEM brushless servomotors is normally closed when cold and opens when the switching temperature is exceeded.

Switch ratings

50Vac 2.5A with 1.0 power factor

50Vac 1.6A with 0.6 power factor

(Rating as VDE 0631, 10.4.1)

GENERAL INFORMATION

The actual temperature at which the switch opens ($155^{\circ}\text{C} \pm 5^{\circ}\text{C}$) has been selected to give reasonable protection to the SEM range of motors.

After the switch has opened, the temperature must fall to approximately 120°C before it will close again.

PTC THERMISTOR (OPTION)

The thermistor is a single thermistor of the type specified in BS4999 part 111 1987.

The voltage across the thermistor must not exceed 2.5V.

Resistance change with temperature	
Temperature $^{\circ}\text{C}$	Resistance Ω
< -20	not defined
- 20 to 130	< 250
145	< 550
155	< 1330
> 165	> 4000

To protect the winding, the drive should shut down if the resistance exceeds 1000 Ohms.

NTC THERMISTOR (OPTION)

The NTC thermistor is a single thermistor device with the below characteristics:

Resistance change with temperature	
Temperature $^{\circ}\text{C}$	Resistance Ω
0	324K
25	100K Ω 10%
100	6K83
150	1K88
160	1K50

We recommend that the power dissipation in the sensor is less than 2mW.

To protect the winding, the drive should shut down if the resistance is less than 1K7 Ohms.

It is advisable to also shut down, if the resistance exceeds 500K Ohms, to detect a possible open circuit cable.

TEMPERATURE SENSOR (OPTION)

This is a PTC sensor (Phillips type KTY 84-130) whose resistance varies as indicated.

Resistance change with temperature	
Temperature $^{\circ}\text{C}$	Resistance Ω
0	493
25	598
100	970 to 1030
150	1340
160	1415

The current in the sensor should be between 1mA and 3mA.

To protect the winding, the drive should shut down if the resistance exceeds 1400 Ohms.

GENERAL INFORMATION

HOLDING BRAKE OPTIONS

Two models of fail safe brake options are available, one is a spring applied and the other a permanent magnet type.

Both types are primarily holding brakes e.g. to hold a vertical axis under a no voltage condition. However, they can also be used in some applications for emergency stopping.

Spring Applied Brake

The brake is of the 'springset' fail to safe type.

Connection should be such that when the motor is powered the brake coil is energised and the brake released. Under normal operating conditions no maintenance is required other than ensuring that the hub and stationary plates are kept free from foreign matter.

Standard Ratings

Frame	Brake holding torque at working temperature Nm (lb-in)	Voltage Vdc	Nominal Power Consumed W
HR55	1 (9)	24 or 90	TBA
HR70	2 (18)	24 or 90	TBA
HR/HRS92	5 (44)	24 or 90	13
HR115	10 (88)	24 or 90	13
HRS115	13.5 (120)	24 or 90	13
HR/HRS142	18 (160)	24 or 90	24
HR190	70 (620)	24 or 90	33

Optional Torque Ratings

Frame	Brake holding torque at working temperature Nm (lb-in)	Voltage Vdc	Nominal Power Consumed W
HR115	5 (44)	24 or 90	13
HR115	13.5 (120)	24 or 90	13
HR/HRS142	40 (350)	24 or 90	24

GENERAL INFORMATION

MAINTENANCE AND SERVICING

Bearings

All servomotors are fitted with double shielded, single row radial ball bearings. Under normal conditions no maintenance is required.

Bearing Specification		
Frame	ISO Code for Drive End	ISO Code for Non-Drive End
HR55	6000-2RS	6000-2Z
HR70	6002-2RS	6000-2Z
HR92	6002-2Z	6002-2Z
HR115	6004-2Z	6003-2Z
HR142	6205-2Z	6004-2Z
HR190	6207-2Z	6205-2Z

The bearings are selected to give a minimum 30,000 hours life. Refer to the shaft loading graphs for further information.

Mechanical

It is recommended that a general inspection be made at regular intervals to check all bolts, nuts, couplings, etc. to ensure that they are still tightened to the correct torque.

Fitting & Tightening Brushless Motor Drive End to Body Fasteners		
Frame	Screw Size	Torque
HR55	M2.5	0.8 Nm
HR70	M4	2.2 Nm
HR92	M5	5.0 Nm
HR115	M5	5.0 Nm
HR142	M6	8.0 Nm
HR190	M10	25.0 Nm

For information on the repair and rectification of brushless servomotors please contact SEM.

E.C. DIRECTIVES

There are three main directives that affect applications incorporating servomotors.

Machinery Directive 2006/42/EC

This directive applies to complete machines.

In accordance with the directive, SEM provides a Certificate of Incorporation which includes installation instructions and general service guidelines in different languages.

Low Voltage Directive 2006/95/EC

This applies to electrical equipment for use with a DC voltage of 75V to 1500V and AC voltage of 50V to 1000V.

SEM AC/DC brushless servomotors in the ranges HJ96, HJ116, HJ130 and HJ/HJT155 conform to the EC directive.

A certificate of conformity is available from SEM sales on request.

EMC Directive (Electro Magnetic Compatibility) 2004/108/EC

This directive applies to products or appliances with an intrinsic function for the end user in which:

1. They contain electrical/electronic systems liable to cause an electromagnetic disturbance.
2. They contain electrical/electronic systems which may have their performance affected by an electromagnetic disturbance.

SEM can provide data sheets outlining the EMC characteristics of a standard SEM AC brushless servomotor and giving advice on cable screening connectors and other related subjects.

SEM will be pleased to discuss any EMC related problems encountered by customers incorporating SEM AC/DC brushless servomotors into such products or appliances which are governed by the EMC directive.

MECHANICAL TOLERANCE IEC 72 SHAFT & SPIGOT CHECKING CHART

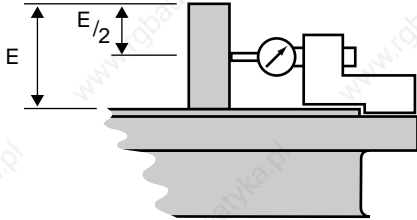

SHAFT EXTENSION RUN-OUT

SHAFT DIAMETER mm	NORMAL CLASS		PRECISION CLASS	
	mm	inch	mm	inch
≤10	.030	.00181	.015	.00059
>10 ≤ 18	.035	.00138	.018	.00071
>18 ≤ 30	.040	.00157	.021	.00082
>30 ≤ 50	.050	.00196	.025	.00098
>50 ≤ 80	.060	.00236	.030	.00181

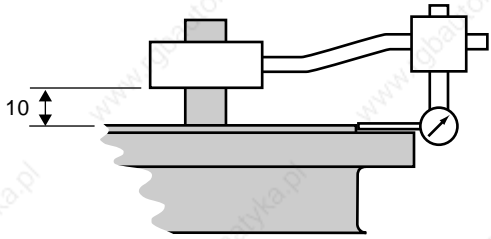

**CONCENTRICITY OF SPIGOT
AND SHAFT**

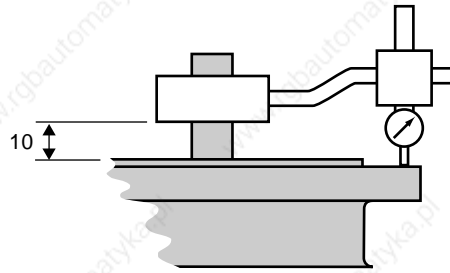

**PERPENDICULARITY OF
MOUNTING FACE TO SHAFT**

FLANGE NUMBER	SPIGOT DIAMETER	FLANGE O/D/DIAMETER	MAXIMUM PERMISSIBLE CHANGE IN INDICATOR READING			
			NORMAL CLASS		PRECISION CLASS	
			mm	inch	mm	inch
55	40	70	.08	.00315	.04	.00157
65	50	80				
75	60	90				
85	70	105				
100	80	120				
115	95	140				
130	110	160	.10	.00394	.05	.00197
165	130	200				
215	190	250				
265	230	300				

BRUSHLESS 55/70 SERIES MOTOR WITH RESOLVER – SOURIAU TYPE

SUPPLY CONNECTOR

PIN	FUNCTION
1	MOTOR U
2	MOTOR V
3	MOTOR W
4	BRAKE B+ (IF FITTED)
5	BRAKE B- (IF FITTED)
≡	EARTH

FEEDBACK CONNECTOR

PIN	FUNCTION
1	ROTOR R1
2	ROTOR R2
3	STATOR 1st PHASE S1
4	STATOR 1st PHASE S3
5	STATOR 2nd PHASE S2
6	STATOR 2nd PHASE S4
7	THERMAL SENSOR K1
8	THERMAL SENSOR K2
9	

SOURIAU 8GN-QL2-6P

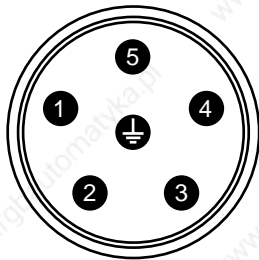

*NOTE: Connectors
viewed from
customer side.*

SOURIAU 8GN-QL2-9P

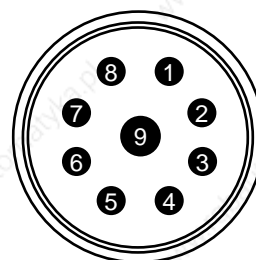

CONNECTION DETAILS

MOTOR WITH RESOLVER – INTERCONNECTRON TYPE

PIN	FUNCTION
U	MOTOR U
V	MOTOR V
+	BRAKE B+ (IF FITTED)
-	BRAKE B- (IF FITTED)
W	MOTOR W
⊕	MOTOR EARTH ⊕

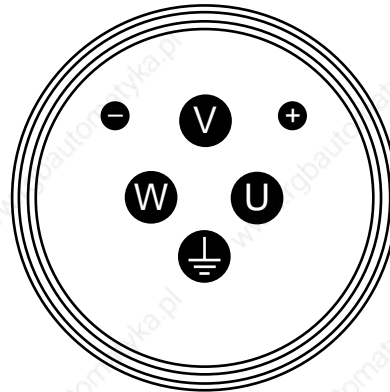

INTERCONNECTRON
SIZE 1.5 6 PIN
(FOR FRAME 142 AND LARGER)

SUPPLY CONNECTOR

PIN	FUNCTION
1	MOTOR U
2	MOTOR V
4	BRAKE B+ (IF FITTED)
5	BRAKE B- (IF FITTED)
6	MOTOR W
⊕	MOTOR EARTH ⊕

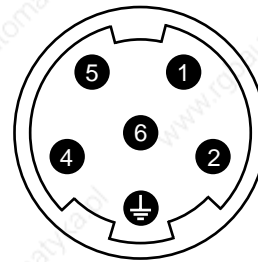

INTERCONNECTRON
SIZE 1 6 PIN
(FOR FRAME 115 AND SMALLER*)

FEEDBACK CONNECTOR

PIN	FUNCTION
1	STATOR 2nd PHASE S2
2	STATOR 2nd PHASE S4
3	
4	
5	
6	
7	ROTOR R2
8	THERMAL SENSOR
9	THERMAL SENSOR
10	ROTOR R1
11	STATOR 1st PHASE S1
12	STATOR 1st PHASE S3

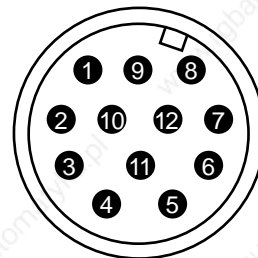

INTERCONNECTRON
SIZE 1 12 PIN
(20° OFFSET)

* Some 142 frames can be fitted with the size 1 power connector. Consult SEM for details.

NOTE: Connectors viewed from customer side.

CONNECTION DETAILS

MOTOR WITH RESOLVER – MS TYPE

TERMINAL BOX (OPTION)

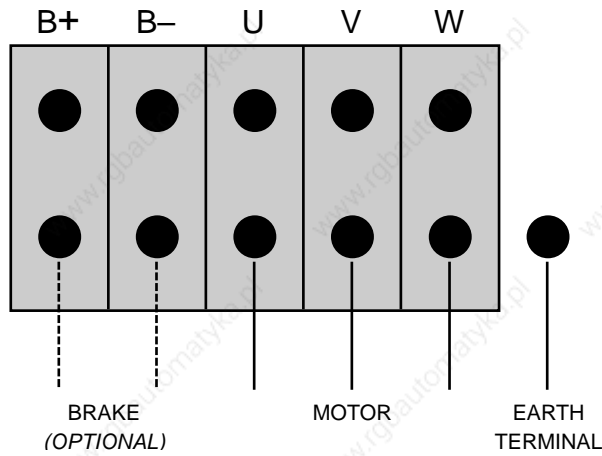

SUPPLY CONNECTOR (OPTION)

PIN	FUNCTION
A	MOTOR U
B	MOTOR V
C	BRAKE B+ IF FITTED
D	BRAKE B- IF FITTED
E	MOTOR EARTH \perp
F	MOTOR W
G	

FEEDBACK CONNECTOR

PIN	FUNCTION
A	ROTOR R1
B	ROTOR R2
C	STATOR 1st PHASE S1
D	STATOR 2nd PHASE S2
E	STATOR 1st PHASE S3
F	
G	
H	
J	
K	
L	
M	
N	
P	STATOR 2nd PHASE S4
R	
S	THERMAL SENSOR K1
T	THERMAL SENSOR K2

FRAMES 92 & 115 – MS3102E-20-15P

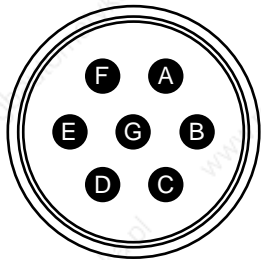

FRAME 142 – MS3102E-24-10P

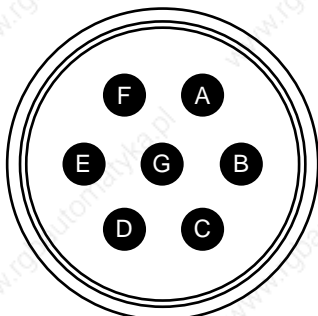

MS3102E-20-29P

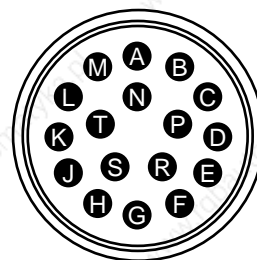

NOTE:
Connectors
viewed from
customer side

CONNECTION DETAILS

HR BRUSHLESS MOTOR WITH HEIDENHAIN ERN1387 OR ERN1185 ENCODER

NOTE: Connectors viewed from customer side.

PIN	FUNCTION
U	MOTOR U
V	MOTOR V
+	BRAKE B+ (IF FITTED)
-	BRAKE B- (IF FITTED)
W	MOTOR W
⊕	MOTOR EARTH ⊕

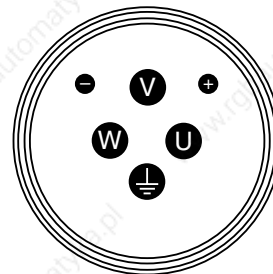

**INTERCONNECTRON
SIZE 1.5 6 PIN**

SUPPLY CONNECTOR

PIN	FUNCTION
1	MOTOR U
2	MOTOR V
4	BRAKE B+ (IF FITTED)
5	BRAKE B- (IF FITTED)
6	MOTOR W
⊕	MOTOR EARTH ⊕

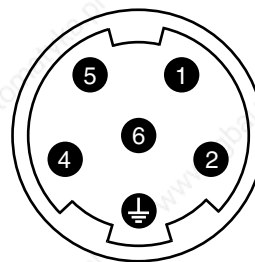

**INTERCONNECTRON
SIZE 1 6 PIN**

FEEDBACK CONNECTOR

PIN	FUNCTION
1	A+ (0° SIGNAL)
2	A- (0° SIGNAL)
3	R+ (REF SIGNAL)
4	D- (COSINUS)
5	C+ (SINUS)
6	C- (SINUS)
7	0V (UN)
8	THERMAL SENSOR +
9	THERMAL SENSOR -
10	+5V (UP)
11	B+ (90° SIGNAL)
12	B- (90° SIGNAL)
13	R- REF SIGNAL
14	D+ (COSINUS)
15	0V (SENSOR UN)
16	+5V (SENSOR UP)
17	

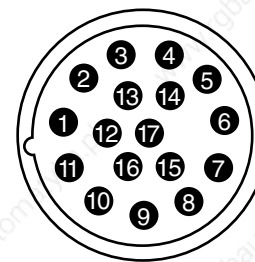

**INTERCONNECTRON
SIZE 1 17 PIN**

TERMINAL BOX (OPTION)

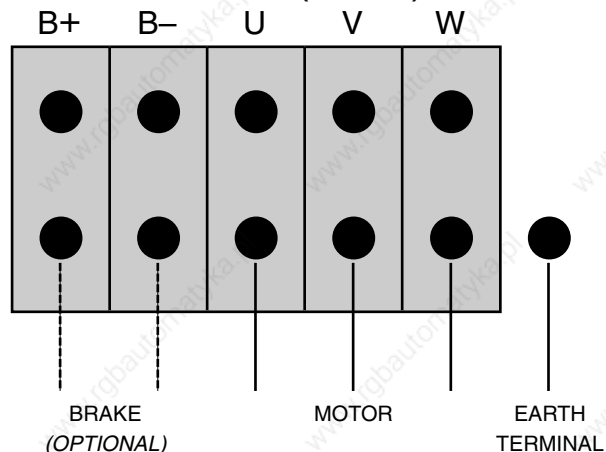

CONNECTION DETAILS

HR BRUSHLESS MOTOR WITH HEIDENHAIN ENDAT ENCODER

NOTE: Connectors viewed from customer side.

PIN	FUNCTION
U	MOTOR U
V	MOTOR V
+	BRAKE B+ (IF FITTED)
-	BRAKE B- (IF FITTED)
W	MOTOR W
⊕	MOTOR EARTH ⊕

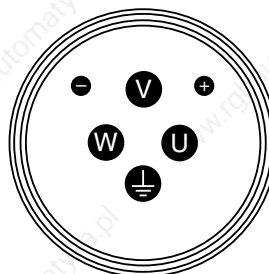

INTERCONNECTRON
SIZE 1.5 6 PIN

SUPPLY CONNECTOR

PIN	FUNCTION
1	MOTOR U
2	MOTOR V
4	BRAKE B+ (IF FITTED)
5	BRAKE B- (IF FITTED)
6	MOTOR W
⊕	MOTOR EARTH ⊕

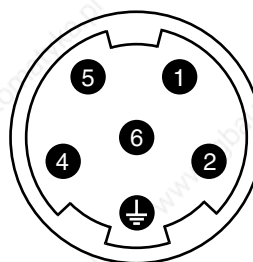

INTERCONNECTRON
SIZE 1 6 PIN

FEEDBACK CONNECTOR

PIN	FUNCTION
1	A+ (0° SIGNAL)
2	A- (0° SIGNAL)
3	DATA
4	
5	CLOCK +
6	
7	0V (UN)
8	THERMAL SENSOR +
9	THERMAL SENSOR -
10	+5V (UP)
11	B+ (90° SIGNAL)
12	B- (90° SIGNAL)
13	DATA -
14	CLOCK -
15	0V (SENSOR UN)
16	+5V (SENSOR UP)
17	

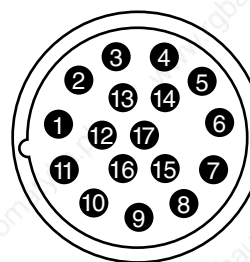

INTERCONNECTRON
SIZE 1 17 PIN

TERMINAL BOX (OPTION)

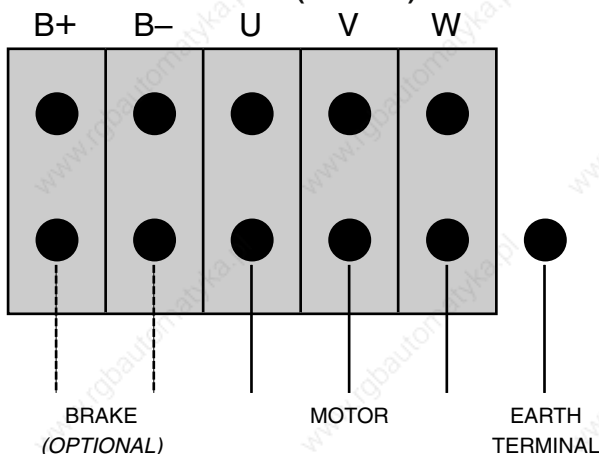

CONNECTION DETAILS

HR BRUSHLESS MOTOR WITH STEGMANN SRS50 OR SRM50 ENCODER

NOTE: Connectors viewed from customer side.

PIN	FUNCTION
U	MOTOR U
V	MOTOR V
+	BRAKE B+ (IF FITTED)
-	BRAKE B- (IF FITTED)
W	MOTOR W
⊥	MOTOR EARTH ⊥

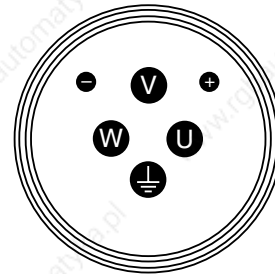

**INTERCONNECTRON
SIZE 1.5 6 PIN**

SUPPLY CONNECTOR

PIN	FUNCTION
1	MOTOR U
2	MOTOR V
4	BRAKE B+ (IF FITTED)
5	BRAKE B- (IF FITTED)
6	MOTOR W
⊥	MOTOR EARTH ⊥

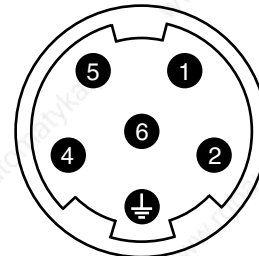

**INTERCONNECTRON
SIZE 1 6 PIN**

FEEDBACK CONNECTOR

PIN	FUNCTION
1	SIN +
2	REFSIN
3	+ 485
4	
5	
6	
7	GROUND
8	THERMAL SENSOR +
9	THERMAL SENSOR -
10	+V
11	COS +
12	REFCOS
13	- 485
14	
15	
16	
17	

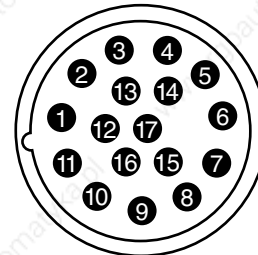

**INTERCONNECTRON
SIZE 1 17 PIN**

TERMINAL BOX (OPTION)

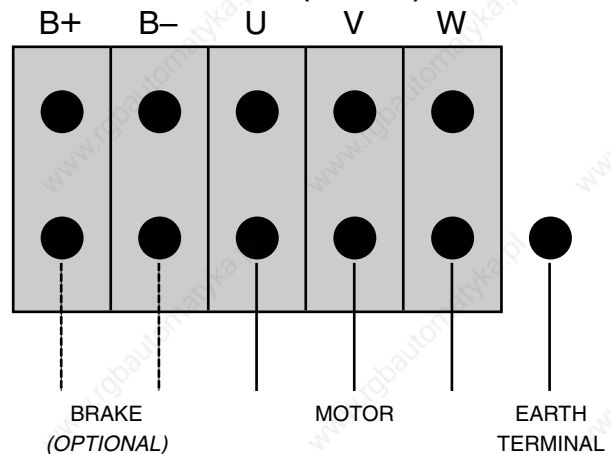

4

4

CONNECTION DETAILS

BRUSHLESS MOTOR WITH OIH48 ENCODER AND INTERCONNECTRON CONNECTORS

FEEDBACK CONNECTOR

PIN	FUNCTION
1	CHANNEL A
2	CHANNEL A-
3	CHANNEL Z
4	CHANNEL V-
5	CHANNEL U
6	CHANNEL U-
7	0V
8	THERMAL SENSOR K1
9	THERMAL SENSOR K2
10	+5V
11	CHANNEL B
12	CHANNEL B-
13	CHANNEL Z-
14	CHANNEL V
15	CHANNEL W-
16	CHANNEL W
17	

TERMINAL BOX (OPTION)

(HJ155 ONLY)

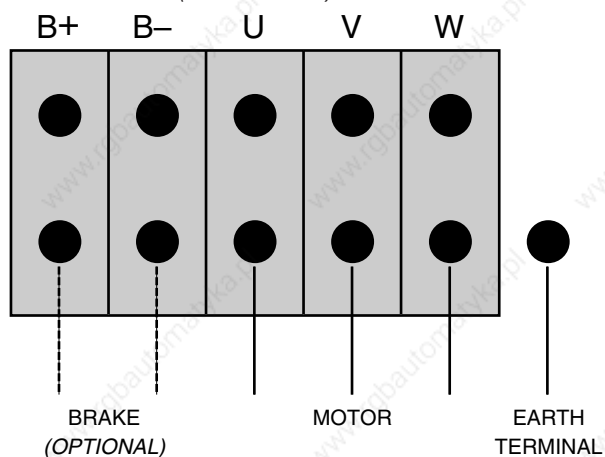

INTERCONNECTRON SIZE 1 17 PIN

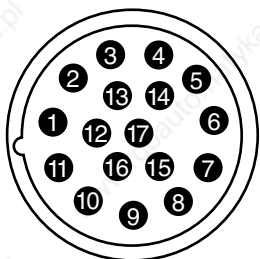

INTERCONNECTRON SIZE 1.5 6 PIN

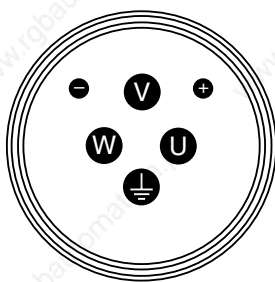

INTERCONNECTRON SIZE 1 6 PIN

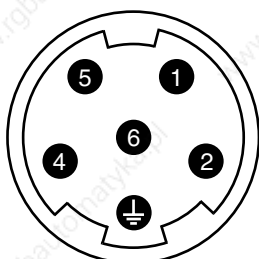

NOTE:
Connectors
viewed from
customer side

SUPPLY CONNECTOR (OPTION)

PIN	FUNCTION
U	MOTOR U
V	MOTOR V
1	-
2	-
+	BRAKE B+ (IF FITTED)
-	BRAKE B- (IF FITTED)
W	MOTOR W
⊥	MOTOR EARTH ⊥

SUPPLY CONNECTOR (OPTION)

PIN	FUNCTION
1	MOTOR U
2	MOTOR V
4	BRAKE B+ (IF FITTED)
5	BRAKE B- (IF FITTED)
6	MOTOR W
⊥	MOTOR EARTH ⊥

4

4

CONNECTION DETAILS

HR BRUSHLESS MOTOR FITTED WITH TAMAGAWA 01H35 OR 01H48 ENCODER

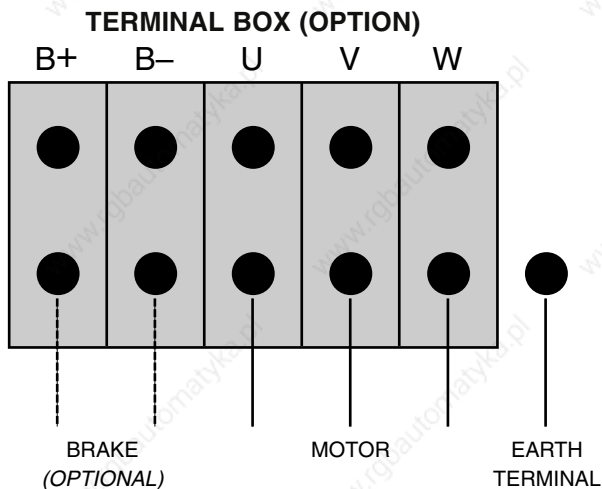

SUPPLY CONNECTOR (OPTION)

PIN	FUNCTION
A	MOTOR U
B	MOTOR V
C	BRAKE B+ IF FITTED
D	BRAKE B- IF FITTED
E	MOTOR EARTH \perp
F	MOTOR W
G	

FEEDBACK CONNECTOR

PIN	FUNCTION
A	A CHANNEL
B	W CHANNEL
C	\bar{A} CHANNEL
D	\bar{W} CHANNEL
E	B CHANNEL
F	\bar{B} CHANNEL
G	Z CHANNEL
H	\bar{Z} CHANNEL
J	GROUND
K	\bar{U} CHANNEL
L	V CHANNEL
M	U CHANNEL
N	DC +5V
P	\bar{V} CHANNEL
R	
S	THERMAL SENSOR K1
T	THERMAL SENSOR K2

FRAMES 90 & 115 – MS3102E-20-15P

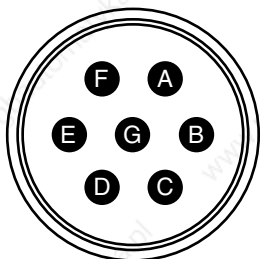

FRAME 142 & 190 – MS3102E-24-10P

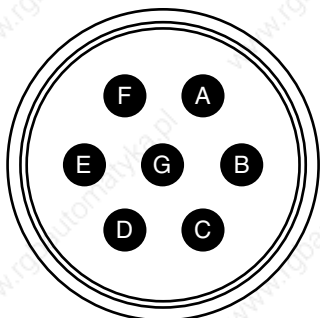

MS3102E-20-29P

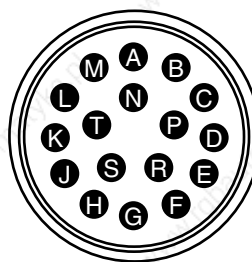

NOTE:
Connectors
viewed from
customer side

CONNECTION DETAILS

BRUSHLESS MOTOR WITH AC BRUSHLESS TACHO

TERMINAL BOX (OPTION)

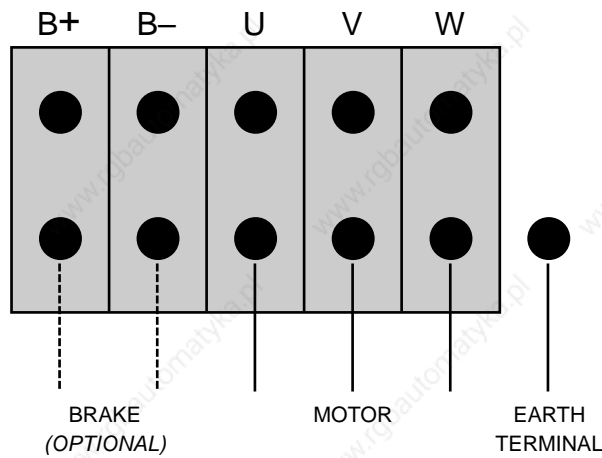

SUPPLY CONNECTOR (OPTION)

PIN	FUNCTION
A	MOTOR U
B	MOTOR V
C	BRAKE B+ IF FITTED
D	BRAKE B- IF FITTED
E	MOTOR EARTH \perp
F	MOTOR W
G	

FEEDBACK CONNECTOR

PIN	FUNCTION
A	
B	POSN. SIGNAL B (OPEN COIL)
C	TACHO PHASE TU
D	TACHO PHASE TV
E	TACHO PHASE TW
F	
G	
H	
J	POWER 0V
K	
L	POSN. SIGNAL NOT A (OPEN COLL.)
M	POSN. SIGNAL NOT C (OPEN COLL.)
N	
P	TACHO NEUTRAL TN
R	POWER +15V (50mA)
S	THERMAL SENSOR K1
T	THERMAL SENSOR K2

FRAMES 92 & 115 – MS3102E-20-15P

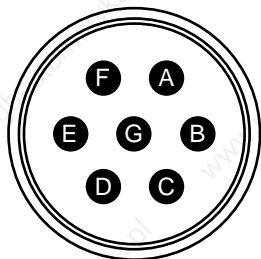

FRAME 142 – MS3102E-24-10P

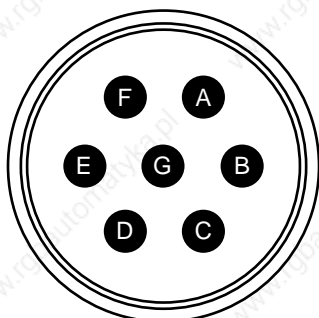

MS3102E-20-29P

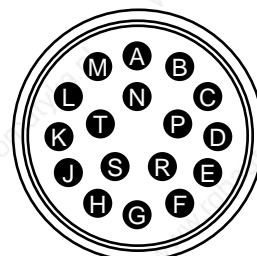

NOTE:
Connectors
viewed from
customer side

CONNECTION DETAILS

BRUSHLESS MOTOR WITH DC BRUSHLESS TACHO

TERMINAL BOX (OPTION)

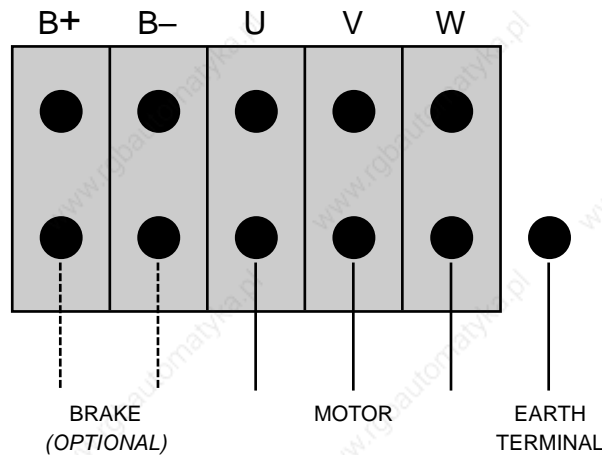

SUPPLY CONNECTOR (OPTION)

PIN	FUNCTION
A	MOTOR U
B	MOTOR V
C	BRAKE B+ IF FITTED
D	BRAKE B- IF FITTED
E	MOTOR EARTH \perp
F	MOTOR W
G	

FEEDBACK CONNECTOR

PIN	FUNCTION
A	POSITION SIGNAL A
B	POSITION SIGNAL B
C	POSITION SIGNAL C
D	TACHO OUTPUT T1
E	
F	POSITION SIGNAL NOT B
G	
H	
J	POWER 0V
K	POWER -15V
L	POSITION SIGNAL NOT A
M	POSITION SIGNAL NOT C
N	
P	TACHO OUTPUT TO
R	POWER +15V
S	THERMAL SENSOR K1
T	THERMAL SENSOR K2

FRAMES 92 & 115 – MS3102E-20-15P

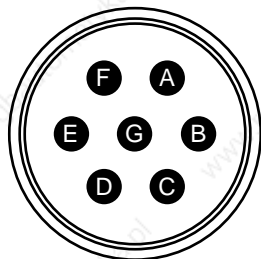

FRAME 142 – MS3102E-24-10P

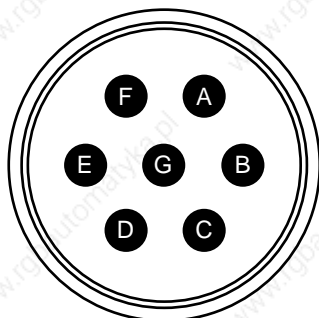

MS3102E-20-29P

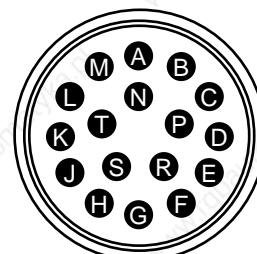

NOTE:
Connectors
viewed from
customer side

FEEDBACK DEVICE SPECIFICATION

SPECIFICATION FOR RESOLVER SIZE 15

Fitted to SEM HR55 and HR70 motors

Configuration: 2 pole (1speed), brushless resolver.

Input to single phase rotor.

Output from 2 phase stator

Connections and output equation: *see drawing*

DATA	Primary Side	R1-R2	
	Pole Pairs	1	
	Transformation Ratio	0.5 ± 0.05	
	Input Voltage	7V _{rms}	7V _{rms}
	Input Current	58mA	36mA
	Input Frequency	5 kHz	10kHz
	Phase Shift (± 3°)	8°	-6°
	Impedance		
	Zro	75 j 98 Ohm	110 j 159 Ohm
	Zso	180 j 230 Ohm	245 j 400 Ohm
	Zss	170 j 200 Ohm	216 j 370 Ohm
	DC resistances		
	Rotor	40 Ohm ± 10%	
	Stator	102 Ohm ± 10%	
	Null Voltage	30 mV max	
Accuracy	± 10'		
Approved resolver	LTN RE15-1-B04		

5

5

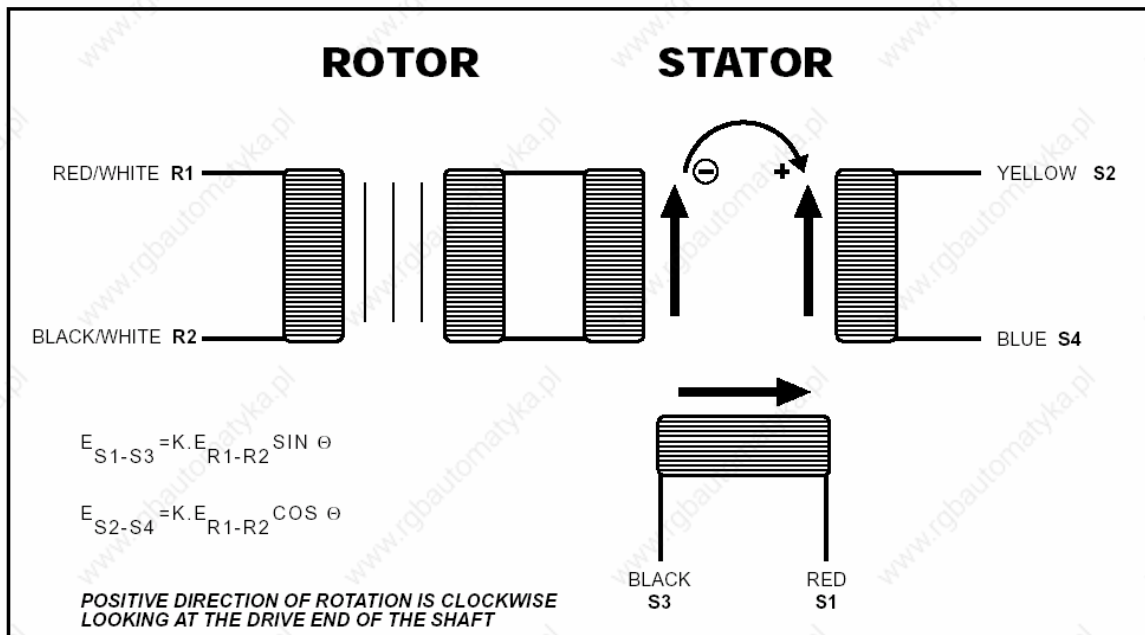

FEEDBACK DEVICE SPECIFICATION

SPECIFICATION FOR RESOLVER SIZE 21

Fitted to SEM HR92, 115, 142 and 190 motors

Configuration: 2 pole (1speed), brushless resolver.

Input to single phase rotor.

Output from 2 phase stator

Connections and output equation: see drawing

DATA		LTN	Tamagawa
		RE21-1-A05	TS2640N321E64
	Primary Side	R1-R2	R1-R2
	Pole Pairs	1	1
	Transformation Ratio	0.5 ± 0.05	0.5 ± 0.05
	Input Voltage	7V _{rms}	7V _{rms}
	Input Current	30mA	40mA
	Input Frequency	10kHz	10KHz
	Phase Shift (± 3°)	-8°	+1°
	Impedance		
	Z _{ro}	122 j 203 Ohm	100 j 140 Ohm
	Z _{so}	245 j 454 Ohm	140 j 270 Ohm
	Z _{ss}	202 j 415 Ohm	120 j 240 Ohm
	DC resistances		
	Rotor	56 Ohm ± 10%	36 Ohm ± 10%
	Stator	53 Ohm ± 10%	42 Ohm ± 10%
	Null Voltage	30 mV max	20 mV max
	Accuracy	± 6'	± 10'
	Approved resolver	LTN RE-21-1-A05	Tamagawa TS2640N321E64

5

5

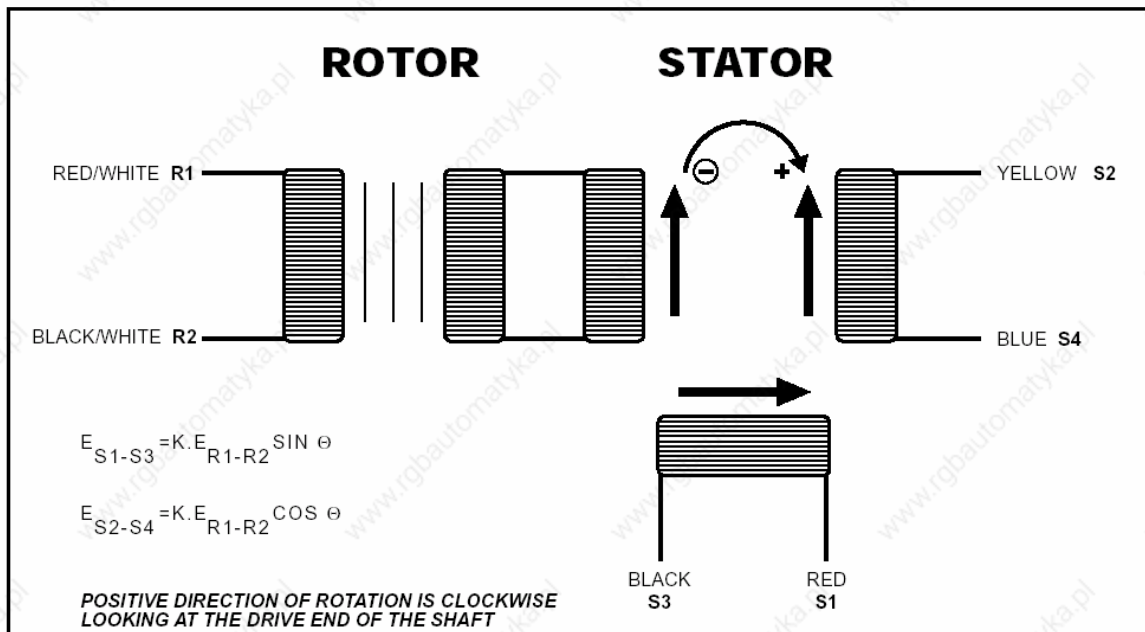

FEEDBACK DEVICE SPECIFICATION SEM'S STANDARD SETTINGS

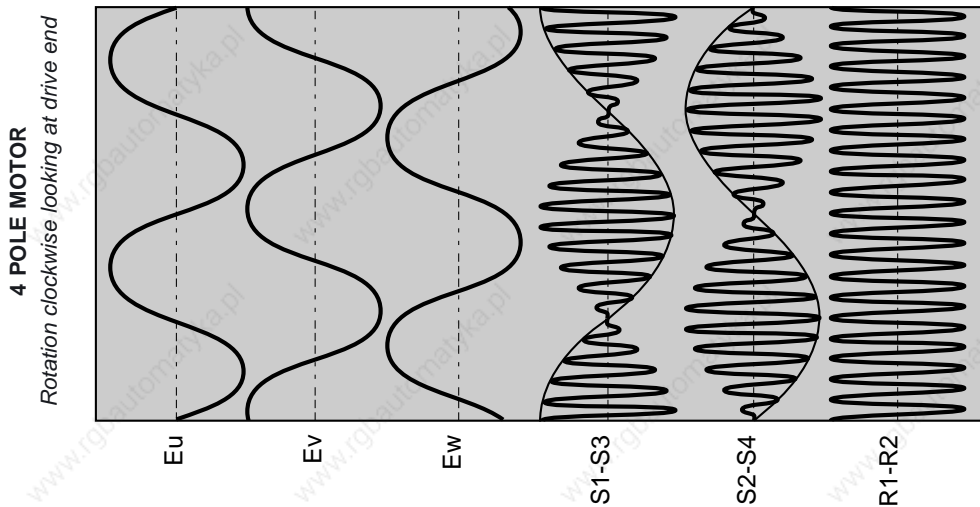
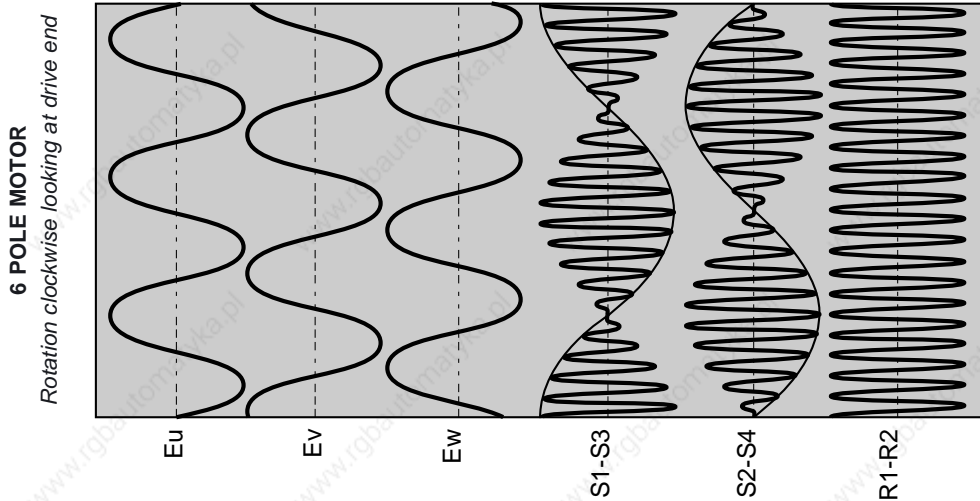
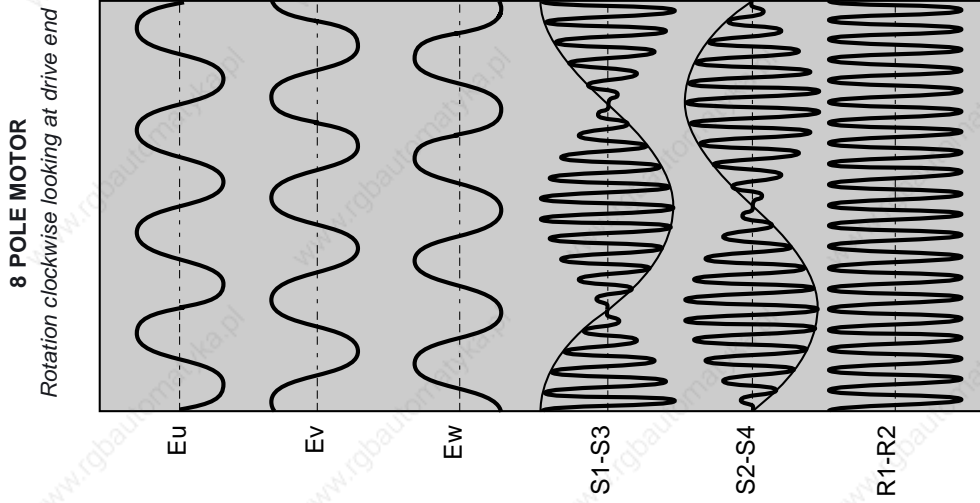

NOTES

- 1 Clockwise rotation means that the shaft rotates clockwise looking at the drive end of the shaft.
- 2 The EMFs (Eu, Ev, Ew) are phase EMFs
- 3 For + VE current into the motor: Iu, in phase with Eu will give a clockwise torque (motoring)

FEEDBACK DEVICE SPECIFICATION

SEM'S STANDARD SETTING FOR OIH35/OIH48 ENCODER

(Note that some customers specify alternative settings)

Rotation clockwise looking at drive end

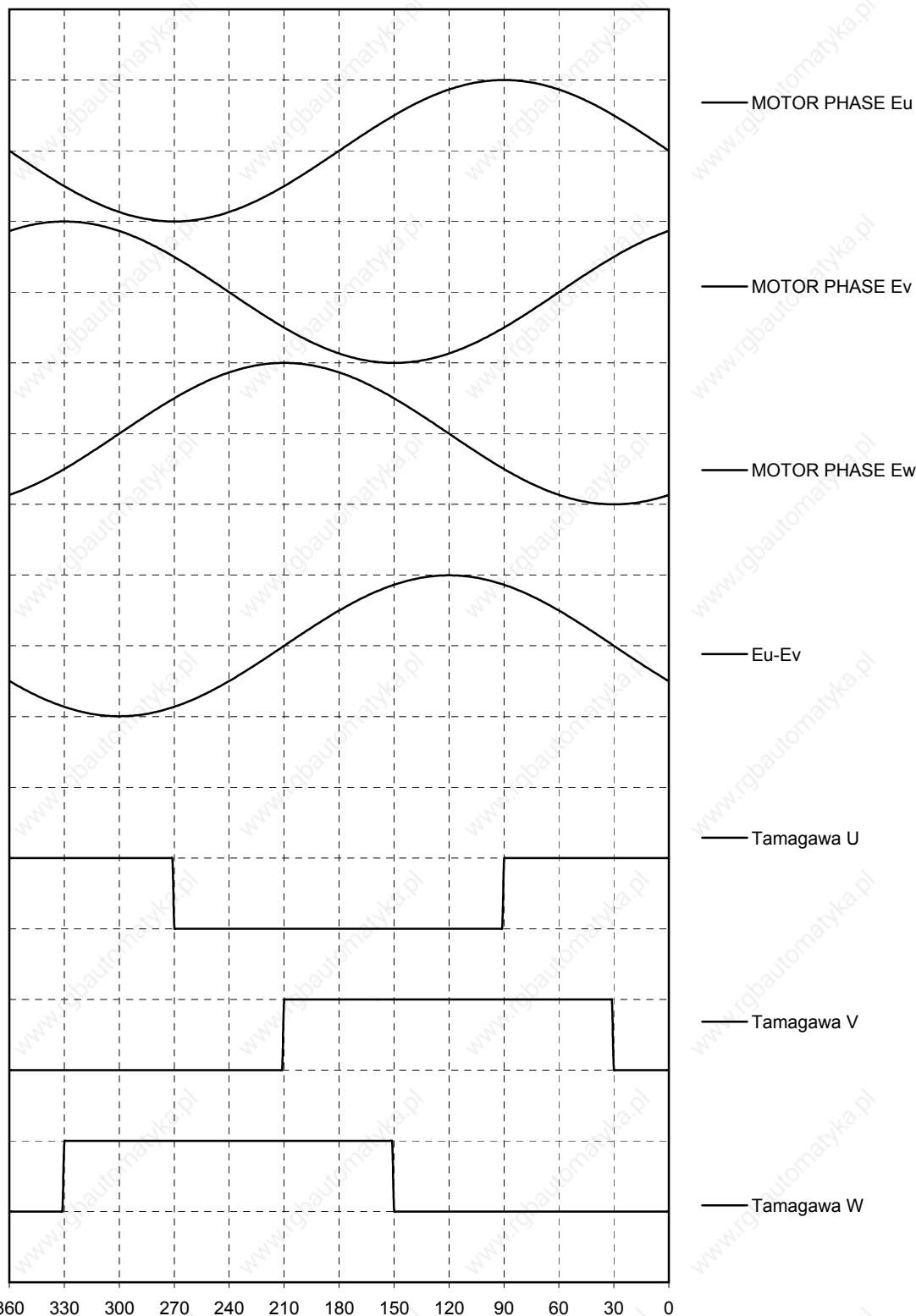

NOTES

- 1 Clockwise rotation means that the shaft rotates clockwise looking at the drive end of the shaft.
- 2 The EMFs (Eu, Ev, Ew) are phase EMFs
- 3 For + VE current into the motor: I_u , in phase with Eu will give a clockwise torque (motoring)

FEEDBACK DEVICE SPECIFICATION STANDARD BRUSHLESS AC TACHO CONNECTIONS

POWER FOR POSITION SENSORS

MS CONNECTOR PINS

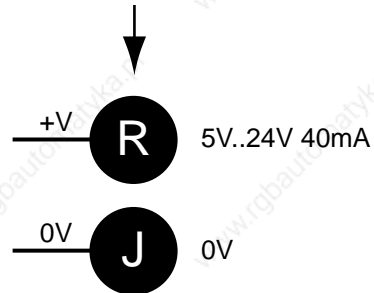

POSITION SENSORS

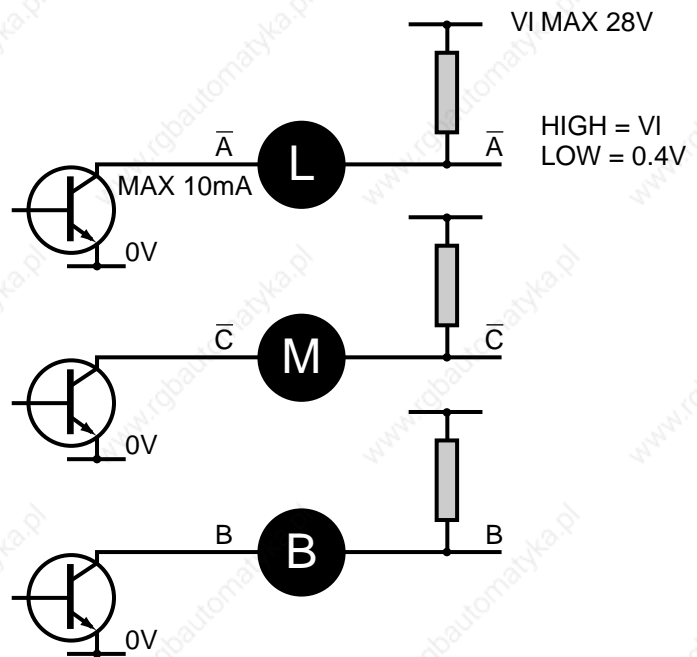

TACHO WINDINGS

POLES	6	4
emf (V/100rpm)	10	10
L (mH)	46	83
R (Ohm)	125	165

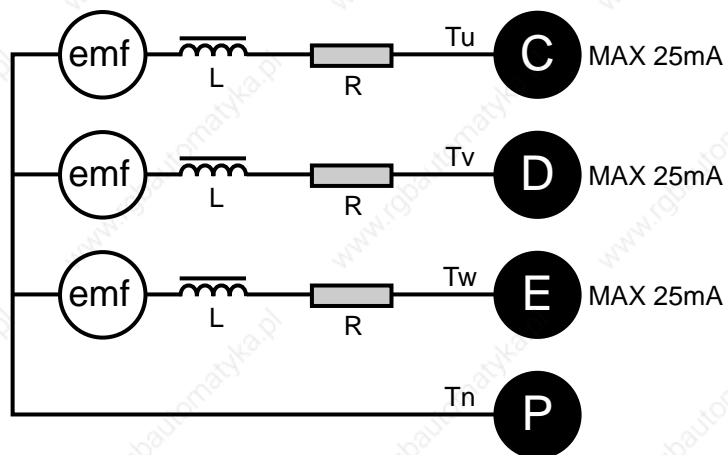

MOTOR OVERTEMPERATURE SENSOR

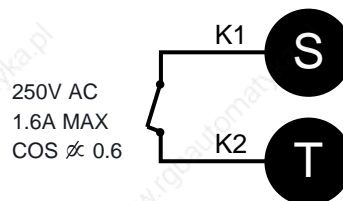

FEEDBACK DEVICE SPECIFICATION

STANDARD BRUSHLESS AC TACHO WAVEFORMS

Shown for motor rotation clockwise when looking on shaft end

TACHO WINDING EMFS

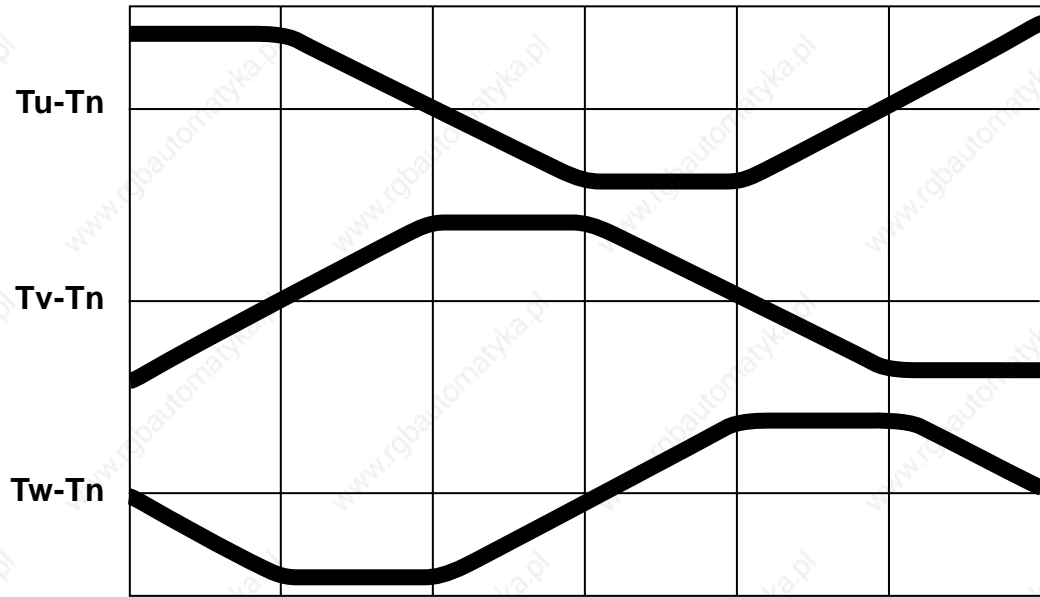

COMMUTATION SEQUENCE

+Tu	-Tw	+Tv	-Tu	+Tw	-Tv
------------	------------	------------	------------	------------	------------

POSITION SENSOR OUTPUT VOLTAGES (WHEN PULLED UP)

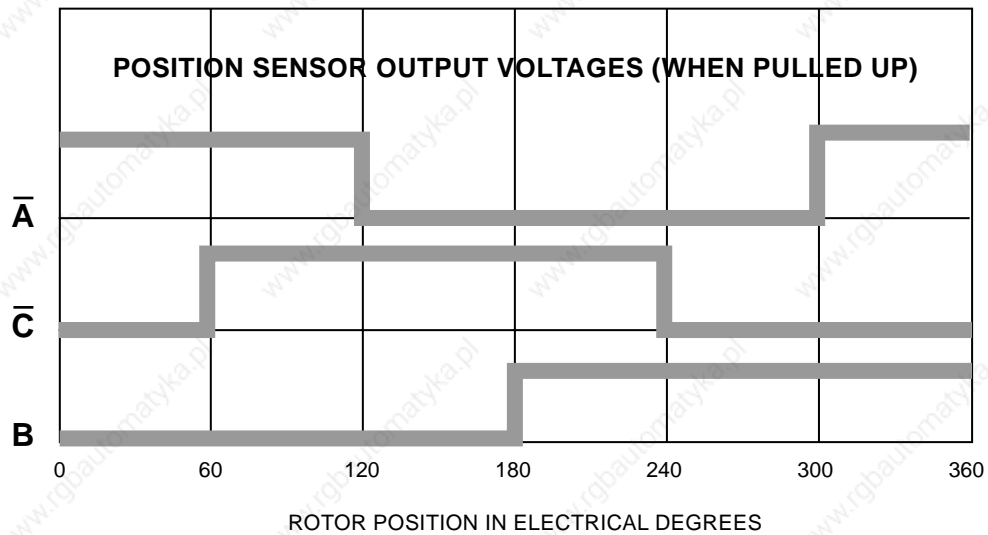

FEEDBACK DEVICE SPECIFICATION STANDARD BRUSHLESS T MOTOR WAVEFORMS

Shown for motor rotation clockwise when looking on shaft end

MOTOR WINDING EMFS

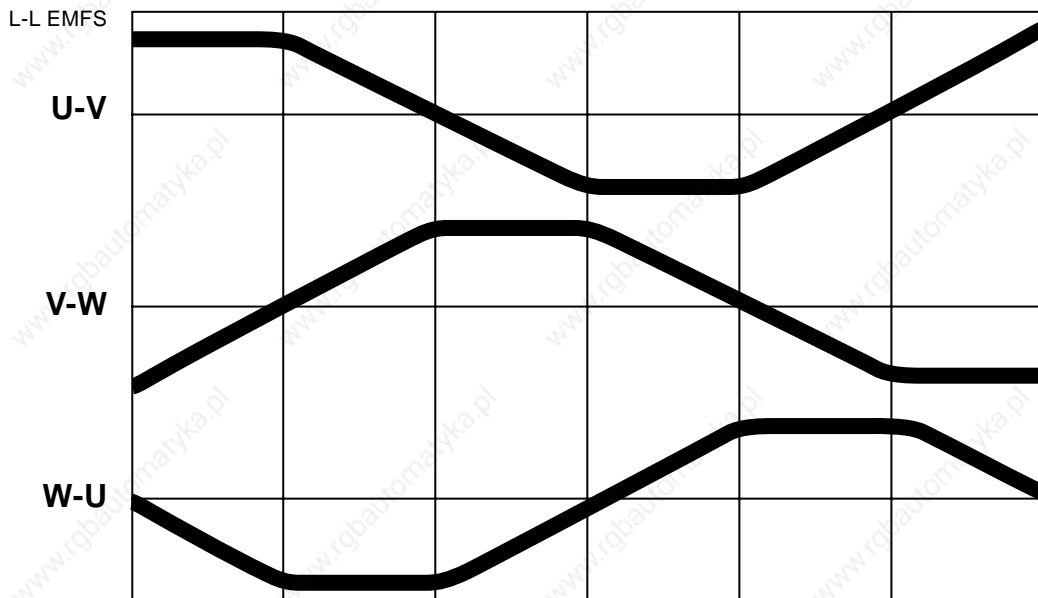

COMMUTATION
SEQUENCE

+U	+U	+V	+V	+W	+W
-V	-W	-W	-U	-U	-V

PHASE U EMF
AND CURRENT INTO U

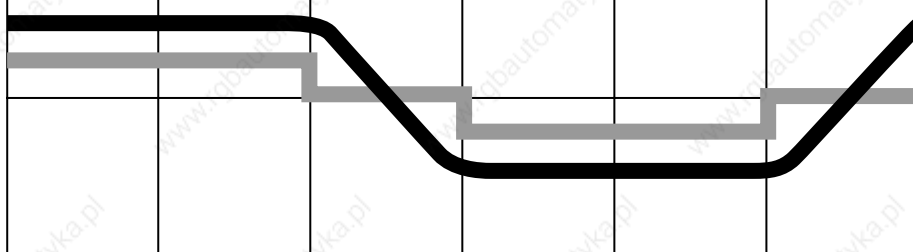

POSITION SENSOR OUTPUT VOLTAGES (WHEN PULLED UP)

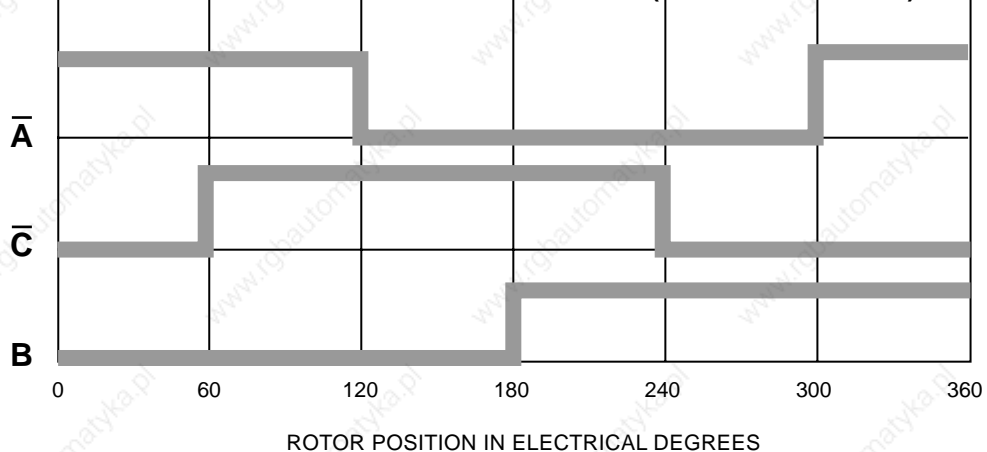

5

5

DERATING OF SEM MOTORS WITH NdFeB MAGNETS for unusual ambient temperatures

Note that the peak current must be reduced as well as the rated current

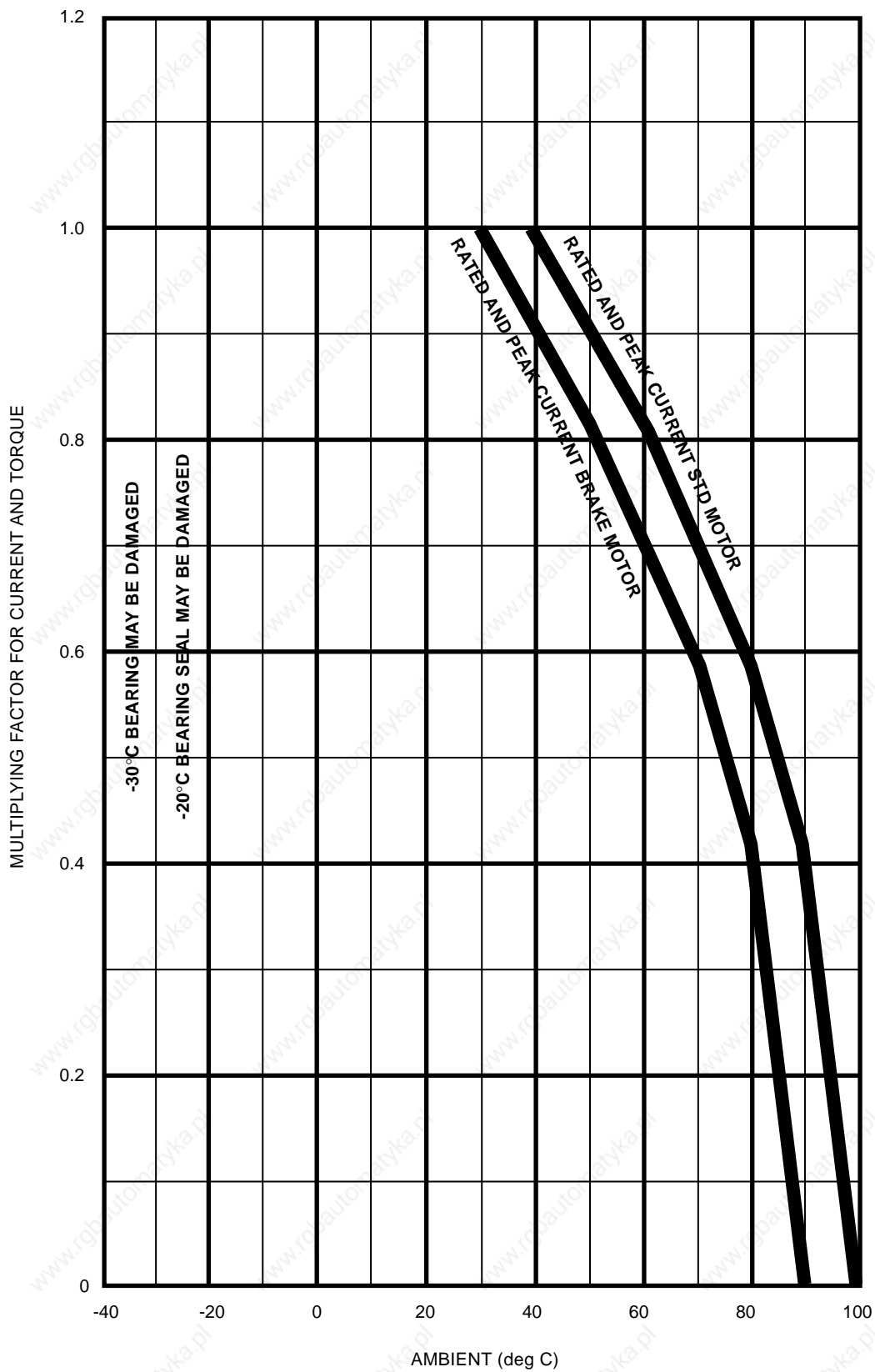

6

6

HR55A4

HR55C4

HR55G4

HR55

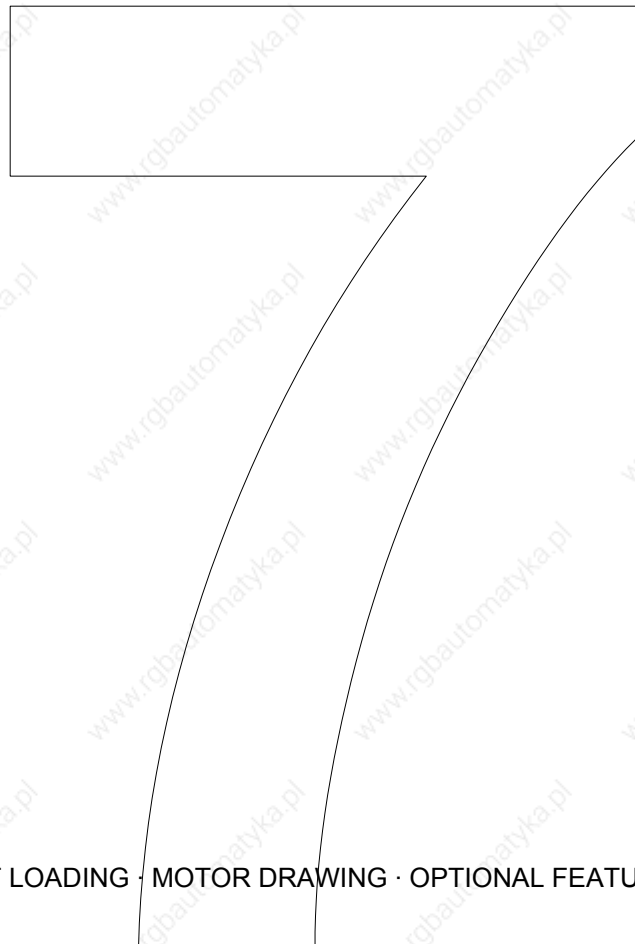

DATA TABLES · PERFORMANCE CURVES · SHAFT LOADING · MOTOR DRAWING · OPTIONAL FEATURES

HR55A4

Brushless DC/AC Servomotors

7

Technical Data

Parameter	Units	HR55A4-44	HR55A4-32	HR55A4-22
GENERAL				
Voltage Gradient No Load	Line-Line Volts (Peak)/1000RPM	44	32	22
Max. Motor EMF	Line - Line Volts	350	260	180
Max. Speed	RPM	8000	8000	8000
Insulation Class		F	F	F
Max. Ambient Temperature	°C (°F)	40 (104)	40 (104)	40 (104)
Thermal Time Constant	Minutes	15	15	15
Static Friction Torque	Nm lb-in	0.0015 0.0133	0.0015 0.0133	0.0015 0.0133
Peak Stall Torque	Nm (lb-in)	0.74 (6.5)	0.74 (6.5)	0.74 (6.5)
Continuous Stall Current rms ^ψ	Amps	0.39	0.53	0.78
Rotor Polar Moment of Inertia (Inclusive of Resolver Inertia)	kgcm ² lb-in sec ²	0.14 0.00012	0.14 0.00012	0.14 0.00012
Maximum Current (Peak)	Amp	2.3	3.1	4.5
Continuous Stall Torque TENV (110K) ^ψ	Nm (lb-in)	0.2 (1.8)	0.2 (1.8)	0.2 (1.8)
Cogging Torque (No shaft seal fitted)	Nm lb - in	0.0125 0.111	0.0125 0.111	0.0125 0.111
Torque Constant Kt_{rms}^{*†}	Nm/Amp lb-in/Amp	0.51 4.5	0.375 3.3	0.258 2.28
(Size 150 x 150 x 6 mm) Cont. Stall Torque when fitted to Heatsink (Size 6 x 6 x 0.25 in)	Nm lb-in	0.22 1.9	0.22 1.9	0.22 1.9
STATOR WINDING				
Resistance Line-Line*	Ohms	112	59	29
Inductance Line-Line	MilliHenrys	67	36	17
Thermal Resistance	°C/Watt °F/Watt	2.8 5.9	2.8 5.9	2.8 5.9
Motor Weight	kg (lb)	1.2 (2.6)	1.2 (2.6)	1.2 (2.6)

Notes

- Tolerance** - All data is subject to a tolerance of ±10% (except motor 'Voltage Gradient' and Kt which are to +15%/-5%).
- *** - At 25°C.
- †** - Note that Kt is shown as a combined value for all **three phases**.
- ψ** - The temperature rise ΔT on the windings is 110K and applies to all continuous torque values. The maximum ambient temperature is 40°C and therefore the temperature on the windings should not be more than 150°C. A value higher than 150°C would exceed the class F insulation temperature specification.

7

7

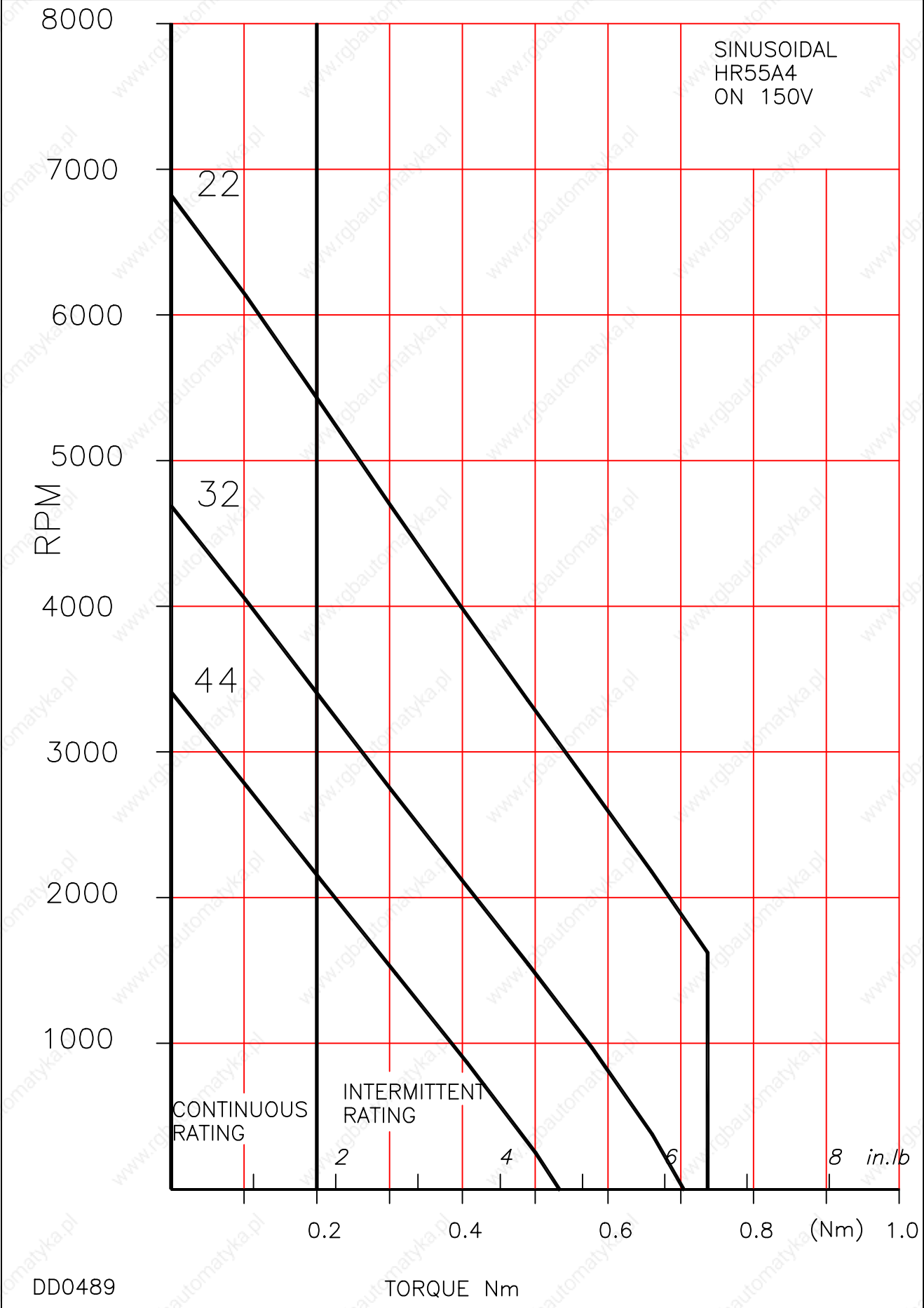

DD0489

TORQUE Nm

SINUSOIDAL
HR55A4
ON 150V

CONTINUOUS
RATING

INTERMITTENT
RATING

2

4

6

8 *in.lb*

0.2

0.4

0.6

0.8

(Nm) 1.0

7

7

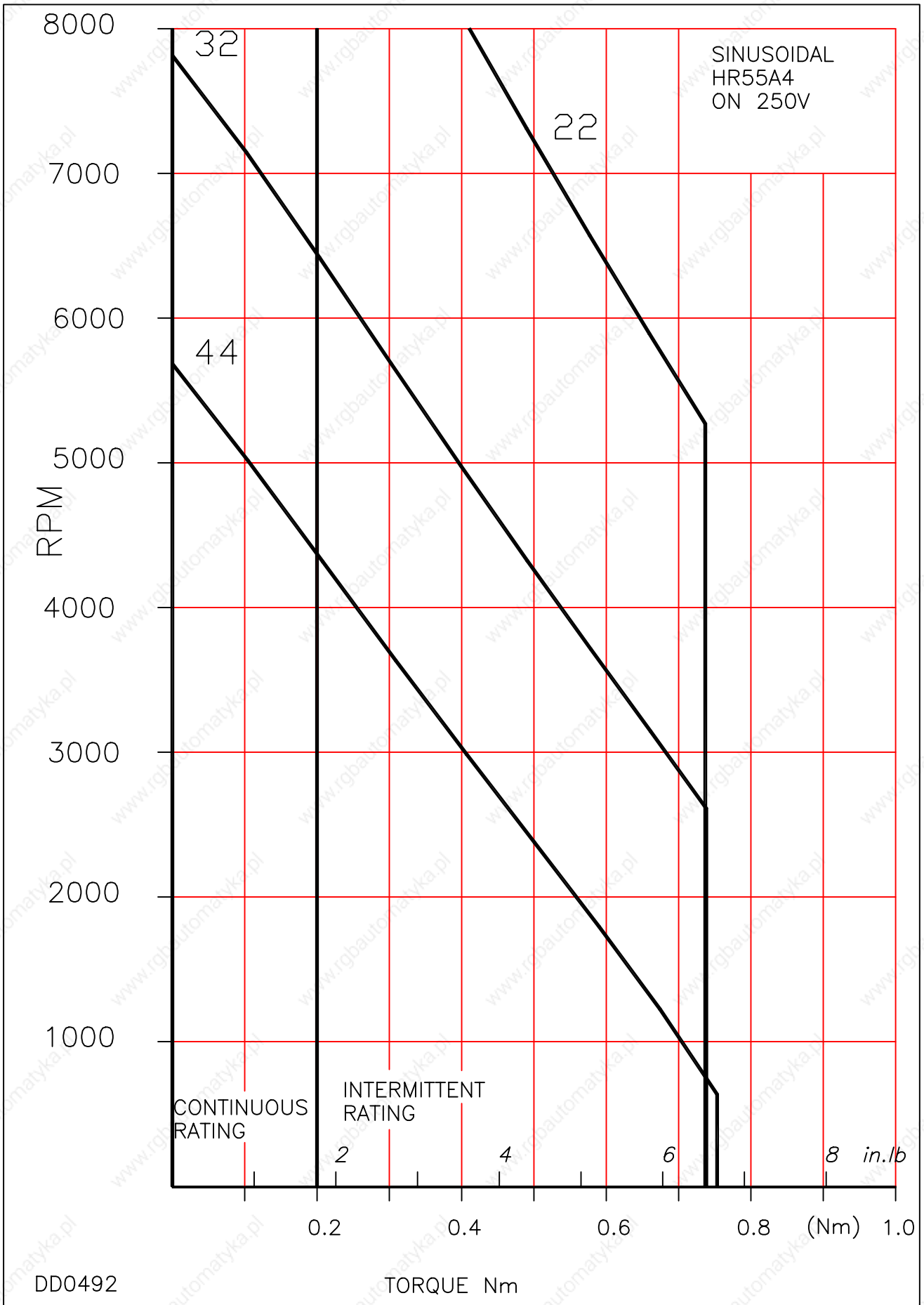

7

7

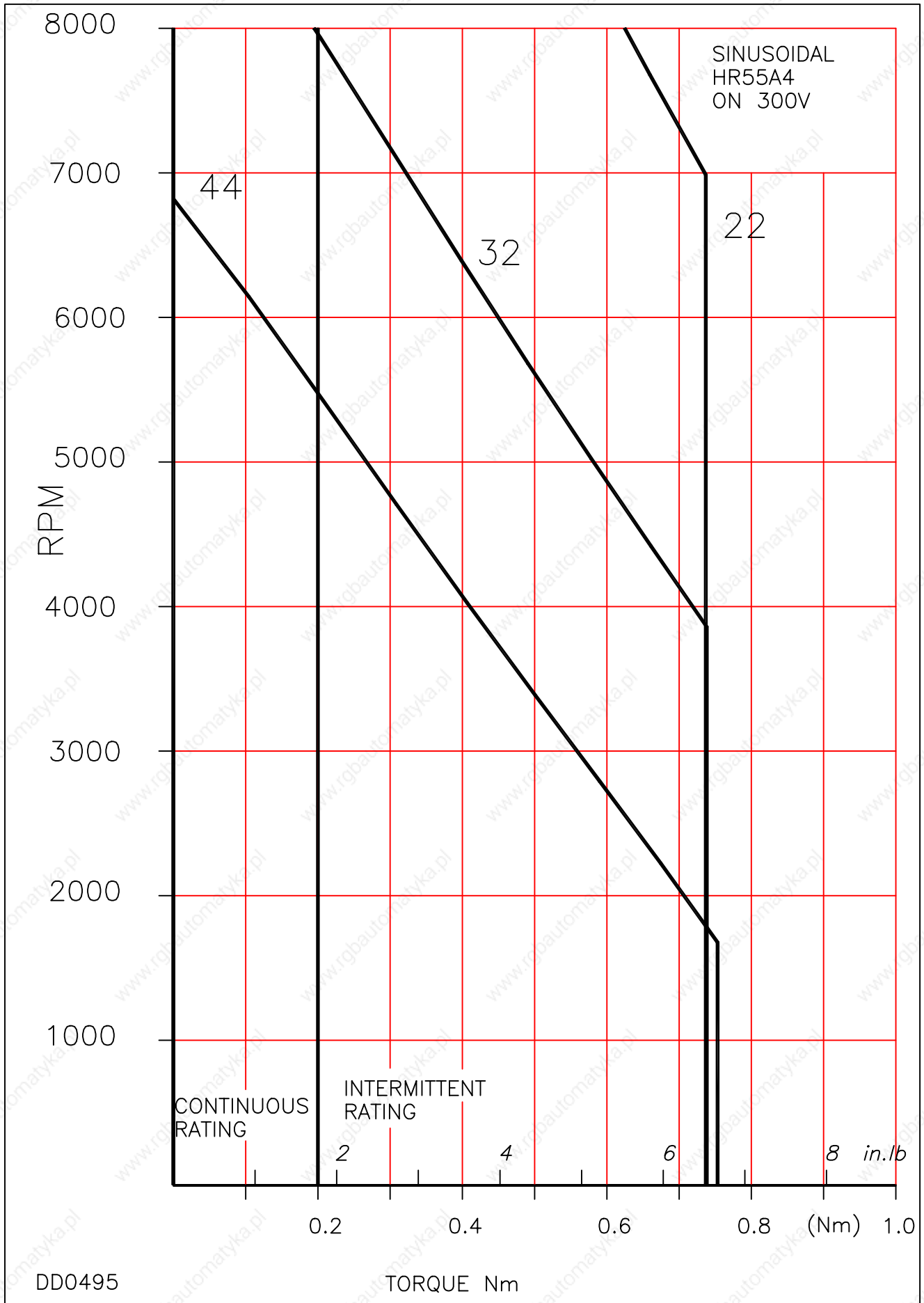

7

7

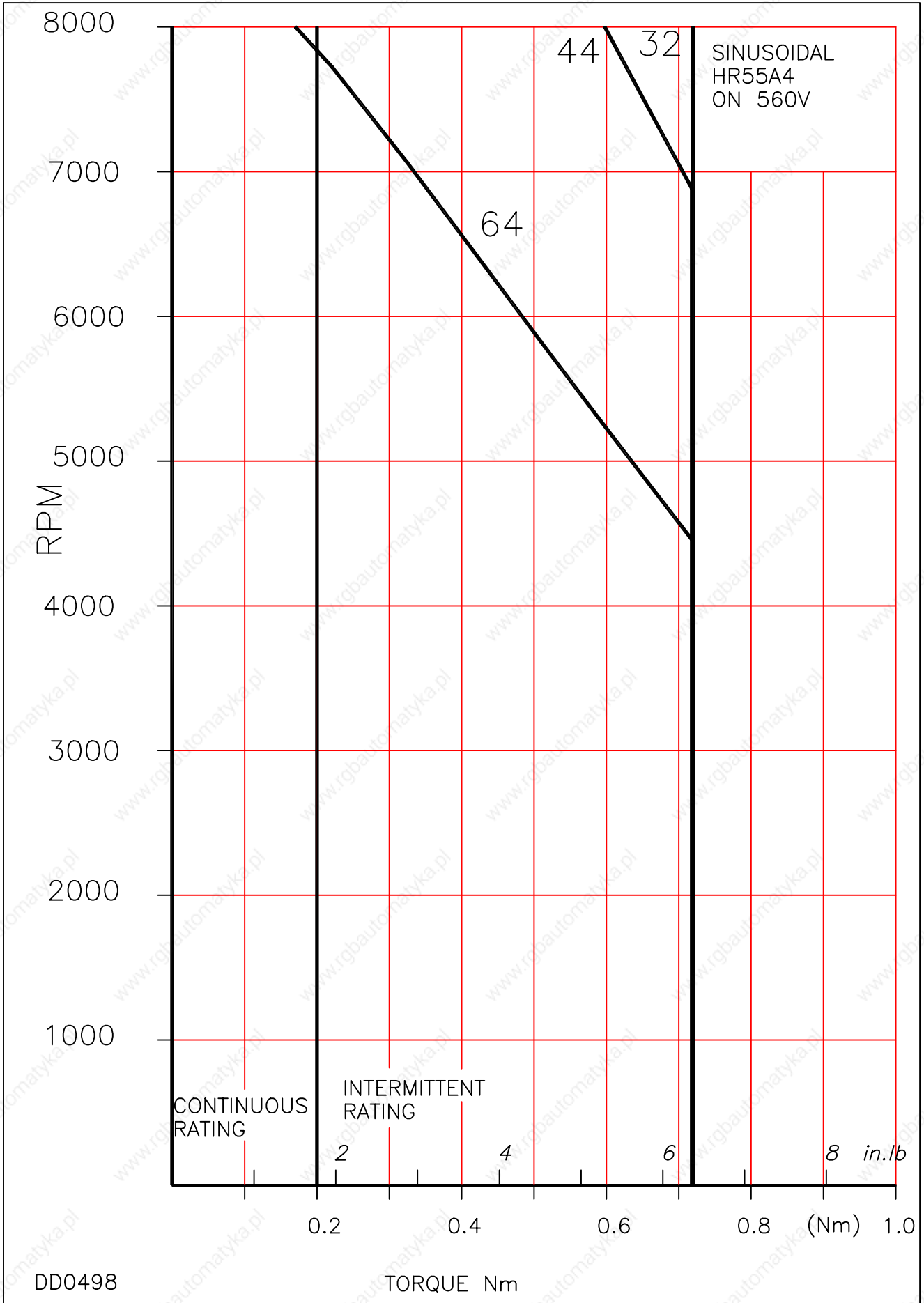

7

7

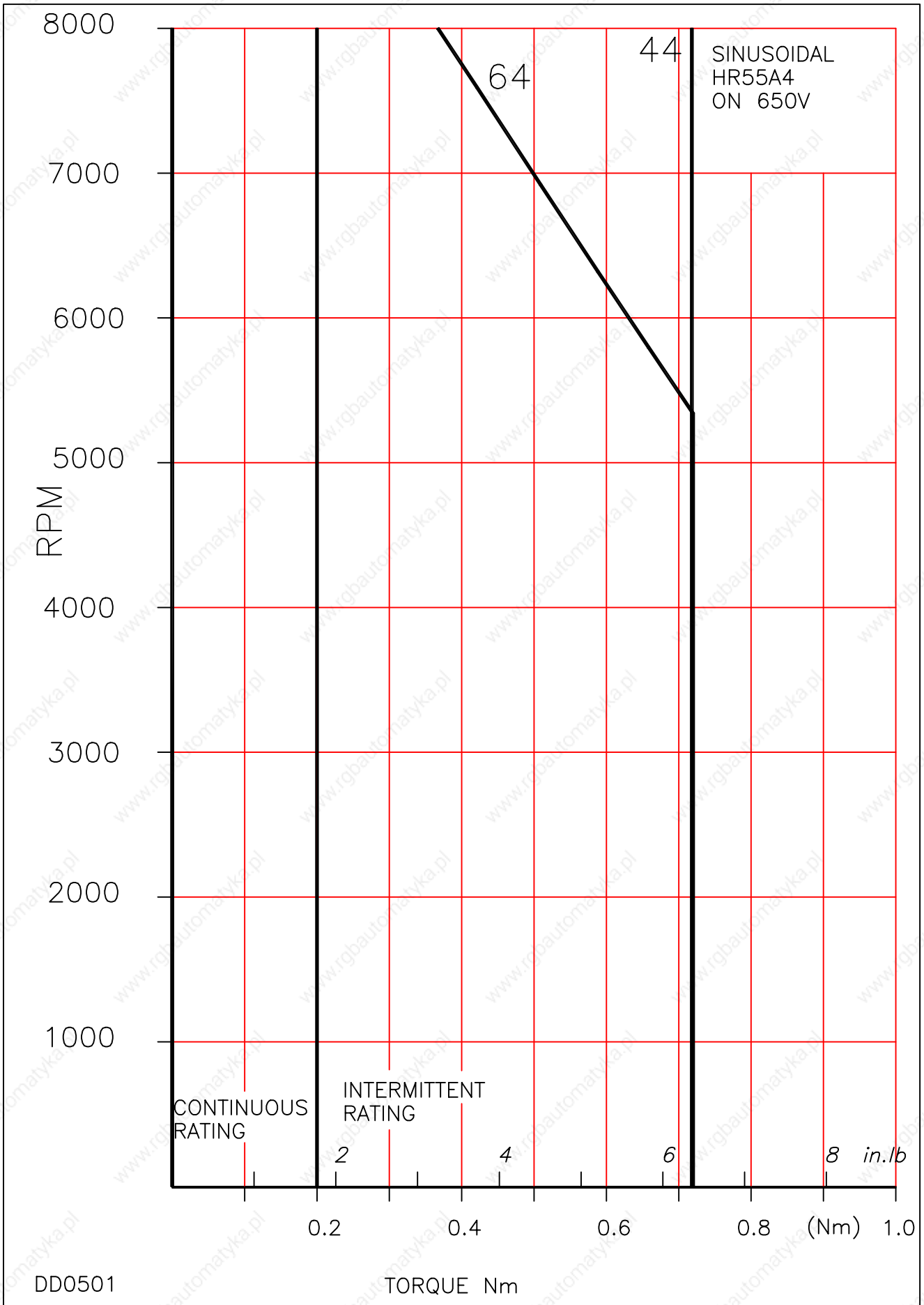

HR55C4

Brushless DC/AC Servomotors

7

Technical Data

Parameter	Units	HR55C4-44	HR55C4-32	HR55C4-22
GENERAL				
Voltage Gradient No Load	Line-Line Volts (Peak)/1000RPM	44	32	22
Max. Motor EMF	Line - Line Volts	350	260	180
Max. Speed	RPM	8000	8000	8000
Insulation Class		F	F	F
Max. Ambient Temperature	°C (°F)	40 (104)	40 (104)	40 (104)
Thermal Time Constant	Minutes	20	20	20
Static Friction Torque	Nm lb-in	0.0015 0.0133	0.0015 0.0133	0.0015 0.0133
Peak Stall Torque	Nm (lb-in)	1.4 (12.7)	1.4 (12.7)	1.4 (12.7)
Continuous Stall Current rms ^ψ	Amps	0.78	1.07	1.6
Rotor Polar Moment of Inertia (Inclusive of Resolver Inertia)	kgcm ² lb-in sec ²	0.19 0.00017	0.19 0.00017	0.19 0.00017
Maximum Current (Peak)	Amp	4.4	6.1	8.7
Continuous Stall Torque TENV (110K)^ψ	Nm (lb-in)	0.4 (3.5)	0.4 (3.5)	0.4 (3.5)
Cogging Torque (No shaft seal fitted)	Nm lb - in	0.0175 0.15	0.0175 0.15	0.0175 0.15
Torque Constant Kt_{rms}^{*†}	Nm/Amp lb-in/Amp	0.51 4.5	0.375 3.3	0.258 2.28
(Size 150 x 150 x 6 mm) Cont. Stall Torque when fitted to Heatsink (Size 6 x 6 x 0.25 in)	Nm lb-in	0.44 3.9	0.44 3.9	0.44 3.9
STATOR WINDING				
Resistance Line-Line*	Ohms	39	20	9.8
Inductance Line-Line	MilliHenrys	33	17	8.4
Thermal Resistance	°C/Watt °F/Watt	2.3 4.8	2.3 4.8	2.3 4.8
Motor Weight	kg (lb)	1.4 (3.1)	1.4 (3.1)	1.4 (3.1)

Notes

- Tolerance** - All data is subject to a tolerance of ±10% (except motor 'Voltage Gradient' and Kt which are to +15%/-5%).
- *** - At 25°C.
- †** - Note that Kt is shown as a combined value for all **three phases**.
- ψ** - The temperature rise ΔT on the windings is 110K and applies to all continuous torque values. The maximum ambient temperature is 40°C and therefore the temperature on the windings should not be more than 150°C. A value higher than 150°C would exceed the class F insulation temperature specification.

7

7

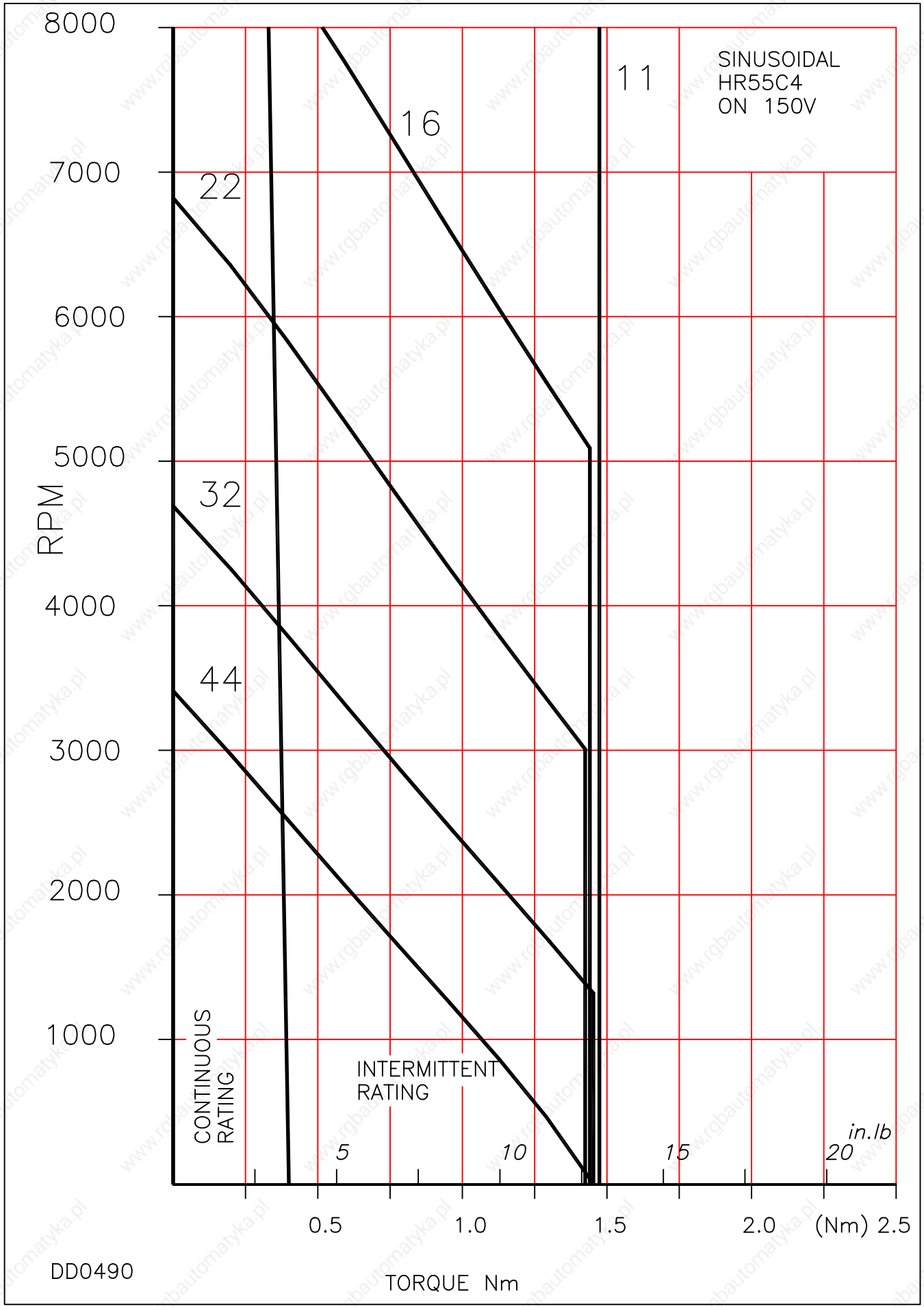

7

7

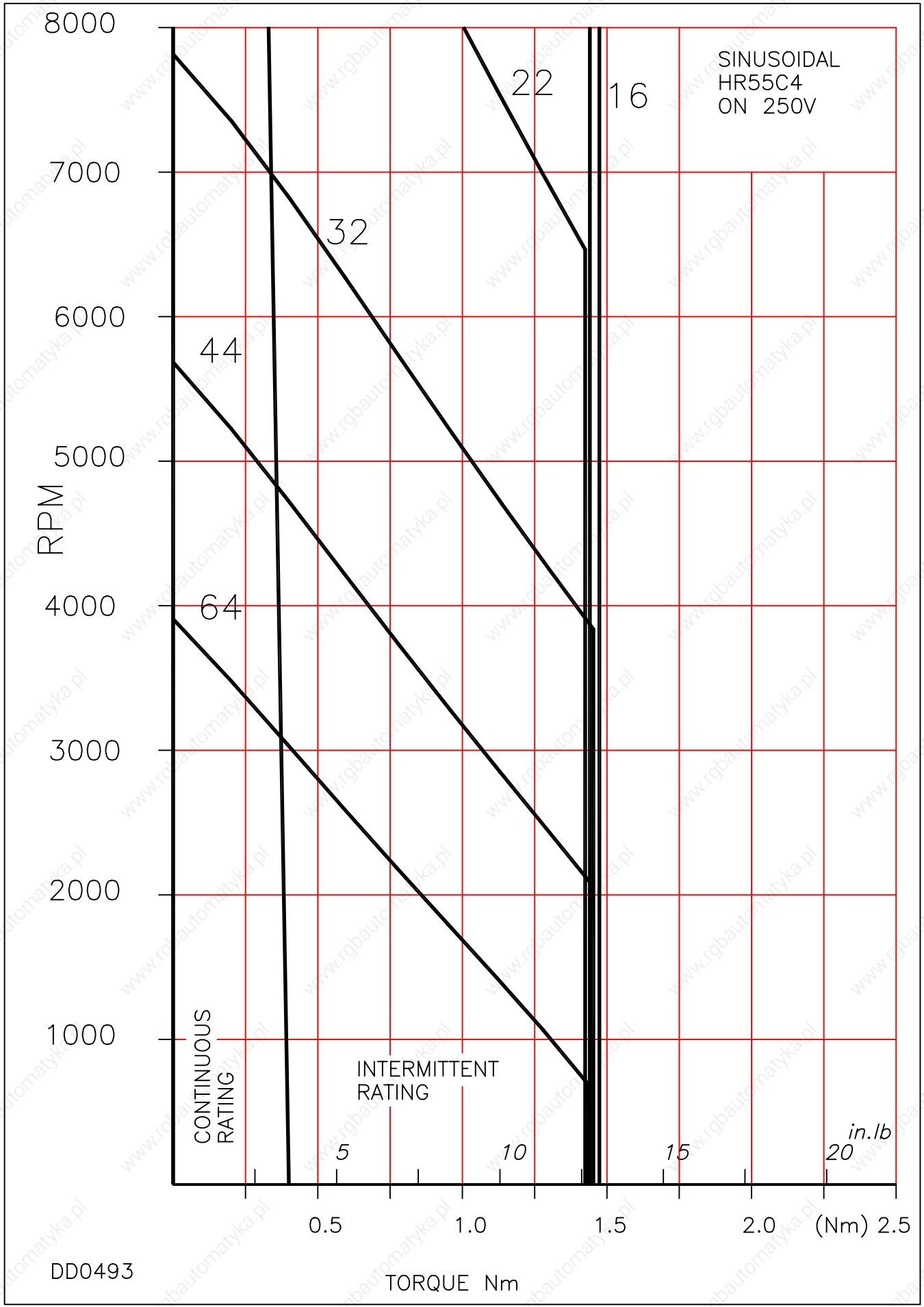

7

7

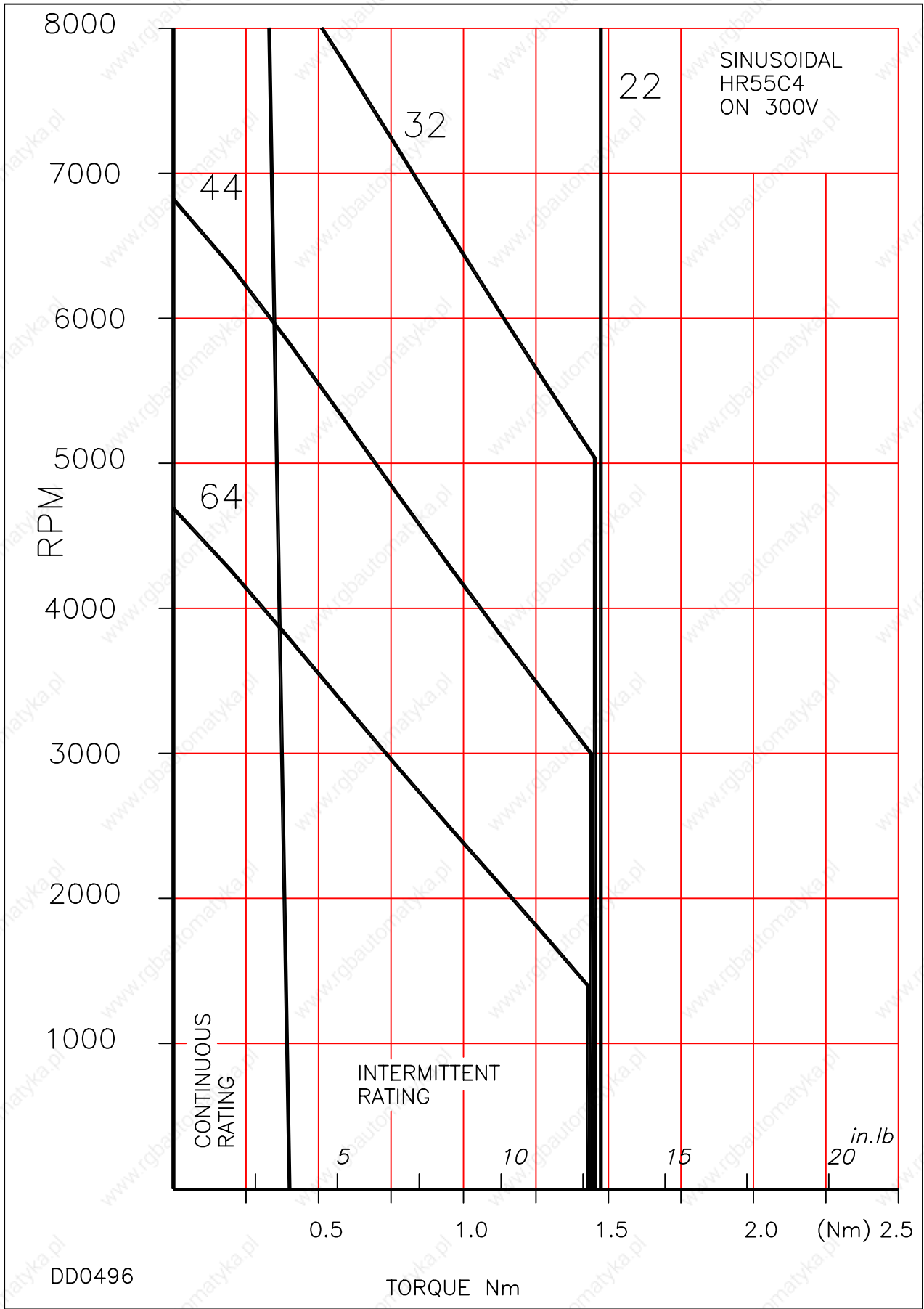

7

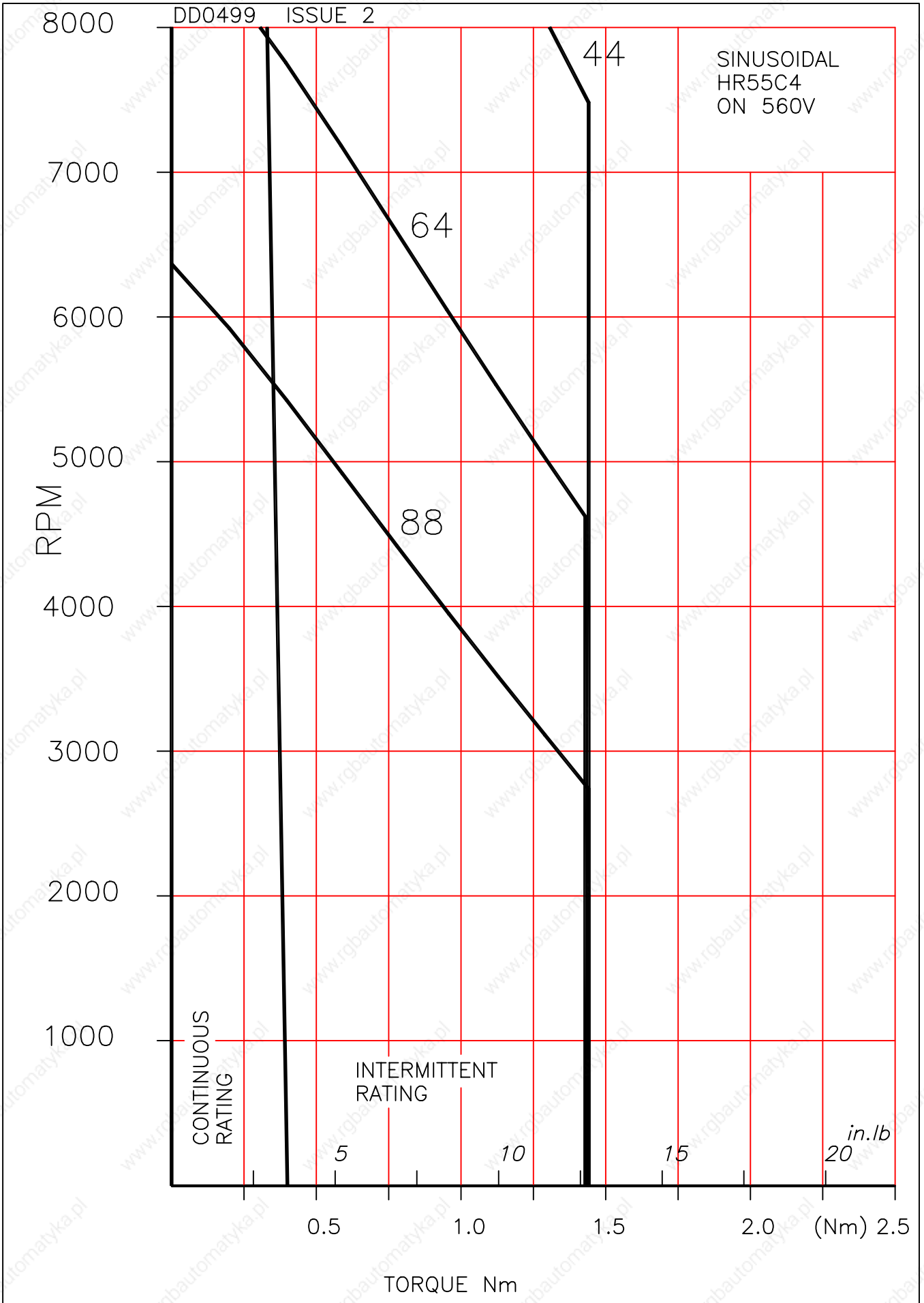

7

7

7

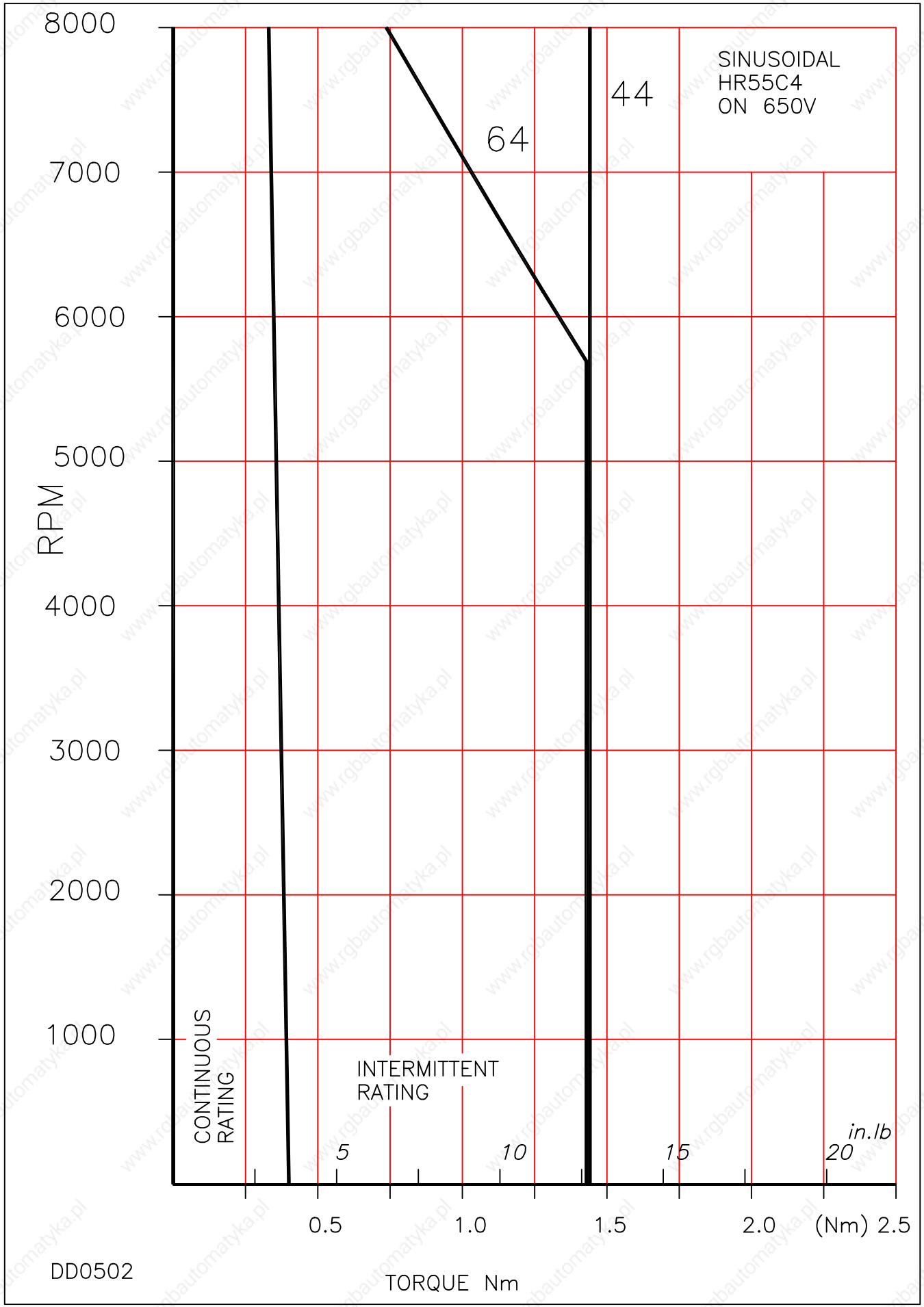

DD0502

TORQUE Nm

SINUSOIDAL
HR55C4
ON 650V

44

64

5

10

15

in.lb
20

(Nm) 2.5

HR55G4

Brushless DC/AC Servomotors

7

Technical Data

Parameter	Units	HR55G4-44	HR55G4-32	HR55G4-22
GENERAL				
Voltage Gradient No Load	Line-Line Volts (Peak)/1000RPM	44	32	22
Max. Motor EMF	Line - Line Volts	350	260	180
Max. Speed	RPM	8000	8000	8000
Insulation Class		F	F	F
Max. Ambient Temperature	°C (°F)	40 (104)	40 (104)	40 (104)
Thermal Time Constant	Minutes	25	25	25
Static Friction Torque	Nm lb-in	0.0015 0.0133	0.0015 0.0133	0.0015 0.0133
Peak Stall Torque	Nm (lb-in)	2.9 (26)	2.9 (26)	2.9 (26)
Continuous Stall Current rms ^ψ	Amps	1.6	2.1	3.1
Rotor Polar Moment of Inertia (Inclusive of Resolver Inertia)	kgcm ² lb-in sec ²	0.28 0.00025	0.28 0.00025	0.28 0.00025
Maximum Current (Peak)	Amp	8.7	12.1	18
Continuous Stall Torque TENV (110K)^ψ	Nm (lb-in)	0.8 (7.1)	0.8 (7.1)	0.8 (7.1)
Cogging Torque (No shaft seal fitted)	Nm lb - in	0.0295 0.26	0.0295 0.26	0.0295 0.26
Torque Constant Kt_{rms}^{*†}	Nm/Amp lb-in/Amp	0.51 4.5	0.375 3.3	0.258 2.28
(Size 150 x 150 x 6 mm)	Nm	0.85	0.85	0.85
Cont. Stall Torque when fitted to Heatsink (Size 6 x 6 x 0.25 in)	lb-in	7.5	7.5	7.5
STATOR WINDING				
Resistance Line-Line*	Ohms	15	7.3	3.6
Inductance Line-Line	MilliHenrys	15	7.8	3.6
Thermal Resistance	°C/Watt °F/Watt	1.4 3	1.4 3	1.4 3
Motor Weight	kg (lb)	1.9 (4.2)	1.9 (4.2)	1.9 (4.2)

Notes

Tolerance

- All data is subject to a tolerance of $\pm 10\%$ (except motor 'Voltage Gradient' and Kt which are to $+15\%/-5\%$).
- At 25°C.

†

- Note that Kt is shown as a combined value for all **three phases**.

ψ

- The temperature rise ΔT on the windings is 110K and applies to all continuous torque values. The maximum ambient temperature is 40°C and therefore the temperature on the windings should not be more than 150°C. A value higher than 150°C would exceed the class F insulation temperature specification.

7

7

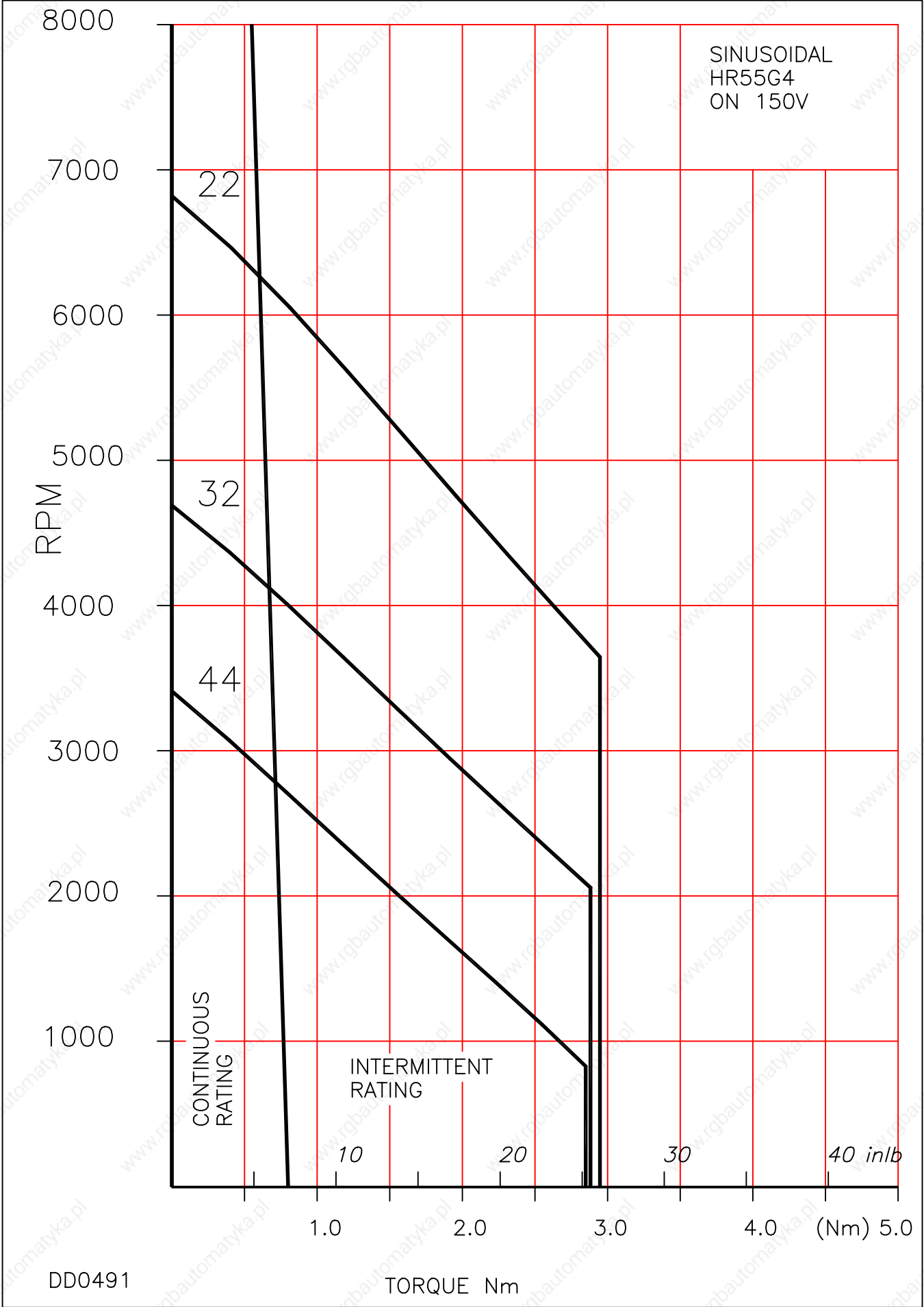

7

7

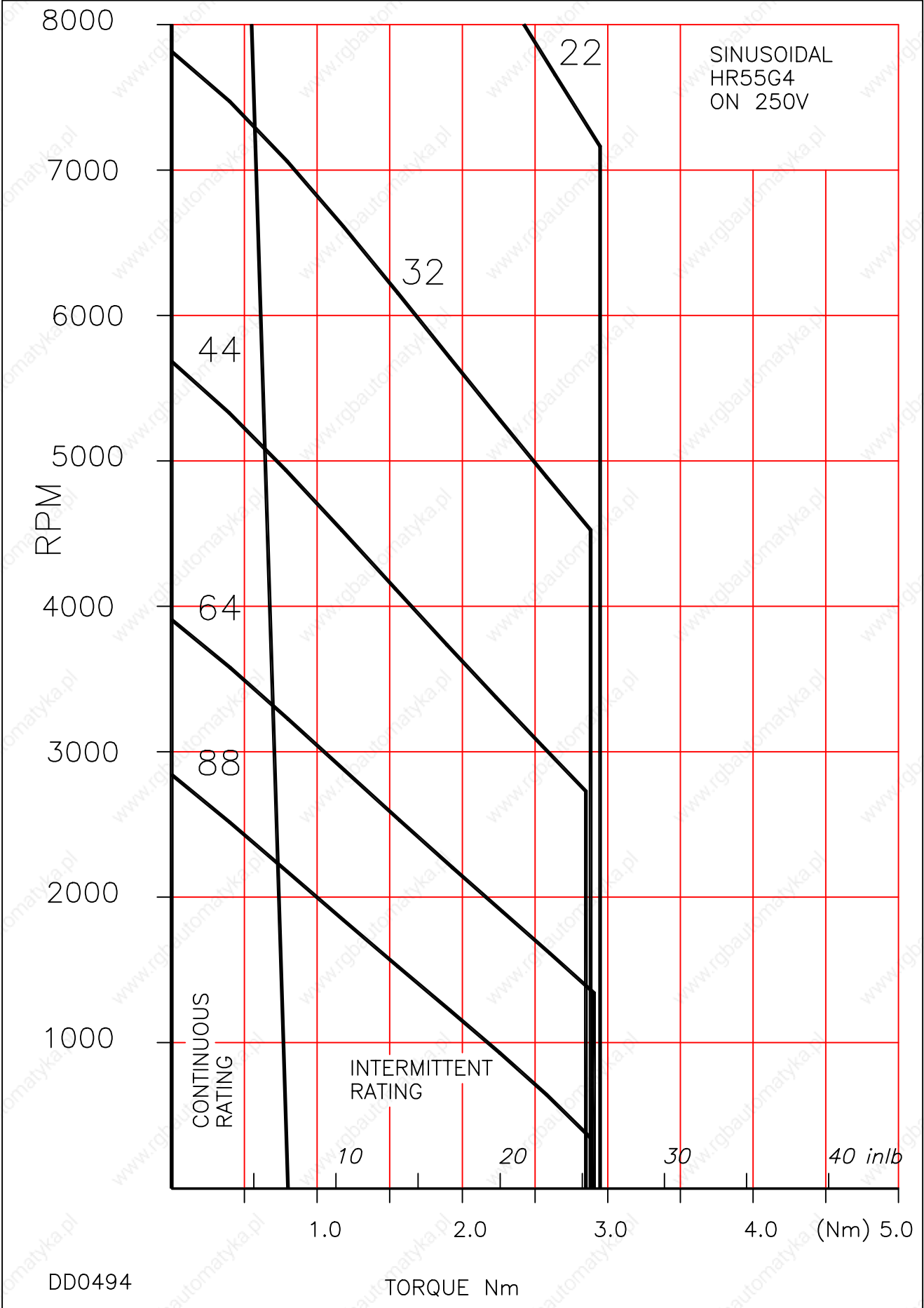

DD0494

TORQUE Nm

10

20

30

40 inlb

1.0

2.0

3.0

4.0

(Nm) 5.0

CONTINUOUS RATING

INTERMITTENT RATING

SINUSOIDAL
HR55G4
ON 250V

7

7

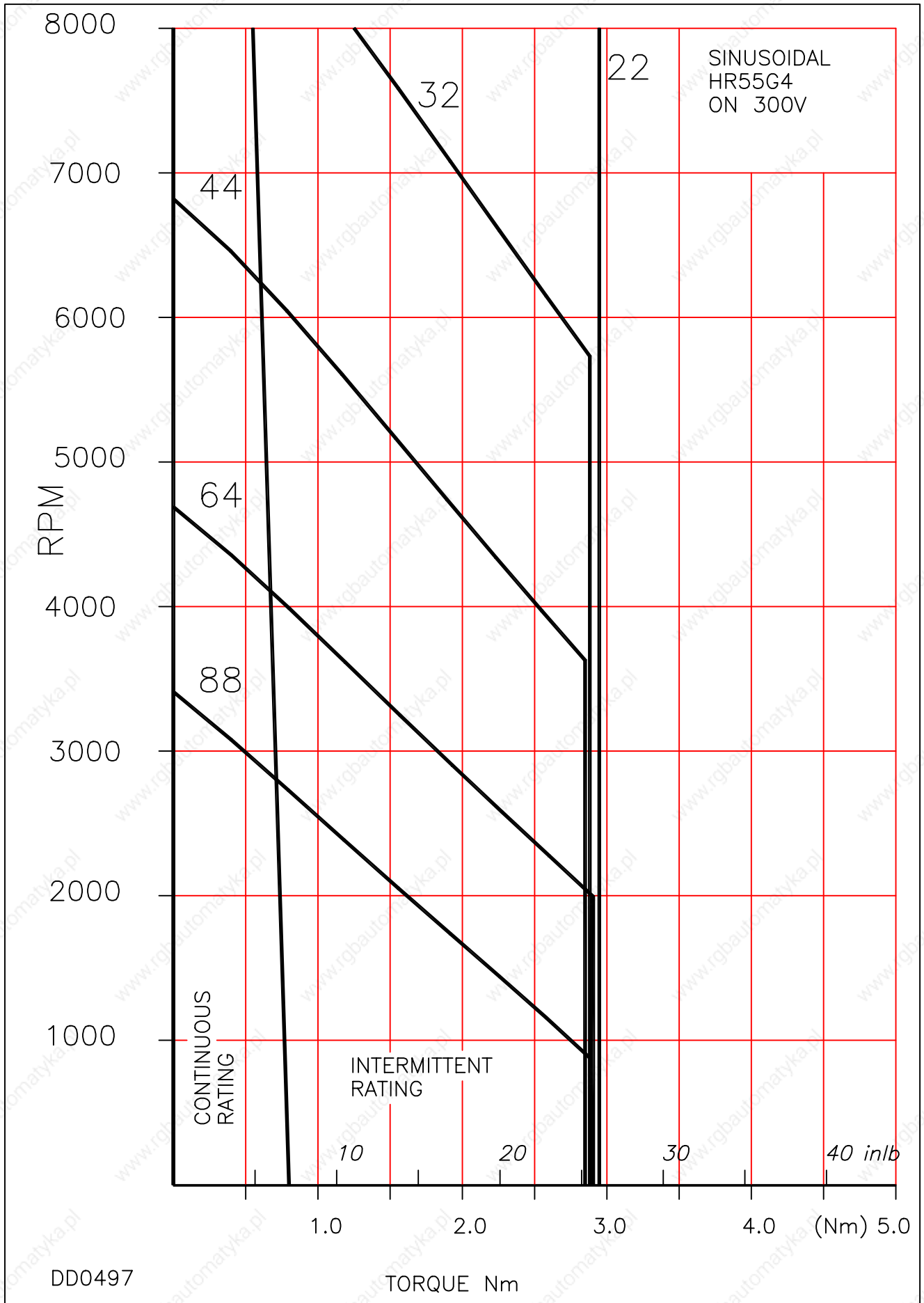

7

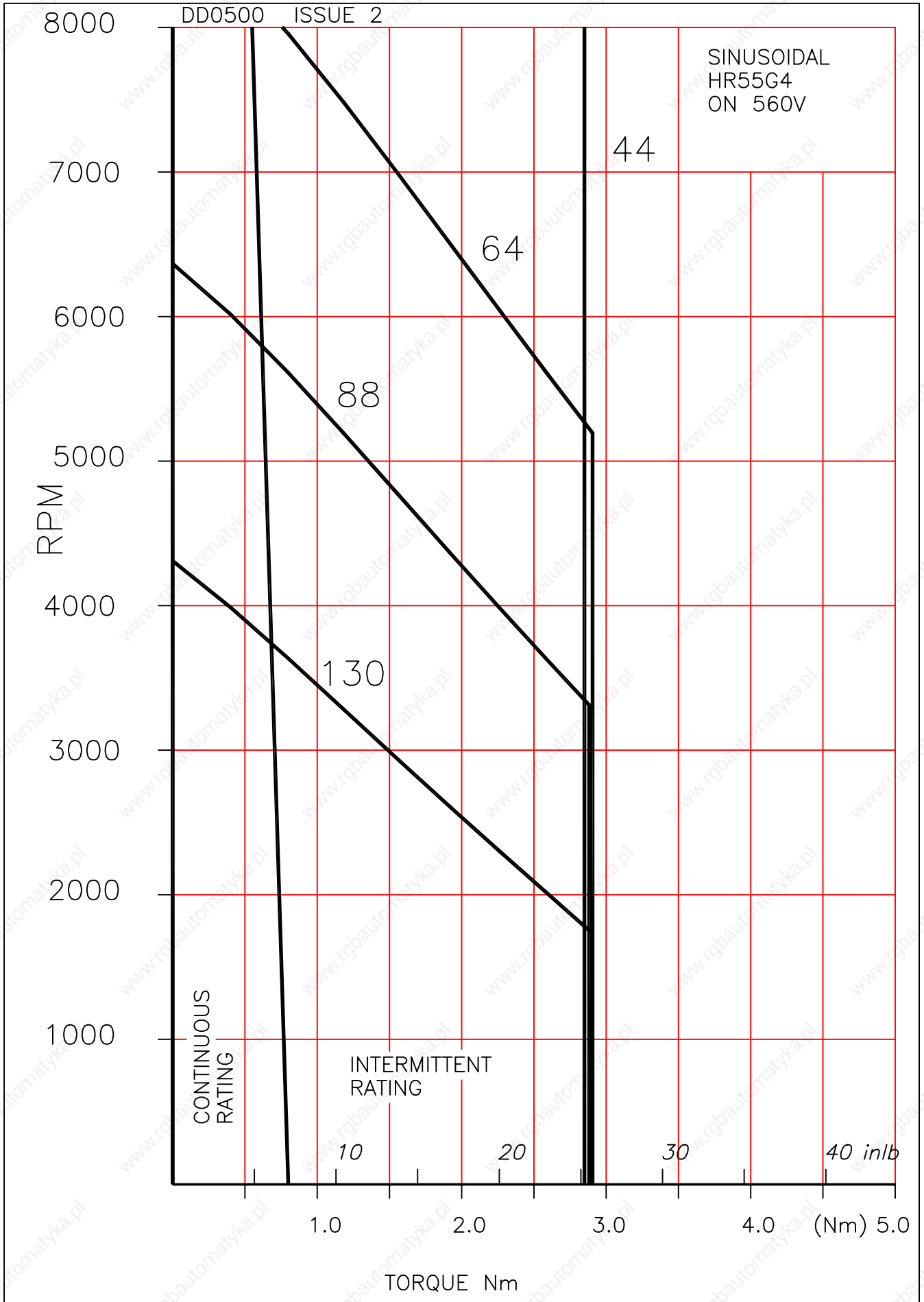

7

7

7

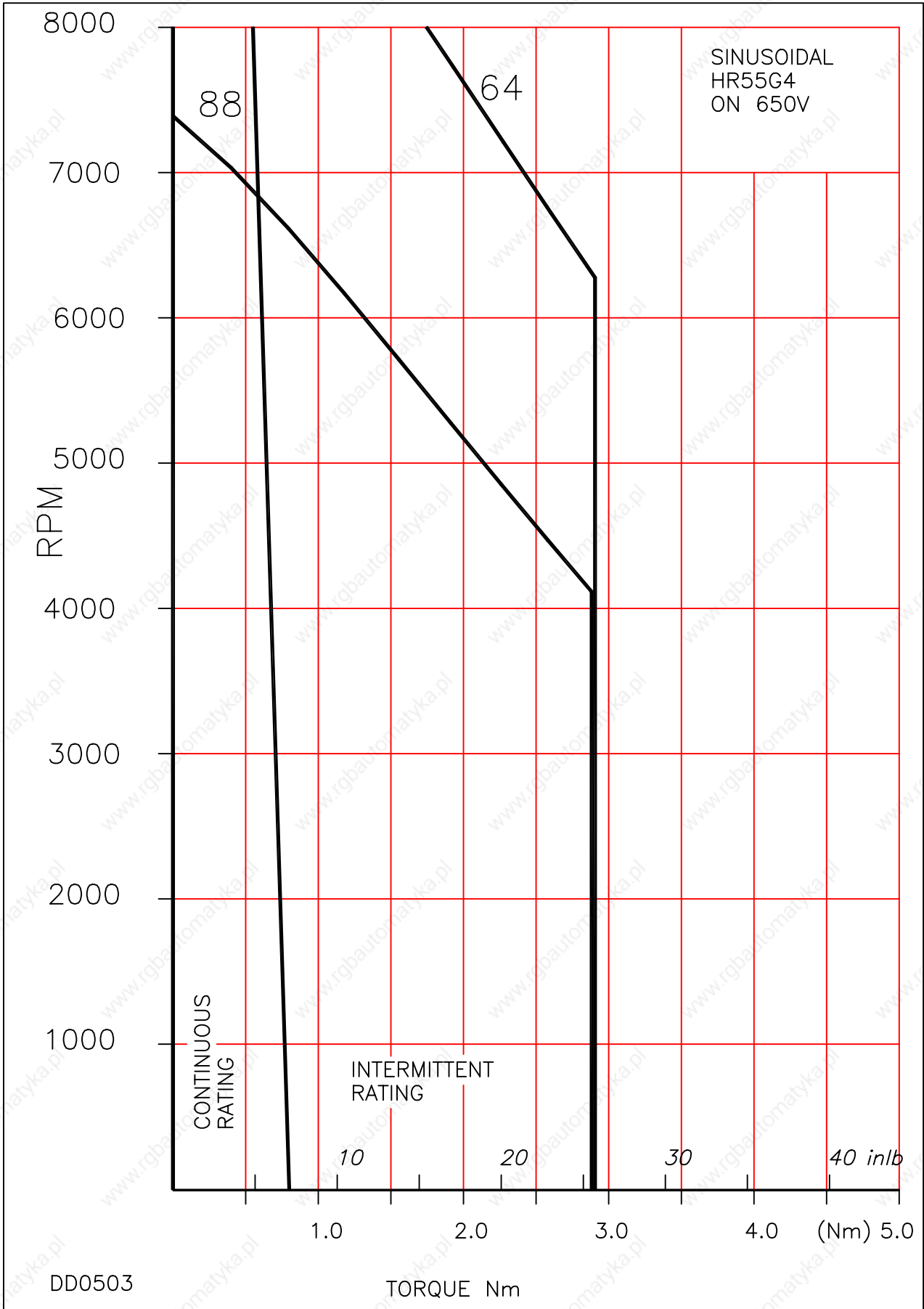

HR55 PERMITTED RADIAL SHAFT LOADINGS

(If axial loads are to be applied, the equivalent radial loading must be calculated as described on next page)

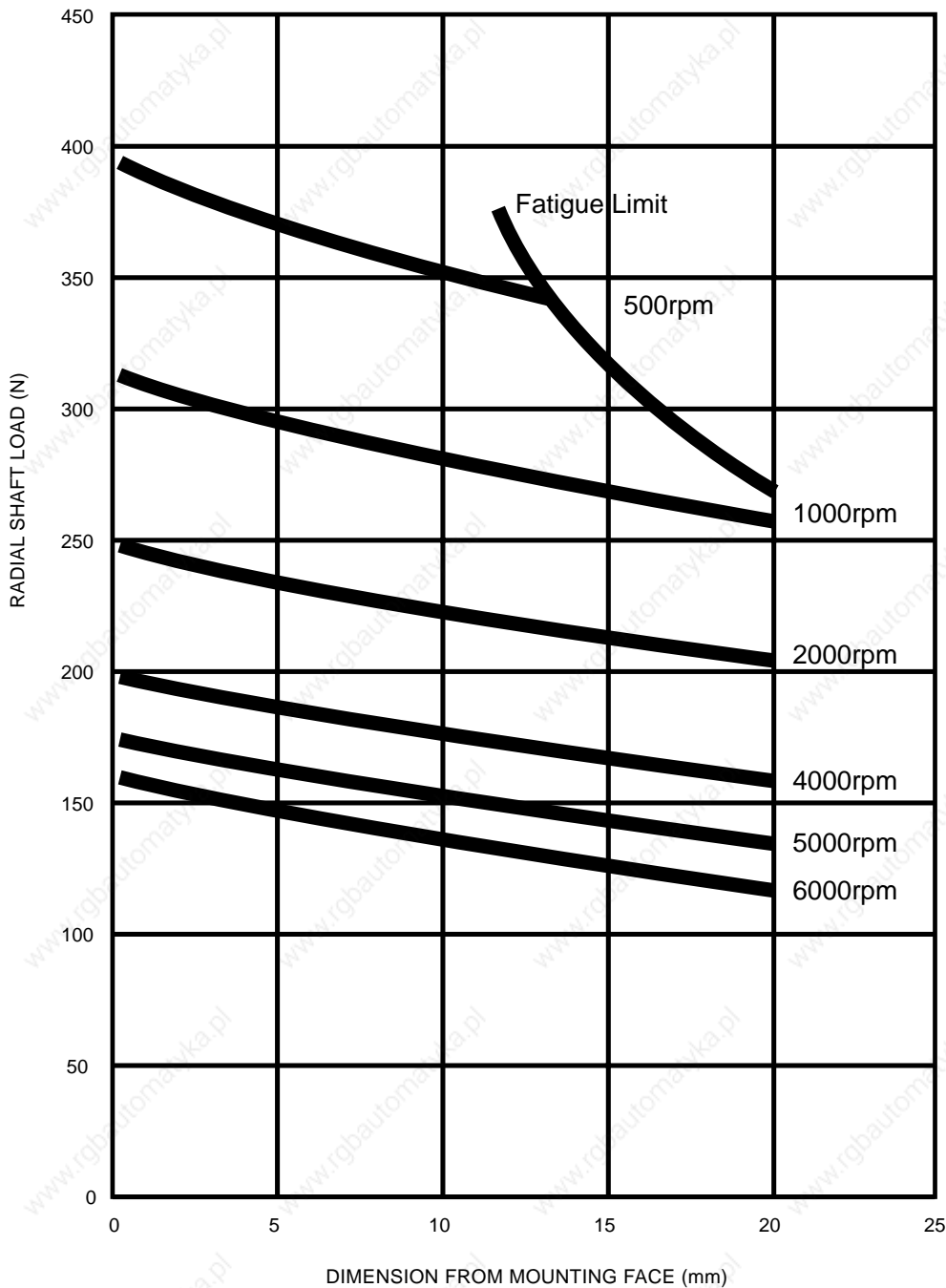

Shaft Loading Information for SEM Standard Servomotors

General notes:-

- 1 All loadings are based upon An L10 bearing life expectancy of 30,000 hours.
- 2 Separate graphs are usually supplied to indicate maximum axial loads which are applicable. However, for motors with locked drive end bearings, a graph is used to illustrate the maximum allowed radial shaft loadings together with a simplified calculation to provide a compensated figure for when radial and axial loadings are to be applied in combination.
- 3 It may occur, in certain circumstances, that loading outside the scope of the published information is deemed necessary. In these cases it is desirable that SEM Ltd should be consulted and all relevant information made available, in order that due consideration can be given to finding a satisfactory solution.
- 4 Should motors be required to operate under abnormal conditions, such as excessive vibration or shock, this should also be referred to SEM Ltd as noted above.

HR55 COMBINATION OF AXIAL AND RADIAL SHAFT LOADING

Calculated combined load must NOT EXCEED the Radial Shaft loadings indicated on Sheet 1
 Equivalent radial load $(Pr) = 0.56Fr + YFa$ Where $Fr =$ Applied radial load
 or $= Fr$ (whichever is greater) $Fa =$ Applied axial load (Max 150N)
 $YFa =$ Value taken from chart below

YFa VALUE Vs APPLIED AXIAL LOAD

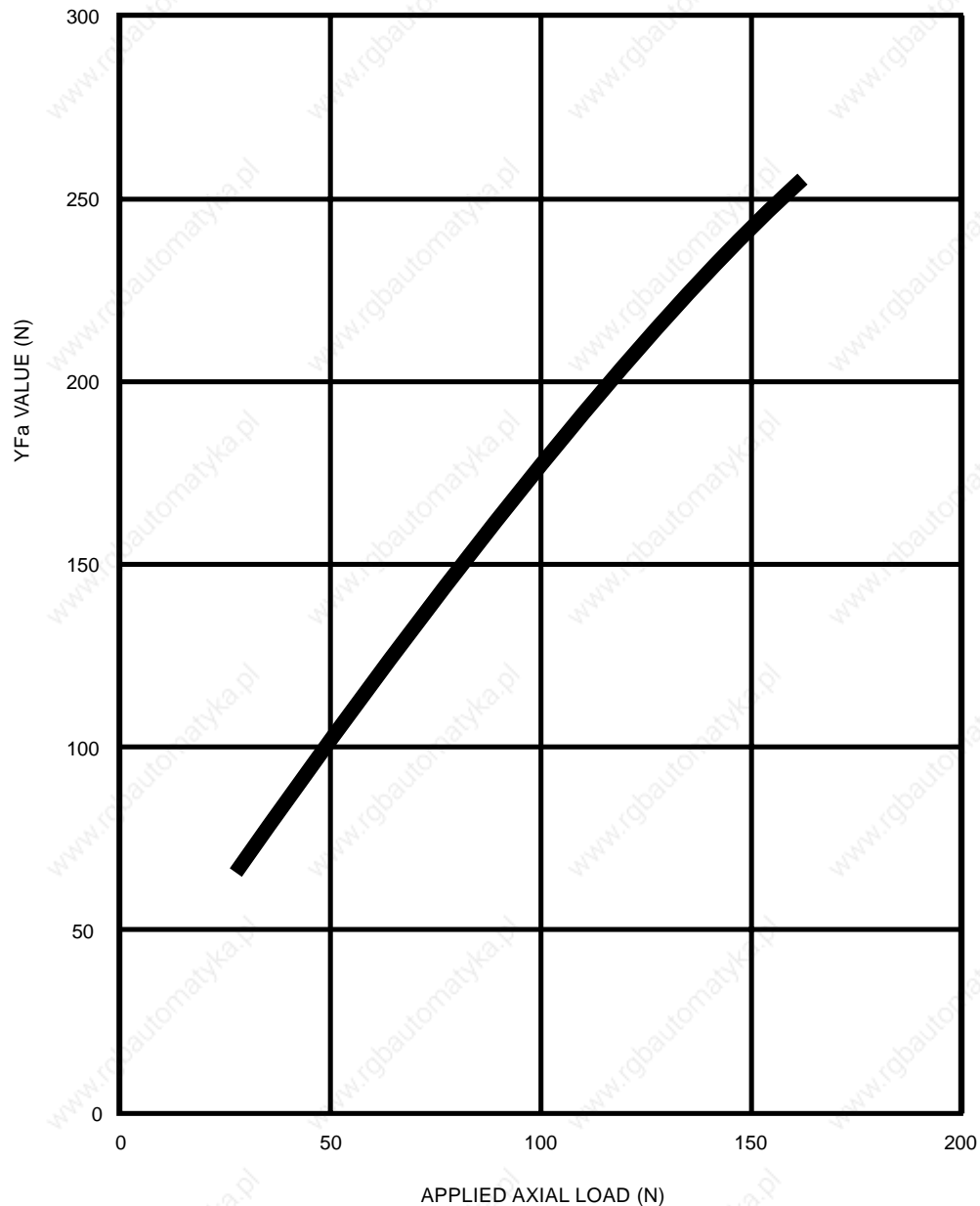

Shaft Loading Information for SEM Standard Servomotors

General notes:-

- 1 All loadings are based upon An L10 bearing life expectancy of 30,000 hours.
- 2 Separate graphs are usually supplied to indicate maximum axial loads which are applicable. However, for motors with locked drive end bearings, a graph is used to illustrate the maximum allowed radial shaft loadings together with a simplified calculation to provide a compensated figure for when radial and axial loadings are to be applied in combination.
- 3 It may occur, in certain circumstances, that loading outside the scope of the published information is deemed necessary. In these cases it is desirable that SEM Ltd should be consulted and all relevant information made available, in order that due consideration can be given to finding a satisfactory solution.
- 4 Should motors be required to operate under abnormal conditions, such as excessive vibration or shock, this should also be referred to SEM Ltd as noted above.

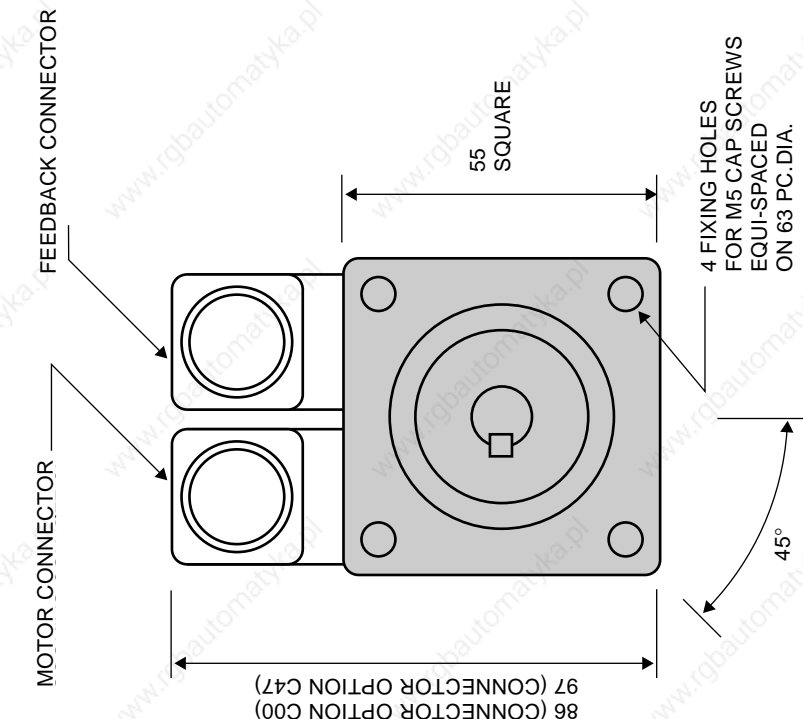

CONNECTORS MAY BE ROTATED INTO ONE OF FOUR POSITIONS

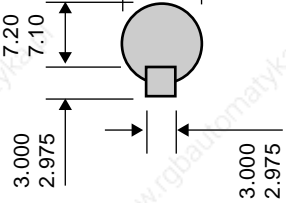
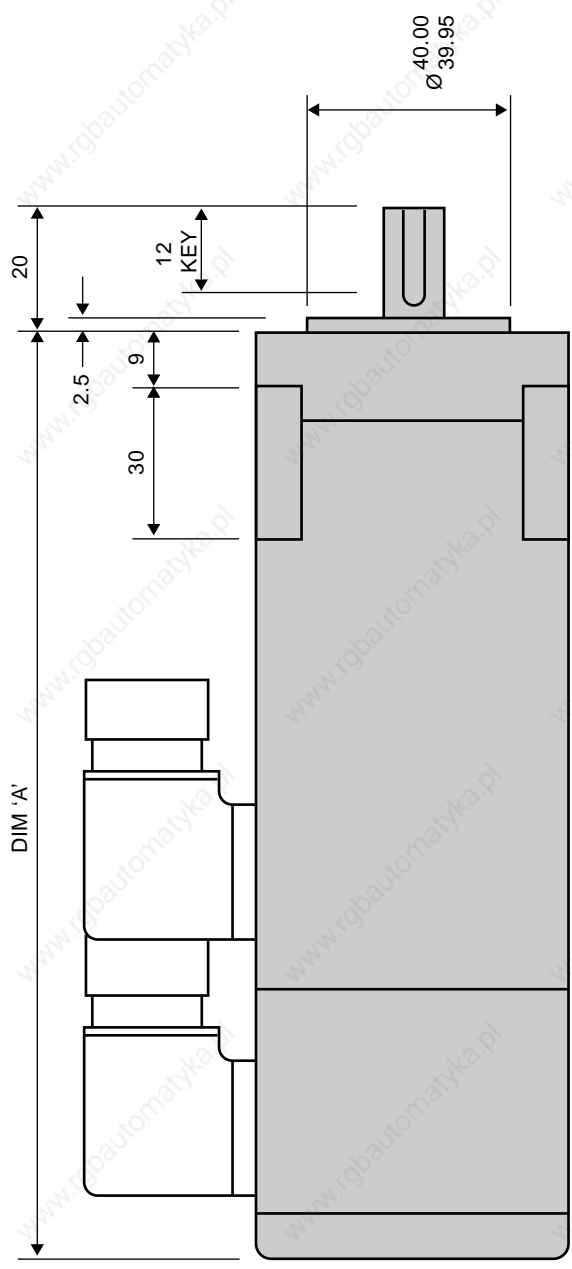

FRAME	DIM 'A'	
	NO BRAKE	WITH BRAKE
HR55A	122	158
HR55C	140	176
HR55G	176	212

Dimensions may be subject to change without notice.
Certified drawings available on request.

HR SERIES

HR55 + CONNECTORS

HR55 - OPTIONS (metric series)

7

Code	Description	Notes
WAVEFORM (WINDING)		
Y00*	Waveform.	Sinusoidal waveform.
FEEDBACK DEVICES		
F00*	Resolver (F00 setting).	2 Pole Resolver type 15-B with F00 setting.
F16	Resolver (F16 setting)	2 Pole Resolver type 15-B with alternative F16 setting.
F66	No Feedback Device	
FITTED ENCODERS		
E15	Encoder	Heidenhain ERN1185 series, 2048ppr.
E24	Encoder, singleturn, EnDat	Heidenhain ECN1113 series, 512ppr with EnDat Interface.
E32	Encoder, multiturn, EnDat.	Heidenhain EQN1125 series, 512ppr with EnDat Interface.
E20	Encoder, singleturn.	Stegmann SRS50 series with Hiperface Interface.
E21	Encoder, multiturn.	Stegmann SRM50 series with Hiperface Interface.
E26**	Incremental encoder	Renco R35i, 1000ppr
E28**	Incremental encoder	Renco R35i, 2048ppr
E29**	Incremental encoder	Renco R35i, 4000ppr
E31**	Incremental encoder	Renco R35i, 8192ppr
MECHANICAL INTERFACE		
M00*	Flange.	55 x 55 mm square flange. Spigot Ø 40mm. Fixing 4 x Ø 5.5 mm holes on 63 mm PCD.
R01	Close tolerance interface.	Flange & shaft to IEC72-P (precision).
S00*	Shaft.	Ø 9mm x 20mm long.
K00*	Keyway.	3 x 3 x 15 mm long.
K99	No Keyway.	Plain shaft.
D02*	Shaft end threaded hole.	M3 x 8mm deep.
BRAKES		
B00	24Vdc Brake.	1.0 Nm. Torque
B01	90Vdc Brake.	1.0 Nm. Torque
ELECTRICAL TERMINATIONS		
C47*	Motor & feedback connector.	Interconnectron motor receptacle (6 pin) and feedback receptacle (12 pin 20 degree offset) (for motors fitted with resolver)
C48	Motor & feedback connector.	Interconnectron motor receptacle (6 pin) and feedback receptacle (17 pin) (for motors fitted with encoder)
C68	Feedback plug.	Interconnectron straight plug (12 pin) & cable clamp for C47.
C69	Feedback plug.	Interconnectron straight plug (17 pin) & cable clamp for C48.
C67	Motor plug.	Interconnectron straight plug (6 pin) & cable clamp for C47/C48.
C70	Flying Leads	Motor and feedback leads 0.5m long.
C00	Motor & feedback connector.	Souriau / Conninvers 6 pin motor receptacle, 9 pin feedback receptacle, high profile facing non-drive end.
C01	Motor & feedback connector.	As C00 but facing drive end.
C11	Feedback plug & cable clamp.	Straight plug & cable clamp for C00, C01.
C09	Motor plug & cable clamp.	Straight plug & cable clamp for C00, C01.
THERMAL PROTECTION		
P21*	Thermal overload.	Bi-metal thermal switch.
P17	Thermal overload.	Temperature sensor, Phillips type KTY 84-130.
P18	No thermal overload.	Thermal protection not fitted.
ENCLOSURE PROTECTION		
W02*	IP64/65 enclosure.	Nitrile shaft seal for IP64/65 protection (supplied loose).
W00	IP64/65 enclosure.	Nitrile shaft seal for IP64/65 protection (factory fitted).
W99	No Shaft Seal Fitted	
UL APPROVAL		
U00	UL approved motor	

*Standard feature

**Other line counts available on request, not available on the HR55G brake

HR70A4

HR70C4

HR70E4

HR70

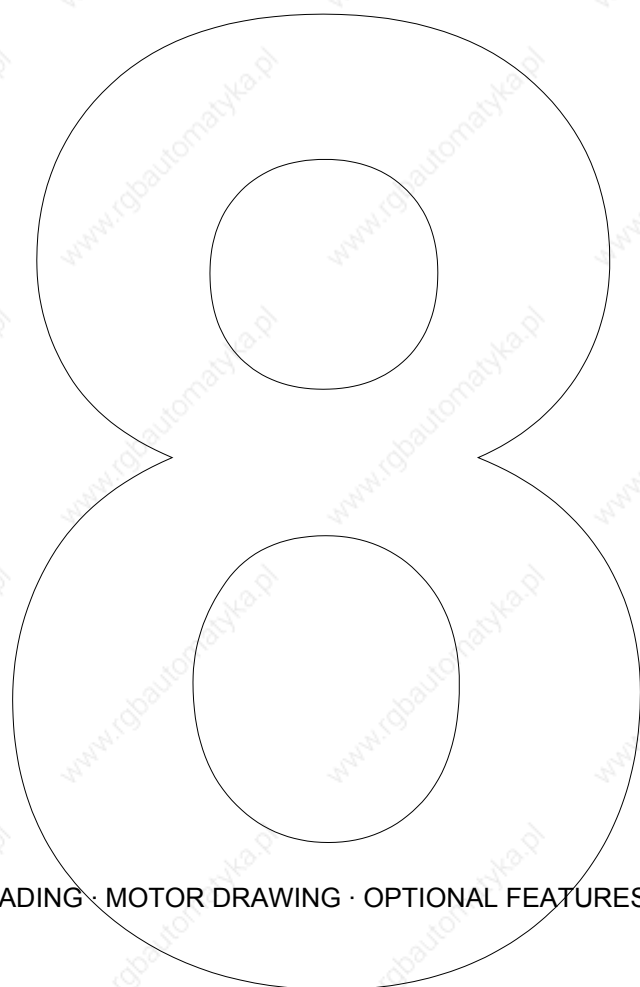

DATA TABLES · PERFORMANCE CURVES · SHAFT LOADING · MOTOR DRAWING · OPTIONAL FEATURES

HR70A4

Brushless DC/AC Servomotors

8

Technical Data

Parameter	Units	HR70A4-44	HR70A4-32	HR70A4-22
GENERAL				
Voltage Gradient No Load	Line-Line Volts (Peak)/1000RPM	44	32	22
Max. Motor EMF	Line - Line Volts	350	260	180
Max. Speed	RPM	8000	8000	8000
Insulation Class		F	F	F
Max. Ambient Temperature	°C (°F)	40 (104)	40 (104)	40 (104)
Thermal Time Constant	Minutes	15	15	15
Static Friction Torque	Nm lb-in	0.002 0.018	0.002 0.018	0.002 0.018
Peak Stall Torque	Nm (lb-in)	2.2 (19)	2.2 (19)	2.2 (19)
Continuous Stall Current rms ^ψ	Amps	1.17	1.6	2.3
Rotor Polar Moment of Inertia (Inclusive of Resolver Inertia)	kgcm ² lb-in sec ²	0.32 0.00028	0.32 0.00028	0.32 0.00028
Maximum Current (Peak)	Amp	7.4	10.2	15
Continuous Stall Torque TENV (110K)^ψ	Nm (lb-in)	0.6 (5.3)	0.6 (5.3)	0.6 (5.3)
Cogging Torque	Nm	0.027	0.027	0.027
(No shaft seal fitted)	lb - in	0.24	0.24	0.24
Torque Constant Kt_{rms}[†]	Nm/Amp lb-in/Amp	0.51 4.5	0.375 3.3	0.258 2.28
(Size 150 x 150 x 6 mm)	Nm	0.7	0.7	0.7
Cont. Stall Torque when fitted to Heatsink (Size 6 x 6 x 0.25 in)	lb-in	6.2	6.2	6.2
STATOR WINDING				
Resistance Line-Line*	Ohms	18	9.2	3.9
Inductance Line-Line	MilliHenrys	27	13.9	6.5
Thermal Resistance	°C/Watt °F/Watt	2.2 3.9	2.2 3.9	2.2 3.9
Motor Weight	kg (lb)	2.0 (4.4)	2.0 (4.4)	2.0 (4.4)

Notes

Tolerance - All data is subject to a tolerance of ±10% (except motor 'Voltage Gradient' and Kt which are to +15%/-5%).
* - At 25°C.

† - Note that Kt is shown as a combined value for all **three phases**.

ψ - The temperature rise ΔT on the windings is 110K and applies to all continuous torque values. The maximum ambient temperature is 40°C and therefore the temperature on the windings should not be more than 150°C. A value higher than 150°C would exceed the class F insulation temperature specification.

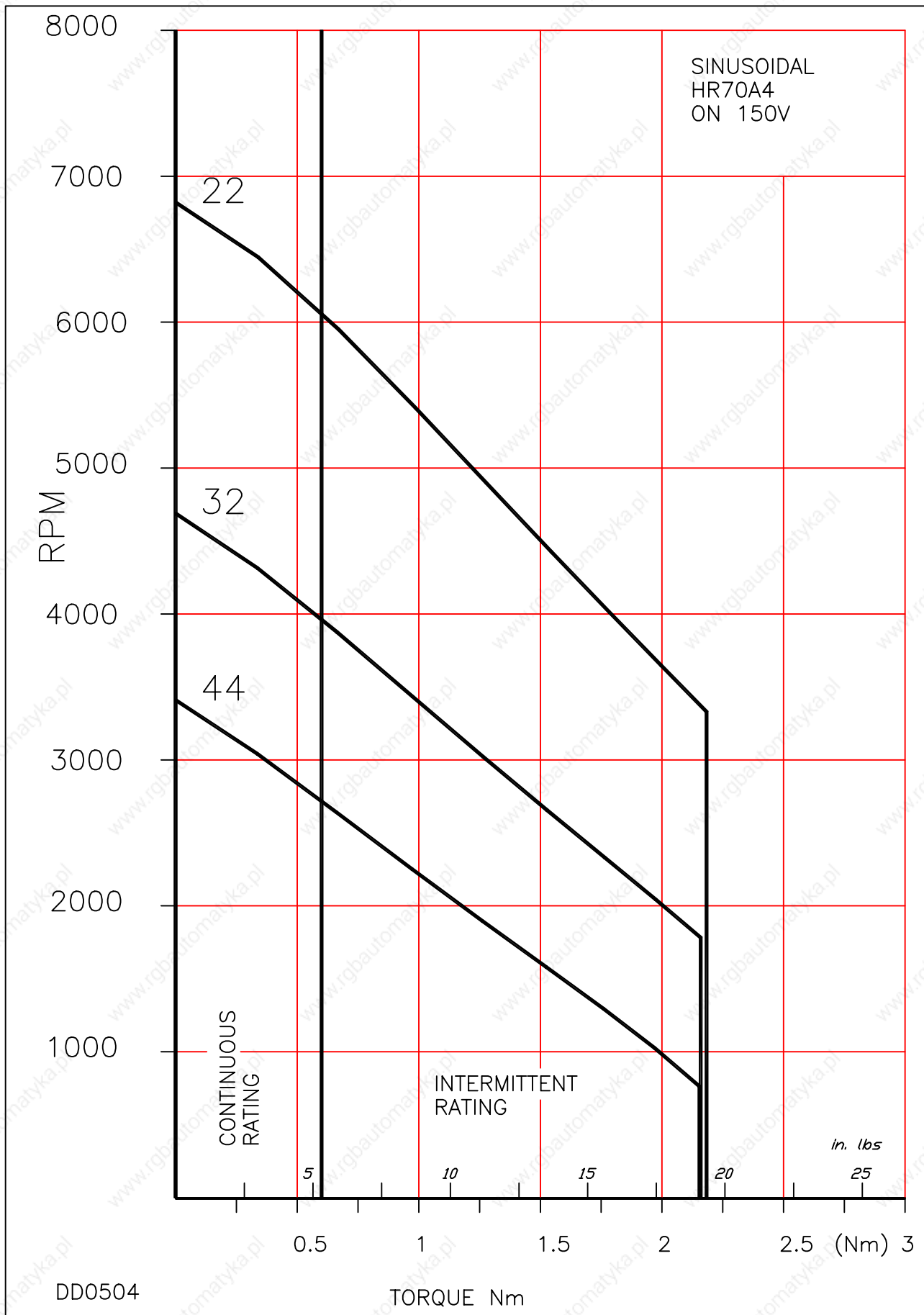

8

8

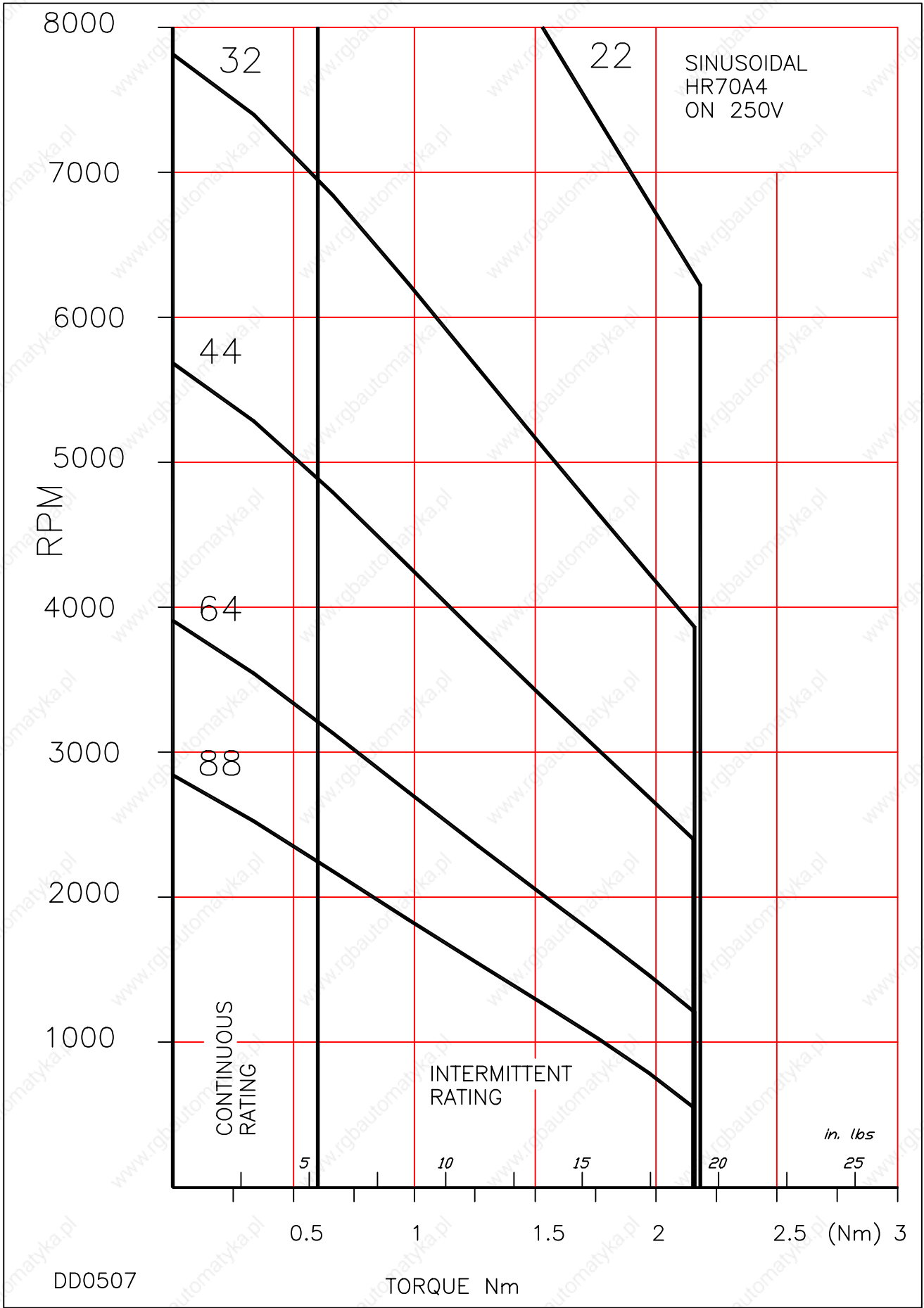

8

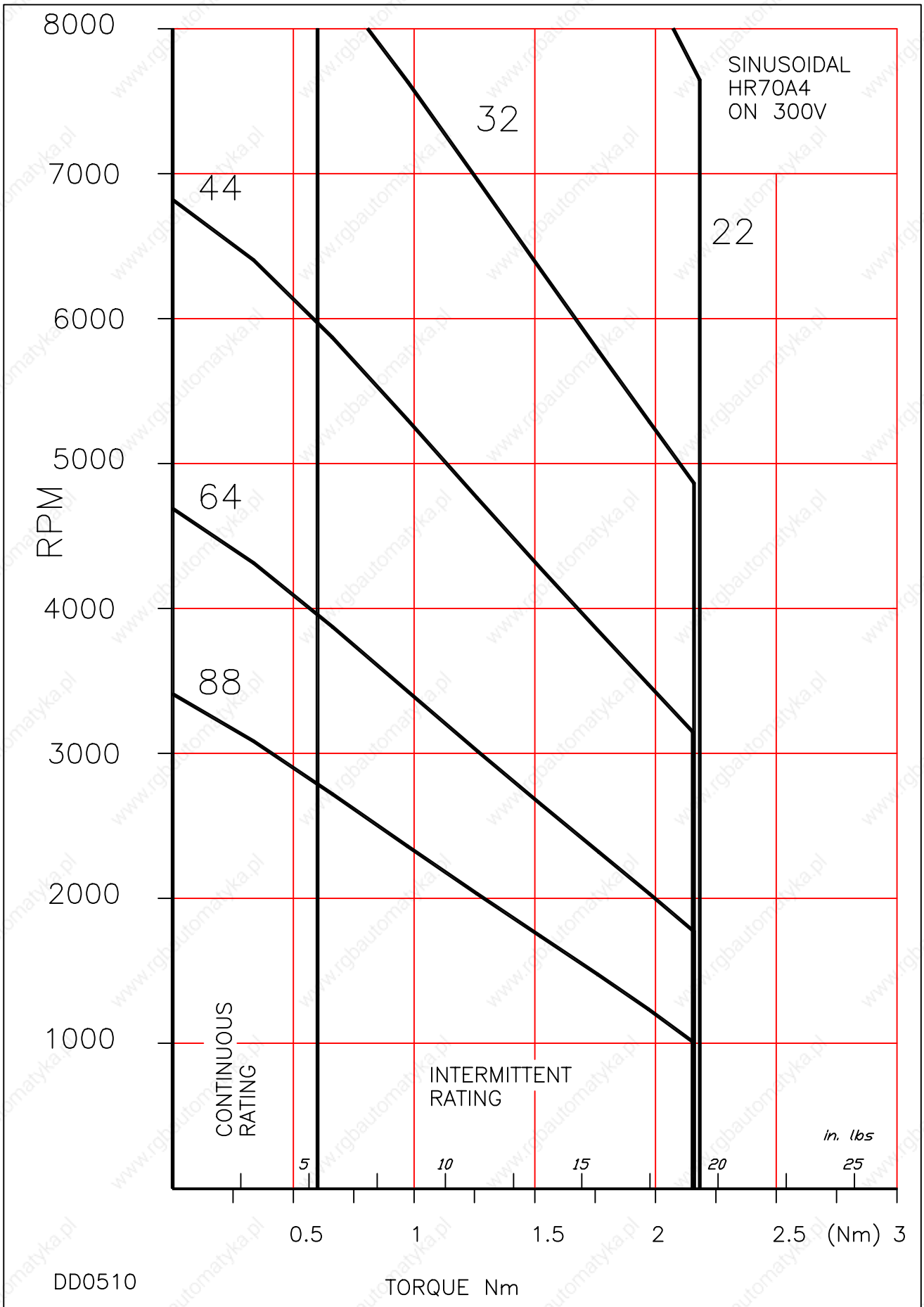

8

DD0513 ISSUE 2

SINUSOIDAL
HR70A4
ON 560V

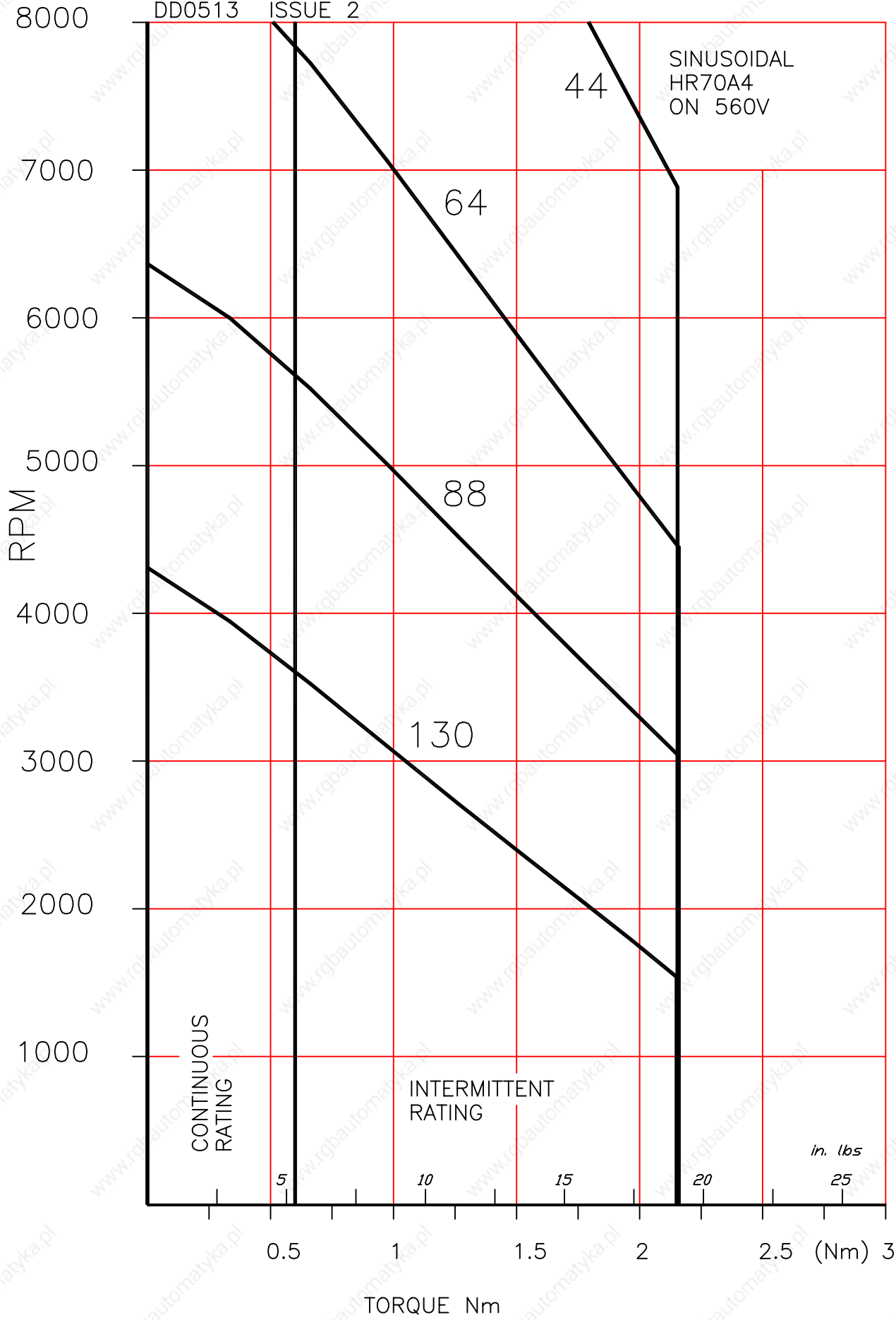

8

8

in. lbs

TORQUE Nm

8

8

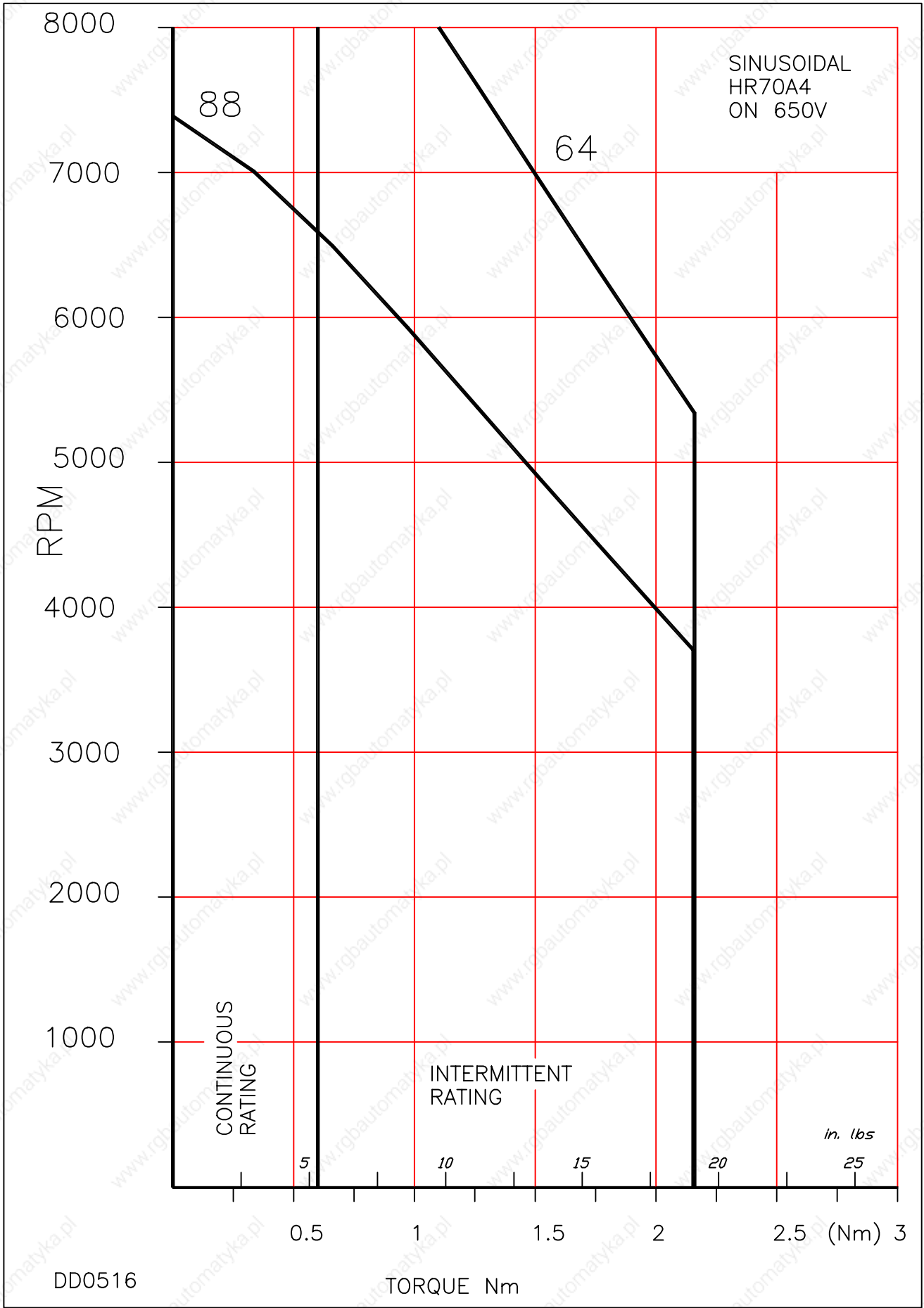

HR70C4

Brushless DC/AC Servomotors

8

Technical Data

Parameter	Units	HR70C4-64	HR70C4-44	HR70C4-32
GENERAL				
Voltage Gradient No Load	Line-Line Volts (Peak)/1000RPM	64	44	32
Max. Motor EMF	Line - Line Volts	510	350	260
Max. Speed	RPM	8000	8000	8000
Insulation Class		F	F	F
Max. Ambient Temperature	°C (°F)	40 (104)	40 (104)	40 (104)
Thermal Time Constant	Minutes	25	25	25
Static Friction Torque	Nm lb-in	0.002 0.018	0.002 0.018	0.002 0.018
Peak Stall Torque	Nm (lb-in)	4.3 (38)	4.3 (38)	4.3 (38)
Continuous Stall Current rms ^ψ	Amps	1.6	2.3	3.2
Rotor Polar Moment of Inertia (Inclusive of Resolver Inertia)	kgcm ² lb-in sec ²	0.47 0.00042	0.47 0.00042	0.47 0.00042
Maximum Current (Peak)	Amp	10.2	15	21
Continuous Stall Torque TENV (110K)^ψ	Nm (lb-in)	1.2 (10.6)	1.2 (10.6)	1.2 (10.6)
Cogging Torque (No shaft seal fitted)	Nm lb - in	0.039 0.35	0.039 0.35	0.039 0.35
Torque Constant Kt_{rms}^{*†}	Nm/Amp lb-in/Amp	0.75 6.6	0.51 4.5	0.375 3.3
(Size 150 x 150 x 6 mm) Cont. Stall Torque when fitted to Heatsink (Size 6 x 6 x 0.25 in)	Nm lb-in	1.3 11.5	1.3 11.5	1.3 11.5
STATOR WINDING				
Resistance Line-Line*	Ohms	12.5	5.3	2.9
Inductance Line-Line	MilliHenrys	25	11.6	6
Thermal Resistance	°C/Watt °F/Watt	1.7 3.6	1.7 3.6	1.7 3.6
Motor Weight	kg (lb)	2.6 (5.7)	2.6 (5.7)	2.6 (5.7)

Notes

Tolerance

- * - All data is subject to a tolerance of $\pm 10\%$ (except motor 'Voltage Gradient' and Kt which are to $+15\%/-5\%$).
- At 25°C.
- † - Note that Kt is shown as a combined value for all **three phases**.
- ψ - The temperature rise ΔT on the windings is 110K and applies to all continuous torque values. The maximum ambient temperature is 40°C and therefore the temperature on the windings should not be more than 150°C. A value higher than 150°C would exceed the class F insulation temperature specification.

8

8

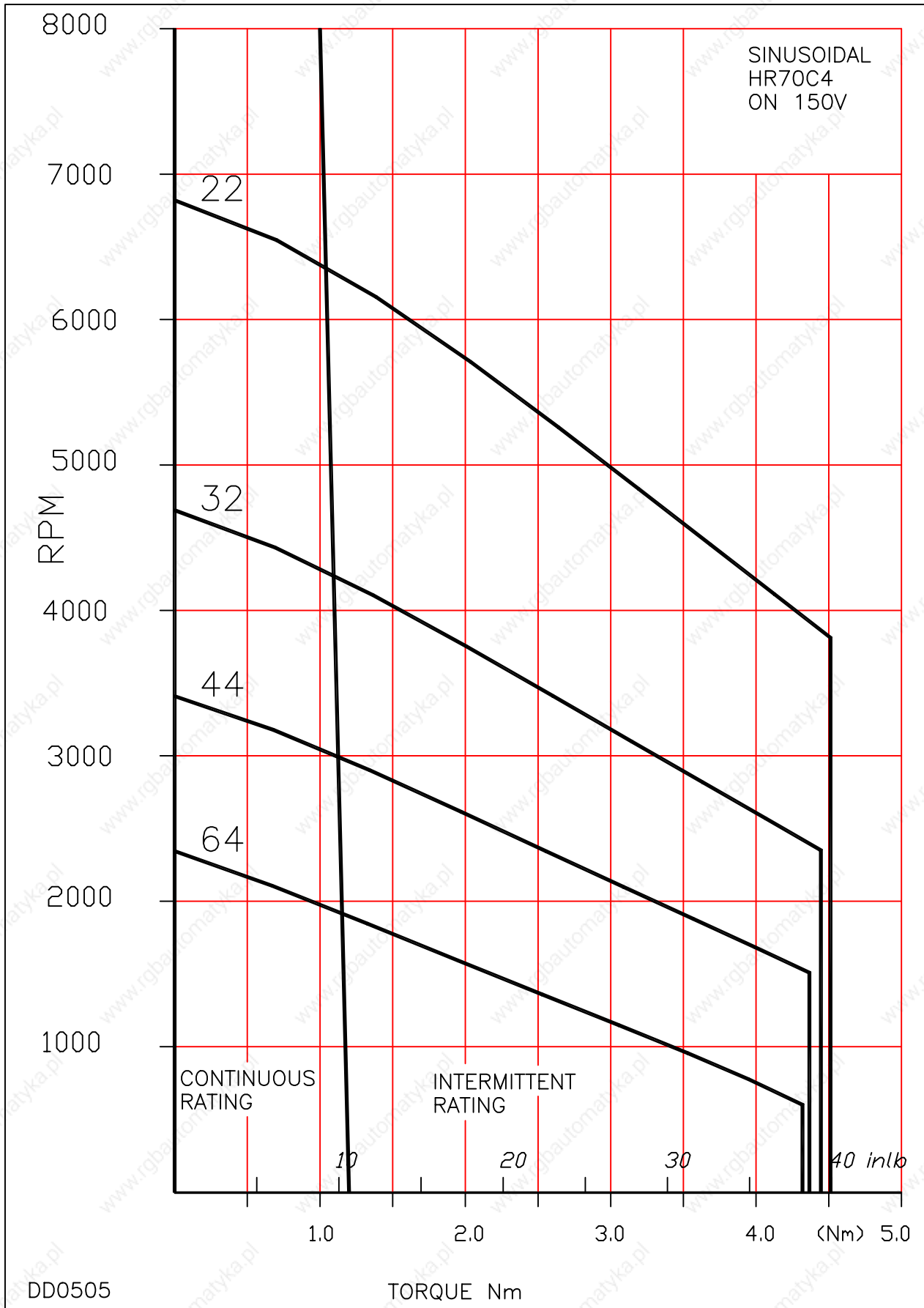

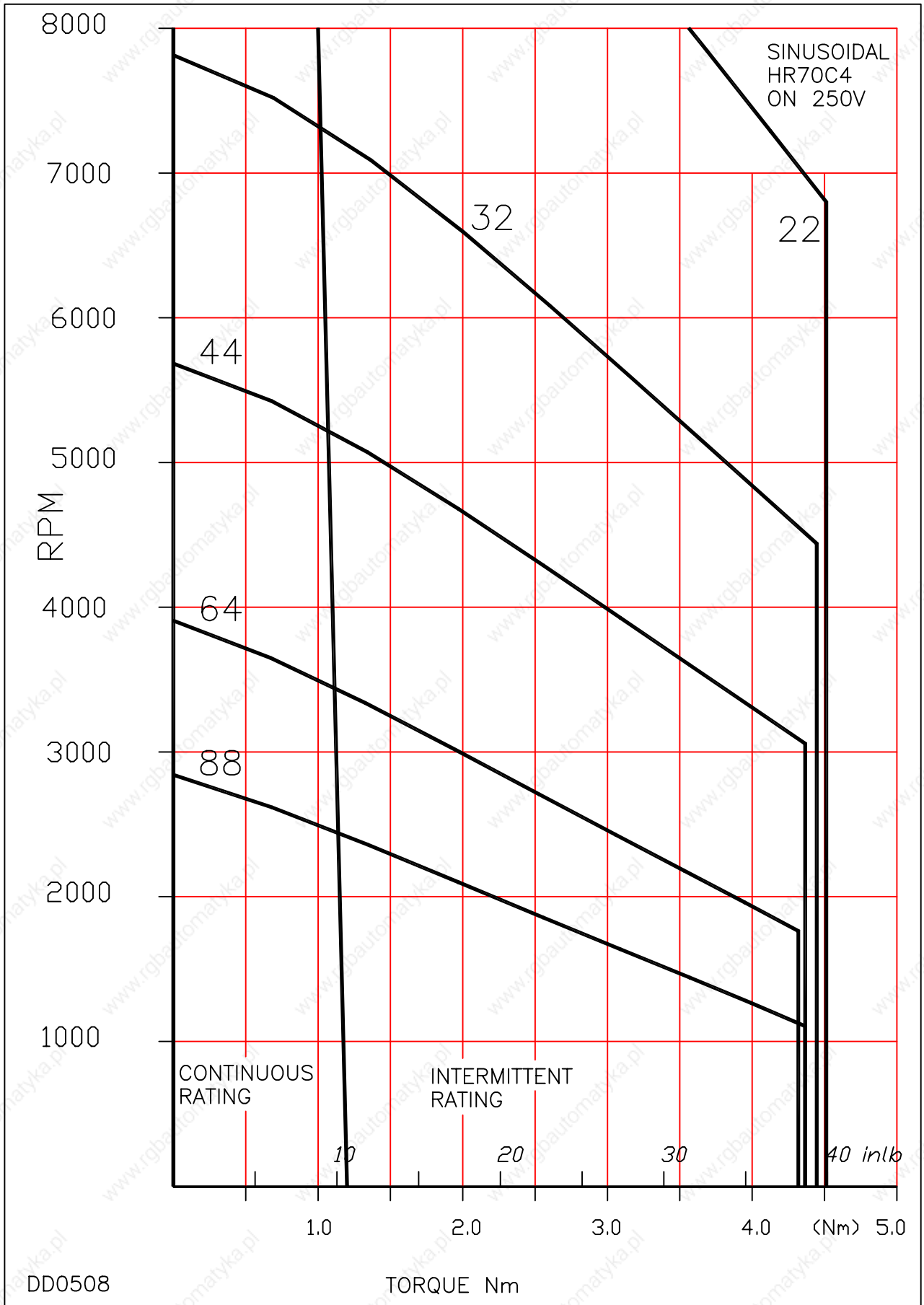

40 inlb

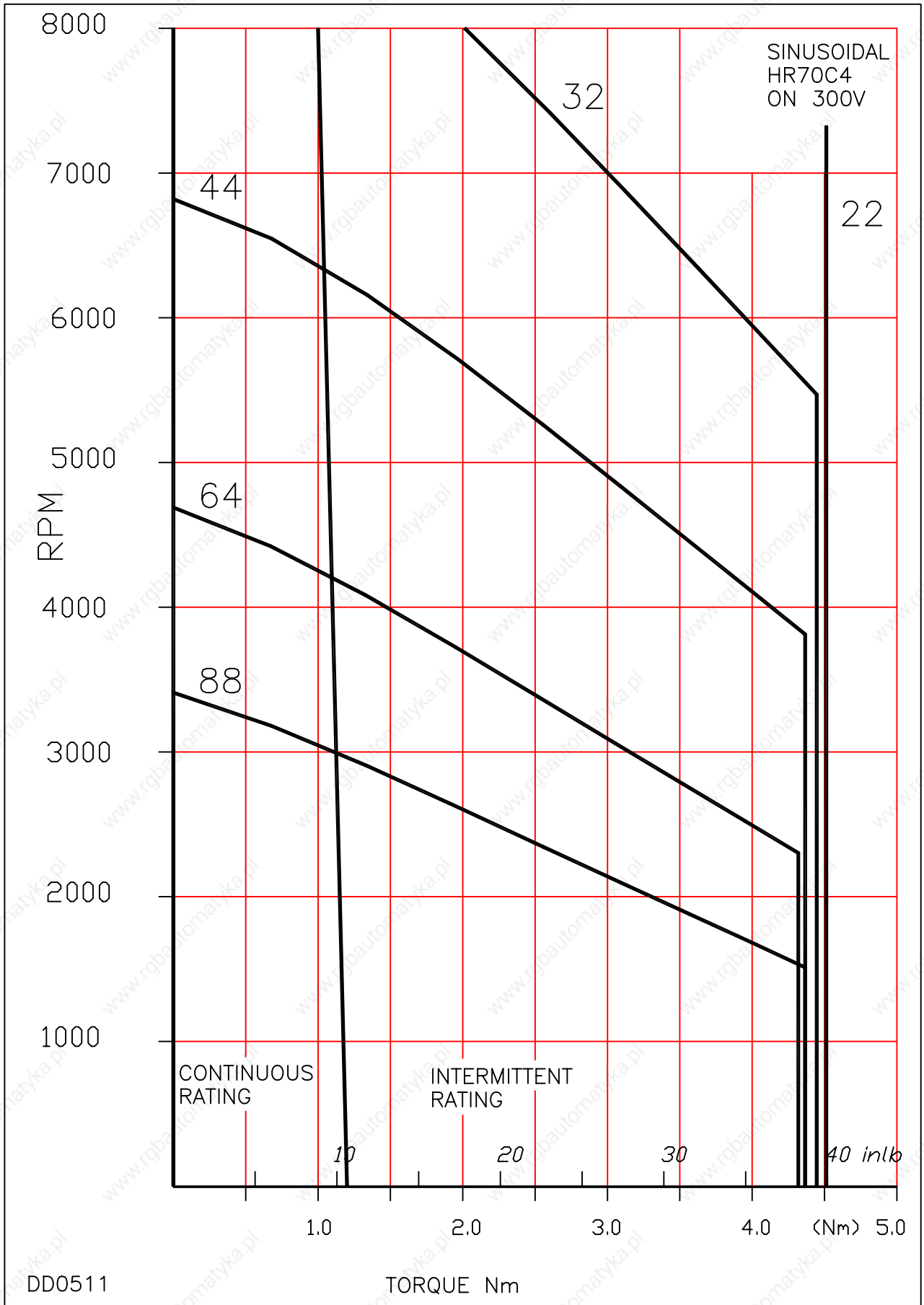

SINUSOIDAL
HR70C4
ON 300V

32

44

22

64

88

10

20

30

40 inlb

DD0511

TORQUE Nm

8

8

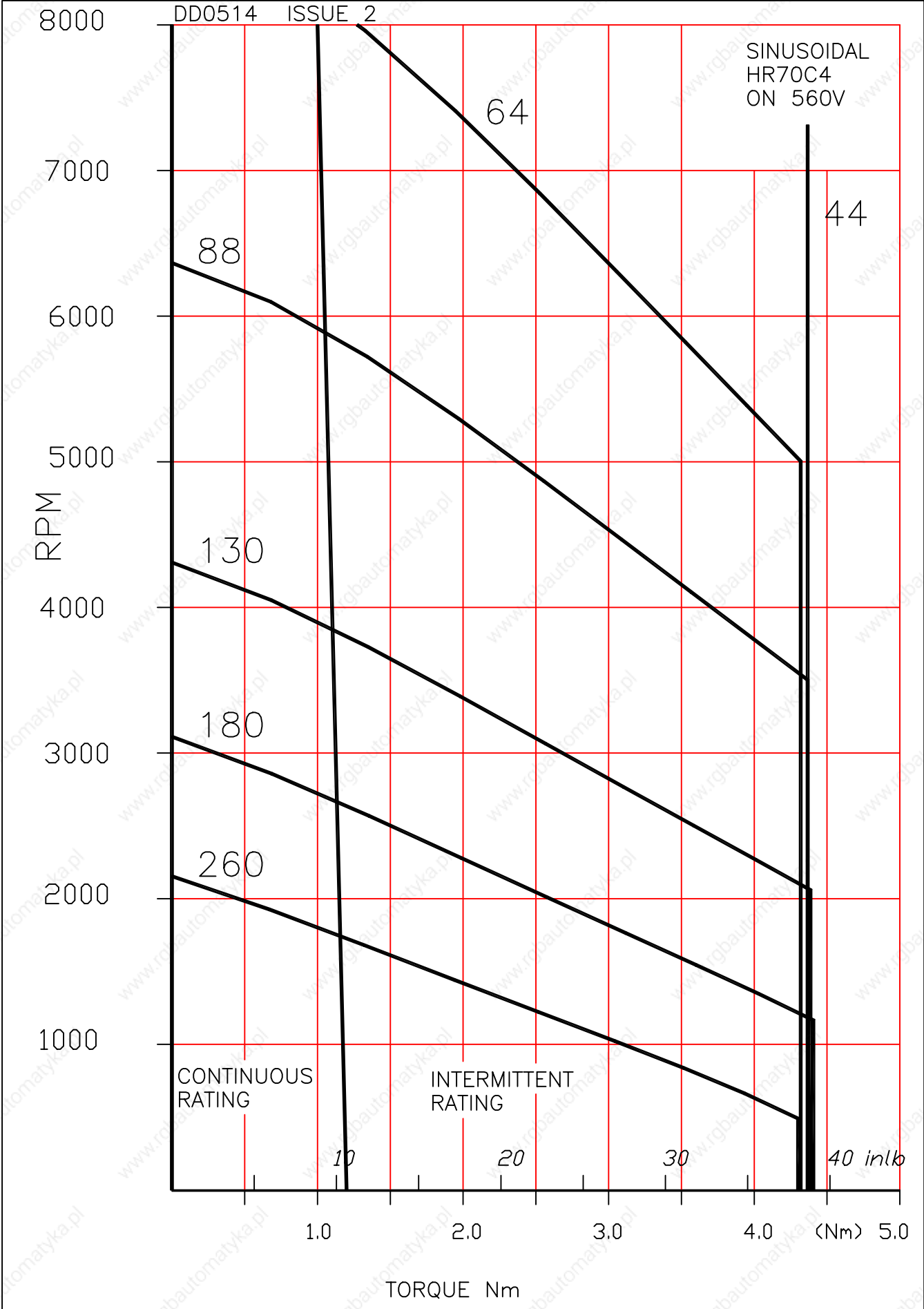

8

8

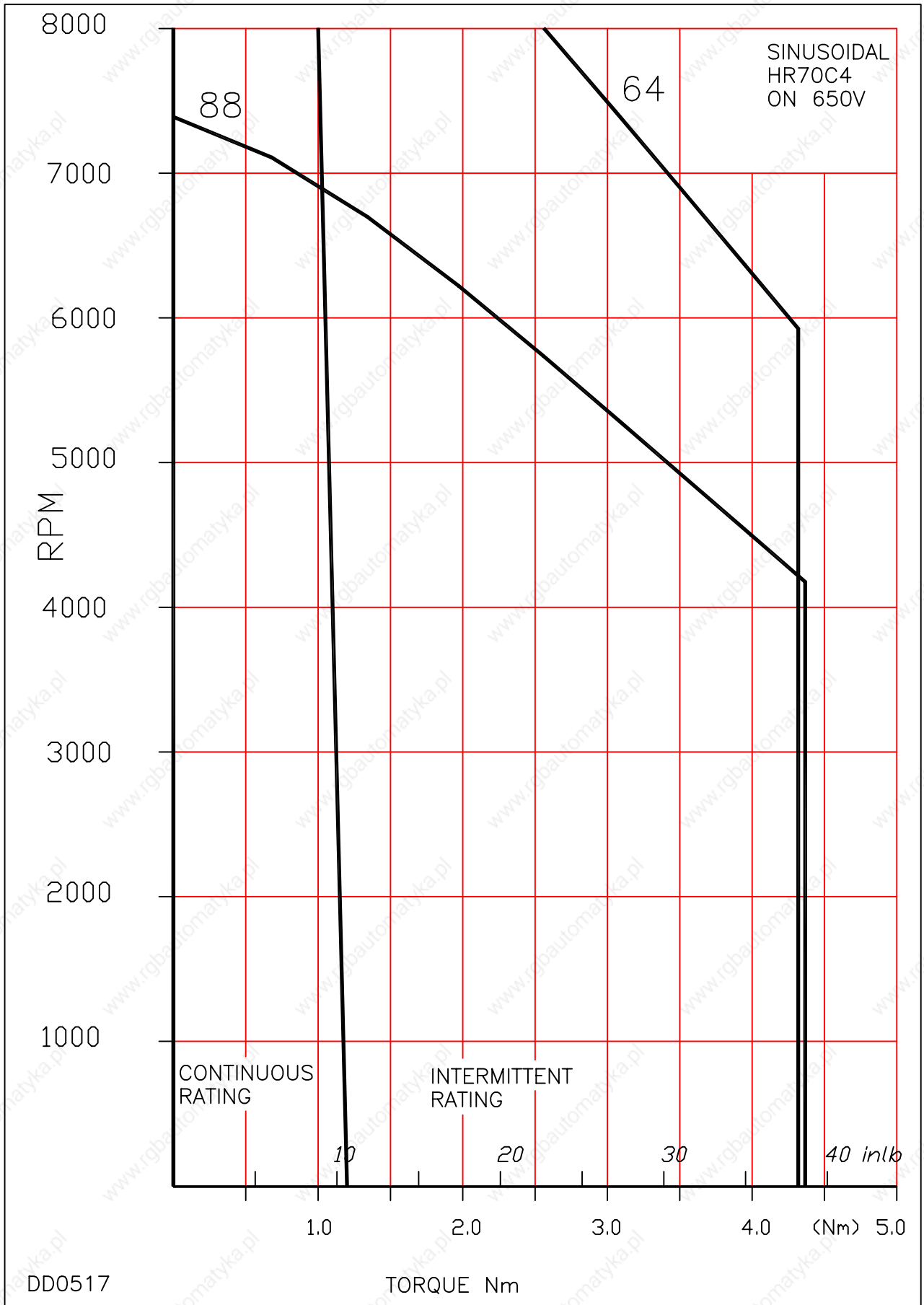

HR70E4

Brushless DC/AC Servomotors

8

Technical Data

Parameter	Units	HR70E4-44	HR70E4-32	HR70E4-22
GENERAL				
Voltage Gradient No Load	Line-Line Volts (Peak)/1000RPM	44	32	22
Max. Motor EMF	Line - Line Volts	350	260	180
Max. Speed	RPM	8000	8000	8000
Insulation Class		F	F	F
Max. Ambient Temperature	°C (°F)	40 (104)	40 (104)	40 (104)
Thermal Time Constant	Minutes	30	30	30
Static Friction Torque	Nm lb-in	0.002 0.018	0.002 0.018	0.002 0.018
Peak Stall Torque	Nm lb - in	6.5 57	6.5 57	6.5 57
Continuous Stall Current rms ^ψ	Amps	3.5	4.8	7.0
Rotor Polar Moment of Inertia (Inclusive of Resolver Inertia)	kgcm ² lb-in sec ²	0.62 0.00055	0.62 0.00055	0.62 0.00055
Maximum Current (Peak)	Amp	22	31	45
Continuous Stall Torque TENV (110K) ^ψ	Nm (lb-in)	1.8 (16)	1.8 (16)	1.8 (16)
Cogging Torque (No shaft seal fitted)	Nm lb - in	0.057 0.5	0.057 0.5	0.057 0.5
Torque Constant Kt_{rms} *†	Nm/Amp lb-in/Amp	0.51 4.5	0.375 3.3	0.258 2.3
(Size 150 x 150 x 6 mm)	Nm	2	2	2
Cont. Stall Torque when fitted to Heatsink (Size 6 x 6 x 0.25 in)	lb-in	18	18	18
STATOR WINDING				
Resistance Line-Line*	Ohms	2.9	1.7	0.79
Inductance Line-Line	MilliHenrys	7.5	4.0	1.9
Thermal Resistance	°C/Watt °F/Watt	1.33 2.4	1.33 2.4	1.33 2.4
Motor Weight	kg (lb)	3.2 (7.1)	3.2 (7.1)	3.2 (7.1)

Notes

Tolerance

* - All data is subject to a tolerance of $\pm 10\%$ (except motor 'Voltage Gradient' and Kt which are to $+15\%/-5\%$).

- At 25°C.

† - Note that Kt is shown as a combined value for all **three phases**.

ψ - The temperature rise ΔT on the windings is 110K and applies to all continuous torque values. The maximum ambient temperature is 40°C and therefore the temperature on the windings should not be more than 150°C. A value higher than 150°C would exceed the class F insulation temperature specification.

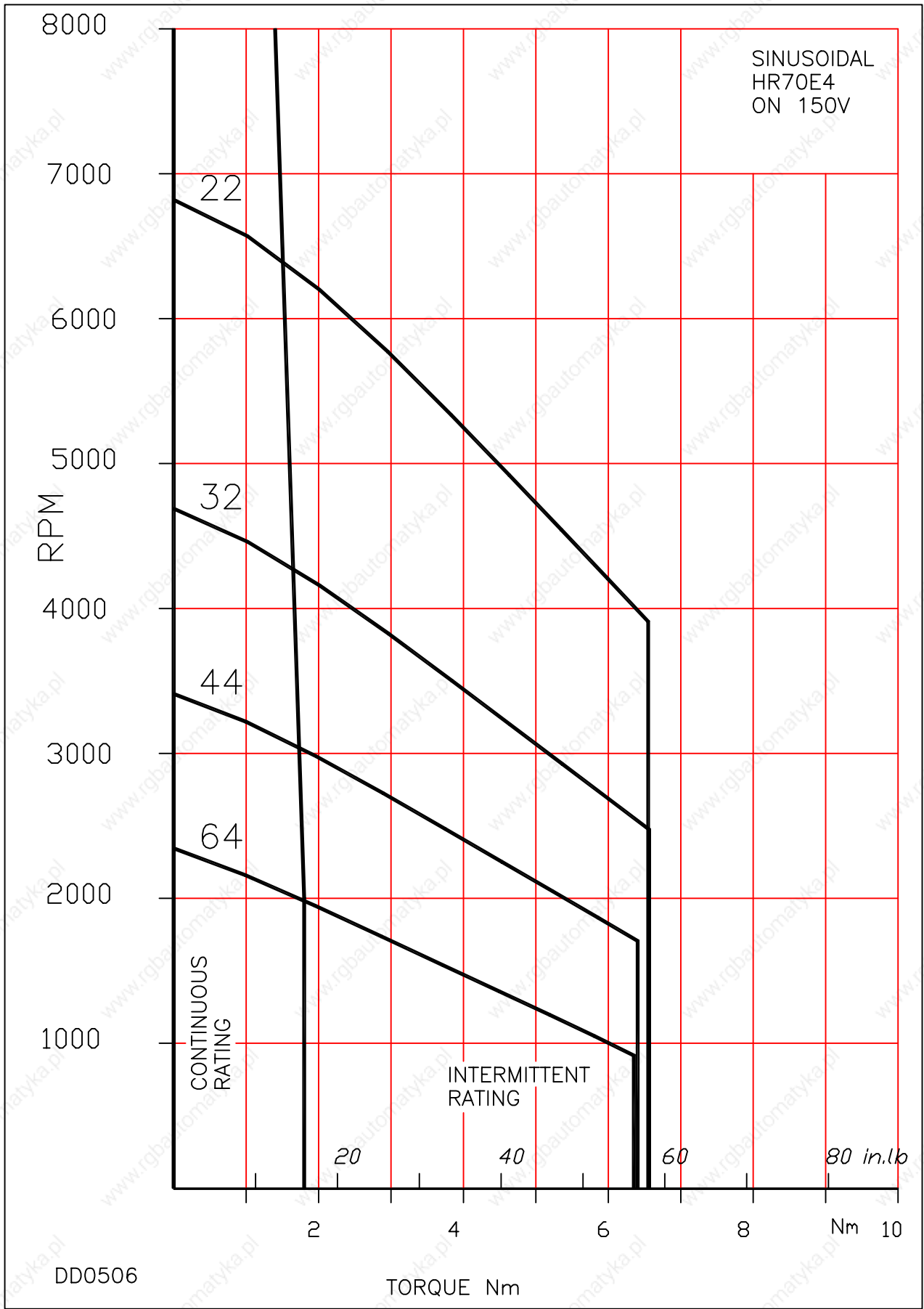

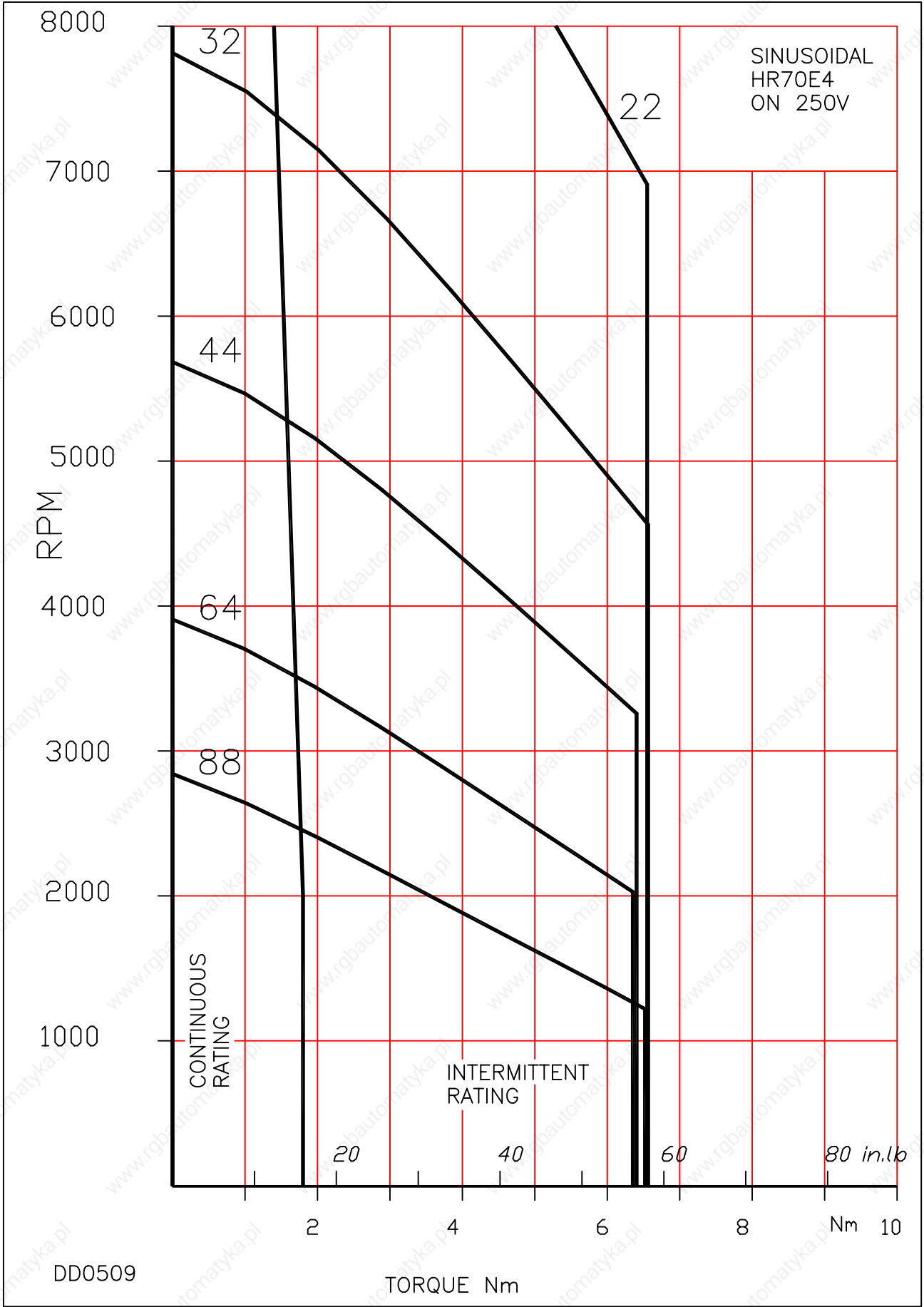

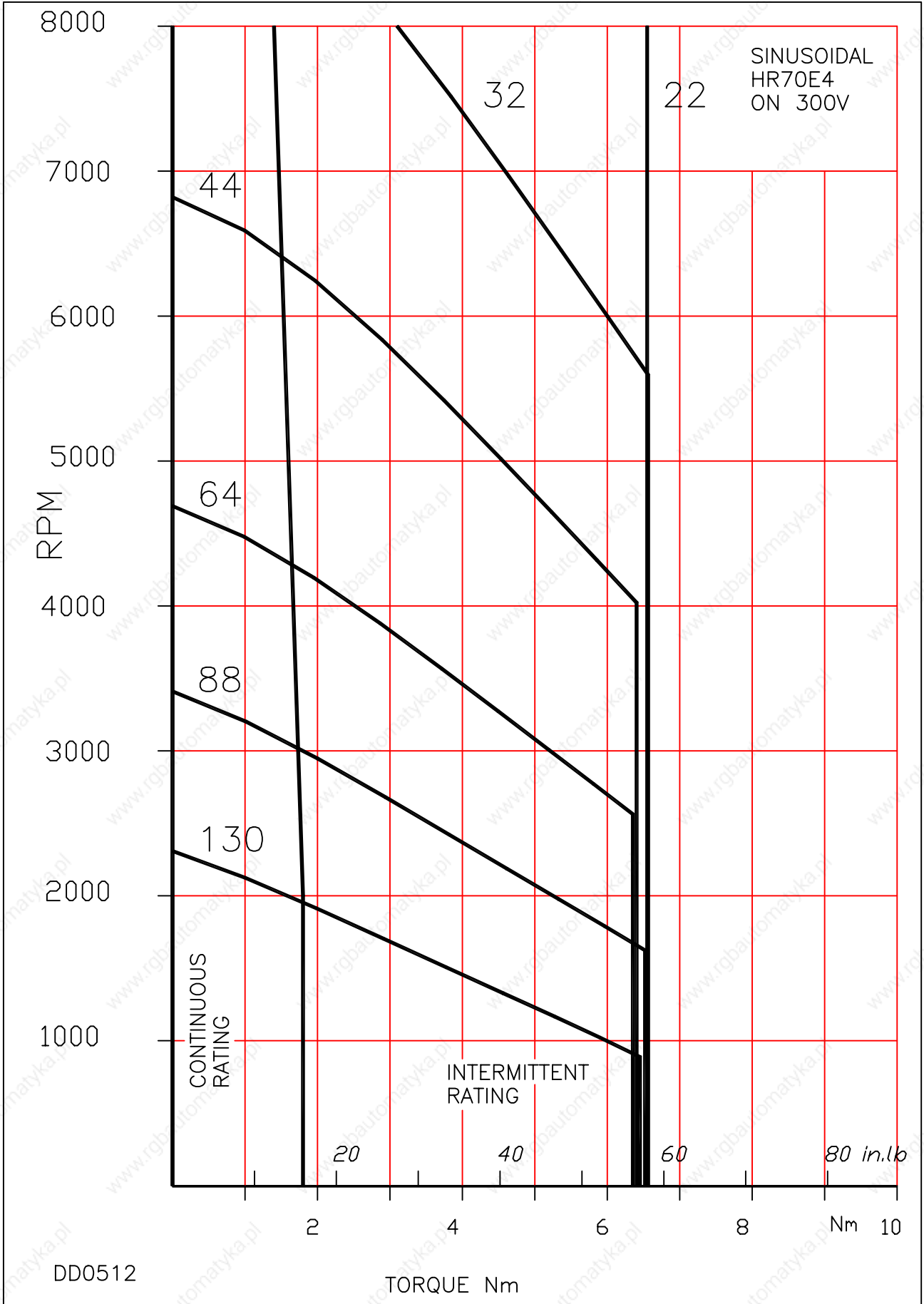

8

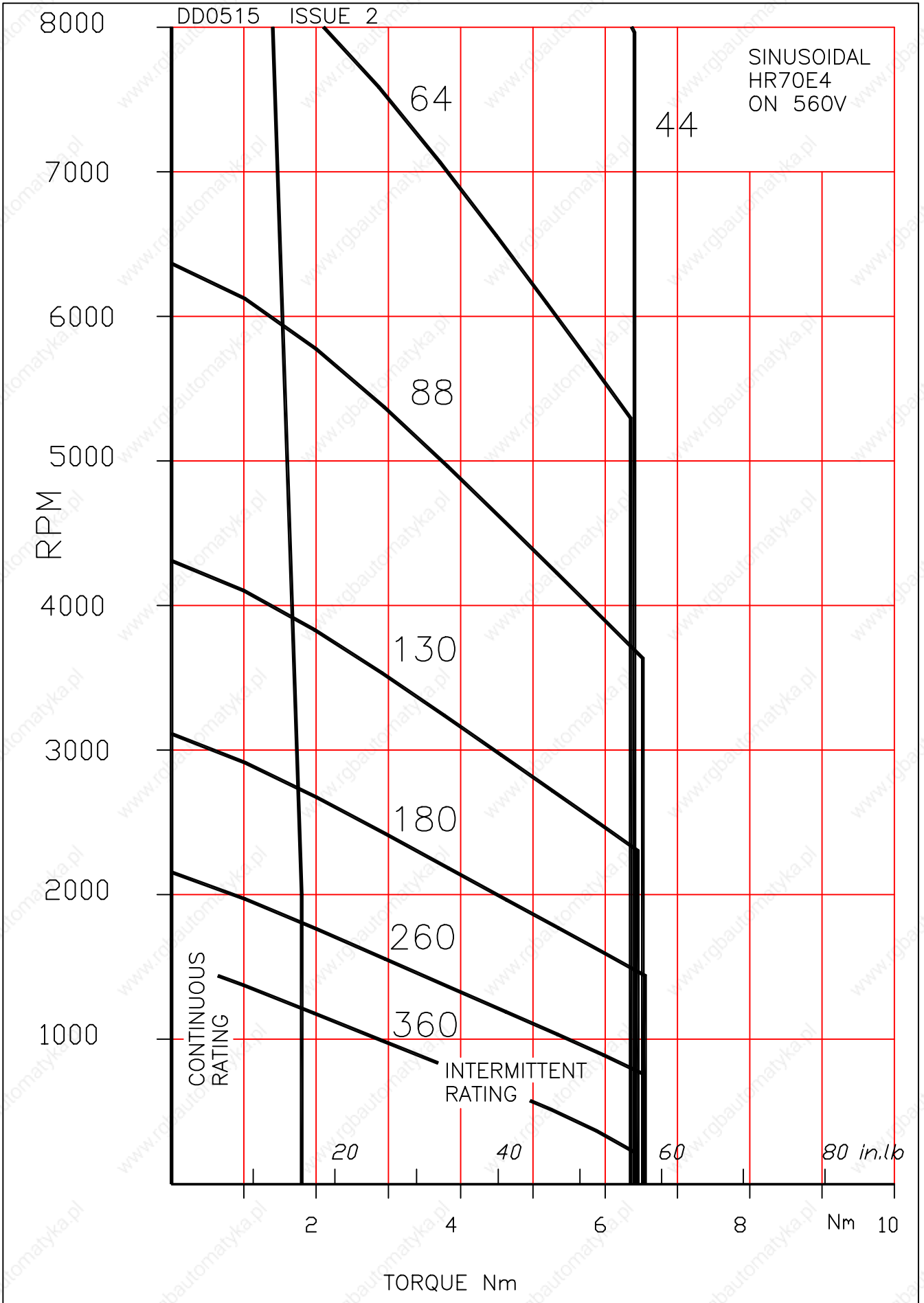

8

8

8

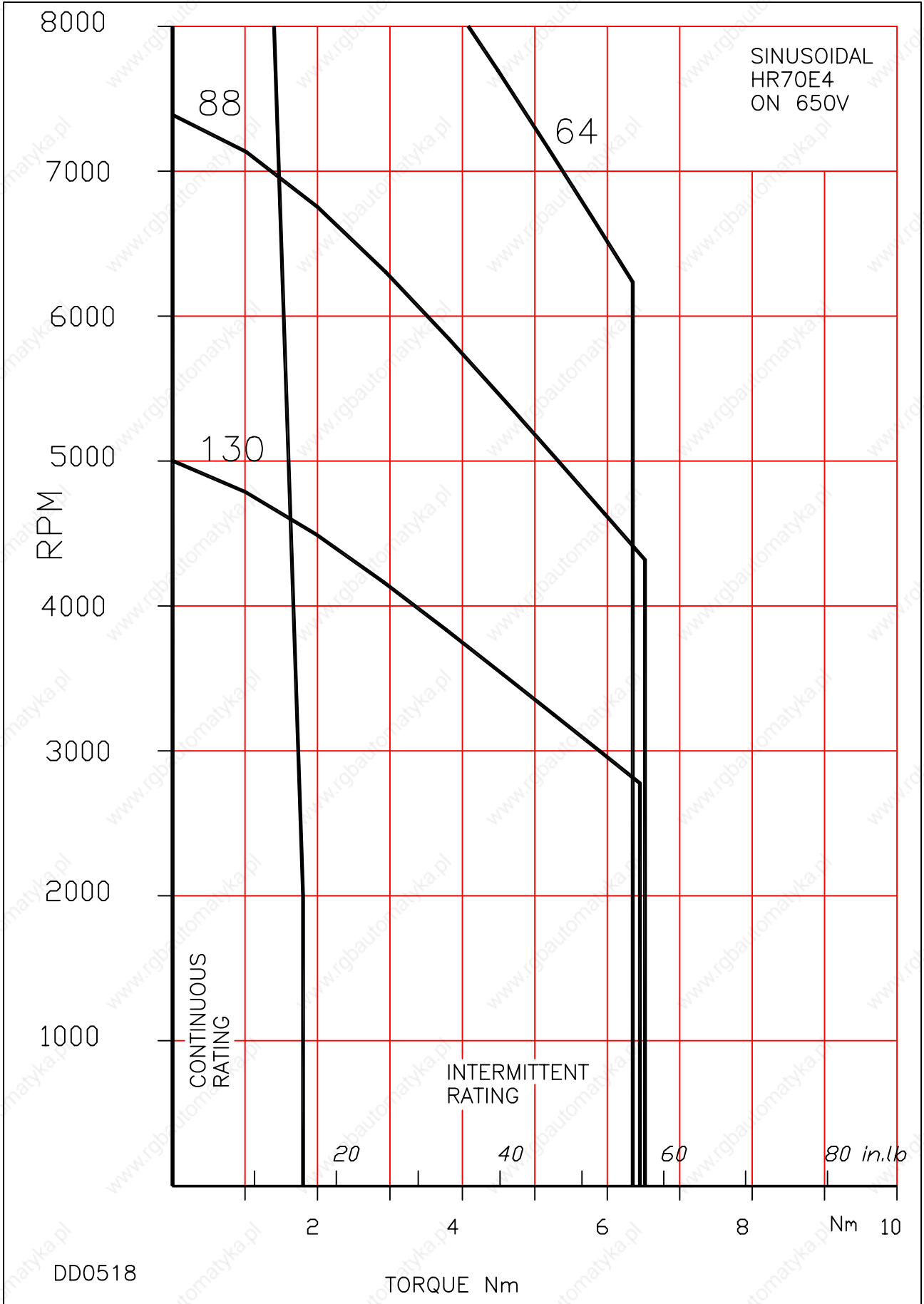

DD0518

TORQUE Nm

HR70 PERMITTED RADIAL SHAFT LOADING

(If axial loads are to be applied, the equivalent radial loading must be calculated as described on next page)

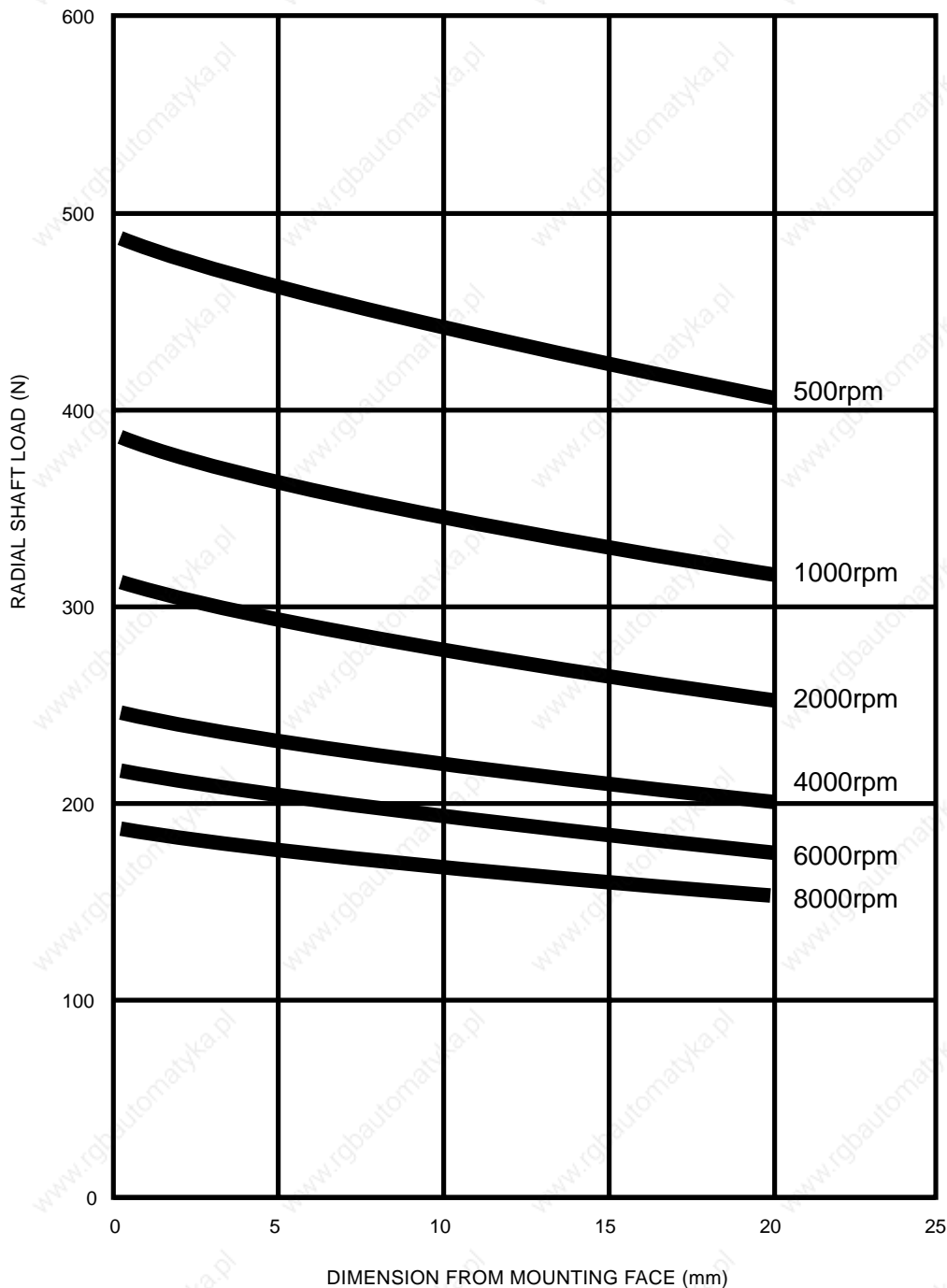

Shaft Loading Information for SEM Standard Servomotors

General notes:-

- 1 All loadings are based upon An L10 bearing life expectancy of 30,000 hours.
- 2 Separate graphs are usually supplied to indicate maximum axial loads which are applicable. However, for motors with locked drive end bearings, a graph is used to illustrate the maximum allowed radial shaft loadings together with a simplified calculation to provide a compensated figure for when radial and axial loadings are to be applied in combination.
- 3 It may occur, in certain circumstances, that loading outside the scope of the published information is deemed necessary. In these cases it is desirable that SEM Ltd should be consulted and all relevant information made available, in order that due consideration can be given to finding a satisfactory solution.
- 4 Should motors be required to operate under abnormal conditions, such as excessive vibration or shock, this should also be referred to SEM Ltd as noted above.

HR70 COMBINATION OF AXIAL AND RADIAL SHAFT LOADING

Calculated combined load must NOT EXCEED the Radial Shaft loadings indicated on Sheet 1

Equivalent radial load (P_r) = $0.56F_r + YF_a$

or = F_r (whichever is greater)

Where F_r = Applied radial load

F_a = Applied axial load (Max 250N)

YF_a = Value taken from chart below

YFa VALUE Vs APPLIED AXIAL LOAD

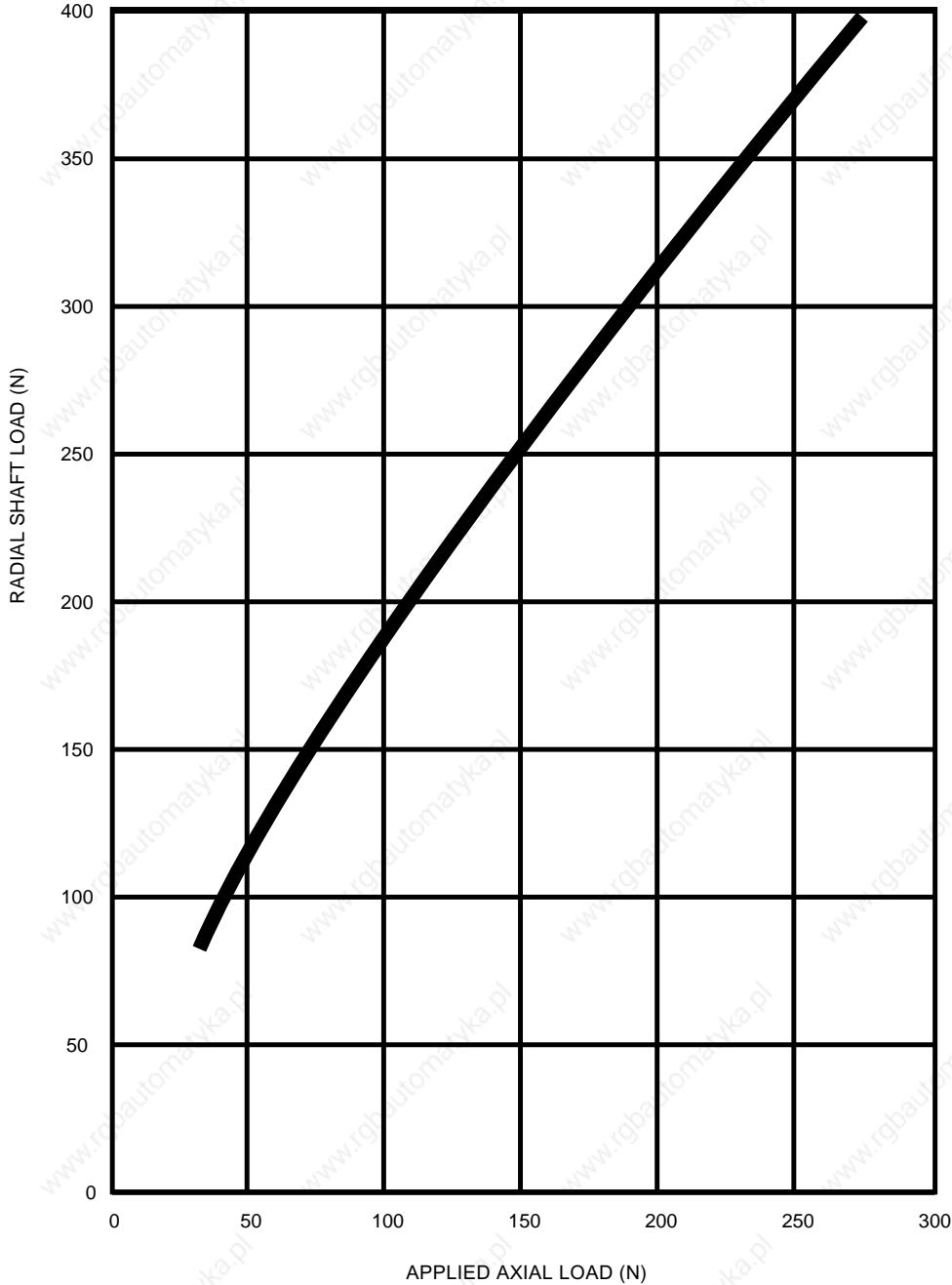

Shaft Loading Information for SEM Standard Servomotors

General notes:-

- 1 All loadings are based upon An L10 bearing life expectancy of 30,000 hours.
- 2 Separate graphs are usually supplied to indicate maximum axial loads which are applicable. However, for motors with locked drive end bearings, a graph is used to illustrate the maximum allowed radial shaft loadings together with a simplified calculation to provide a compensated figure for when radial and axial loadings are to be applied in combination.
- 3 It may occur, in certain circumstances, that loading outside the scope of the published information is deemed necessary. In these cases it is desirable that SEM Ltd should be consulted and all relevant information made available, in order that due consideration can be given to finding a satisfactory solution.
- 4 Should motors be required to operate under abnormal conditions, such as excessive vibration or shock, this should also be referred to SEM Ltd as noted above.

ALL DIMENSIONS IN MILLIMETRES

CONNECTORS MAY BE ROTATED INTO ONE OF FOUR POSITIONS

MOTOR CONNECTOR

FEEDBACK CONNECTOR

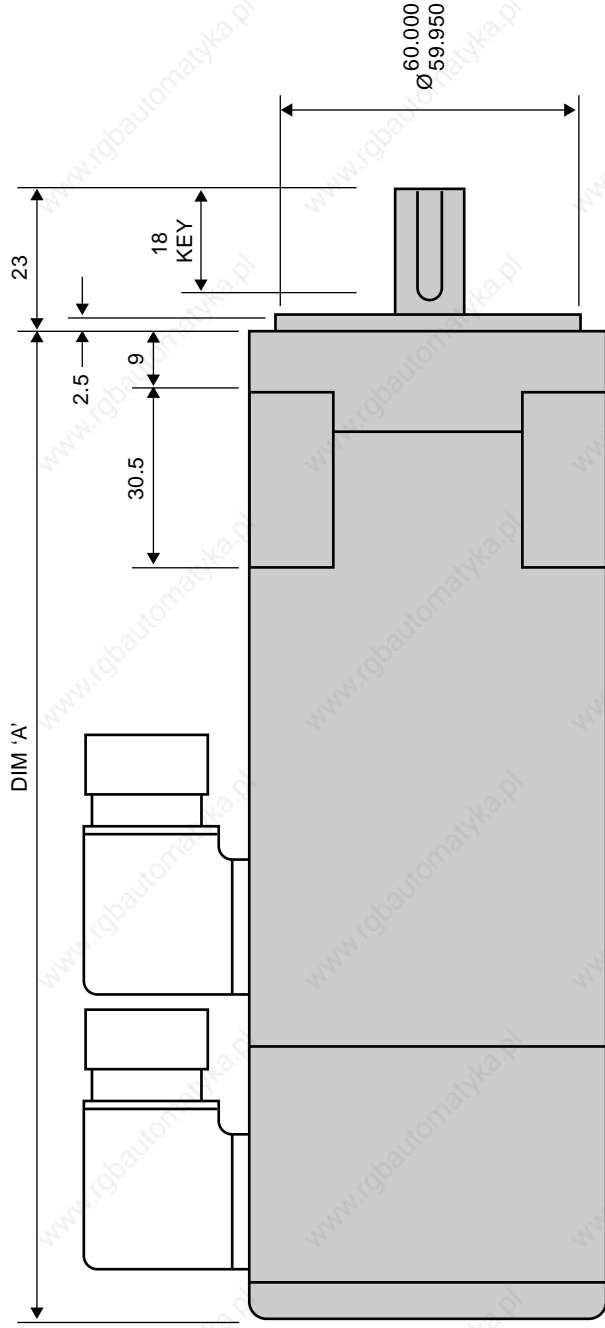

70 SQUARE

4 FIXING HOLES FOR M5 CAP SCREWS EQUI-SPACED ON 75PC.DIA.

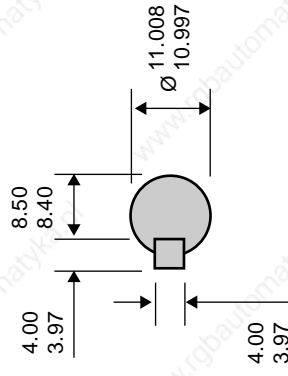

SHAFT DETAIL

FRAME	DIM 'A'	
	NO BRAKE	WITH BRAKE
HR70A	131	158
HR70C	158	185
HR70E	185	212

101 (CONNECTOR OPTION C00)
112 (CONNECTOR OPTION C47)

Dimensions may be subject to change without notice.
Certified drawings available on request.

HR SERIES

HR70 + CONNECTORS

HR70 - OPTIONS (metric series)

8

Code	Description	Notes
WAVEFORM (WINDING)		
Y00*	Waveform.	Sinusoidal waveform.
FEEDBACK DEVICES		
F00*	Resolver (F00 setting).	2 Pole Resolver type 15-B with F00 setting.
F16	Resolver (F16 setting)	2 Pole Resolver type 15-B with alternative F16 setting.
F66	No Feedback	
FITTED ENCODERS		
E15	Encoder	Heidenhain ERN1185 series, 2048ppr.
E24	Encoder, singleturn, EnDat	Heidenhain ECN1113 series, 512ppr with EnDat Interface.
E32	Encoder, multiturn, EnDat.	Heidenhain EQN1125 series, 512ppr with EnDat Interface.
E20	Encoder, singleturn.	Stegmann SRS50 series with Hiperface Interface.
E21	Encoder, multiturn.	Stegmann SRM50 series with Hiperface Interface.
E04	Encoder, c/w com-tracks.	Tamagawa 01H35 series, 1024ppr with commutation tracks.
E05	Encoder, c/w com-tracks.	Tamagawa 01H35 series, 2048ppr with commutation tracks.
E26**	Incremental encoder	Renco R35i, 1000ppr
E28**	Incremental encoder	Renco R35i, 2048ppr
E29**	Incremental encoder	Renco R35i, 4000ppr
E31**	Incremental encoder	Renco R35i, 8192ppr
MECHANICAL INTERFACE		
M00*	Flange.	70 x 70 mm square flange. Spigot Ø 60mm. Fixing 4 x Ø 5.5mm holes on 75mm PCD.
R01	Close tolerance interface.	Flange & shaft to IEC72-P (precision).
S00*	Shaft.	Ø 11mm x 23mm long.
K00*	Keyway.	4 x 4 x 18 mm long.
K99	No Keyway.	Plain shaft.
D02*	Shaft end threaded hole.	M4 x 12mm deep.
BRAKES		
B00	24Vdc Brake.	2.0 Nm. Torque
B01	90Vdc Brake.	2.0 Nm. Torque
ELECTRICAL TERMINATIONS		
C47*	Motor & feedback connector.	Interconnectron motor receptacle (6 pin) and feedback receptacle (12 pin 20 degree offset) (for motors fitted with resolver)
C48	Motor & feedback connector.	Interconnectron motor receptacle (6 pin) and feedback receptacle (17 pin) (for motors fitted with encoder)
C68	Feedback plug.	Interconnectron straight plug (12 pin) & cable clamp for C47.
C69	Feedback plug.	Interconnectron straight plug (17 pin) & cable clamp for C48.
C67	Motor plug.	Interconnectron straight plug (6 pin) & cable clamp for C47/C48.
C70	Flying Leads	Motor and feedback leads 0.5m long.
C00	Motor & feedback connector.	Souriau 6 pin motor receptacle, 9 pin feedback receptacle, high profile facing non-drive end.
C01	Motor & feedback connector.	As C00 but facing drive end.
C11	Feedback plug & cable clamp.	Straight plug & cable clamp for C00, C01.
C09	Motor plug & cable clamp.	Straight plug & cable clamp for C00, C01.
THERMAL PROTECTION		
P21*	Thermal overload.	Bi-metal thermal switch.
P17	Thermal overload.	Temperature sensor, Phillips type KTY 84-130.
P18	No thermal overload.	Thermal protection not fitted.
ENCLOSURE PROTECTION		
W02*	IP64/65 enclosure.	Nitrile shaft seal for IP64/65 protection (supplied loose).
W00	IP64/65 enclosure.	Nitrile shaft seal for IP64/65 protection (factory fitted).
W99	No Shaft Seal Fitted	
UL APPROVAL		
U00	UL approved motor	

* Standard feature

**Other line counts available on request, not available on the motors HR70C brake & HR70E brake & non brake

HR92C4

HR92E4

HR92G4

HR92J4

HR92

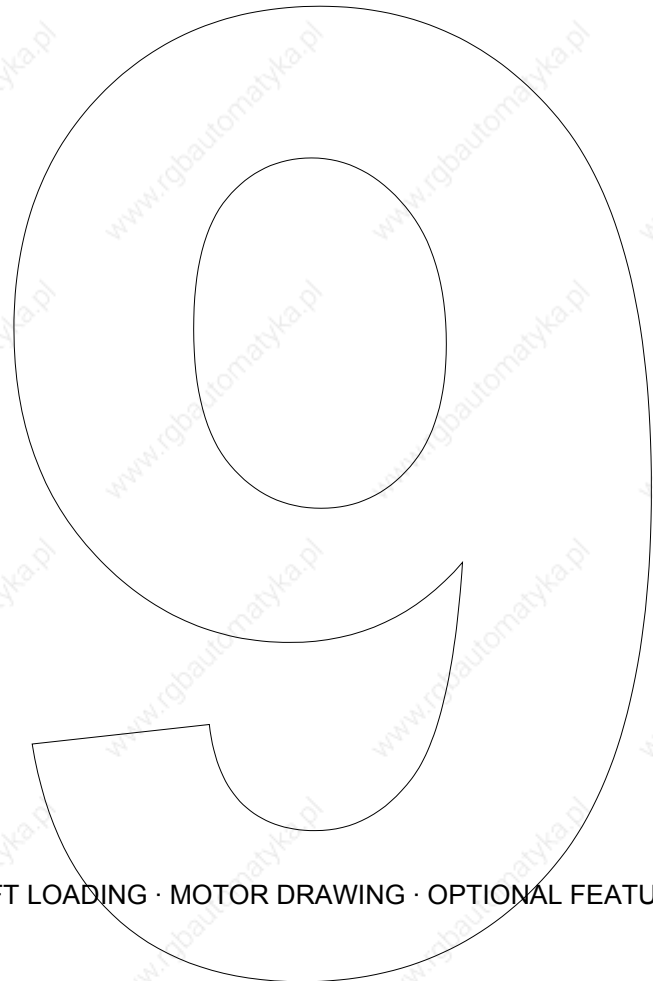

DATA TABLES · PERFORMANCE CURVES · SHAFT LOADING · MOTOR DRAWING · OPTIONAL FEATURES

HR92C4

Brushless AC Servomotors

9

Technical Data

Parameter	Units	HR92C4-64	HR92C4-44	HR92C4-32
GENERAL				
Voltage Gradient No Load	Line-Line Volts (Peak)/1000RPM	64	44	32
Max. Motor EMF	Line - Line Volts	380	260	190
Max. Speed	RPM	6000	6000	6000
Continuous Stall Torque TENV				
	Nm	1.5	1.5	1.5
	lb-in	13.3	13.3	13.3
(Size 300 x 300 x 12 mm)	Nm	1.6	1.6	1.6
Cont. Stall Torque when fitted to Heatsink (Size 12 x 12 x 0.5 in)	lb-in	14.0	14.0	14.0
Peak Stall Torque	Nm	4.6	4.6	4.6
	lb-in	41	41	41
Continuous stall current rms (110K) ^ψ	Amps	2	2.9	4
Rotor Polar Moment of Inertia (Inclusive of Resolver Inertia)	kgcm ² lb-in Sec ²	0.94 0.00083	0.94 0.00083	0.94 0.00083
Max. Current (Peak)	Amps	11	16	22
Cogging Torque (No shaft seal fitted)	Nm lb-in	0.048 0.425	0.048 0.425	0.048 0.425
Torque Constant Kt_{rms}*†				
	Nm/Amp	0.75	0.51	0.375
	lb-in/Amp	6.6	4.5	3.3
STATOR WINDING				
Resistance Line-Line*	Ohms	9.2	4.6	2.6
Inductance Line-Line	MilliHenrys	43	20	10.8
THERMAL				
Insulation Class		F	F	F
Max. Ambient Temperature	°C °F	40 104	40 104	40 104
Thermal Time Constant	Minutes	28	28	28
Thermal Resistance	°C/Watt °F/Watt	1.25 2.2	1.25 2.2	1.25 2.2
MECHANICAL				
Static Friction Torque	Nm lb	0.04 0.35	0.04 0.35	0.04 0.35
Motor Weight	kg lb	4.3 9.5	4.3 9.5	4.3 9.5

Notes

- Tolerance** - All data is subject to a tolerance of $\pm 10\%$ (except motor 'Voltage Gradient' and Kt which are to $+15\%/-5\%$).
- *** - At 25°C.
- †** - Note that Kt is shown as a combined value for all **three phases**.
- ψ** - The temperature rise ΔT on the windings is 110K and applies to all continuous torque values. The maximum ambient temperature is 40°C and therefore the temperature on the windings should not be more than 150°C. A value higher than 150°C would exceed the class F insulation temperature specification.

HR92E4

Brushless AC Servomotors

9

Technical Data

Parameter	Units	HR92E4-64	HR92E4-44	HR92E4-32
GENERAL				
Voltage Gradient No Load	Line-Line Volts (Peak)/1000RPM	64	44	32
Max. Motor EMF	Line - Line Volts	380	260	190
Max. Speed	RPM	6000	6000	6000
Continuous Stall Torque TENV				
	Nm	2.2	2.2	2.2
	lb-in	19	19	19
(Size 300 x 300 x 12 mm)	Nm	2.4	2.4	2.4
Cont. Stall Torque when fitted to Heatsink (Size 12 x 12 x 0.5 in)	lb-in	21	21	21
Peak Stall Torque	Nm	6.9	6.9	6.9
	lb-in	61	61	61
Continuous stall current rms (110K) ^ψ	Amps	2.9	4.3	5.9
Rotor Polar Moment of Inertia (Inclusive of Resolver Inertia)	kgcm ² lb-in Sec ²	1.3 0.00115	1.3 0.00115	1.3 0.00115
Max. Current (Peak)	Amps	16	23	32
Cogging Torque (No shaft seal fitted)	Nm lb-in	0.062 0.54	0.062 0.54	0.062 0.54
Torque Constant Kt_{rms}^{*†}	Nm/Amp lb-in/Amp	0.75 6.6	0.51 4.5	0.375 3.33
STATOR WINDING				
Resistance Line-Line*	Ohms	5	2.4	1.23
Inductance Line-Line	MilliHenrys	30	14	7.5
THERMAL				
Insulation Class		F	F	F
Max. Ambient Temperature	°C °F	40 104	40 104	40 104
Thermal Time Constant	Minutes	30	30	30
Thermal Resistance	°C/Watt °F/Watt	1.03 2	1.03 2	1.03 2
MECHANICAL				
Static Friction Torque	Nm lb	0.04 0.35	0.04 0.35	0.04 0.35
Motor Weight	kg lb	5.2 11.5	5.2 11.5	5.2 11.5

Notes

- Tolerance** - All data is subject to a tolerance of $\pm 10\%$ (except motor 'Voltage Gradient' and Kt which are to $+15\%/-5\%$).
***** - At 25°C.
- †** - Note that Kt is shown as a combined value for all **three phases**.
- ψ** - The temperature rise ΔT on the windings is 110K and applies to all continuous torque values. The maximum ambient temperature is 40°C and therefore the temperature on the windings should not be more than 150°C. A value higher than 150°C would exceed the class F insulation temperature specification.

HR92G4

Brushless AC Servomotors

9

Technical Data

Parameter	Units	HR92G4-64	HR92G4-44	HR92G4-32
GENERAL				
Voltage Gradient No Load	Line-Line Volts (Peak)/1000RPM	64	44	32
Max. Motor EMF	Line - Line Volts	380	260	190
Max. Speed	RPM	6000	6000	6000
Continuous Stall Torque TENV				
	Nm	3	3	3
	lb-in	27	27	27
(Size 300 x 300 x 12 mm)	Nm	3.3	3.3	3.3
Cont. Stall Torque when fitted to Heatsink				
(Size 12 x 12 x 0.5 in)	lb-in	29	29	29
Peak Stall Torque	Nm	9.2	9.2	9.2
	lb-in	81	81	81
Continuous stall current rms (110K) ^ψ	Amps	4	5.8	8
Rotor Polar Moment of Inertia	kgcm ²	1.6	1.6	1.6
(Inclusive of Resolver Inertia)	lb-in Sec ²	0.0014	0.0014	0.0014
Max. Current (Peak)	Amps	22	32	43
Cogging Torque	Nm	0.076	0.076	0.076
(No shaft seal fitted)	lb-in	0.068	0.068	0.068
Torque Constant Kt_{rms}^{*†}	Nm/Amp	0.75	0.51	0.375
	lb-in/Amp	6.6	4.5	3.33
STATOR WINDING				
Resistance Line-Line*	Ohms	3.4	1.5	0.86
Inductance Line-Line	MilliHenrys	19	8.9	4.7
THERMAL				
Insulation Class		F	F	F
Max. Ambient Temperature	°C	40	40	40
	°F	104	104	104
Thermal Time Constant	Minutes	32	32	32
Thermal Resistance	°C/Watt	0.92	0.92	0.92
	°F/Watt	1.7	1.7	1.7
MECHANICAL				
Static Friction Torque	Nm	0.04	0.04	0.04
	lb	0.35	0.35	0.35
Motor Weight	kg	5.8	5.8	5.8
	lb	12.8	12.8	12.8

Notes

- Tolerance** - All data is subject to a tolerance of $\pm 10\%$ (except motor 'Voltage Gradient' and Kt which are to $+15\%/-5\%$).
- *** - At 25°C.
- †** - Note that Kt is shown as a combined value for all **three phases**.
- ψ** - The temperature rise ΔT on the windings is 110K and applies to all continuous torque values. The maximum ambient temperature is 40°C and therefore the temperature on the windings should not be more than 150°C. A value higher than 150°C would exceed the class F insulation temperature specification.

HR92J4

Brushless AC Servomotors

9

Technical Data

Parameter	Units	HR92J4-88	HR92J4-64	HR92J4-44
GENERAL				
Voltage Gradient No Load	Line-Line Volts (Peak)/1000RPM	88	64	44
Max. Motor EMF	Line - Line Volts	530	380	260
Max. Speed	RPM	6000	6000	6000
Continuous Stall Torque TENV				
	Nm	3.8	3.8	3.8
	lb-in	34	34	34
(Size 300 x 300 x 12 mm)	Nm	4.1	4.1	4.1
Cont. Stall Torque when fitted to Heatsink (Size 12 x 12 x 0.5 in)	lb-in	36	36	36
Peak Stall Torque	Nm	11.5	11.5	11.5
	lb-in	101	101	101
Continuous stall current rms (110K) ^ψ	Amps	3.7	5.1	7.4
Rotor Polar Moment of Inertia (Inclusive of Resolver Inertia)	kgcm ² lb-in Sec ²	2 0.0018	2 0.0018	2 0.0018
Max. Current (Peak)	Amps	20	27	39
Cogging Torque (No shaft seal fitted)	Nm lb-in	0.09 0.81	0.09 0.81	0.09 0.81
Torque Constant Kt_{rms}^{*†}	Nm/Amp lb-in/Amp	1.02 9	0.75 6.6	0.51 4.5
STATOR WINDING				
Resistance Line-Line*	Ohms	5	2.5	1.24
Inductance Line-Line	MilliHenrys	29	15	7.2
THERMAL				
Insulation Class		F	F	F
Max. Ambient Temperature	°C °F	40 104	40 104	40 104
Thermal Time Constant	Minutes	33	33	33
Thermal Resistance	°C/Watt °F/Watt	0.77 1.38	0.77 1.38	0.77 1.38
MECHANICAL				
Static Friction Torque	Nm lb	0.04 0.35	0.04 0.35	0.04 0.35
Motor Weight	kg lb	6.6 15	6.6 15	6.6 15

Notes

- Tolerance** - All data is subject to a tolerance of $\pm 10\%$ (except motor 'Voltage Gradient' and Kt which are to $+15\%/-5\%$).
***** - At 25°C.
- †** - Note that Kt is shown as a combined value for all **three phases**.
- ψ** - The temperature rise ΔT on the windings is 110K and applies to all continuous torque values. The maximum ambient temperature is 40°C and therefore the temperature on the windings should not be more than 150°C. A value higher than 150°C would exceed the class F insulation temperature specification.

HR92 PERMITTED RADIAL SHAFT LOADING

(Axial loadings may be considered separately – refer to next page)

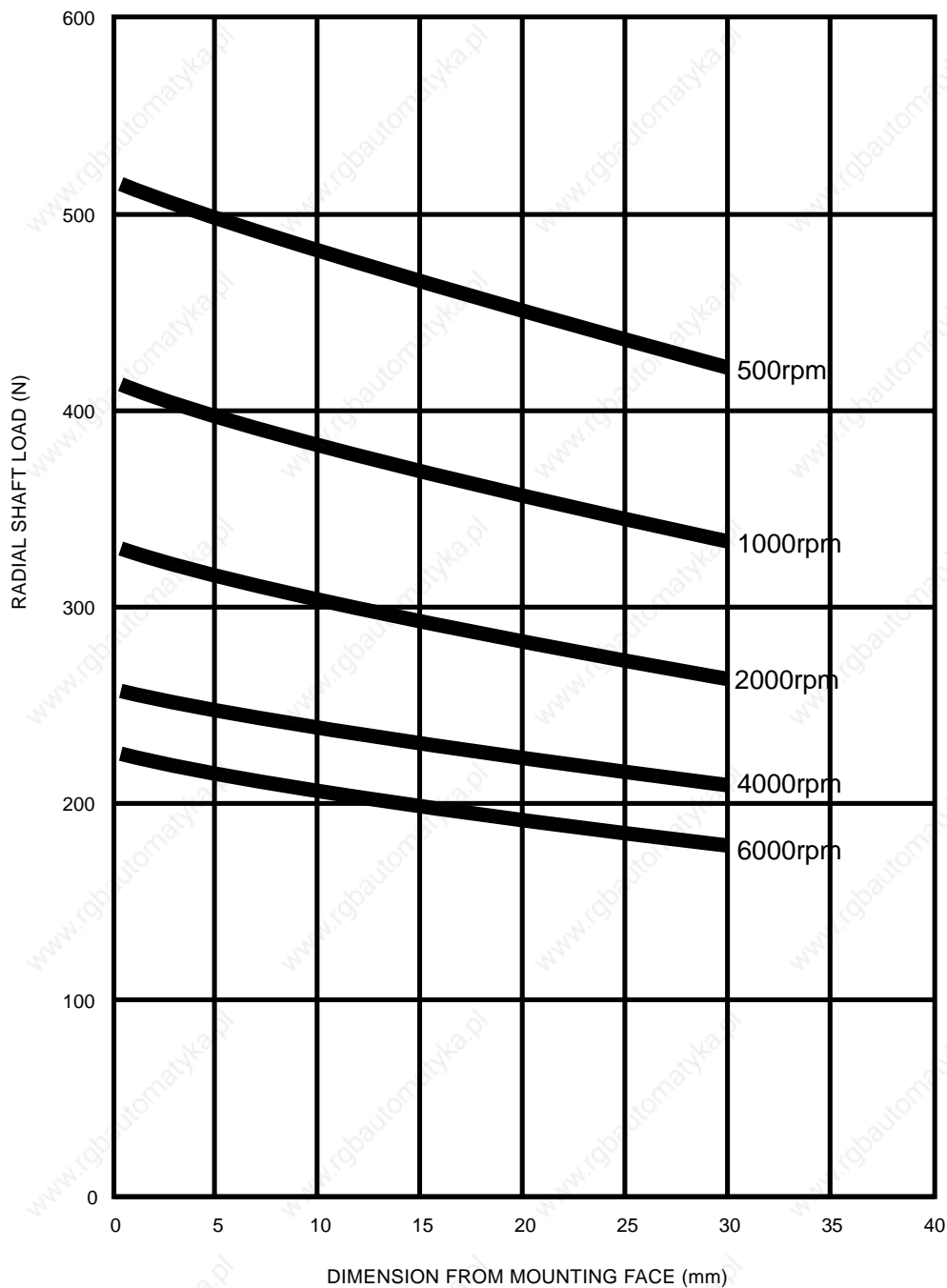

Shaft Loading Information for SEM Standard Servomotors

General notes:-

- 1 All loadings are based upon An L10 bearing life expectancy of 30,000 hours.
- 2 Separate graphs are usually supplied to indicate maximum axial loads which are applicable. However, for motors with locked drive end bearings, a graph is used to illustrate the maximum allowed radial shaft loadings together with a simplified calculation to provide a compensated figure for when radial and axial loadings are to be applied in combination.
- 3 It may occur, in certain circumstances, that loading outside the scope of the published information is deemed necessary. In these cases it is desirable that SEM Ltd should be consulted and all relevant information made available, in order that due consideration can be given to finding a satisfactory solution.
- 4 Should motors be required to operate under abnormal conditions, such as excessive vibration or shock, this should also be referred to SEM Ltd as noted above.

HR92 PERMITTED AXIAL LOAD

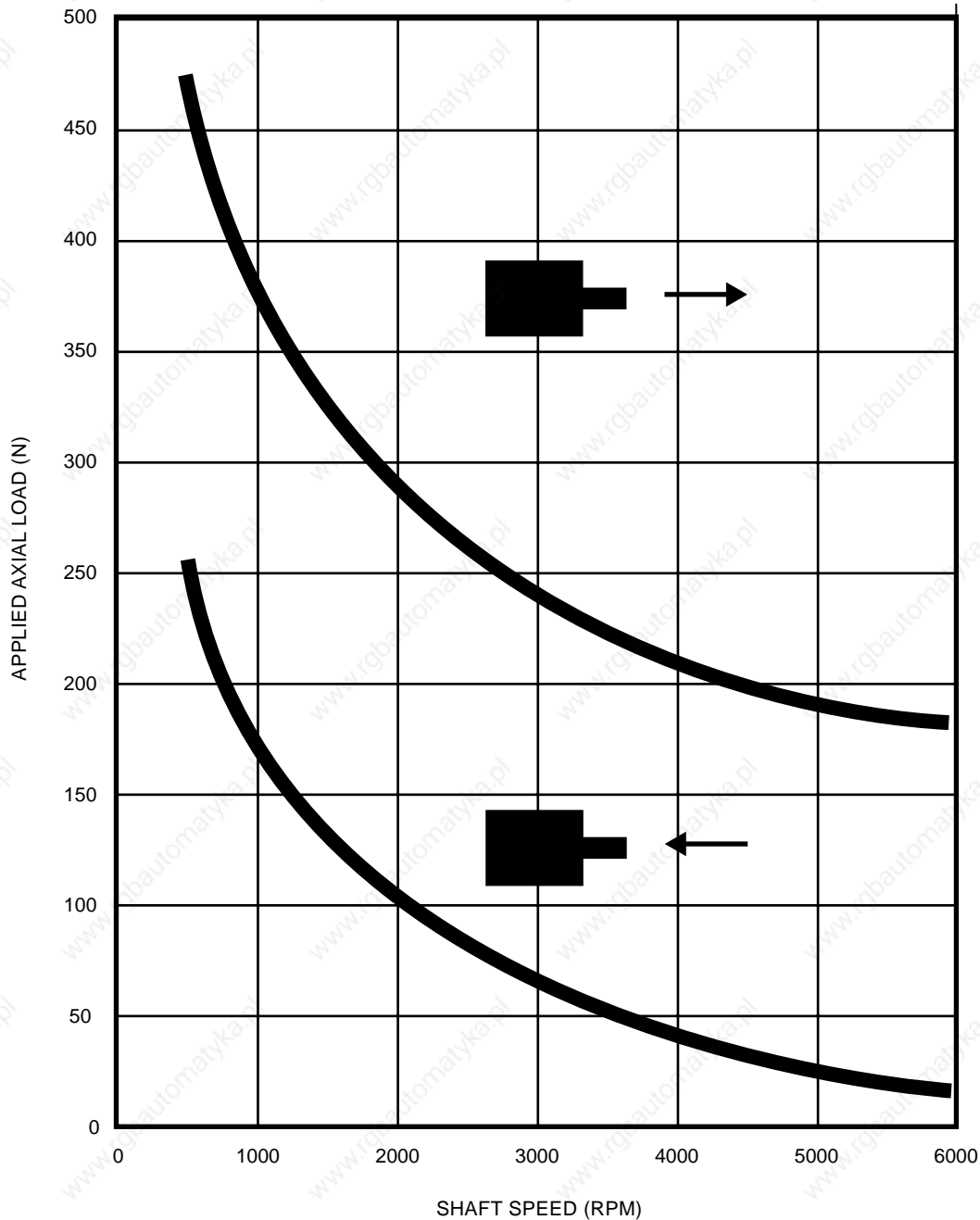

Shaft Loading Information for SEM Standard Servomotors

General notes:-

- 1 All loadings are based upon An L10 bearing life expectancy of 30,000 hours.
- 2 Separate graphs are usually supplied to indicate maximum axial loads which are applicable. However, for motors with locked drive end bearings, a graph is used to illustrate the maximum allowed radial shaft loadings together with a simplified calculation to provide a compensated figure for when radial and axial loadings are to be applied in combination.
- 3 It may occur, in certain circumstances, that loading outside the scope of the published information is deemed necessary. In these cases it is desirable that SEM Ltd should be consulted and all relevant information made available, in order that due consideration can be given to finding a satisfactory solution.
- 4 Should motors be required to operate under abnormal conditions, such as excessive vibration or shock, this should also be referred to SEM Ltd as noted above.

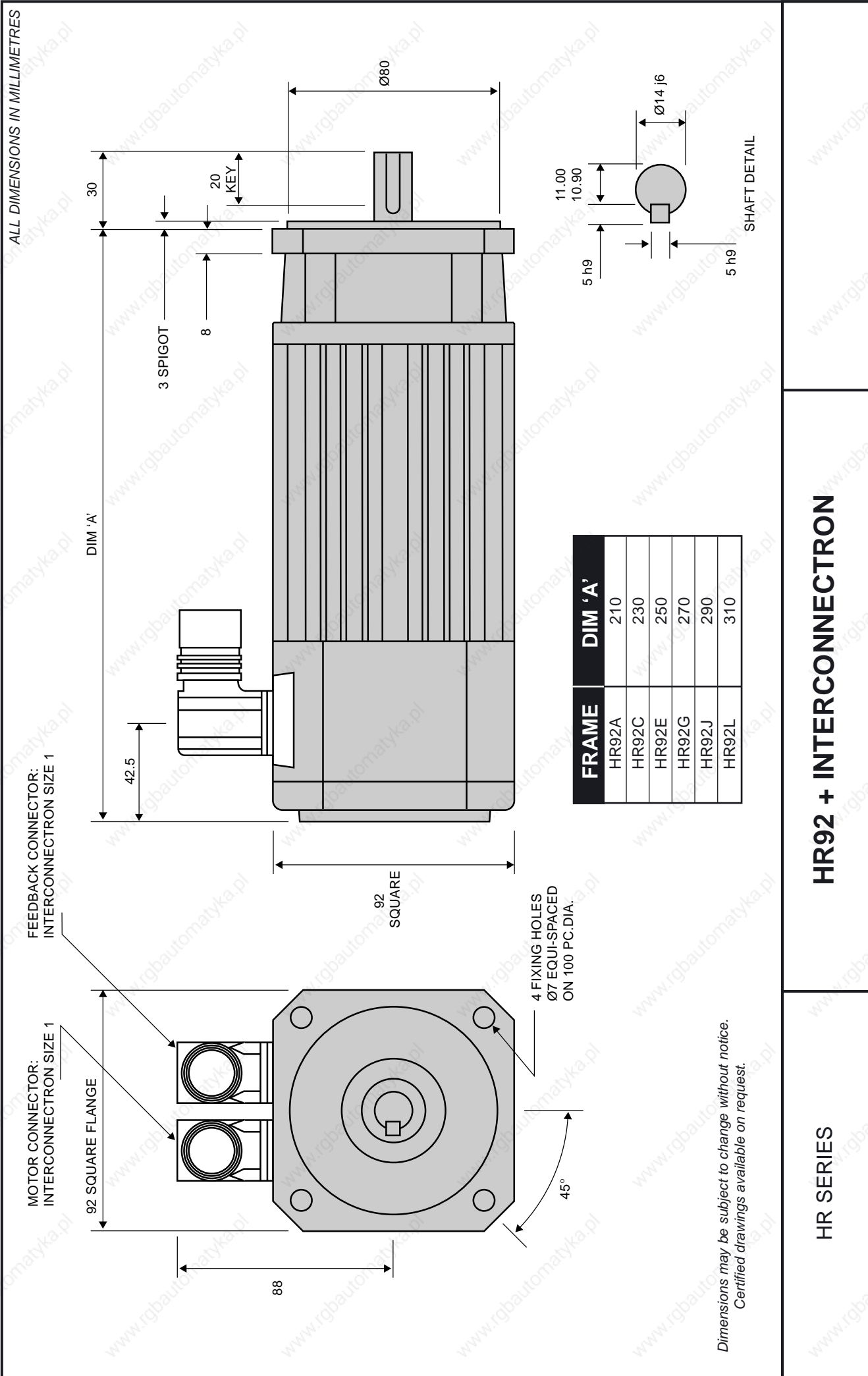

HR SERIES

HR92 + INTERCONNECTRON

ALL DIMENSIONS IN MILLIMETRES

FEEDBACK CONNECTOR
MS3102E-20-29P

MOTOR CONNECTOR
MS3102E-20-15P

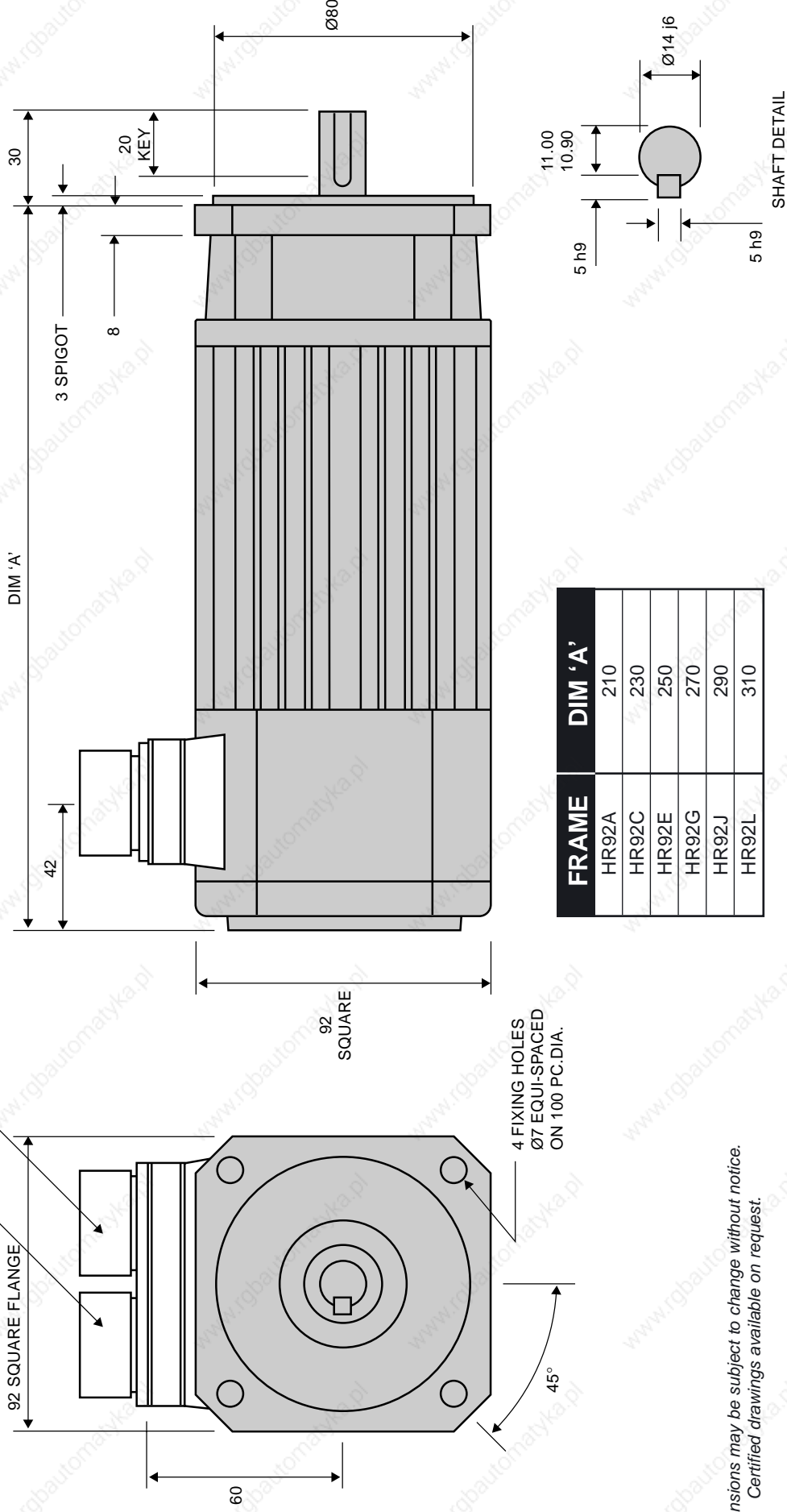

Dimensions may be subject to change without notice.
Certified drawings available on request.

HR SERIES

HR92 + MS CONNECTORS

ALL DIMENSIONS IN MILLIMETRES

NOTE: Terminal box may be rotated into any one of four positions

MOTOR CONNECTION VIA M20 ACCESS TO TERMINALS
 FEEDBACK CONNECTOR MS3102E-20-29P

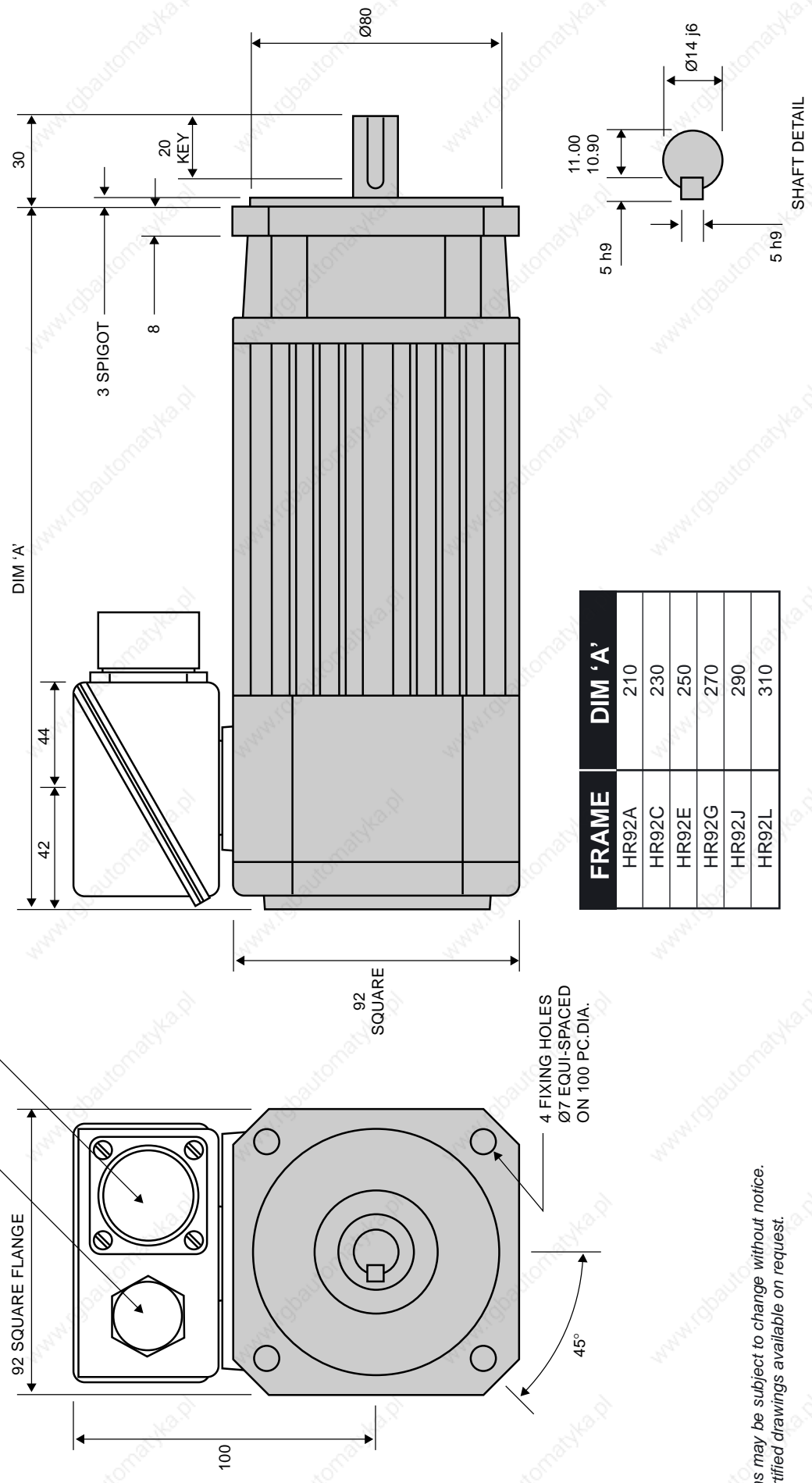

FRAME	DIM 'A'
HR92A	210
HR92C	230
HR92E	250
HR92G	270
HR92J	290
HR92L	310

4 FIXING HOLES Ø7 EQUI-SPACED ON 100 PC.DIA.

HR SERIES

HR92 + TERMINAL BOX

Dimensions may be subject to change without notice.
 Certified drawings available on request.

HR92 - OPTIONS (metric series)

9

Code	Description	Notes
WAVEFORM (WINDING)		
Y00*	Waveform.	Sinusoidal waveform.
FEEDBACK DEVICES		
F00*	Resolver (F00 setting).	2 Pole Resolver type 21-B with F00 setting.
F16	Resolver (F16 setting)	2 Pole Resolver type 21-B with alternative F16 setting.
F66	No Feedback fitted	
FITTED ENCODERS		
E15	Encoder	Heidenhain ERN1387 series, 2048ppr.
E22	Encoder, singleturn, Optical	Heidenhain ECN1313 series, 2048ppr with EnDat Interface.
E16	Encoder, multiturn, Optical	Heidenhain EQN1325 series, 2048ppr with EnDat Interface.
E33	Encoder, singleturn, Inductive	Heidhenhain ECI1319 series, 32ppr with EnDat Interface
E34	Encoder, multiturn, Inductive	Heidhenhain ECI1331 series, 32ppr with EnDat Interface
E20	Encoder, singleturn.	Stegmann SRS50 series with Hiperface Interface.
E21	Encoder, multiturn.	Stegmann SRM50 series with Hiperface Interface.
E26**	Incremental encoder	Renco R35i, 1000ppr
E28**	Incremental encoder	Renco R35i, 2048ppr
E29**	Incremental encoder	Renco R35i, 4000ppr
E31**	Incremental encoder	Renco R35i, 8192ppr
MECHANICAL INTERFACE		
M00*	Flange.	92 x 92 mm square flange. Spigot Ø 80mm. Fixing 4 x Ø 7 mm holes on 100 mm PCD.
R01	Close tolerance interface.	Flange & shaft to IEC72-P (precision).
S00*	Shaft.	Ø 14mm x 30mm long.
K00*	Keyway.	5 x 5 x 20 mm long.
K99	No Keyway.	Plain shaft.
D01*	Shaft end threaded hole.	M5 x 15mm deep.
BRAKES		
B00	24Vdc Brake.	5.0Nm Torque
B01	90Vdc Brake.	5.0Nm Torque
ELECTRICAL TERMINATIONS		
C47*	Motor & feedback connector.	Interconnectron motor receptacle (6 pin) and feedback receptacle (12 pin 20 degree offset) (for motors fitted with resolver)
C48	Motor & feedback connector.	Interconnectron motor receptacle (6 pin) and feedback receptacle (17 pin) (for motors fitted with encoder)
C68	Feedback plug.	Interconnectron straight plug (12 pin) & cable clamp for C47.
C69	Feedback plug.	Interconnectron straight plug (17 pin) & cable clamp for C48.
C67	Motor plug.	Interconnectron straight plug (6 pin) & cable clamp for C47/C48.
C00	Terminal Box	Terminal Box with 1 x M20 hole. Feedback MS receptacle (17 pin)
C01	Motor & feedback connector	MS Motor receptacle (7 pin), feedback receptacle (17 pin)
C04	Feedback plug & cable	Straight plug and cable clamp for C00, C01
C08	Motor Plug & cable	Straight plug and cable clamp for C01
THERMAL PROTECTION		
P21*	Thermal overload.	Bi-metal thermal switch.
P17	Thermal overload.	Temperature sensor, Phillips type KTY 84-130.
P18	No thermal overload.	Thermal protection not fitted.
ENCLOSURE PROTECTION		
W00*	IP64/65 enclosure.	Nitrile shaft seal for IP64/65 protection (factory fitted).
W01	IP64/65 enclosure.	Viton shaft seal for IP64/65 protection (factory fitted).
W02	IP64/65 enclosure.	Nitrile shaft seal for IP64/65 protection (supplied loose).
W03	IP64/65 enclosure.	Viton shaft seal for IP64/65 protection (supplied loose).
W99	No Shaft Seal Fitted	
UL APPROVAL		
U00	UL approved motor	

* Standard feature

** Other line counts available on request

HRS92C4

HRS92E4

HRS92G4

HRS92J4

HRS92

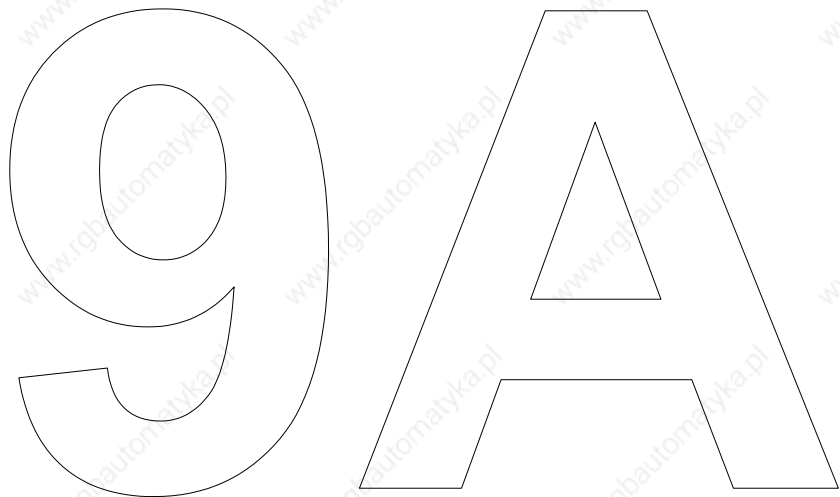

DATA TABLES · PERFORMANCE CURVES · SHAFT LOADING · MOTOR DRAWING · OPTIONAL FEATURES

HRS92C4 Brushless AC Servomotors

Technical Data

9A

Parameter	Units	HRS92C4-64S	HRS92C4-44S	HRS92C4-32S
GENERAL				
Voltage Gradient No Load	Line-Line Volts (Peak)/1000rpm	64	44	32
Max. Current (Peak)	A	11	16	22
Max. Motor EMF	Line-Line Volts	380	260	190
Max. Mechanical Speed Limit	rpm	6000	6000	6000
Continuous Stall Torque TENV (110K) ^ψ	Nm	1.5	1.5	1.5
	lb-in	13.3	13.3	13.3
(Size 300 x 300 x 12 mm)	Nm	1.6	1.6	1.6
Cont. Stall Torque when fitted to Heatsink (Size 12 x 12 x 0.5 in)	lb-in	14	14	14
Peak Stall Torque	Nm	4.6	4.6	4.6
	lb-in	41	41	41
Continuous Stall Current rms (110K) ^ψ	A	2	2.9	4
Rotor Polar Moment of Inertia (Inclusive of Resolver Inertia)	kgcm ² lb-in s ²	0.94 0.00083	0.94 0.00083	0.94 0.00083
Torque Constant 3 x K _{t_rms} ^{*†}	Nm/A lb-in/A	0.75 6.6	0.51 4.5	0.375 3.3
STATOR WINDING				
Resistance Line-Line*	Ω	9.2	4.6	2.6
Inductance Line-Line	mH	43	20	10.8
THERMAL				
Insulation Class		F	F	F
Max. Ambient Temperature	°C	40	40	40
	°F	104	104	104
Thermal Time Constant	minutes	28	28	28
Thermal Resistance	°C/W	1.23	1.23	1.23
	°F/W	2.2	2.2	2.2
MECHANICAL				
Static Friction Torque	Nm	0.04	0.04	0.04
	lb-in	0.35	0.35	0.35
Cogging Torque	Nm	0.048	0.048	0.048
	lb-in	0.42	0.42	0.42
Motor Weight	kg	4.1	4.1	4.1
	lb	9	9	9

Notes

- * - All data is subject to a tolerance of ±10% (except motor 'Voltage Gradient' and K_t which are to +15%/-5%).
- At 25°C.
- † - Note that K_t is shown as a combined value for all **three phases**.
- ψ - The temperature rise ΔT on the windings is 110K and applies to all continuous torque values. The maximum ambient temperature is 40°C and therefore the temperature on the windings should not be more than 150°C. A value higher than 150°C would exceed the class F insulation temperature specification.

DD0270 ISSUE 2

HR92C4/HRS92C4
on 150 VOLT

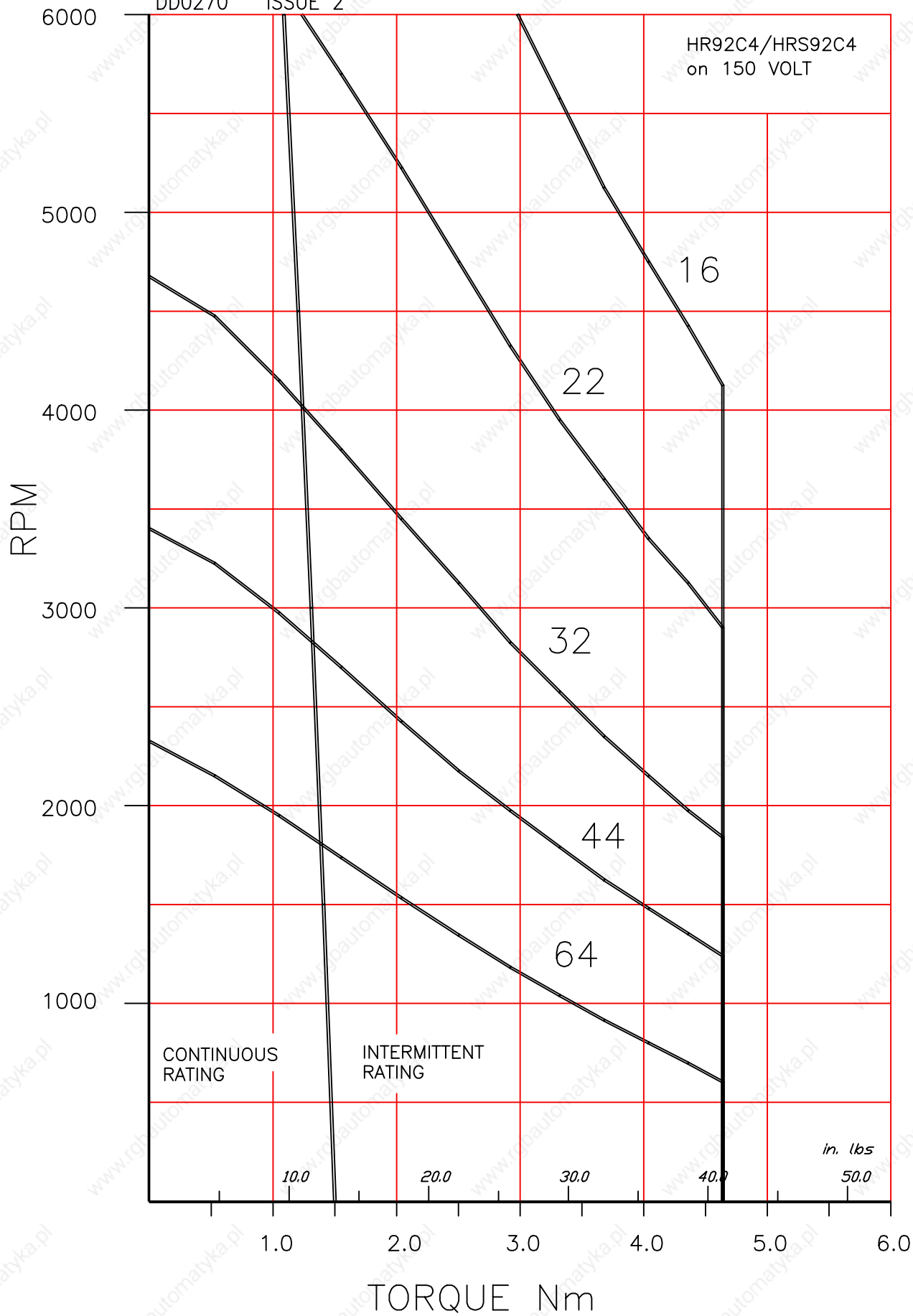

9A

9A

DD0276 ISSUE 2

HR92C4/HRS92C4
on 250 VOLT

RPM

6000

5000

4000

3000

2000

1000

22

32

44

64

88

130

CONTINUOUS
RATING

INTERMITTENT
RATING

in. lbs
50.0

10.0

20.0

30.0

40.0

1.0

2.0

3.0

4.0

5.0

6.0

TORQUE Nm

9A

9A

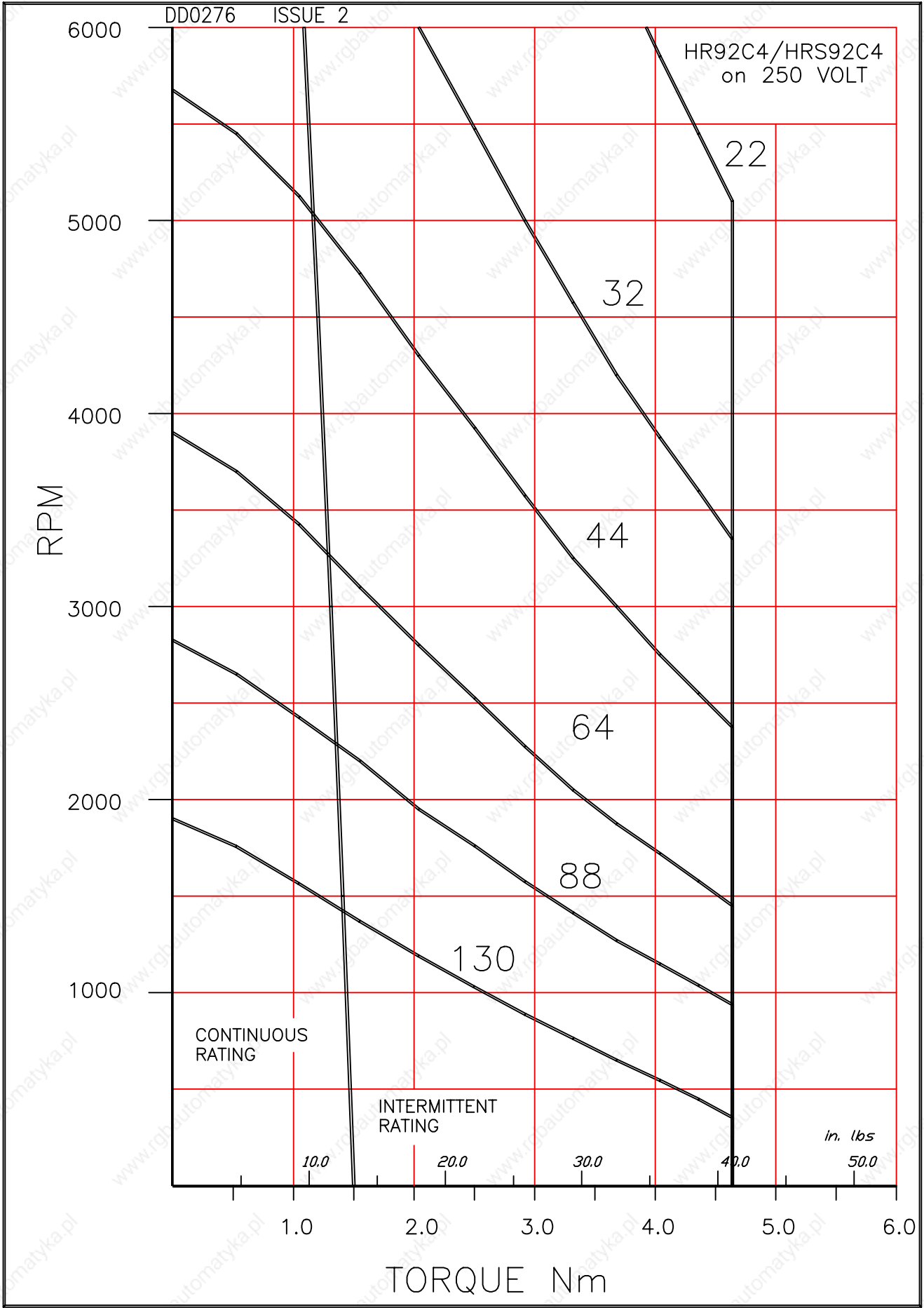

DD0282 ISSUE 2

HR92C4/HRS92C4
on 300 VOLT

RPM

6000
5000
4000
3000
2000
1000

CONTINUOUS
RATING

INTERMITTENT
RATING

10.0 20.0 30.0 40.0

in. lbs
50.0

TORQUE Nm

1.0 2.0 3.0 4.0 5.0 6.0

32

44

64

88

130

9A

9A

9A

9A

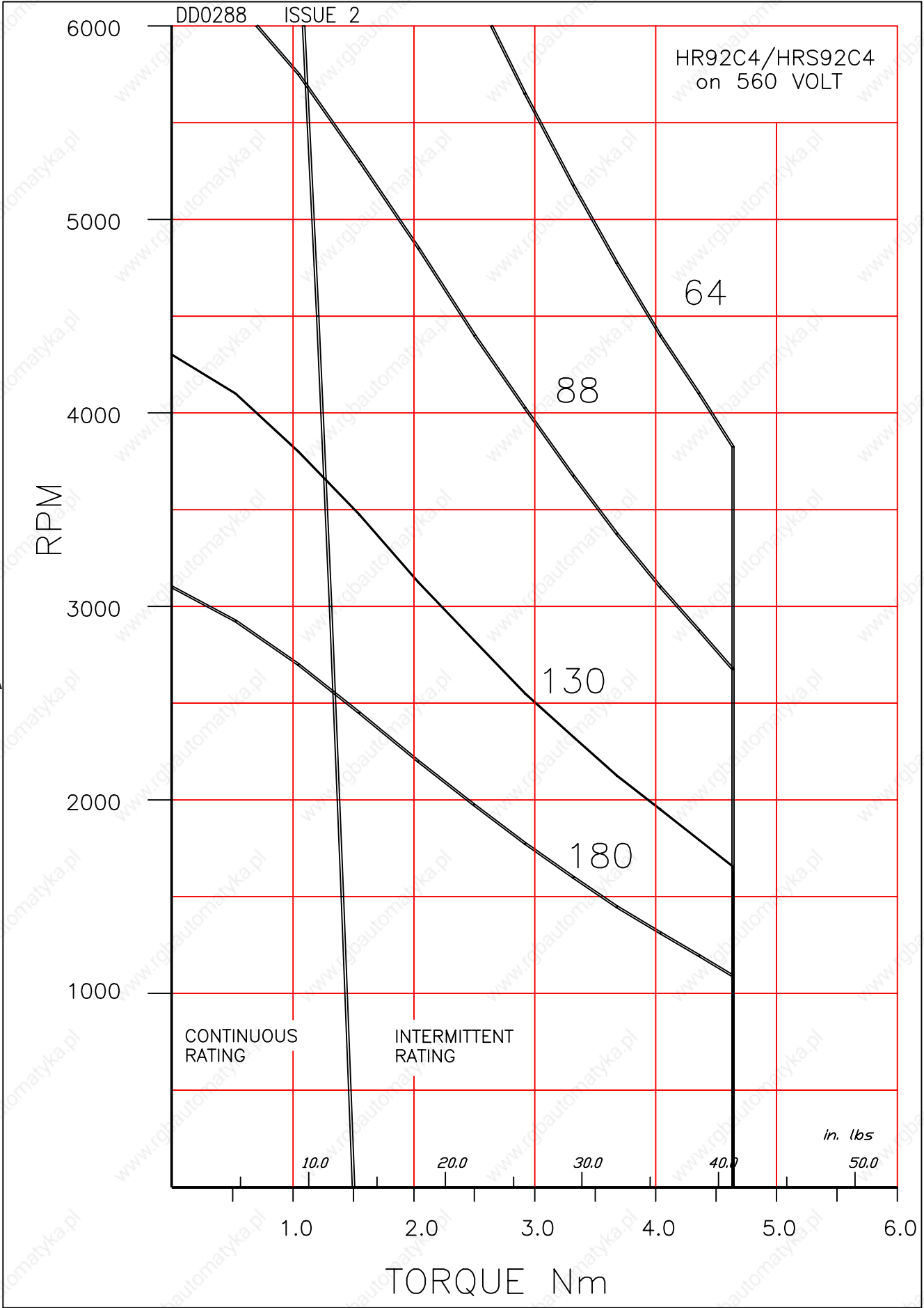

HRS92E4 Brushless AC Servomotors

Technical Data

9A

Parameter	Units	HRS92E4-64S	HRS92E4-44S	HRS92E4-32S
GENERAL				
Voltage Gradient No Load	Line-Line Volts (Peak)/1000rpm	64	44	32
Max. Current (Peak)	A	16	23	32
Max. Motor EMF	Line-Line Volts	380	260	190
Max. Mechanical Speed Limit	rpm	6000	6000	6000
Continuous Stall Torque TENV (110K) ^ψ	Nm	2.2	2.2	2.2
	lb-in	19	19	19
(Size 300 x 300 x 12 mm)	Nm	2.4	2.4	2.4
Cont. Stall Torque when fitted to Heatsink (Size 12 x 12 x 0.5 in)	lb-in	21	21	21
Peak Stall Torque	Nm	6.9	6.9	6.9
	lb-in	61	61	61
Continuous Stall Current rms (110K) ^ψ	A	2.9	4.3	5.9
Rotor Polar Moment of Inertia (Inclusive of Resolver Inertia)	kgcm ² lb-in s ²	1.3 0.00115	1.3 0.00115	1.3 0.00115
Torque Constant 3 x K _{t_rms} *†	Nm/A lb-in/A	0.75 6.6	0.51 4.5	0.375 3.3
STATOR WINDING				
Resistance Line-Line*	Ω	5.0	2.4	1.23
Inductance Line-Line	mH	30	14	7.5
THERMAL				
Insulation Class		F	F	F
Max. Ambient Temperature	°C	40	40	40
	°F	104	104	104
Thermal Time Constant	minutes	30	30	30
Thermal Resistance	°C/W	1.13	1.13	1.13
	°F/W	2	2	2
MECHANICAL				
Static Friction Torque	Nm	0.04	0.04	0.04
	lb-in	0.35	0.35	0.35
Cogging Torque	Nm	0.062	0.062	0.062
	lb-in	0.55	0.55	0.55
Motor Weight	kg	4.9	4.9	4.9
	lb	10.8	10.8	10.8

Notes

- * - All data is subject to a tolerance of ±10% (except motor 'Voltage Gradient' and K_t which are to +15%/-5%).
- At 25°C.
- † - Note that K_t is shown as a combined value for all **three phases**.
- ψ - The temperature rise ΔT on the windings is 110K and applies to all continuous torque values. The maximum ambient temperature is 40°C and therefore the temperature on the windings should not be more than 150°C. A value higher than 150°C would exceed the class F insulation temperature specification.

DD0271 ISSUE 2

HR92E4/HRS92E4
on 150V

RPM

6000

5000

4000

3000

2000

1000

22

32

44

64

CONTINUOUS
RATING

INTERMITTENT
RATING

20

40

60

80 in.lb

2

4

6

8

Nm

10

TORQUE Nm

9A

9A

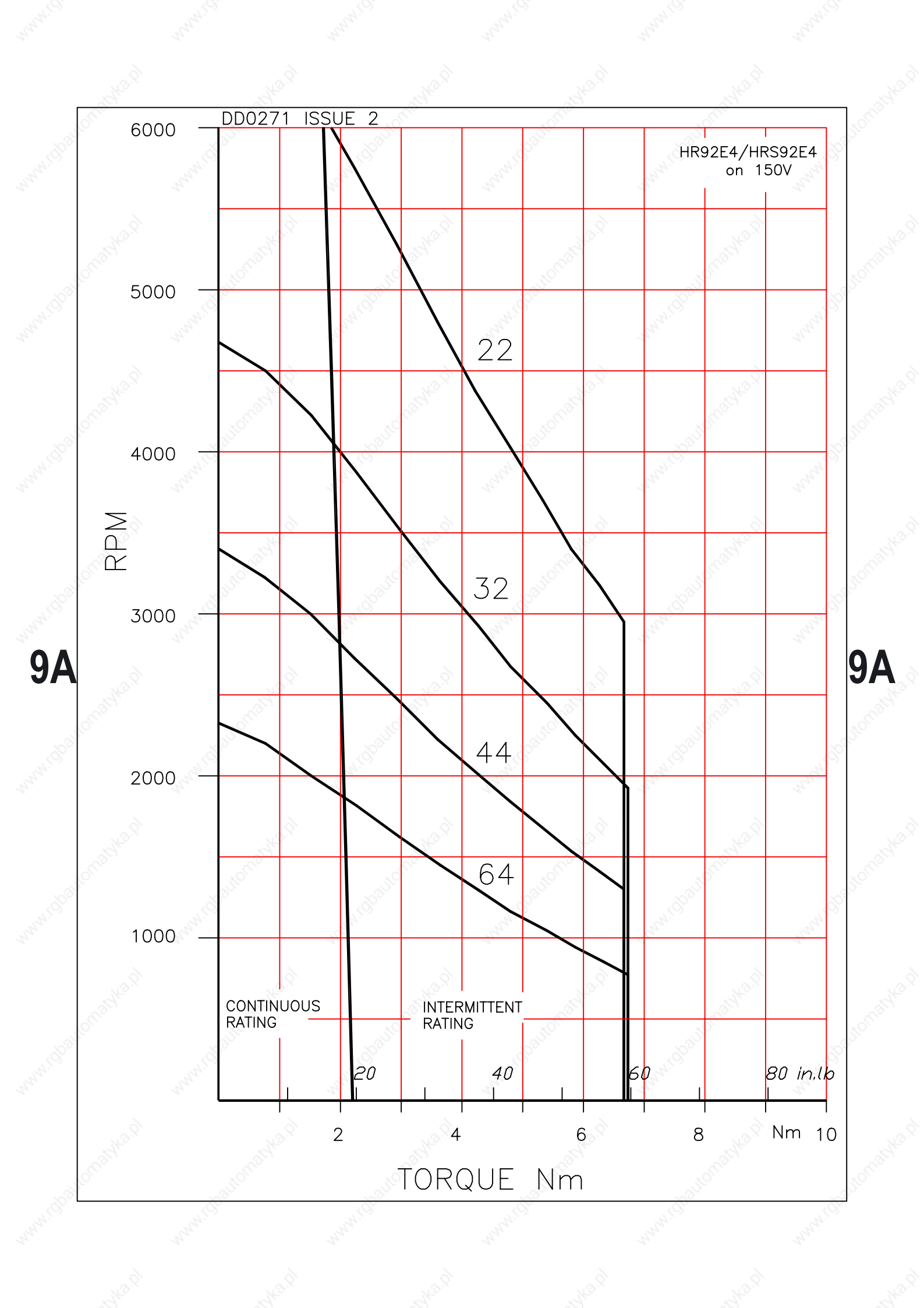

DD0277 ISSUE 2

HR92E4/HRS92E4
on 250V

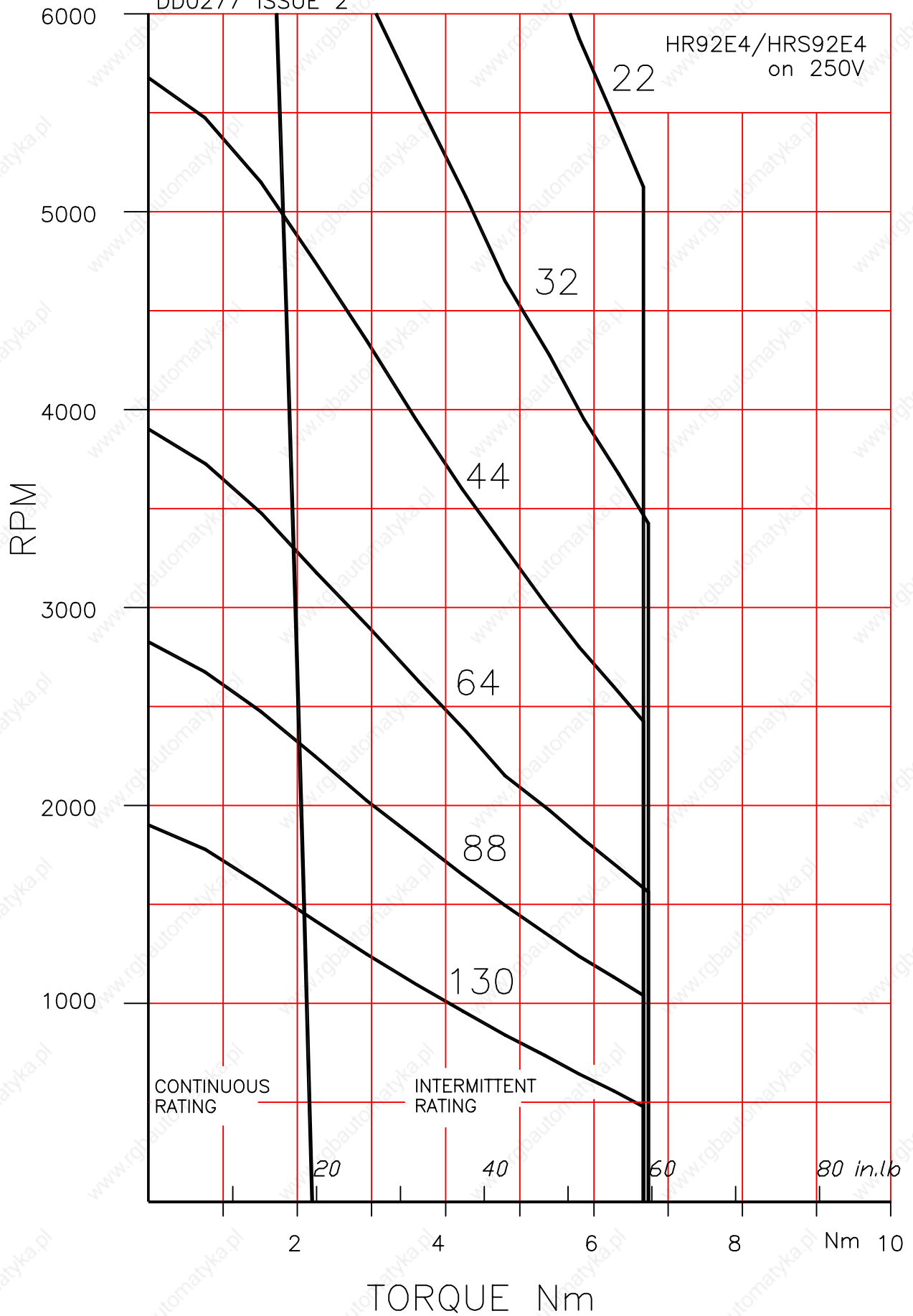

9A

9A

DD0283 ISSUE 2

HR92E4/HRS92E4
on 300V

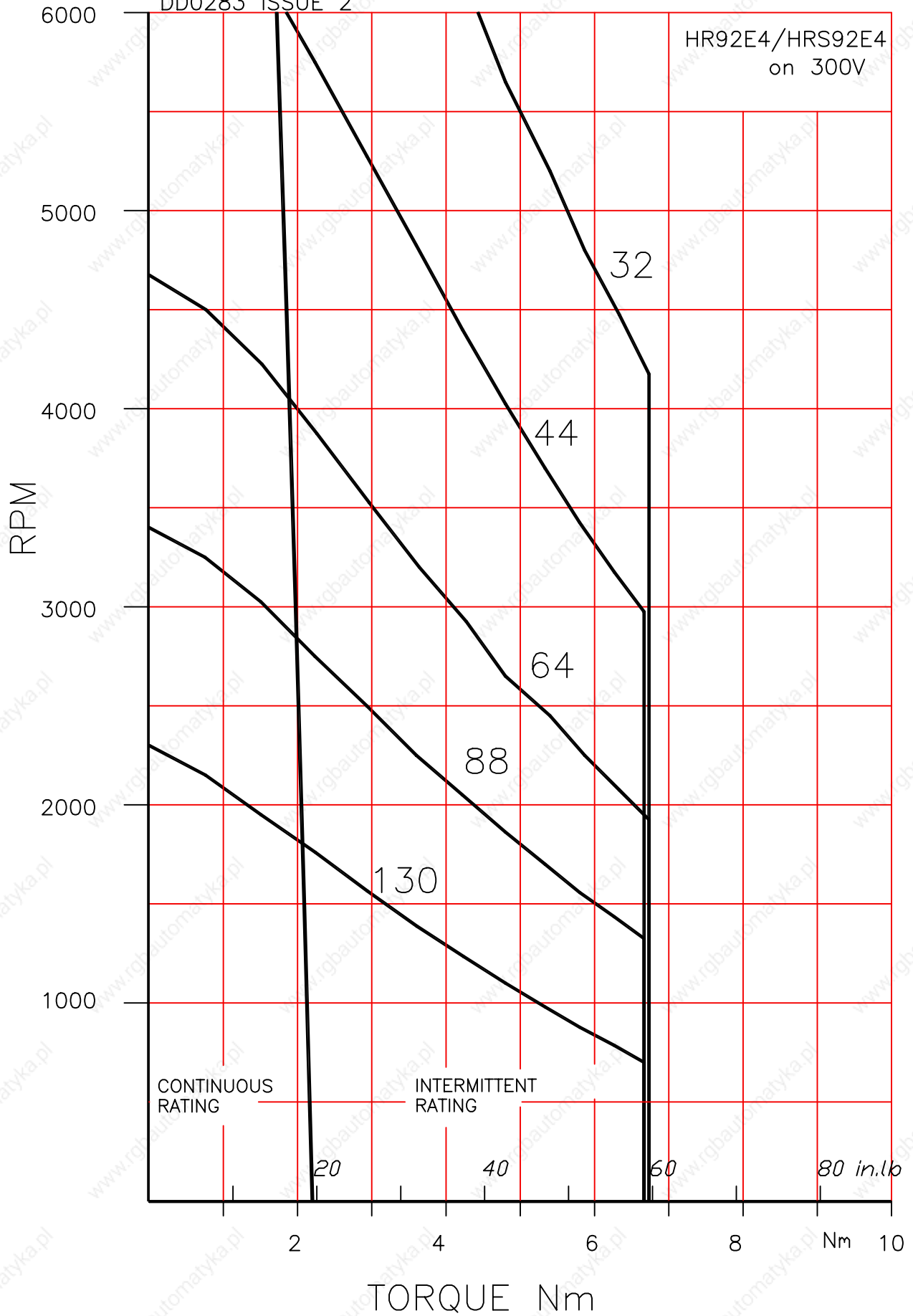

9A

9A

DD0289 ISSUE 2

HR92E4/HRS92E4
on 560V

RPM

6000

5000

4000

3000

2000

1000

64

88

130

180

260

CONTINUOUS
RATING

INTERMITTENT
RATING

20

40

60

80 in.lb

2

4

6

8

Nm 10

TORQUE Nm

9A

9A

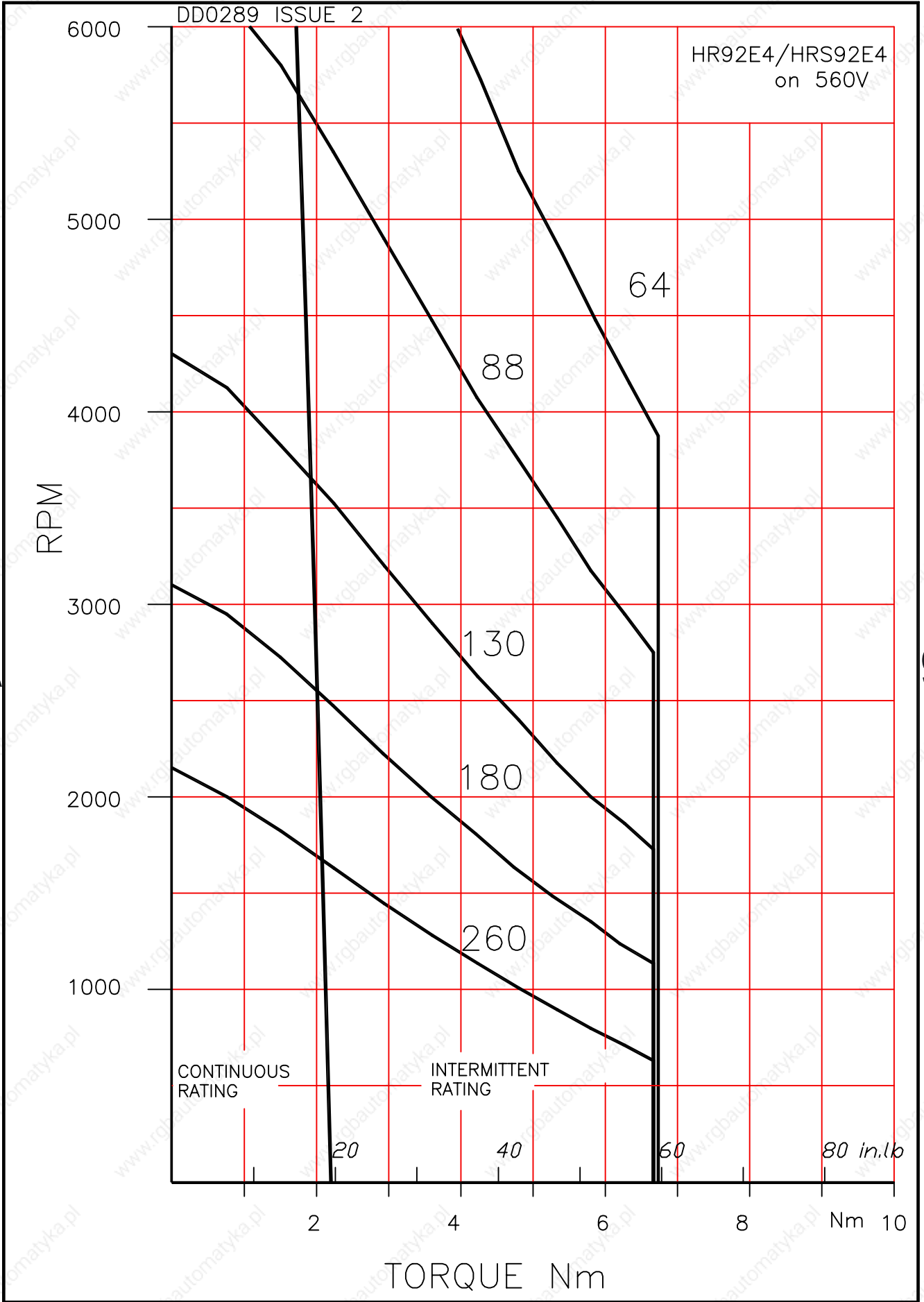

HRS92G4 Brushless AC Servomotors

9A

Technical Data

Parameter	Units	HRS92G4-64S	HRS92G4-44S	HRS92G4-32S
GENERAL				
Voltage Gradient No Load	Line-Line Volts (Peak)/1000rpm	64	44	32
Max. Current (Peak)	A	22	32	43
Max. Motor EMF	Line-Line Volts	380	260	190
Max. Mechanical Speed Limit	rpm	6000	6000	6000
Continuous Stall Torque TENV (110K) ^ψ	Nm	3	3	3
	lb-in	27	27	27
(Size 300 x 300 x 12 mm)	Nm	3.3	3.3	3.3
Cont. Stall Torque when fitted to Heatsink (Size 12 x 12 x 0.5 in)	lb-in	29	29	29
Peak Stall Torque	Nm	9.2	9.2	9.2
	lb-in	81	81	81
Continuous Stall Current rms (110K) ^ψ	A	4	5.8	8
Rotor Polar Moment of Inertia (Inclusive of Resolver Inertia)	kgcm ² lb-in s ²	1.6 0.0014	1.6 0.0014	1.6 0.0014
Torque Constant 3 x K _{t_rms} * [†]	Nm/A lb-in/A	0.75 6.6	0.51 4.5	0.375 3.3
STATOR WINDING				
Resistance Line-Line*	Ω	3.4	1.5	0.86
Inductance Line-Line	mH	19	8.9	4.7
THERMAL				
Insulation Class		F	F	F
Max. Ambient Temperature	°C	40	40	40
	°F	104	104	104
Thermal Time Constant	minutes	32	32	32
Thermal Resistance	°C/W	0.92	0.92	0.92
	°F/W	1.7	1.7	1.7
MECHANICAL				
Static Friction Torque	Nm	0.04	0.04	0.04
	lb-in	0.35	0.35	0.35
Cogging Torque	Nm	0.076	0.076	0.076
	lb-in	0.67	0.67	0.67
Motor Weight	kg	5.7	5.7	5.7
	lb	12.6	12.6	12.6

Notes

- * - All data is subject to a tolerance of ±10% (except motor 'Voltage Gradient' and K_t which are to +15%/-5%).
- At 25°C.
- † - Note that K_t is shown as a combined value for all **three phases**.
- ψ - The temperature rise ΔT on the windings is 110K and applies to all continuous torque values. The maximum ambient temperature is 40°C and therefore the temperature on the windings should not be more than 150°C. A value higher than 150°C would exceed the class F insulation temperature specification.

DD0272 ISSUE 2

HR92G4/HRS92G4
on 150 VOLT

RPM

6000

5000

4000

3000

2000

1000

CONTINUOUS
RATING

INTERMITTENT
RATING

20

40

60

80

100

in. lbs
120

TORQUE Nm

32

44

64

9A

9A

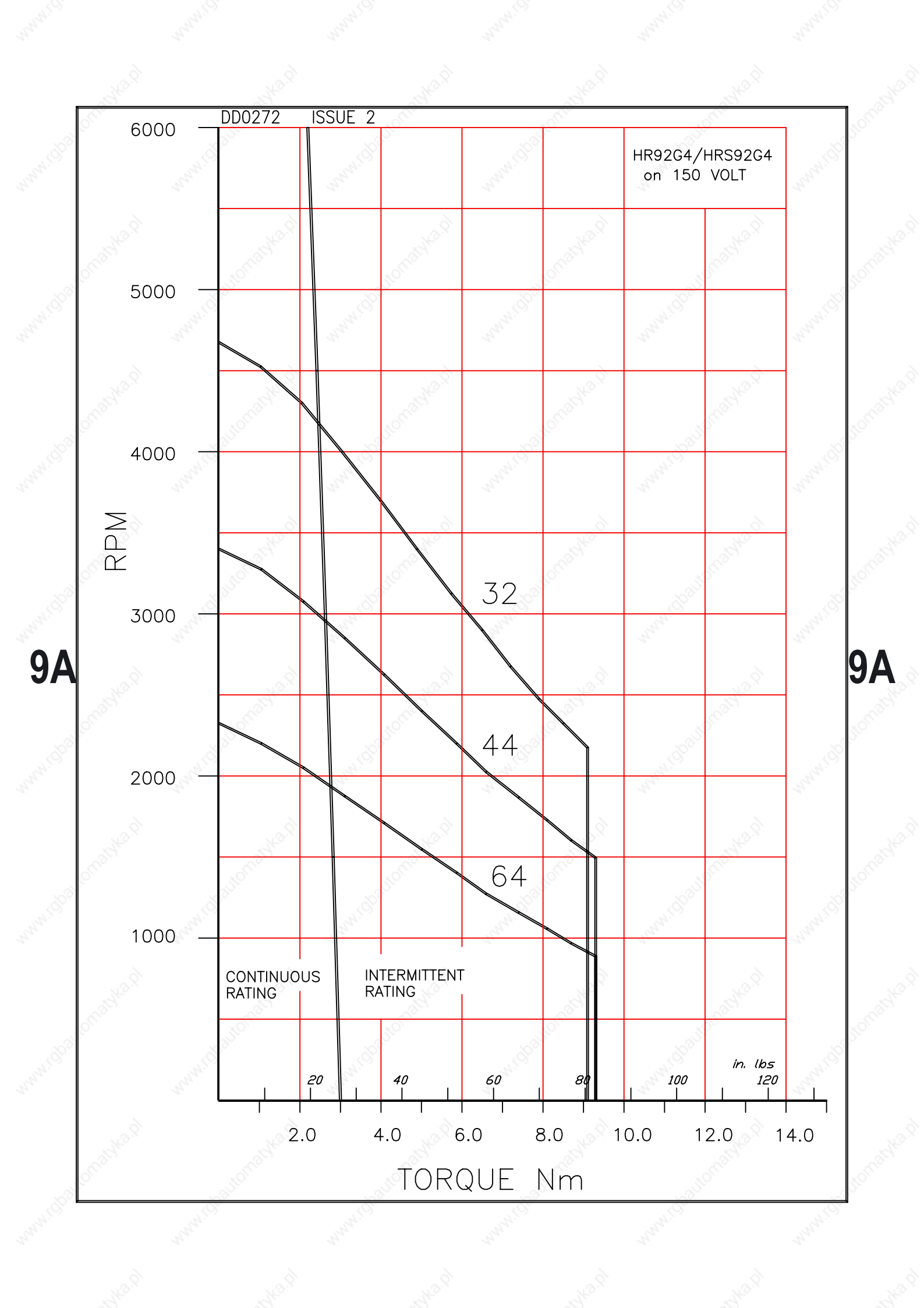

DD0278 ISSUE 2

HR92G4/HRS92G4
on 250 VOLT

RPM

6000
5000
4000
3000
2000
1000

32

44

64

88

130

CONTINUOUS
RATING

INTERMITTENT
RATING

20

40

60

80

100
120

in. lbs

120

TORQUE Nm

2.0

4.0

6.0

8.0

10.0

12.0

14.0

9A

9A

9A

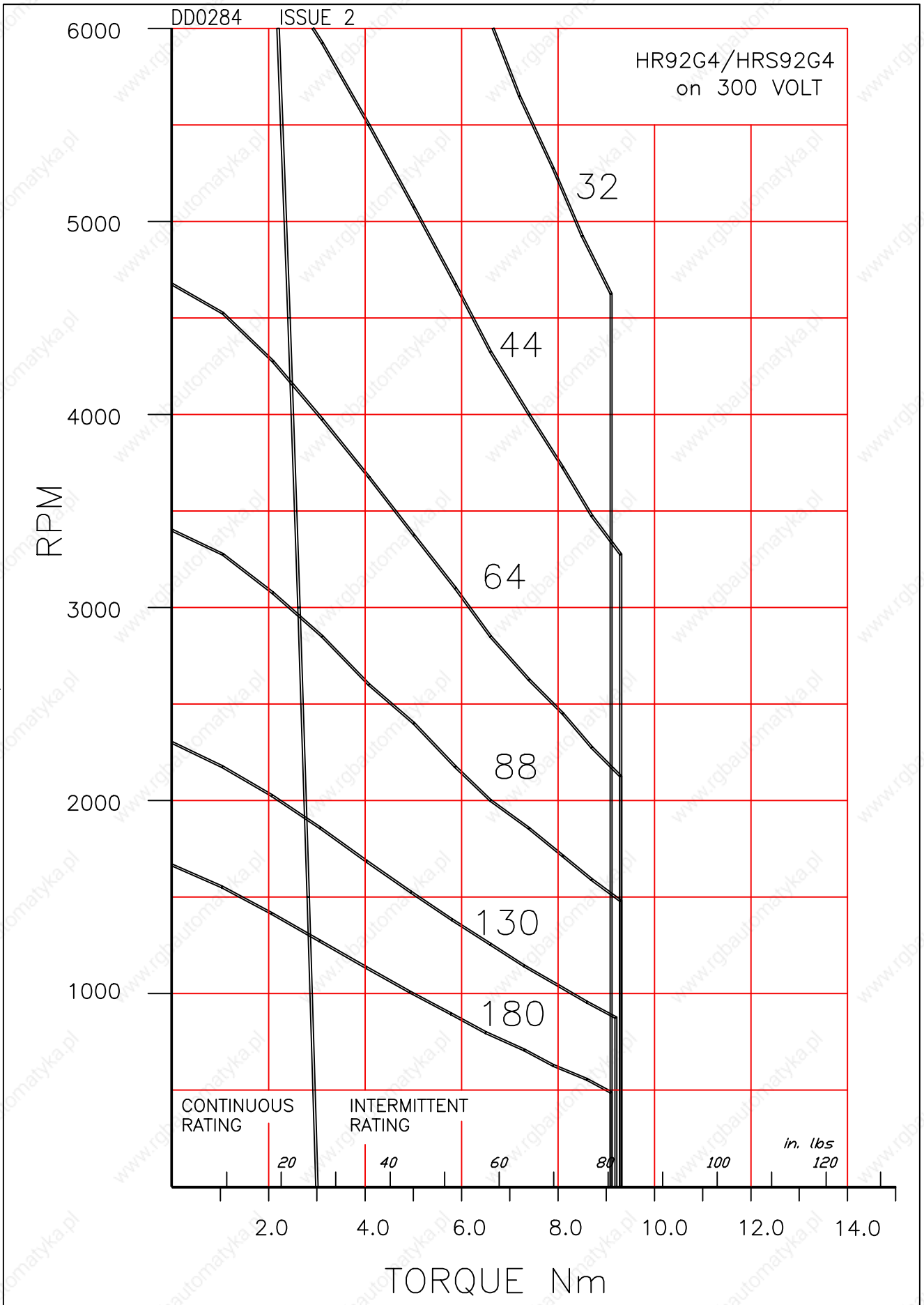

9A

DD0290 ISSUE 2

HR92G4/HRS92G4
on 560 VOLT

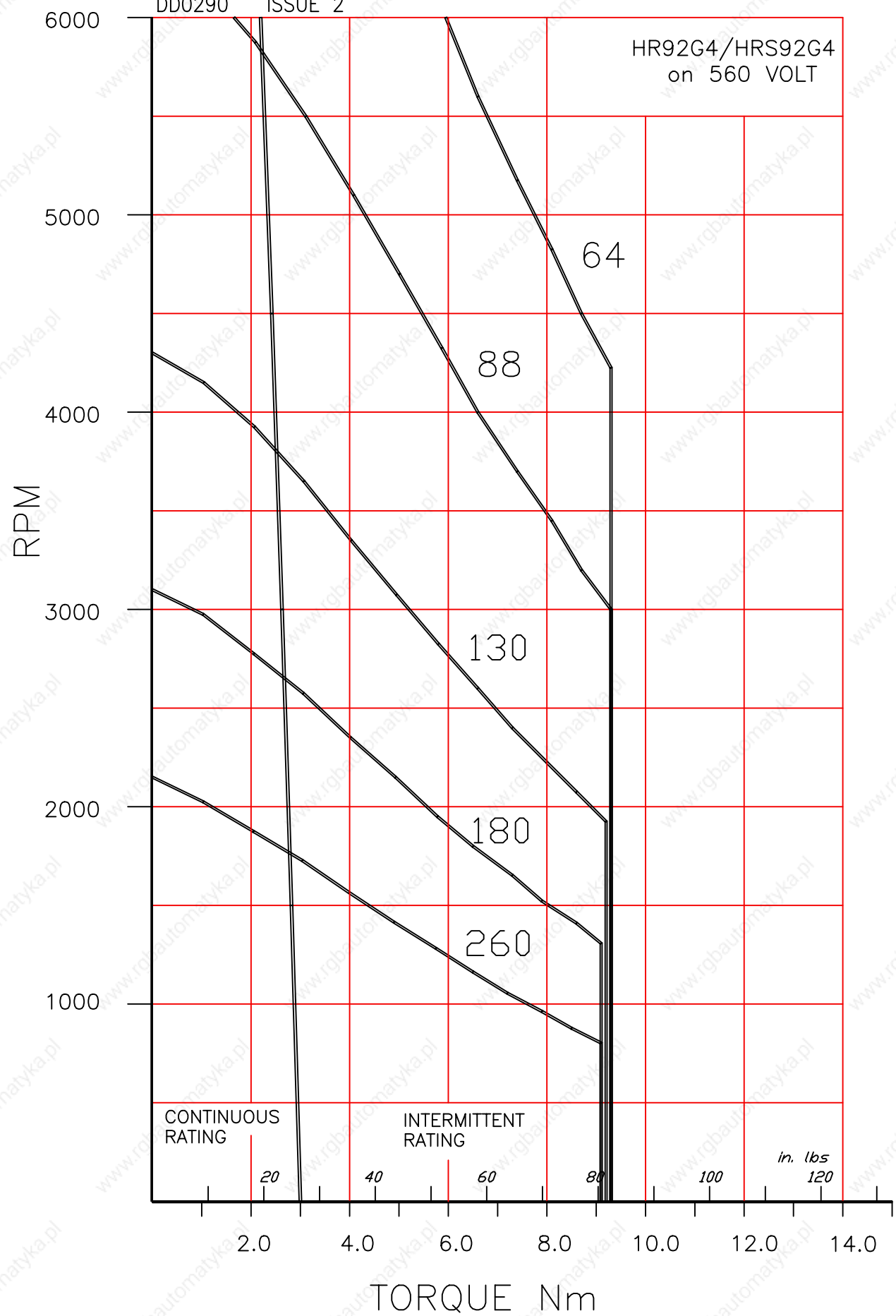

9A

9A

HRS92J4 Brushless AC Servomotors

Technical Data

9A

Parameter	Units	HRS92J4-88S	HRS92J4-64S	HRS92J4-44S
GENERAL				
Voltage Gradient No Load	Line-Line Volts (Peak)/1000rpm	88	64	44
Max. Current (Peak)	A	20	27	39
Max. Motor EMF	Line-Line Volts	530	380	260
Max. Mechanical Speed Limit	rpm	6000	6000	6000
Continuous Stall Torque TENV (110K) ^ψ	Nm	3.8	3.8	3.8
	lb-in	34	34	34
(Size 300 x 300 x 12 mm)	Nm	4.1	4.1	4.1
Cont. Stall Torque when fitted to Heatsink (Size 12 x 12 x 0.5 in)	lb-in	36	36	36
Peak Stall Torque	Nm	11.4	11.4	11.4
	lb-in	101	101	101
Continuous Stall Current rms (110K) ^ψ	A	3.7	5.1	7.4
Rotor Polar Moment of Inertia (Inclusive of Resolver Inertia)	kgcm ² lb-in s ²	2 0.0018	2 0.0018	2 0.0018
Torque Constant 3 x K _{t_rms} * [†]	Nm/A lb-in/A	1.02 9	0.75 6.6	0.51 4.5
STATOR WINDING				
Resistance Line-Line*	Ω	5	2.5	1.24
Inductance Line-Line	mH	29	15	7.2
THERMAL				
Insulation Class		F	F	F
Max. Ambient Temperature	°C	40	40	40
	°F	104	104	104
Thermal Time Constant	minutes	33	33	33
	°C/W	0.79	0.79	0.79
Thermal Resistance	°F/W	1.4	1.4	1.4
MECHANICAL				
Static Friction Torque	Nm	0.04	0.04	0.04
	lb-in	0.35	0.35	0.35
Cogging Torque	Nm	0.09	0.09	0.09
	lb-in	0.8	0.8	0.8
Motor Weight	kg	6.5	6.5	6.5
	lb	14	14	14

Notes

- * - All data is subject to a tolerance of ±10% (except motor 'Voltage Gradient' and K_t which are to +15%/-5%).
- At 25°C.
- † - Note that K_t is shown as a combined value for all **three phases**.
- ψ - The temperature rise ΔT on the windings is 110K and applies to all continuous torque values. The maximum ambient temperature is 40°C and therefore the temperature on the windings should not be more than 150°C. A value higher than 150°C would exceed the class F insulation temperature specification.

DD0273 ISSUE 2

HR92J4/HRS92J4
on 150 VOLT

RPM

6000

5000

4000

3000

2000

1000

32

44

64

CONTINUOUS
RATING

INTERMITTENT
RATING

20

40

60

80

100

120

in. lbs

2.0

4.0

6.0

8.0

10.0

12.0

14.0

TORQUE Nm

DATE:

CHECKED:

9A

9A

DD0279 ISSUE 2

HR92J4/HRS92J4
on 250 VOLT

RPM

6000
5000
4000
3000
2000
1000

32

44

64

88

130

CONTINUOUS
RATING

INTERMITTENT
RATING

20

40

60

80

100

120

in. lbs

2.0

4.0

6.0

8.0

10.0

12.0

14.0

TORQUE Nm

9A

9A

DD0285 ISSUE 2

HR92J4/HRS92J4
on 300 VOLT

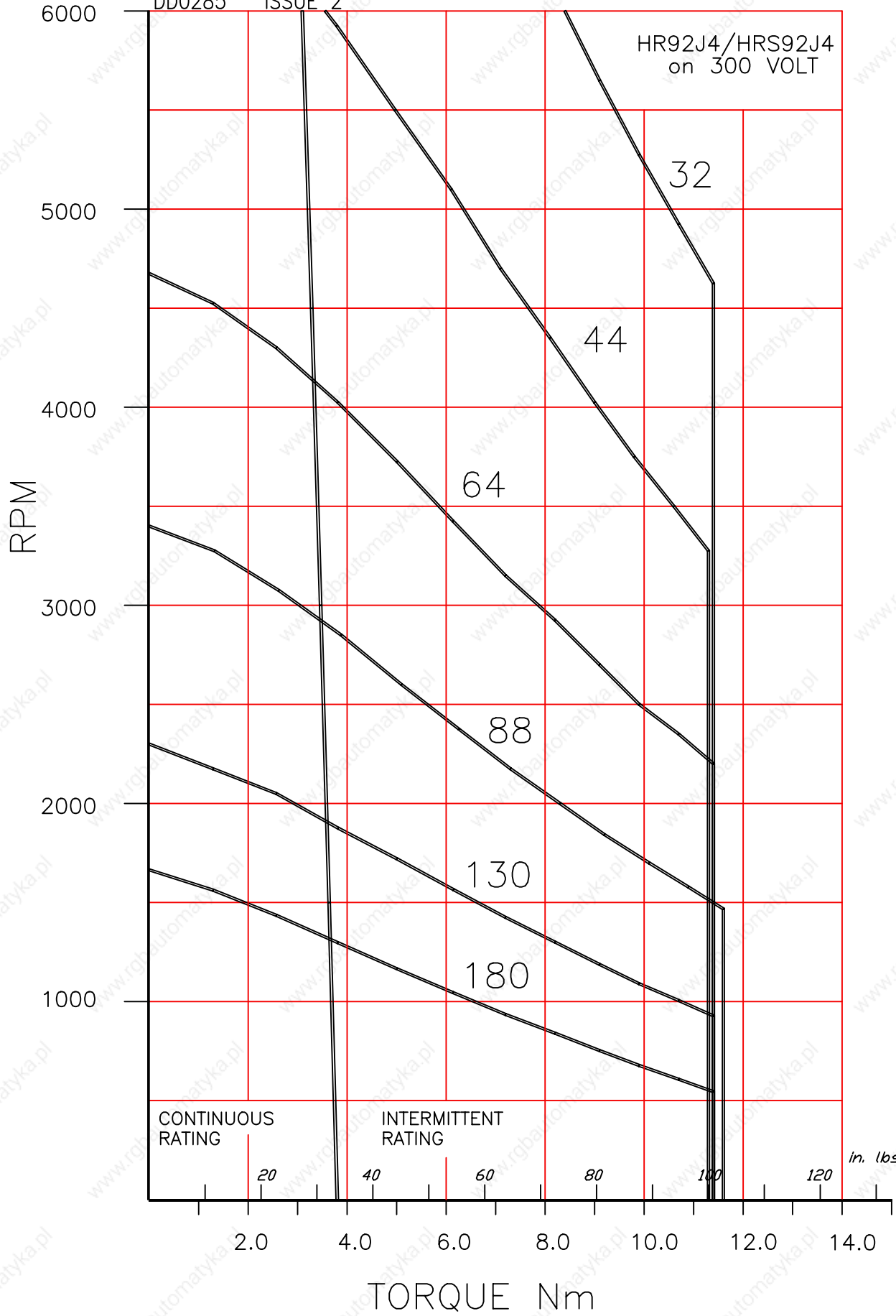

9A

9A

DD0291 ISSUE 2

HR92J4/HRS92J4
on 560 VOLT

RPM

6000
5000
4000
3000
2000
1000

CONTINUOUS
RATING

INTERMITTENT
RATING

20 40 60 80 100 120 *in. lbs*

TORQUE Nm

88
64
130
180
260

9A

9A

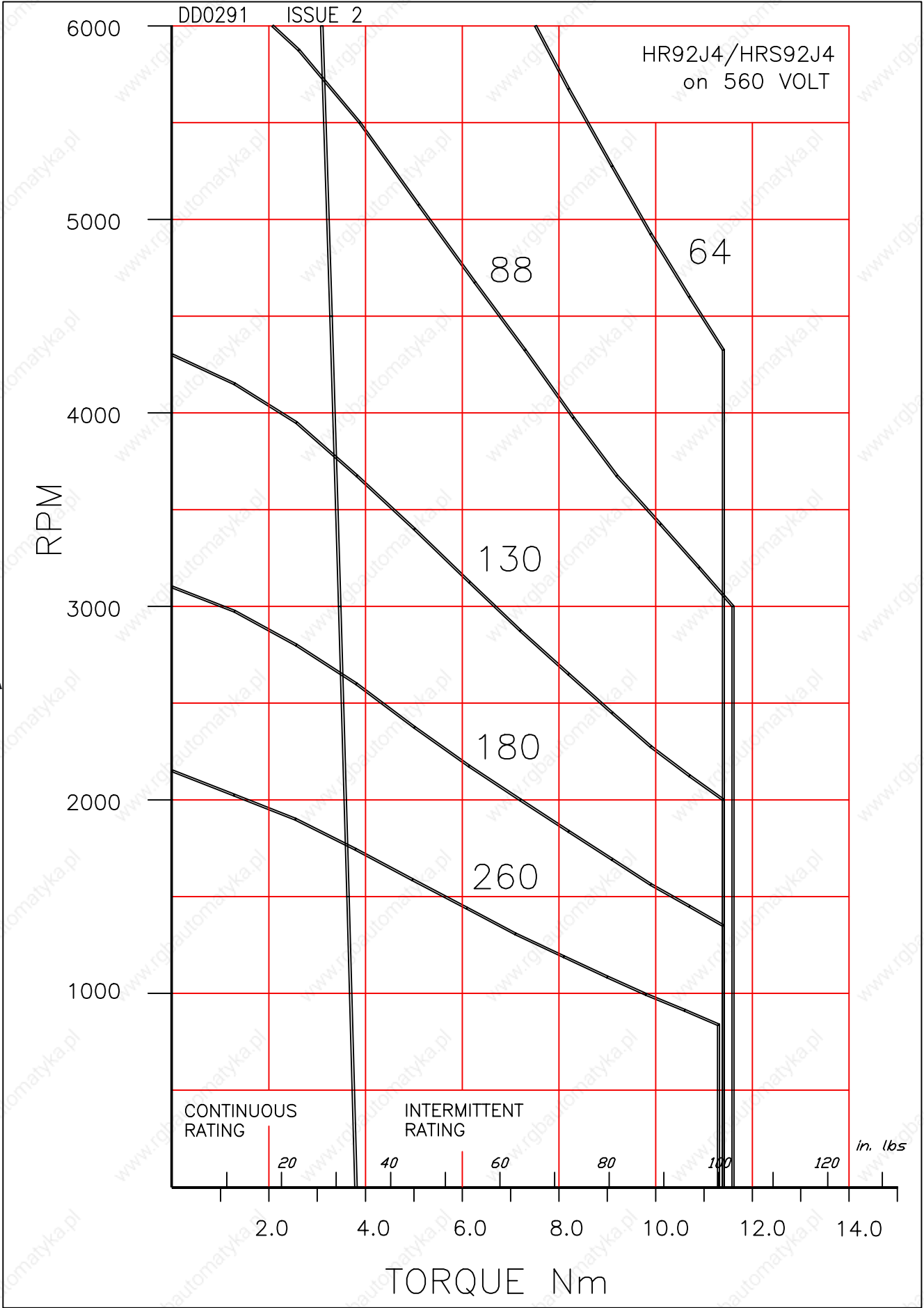

FIRST ANGLE PROJECTION

MOTOR CONNECTOR :- INTERCONNECTOR SIZE 1, 6 PIN
 FEEDBACK CONNECTOR :- INTERCONNECTOR SIZE 1, 12 PIN, 20° OFFSET

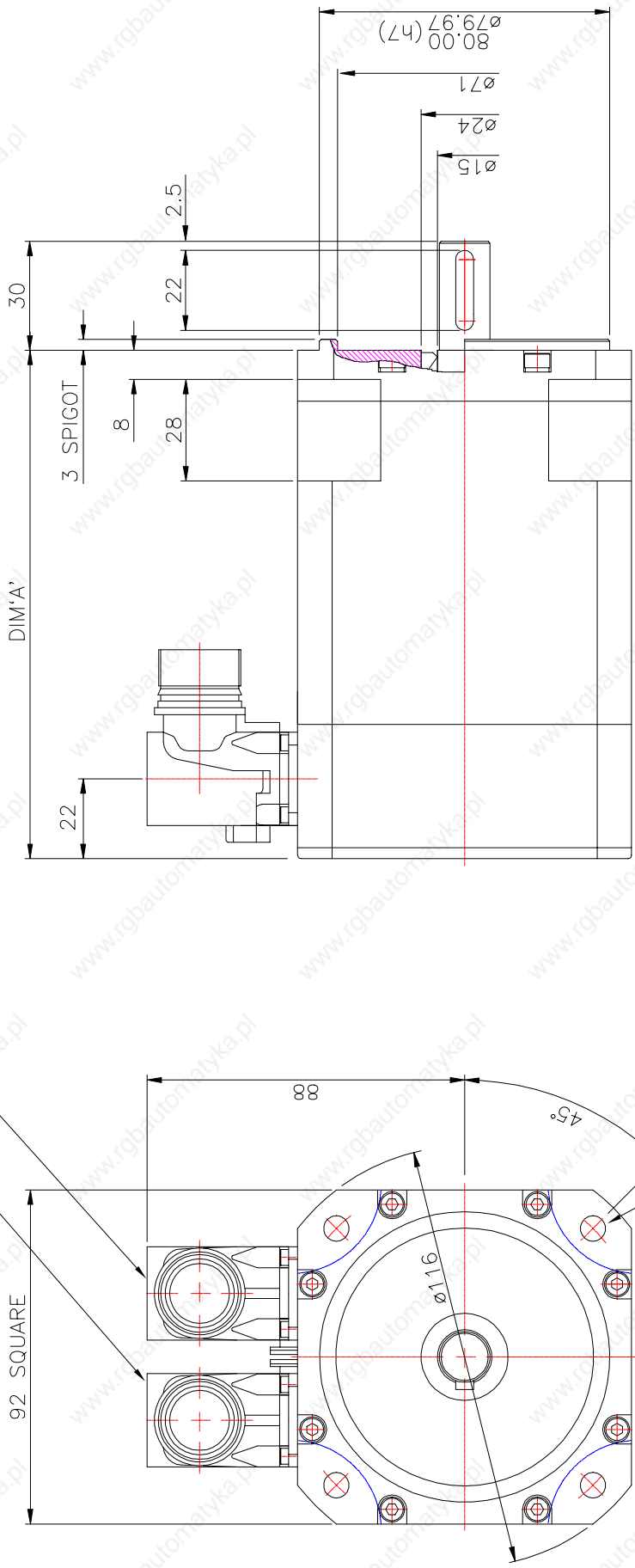

FRAME	NO BRAKE	WITH BRAKE
92A	140	180
92C	160	200
92E	180	220
92G	200	240
92J	220	260
92L	240	280

4-FIXING HOLES ø7 EQUI-SPACED ON 100 PCD

SHAFT DETAIL (x1)

3 03MAR05 MR3355 KEYWAY NOW ENCLOSED	TITLE : OUTLINE HRS92 STD METRIC		DRAWING NO.	SCALE
ALL DIMENSIONS IN MILLIMETRES TOLERANCES UNLESS ANG: ±0.5° OTHERWISE STATED DIM: ±0.25mm	MATERIAL	CODE	664-7-06335	ISSUE No.
	SPEC	FORM	 LONDON ENGLAND	3
	FINISH	PATTERN No.		DR.
			DATE	04MAR03
				A06335C1

HRS92 - OPTIONS (metric series)

9A

Code	Description	Notes
WAVEFORM (WINDING)		
Y00*	Waveform.	Sinusoidal waveform.
FEEDBACK DEVICES		
F00*	Resolver (F00 setting).	2 Pole Resolver type 21-B with F00 setting.
F16	Resolver (F16 setting)	2 Pole Resolver type 21-B with alternative F16 setting.
F66	No Feedback fitted	
FITTED ENCODERS		
E15	Encoder	Heidenhain ERN1387 series, 2048ppr.
E22	Encoder, singleturn, Optical	Heidenhain ECN1313 series, 2048ppr with EnDat Interface.
E16	Encoder, multiturn, Optical	Heidenhain EQN1325 series, 2048ppr with EnDat Interface.
E33	Encoder, singleturn, Inductive	Heidhenhain ECI1319 series, 32ppr with EnDat Interface
E34	Encoder, multiturn, Inductive	Heidhenhain ECI1331 series, 32ppr with EnDat Interface
E20	Encoder, singleturn.	Stegmann SRS50 series with Hiperface Interface.
E21	Encoder, multiturn.	Stegmann SRM50 series with Hiperface Interface.
E26**	Incremental encoder	Renco R35i, 1000ppr
E28**	Incremental encoder	Renco R35i, 2048ppr
E29**	Incremental encoder	Renco R35i, 4000ppr
E31**	Incremental encoder	Renco R35i, 8192ppr
MECHANICAL INTERFACE		
M00*	Flange.	92 x 92 mm square flange. Spigot Ø 80mm. Fixing 4 x Ø 7 mm holes on 100 mm PCD.
R01	Close tolerance interface.	Flange & shaft to IEC72-P (precision).
S00*	Shaft.	Ø 14mm x 30mm long.
K00*	Keyway.	5 x 5 x 20 mm long.
K99	No Keyway.	Plain shaft.
D01*	Shaft end threaded hole.	M5 x 15mm deep.
BRAKES		
B00	24Vdc Brake.	5.0Nm Torque
B01	90Vdc Brake.	5.0Nm Torque
ELECTRICAL TERMINATIONS		
C47*	Motor & feedback connector.	Interconnectron motor receptacle (6 pin) and feedback receptacle (12 pin 20 degree offset) (for motors fitted with resolver)
C48	Motor & feedback connector.	Interconnectron motor receptacle (6 pin) and feedback receptacle (17 pin) (for motors fitted with encoder)
C68	Feedback plug.	Interconnectron straight plug (12 pin) & cable clamp for C47.
C69	Feedback plug.	Interconnectron straight plug (17 pin) & cable clamp for C48.
C67	Motor plug.	Interconnectron straight plug (6 pin) & cable clamp for C47/C48.
THERMAL PROTECTION		
P21*	Thermal overload.	Bi-metal thermal switch.
P17	Thermal overload.	Temperature sensor, Phillips type KTY 84-130.
P18	No thermal overload.	Thermal protection not fitted.
ENCLOSURE PROTECTION		
W00*	IP64/65 enclosure.	Nitrile shaft seal for IP64/65 protection (factory fitted).
W01	IP64/65 enclosure.	Viton shaft seal for IP64/65 protection (factory fitted).
W02	IP64/65 enclosure.	Nitrile shaft seal for IP64/65 protection (supplied loose).
W03	IP64/65 enclosure.	Viton shaft seal for IP64/65 protection (supplied loose).
W99	No Shaft Seal Fitted	
UL APPROVAL		
U00	UL approved motor	

* Standard feature

** Other line counts available on request

HR115A6

HR115B6

HR115C6

HR115E6

HR115

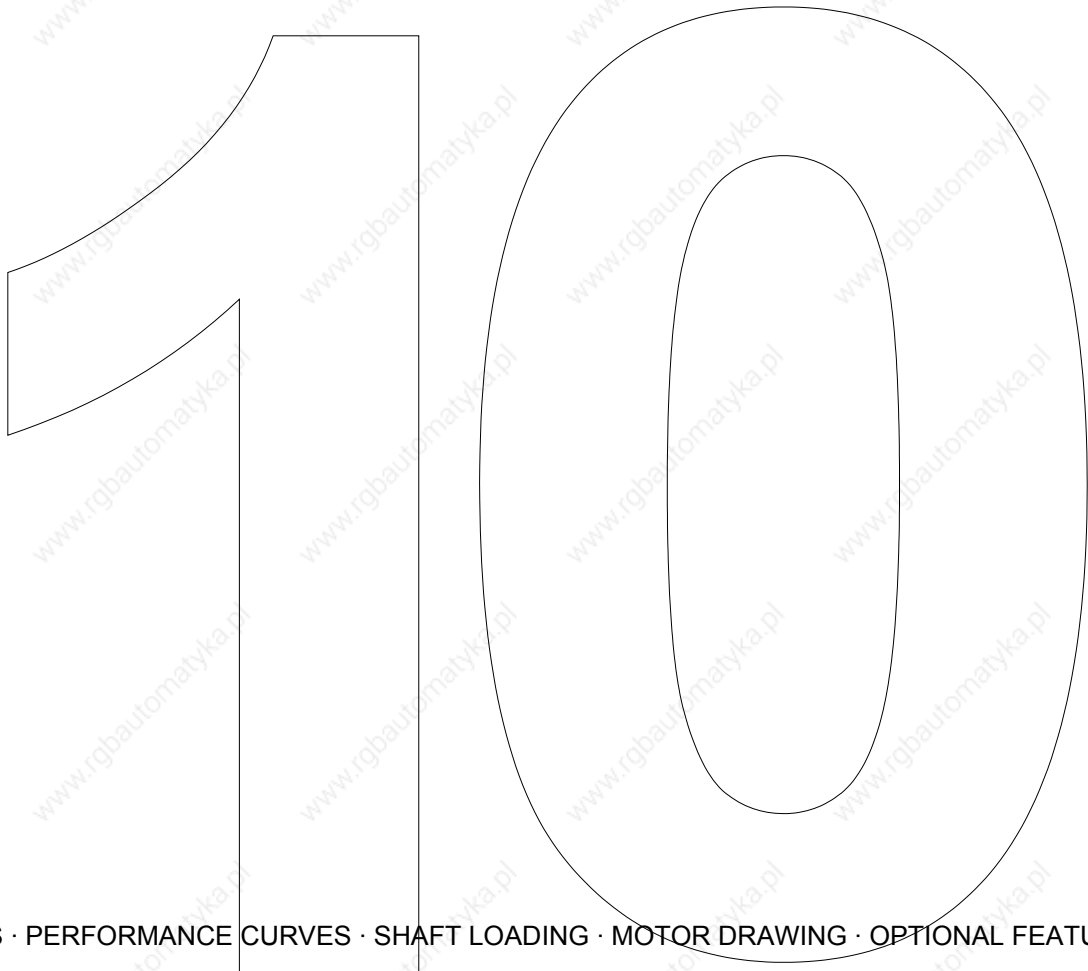

DATA TABLES · PERFORMANCE CURVES · SHAFT LOADING · MOTOR DRAWING · OPTIONAL FEATURES

HR115A6

Brushless AC Servomotors

10

Technical Data

Parameter	Units	HR115A6-130	HR115A6-88	HR115A6-64	HR115A6-44
GENERAL					
Voltage Gradient No Load	Line-Line Volts (Peak)/1000RPM	130	88	64	44
Max. Motor EMF	Line - Line Volts	700	530	380	260
Max. Speed	RPM	5400	6000	6000	6000
Continuous Stall Torque TENV					
	Nm	3.7	3.7	3.7	3.7
	lb-in	33	33	33	33
(Size 300 x 300 x 12 mm) Cont. Stall Torque when fitted to Heatsink	Nm	4.2	4.2	4.2	4.2
(Size 12 x 12 x 0.5 in)	lb-in	37	37	37	37
Peak Stall Torque	Nm	11	11	11	11
	lb - in	97	97	97	97
Continuous Stall Current rms (110K) ^ψ	Amps	2.4	3.6	4.9	7.2
Rotor Polar Moment of Inertia (Inclusive of Resolver Inertia)	kgcm ² lb-in sec ²	2.7 0.0024	2.7 0.0024	2.7 0.0024	2.7 0.0024
Max. Current (Peak)	Amps	12.1	18	24	36
Cogging Torque	Nm	0.101	0.101	0.101	0.101
	lb-in	0.90	0.90	0.90	0.90
Torque Constant Kt_{rms}[†]					
	Nm/Amp	1.53	1.02	0.75	0.51
	lb-in/Amp	13.5	9	6.6	4.5
STATOR WINDING					
Resistance Line-Line*	Ohms	11.4	5.5	2.7	1.29
Inductance Line-Line	MilliHenrys	60	28	15	6.9
THERMAL					
Insulation Class		F	F	F	F
Max. Ambient Temperature	°C	40	40	40	40
	°F	104	104	104	104
Thermal Time Constant	Minutes	35	35	35	35
Thermal Resistance	°C/Watt	0.74	0.74	0.74	0.74
	°F/Watt	1.33	1.33	1.33	1.33
MECHANICAL					
Static Friction Torque	Nm	0.066	0.066	0.066	0.066
	lb	0.58	0.58	0.58	0.58
Motor Weight	kg	6.6	6.6	6.6	6.6
	lb	15	15	15	15

Notes

- Tolerance** - All data is subject to a tolerance of $\pm 10\%$ (except motor 'Voltage Gradient' and Kt which are to $+15\%/-5\%$).
- * - At 25°C.
- † - Note that Kt is shown as a combined value for all **three phases**.
- ψ - The temperature rise ΔT on the windings is 110K and applies to all continuous torque values. The maximum ambient temperature is 40°C and therefore the temperature on the windings should not be more than 150°C. A value higher than 150°C would exceed the class F insulation temperature specification.

HR115B6

Brushless AC Servomotors

10

Technical Data

Parameter	Units	HR115B6-130	HR115B6-88	HR115B6-64	HR115B6-44
GENERAL					
Voltage Gradient No Load	Line-Line Volts (Peak)/1000RPM	130	88	64	44
Max. Motor EMF	Line - Line Volts	700	530	380	260
Max. Speed	RPM	5400	6000	6000	6000
Continuous Stall Torque TENV					
	Nm	5.2	5.2	5.2	5.2
	lb-in	46	46	46	46
(Size 300 x 300 x 12 mm)	Nm	5.8	5.8	5.8	5.8
Cont. Stall Torque when fitted to Heatsink (Size 12 x 12 x 0.5 in)	lb-in	51	51	51	51
Peak Stall Torque	Nm	16	16	16	16
	lb - in	140	140	140	140
Continuous Stall Current rms (110K) ^ψ	Amps	3.4	5.1	6.9	10.1
Rotor Polar Moment of Inertia (Inclusive of Resolver Inertia)	kgcm ²	3.9	3.9	3.9	3.9
	lb-in sec ²	0.0035	0.0035	0.0035	0.0035
Max. Current (Peak)	Amps	18	26	36	53
Cogging Torque	Nm	0.137	0.137	0.137	0.137
	lb-in	1.22	1.22	1.22	1.22
Torque Constant Kt_{rms}[†]	Nm/Amp	1.53	1.02	0.75	0.51
	lb-in/Amp	13.5	9.0	6.6	4.5
STATOR WINDING					
Resistance Line-Line*	Ohms	6.4	2.9	1.5	0.72
Inductance Line-Line	MilliHenrys	39	18	9.4	4.4
THERMAL					
Insulation Class		F	F	F	F
Max. Ambient Temperature	°C	40	40	40	40
	°F	104	104	104	104
Thermal Time Constant	Minutes	40	40	40	40
Thermal Resistance	°C/Watt	0.72	0.72	0.72	0.72
	°F/Watt	1.3	1.3	1.3	1.3
MECHANICAL					
Static Friction Torque	Nm	0.066	0.066	0.066	0.066
	lb	0.58	0.58	0.58	0.58
Motor Weight	kg	7.8	7.8	7.8	7.8
	lb	17	17	17	17

Notes

- Tolerance** - All data is subject to a tolerance of $\pm 10\%$ (except motor 'Voltage Gradient' and Kt which are to $+15\%/-5\%$).
- *** - At 25°C.
- †** - Note that Kt is shown as a combined value for all **three phases**.
- ψ** - The temperature rise ΔT on the windings is 110K and applies to all continuous torque values. The maximum ambient temperature is 40°C and therefore the temperature on the windings should not be more than 150°C. A value higher than 150°C would exceed the class F insulation temperature specification.

HR115C6

Brushless AC Servomotors

10

Technical Data

Parameter	Units	HR115C6-130	HR115C6-88	HR115C6-64	HR115C6-44
GENERAL					
Voltage Gradient No Load	Line-Line Volts (Peak)/1000RPM	130	88	64	44
Max. Motor EMF	Line - Line Volts	700	530	380	260
Max. Speed	RPM	5400	6000	6000	6000
Continuous Stall Torque TENV					
	Nm	6.8	6.8	6.8	6.8
	lb-in	60	60	60	60
(Size 300 x 300 x 12 mm) Cont. Stall Torque when fitted to Heatsink	Nm	7.5	7.5	7.5	7.5
(Size 12 x 12 x 0.5 in)	lb-in	66	66	66	66
Peak Stall Torque	Nm	22	22	22	22
	lb - in	190	190	190	190
Continuous Stall Current rms (110)K ^ψ	Amps	4.5	6.6	9.1	13.2
Rotor Polar Moment of Inertia (Inclusive of Resolver Inertia)	kgcm ² lb-in sec ²	5.1 0.0045	5.1 0.0045	5.1 0.0045	5.1 0.0045
Max. Current (Peak)	Amps	24	35	48	70
Cogging Torque	Nm lb-in	0.17 1.5	0.17 1.5	0.17 1.5	0.17 1.5
Torque Constant Kt_{rms}^{*†}	Nm/Amp lb-in/Amp	1.53 13.5	1.02 9.0	0.75 6.6	0.51 4.5
STATOR WINDING					
Resistance Line-Line*	Ohms	3.7	1.7	0.9	0.46
Inductance Line-Line	MilliHenrys	28	12.6	6.7	3.2
THERMAL					
Insulation Class		F	F	F	F
Max. Ambient Temperature	°C °F	40 104	40 104	40 104	40 104
Thermal Time Constant	Minutes	45	45	45	45
Thermal Resistance	°C/Watt °F/Watt	0.64 1.15	0.64 1.15	0.64 1.15	0.64 1.15
MECHANICAL					
Static Friction Torque	Nm lb	0.066 0.58	0.066 0.58	0.066 0.58	0.066 0.58
Motor Weight	kg lb	9 20	9 20	9 20	9 20

Notes

- Tolerance** - All data is subject to a tolerance of $\pm 10\%$ (except motor 'Voltage Gradient' and Kt which are to $+15\%/-5\%$).
- *** - At 25°C.
- †** - Note that Kt is shown as a combined value for all **three phases**.
- ψ** - The temperature rise ΔT on the windings is 110K and applies to all continuous torque values. The maximum ambient temperature is 40°C and therefore the temperature on the windings should not be more than 150°C. A value higher than 150°C would exceed the class F insulation temperature specification.

HR115E6

Brushless AC Servomotors

10

Technical Data

Parameter	Units	HR115E6-130	HR115E6-88	HR115E6-64	HR115E6-44
GENERAL					
Voltage Gradient No Load	Line-Line Volts (Peak)/1000RPM	130	88	64	44
Max. Motor EMF	Line - Line Volts	700	530	380	260
Max. Speed	RPM	5400	6000	6000	6000
Continuous Stall Torque TENV					
	Nm	9.8	9.8	9.8	9.8
	lb-in	87	87	87	87
(Size 300 x 300 x 12 mm) Cont. Stall Torque when fitted to Heatsink	Nm	10.8	10.8	10.8	10.8
(Size 12 x 12 x 0.5 in)	lb-in	96	96	96	96
Peak Stall Torque	Nm	33	33	33	33
	lb - in	290	290	290	290
Continuous Stall Current rms (110K) ^ψ	Amps	6.4	9.5	13.1	19
Rotor Polar Moment of Inertia (Inclusive of Resolver Inertia)	kgcm ² lb-in sec ²	7.5 0.0066	7.5 0.0066	7.5 0.0066	7.5 0.0066
Max. Current (Peak)	Amps	36	53	73	106
Cogging Torque	Nm	0.24	0.24	0.24	0.24
	lb-in	2.131	2.131	2.131	2.131
Torque Constant Kt_{rms}[†]					
	Nm/Amp	1.53	1.02	0.75	0.51
	lb-in/Amp	13.5	9.0	6.6	4.5
STATOR WINDING					
Resistance Line-Line*	Ohms	2.1	1.01	0.49	0.23
Inductance Line-Line	MilliHenrys	18	8.1	4.3	2
THERMAL					
Insulation Class		F	F	F	F
Max. Ambient Temperature	°C	40	40	40	40
	°F	104	104	104	104
Thermal Time Constant	Minutes	55	55	55	55
Thermal Resistance	°C/Watt	0.58	0.58	0.58	0.58
	°F/Watt	1.04	1.04	1.04	1.04
MECHANICAL					
Static Friction Torque	Nm	0.066	0.066	0.066	0.066
	lb	0.58	0.58	0.58	0.58
Motor Weight	kg	11.4	11.4	11.4	11.4
	lb	25	25	25	25

Notes

- Tolerance** - All data is subject to a tolerance of $\pm 10\%$ (except motor 'Voltage Gradient' and Kt which are to $+15\%/-5\%$).
- * - At 25°C.
- † - Note that Kt is shown as a combined value for all **three phases**.
- ψ - The temperature rise ΔT on the windings is 110K and applies to all continuous torque values. The maximum ambient temperature is 40°C and therefore the temperature on the windings should not be more than 150°C. A value higher than 150°C would exceed the class F insulation temperature specification.

HR115 PERMITTED RADIAL SHAFT LOADING

(Axial loadings may be considered separately – refer to next page)

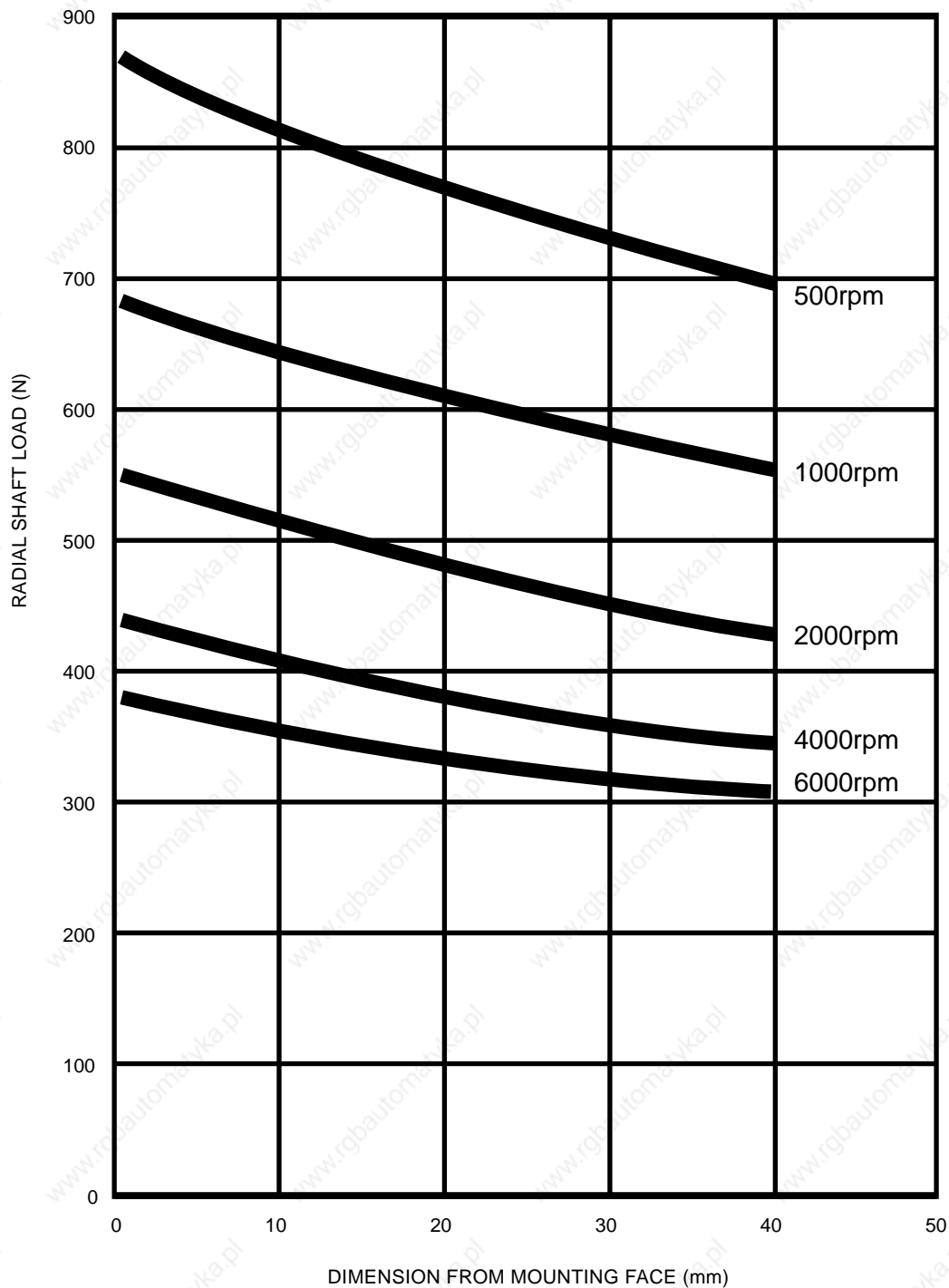

Shaft Loading Information for SEM Standard Servomotors

General notes:-

- 1 All loadings are based upon An L10 bearing life expectancy of 30,000 hours.
- 2 Separate graphs are usually supplied to indicate maximum axial loads which are applicable. However, for motors with locked drive end bearings, a graph is used to illustrate the maximum allowed radial shaft loadings together with a simplified calculation to provide a compensated figure for when radial and axial loadings are to be applied in combination.
- 3 It may occur, in certain circumstances, that loading outside the scope of the published information is deemed necessary. In these cases it is desirable that SEM Ltd should be consulted and all relevant information made available, in order that due consideration can be given to finding a satisfactory solution.
- 4 Should motors be required to operate under abnormal conditions, such as excessive vibration or shock, this should also be referred to SEM Ltd as noted above.

HR115 PERMITTED AXIAL LOAD

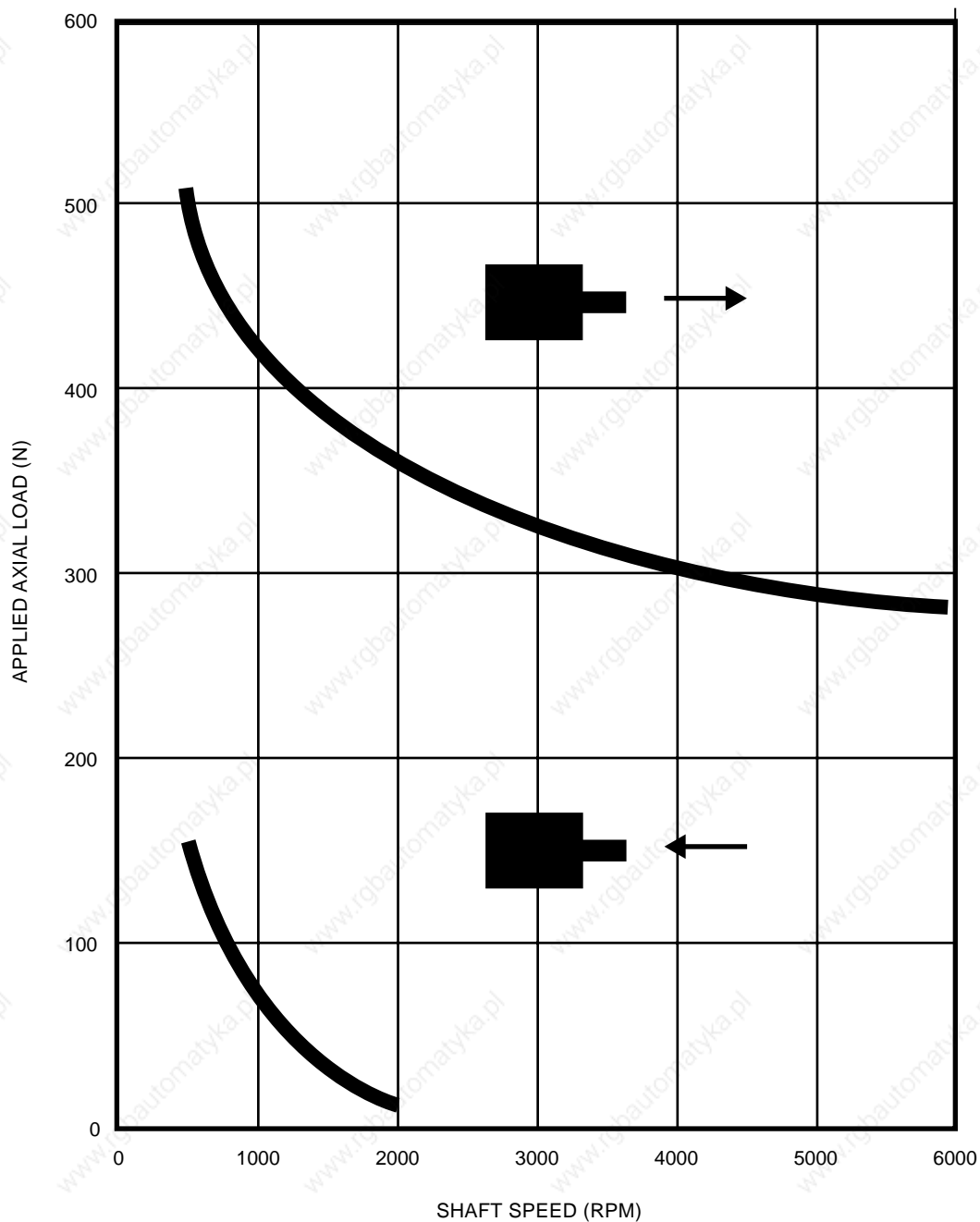

Shaft Loading Information for SEM Standard Servomotors

General notes:-

- 1 All loadings are based upon An L10 bearing life expectancy of 30,000 hours.
- 2 Separate graphs are usually supplied to indicate maximum axial loads which are applicable. However, for motors with locked drive end bearings, a graph is used to illustrate the maximum allowed radial shaft loadings together with a simplified calculation to provide a compensated figure for when radial and axial loadings are to be applied in combination.
- 3 It may occur, in certain circumstances, that loading outside the scope of the published information is deemed necessary. In these cases it is desirable that SEM Ltd should be consulted and all relevant information made available, in order that due consideration can be given to finding a satisfactory solution.
- 4 Should motors be required to operate under abnormal conditions, such as excessive vibration or shock, this should also be referred to SEM Ltd as noted above.

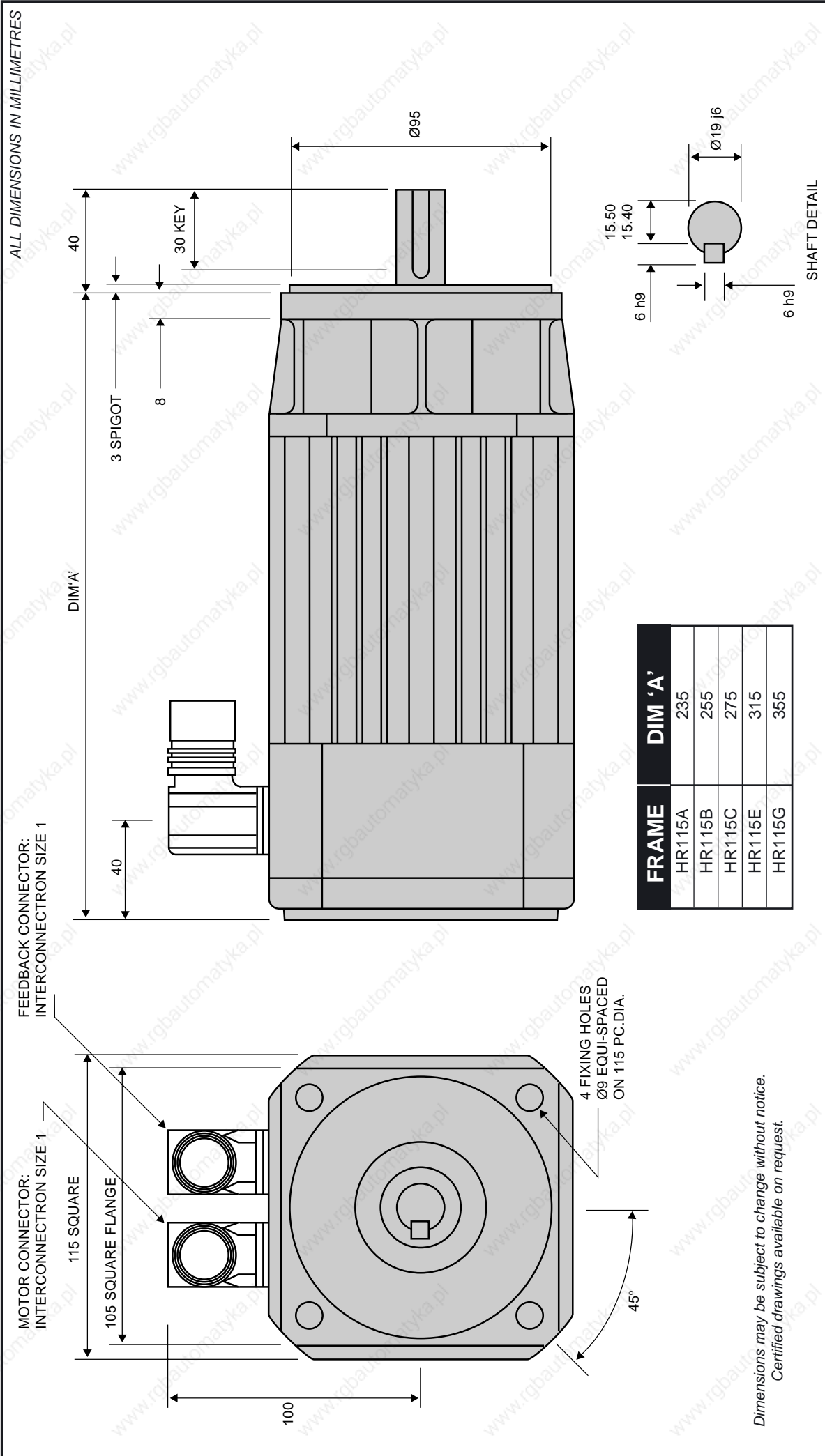

HR SERIES

HR115 + INTERCONNECTRON

Dimensions may be subject to change without notice.
 Certified drawings available on request.

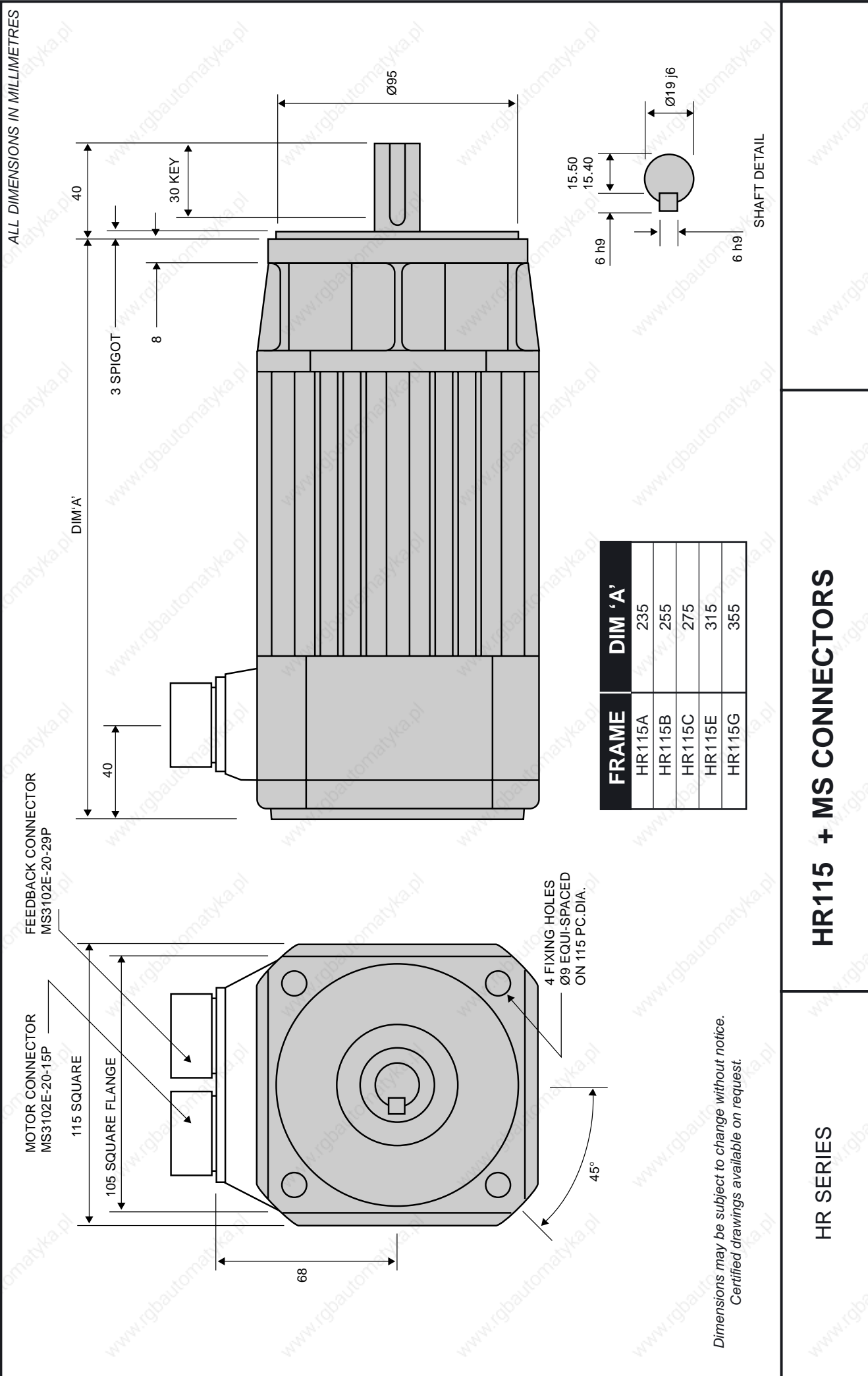

Dimensions may be subject to change without notice.
 Certified drawings available on request.

HR SERIES

HR115 + MS CONNECTORS

ALL DIMENSIONS IN MILLIMETRES

NOTE: Terminal box may be rotated into any one of four positions

MOTOR CONNECTIONS VIA M20 ACCESS TO TERMINALS — FEEDBACK CONNECTOR MS3102E-20-29P

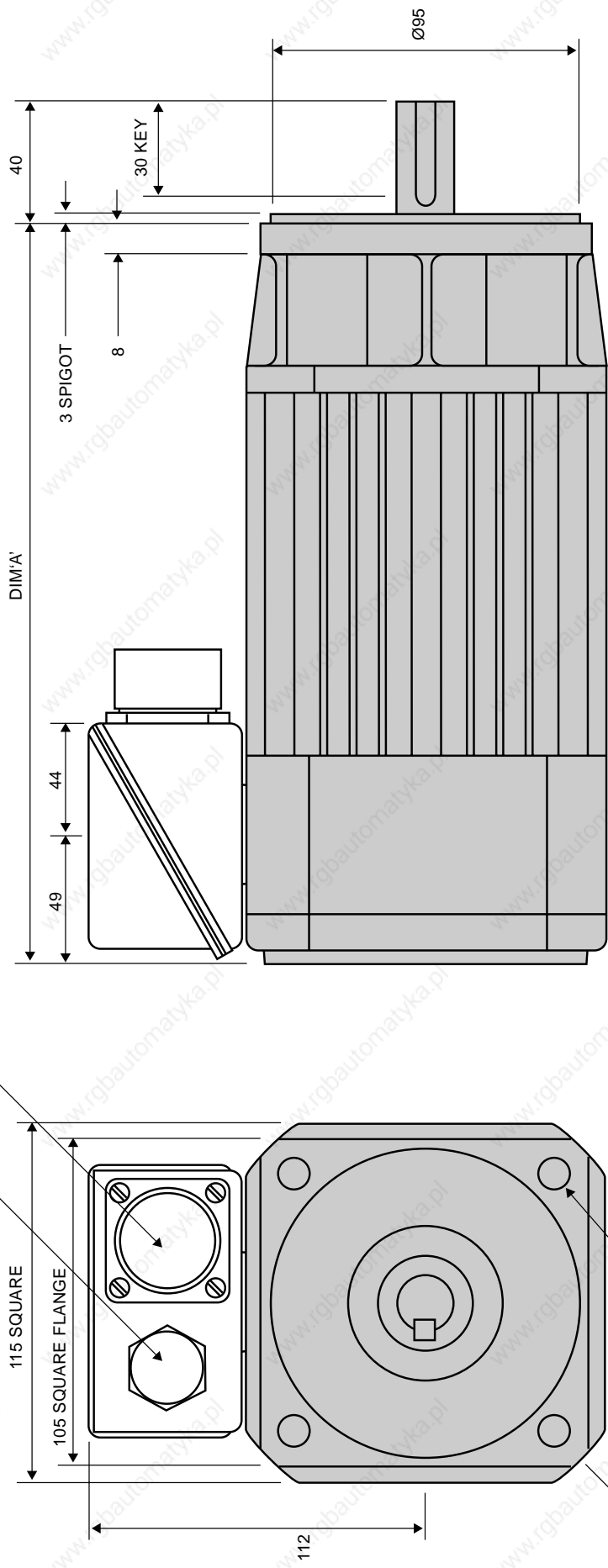

FRAME	DIM 'A'
HR115A	235
HR115B	255
HR115C	275
HR115E	315
HR115G	355

Dimensions may be subject to change without notice.
Certified drawings available on request.

HR SERIES

HR115 + TERMINAL BOX

HR115 - OPTIONS (metric series)

10

Code	Description	Notes
WAVEFORM (WINDING)		
Y00*	Waveform.	Sinusoidal waveform.
FEEDBACK DEVICES		
F00*	Resolver (F00 setting).	2 Pole Resolver type 21-B with F00 setting.
F16	Resolver (F16 setting)	2 Pole Resolver type 21-B with alternative F16 setting.
F66	No Feedback fitted	
FITTED ENCODERS		
E15	Encoder	Heidenhain ERN1387 series, 2048ppr.
E22	Encoder, singleturn, Optical	Heidenhain ECN1313 series, 2048ppr with EnDat Interface.
E16	Encoder, multiturn, Optical	Heidenhain EQN1325 series, 2048ppr with EnDat Interface.
E33	Encoder, singleturn, Inductive	Heidhenhain ECI1319 series, 32ppr with EnDat Interface
E34	Encoder, multiturn, Inductive	Heidhenhain ECI1331 series, 32ppr with EnDat Interface
E20	Encoder, singleturn.	Stegmann SRS50 series with Hiperface Interface.
E21	Encoder, multiturn.	Stegmann SRM50 series with Hiperface Interface.
E26**	Incremental encoder	Renco R35i, 1000ppr
E28**	Incremental encoder	Renco R35i, 2048ppr
E29**	Incremental encoder	Renco R35i, 4000ppr
E31**	Incremental encoder	Renco R35i, 8192ppr
MECHANICAL INTERFACE		
M00*	Flange.	105 x 105 mm square flange. Spigot Ø 95mm. Fixing 4 x Ø 9 mm holes on 115 mm PCD.
R01	Close tolerance interface.	Flange & shaft to IEC72-P (precision).
S00*	Shaft.	Ø 19mm x 40mm long.
K00*	Keyway.	6 x 6 x 30 mm long.
K99	No Keyway.	Plain shaft.
D01*	Shaft end threaded hole.	M6 x 15mm deep.
BRAKES		
B00	24Vdc Brake.	13.5Nm Torque
B01	90Vdc Brake.	13.5Nm Torque
B04	24Vdc Low Torque Brake.	5.0Nm Torque
B05	90Vdc Low Torque Brake.	5.0Nm Torque
ELECTRICAL TERMINATIONS		
C47*	Motor & feedback connector.	Interconnectron motor receptacle (6 pin) and feedback receptacle (12 pin 20 degree offset) (for motors fitted with resolver)
C48	Motor & feedback connector.	Interconnectron motor receptacle (6 pin) and feedback receptacle (17 pin) (for motors fitted with encoder)
C68	Feedback plug.	Interconnectron straight plug (12 pin) & cable clamp for C47.
C69	Feedback plug.	Interconnectron straight plug (17 pin) & cable clamp for C48.
C67	Motor plug.	Interconnectron straight plug (6 pin) & cable clamp for C47/C48.
C00	Terminal Box	Terminal Box with 1 x M20 hole. Feedback MS receptacle (17 pin)
C01	Motor & feedback connector	Motor receptacle (7 pin) feedback receptacle (17 pin)
C04	Feedback plug & cable	Straight plug and cable clamp for C00, C01
C08	Motor Plug & cable	Straight plug and cable clamp for C01
THERMAL PROTECTION		
P21*	Thermal overload.	Bi-metal thermal switch.
P17	Thermal overload.	Temperature sensor, Phillips type KTY 84-130.
P18	No thermal overload.	Thermal protection not fitted.
ENCLOSURE PROTECTION		
W00*	IP64/65 enclosure.	Nitrile shaft seal for IP64/65 protection (factory fitted).
W01	IP64/65 enclosure.	Viton shaft seal for IP64/65 protection (factory fitted).
W02	IP64/65 enclosure.	Nitrile shaft seal for IP64/65 protection (supplied loose).
W03	IP64/65 enclosure.	Viton shaft seal for IP64/65 protection (supplied loose).
W99	No Shaft Seal Fitted	
UL APPROVAL		
U00	UL approved motor	

* Standard feature

** Other line counts available on request

HRS115A6

HRS115B6

HRS115C6

HRS115E6

HRS115

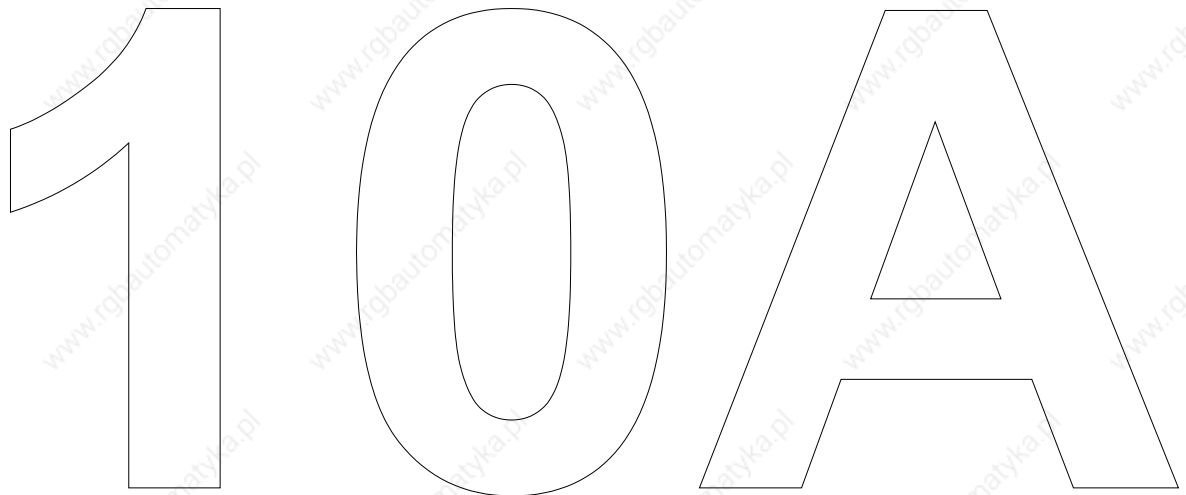

DATA TABLES · PERFORMANCE CURVES · SHAFT LOADING · MOTOR DRAWING · OPTIONAL FEATURES

HRS115A6 Brushless AC Servomotors

Technical Data

10A

Parameter	Units	HRS115A6-130S	HRS115A6-88S	HRS115A6-64S
GENERAL				
Voltage Gradient No Load	Line-Line Volts (Peak)/1000rpm	130	88	64
Max. Current (Peak)	A	12.1	18	24
Max. Motor EMF	Line-Line Volts	700	530	380
Max. Mechanical Speed Limit	rpm	5400	6000	6000
Continuous Stall Torque TENV (110K) ^ψ	Nm	3.7	3.7	3.7
	lb-in	33	33	33
(Size 300 x 300 x 12 mm)	Nm	4.2	4.2	4.2
Cont. Stall Torque when fitted to Heatsink (Size 12 x 12 x 0.5 in)	lb-in	37	37	37
Peak Stall Torque	Nm	11	11	11
	lb-in	97	97	97
Continuous Stall Current rms (110K) ^ψ	A	2.4	3.6	4.9
Rotor Polar Moment of Inertia (Inclusive of Resolver Inertia)	kgcm ² lb-in s ²	2.7 0.0024	2.7 0.0024	2.7 0.0024
Torque Constant 3 x K _{t_rms} * [†]	Nm/A lb-in/A	1.53 13.5	1.02 9	0.75 6.6
STATOR WINDING				
Resistance Line-Line*	Ω	11.4	5.5	2.7
Inductance Line-Line	mH	60	28	15
THERMAL				
Insulation Class		F	F	F
Max. Ambient Temperature	°C	40	40	40
	°F	104	104	104
Thermal Time Constant	minutes	35	35	35
Thermal Resistance	°C/W	0.74	0.74	0.74
	°F/W	1.33	1.33	1.33
MECHANICAL				
Static Friction Torque	Nm	0.066	0.066	0.066
	lb-in	0.58	0.58	0.58
Cogging Torque	Nm	0.101	0.101	0.101
	lb-in	0.89	0.89	0.89
Motor Weight	kg	5.6	5.6	5.6
	lb	12.3	12.3	12.3

Notes

- * - All data is subject to a tolerance of ±10% (except motor 'Voltage Gradient' and K_t which are to +15%/-5%).
- At 25°C.
- † - Note that K_t is shown as a combined value for all **three phases**.
- ψ - The temperature rise ΔT on the windings is 110K and applies to all continuous torque values. The maximum ambient temperature is 40°C and therefore the temperature on the windings should not be more than 150°C. A value higher than 150°C would exceed the class F insulation temperature specification.

DD0576 ISSUE 1

HRS115A6
on 150 VOLT

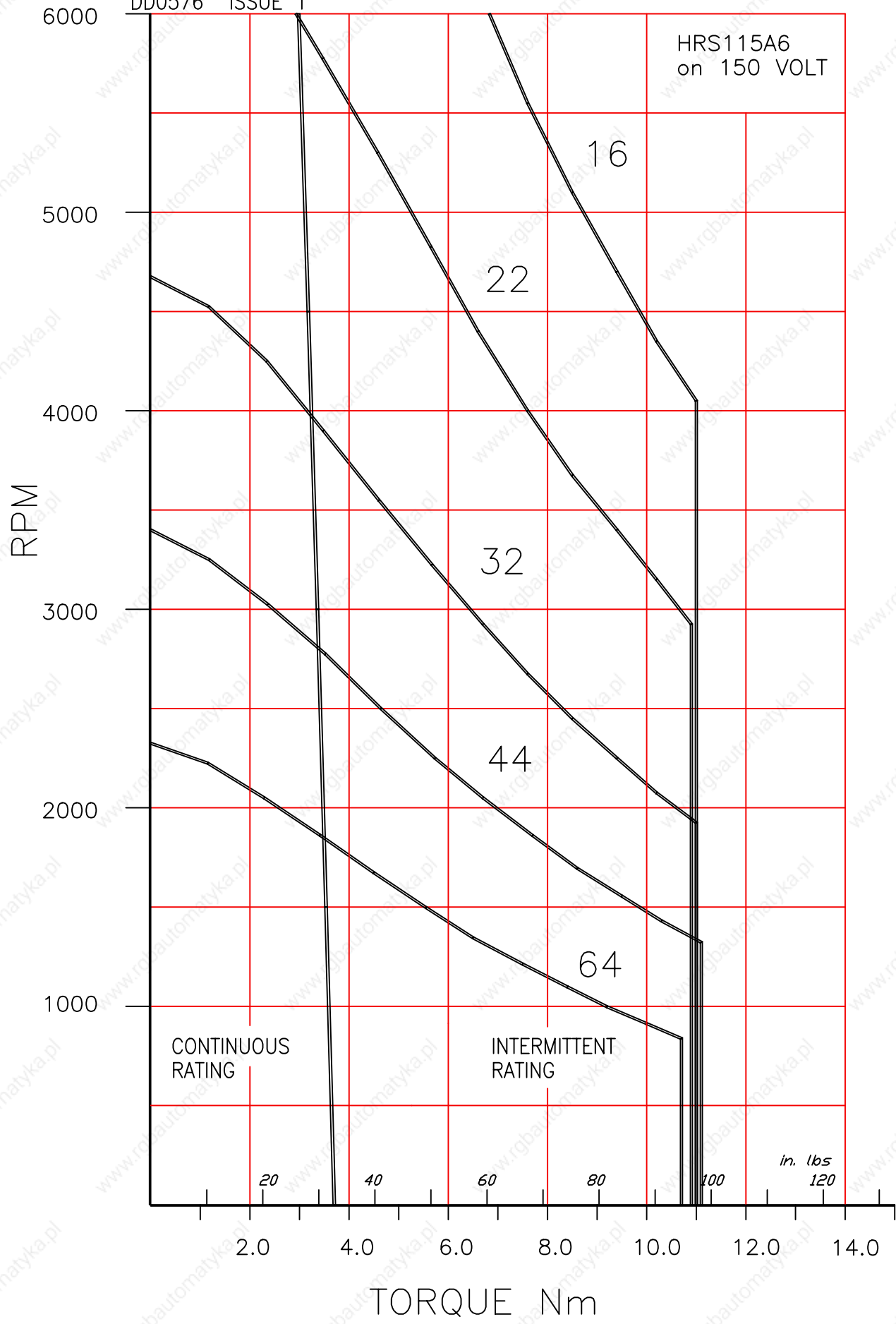

10A

10A

TORQUE Nm

in. lbs
120

DD0581 ISSUE 1

HRS115A6
on 250 VOLT

RPM

10A

10A

6000
5000
4000
3000
2000
1000

CONTINUOUS
RATING

INTERMITTENT
RATING

20

40

60

80

100

in. lbs
120

TORQUE Nm

32

44

64

88

130

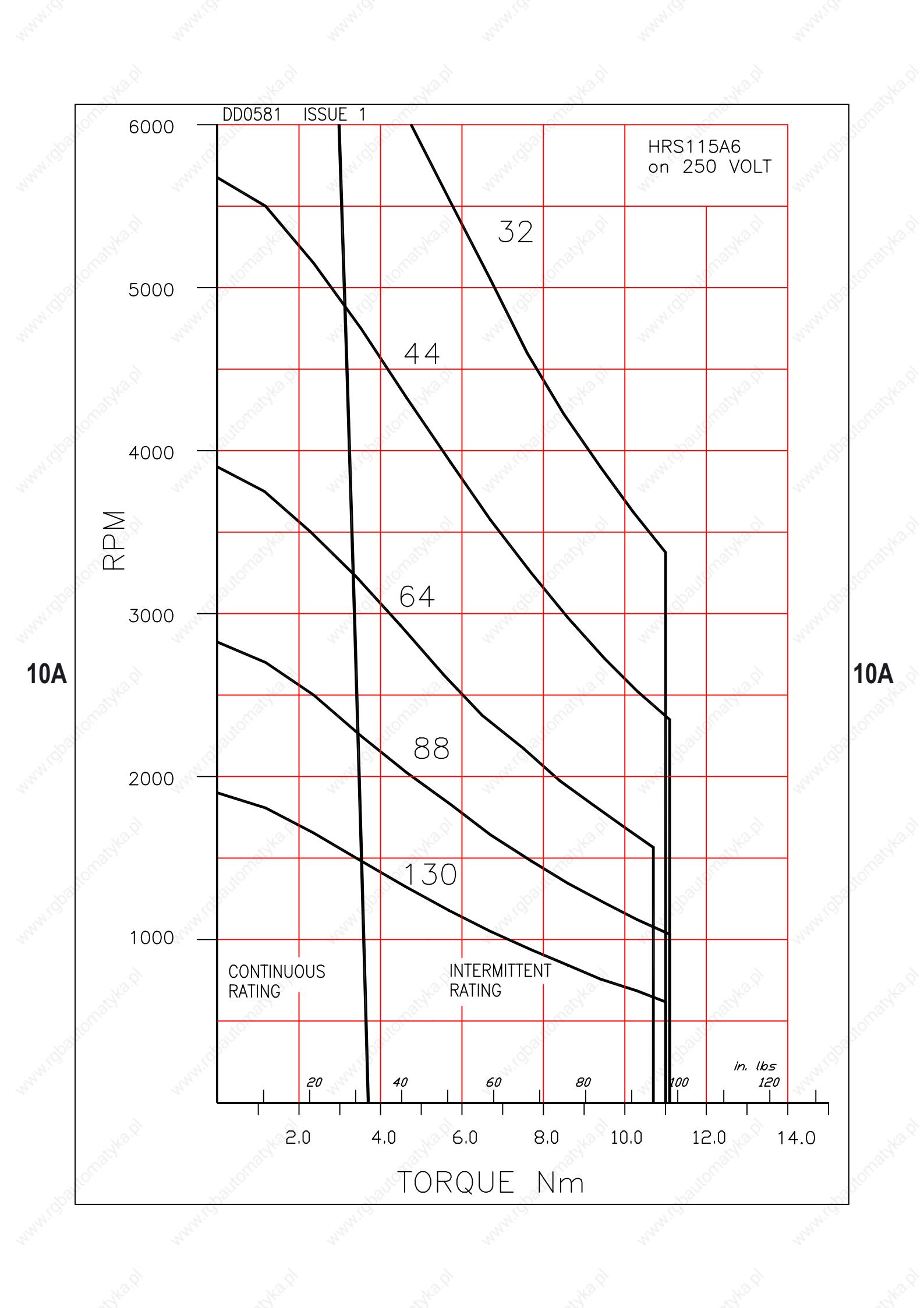

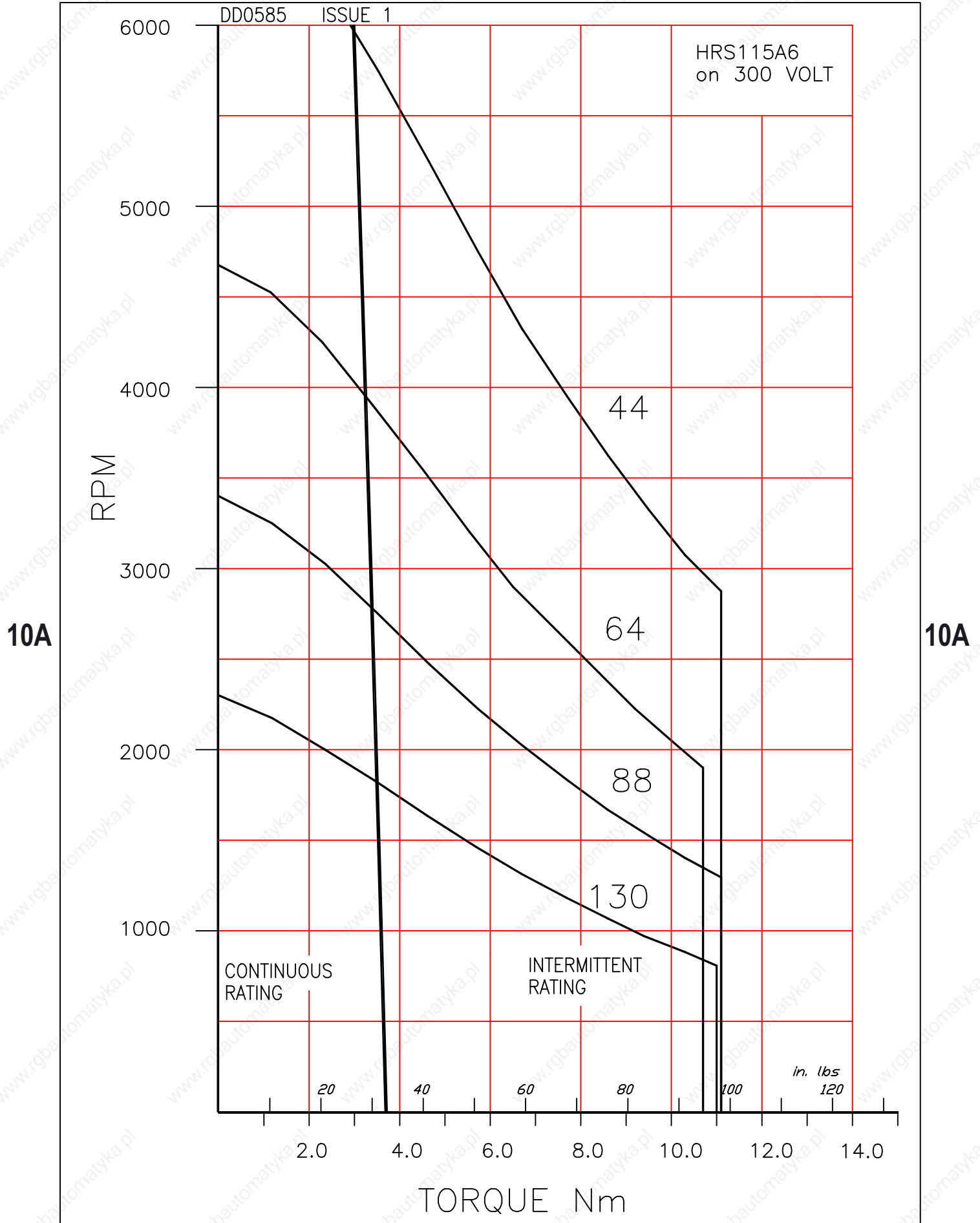

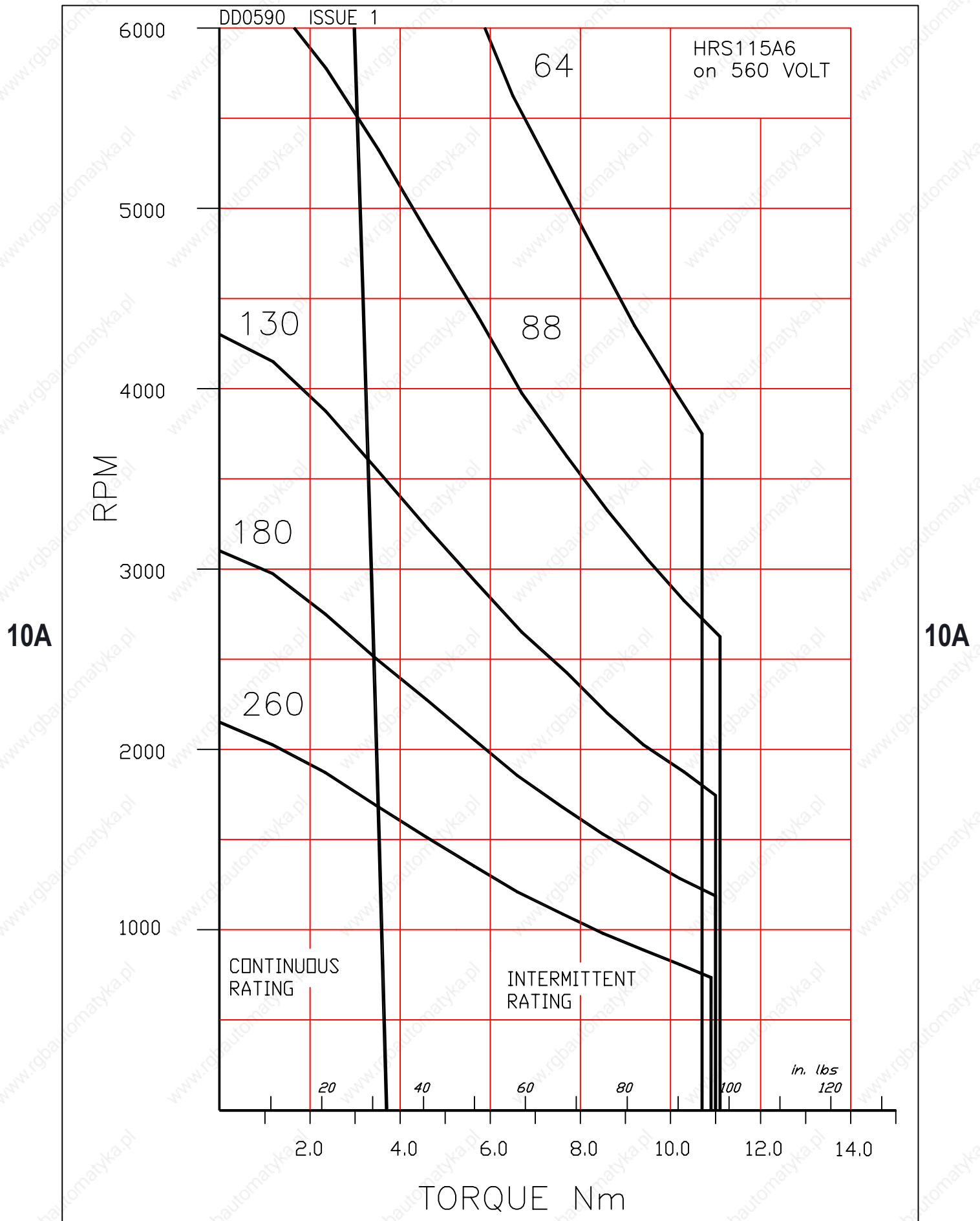

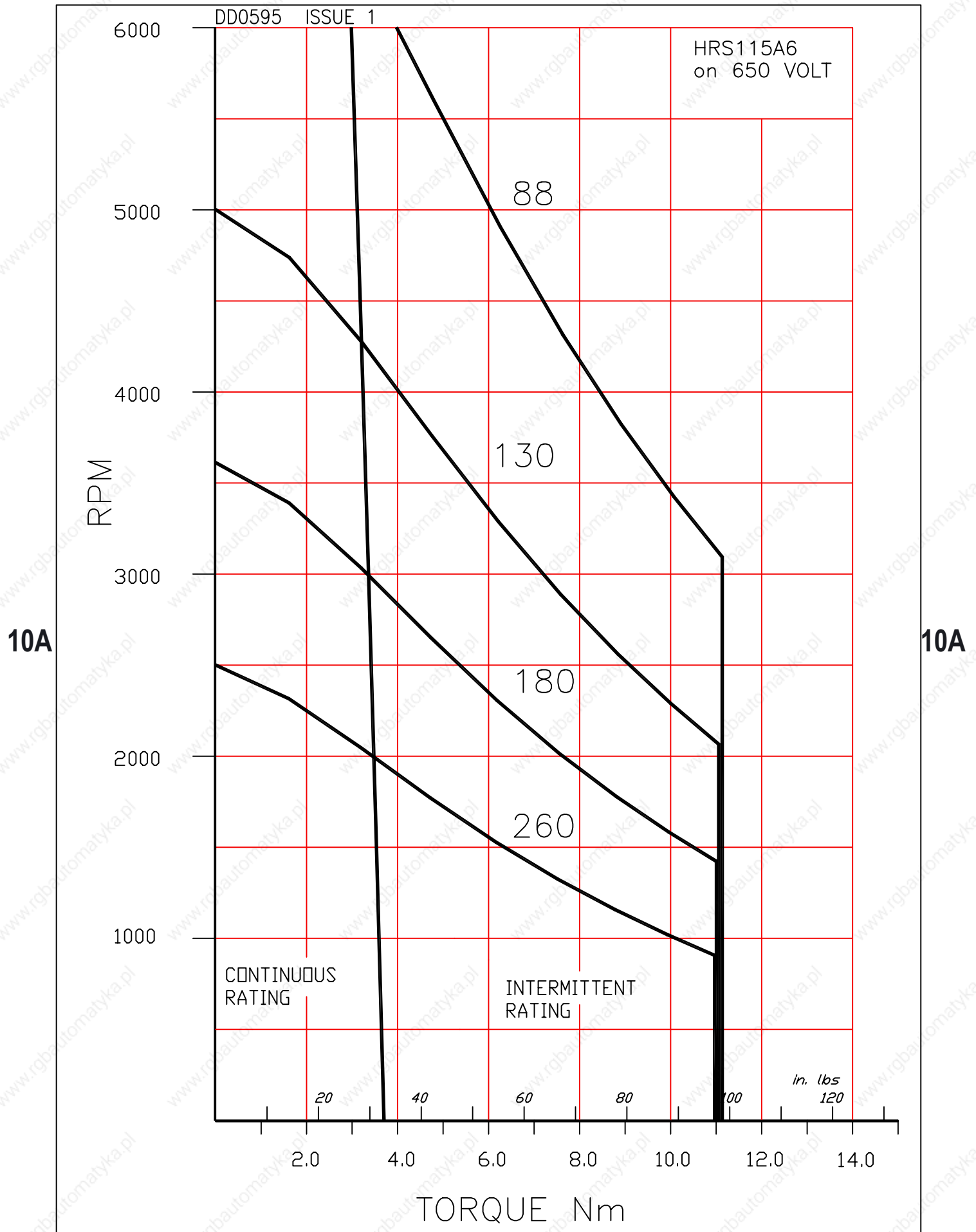

HRS115B6 Brushless AC Servomotors

Technical Data

10A

Parameter	Units	HRS115B6-130S	HRS115B6-88S	HRS115B6-64S
GENERAL				
Voltage Gradient No Load	Line-Line Volts (Peak)/1000rpm	130	88	64
Max. Current (Peak)	A	18	26	36
Max. Motor EMF	Line-Line Volts	700	530	380
Max. Mechanical Speed Limit	rpm	5400	6000	6000
Continuous Stall Torque TENV (110K) ^ψ	Nm	5.2	5.2	5.2
	lb-in	46	46	46
(Size 300 x 300 x 12 mm)	Nm	5.8	5.8	5.8
Cont. Stall Torque when fitted to Heatsink (Size 12 x 12 x 0.5 in)	lb-in	51	51	51
Peak Stall Torque	Nm	16	16	16
	lb-in	140	140	140
Continuous Stall Current rms (110K) ^ψ	A	3.4	5.1	6.9
Rotor Polar Moment of Inertia (Inclusive of Resolver Inertia)	kgcm ² lb-in s ²	3.9 0.0035	3.9 0.0035	3.9 0.0035
Torque Constant 3 x K _{t_rms} * [†]	Nm/A lb-in/A	1.53 13.5	1.02 9	0.75 6.6
STATOR WINDING				
Resistance Line-Line*	Ω	6.4	2.9	1.5
Inductance Line-Line	mH	39	18	9.4
THERMAL				
Insulation Class		F	F	F
Max. Ambient Temperature	°C	40	40	40
	°F	104	104	104
Thermal Time Constant	minutes	40	40	40
Thermal Resistance	°C/W	0.72	0.72	0.72
	°F/W	1.3	1.3	1.3
MECHANICAL				
Static Friction Torque	Nm	0.066	0.066	0.066
	lb-in	0.58	0.58	0.58
Cogging Torque	Nm	0.137	0.137	0.137
	lb-in	1.21	1.21	1.21
Motor Weight	kg	6.9	6.9	6.9
	lb	15	15	15

Notes

- * - All data is subject to a tolerance of ±10% (except motor 'Voltage Gradient' and K_t which are to +15%/-5%).
- At 25°C.
- † - Note that K_t is shown as a combined value for all **three phases**.
- ψ - The temperature rise ΔT on the windings is 110K and applies to all continuous torque values. The maximum ambient temperature is 40°C and therefore the temperature on the windings should not be more than 150°C. A value higher than 150°C would exceed the class F insulation temperature specification.

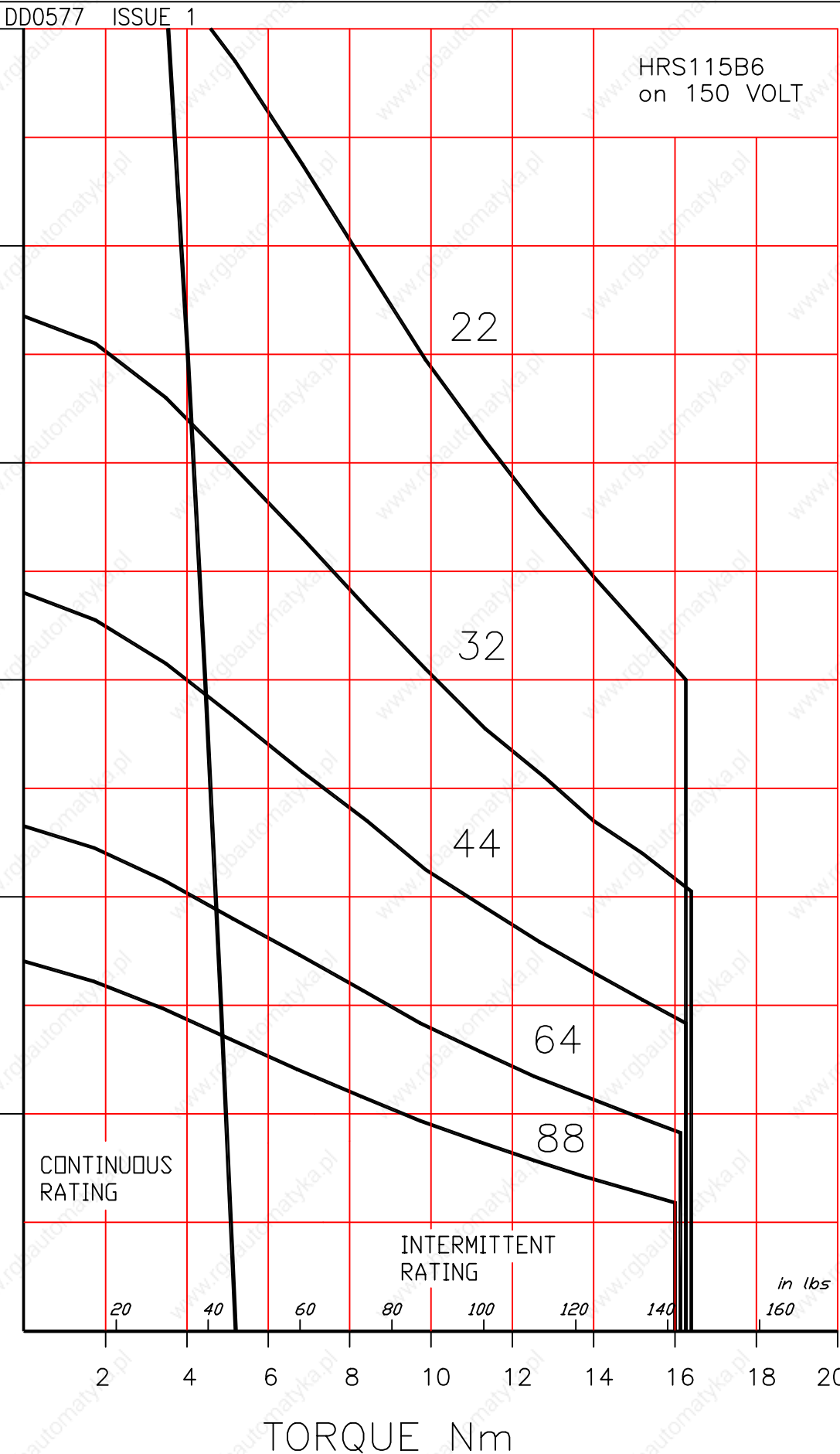

DD0582 ISSUE 1

HRS115B6
on 250 VOLT

10A

10A

RPM

6000

5000

4000

3000

2000

1000

CONTINUOUS
RATING

INTERMITTENT
RATING

in lbs
160

20

40

60

80

100

120

140

2

4

6

8

10

12

14

16

18

20

TORQUE Nm

64

44

88

130

180

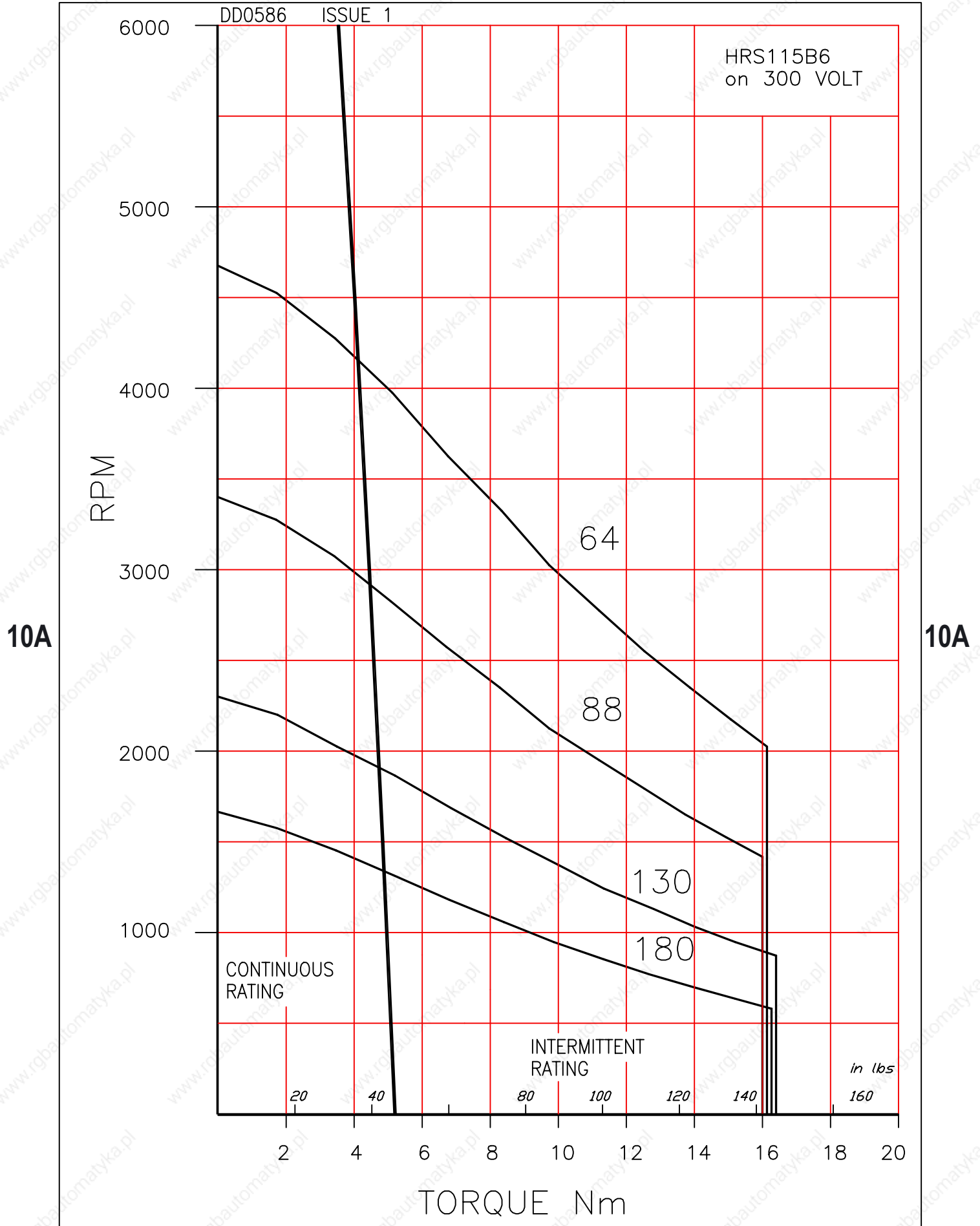

DD0591 ISSUE 1

HRS115B6
on 560 VOLT

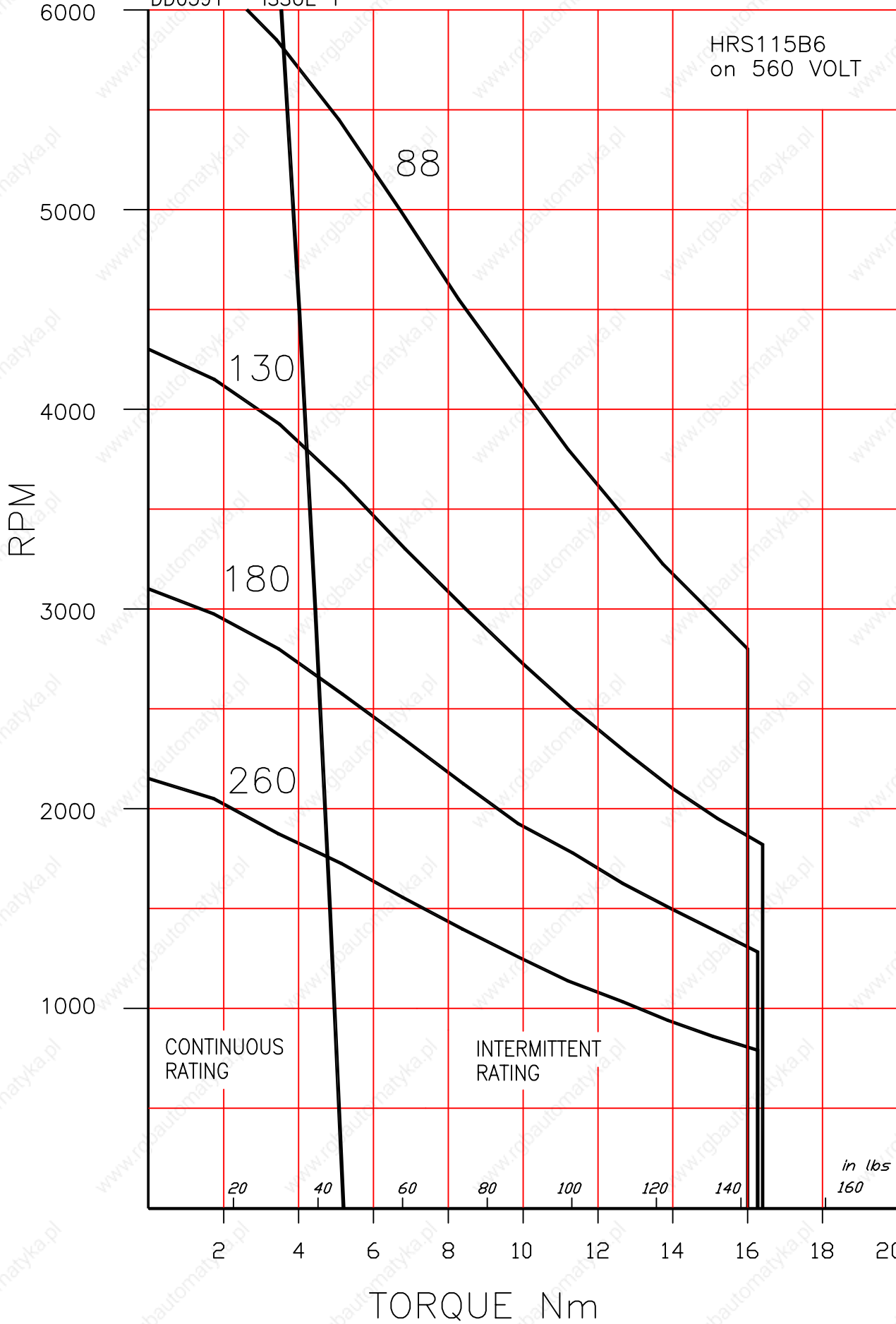

10A

10A

in lbs
160

TORQUE Nm

DD0596 ISSUE 1

HRS115B6
on 650 VOLT

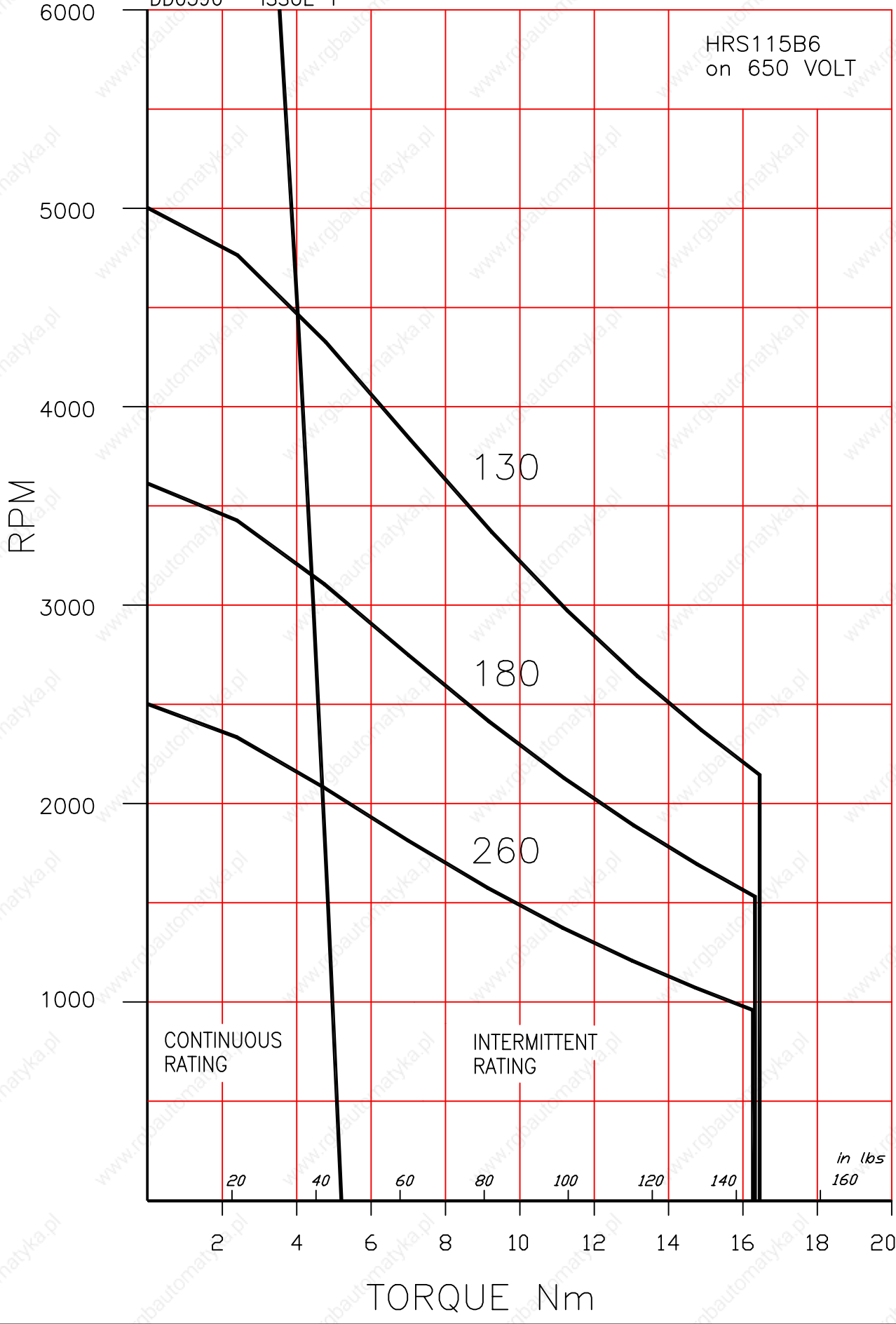

10A

10A

TORQUE Nm

in lbs
160

HRS115C6 Brushless AC Servomotors

Technical Data

10A

Parameter	Units	HRS115C6-130S	HRS115C6-88S	HRS115C6-64S
GENERAL				
Voltage Gradient No Load	Line-Line Volts (Peak)/1000rpm	130	88	64
Max. Current (Peak)	A	24	35	48
Max. Motor EMF	Line-Line Volts	700	530	380
Max. Mechanical Speed Limit	rpm	5400	6000	6000
Continuous Stall Torque TENV (110K) ^ψ	Nm	6.8	6.8	6.8
	lb-in	60	60	60
(Size 300 x 300 x 12 mm)	Nm	7.5	7.5	7.5
Cont. Stall Torque when fitted to Heatsink (Size 12 x 12 x 0.5 in)	lb-in	66	66	66
Peak Stall Torque	Nm	22	22	22
	lb-in	190	190	190
Continuous Stall Current rms (110K) ^ψ	A	9.1	6.6	4.5
Rotor Polar Moment of Inertia (Inclusive of Resolver Inertia)	kgcm ² lb-in s ²	5.1 0.0045	5.1 0.0045	5.1 0.0045
Torque Constant 3 x K _{t_rms} * [†]	Nm/A lb-in/A	1.53 13.5	1.02 9	0.75 6.6
STATOR WINDING				
Resistance Line-Line*	Ω	3.7	1.7	0.9
Inductance Line-Line	mH	28	12.6	6.7
THERMAL				
Insulation Class		F	F	F
Max. Ambient Temperature	°C	40	40	40
	°F	104	104	104
Thermal Time Constant	minutes	45	45	45
Thermal Resistance	°C/W	0.64	0.64	0.64
	°F/W	1.15	1.15	1.15
MECHANICAL				
Static Friction Torque	Nm	0.066	0.066	0.066
	lb-in	0.58	0.58	0.58
Cogging Torque	Nm	0.17	0.17	0.17
	lb-in	1.5	1.5	1.5
Motor Weight	kg	8.1	8.1	8.1
	lb	18	18	18

Notes

- * - All data is subject to a tolerance of ±10% (except motor 'Voltage Gradient' and K_t which are to +15%/-5%).
- At 25°C.
- † - Note that K_t is shown as a combined value for all **three phases**.
- ψ - The temperature rise ΔT on the windings is 110K and applies to all continuous torque values. The maximum ambient temperature is 40°C and therefore the temperature on the windings should not be more than 150°C. A value higher than 150°C would exceed the class F insulation temperature specification.

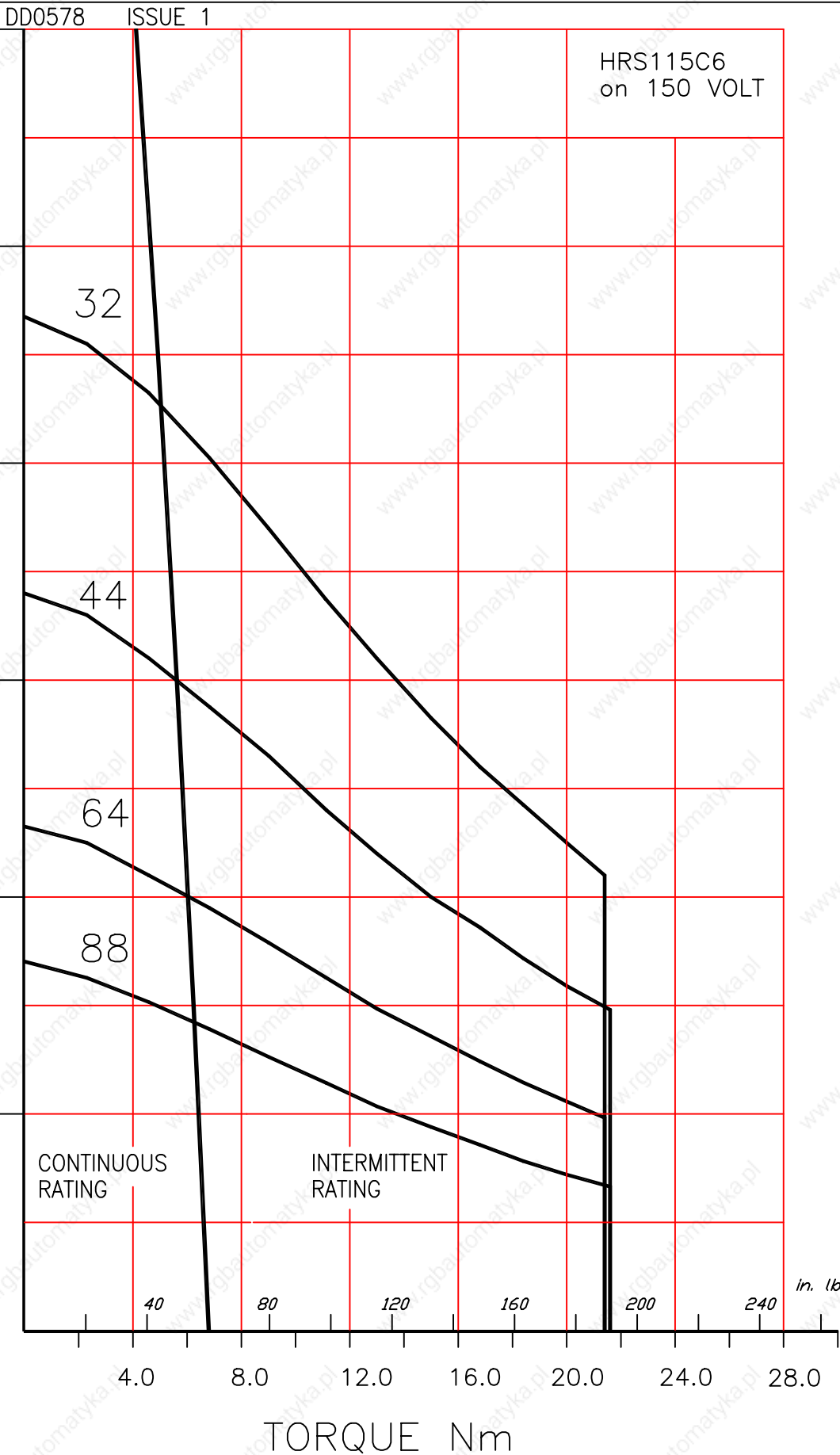

DD0583 ISSUE 1

HRS115C6
on 250 VOLT

RPM

10A

10A

6000

5000

4000

3000

2000

1000

CONTINUOUS
RATING

INTERMITTENT
RATING

TORQUE Nm

in. lbs

40

80

120

160

200

240

44

64

88

130

180

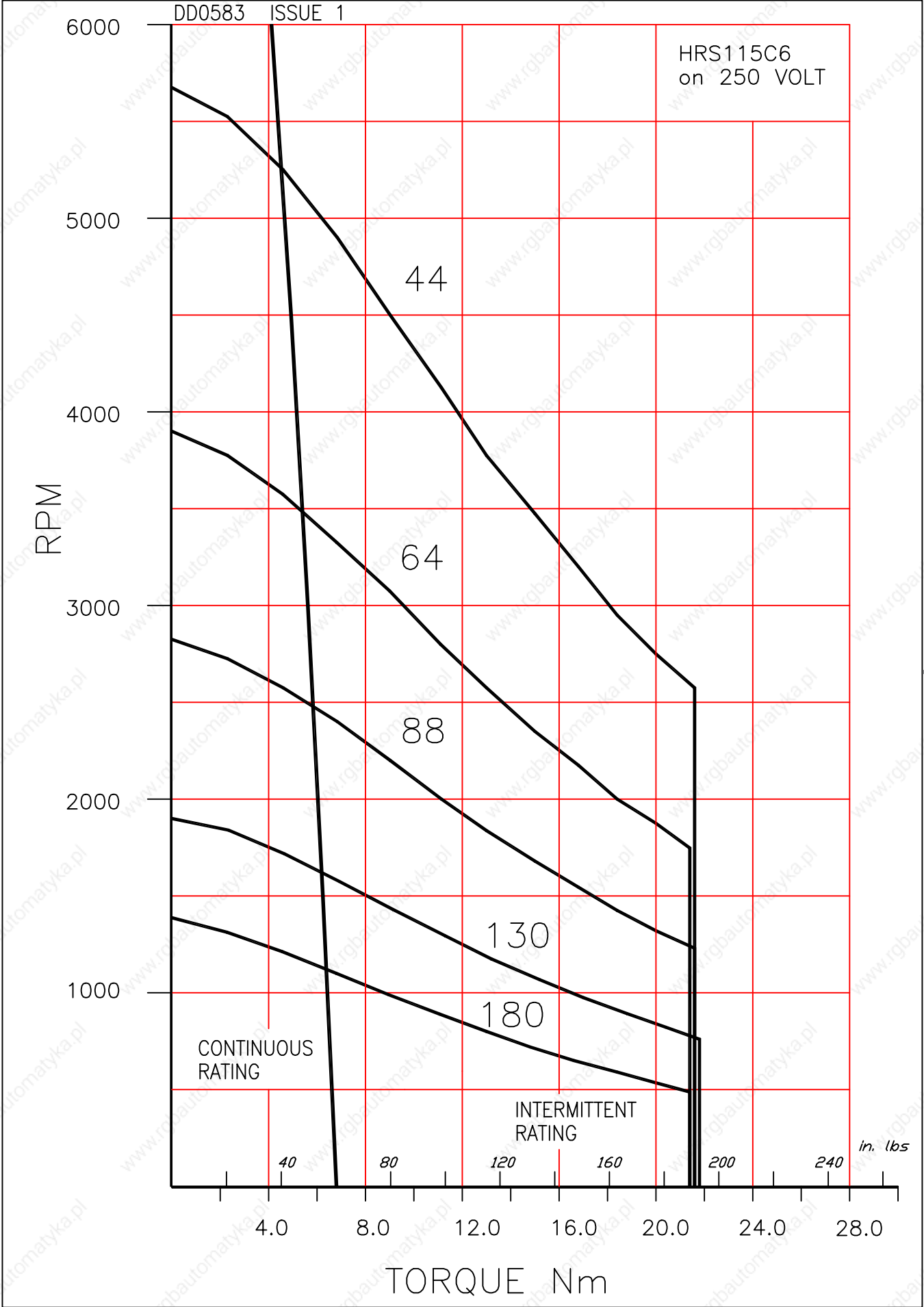

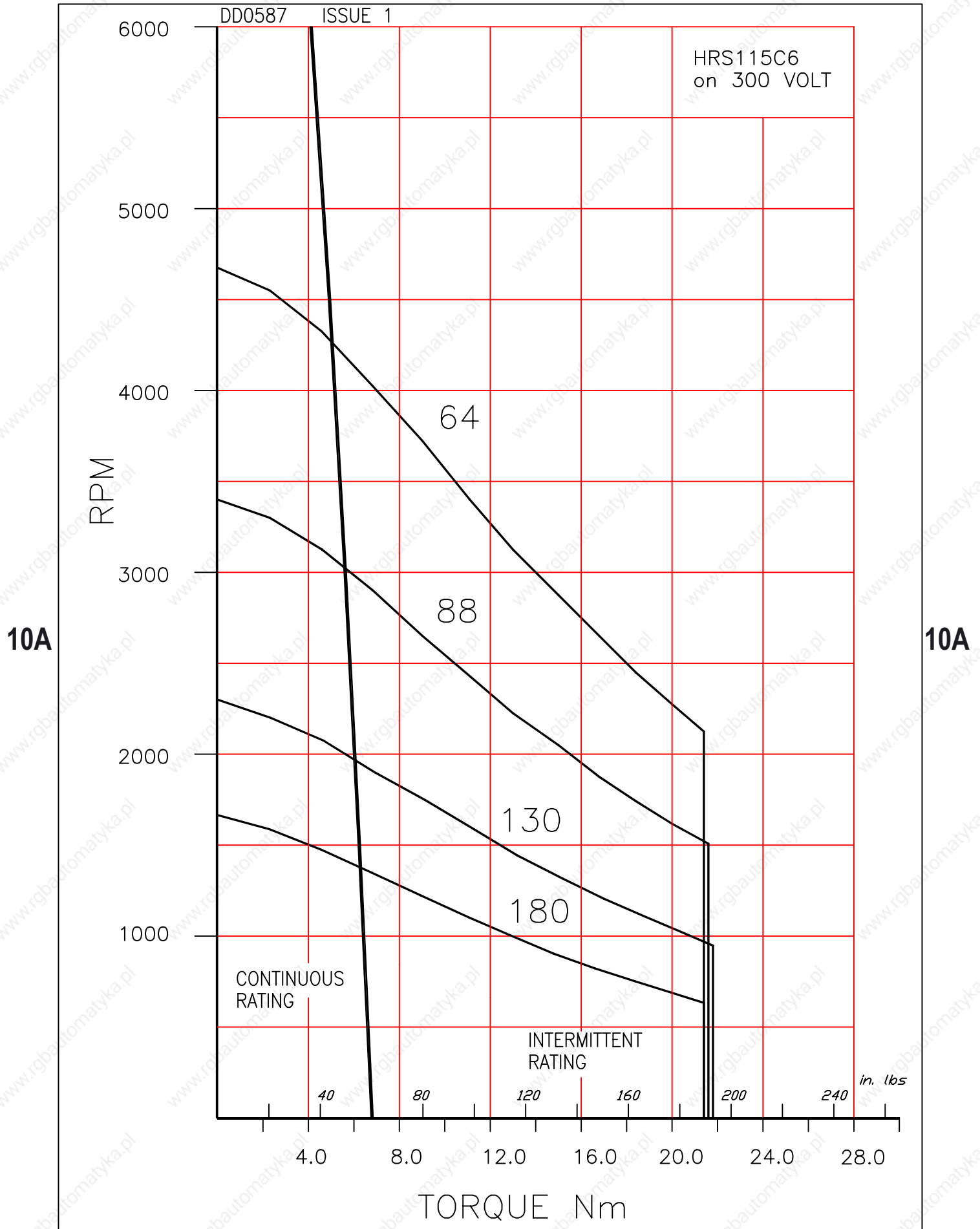

DD0592 ISSUE 1

HRS115C6
on 560 VOLT

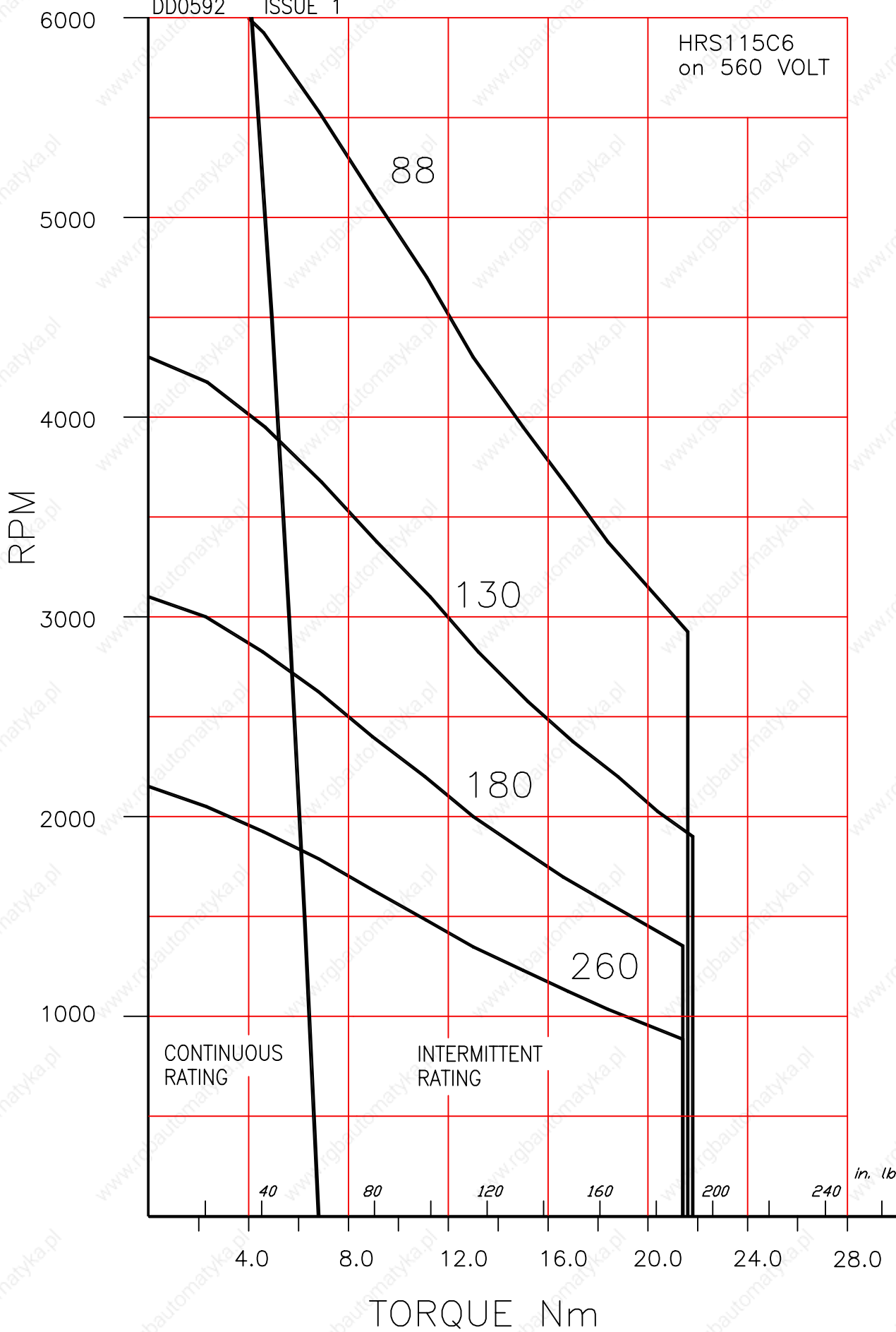

10A

10A

TORQUE Nm

in. lbs

DD0597 ISSUE 1

HRS115C6
on 650 VOLT

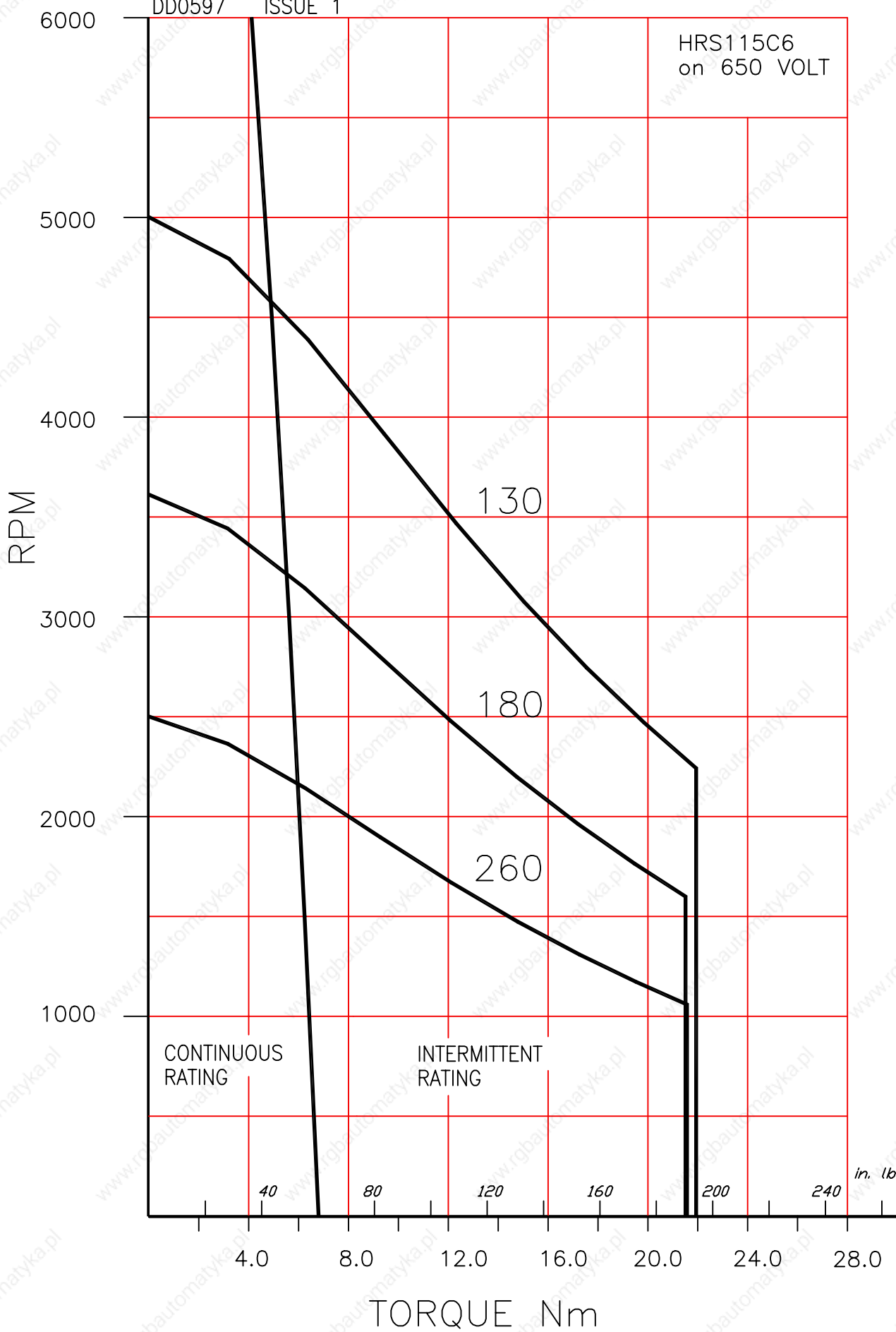

10A

10A

TORQUE Nm

in. lbs

HRS115E6 Brushless AC Servomotors

Technical Data

10A

Parameter	Units	HRS115E6-180S	HRS115E6-130S	HRS115E6-88S
GENERAL				
Voltage Gradient No Load	Line-Line Volts (Peak)/1000rpm	180	130	88
Max. Current (Peak)	A	26	36	53
Max. Motor EMF	Line-Line Volts	700	700	530
Max. Mechanical Speed Limit	rpm	3900	5400	6000
Continuous Stall Torque TENV (110K) ^ψ	Nm	9.8	9.8	9.8
	lb-in	87	87	87
(Size 300 x 300 x 12 mm)	Nm	10.8	10.8	10.8
Cont. Stall Torque when fitted to Heatsink (Size 12 x 12 x 0.5 in)	lb-in	96	96	96
Peak Stall Torque	Nm	33	33	33
	lb-in	290	290	290
Continuous Stall Current rms (110K) ^ψ	A	4.7	6.4	9.5
Rotor Polar Moment of Inertia (Inclusive of Resolver Inertia)	kgcm ² lb-in s ²	7.5 0.0066	7.5 0.0066	7.5 0.0066
Torque Constant 3 x K _{t_rms} * [†]	Nm/A lb-in/A	2.1 19	1.53 13.5	1.02 9
STATOR WINDING				
Resistance Line-Line*	Ω	4.2	2.1	1.01
Inductance Line-Line	mH	34	18	8.1
THERMAL				
Insulation Class		F	F	F
Max. Ambient Temperature	°C	40	40	40
	°F	104	104	104
Thermal Time Constant	minutes	55	55	55
Thermal Resistance	°C/W	0.58	0.58	0.58
	°F/W	1.04	1.04	1.04
MECHANICAL				
Static Friction Torque	Nm	0.066	0.066	0.066
	lb-in	0.58	0.58	0.58
Cogging Torque	Nm	0.24	0.24	0.24
	lb-in	2.1	2.1	2.1
Motor Weight	kg	10.5	10.5	10.5
	lb	23	23	23

Notes

- * - All data is subject to a tolerance of ±10% (except motor 'Voltage Gradient' and K_t which are to +15%/-5%).
- At 25°C.
- † - Note that K_t is shown as a combined value for all **three phases**.
- ψ - The temperature rise ΔT on the windings is 110K and applies to all continuous torque values. The maximum ambient temperature is 40°C and therefore the temperature on the windings should not be more than 150°C. A value higher than 150°C would exceed the class F insulation temperature specification.

DD0579 ISSUE 1

HRS115E6
on 150 VOLT

RPM

10A

10A

6000

5000

4000

3000

2000

1000

CONTINUOUS
RATING

INTERMITTENT
RATING

44

64

88

50

100

150

200

250

300

in. lbs

4

8

12

16

20

24

28

32

36

40

TORQUE Nm

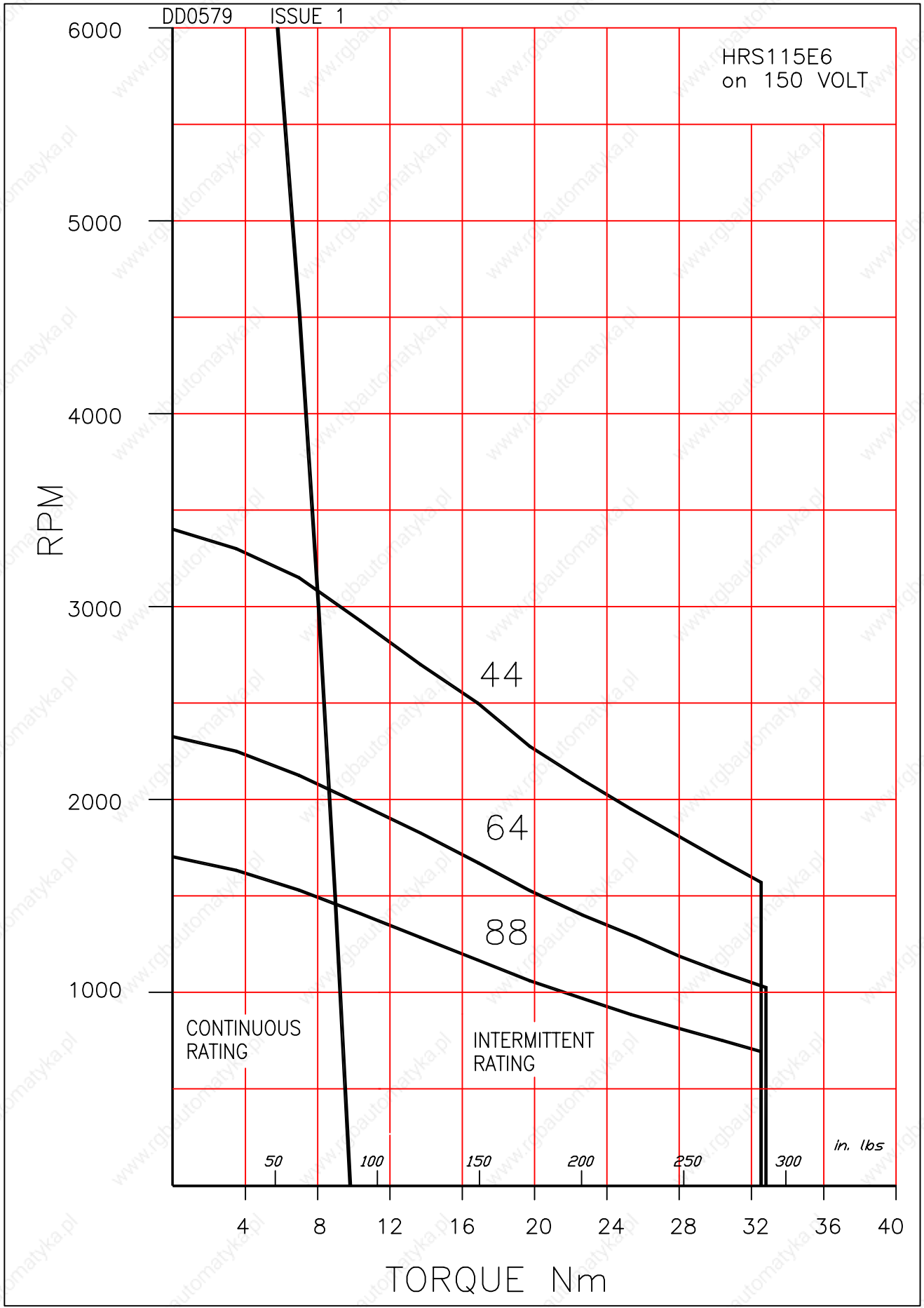

DD0583 ISSUE 1

HRS115E6
on 250 VOLT

10A

10A

RPM

6000

5000

4000

3000

2000

1000

CONTINUOUS
RATING

INTERMITTENT
RATING

in. lbs

50

100

150

200

250

300

4

8

12

16

20

24

28

32

36

40

TORQUE Nm

64

88

130

180

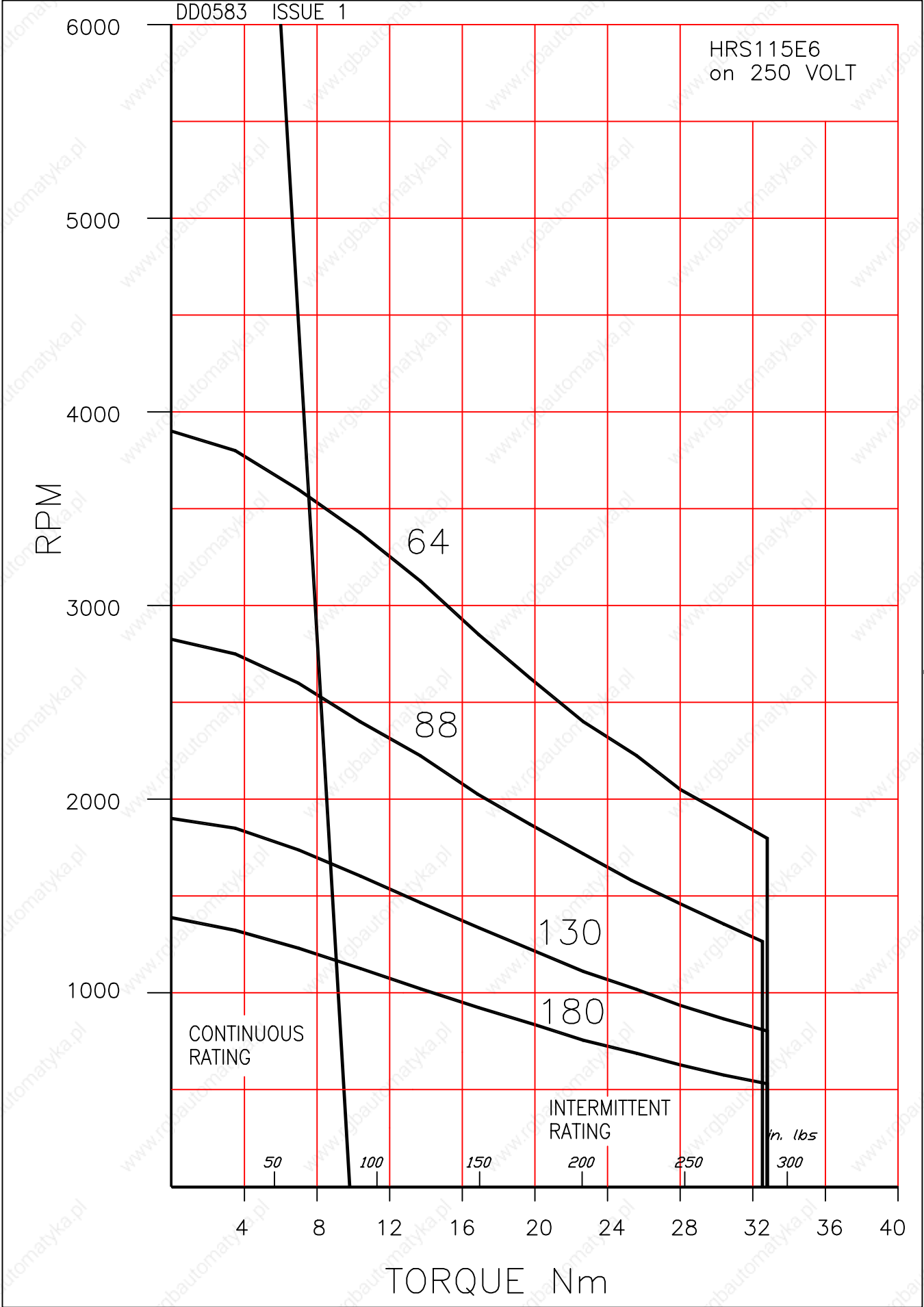

DD0588 ISSUE 1

HRS115E6
on 300 VOLT

RPM

10A

10A

6000

5000

4000

3000

2000

1000

CONTINUOUS
RATING

INTERMITTENT
RATING

64

88

130

180

50

100

150

200

250

n. lbs

300

4

8

12

16

20

24

28

32

36

40

TORQUE Nm

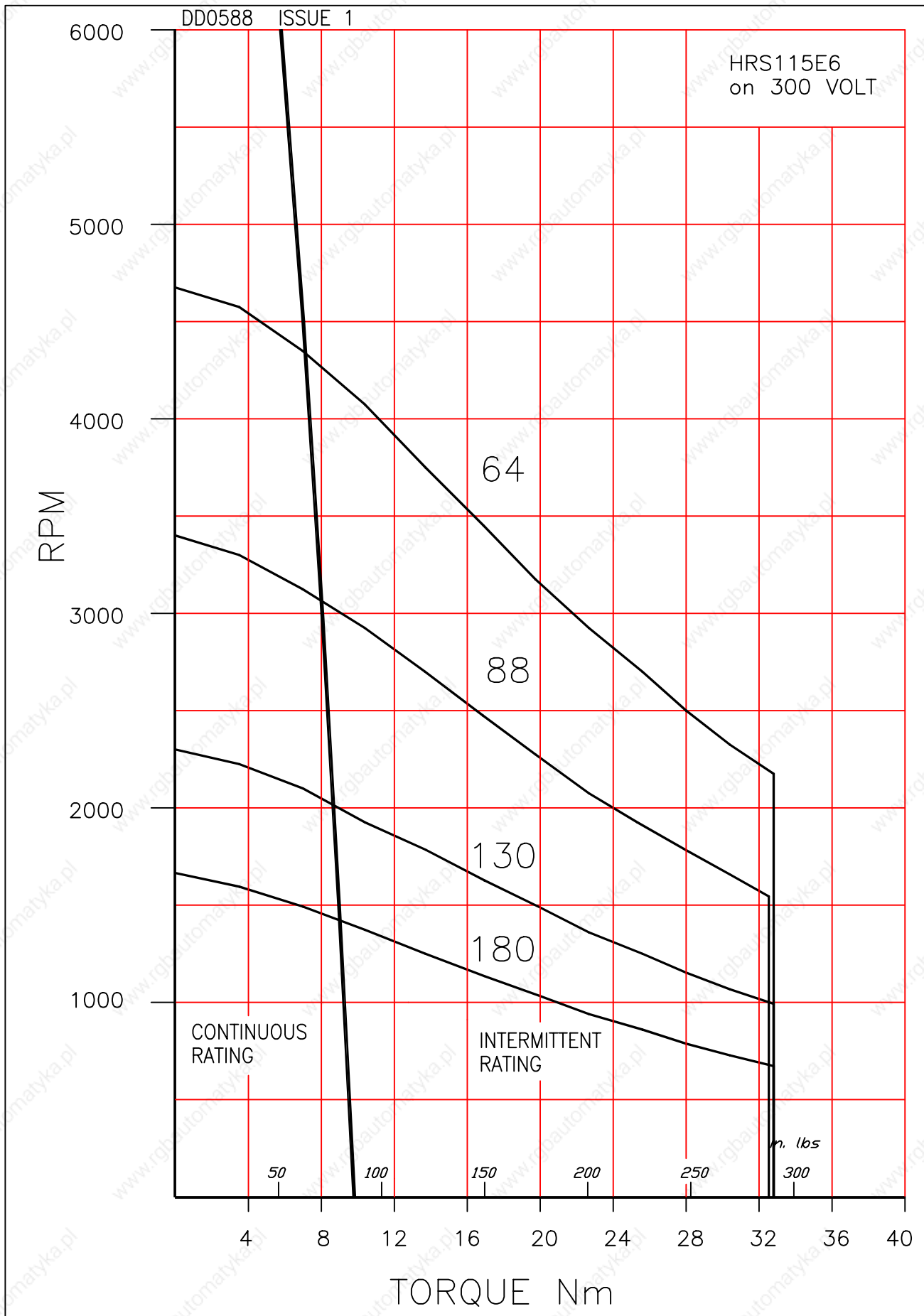

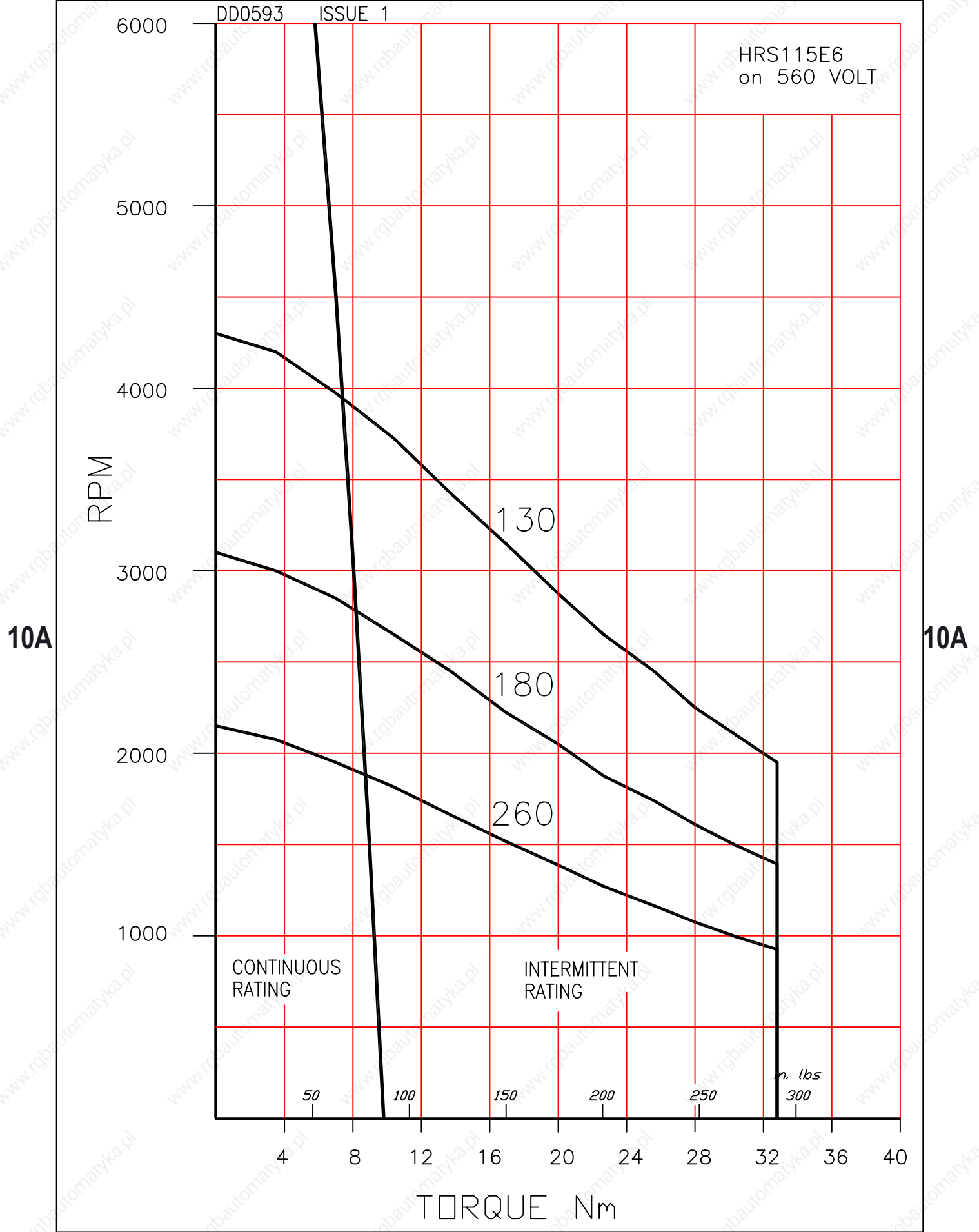

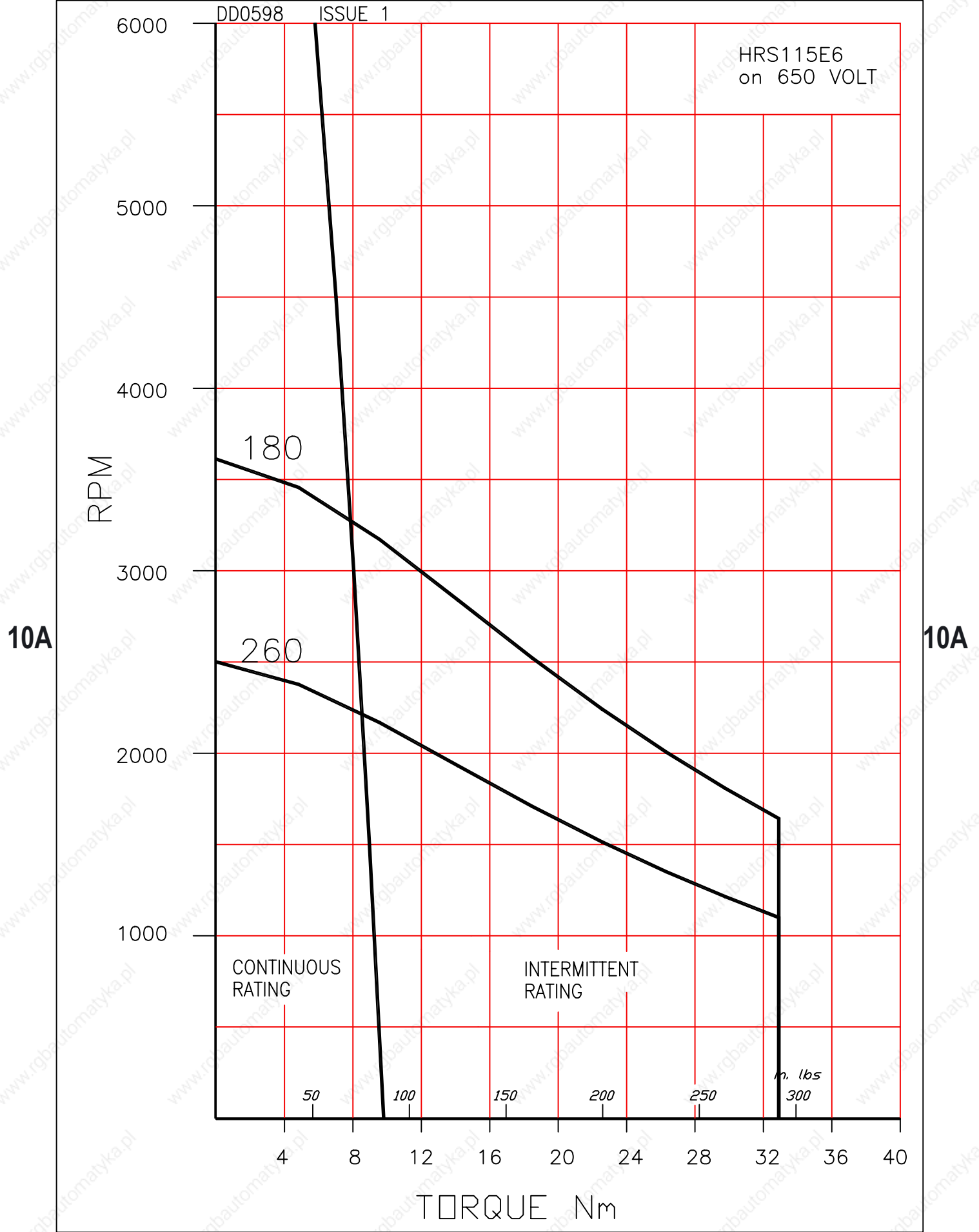

FIRST ANGLE PROJECTION

MOTOR CONNECTOR :- INTERCONNECTRON SIZE 1, 6 PIN

FEEDBACK CONNECTOR :- INTERCONNECTRON SIZE 1, 12 PIN, 20° OFFSET

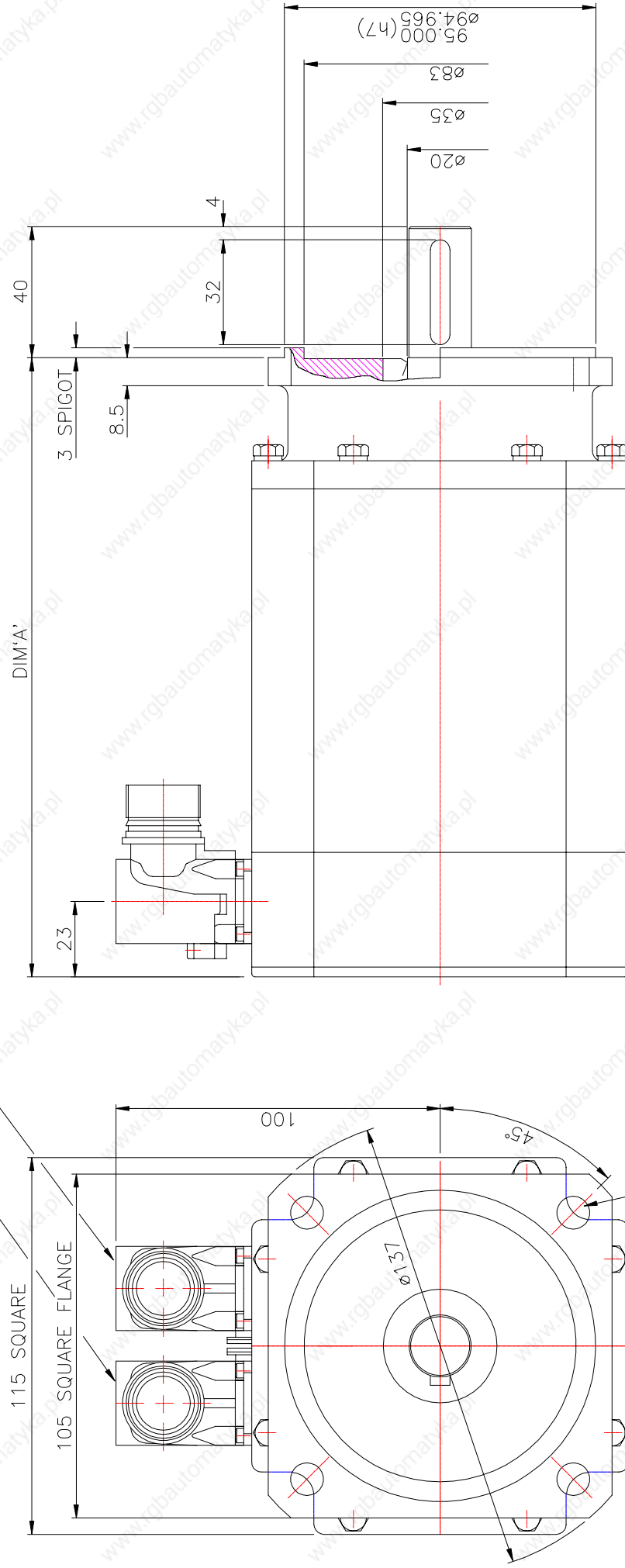

4-FIXING HOLES ø10 EQUI-SPACED ON 115 PCD

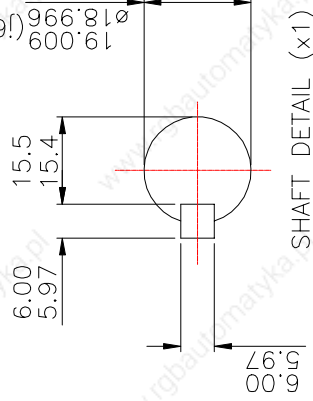

SHAFT DETAIL (x1)

FRAME NO	NO BRAKE	WITH BRAKE
115A	189	209
115B	209	229
115C	229	249
115E	269	289
115G	309	329

3 17DEC04 MR3355 KEYWAY NOW ENCLOSED.

TITLE : OUTLINE HRS115 STD METRIC - RES + SIZE 1 CONNS.

DRAWING NO.
664-7-06332

SCALE 3:4

ISSUE No. 3

ALL DIMENSIONS IN MILLIMETRES
TOLERANCES UNLESS ANG: ±0.5°
OTHERWISE STATED DIM: ±0.25mm

MATERIAL
SPEC
FINISH

CODE
FORM
PATTERN No.



DR. SIH
DATE 30JAN03
A06332C1

HRS115 - OPTIONS (metric series)

10A

Code	Description	Notes
WAVEFORM (WINDING)		
Y00*	Waveform.	Sinusoidal waveform.
FEEDBACK DEVICES		
F00*	Resolver (F00 setting).	2 Pole Resolver type 21-B with F00 setting.
F16	Resolver (F16 setting)	2 Pole Resolver type 21-B with alternative F16 setting.
F66	No Feedback fitted	
FITTED ENCODERS		
E15	Encoder	Heidhenhain ERN1387 series, 2048ppr.
E22	Encoder, singleturn, Optical	Heidhenhain ECN1313 series, 2048ppr with EnDat Interface.
E16	Encoder, multiturn, Optical	Heidhenhain EQN1325 series, 2048ppr with EnDat Interface.
E33	Encoder, singleturn, Inductive	Heidhenhain ECI1319 series, 32ppr with EnDat Interface
E34	Encoder, multiturn, Inductive	Heidhenhain ECI1331 series, 32ppr with EnDat Interface
E20	Encoder, singleturn.	Stegmann SRS50 series with Hiperface Interface.
E21	Encoder, multiturn.	Stegmann SRM50 series with Hiperface Interface.
E26**	Incremental encoder	Renco R35i, 1000ppr
E28**	Incremental encoder	Renco R35i, 2048ppr
E29**	Incremental encoder	Renco R35i, 4000ppr
E31**	Incremental encoder	Renco R35i, 8192ppr
MECHANICAL INTERFACE		
M00*	Flange.	105 x 105 mm square flange. Spigot Ø 95mm. Fixing 4 x Ø 10 mm holes on 115 mm PCD.
R01	Close tolerance interface.	Flange & shaft to IEC72-P (precision).
S00*	Shaft.	Ø 19mm x 40mm long.
K00*	Keyway.	6 x 6 x 30 mm long.
K99	No Keyway.	Plain shaft.
D01*	Shaft end threaded hole.	M6 x 15mm deep.
BRAKES		
B00	24Vdc Brake.	13.5Nm Torque
ELECTRICAL TERMINATIONS		
C47*	Motor & feedback connector.	Interconnectron motor receptacle (6 pin) and feedback receptacle (12 pin 20 degree offset) (for motors fitted with resolver)
C48	Motor & feedback connector.	Interconnectron motor receptacle (6 pin) and feedback receptacle (17 pin) (for motors fitted with encoder)
C68	Feedback plug.	Interconnectron straight plug (12 pin) & cable clamp for C47.
C69	Feedback plug.	Interconnectron straight plug (17 pin) & cable clamp for C48.
C67	Motor plug.	Interconnectron straight plug (6 pin) & cable clamp for C47/C48.
THERMAL PROTECTION		
P21*	Thermal overload.	Bi-metal thermal switch.
P17	Thermal overload.	Temperature sensor, Phillips type KTY 84-130.
P18	No thermal overload.	Thermal protection not fitted.
ENCLOSURE PROTECTION		
W00*	IP64/65 enclosure.	Nitrile shaft seal for IP64/65 protection (factory fitted).
W01	IP64/65 enclosure.	Viton shaft seal for IP64/65 protection (factory fitted).
W02	IP64/65 enclosure.	Nitrile shaft seal for IP64/65 protection (supplied loose).
W03	IP64/65 enclosure.	Viton shaft seal for IP64/65 protection (supplied loose).
W99	No Shaft Seal Fitted	
UL APPROVAL		
U00	UL approved motor	

* Standard feature

** Other line counts available on request

HR142C6

HR142E6

HR142G6

HR142J6

HR142

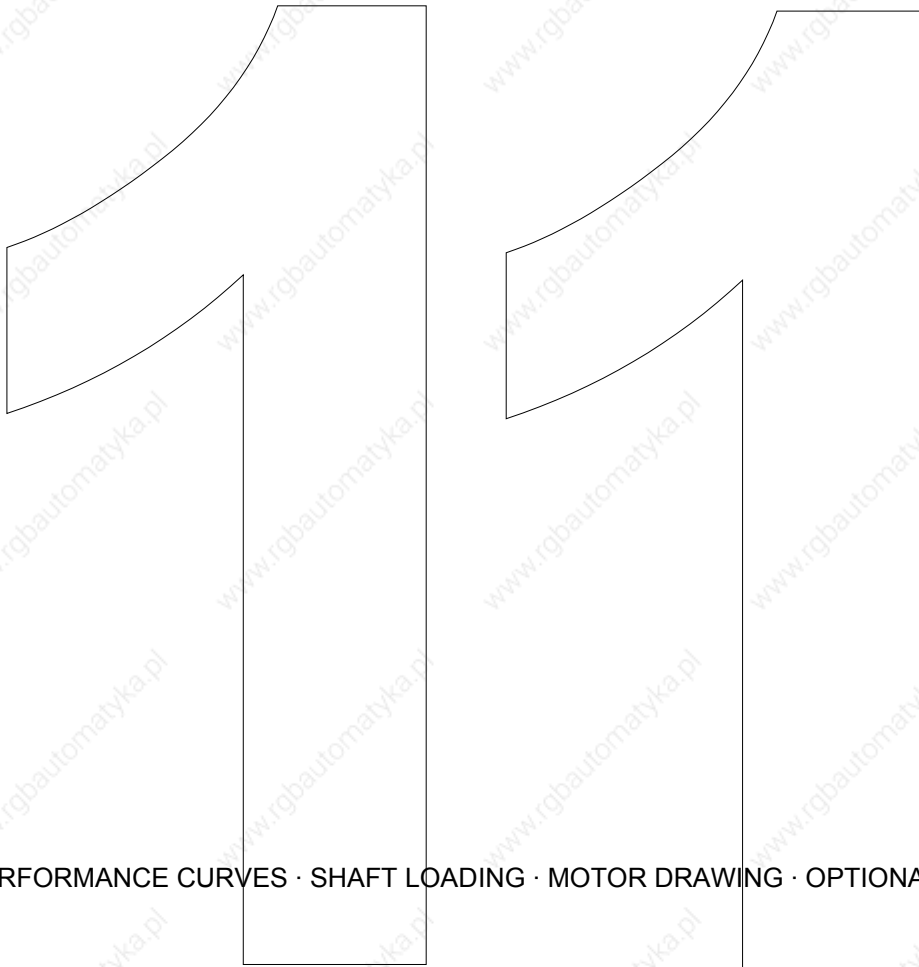

DATA TABLES · PERFORMANCE CURVES · SHAFT LOADING · MOTOR DRAWING · OPTIONAL FEATURES

HR142C6

Brushless AC Servomotors

11

Technical Data

Parameter	Units	HR142C6-130	HR142C6-88	HR142C6-64	HR142C6-44
GENERAL					
Voltage Gradient No Load	Line-Line Volts (Peak)/1000RPM	130	88	64	44
Max. Motor EMF	Line - Line Volts	700	530	380	260
Max. Speed	RPM	5400	6000	6000	6000
Continuous Stall Torque TENV					
	Nm	11.3	11.3	11.3	11.3
	lb-in	100	100	100	100
(Size 300 x 300 x 12 mm) Cont. Stall Torque when fitted to Heatsink	Nm	12.1	12.1	12.1	12.1
(Size 12 x 12 x 0.5 in)	lb-in	107	107	107	107
Peak Stall Torque	Nm	30	30	30	30
	lb - in	270	270	270	270
Continuous Stall Current rms (110K) ^ψ	Amps	7.4	11	15	22
Rotor Polar Moment of Inertia (Inclusive of Resolver Inertia)	kgcm ² lb-in sec ²	11.5 0.0102	11.5 0.0102	11.5 0.0102	11.5 0.0102
Max. Current (Peak)	Amps	35	52	72	105
Cogging Torque	Nm lb-in	0.24 2.124	0.24 2.124	0.24 2.124	0.24 2.124
Torque Constant Kt_{rms}^{*†}	Nm/Amp lb-in/Amp	1.53 13.5	1.02 9.0	0.75 6.6	0.51 4.5
STATOR WINDING					
Resistance Line-Line*	Ohms	1.7	0.76	0.38	0.2
Inductance Line-Line	MilliHenrys	19	8.9	4.7	2.2
THERMAL					
Insulation Class		F	F	F	F
Max. Ambient Temperature	°C °F	40 104	40 104	40 104	40 104
Thermal Time Constant	Minutes	50	50	50	50
Thermal Resistance	°C/Watt °F/Watt	0.57 1.02	0.57 1.02	0.57 1.02	0.57 1.02
MECHANICAL					
Static Friction Torque	Nm lb	0.12 1.06	0.12 1.06	0.12 1.06	0.12 1.06
Motor Weight	kg lb	14 31	14 31	14 31	14 31

Notes

Tolerance

* - All data is subject to a tolerance of ±10% (except motor 'Voltage Gradient' and Kt which are to +15%/-5%).

† - At 25°C.

‡ - Note that Kt is shown as a combined value for all **three phases**.

ψ - The temperature rise ΔT on the windings is 110K and applies to all continuous torque values. The maximum ambient temperature is 40°C and therefore the temperature on the windings should not be more than 150°C. A value higher than 150°C would exceed the class F insulation temperature specification.

HR142E6

Brushless AC Servomotors

11

Technical Data

Parameter	Units	HR142E6-180	HR142E6-130	HR142E6-88	HR142E6-64
GENERAL					
Voltage Gradient No Load	Line-Line Volts (Peak)/1000RPM	180	130	88	64
Max. Motor EMF	Line - Line Volts	700	700	530	380
Max. Speed	RPM	3900	5400	6000	6000
Continuous Stall Torque TENV					
	Nm	16	16	16	16
	lb-in	140	140	140	140
(Size 300 x 300 x 12 mm) Cont. Stall Torque when fitted to Heatsink	Nm	17	17	17	17
(Size 12 x 12 x 0.5 in)	lb-in	150	150	150	150
Peak Stall Torque	Nm	45	45	45	45
	lb - in	400	400	400	400
Continuous Stall Current rms (110K) ^ψ	Amps	7.6	10.5	16	21
Rotor Polar Moment of Inertia (Inclusive of Resolver Inertia)	kgcm ² lb-in sec ²	17 0.0150	17 0.0150	17 0.0150	17 0.0150
Max. Current (Peak)	Amps	38	53	78	109
Cogging Torque	Nm	0.34	0.34	0.34	0.34
	lb-in	3	3	3	3
Torque Constant Kt_{rms}^{*†}					
	Nm/Amp	2.1	1.53	1.02	0.75
	lb-in/Amp	18	13.5	9.0	6.6
STATOR WINDING					
Resistance Line-Line*	Ohms	1.7	0.9	0.42	0.2
Inductance Line-Line	MilliHenrys	22	11.8	5.3	2.8
THERMAL					
Insulation Class		F	F	F	F
Max. Ambient Temperature	°C	40	40	40	40
	°F	104	104	104	104
Thermal Time Constant	Minutes	55	55	55	55
Thermal Resistance	°C/Watt	0.53	0.53	0.53	0.53
	°F/Watt	0.96	0.96	0.96	0.96
MECHANICAL					
Static Friction Torque	Nm	0.12	0.12	0.12	0.12
	lb	1.06	1.06	1.06	1.06
Motor Weight	kg	18	18	18	18
	lb	40	40	40	40

Notes

Tolerance

- All data is subject to a tolerance of $\pm 10\%$ (except motor 'Voltage Gradient' and Kt which are to $+15\%/-5\%$).
* - At 25°C.

†

- Note that Kt is shown as a combined value for all **three phases**.

ψ

- The temperature rise ΔT on the windings is 110K and applies to all continuous torque values. The maximum ambient temperature is 40°C and therefore the temperature on the windings should not be more than 150°C. A value higher than 150°C would exceed the class F insulation temperature specification.

HR142G6

Brushless AC Servomotors

11

Technical Data

Parameter	Units	HR142G6-180	HR142G6-130	HR142G6-88
GENERAL				
Voltage Gradient No Load	Line-Line Volts (Peak)/1000RPM	180	130	88
Max. Motor EMF	Line - Line Volts	700	700	530
Max. Speed	RPM	3900	5400	6000
Continuous Stall Torque TENV				
	Nm	21	21	21
	lb-in	186	186	186
(Size 300 x 300 x 12 mm)	Nm	21.5	21.5	21.5
Cont. Stall Torque when fitted to Heatsink (Size 12 x 12 x 0.5 in)	lb-in	190	190	190
Peak Stall Torque	Nm	60	60	60
	lb - in	530	530	530
Continuous Stall Current rms (110K) ^ψ	Amps	10	13.8	20
Rotor Polar Moment of Inertia (Inclusive of Resolver Inertia)	kgcm ² lb-in sec ²	22 0.0190	22 0.0190	22 0.0190
Max. Current (Peak)	Amps	50	70	102
Cogging Torque	Nm	0.43	0.43	0.43
	lb-in	3.805	3.805	3.805
Torque Constant Kt_{rms}*†				
	Nm/Amp	2.1	1.53	1.02
	lb-in/Amp	18.6	13.5	9.0
STATOR WINDING				
Resistance Line-Line*	Ohms	1.12	0.6	0.29
Inductance Line-Line	MilliHenrys	16	8.4	4
THERMAL				
Insulation Class		F	F	F
Max. Ambient Temperature	°C	40	40	40
	°F	104	104	104
Thermal Time Constant	Minutes	60	60	60
Thermal Resistance	°C/Watt	0.45	0.45	0.45
	°F/Watt	0.81	0.81	0.81
MECHANICAL				
Static Friction Torque	Nm	0.12	0.12	0.12
	lb	1.06	1.06	1.06
Motor Weight	kg	21	21	21
	lb	46	46	46

Notes

Tolerance

- All data is subject to a tolerance of $\pm 10\%$ (except motor 'Voltage Gradient' and Kt which are to $+15\%/-5\%$).

*

- At 25°C.

†

- Note that Kt is shown as a combined value for all **three phases**.

ψ

- The temperature rise ΔT on the windings is 110K and applies to all continuous torque values. The maximum ambient temperature is 40°C and therefore the temperature on the windings should not be more than 150°C. A value higher than 150°C would exceed the class F insulation temperature specification.

HR142J6

Brushless AC Servomotors

11

Technical Data

Parameter	Units	HR142J6-260	HR142J6-180	HR142J6-130
GENERAL				
Voltage Gradient No Load	Line-Line Volts (Peak)/1000RPM	260	180	130
Max. Motor EMF	Line - Line Volts	700	700	700
Max. Speed	RPM	2700	3900	5400
Continuous Stall Torque TENV				
	Nm	25	25	25
	lb-in	220	220	220
(Size 300 x 300 x 12 mm) Cont. Stall Torque when fitted to Heatsink	Nm	26	26	26
(Size 12 x 12 x 0.5 in)	lb-in	230	230	230
Peak Stall Torque	Nm	76	76	76
	lb - in	670	670	670
Continuous Stall Current rms (110K) ^ψ	Amps	8.2	11.9	16
Rotor Polar Moment of Inertia (Inclusive of Resolver Inertia)	kgcm ² lb-in sec ²	27 0.0240	27 0.0240	27 0.0240
Max. Current (Peak)	Amps	44	64	89
Cogging Torque	Nm	0.52	0.52	0.52
	lb-in	4.576	4.576	4.576
Torque Constant Kt_{rms}*†				
	Nm/Amp	3.03	2.1	1.53
	lb-in/Amp	27	18.6	13.5
STATOR WINDING				
Resistance Line-Line*	Ohms	1.8	0.88	0.43
Inductance Line-Line	MilliHenrys	25	12.3	6.3
THERMAL				
Insulation Class		F	F	F
Max. Ambient Temperature	°C	40	40	40
	°F	104	104	104
Thermal Time Constant	Minutes	65	65	65
Thermal Resistance	°C/Watt	0.43	0.43	0.43
	°F/Watt	0.78	0.78	0.78
MECHANICAL				
Static Friction Torque	Nm	0.12	0.12	0.12
	lb	1.06	1.06	1.06
Motor Weight	kg	25	25	25
	lb	55	55	55

Notes

Tolerance

- All data is subject to a tolerance of $\pm 10\%$ (except motor 'Voltage Gradient' and Kt which are to $+15\%/-5\%$).
* - At 25°C.

†

- Note that Kt is shown as a combined value for all **three phases**.

ψ

- The temperature rise ΔT on the windings is 110K and applies to all continuous torque values. The maximum ambient temperature is 40°C and therefore the temperature on the windings should not be more than 150°C. A value higher than 150°C would exceed the class F insulation temperature specification.

HR142 PERMITTED RADIAL SHAFT LOADING

(Axial loadings may be considered separately – refer to next page)

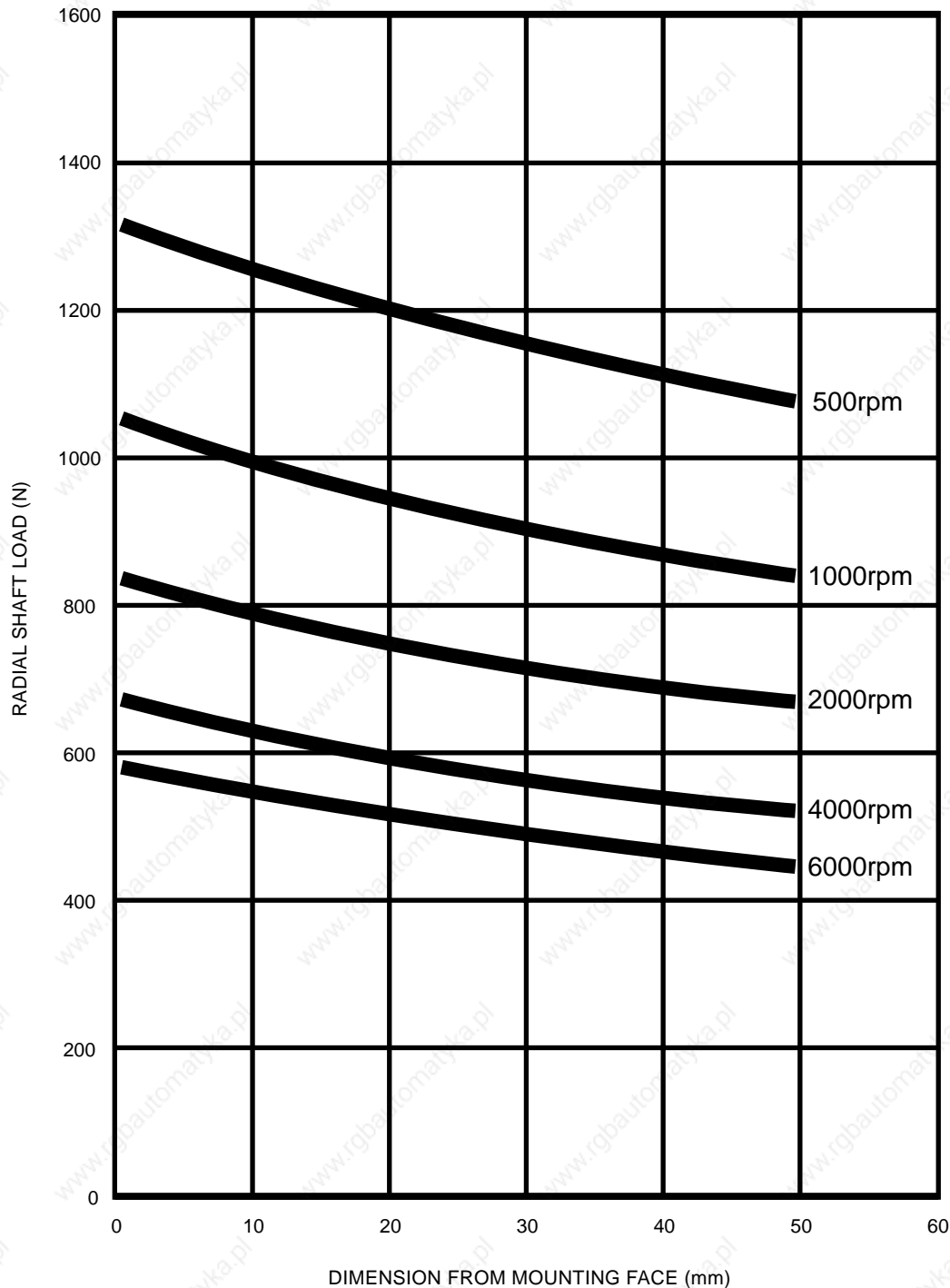

Shaft Loading Information for SEM Standard Servomotors

General notes:-

- 1 All loadings are based upon An L10 bearing life expectancy of 30,000 hours.
- 2 Separate graphs are usually supplied to indicate maximum axial loads which are applicable. However, for motors with locked drive end bearings, a graph is used to illustrate the maximum allowed radial shaft loadings together with a simplified calculation to provide a compensated figure for when radial and axial loadings are to be applied in combination.
- 3 It may occur, in certain circumstances, that loading outside the scope of the published information is deemed necessary. In these cases it is desirable that SEM Ltd should be consulted and all relevant information made available, in order that due consideration can be given to finding a satisfactory solution.
- 4 Should motors be required to operate under abnormal conditions, such as excessive vibration or shock, this should also be referred to SEM Ltd as noted above.

HR142 PERMITTED AXIAL LOAD

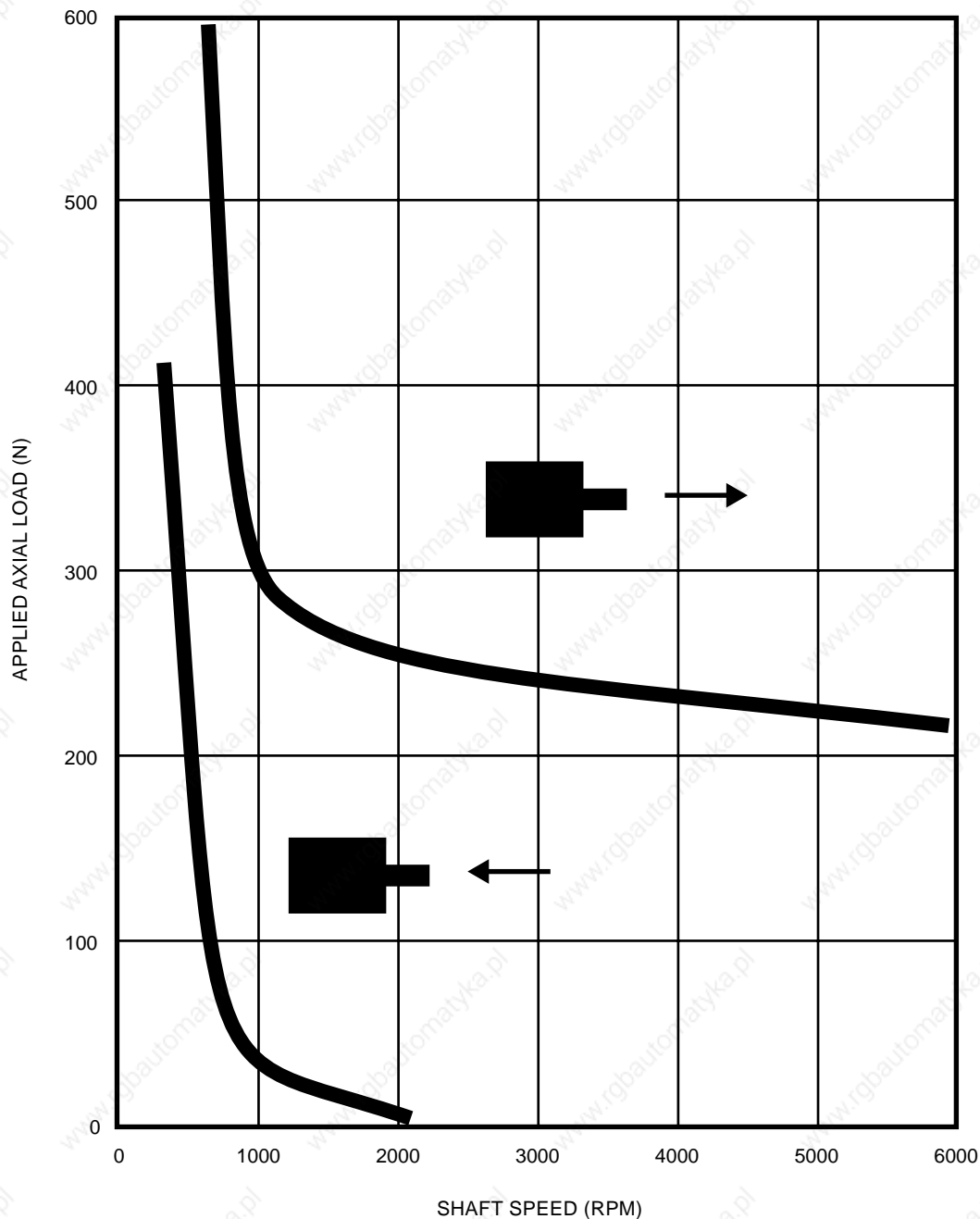

Shaft Loading Information for SEM Standard Servomotors

General notes:-

- 1 All loadings are based upon an L10 bearing life expectancy of 30,000 hours.
- 2 Separate graphs are usually supplied to indicate maximum axial loads which are applicable. However, for motors with locked drive end bearings, a graph is used to illustrate the maximum allowed radial shaft loadings together with a simplified calculation to provide a compensated figure for when radial and axial loadings are to be applied in combination.
- 3 It may occur, in certain circumstances, that loading outside the scope of the published information is deemed necessary. In these cases it is desirable that SEM Ltd should be consulted and all relevant information made available, in order that due consideration can be given to finding a satisfactory solution.
- 4 Should motors be required to operate under abnormal conditions, such as excessive vibration or shock, this should also be referred to SEM Ltd as noted above.

ALL DIMENSIONS IN MILLIMETRES

FRAME	DIM 'A'
HR142C	297
HR142E	337
HR142G	377
HR142J	417

SHAFT DETAIL

**HR142 STD + INTERCONNECTOR
SIZE 1.5 POWER CONNECTOR**

HR SERIES

*Dimensions may be subject to change without notice.
Certified drawings available on request.*

ALL DIMENSIONS IN MILLIMETRES

FRAME	DIM 'A'
HR142C	297
HR142E	337
HR142G	377
HR142J	417

SHAFT DETAIL

Dimensions may be subject to change without notice.
Certified drawings available on request.

**HR142 STD + INTERCONNECTRON
SIZE 1 POWER CONNECTOR**

HR SERIES

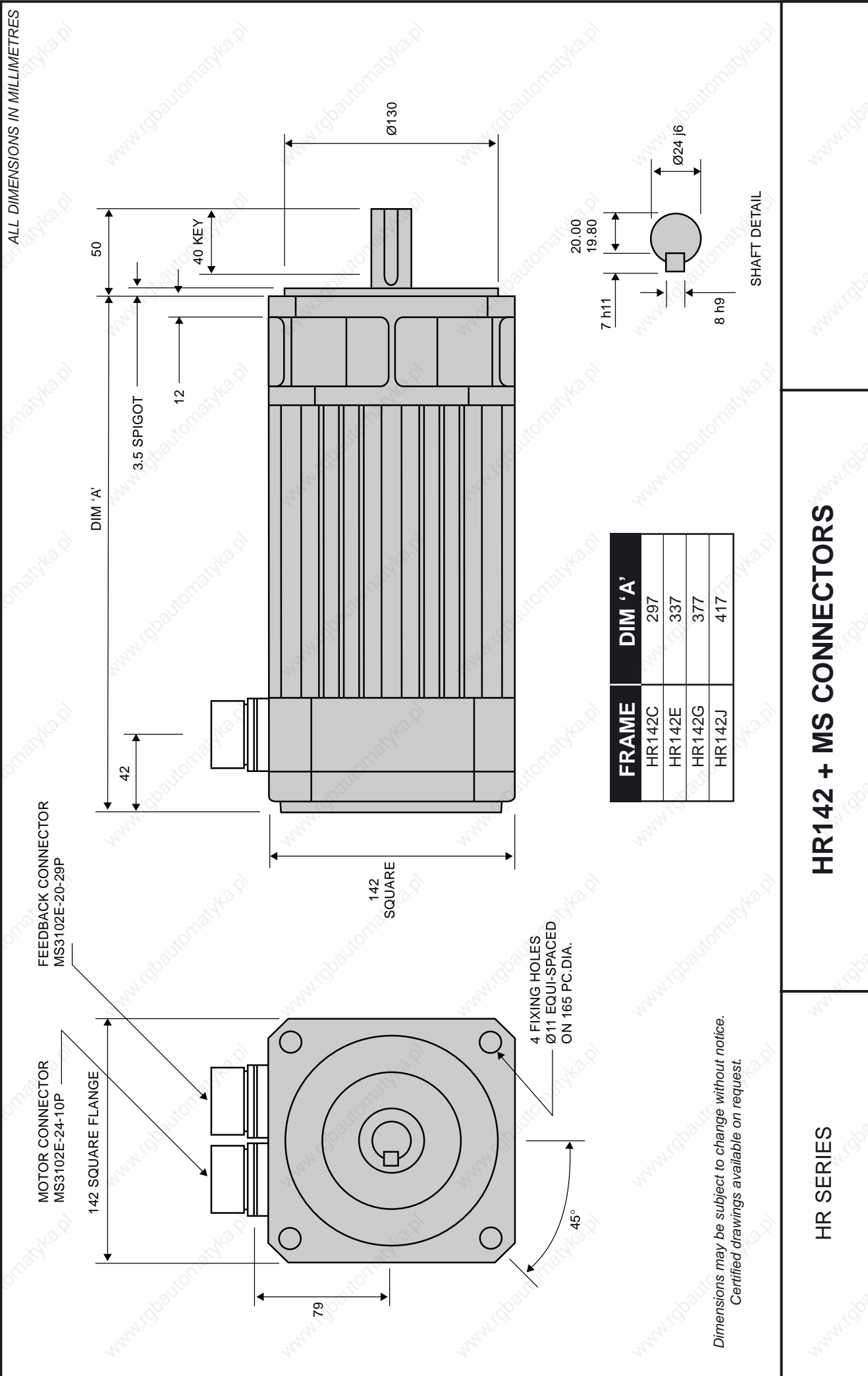

HR SERIES

HR142 + MS CONNECTORS

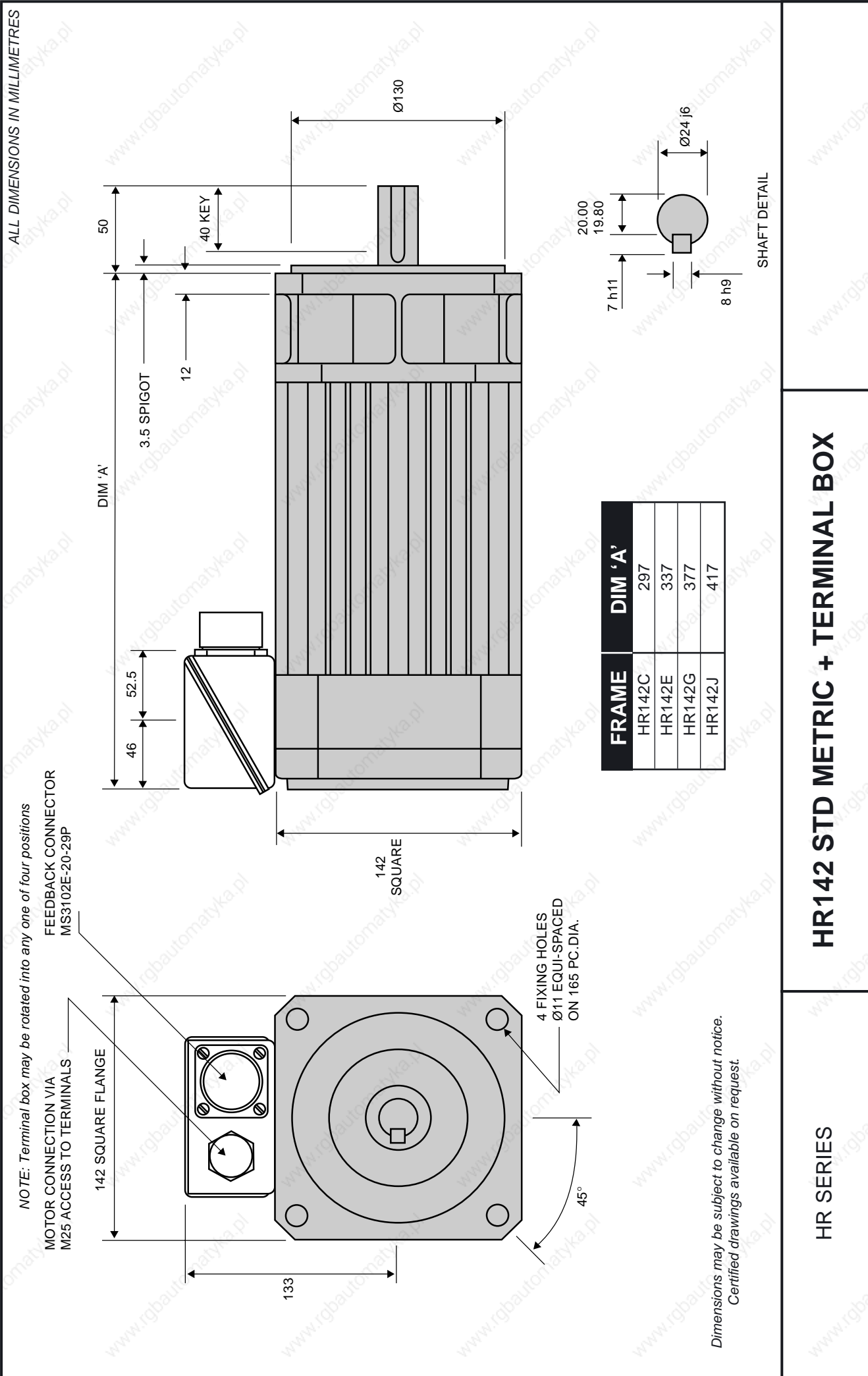

HR142 STD METRIC + TERMINAL BOX

HR SERIES

HR142 - OPTIONS (metric series)

11

Code	Description	Notes
WAVEFORM (WINDING)		
Y00*	Waveform.	Sinusoidal waveform.
FEEDBACK DEVICES		
F00*	Resolver (F00 setting).	2 Pole Resolver type 21-B with F00 setting.
F16	Resolver (F16 setting)	2 Pole Resolver type 21-B with alternative F16 setting.
F66	No Feedback fitted	
FITTED ENCODERS		
E15	Encoder	Heidenhain ERN1387 series, 2048ppr.
E22	Encoder, singleturn, Optical	Heidenhain ECN1313 series, 2048ppr with EnDat Interface.
E16	Encoder, multiturn, Optical	Heidenhain EQN1325 series, 2048ppr with EnDat Interface.
E33	Encoder, singleturn, Inductive	Heidhenhain ECI1319 series, 32ppr with EnDat Interface
E34	Encoder, multiturn, Inductive	Heidhenhain ECI1331 series, 32ppr with EnDat Interface
E20	Encoder, singleturn.	Stegmann SRS50 series with Hiperface Interface.
E21	Encoder, multiturn.	Stegmann SRM50 series with Hiperface Interface.
E26**	Incremental encoder	Renco R35i, 1000ppr
E28**	Incremental encoder	Renco R35i, 2048ppr
E29**	Incremental encoder	Renco R35i, 4000ppr
E31**	Incremental encoder	Renco R35i, 8192ppr
MECHANICAL INTERFACE		
M00*	Flange.	142 x 142 mm square flange. Spigot Ø 130mm. Fixing 4 x Ø 11 mm holes on 165 mm PCD.
R01	Close tolerance interface.	Flange & shaft to IEC72-P (precision).
S00*	Shaft.	Ø 24mm x 50mm long.
K00*	Keyway.	8 x 7 x 40 mm long.
K99	No Keyway.	Plain shaft.
D01*	Shaft end threaded hole.	M8 x 20mm deep.
BRAKES		
B00	24Vdc Brake.	18.0Nm Torque
B01	90Vdc Brake.	18.0Nm Torque
B02	24Vdc High Torque Brake.	40.0Nm Torque
B03	90Vdc High Torque Brake.	40.0Nm Torque
L01	Rectifier for B01 & B03	110Vac Input/90Vdc output for options B01 & B03 (mounted inside terminal box).
ELECTRICAL TERMINATIONS		
C47*	Motor & feedback connector.	Interconnectron motor receptacle (6 pin) and feedback receptacle (12 pin 20 degree offset) (for motors fitted with resolver). (Note that there are restrictions on the current for this power connector and this option is therefore not available for all motors).
C48	Motor & feedback connector.	Interconnectron motor receptacle (6 pin) and feedback receptacle (17 pin) (for motors fitted with encoder). (Note that there are restrictions on the current for this power connector and this option is therefore not available for all motors).
C71	Interconnectron motor & feedback connector.	Size 1.5 motor receptacle, 6 pin 12 pin feedback receptacle rotating type facing drive end (for use with resolver feedback).
C72	Interconnectron Motor & feedback connector.	Size 1.5 motor receptacle, 6 pin 17 pin feedback receptacle rotating type facing drive end (for use with encoder feedback).
C67	Motor plug	Straight plug & cable clamp for C47 and C48.
C73	Motor plug	Straight plug & cable clamp for C71 and C72.
C68	Feedback plug	Straight plug & cable clamp for C47 and C71.
C69	Feedback plug	Straight plug & cable clamp for C48 and C72.

* Standard feature

** Other line counts available on request

HR142 - OPTIONS (metric series)

11

ELECTRICAL TERMINATIONS (continued)

C00	Terminal Box	Terminal Box with 1 x M25 hole. Feedback MS receptacle (17 pin)
C01	motor & feedback connector	Motor receptacle (7 pin) feedback receptacle (17 pin)
C04	Feedback plug & cable	Straight plug and cable clamp for C00, C01
C08	Motor Plug & cable	Straight plug and cable clamp for C01

THERMAL PROTECTION

P21*	Thermal overload.	Bi-metal thermal switch.
P17	Thermal overload.	Temperature sensor, Phillips type KTY 84-130.
P18	No thermal overload.	Thermal protection not fitted.

ENCLOSURE PROTECTION

W00*	IP64/65 enclosure.	Nitrile shaft seal for IP64/65 protection (factory fitted).
W01	IP64/65 enclosure.	Viton shaft seal for IP64/65 protection (factory fitted).
W02	IP64/65 enclosure.	Nitrile shaft seal for IP64/65 protection (supplied loose).
W03	IP64/65 enclosure.	Viton shaft seal for IP64/65 protection (supplied loose).
W99	No Shaft Seal Fitted	

UL APPROVAL

U00	UL approved motor
-----	-------------------

* Standard feature

** Other line counts available on request

HRS142C6

HRS142E6

HRS142G6

HRS142J6

HRS142



HRS142C6 Brushless AC Servomotors

Technical Data

11A

Parameter	Units	HRS142C6-130S	HRS142C6-88S	HRS142C6-64S
GENERAL				
Voltage Gradient No Load	Line-Line Volts (Peak)/1000rpm	130	88	64
Max. Current (Peak)	A	35	52	72
Max. Motor EMF	Line-Line Volts	700	530	380
Max. Mechanical Speed Limit	rpm	5400	6000	6000
Continuous Stall Torque TENV (110K) ^ψ	Nm	11.3	11.3	11.3
	lb-in	100	100	100
(Size 300 x 300 x 12 mm)	Nm	12.1	12.1	12.1
Cont. Stall Torque when fitted to Heatsink (Size 12 x 12 x 0.5 in)	lb-in	107	107	107
Peak Stall Torque	Nm	30	30	30
	lb-in	270	270	270
Continuous Stall Current rms (110K) ^ψ	A	7.4	11	15
Rotor Polar Moment of Inertia (Inclusive of Resolver Inertia)	kgcm ² lb-in s ²	11.5 0.0102	11.5 0.0102	11.5 0.0102
Torque Constant 3 x K _{t_rms} * [†]	Nm/A lb-in/A	1.53 13.5	1.02 9	0.75 6.6
STATOR WINDING				
Resistance Line-Line*	Ω	1.7	0.76	0.38
Inductance Line-Line	mH	19	8.9	4.7
THERMAL				
Insulation Class		F	F	F
Max. Ambient Temperature	°C	40	40	40
	°F	104	104	104
Thermal Time Constant	minutes	50	50	50
Thermal Resistance	°C/W	0.54	0.54	0.54
	°F/W	0.97	0.97	0.97
MECHANICAL				
Static Friction Torque	Nm	0.12	0.12	0.12
	lb-in	1.06	1.06	1.06
Cogging Torque	Nm	0.24	0.24	0.24
	lb-in	2.1	2.1	2.1
Motor Weight	kg	12.8	12.8	12.8
	lb	28	28	28

Notes

- * - All data is subject to a tolerance of ±10% (except motor 'Voltage Gradient' and K_t which are to +15%/-5%).
- At 25°C.
- † - Note that K_t is shown as a combined value for all **three phases**.
- ψ - The temperature rise ΔT on the windings is 110K and applies to all continuous torque values. The maximum ambient temperature is 40°C and therefore the temperature on the windings should not be more than 150°C. A value higher than 150°C would exceed the class F insulation temperature specification.

DD0650 ISSUE 2

HRS142C6-S
on 250 VOLT

RPM

11A

11A

6000

5000

4000

3000

2000

1000

CONTINUOUS
RATING

INTERMITTENT
RATING

50

100

150

200

250

300

in. lbs

4

8

12

16

20

24

28

32

36

40

TORQUE Nm

64

88

130

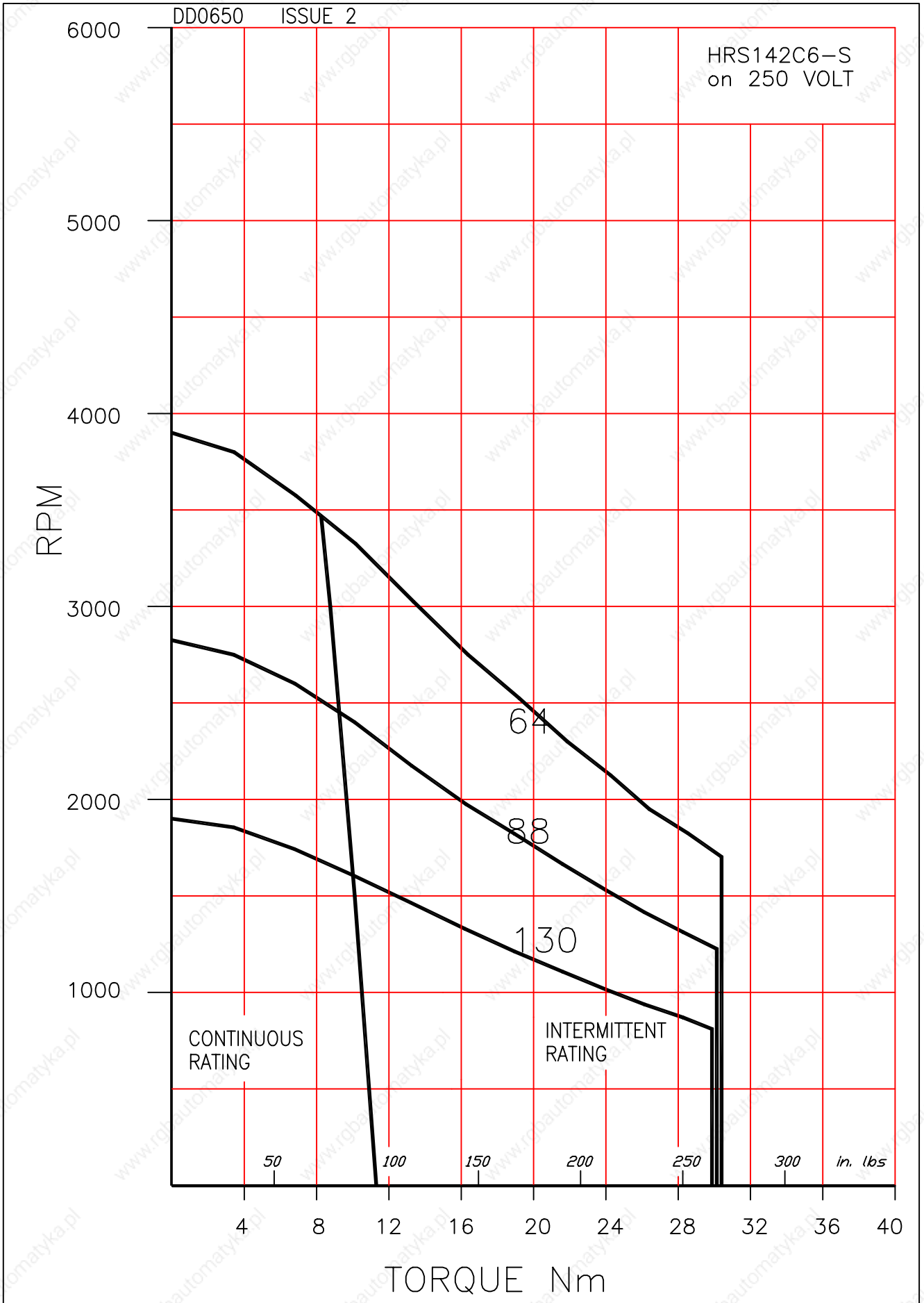

DD0654 ISSUE 2

HRS142C6-S
on 300 VOLT

RPM

11A

11A

6000

5000

4000

3000

2000

1000

CONTINUOUS
RATING

INTERMITTENT
RATING

50

100

150

200

250

300

in. lbs

4

8

12

16

20

24

28

32

36

40

TORQUE Nm

64

88

130

180

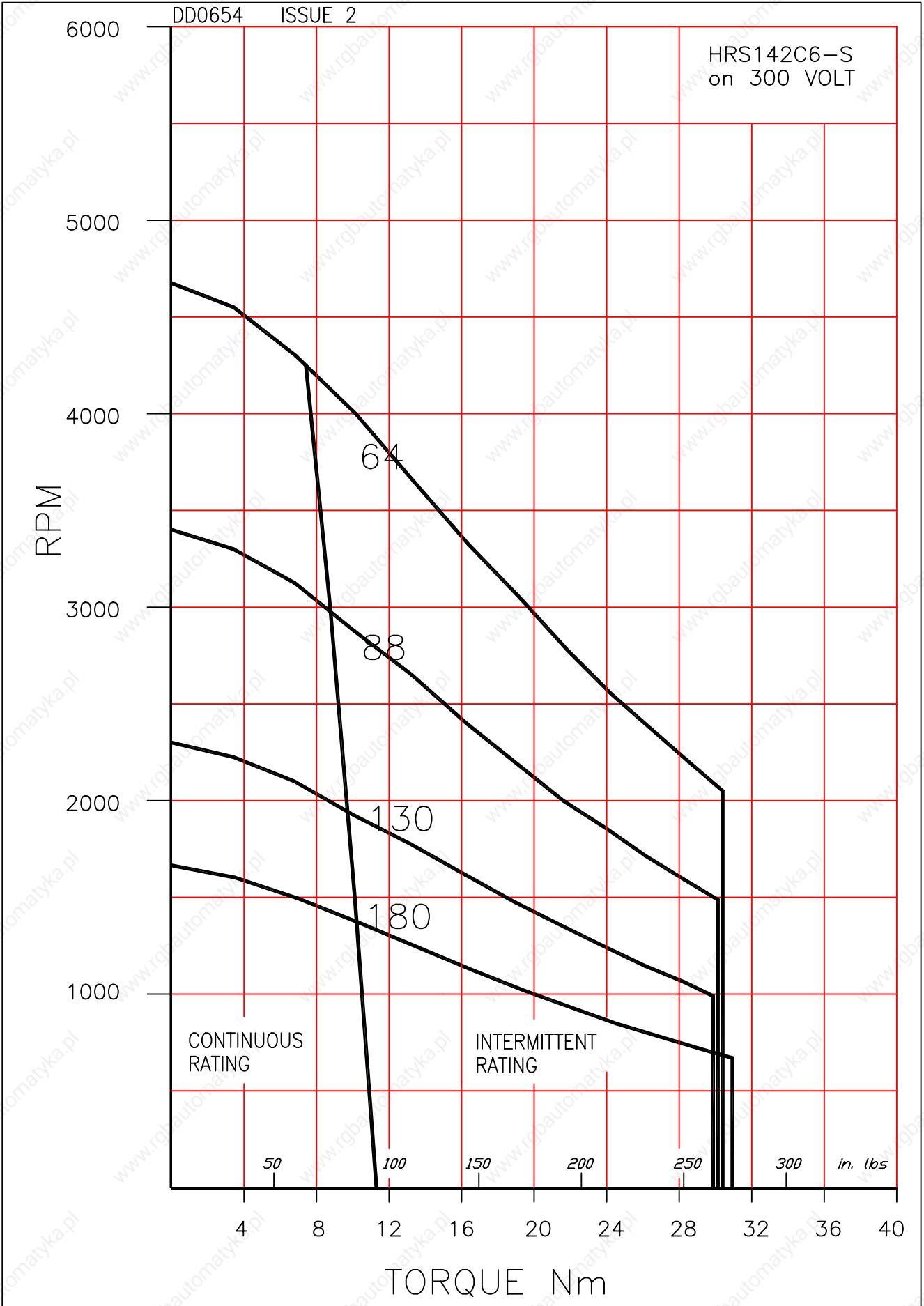

11A

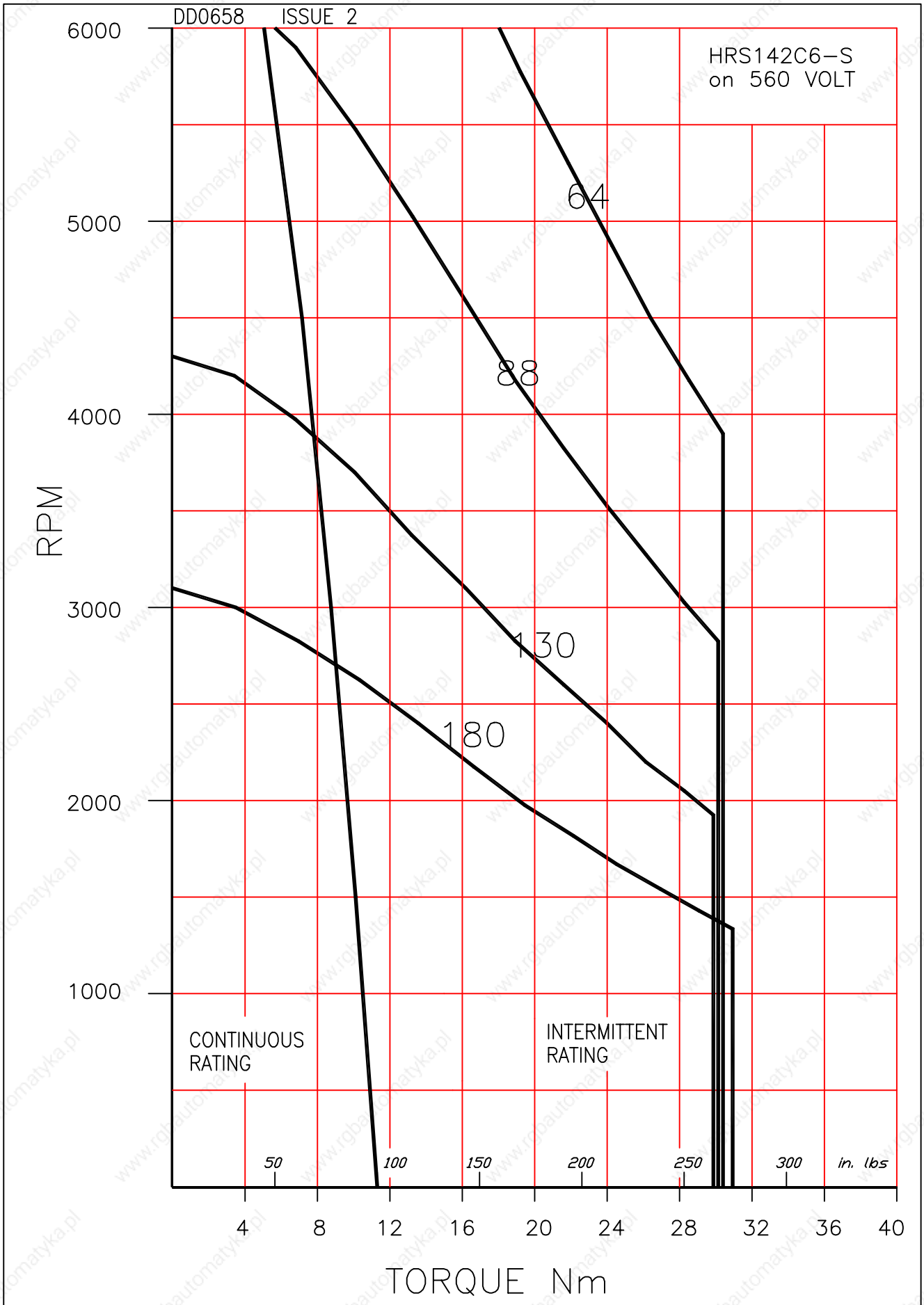

11A

11A

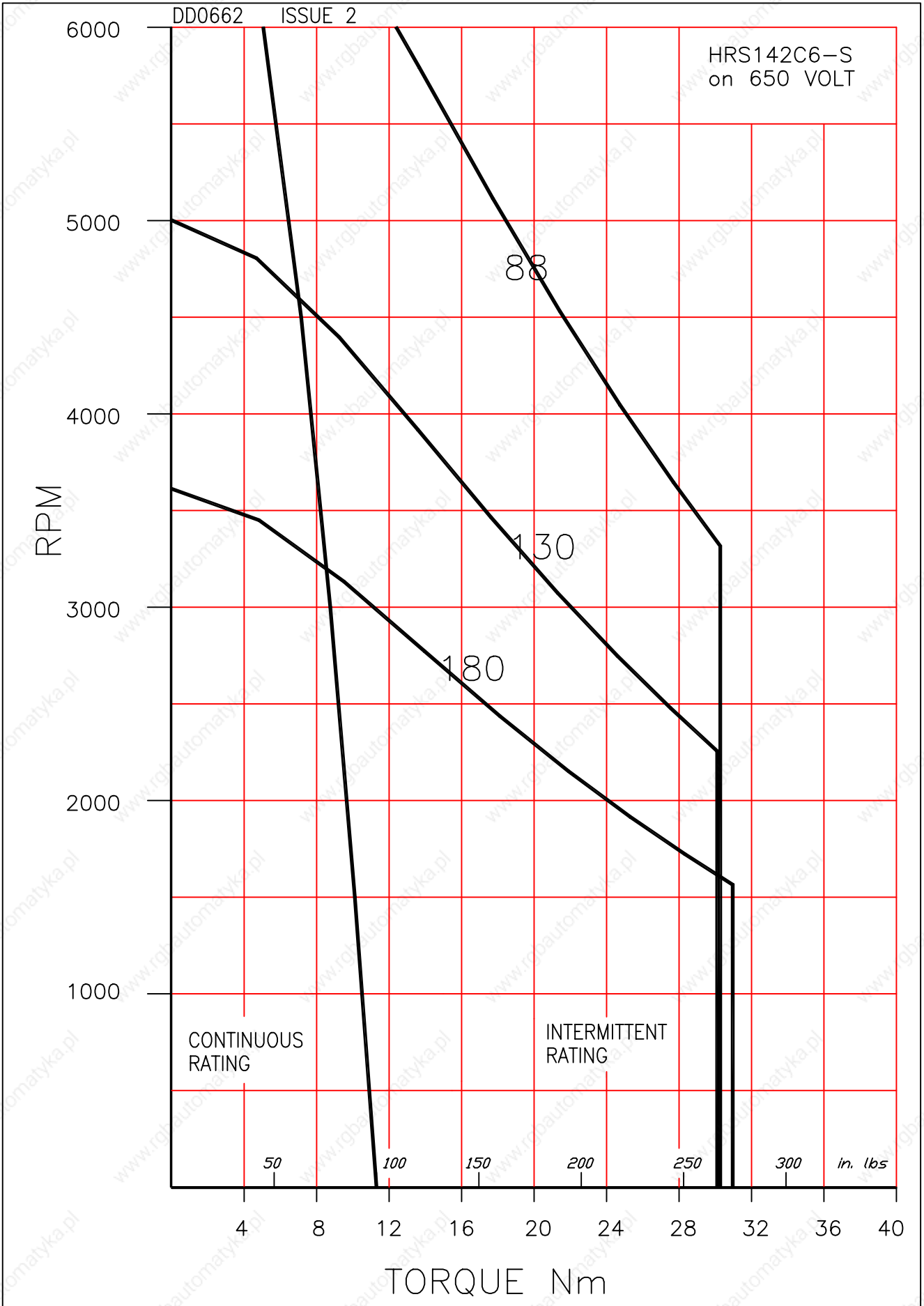

11A

HRS142E6 Brushless AC Servomotors

11A

Technical Data

Parameter	Units	HRS142E6-180S	HRS142E6-130S	HRS142E6-88S
GENERAL				
Voltage Gradient No Load	Line-Line Volts (Peak)/1000rpm	180	130	88
Max. Current (Peak)	A	39	54	78
Max. Motor EMF	Line-Line Volts	700	700	530
Max. Mechanical Speed Limit	rpm	3900	5400	6000
Continuous Stall Torque TENV (110K) ^ψ	Nm	16	16	16
	lb-in	140	140	140
(Size 300 x 300 x 12 mm)	Nm	17	17	17
Cont. Stall Torque when fitted to Heatsink (Size 12 x 12 x 0.5 in)	lb-in	150	150	150
Peak Stall Torque	Nm	45	45	45
	lb-in	400	400	400
Continuous Stall Current rms (110K) ^ψ	A	7.6	10.5	16
Rotor Polar Moment of Inertia (Inclusive of Resolver Inertia)	kgcm ² lb-in s ²	17 0.015	17 0.015	17 0.015
Torque Constant 3 x K _{t_rms} * [†]	Nm/A lb-in/A	2.1 19	1.53 13.5	1.02 9
STATOR WINDING				
Resistance Line-Line*	Ω	1.7	0.9	0.42
Inductance Line-Line	mH	22	11.8	5.3
THERMAL				
Insulation Class		F	F	F
Max. Ambient Temperature	°C	40	40	40
	°F	104	104	104
Thermal Time Constant	minutes	55	55	55
	°C/W	0.5	0.5	0.5
Thermal Resistance	°F/W	0.9	0.9	0.9
MECHANICAL				
Static Friction Torque	Nm	0.12	0.12	0.12
	lb-in	1.06	1.06	1.06
Cogging Torque	Nm	0.34	0.34	0.34
	lb-in	3	3	3
Motor Weight	kg	16	16	16
	lb	35	35	35

Notes

- * - All data is subject to a tolerance of ±10% (except motor 'Voltage Gradient' and K_t which are to +15%/-5%).
- At 25°C.
- † - Note that K_t is shown as a combined value for all **three phases**.
- ψ - The temperature rise ΔT on the windings is 110K and applies to all continuous torque values. The maximum ambient temperature is 40°C and therefore the temperature on the windings should not be more than 150°C. A value higher than 150°C would exceed the class F insulation temperature specification.

DD0651 ISSUE 2

HRS142E6-S
on 250 VOLT

RPM

11A

11A

6000

5000

4000

3000

2000

1000

CONTINUOUS
RATING

INTERMITTENT
RATING

100

200

300

400

in. lbs
500

10

20

30

40

50

60

TORQUE Nm

88

130

180

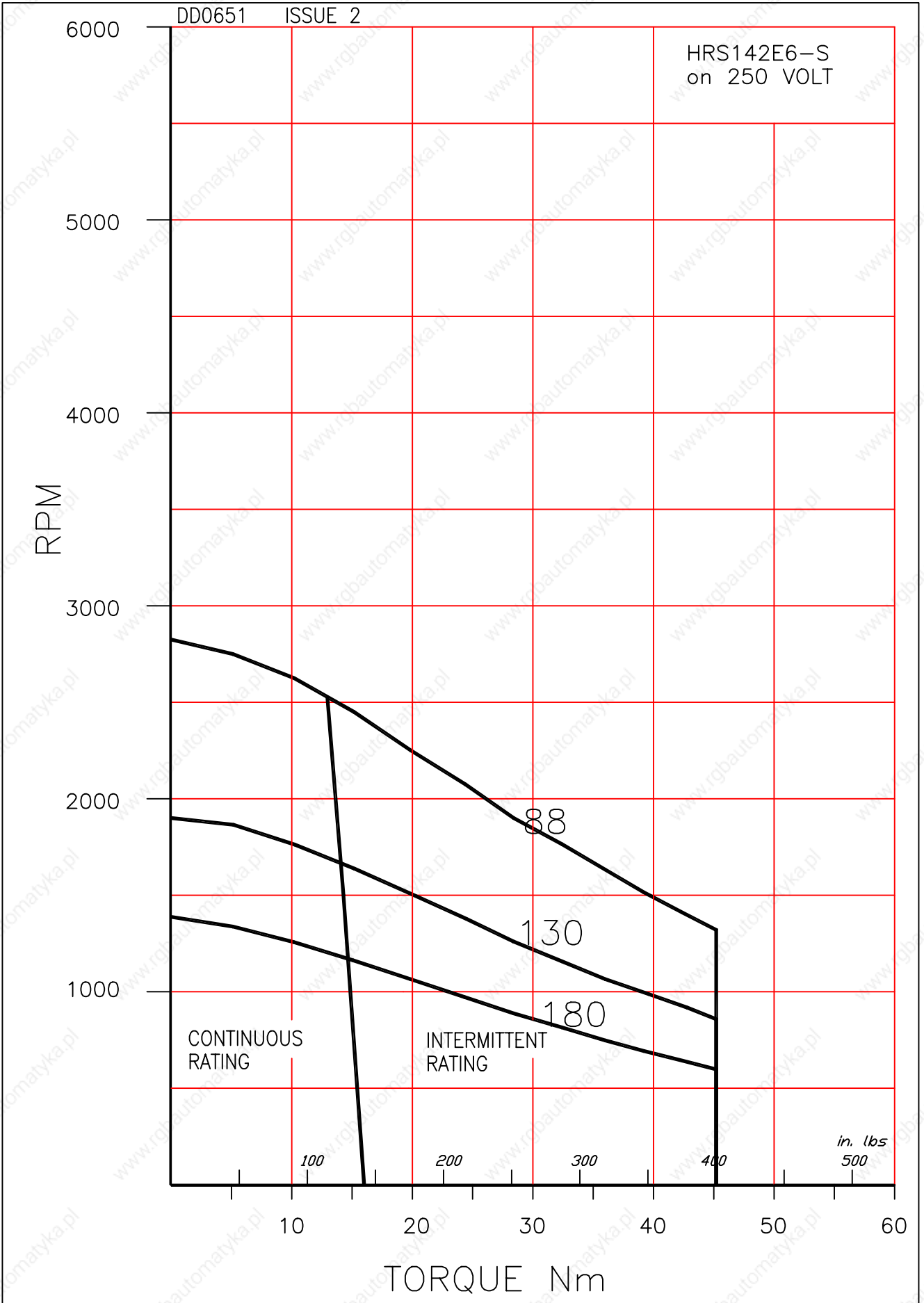

DD0655 ISSUE 2

HRS142E6-S
on 300 VOLT

RPM

11A

11A

6000

5000

4000

3000

2000

1000

CONTINUOUS
RATING

INTERMITTENT
RATING

100

200

300

400

in. lbs
500

10

20

30

40

50

60

TORQUE Nm

38

130

180

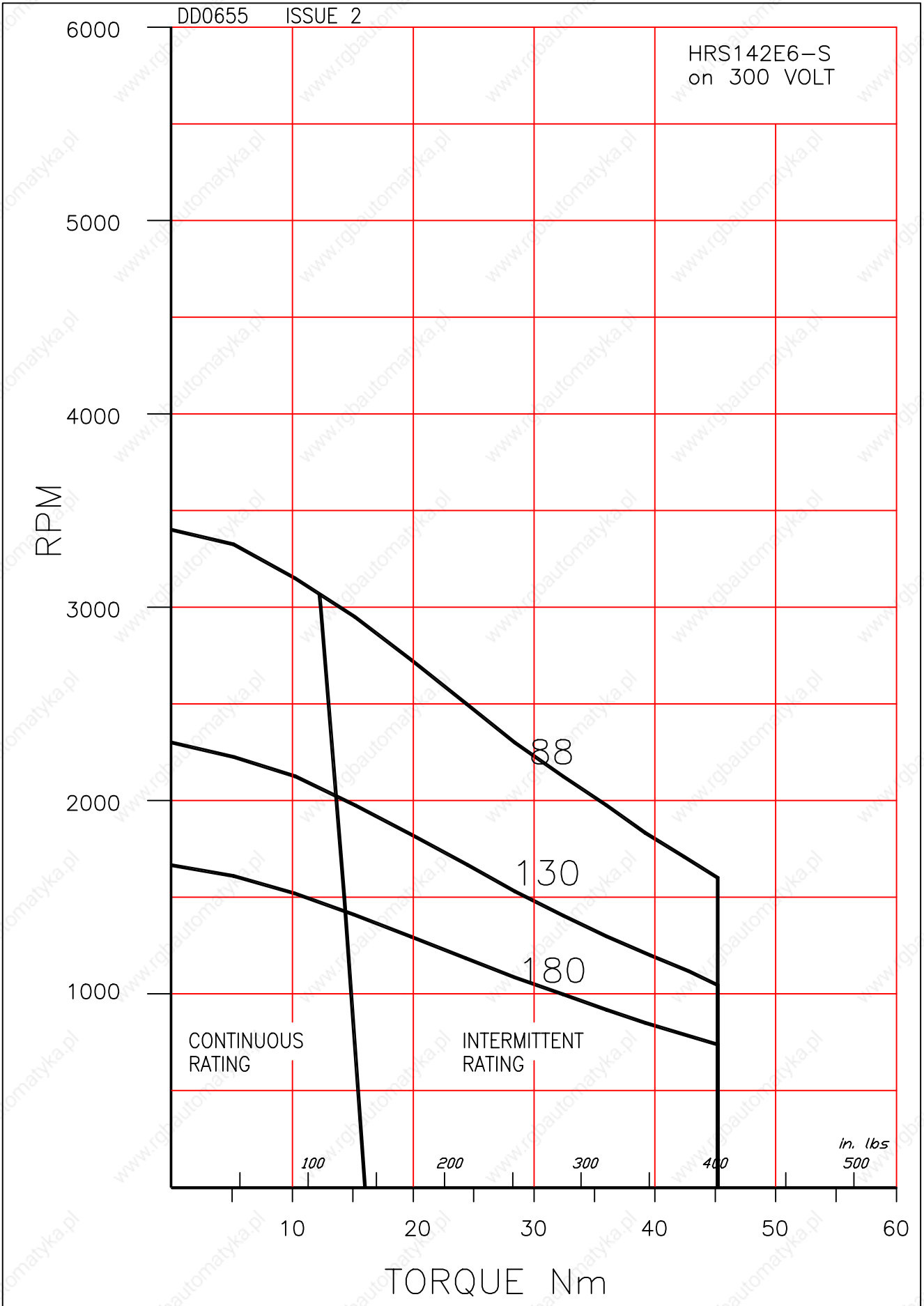

DD0659

ISSUE 2

HRS142E6-S
on 560 VOLT

RPM

11A

11A

6000
5000
4000
3000
2000
1000

CONTINUOUS
RATING

INTERMITTENT
RATING

100 200 300 400 *in. lbs* 500

TORQUE Nm

88

130

180

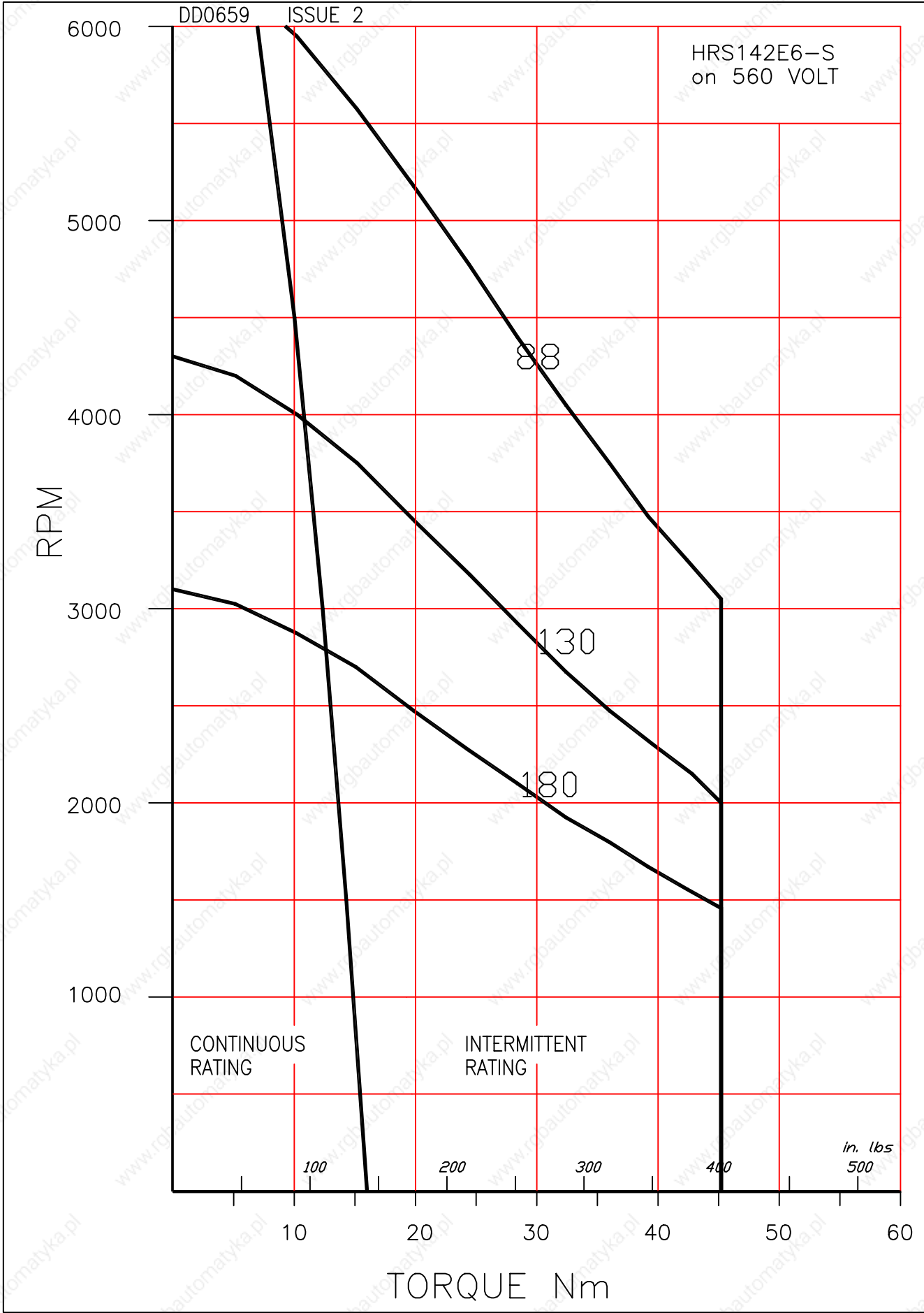

HRS142G6 Brushless AC Servomotors

Technical Data

11A

Parameter	Units	HRS142G6-260S	HRS142G6-180S	HRS142G6-130S
GENERAL				
Voltage Gradient No Load	Line-Line Volts (Peak)/1000rpm	260	180	130
Max. Current (Peak)	A	35	50	70
Max. Motor EMF	Line-Line Volts	700	700	700
Max. Mechanical Speed Limit	rpm	2700	3900	5400
Continuous Stall Torque TENV (110K) ^ψ	Nm	21	21	21
	lb-in	190	190	190
(Size 300 x 300 x 12 mm)	Nm	22	22	22
Cont. Stall Torque when fitted to Heatsink (Size 12 x 12 x 0.5 in)	lb-in	190	190	190
Peak Stall Torque	Nm	60	60	60
	lb-in	530	530	530
Continuous Stall Current rms (110K) ^ψ	A	6.9	10	13.8
Rotor Polar Moment of Inertia (Inclusive of Resolver Inertia)	kgcm ² lb-in s ²	22 0.019	22 0.019	22 0.019
Torque Constant 3 x K _{t_rms} * [†]	Nm/A lb-in/A	3.03 27	2.1 19	1.53 13.5
STATOR WINDING				
Resistance Line-Line*	Ω	2.4	1.12	0.6
Inductance Line-Line	mH	34	16	8.4
THERMAL				
Insulation Class		F	F	F
Max. Ambient Temperature	°C	40	40	40
	°F	104	104	104
Thermal Time Constant	minutes	60	60	60
	°C/W	0.43	0.43	0.43
Thermal Resistance	°F/W	0.77	0.77	0.77
MECHANICAL				
Static Friction Torque	Nm	0.12	0.12	0.12
	lb-in	1.06	1.06	1.06
Cogging Torque	Nm	0.43	0.43	0.43
	lb-in	3.8	3.8	3.8
Motor Weight	kg	20	20	20
	lb	44	44	44

Notes

- * - All data is subject to a tolerance of ±10% (except motor 'Voltage Gradient' and K_t which are to +15%/-5%).
- At 25°C.
- † - Note that K_t is shown as a combined value for all **three phases**.
- ψ - The temperature rise ΔT on the windings is 110K and applies to all continuous torque values. The maximum ambient temperature is 40°C and therefore the temperature on the windings should not be more than 150°C. A value higher than 150°C would exceed the class F insulation temperature specification.

DD0652 ISSUE 2

HRS142G6-S
on 250 VOLT

RPM

11A

11A

6000

5000

4000

3000

2000

1000

CONTINUOUS
RATING

INTERMITTENT
RATING

130

180

100

200

300

400

500

600

700

in. lbs
800

20

40

60

80

100

TORQUE Nm

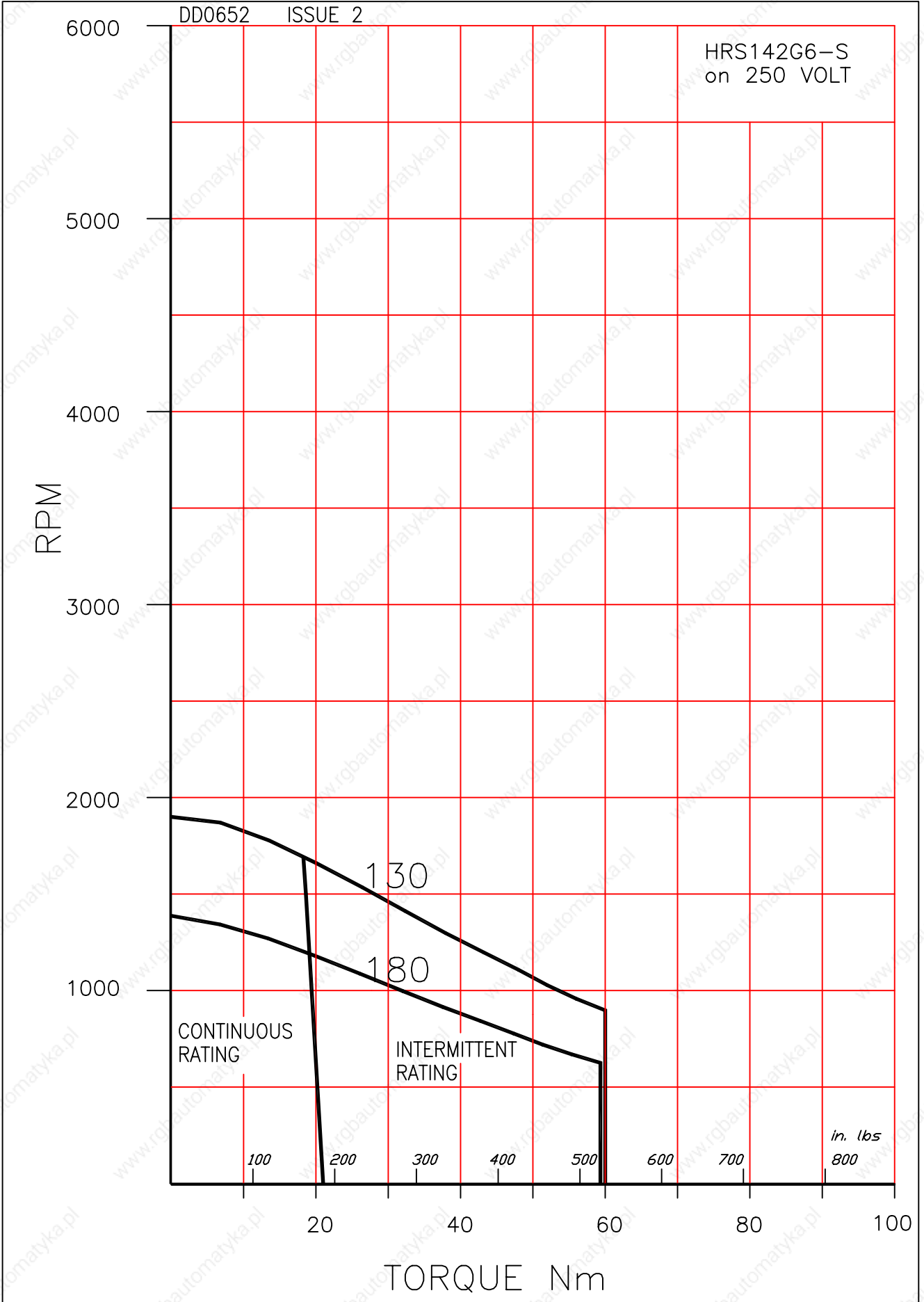

DD0656 ISSUE 2

HRS142G6-S
on 300 VOLT

RPM

11A

11A

6000

5000

4000

3000

2000

1000

CONTINUOUS
RATING

INTERMITTENT
RATING

130

180

100

200

300

400

500

600

700

in. lbs
800

20

40

60

80

100

TORQUE Nm

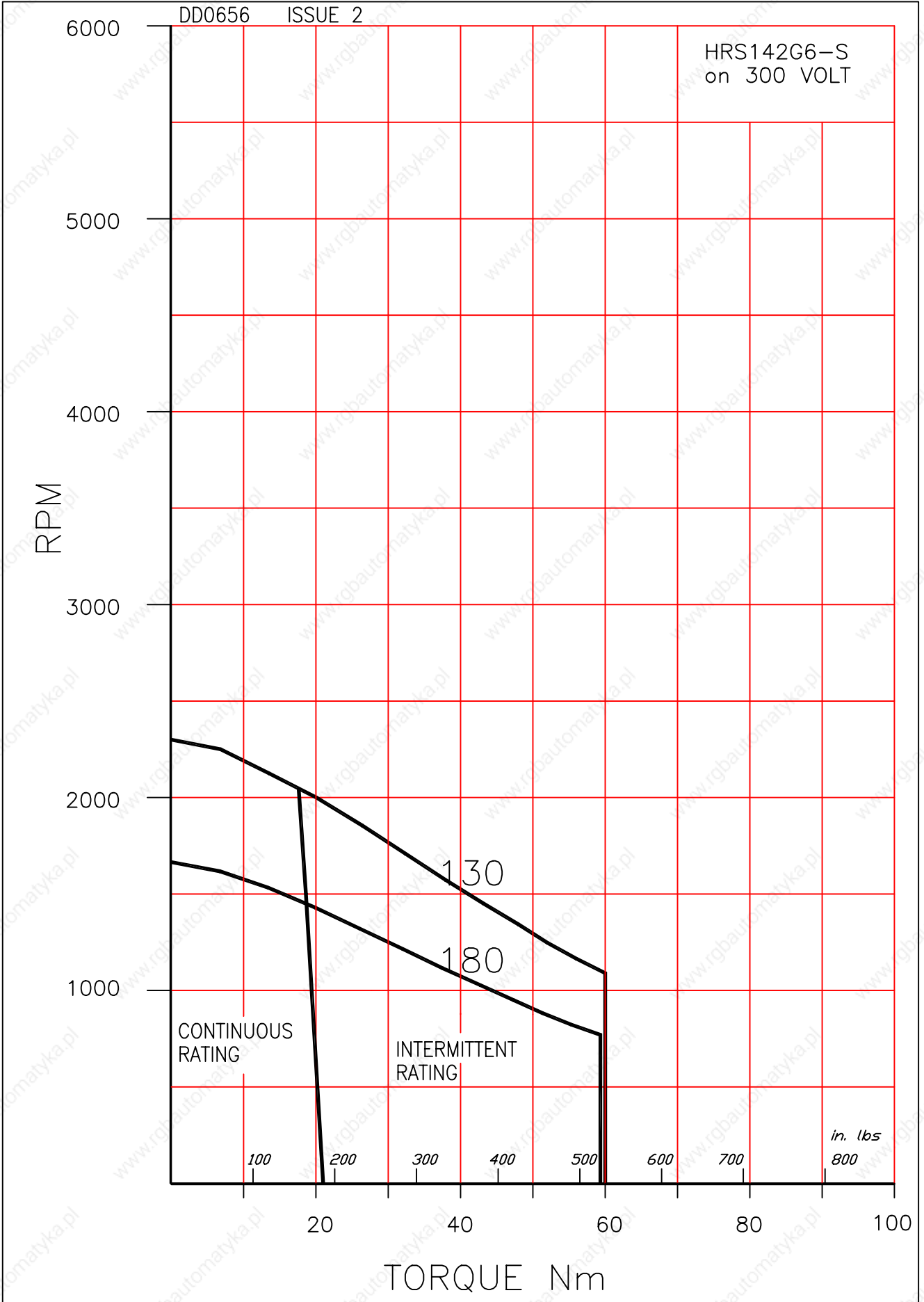

DD0660 ISSUE 2

HRS142G6-S
on 560 VOLT

RPM

11A

11A

6000

5000

4000

3000

2000

1000

CONTINUOUS
RATING

INTERMITTENT
RATING

100

200

300

400

500

600

700

in. lbs
800

20

40

60

80

100

TORQUE Nm

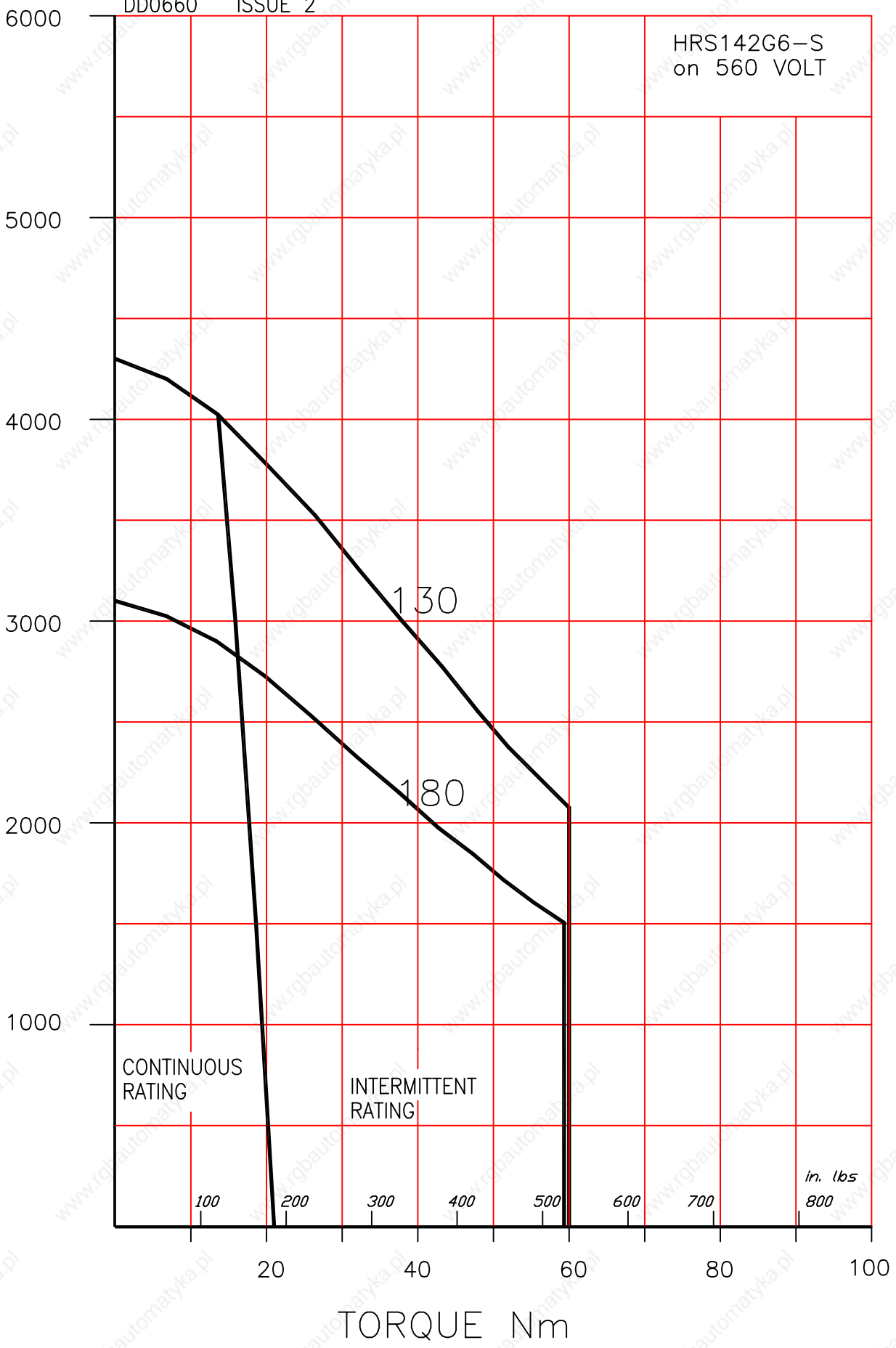

DD0664 ISSUE 2

HRS142G6-S
on 650 VOLT

RPM

11A

11A

6000

5000

4000

3000

2000

1000

CONTINUOUS
RATING

INTERMITTENT
RATING

100

200

300

400

500

600

700

in. lbs
800

20

40

60

80

100

TORQUE Nm

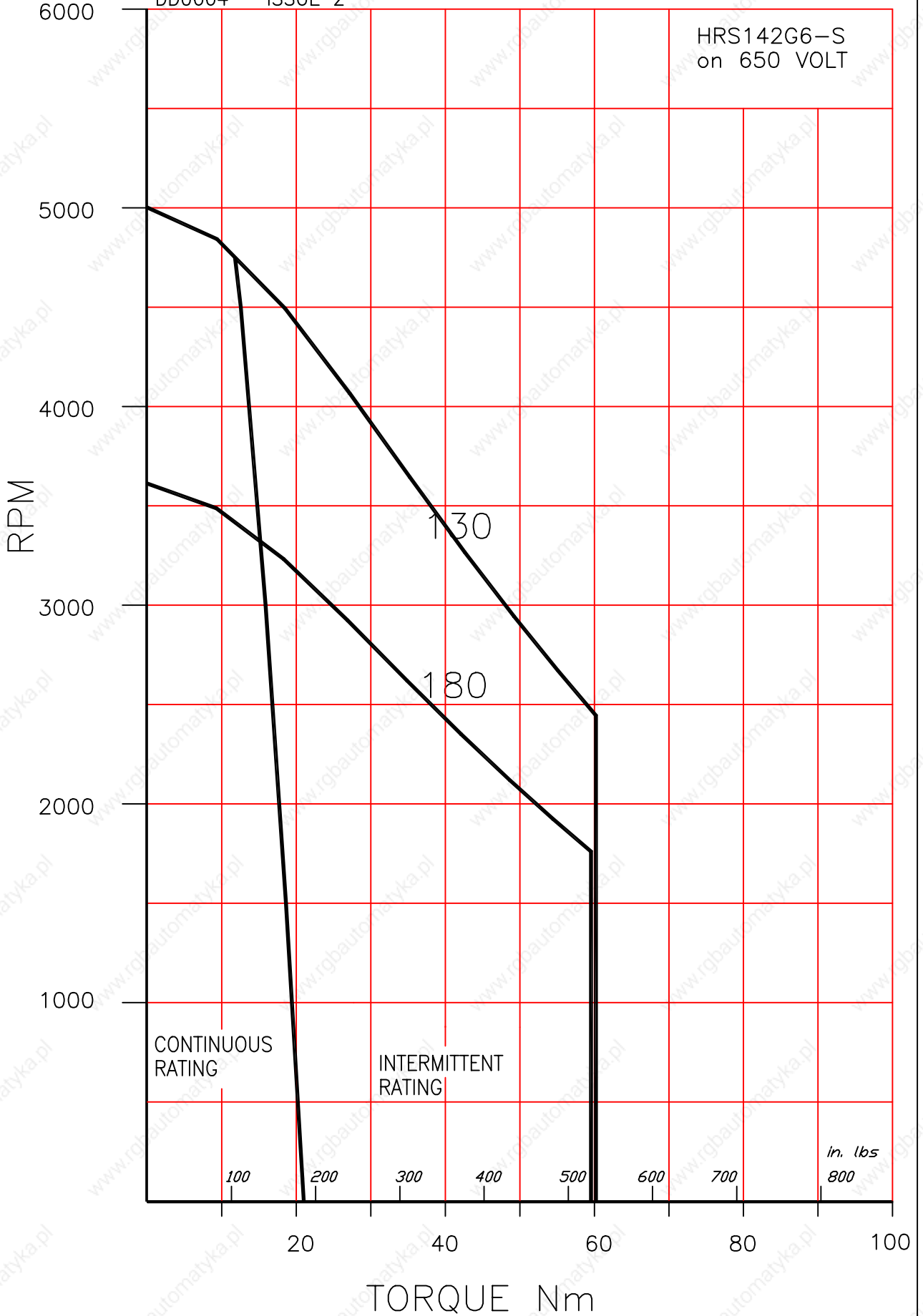

HRS142J6

Brushless AC Servomotors

11A

Technical Data

Parameter	Units	HRS142J6-260S	HRS142J6-180S	HRS142J6-130S
GENERAL				
Voltage Gradient No Load	Line-Line Volts (Peak)/1000rpm	260	180	130
Max. Current (Peak)	A	44	64	89
Max. Motor EMF	Line-Line Volts	700	700	700
Max. Mechanical Speed Limit	rpm	2700	3900	5400
Continuous Stall Torque TENV (110K) ^ψ	Nm	25	25	25
	lb-in	220	220	220
(Size 300 x 300 x 12 mm)	Nm	26	26	26
Cont. Stall Torque when fitted to Heatsink (Size 12 x 12 x 0.5 in)	lb-in	230	230	230
Peak Stall Torque	Nm	76	76	76
	lb-in	670	670	670
Continuous Stall Current rms (110K) ^ψ	A	8.2	11.9	16
Rotor Polar Moment of Inertia (Inclusive of Resolver Inertia)	kgcm ² lb-in s ²	27 0.024	27 0.024	27 0.024
Torque Constant 3 x K _{t_rms} *†	Nm/A lb-in/A	3.03 27	2.1 19	1.53 13.5
STATOR WINDING				
Resistance Line-Line*	Ω	1.8	0.88	0.43
Inductance Line-Line	mH	25	12.3	6.3
THERMAL				
Insulation Class		F	F	F
Max. Ambient Temperature	°C °F	40 104	40 104	40 104
Thermal Time Constant	minutes	65	65	65
Thermal Resistance	°C/W °F/W	0.42 0.76	0.42 0.76	0.42 0.76
MECHANICAL				
Static Friction Torque	Nm lb-in	0.12 1.06	0.12 1.06	0.12 1.06
Cogging Torque	Nm lb-in	0.52 4.6	0.52 4.6	0.52 4.6
Motor Weight	kg lb	24 53	24 53	24 53

Notes

- * - All data is subject to a tolerance of ±10% (except motor 'Voltage Gradient' and K_t which are to +15%/-5%).
- At 25°C.
- † - Note that K_t is shown as a combined value for all **three phases**.
- ψ - The temperature rise ΔT on the windings is 110K and applies to all continuous torque values. The maximum ambient temperature is 40°C and therefore the temperature on the windings should not be more than 150°C. A value higher than 150°C would exceed the class F insulation temperature specification.

DD0653 ISSUE 2

HRS142J6-S
on 250 VOLT

RPM

11A

11A

6000

5000

4000

3000

2000

1000

CONTINUOUS
RATING

INTERMITTENT
RATING

130

180

100

200

300

400

500

600

700

in. lbs
800

20

40

60

80

100

TORQUE Nm

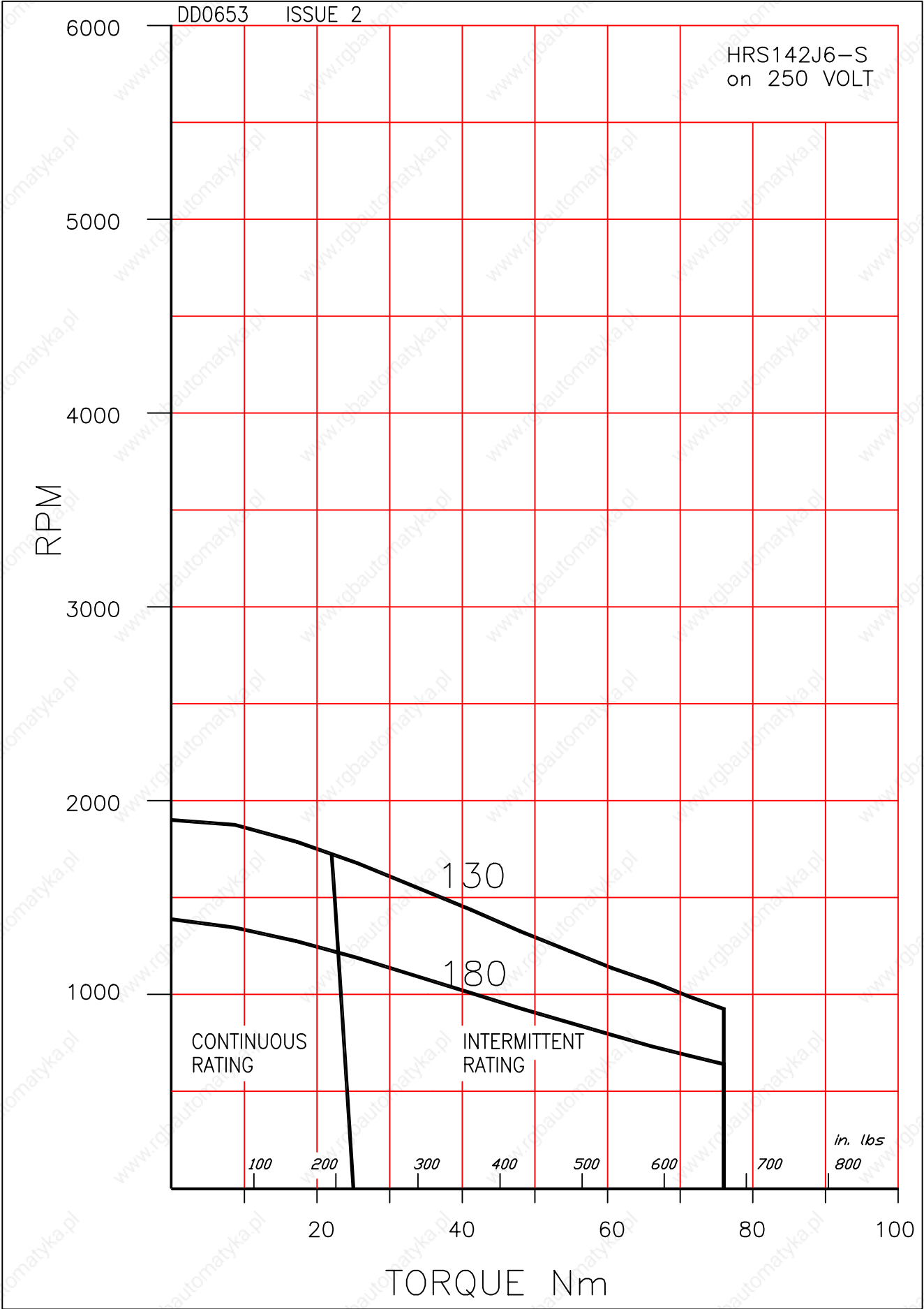

DD0657 ISSUE 2

HRS142J6-S
on 300 VOLT

RPM

11A

11A

6000

5000

4000

3000

2000

1000

CONTINUOUS
RATING

INTERMITTENT
RATING

130

180

100

200

300

400

500

600

700

in. lbs
800

20

40

60

80

100

TORQUE Nm

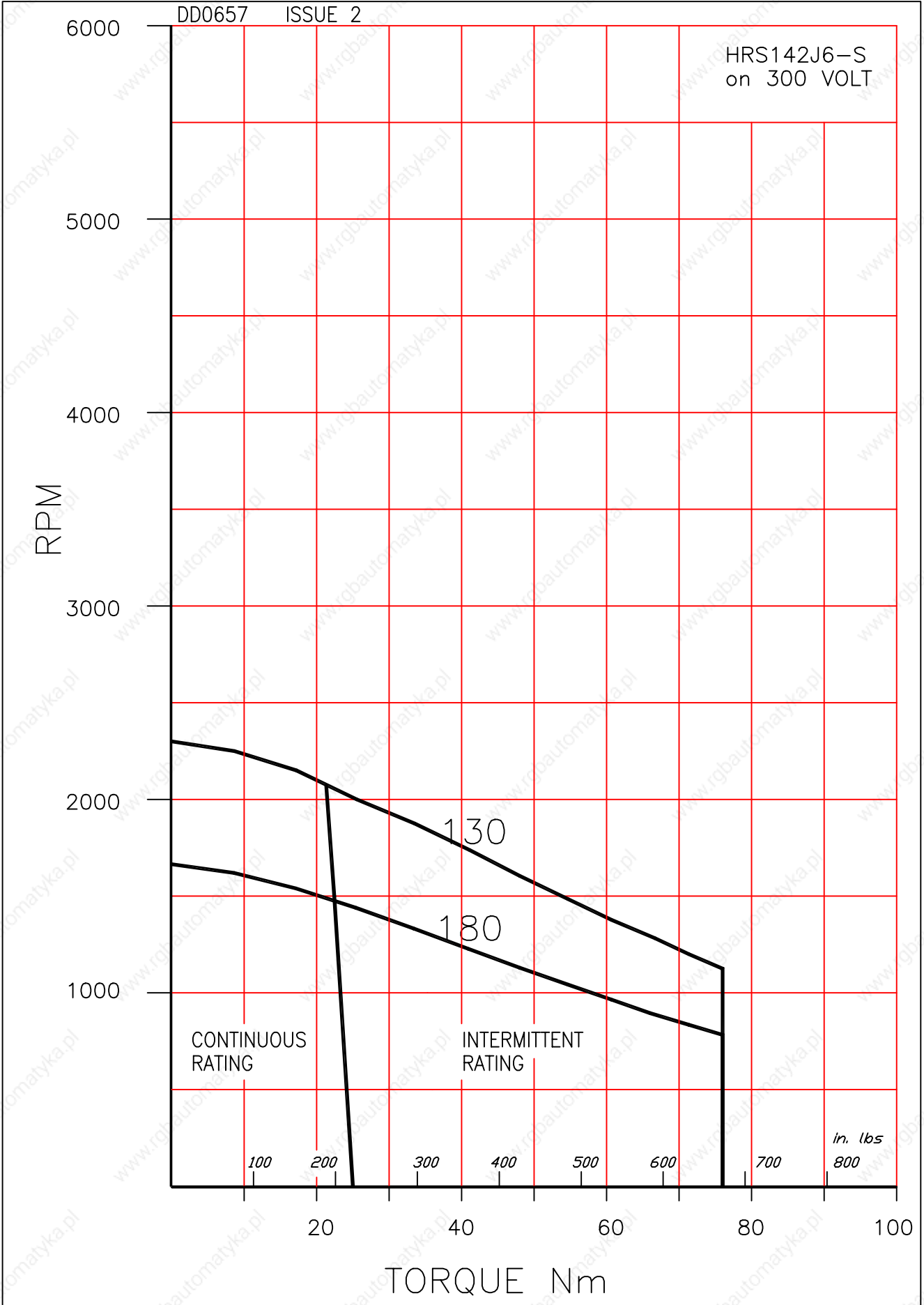

DD0661 ISSUE 2

HRS142J6-S
on 560 VOLT

RPM

11A

11A

6000

5000

4000

3000

2000

1000

CONTINUOUS
RATING

INTERMITTENT
RATING

100

200

300

400

500

600

700

in. lbs
800

20

40

60

80

100

TORQUE Nm

130

180

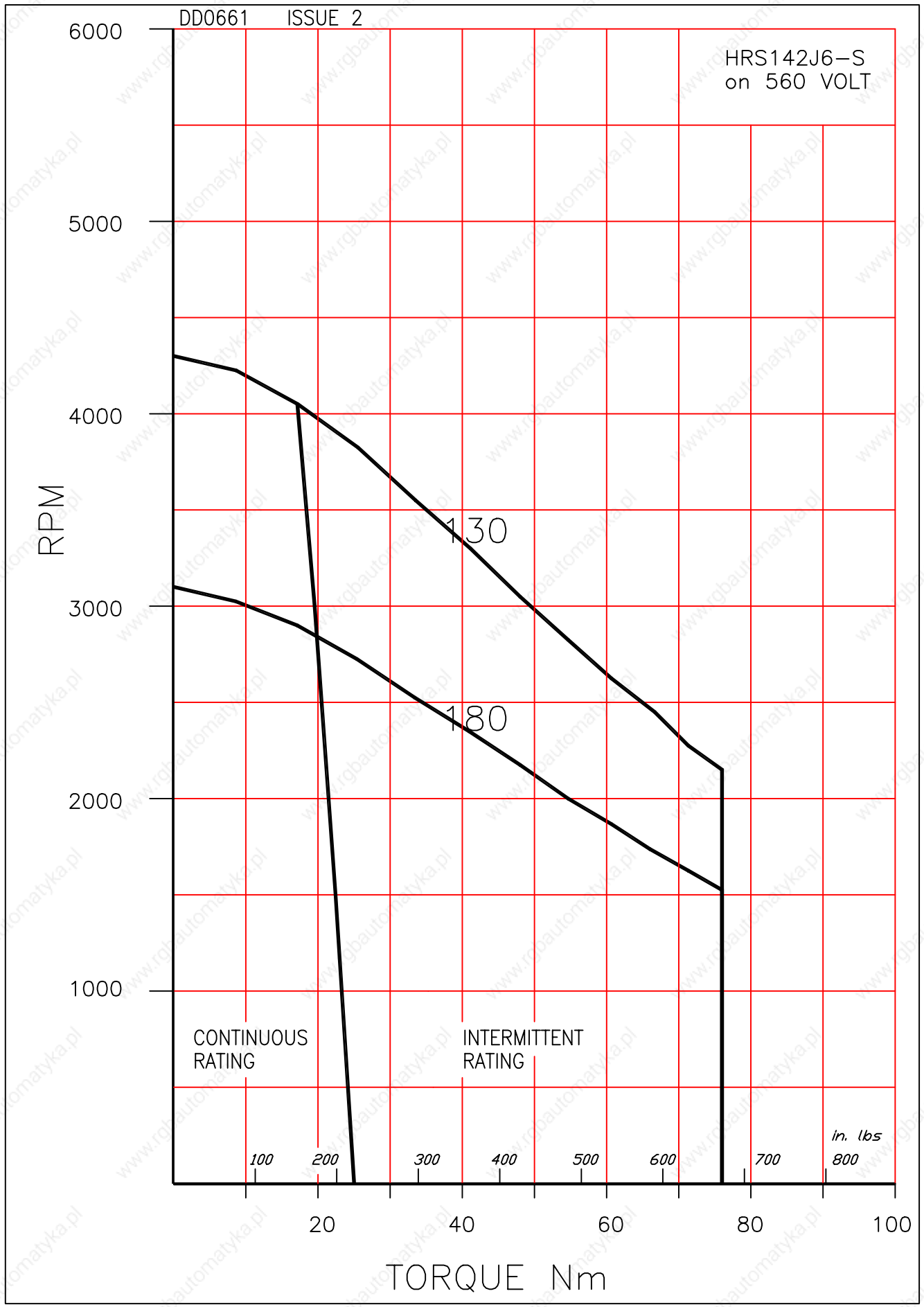

DD0665 ISSUE 2

HRS142J6-S
on 650 VOLT

RPM

11A

11A

6000

5000

4000

3000

2000

1000

CONTINUOUS
RATING

INTERMITTENT
RATING

100

200

300

400

500

600

700

in. lbs
800

20

40

60

80

100

TORQUE Nm

130

180

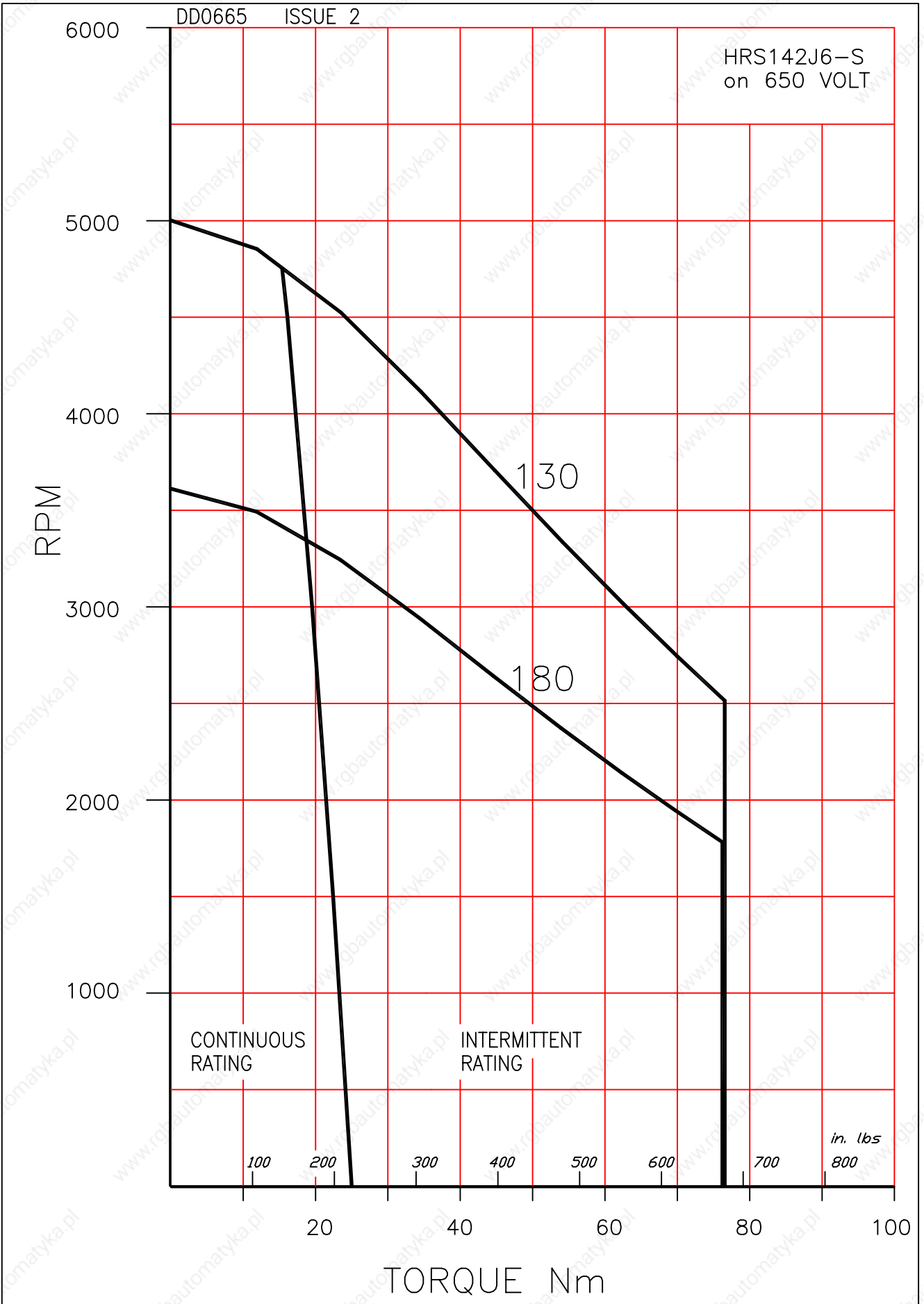

FIRST ANGLE PROJECTION

MOTOR CONNECTOR: - INTERCONNECTOR SIZE 1, 6 PIN
 FEEDBACK CONNECTOR: - RESOLVER - INTERCONNECTOR SIZE 1, 12 PIN
 FEEDBACK CONNECTOR: - ENCODER - INTERCONNECTOR SIZE 1, 17 PIN

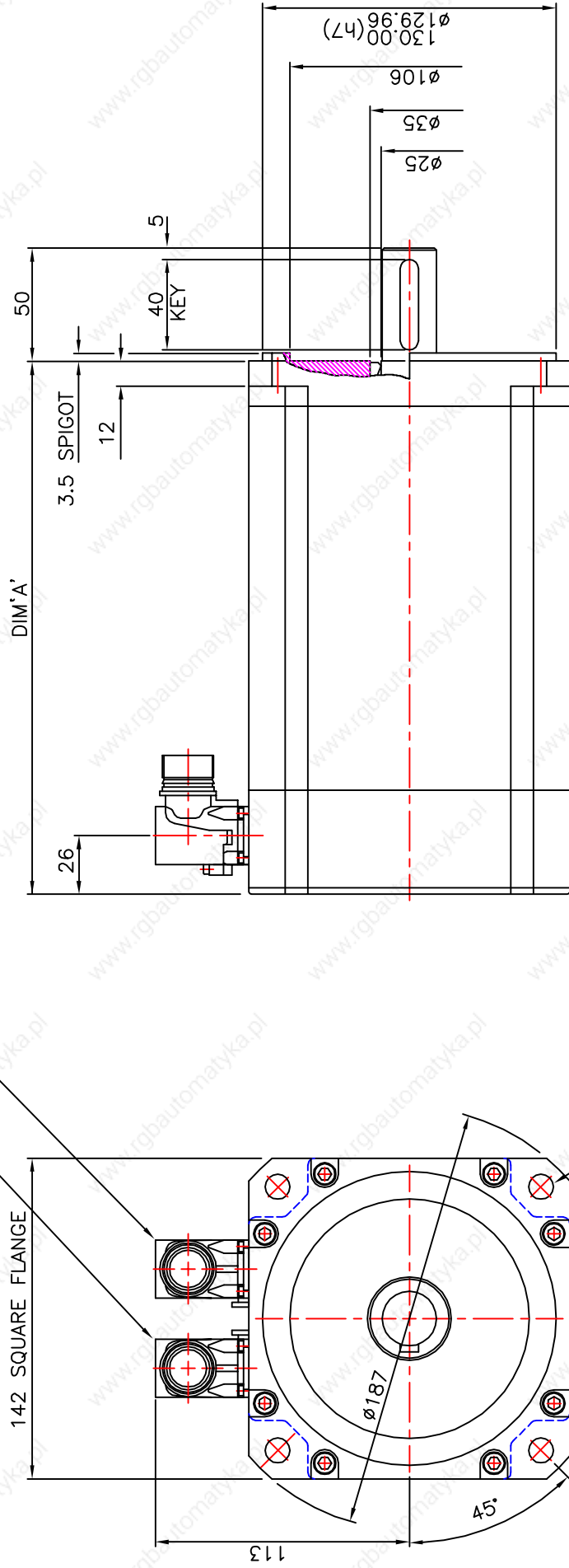

4 FIXING HOLES $\phi 11$ EQUI-SPACED ON 165 PCD

FRAME	NO BRAKE	WITH BRAKE
142C	236	276
142E	276	316
142G	316	356
142J	361	401

SHAFT DETAIL (x1)

SEE SHEET 1 FOR SIZE 1.5 POWER VERSION

5 24OCT06 MR3877 NOW SHOWS RESOLVER & ENCODER OPTIONS.		TITLE : OUTLINE HRS142 STD METRIC - WITH SIZE 1 POWER + SIZE 1 FEEDBACK CONNECTORS	
MATERIAL	CODE	MATERIAL	CODE
SPEC	FORM	SPEC	FORM
FINISH	PATTERN No.	FINISH	PATTERN No.

DRAWING NO.	SHT 2 OF 2	SCALE	1:2
664-7-06348		ISSUE No.	5
		DR.	SIH
		DATE	24JUN03
			A06348DE



ALL DIMENSIONS IN MILLIMETRES
 TOLERANCES UNLESS ANG: $\pm 0.5^\circ$
 OTHERWISE STATED DIM: $\pm 0.25\text{mm}$

HRS142 - OPTIONS (metric series)

11A

Code	Description	Notes
WAVEFORM (WINDING)		
Y00*	Waveform.	Sinusoidal waveform.
FEEDBACK DEVICES		
F00*	Resolver (F00 setting).	2 Pole Resolver type 21-B with F00 setting.
F16	Resolver (F16 setting)	2 Pole Resolver type 21-B with alternative F16 setting.
F66	No Feedback fitted	
FITTED ENCODERS		
E15	Encoder	Heidenhain ERN1387 series, 2048ppr.
E22	Encoder, singleturn, Optical	Heidenhain ECN1313 series, 2048ppr with EnDat Interface.
E16	Encoder, multiturn, Optical	Heidenhain EQN1325 series, 2048ppr with EnDat Interface.
E33	Encoder, singleturn, Inductive	Heidenhain ECI1319 series, 32ppr with EnDat Interface
E34	Encoder, multiturn, Inductive	Heidenhain ECI1331 series, 32ppr with EnDat Interface
E20	Encoder, singleturn.	Stegmann SRS50 series with Hiperface Interface.
E21	Encoder, multiturn.	Stegmann SRM50 series with Hiperface Interface.
E26**	Incremental encoder	Renco R35i, 1000ppr
E28**	Incremental encoder	Renco R35i, 2048ppr
E29**	Incremental encoder	Renco R35i, 4000ppr
E31**	Incremental encoder	Renco R35i, 8192ppr
MECHANICAL INTERFACE		
M00*	Flange.	142 x 142 mm square flange. Spigot Ø 130mm. Fixing 4 x Ø 11 mm holes on 165 mm PCD.
R01	Close tolerance interface.	Flange & shaft to IEC72-P (precision).
S00*	Shaft.	Ø 24mm x 50mm long.
K00*	Keyway.	8 x 7 x 40 mm long.
K99	No Keyway.	Plain shaft.
D01*	Shaft end threaded hole.	M8 x 20mm deep.
BRAKES		
B00	24Vdc Brake.	18.0Nm Torque
B01	90Vdc Brake.	18.0Nm Torque
B02	24Vdc High Torque Brake.	40.0Nm Torque
B03	90Vdc High Torque Brake.	40.0Nm Torque
ELECTRICAL TERMINATIONS		
C47*	Motor & feedback connector.	Interconnectron motor receptacle (6 pin) and feedback receptacle (12 pin 20 degree offset) (for motors fitted with resolver).
C48	Motor & feedback connector.	Interconnectron motor receptacle (6 pin) and feedback receptacle (17 pin) (for motors fitted with encoder).
C71	Interconnectron motor & feedback connector.	Size 1.5 motor receptacle, 6 pin 12 pin feedback receptacle rotating type facing drive end (for use with resolver feedback).
C72	Interconnectron Motor & feedback connector.	Size 1.5 motor receptacle, 6 pin 17 pin feedback receptacle rotating type facing drive end (for use with encoder feedback).
C67	Motor plug	Straight plug & cable clamp for C47 and C48.
C73	Motor plug	Straight plug & cable clamp for C71 and C72.
C68	Feedback plug	Straight plug & cable clamp for C47 and C71.
THERMAL PROTECTION		
P21*	Thermal overload.	Bi-metal thermal switch.
P17	Thermal overload.	Temperature sensor, Phillips type KTY 84-130.
P18	No thermal overload.	Thermal protection not fitted.
ENCLOSURE PROTECTION		
W00*	IP64/65 enclosure.	Nitrile shaft seal for IP64/65 protection (factory fitted).
W01	IP64/65 enclosure.	Viton shaft seal for IP64/65 protection (factory fitted).
W02	IP64/65 enclosure.	Nitrile shaft seal for IP64/65 protection (supplied loose).
W03	IP64/65 enclosure.	Viton shaft seal for IP64/65 protection (supplied loose).
W99	No Shaft Seal Fitted	
UL APPROVAL		
U00	UL approved motor	

* Standard feature

** Other line counts available on request

HR190C8

HR190E8

HR190G8

HR190J8

HR190

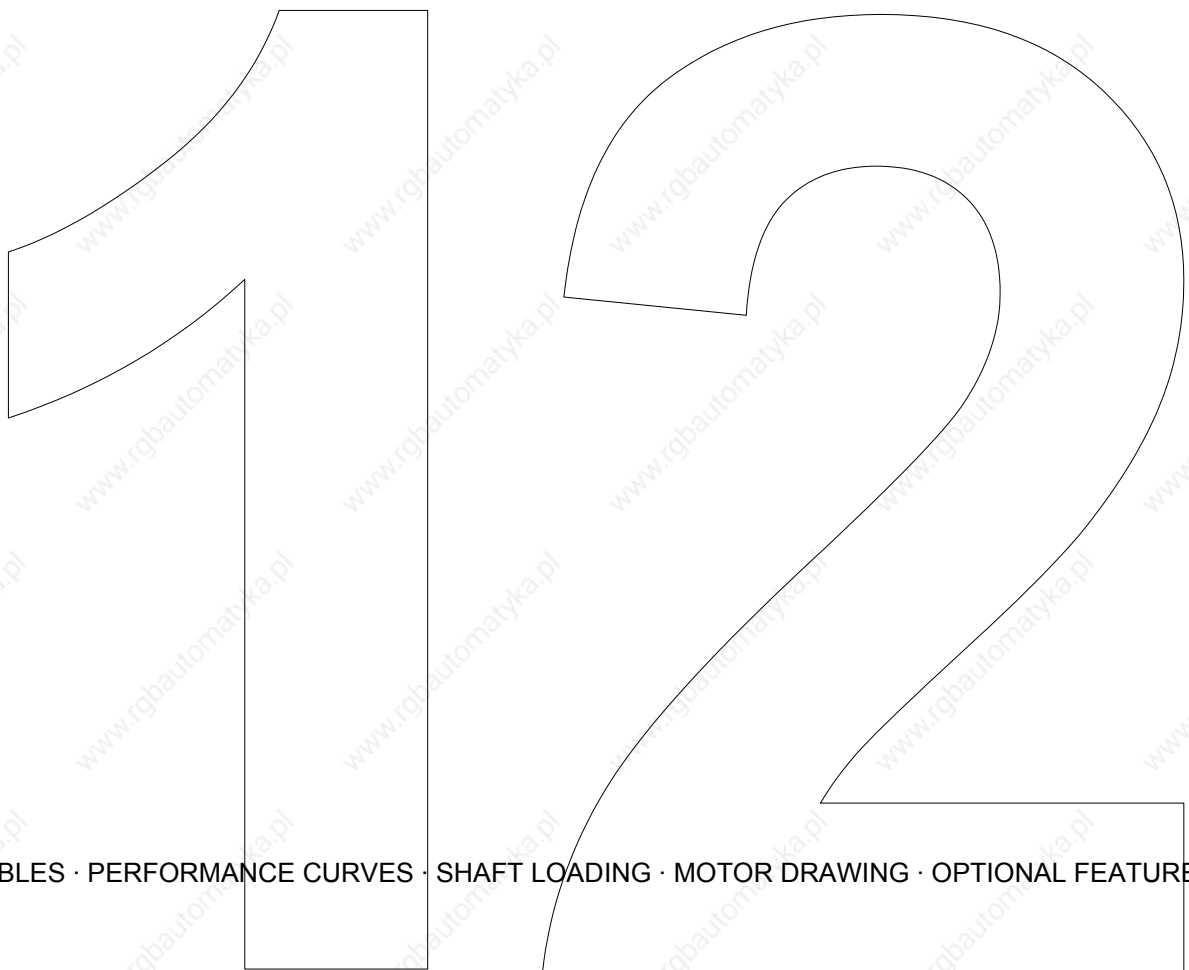

DATA TABLES · PERFORMANCE CURVES · SHAFT LOADING · MOTOR DRAWING · OPTIONAL FEATURES

HR190C8

Brushless AC Servomotors

12

Technical Data

Parameter	Units	HR190C8-260	HR190C8-180	HR190C8-130
GENERAL				
Voltage Gradient No Load	Line-Line Volts (Peak)/1000RPM	260	180	130
Max. Motor EMF	Line - Line Volts	700	700	520
Max. Speed	RPM	2700	3900	4000
Continuous Stall Torque TENV (110K)^ψ	Nm	32	32	32
	lb-in	280	280	280
(Size 500 x 500 x 20mm) Cont. Stall Torque when fitted to Heatsink	Nm	35	35	35
(Size 20 x 20 x 0.75in)	lb-in	310	310	310
STATOR WINDING				
Resistance Line-Line*	Ohms	1.5	0.77	0.39
Inductance Line-Line	MilliHenrys	20	9.7	4.9
THERMAL				
Insulation Class		F	F	F
Max. Ambient Temperature	°C	40	40	40
	°F	104	104	104
Thermal Time Constant	Minutes	40	40	40
Thermal Resistance	°C/Watt	0.29	0.29	0.29
	°F/Watt	0.52	0.52	0.52
MECHANICAL				
Static Friction Torque	Nm	0.14	0.14	0.14
	lb-in	1.25	1.25	1.25
Motor Weight	kg	28.5	28.5	28.5
	lb	63	63	63
SINUSOIDAL MOTORS				
Peak Stall Torque	Nm	87	87	87
	lb - in	770	770	770
Continuous Stall Current rms ^ψ	Amps	10.5	15	21
Rotor Polar Moment of Inertia (Inclusive of Resolver Inertia)	kgcm ²	55	55	55
	lb-in sec ²	0.049	0.049	0.049
Maximum Current (Peak)	Amp	51	73	100
Cogging Torque (No shaft seal fitted)	Nm	0.56	0.56	0.56
	lb - in	5.0	5.0	5.0
Torque Constant Kt_{rms}^{*†}	Nm/Amp	3.03	2.1	1.53
	lb-in/Amp	27	18.6	13.5

Notes

Tolerance - All data is subject to a tolerance of $\pm 10\%$ (except motor 'Voltage Gradient' and Kt which are to $+15\%/-5\%$).

* - At 25°C.

† - Note that Kt is shown as a combined value for all **three phases**.

ψ - The temperature rise ΔT on the windings is 110K and applies to all continuous torque values. The maximum ambient temperature is 40°C and therefore the temperature on the windings should not be more than 150°C. A value higher than 150°C would exceed the class F insulation temperature specification.

12

12

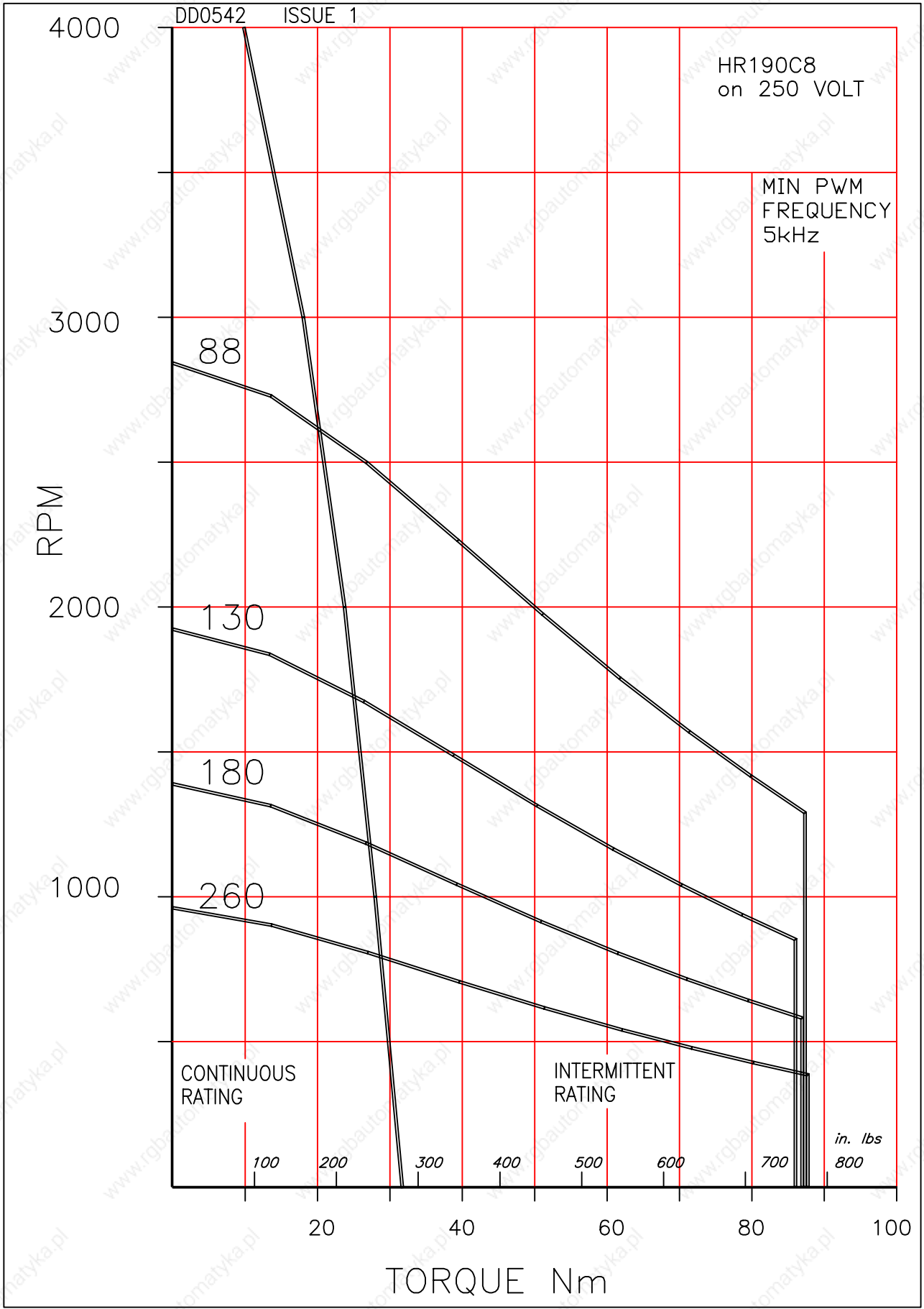

12

12

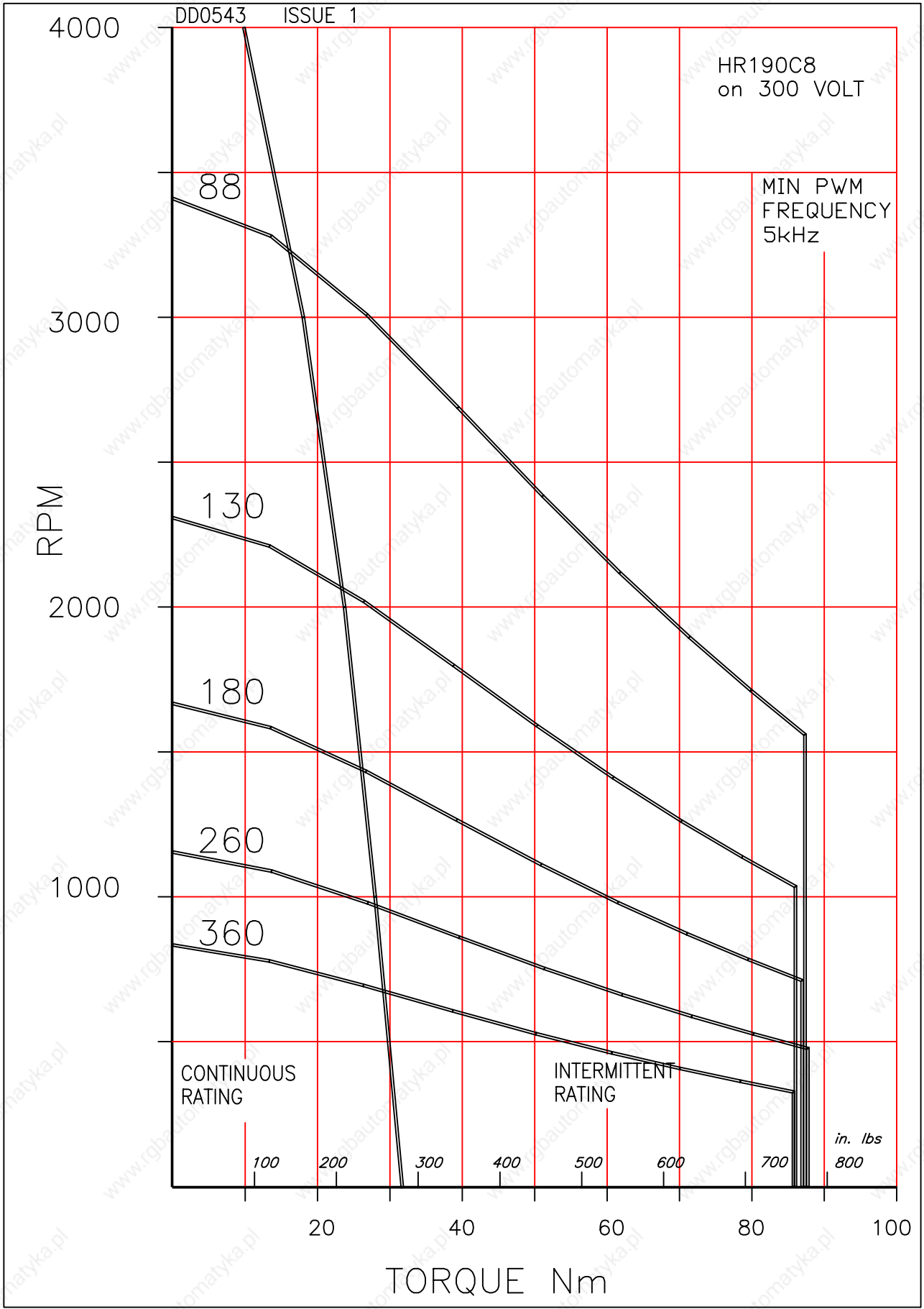

12

12

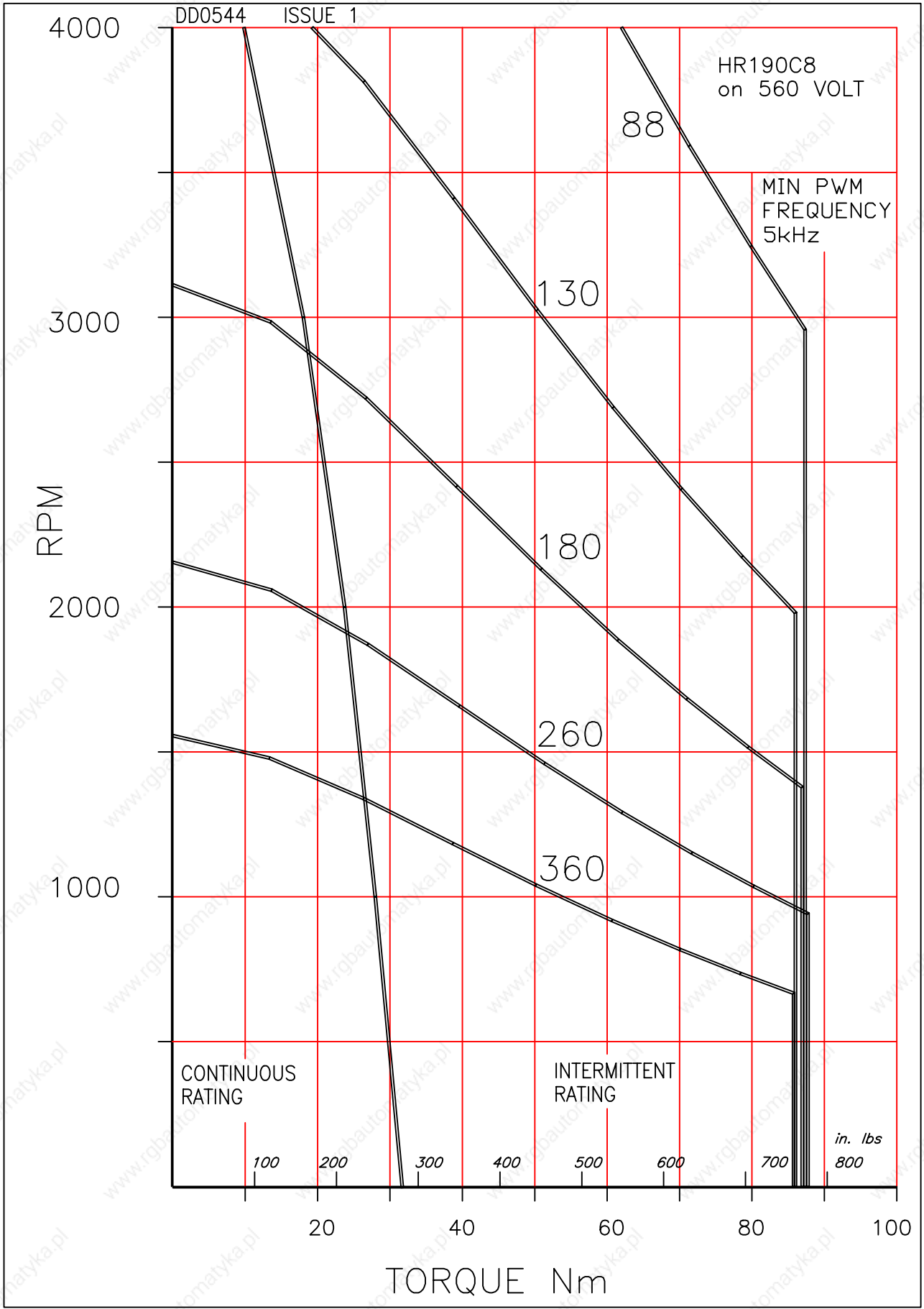

12

12

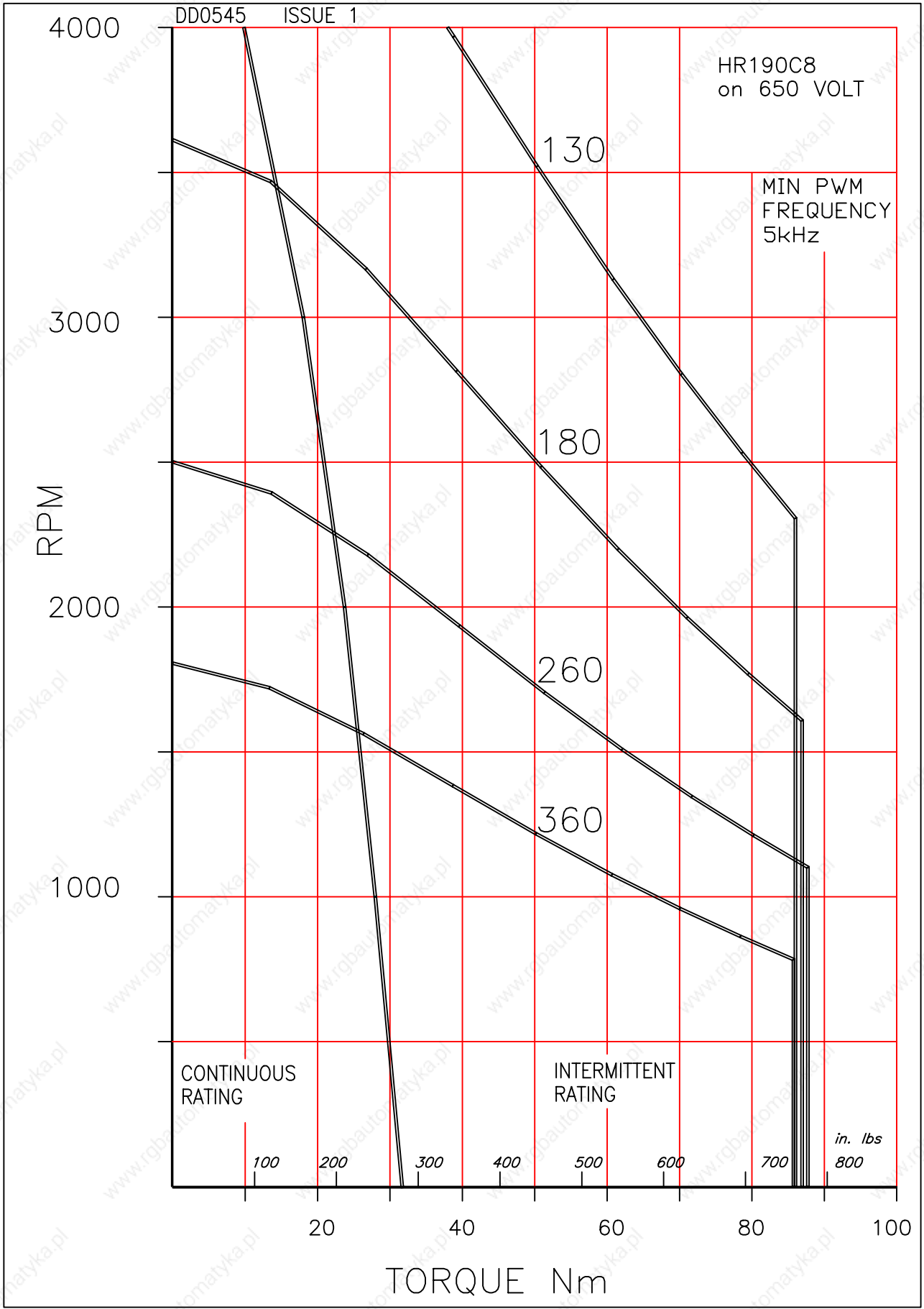

HR190E8

Brushless AC Servomotors

12

Technical Data

Parameter	Units	HR190E8-260	HR190E8-180	HR190E8-130
GENERAL				
Voltage Gradient No Load	Line-Line Volts (Peak)/1000RPM	260	180	130
Max. Motor EMF	Line - Line Volts	700	700	520
Max. Speed	RPM	2700	3900	4000
Continuous Stall Torque TENV (110K)^ψ	Nm	45	45	45
	lb-in	400	400	400
(Size 500 x 500 x 20mm)	Nm	49	49	49
Cont. Stall Torque when fitted to Heatsink (Size 20 x 20 x 0.75in)	lb-in	430	430	430
STATOR WINDING				
Resistance Line-Line*	Ohms	0.83	0.38	0.19
Inductance Line-Line	MilliHenrys	13.7	6.4	3.4
THERMAL				
Insulation Class		F	F	F
Max. Ambient Temperature	°C	40	40	40
	°F	104	104	104
Thermal Time Constant	Minutes	60	60	60
Thermal Resistance	°C/Watt	0.28	0.28	0.28
	°F/Watt	0.50	0.50	0.50
MECHANICAL				
Static Friction Torque	Nm	0.14	0.14	0.14
	lb-in	1.24	1.24	1.24
Motor Weight	kg	36	36	36
	lb	79	79	79
SINUSOIDAL MOTORS				
Peak Stall Torque	Nm	129	129	129
	lb - in	1140	1140	1140
Continuous Stall Current rms ^ψ	Amps	15	21	30
Rotor Polar Moment of Inertia (Inclusive of Resolver Inertia)	kgcm ²	78	78	78
	lb-in sec ²	0.069	0.069	0.069
Maximum Current (Peak)	Amp	75	108	150
Cogging Torque (No shaft seal fitted)	Nm	0.76	0.76	0.76
	lb - in	6.7	6.7	6.7
Torque Constant Kt_{rms}^{*†}	Nm/Amp	3.03	2.1	1.53
	lb-in/Amp	27	18.6	13.5

Notes

Tolerance - All data is subject to a tolerance of $\pm 10\%$ (except motor 'Voltage Gradient' and Kt which are to $+15\%/-5\%$).

* - At 25°C.

† - Note that Kt is shown as a combined value for all **three phases**.

ψ - The temperature rise ΔT on the windings is 110K and applies to all continuous torque values. The maximum ambient temperature is 40°C and therefore the temperature on the windings should not be more than 150°C. A value higher than 150°C would exceed the class F insulation temperature specification.

12

12

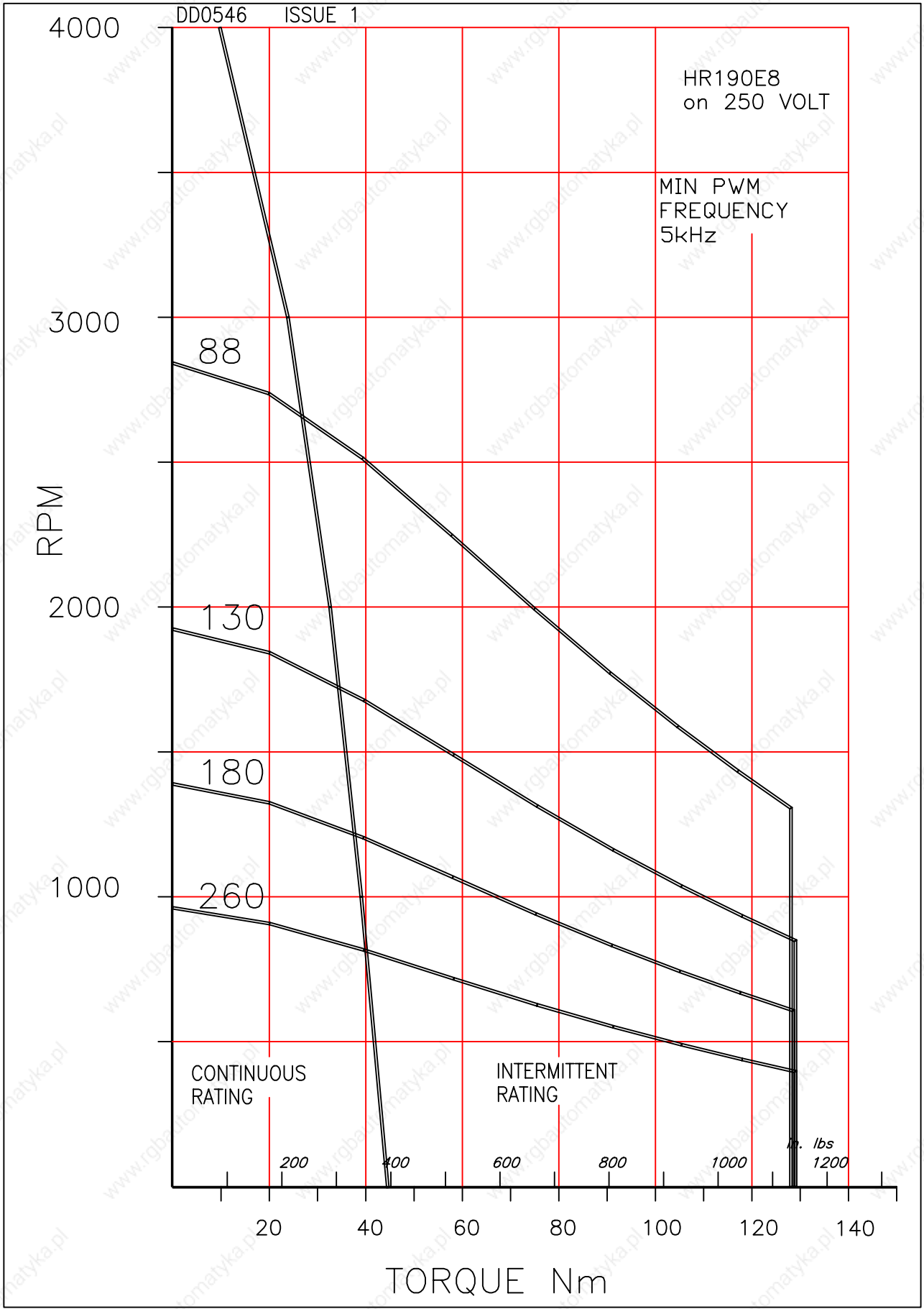

12

12

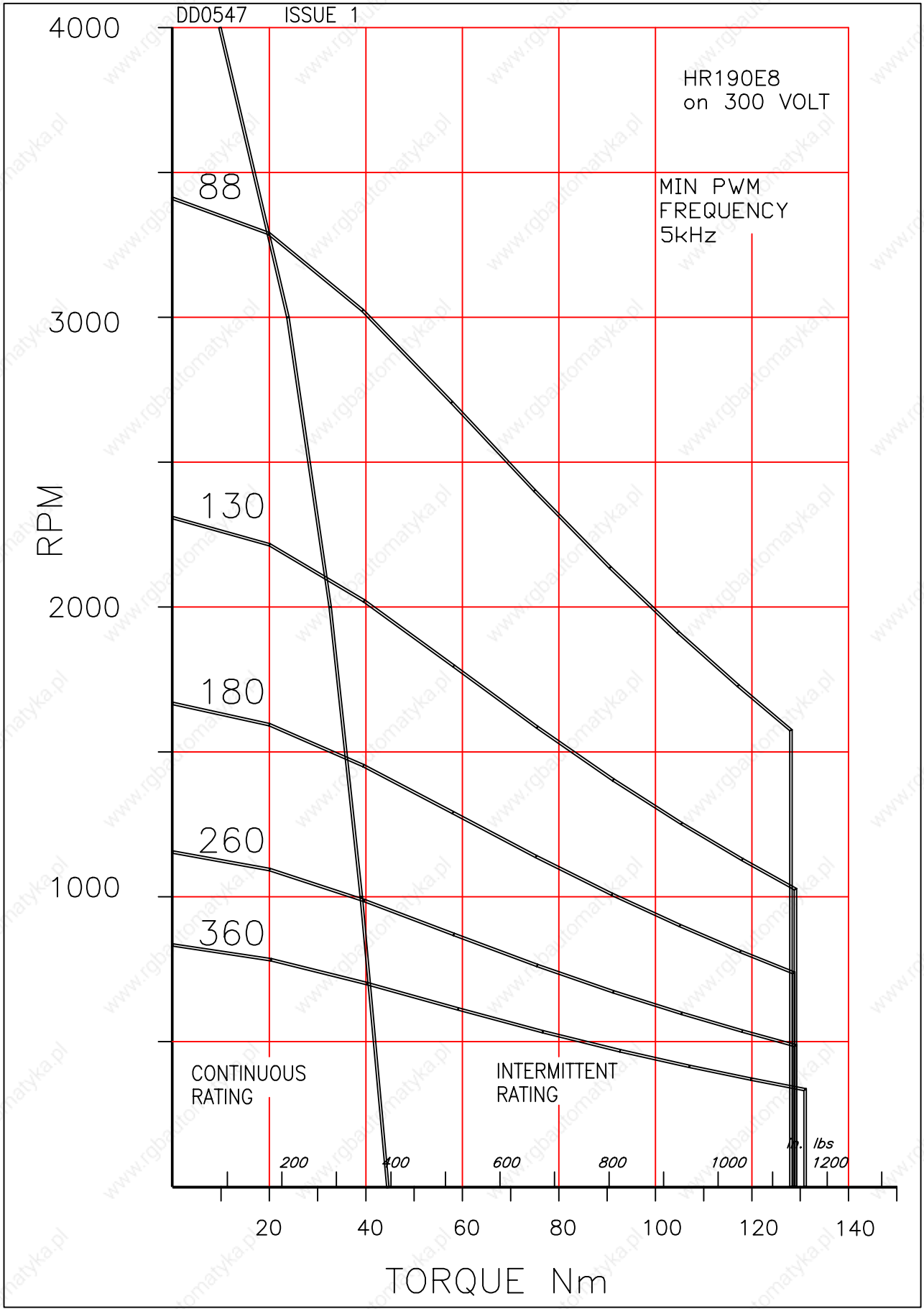

12

12

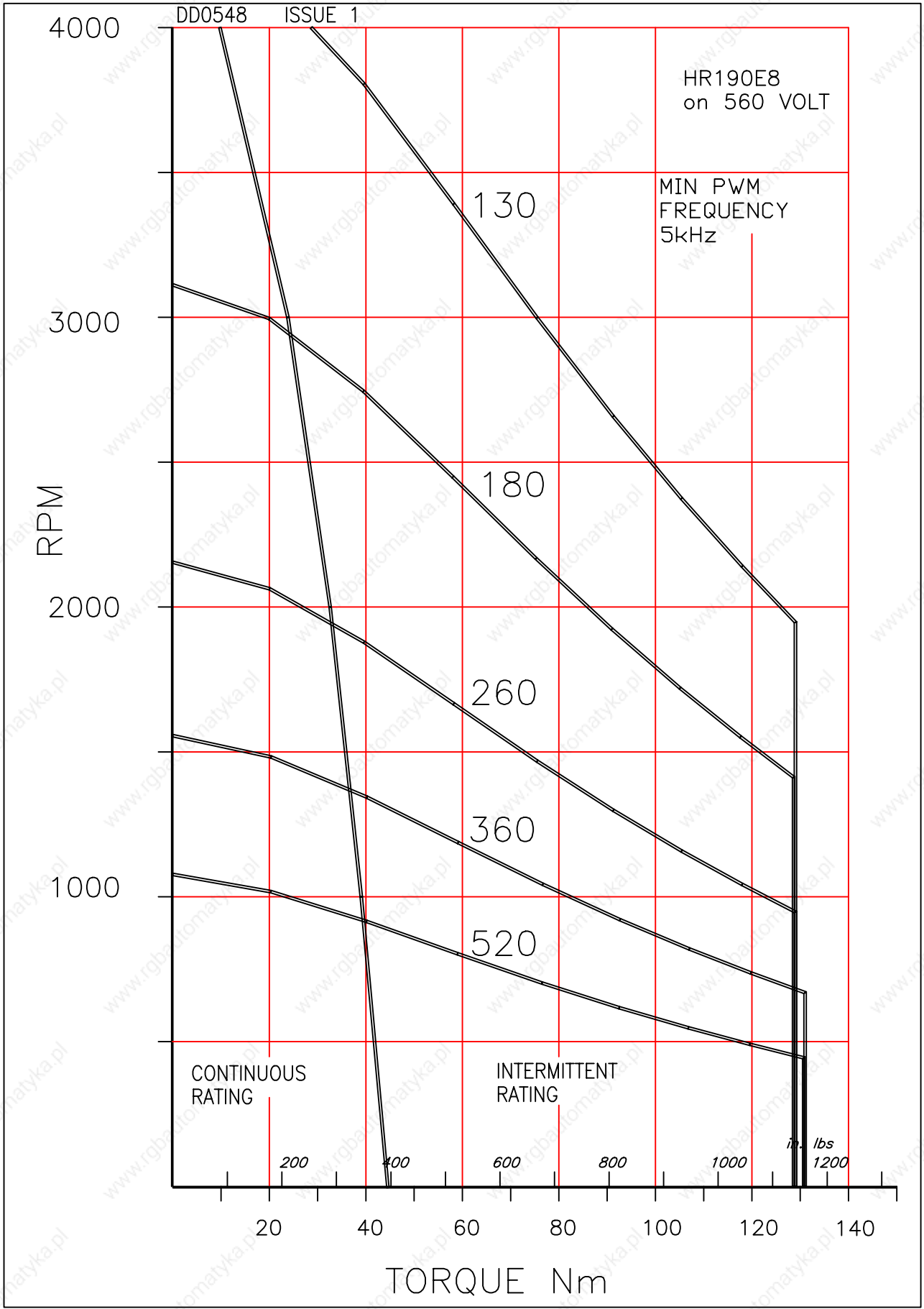

DD0549 ISSUE 2

HR190E8
on 650 VOLT

MIN PWM
FREQUENCY
5kHz

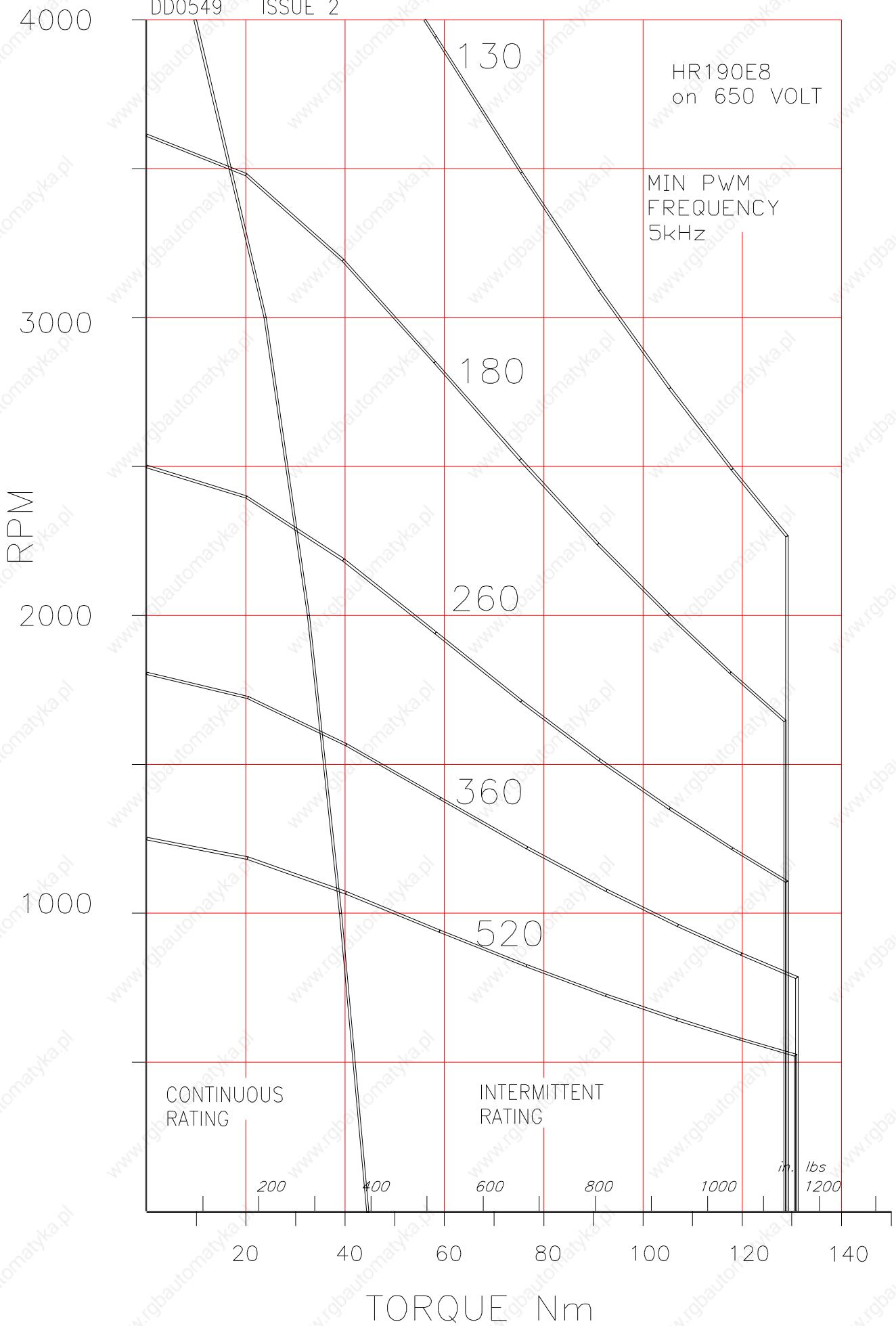

CONTINUOUS
RATING

INTERMITTENT
RATING

200

400

600

800

1000

in. lbs
1200

TORQUE Nm

HR190G8

Brushless AC Servomotors

12

Technical Data

Parameter	Units	HR190G8-360	HR190G8-260	HR190G8-130
GENERAL				
Voltage Gradient No Load	Line-Line Volts (Peak)/1000RPM	360	260	130
Max. Motor EMF	Line - Line Volts	700	700	520
Max. Speed	RPM	1900	2700	4000
Continuous Stall Torque TENV (110K)^ψ	Nm	56	56	56
	lb-in	500	500	500
	(Size 500 x 500 x 20mm) Cont. Stall Torque when fitted to Heatsink (Size 20 x 20 x 0.75in)	Nm	59	59
	lb-in	520	520	520
STATOR WINDING				
Resistance Line-Line*	Ohms	1.02	0.55	0.126
Inductance Line-Line	MilliHenrys	20	10.5	2.5
THERMAL				
Insulation Class		F	F	F
Max. Ambient Temperature	°C	40	40	40
	°F	104	104	104
Thermal Time Constant	Minutes	80	80	80
Thermal Resistance	°C/Watt	0.28	0.28	0.28
	°F/Watt	0.5	0.5	0.5
MECHANICAL				
Static Friction Torque	Nm	0.14	0.14	0.14
	lb-in	1.24	1.24	1.24
Motor Weight	kg	43	43	43
	lb	95	95	95
SINUSOIDAL MOTORS				
Peak Stall Torque	Nm	170	170	170
	lb - in	1500	1500	1500
Continuous Stall Current rms ^ψ	Amps	13.3	18	37
Rotor Polar Moment of Inertia (Inclusive of Resolver Inertia)	kgcm ²	100	100	100
	lb-in sec ²	0.089	0.089	0.089
Maximum Current (Peak)	Amp	73	100	200
Cogging Torque (No shaft seal fitted)	Nm	1.0	1.0	1.0
	lb - in	8.8	8.8	8.8
Torque Constant Kt rms^{*†}	Nm/Amp	4.2	3.03	1.53
	lb-in/Amp	37.2	27	13.5

Notes

Tolerance - All data is subject to a tolerance of ±10% (except motor 'Voltage Gradient' and Kt which are to +15%/-5%).

* - At 25°C.

† - Note that Kt is shown as a combined value for all **three phases**.

ψ - The temperature rise ΔT on the windings is 110K and applies to all continuous torque values. The maximum ambient temperature is 40°C and therefore the temperature on the windings should not be more than 150°C. A value higher than 150°C would exceed the class F insulation temperature specification.

DD0550 ISSUE 2

HR190G8
on 250 VOLT

MIN PWM
FREQUENCY
5kHz

RPM

4000

3000

2000

1000

130

180

260

360

CONTINUOUS
RATING

INTERMITTENT
RATING

in lbs
1600

200

400

600

800

1000

1200

1400

20

40

60

80

100

120

140

160

180

200

TORQUE Nm

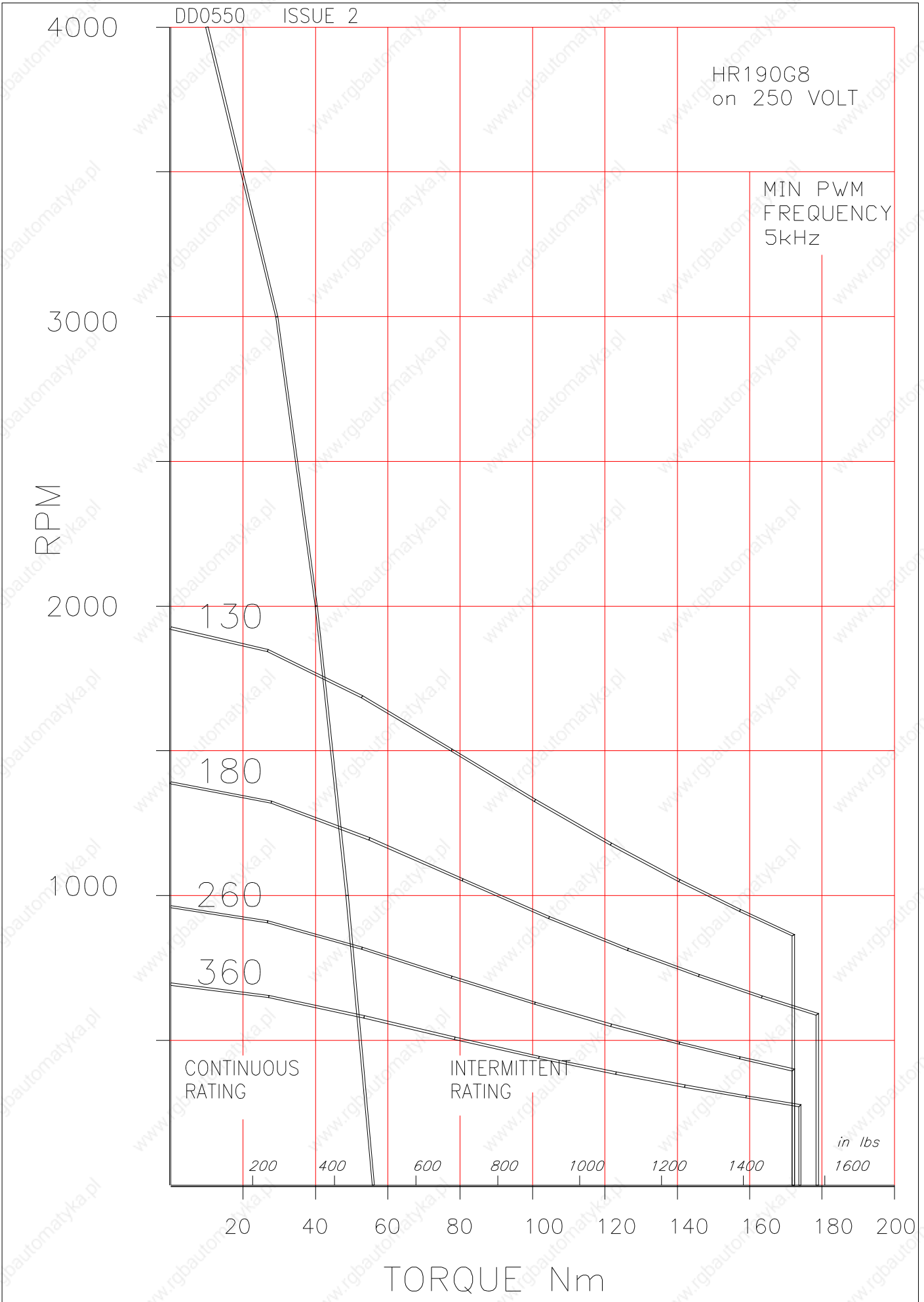

DD0551 ISSUE 2

HR190G8
on 300 VOLT

MIN PWM
FREQUENCY
5kHz

RPM

130

180

260

360

CONTINUOUS
RATING

INTERMITTENT
RATING

in lbs
1600

200

400

600

800

1000

1200

1400

1600

TORQUE Nm

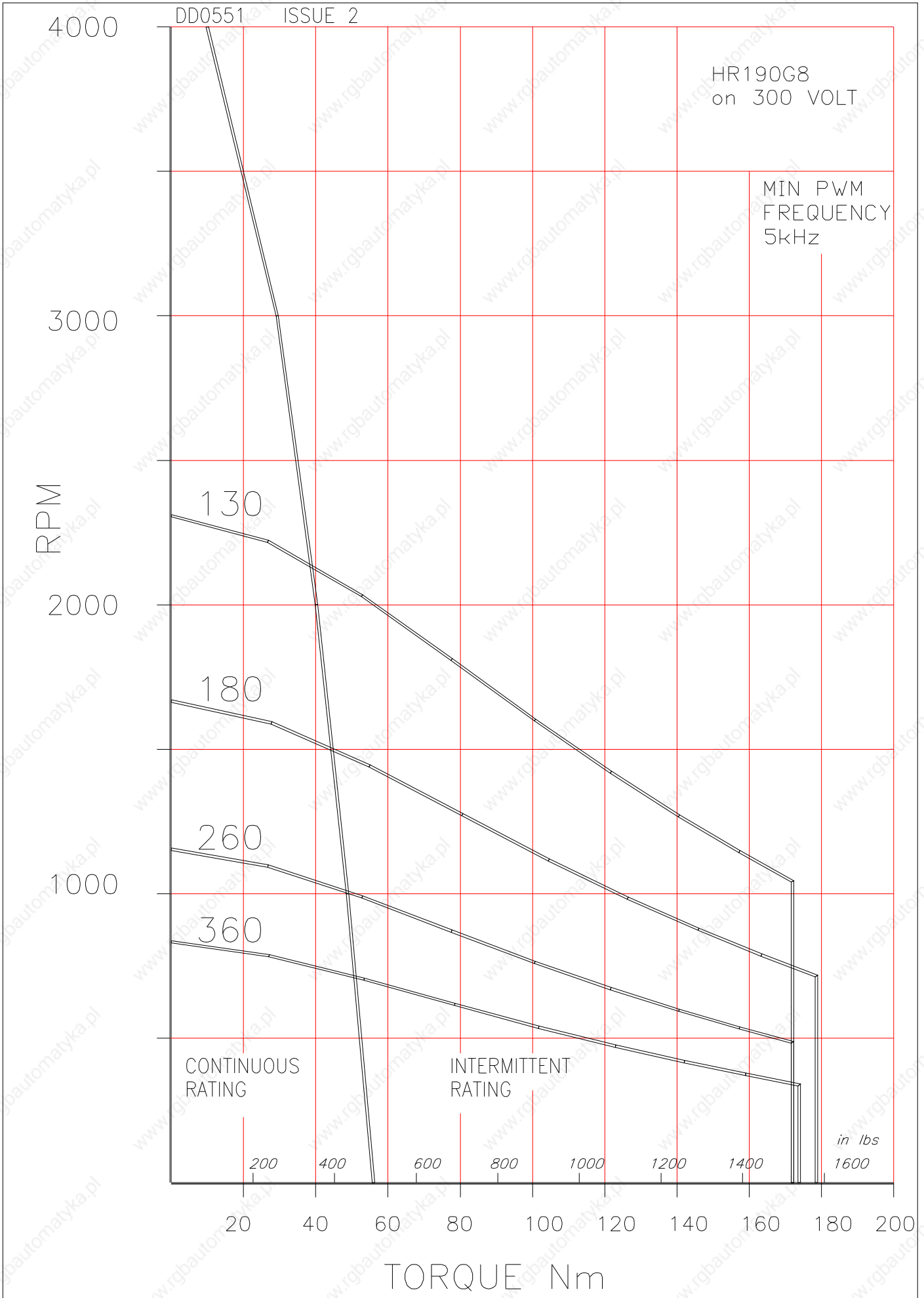

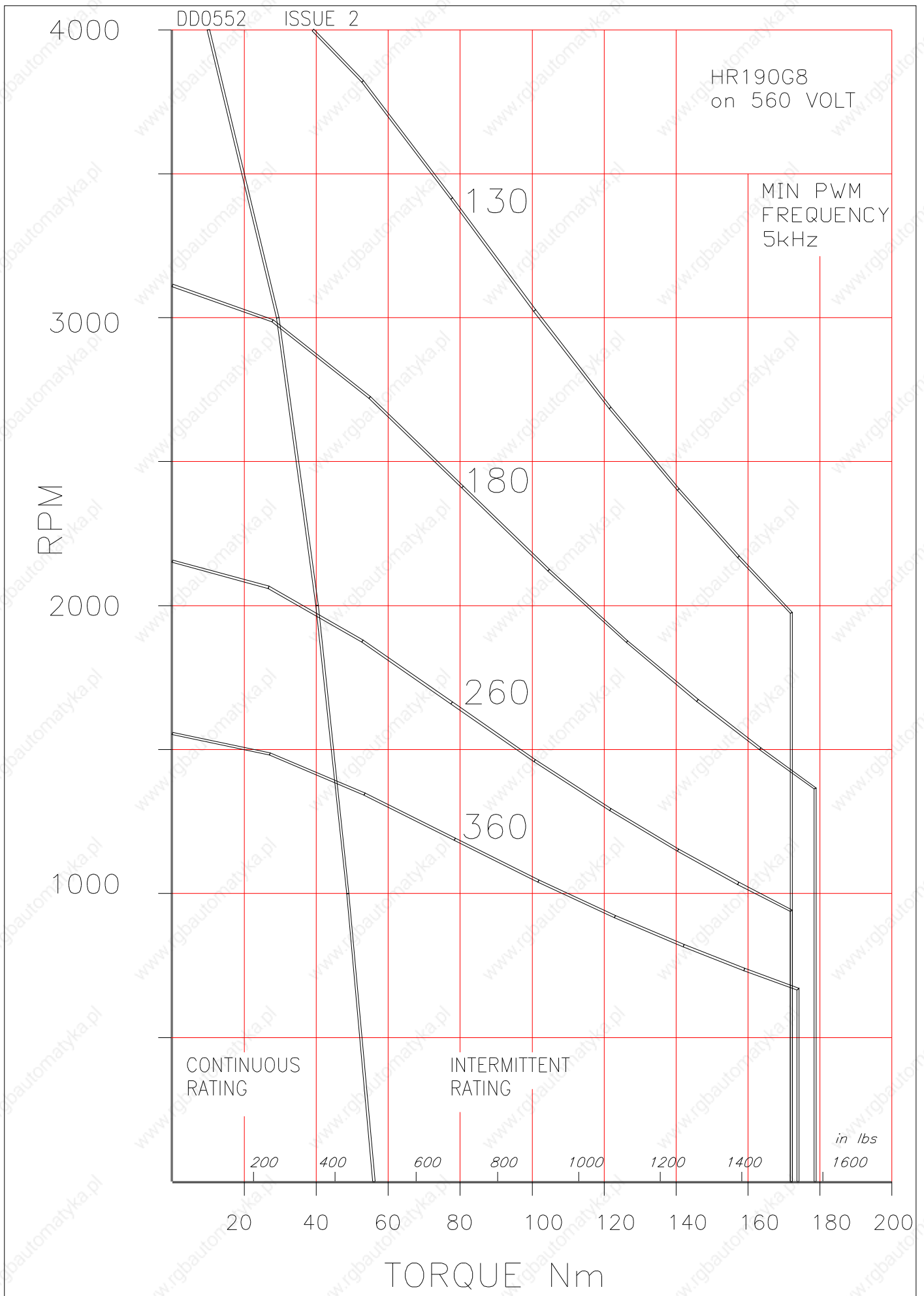

DD0553 ISSUE 2

HR190G8
on 650 VOLT

MIN PWM
FREQUENCY
5kHz

4000
3000
2000
1000
RPM

180
260
360

CONTINUOUS
RATING

INTERMITTENT
RATING

200 400 600 800 1000 1200 1400 1600
in lbs

TORQUE Nm

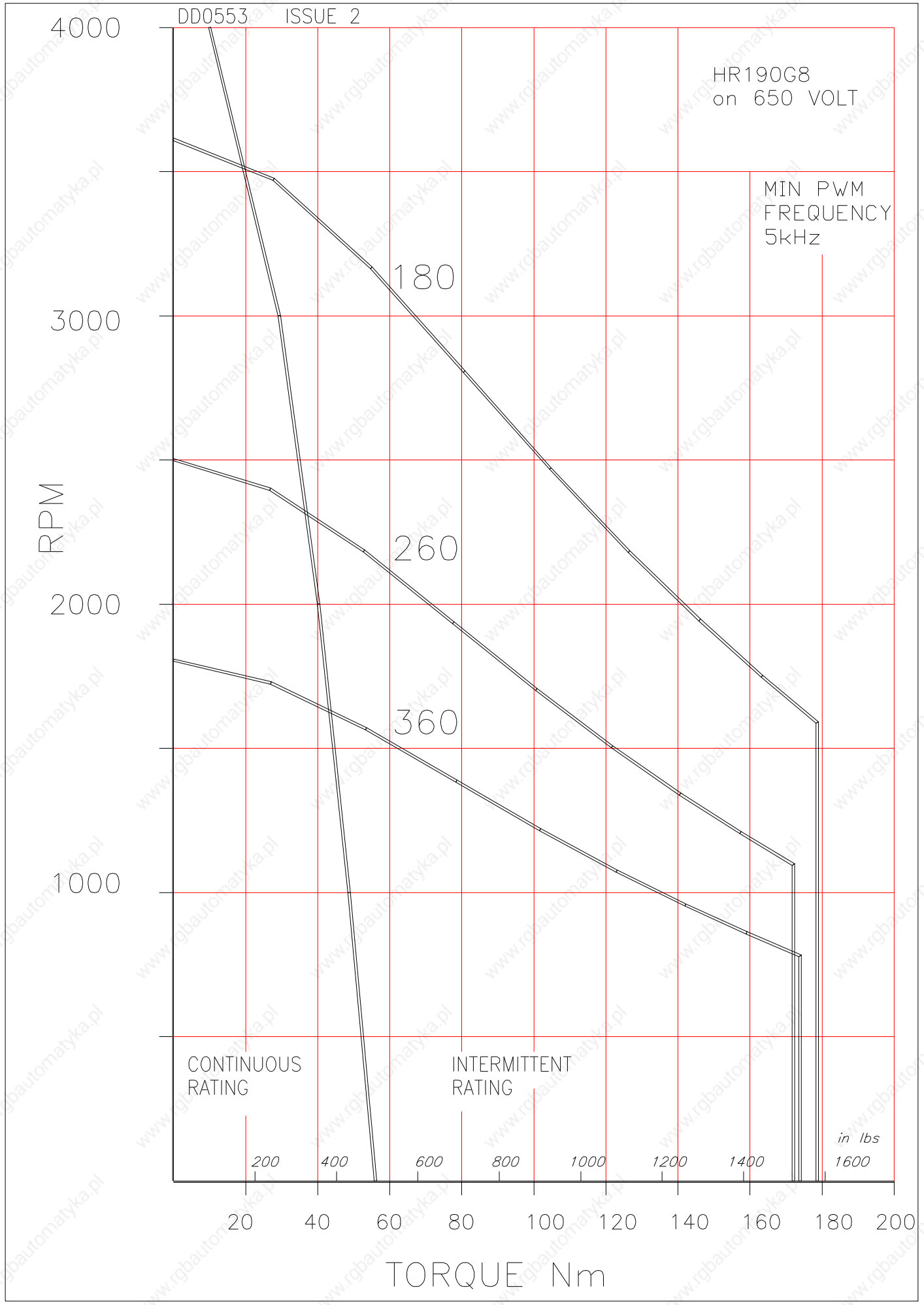

HR190J8

Brushless AC Servomotors

12

Technical Data

Parameter	Units	HR190J8-360	HR190J8-260	HR190J8-180
GENERAL				
Voltage Gradient No Load	Line-Line Volts (Peak)/1000RPM	360	260	180
Max. Motor EMF	Line - Line Volts	700	700	700
Max. Speed	RPM	1900	2700	3900
Continuous Stall Torque TENV (110K)^ψ	Nm	67	67	67
	lb-in	590	590	590
(Size 500 x 500 x 20mm)	Nm	70	70	70
Cont. Stall Torque when fitted to Heatsink (Size 20 x 20 x 0.75in)	lb-in	620	620	620
STATOR WINDING				
Resistance Line-Line*	Ohms	0.75	0.37	0.18
Inductance Line-Line	MilliHenrys	16	8	3.8
THERMAL				
Insulation Class		F	F	F
Max. Ambient Temperature	°C	40	40	40
	°F	104	104	104
Thermal Time Constant	Minutes	100	100	100
Thermal Resistance	°C/Watt	0.27	0.27	0.27
	°F/Watt	0.48	0.48	0.48
MECHANICAL				
Static Friction Torque	Nm	0.14	0.14	0.14
	lb-in	1.24	1.24	1.24
Motor Weight	kg	50	50	50
	lb	110	110	110
SINUSOIDAL MOTORS				
Peak Stall Torque	Nm	210	210	210
	lb - in	1900	1900	1900
Continuous Stall Current rms ^ψ	Amps	16	22	32
Rotor Polar Moment of Inertia (Inclusive of Resolver Inertia)	kgcm ²	130	130	130
	lb-in sec ²	0.115	0.115	0.115
Maximum Current (Peak)	Amp	91	125	180
Cogging Torque (No shalf seal fitted)	Nm	1.2	1.2	1.2
	lb - in	10.6	10.6	10.6
Torque Constant Kt rms^{*†}	Nm/Amp	4.2	3.03	2.1
	lb-in/Amp	37.2	27	18.6

Notes

Tolerance - All data is subject to a tolerance of ±10% (except motor 'Voltage Gradient' and Kt which are to +15%/-5%).

* - At 25°C.

† - Note that Kt is shown as a combined value for all **three phases**.

ψ - The temperature rise ΔT on the windings is 110K and applies to all continuous torque values. The maximum ambient temperature is 40°C and therefore the temperature on the windings should not be more than 150°C. A value higher than 150°C would exceed the class F insulation temperature specification.

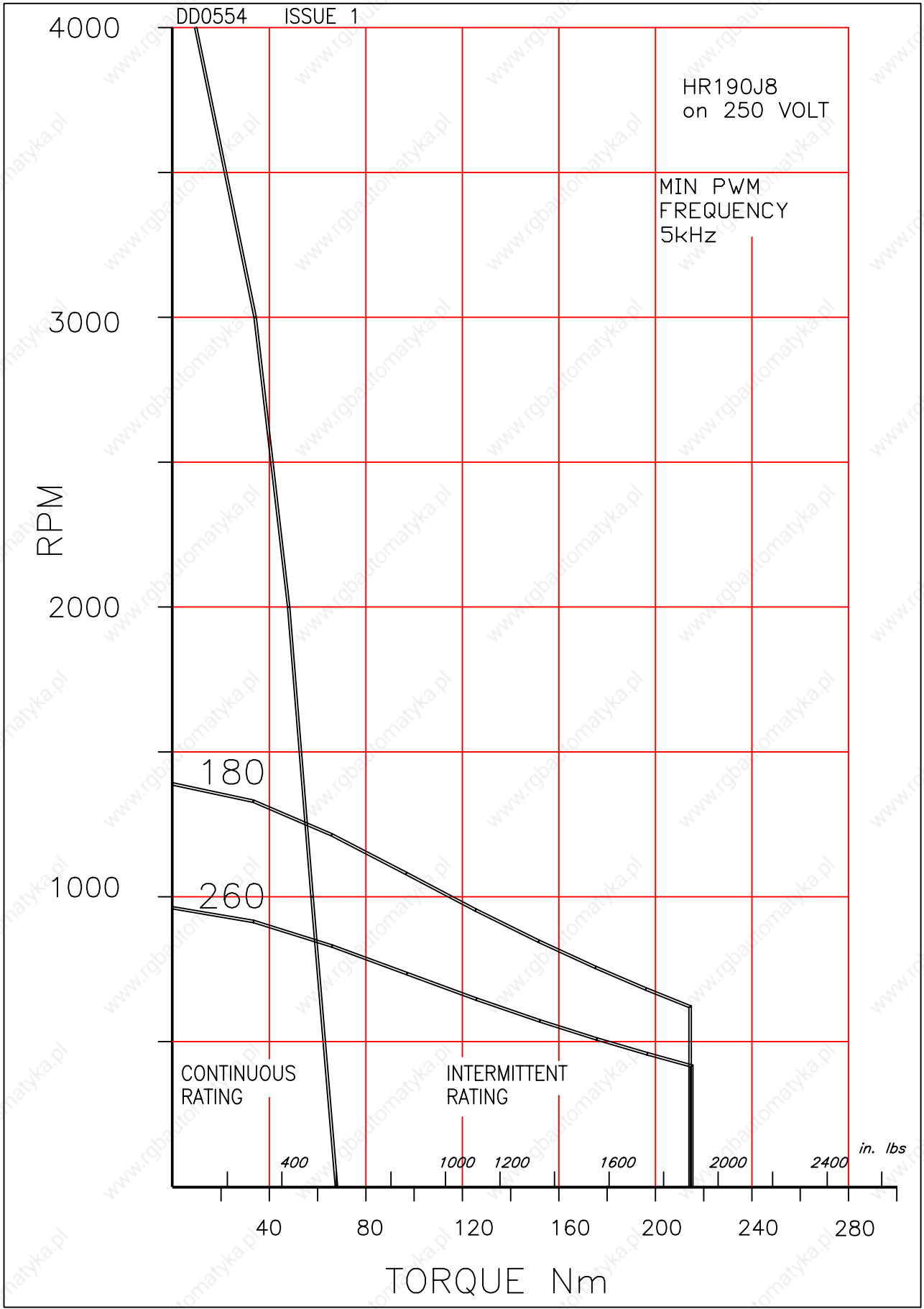

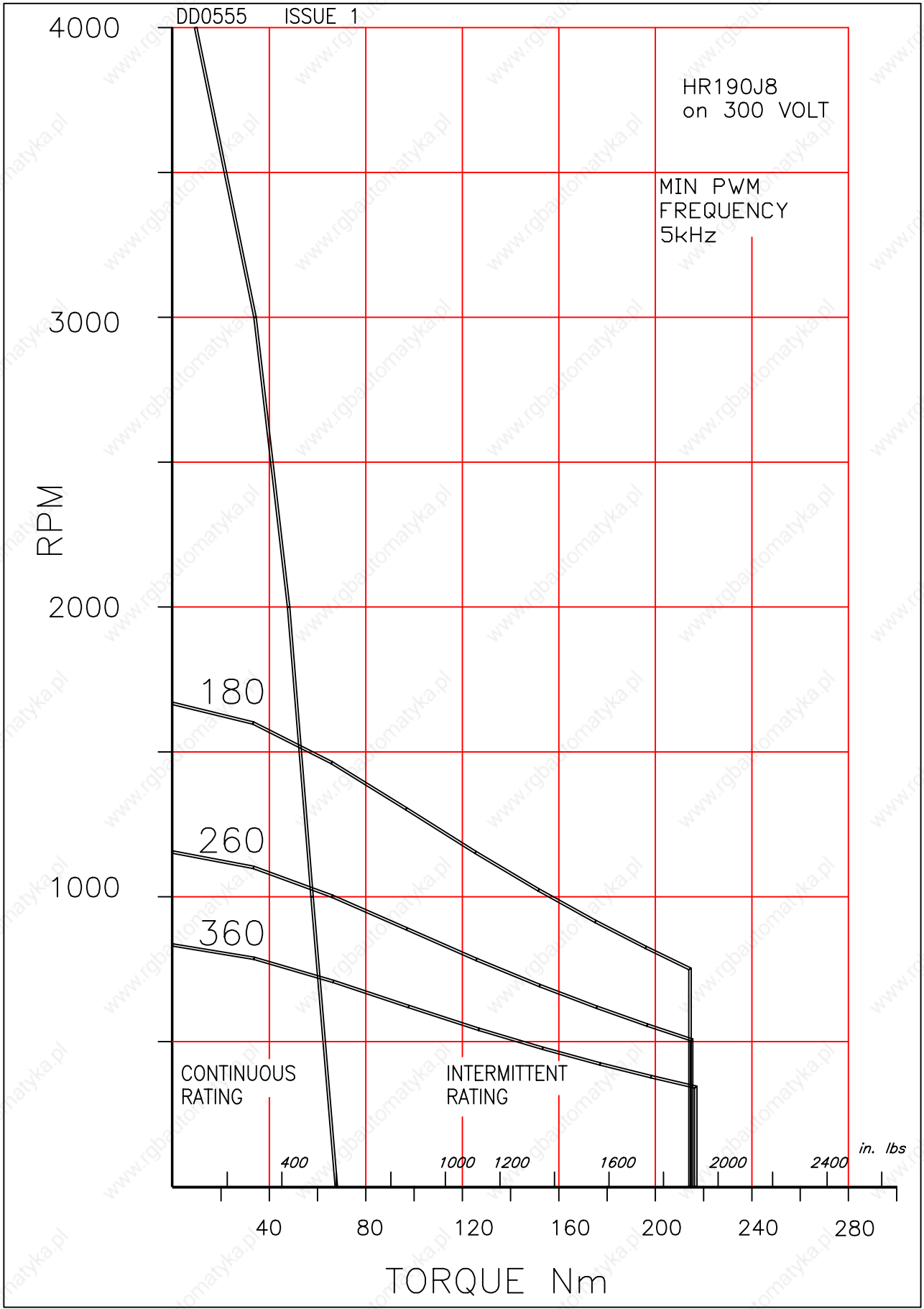

12

12

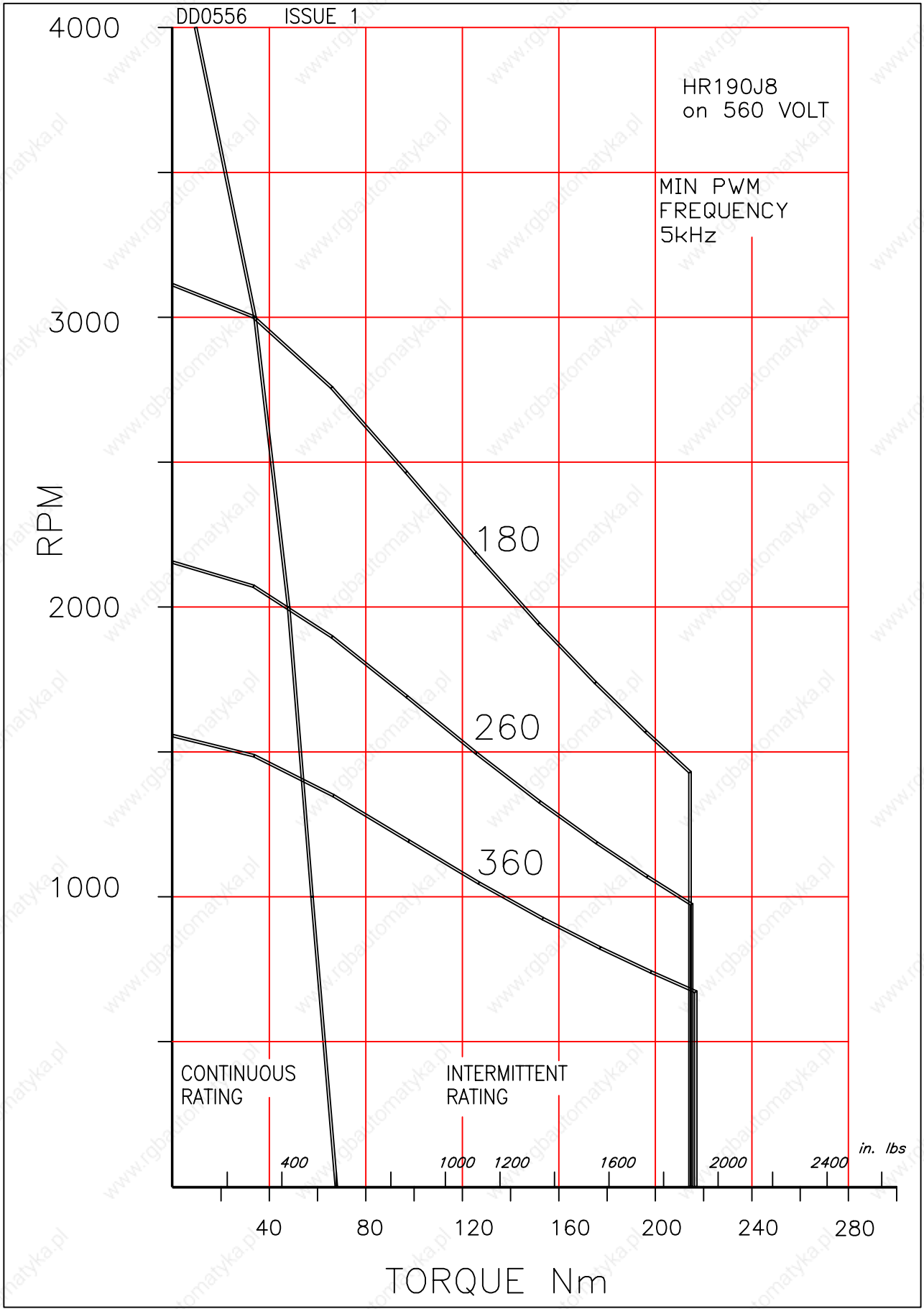

12

12

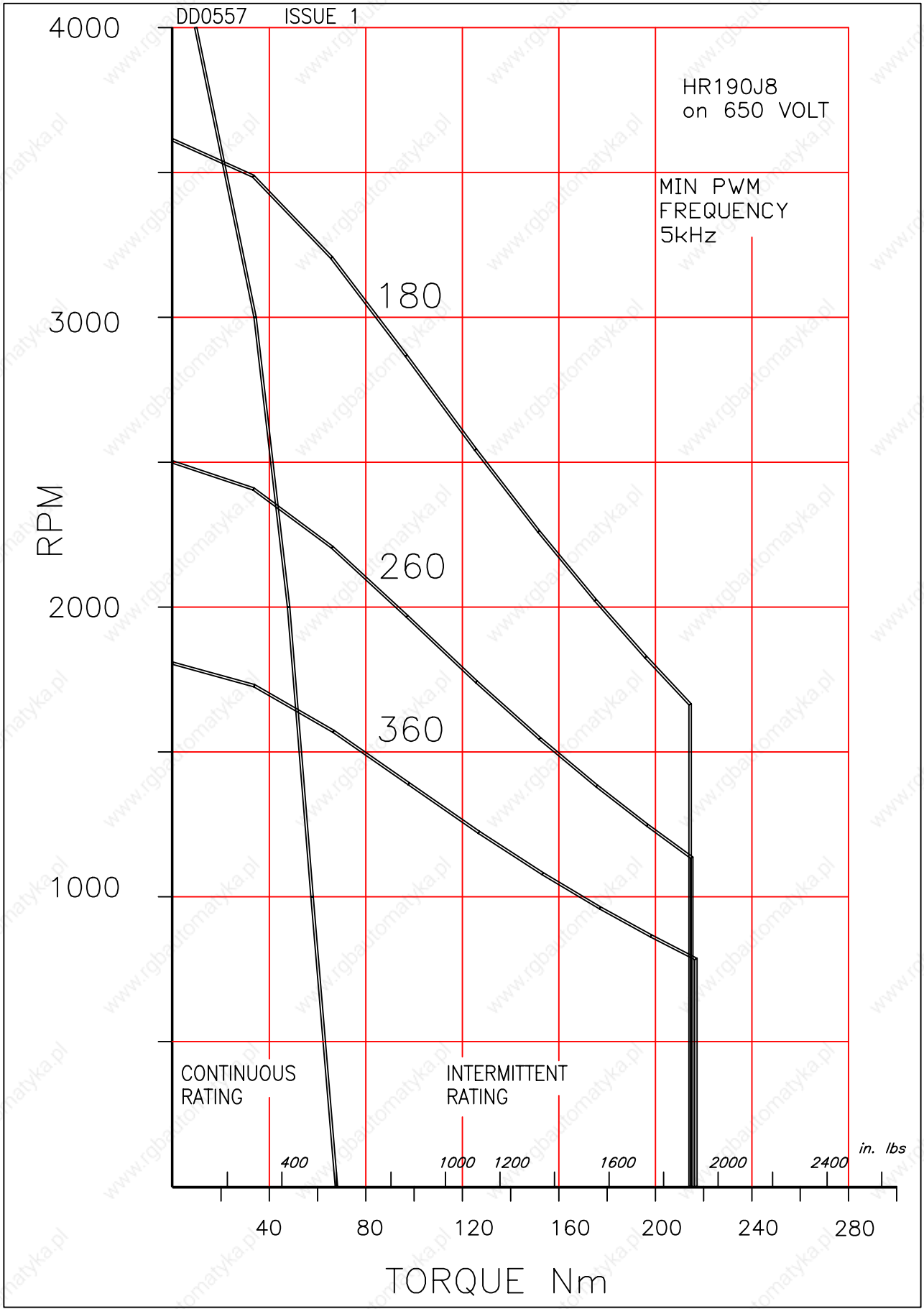

HR190 PERMITTED RADIAL SHAFT LOADING

Axial loadings may be considered separately – refer to next page

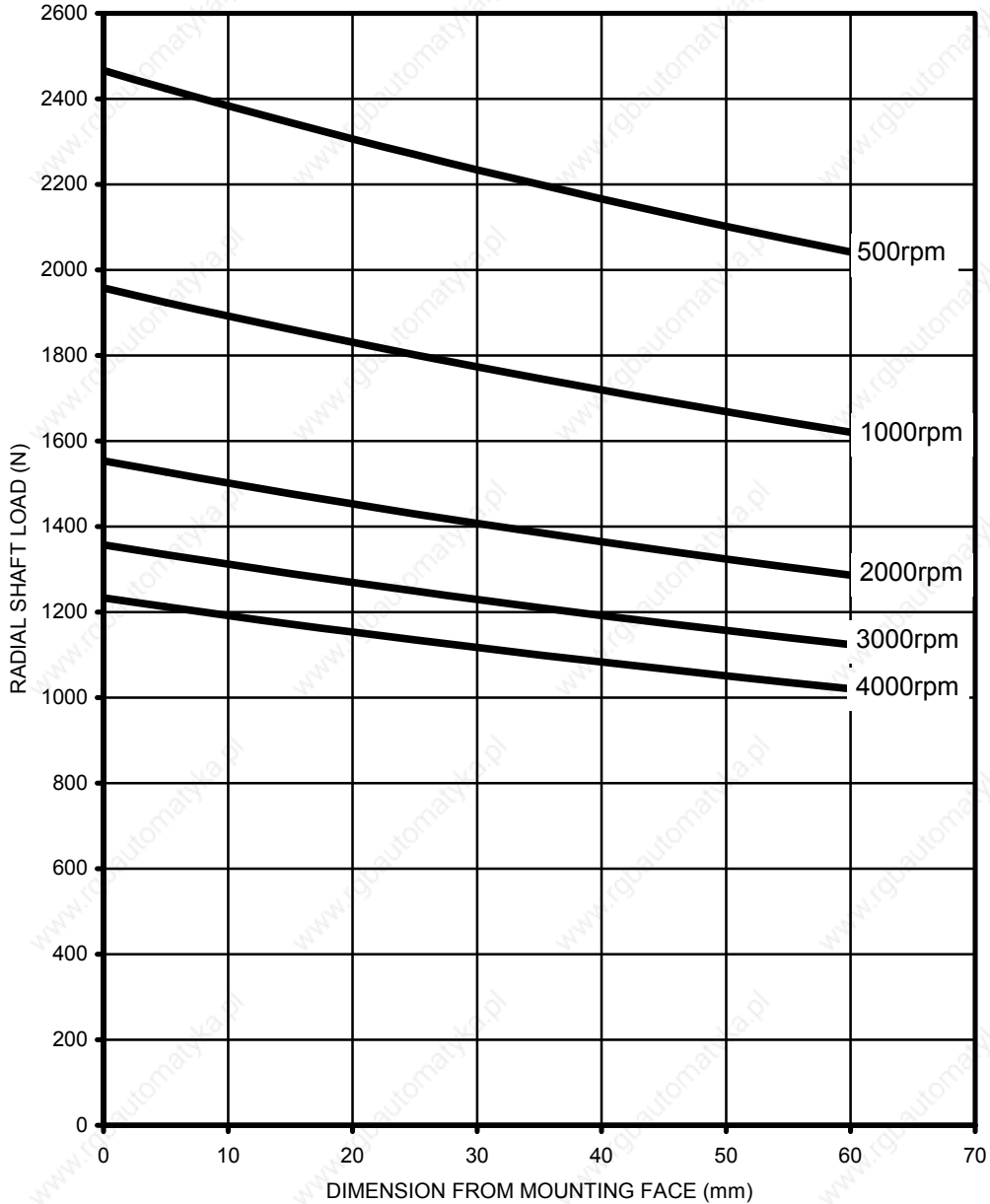

Shaft Loading Information for SEM Standard Servomotors

General notes:-

- 1 All loadings are based upon An L10 bearing life expectancy of 30,000 hours.
- 2 Separate graphs are usually supplied to indicate maximum axial loads which are applicable. However, for motors with locked drive end bearings, a graph is used to illustrate the maximum allowed radial shaft loadings together with a simplified calculation to provide a compensated figure for when radial and axial loadings are to be applied in combination.
- 3 It may occur, in certain circumstances, that loading outside the scope of the published information is deemed necessary. In these cases it is desirable that SEM Ltd should be consulted and all relevant information made available, in order that due consideration can be given to finding a satisfactory solution.
- 4 Should motors be required to operate under abnormal conditions, such as excessive vibration or shock, this should also be referred to SEM Ltd as noted above.

HR190 PERMITTED AXIAL LOAD

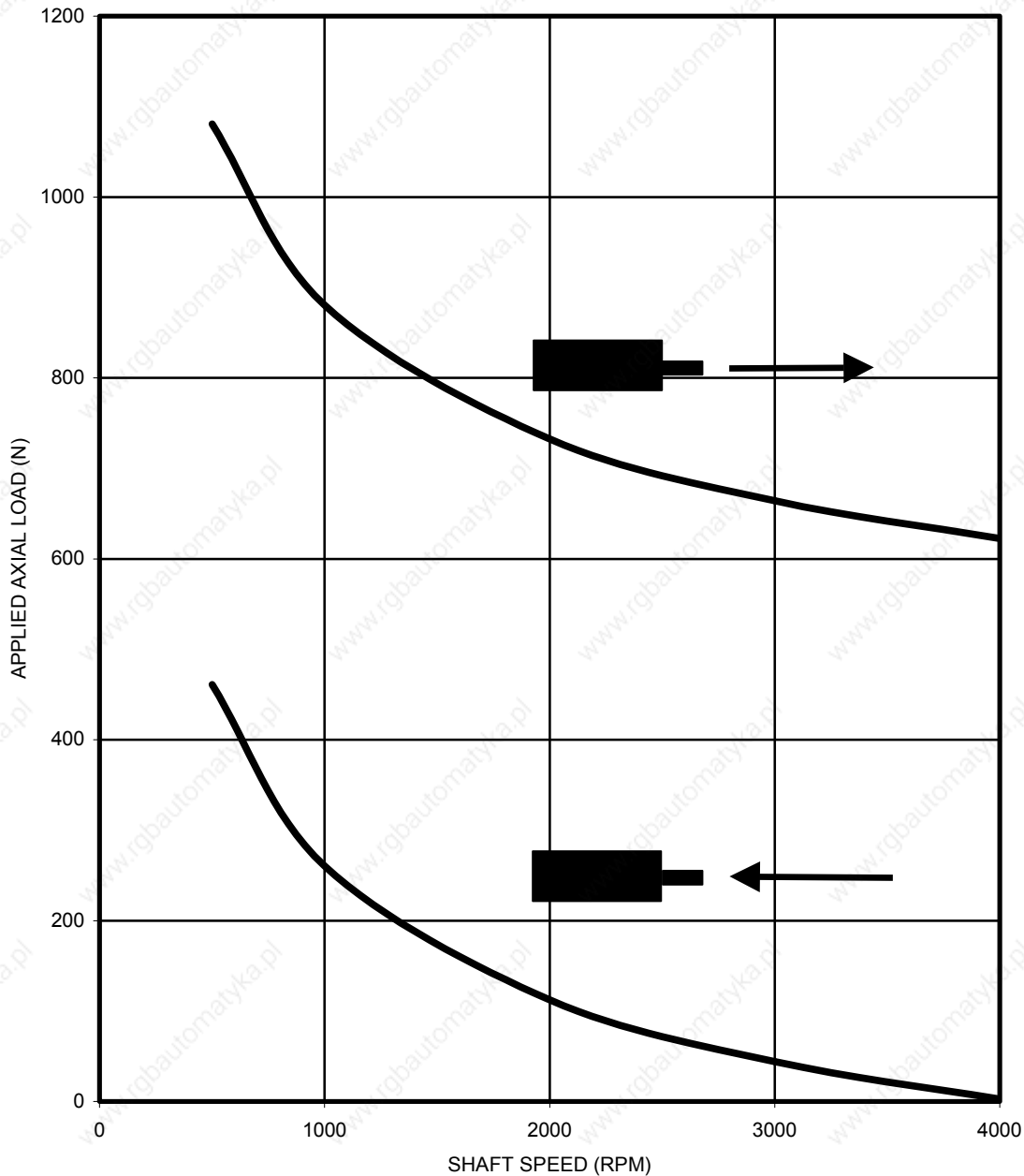

Shaft Loading Information for SEM Standard Servomotors

General notes:-

- 1 All loadings are based upon an L10 bearing life expectancy of 30,000 hours.
- 2 Separate graphs are usually supplied to indicate maximum axial loads which are applicable. However, for motors with locked drive end bearings, a graph is used to illustrate the maximum allowed radial shaft loadings together with a simplified calculation to provide a compensated figure for when radial and axial loadings are to be applied in combination.
- 3 It may occur, in certain circumstances, that loading outside the scope of the published information is deemed necessary. In these cases it is desirable that SEM Ltd should be consulted and all relevant information made available, in order that due consideration can be given to finding a satisfactory solution.
- 4 Should motors be required to operate under abnormal conditions, such as excessive vibration or shock, this should also be referred to SEM Ltd as noted above.

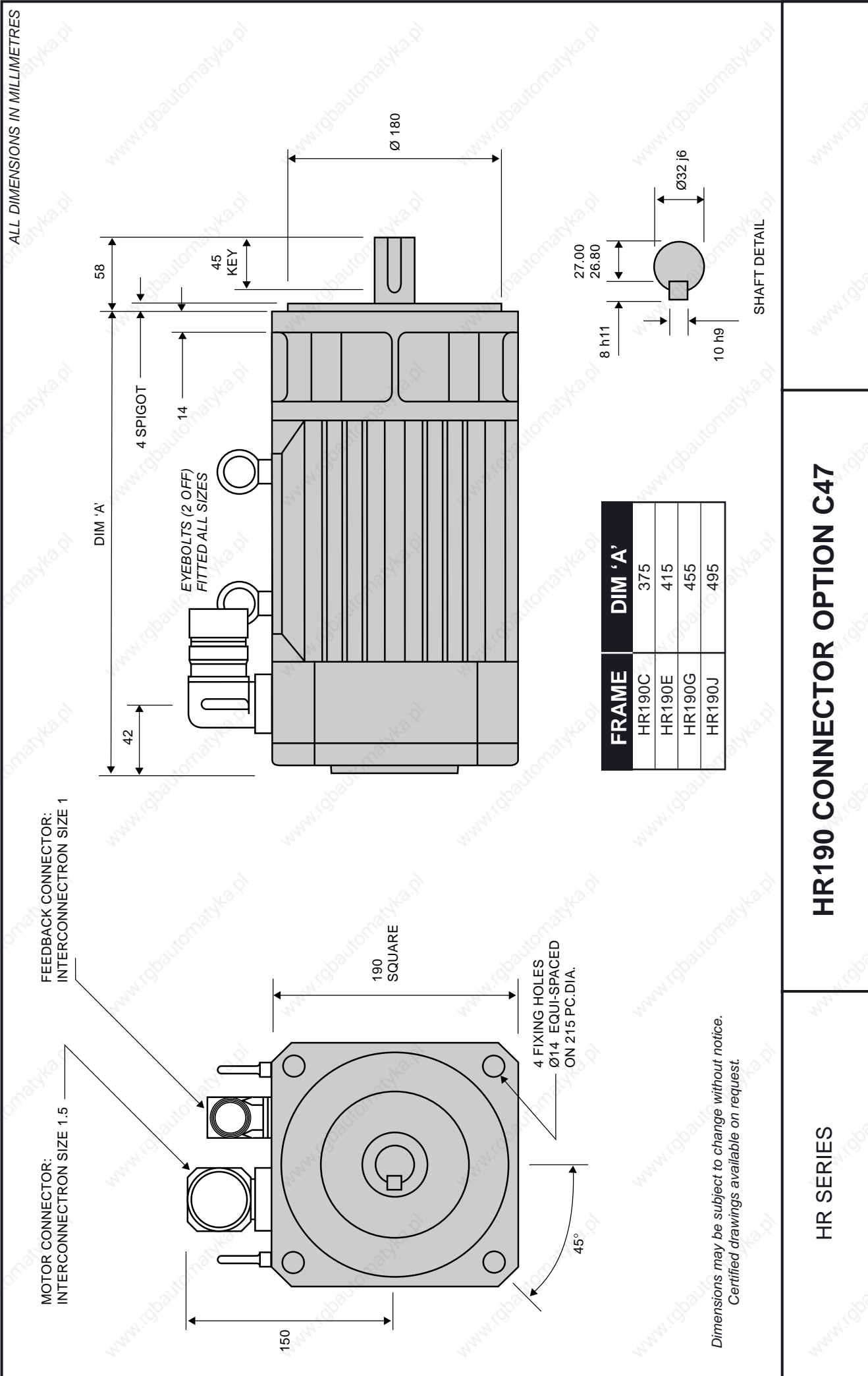

HR190 CONNECTOR OPTION C47

HR SERIES

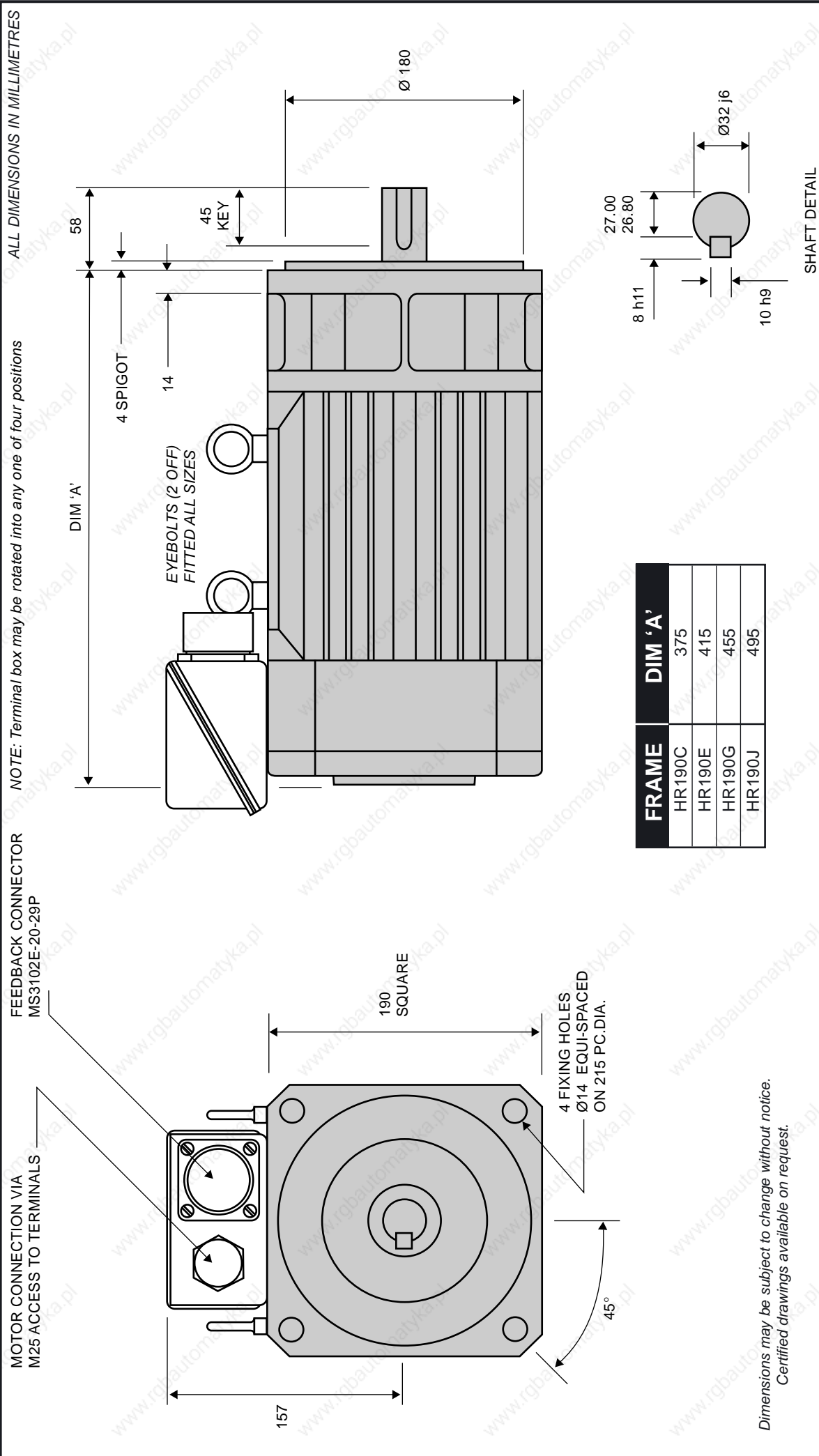

FRAME	DIM 'A'
HR190C	375
HR190E	415
HR190G	455
HR190J	495

Dimensions may be subject to change without notice.
 Certified drawings available on request.

HR SERIES

HR190 + TERMINAL BOX

ALL DIMENSIONS IN MILLIMETRES

FEEDBACK CONNECTOR
MS3102E-20-29P

MOTOR CONNECTION
MS3120E-24-10P

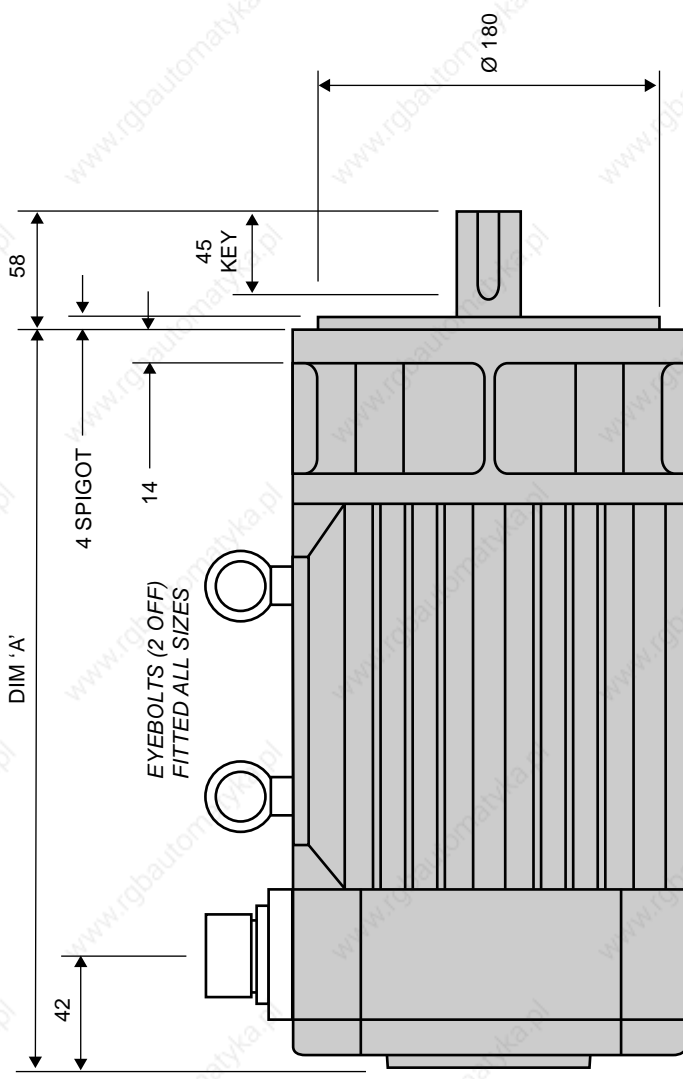

FRAME	DIM 'A'
HR190C	375
HR190E	415
HR190G	455
HR190J	495

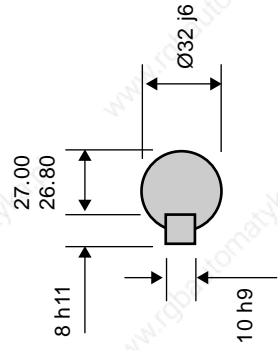

SHAFT DETAIL

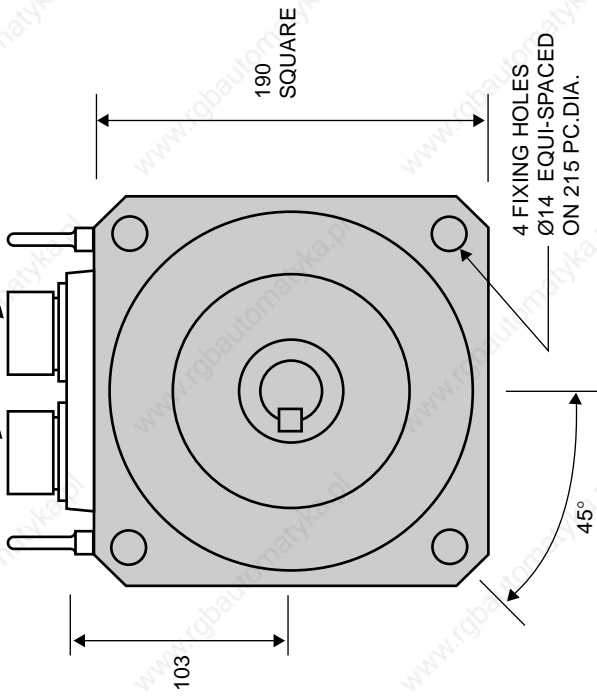

Dimensions may be subject to change without notice.
Certified drawings available on request.

HR SERIES

HR190 + MS CONNECTORS

HR190 - OPTIONS (metric series)

12

Code	Description	Notes
WAVEFORM (WINDING)		
Y00*	Waveform.	Sinusoidal waveform.
FEEDBACK DEVICES		
F00*	Resolver (F00 setting).	2 Pole Resolver type 21-B with F00 setting.
F16	Resolver (F16 setting)	2 Pole Resolver type 21-B with alternative F16 setting.
F66	No Feedback fitted	
FITTED ENCODERS		
E15	Encoder	Heidenhain ERN1387 series, 2048ppr.
E22	Encoder, singleturn, Optical	Heidenhain ECN1313 series, 2048ppr with EnDat Interface.
E16	Encoder, multiturn, Optical	Heidenhain EQN1325 series, 2048ppr with EnDat Interface.
E33	Encoder, singleturn, Inductive	Heidhenhain ECI1319 series, 32ppr with EnDat Interface
E34	Encoder, multiturn, Inductive	Heidhenhain ECI1331 series, 32ppr with EnDat Interface
E20	Encoder, singleturn.	Stegmann SRS50 series with Hiperface Interface.
E21	Encoder, multiturn.	Stegmann SRM50 series with Hiperface Interface.
E26**	Incremental encoder	Renco R35i, 1000ppr
E28**	Incremental encoder	Renco R35i, 2048ppr
E29**	Incremental encoder	Renco R35i, 4000ppr
E31**	Incremental encoder	Renco R35i, 8192ppr
MECHANICAL INTERFACE		
M00*	Flange.	190 x 190 mm square flange. Spigot Ø 180mm. Fixing 4 x Ø 14mm holes on 215 mm PCD.
R01	Close tolerance interface.	Flange & shaft to IEC72-P (precision).
S00*	Shaft.	Ø 32mm x 58mm long.
K00*	Keyway.	10 x 8 x 45 mm long.
K99	No Keyway.	Plain shaft.
D01*	Shaft end threaded hole.	M12 x 20mm deep.
BRAKES		
BRAKES		
B00	24Vdc Brake.	70.0Nm Torque
B01	90Vdc Brake.	70.0Nm Torque
L01	Rectifier for B01	110Vac Input/90Vdc output for options B01 (mounted inside terminal box).
ELECTRICAL TERMINATIONS		
C74*	Terminal Box (Standard format)	Terminal Box with 1 x M25 hole. Feedback 12 pin Interconnectron feedback receptacle (for use with resolver feedback).
C75	Terminal Box	Terminal Box with 1 x M25 hole. Feedback 17 pin Interconnectron feedback receptacle (for use with encoderfeedback).
C71	Interconnectron motor & feedback connector.	Size 1.5 motor receptacle, 6 pin 12 pin feedback receptacle rotating type facing drive end (for use with resolver feedback). (Note that there are restrictions on the current for this power connector and this option is therefore not available for all motors).
C72	Interconnectron Motor & feedback connector.	Size 1.5 motor receptacle, 6 pin 17 pin feedback receptacle rotating type facing drive end (for use with encoder feedback). (Note that there are restrictions on the current for this power connector and this option is therefore not available for all motors).
C73	Motor plug & cable clamp.	Straight plug & cable clamp for C71 and C72.
C68	Feedback plug & cable clamp.	Straight plug & cable clamp for C71 and C74
C69	Feedback plug & cable clamp.	Straight plug & cable clamp for C72 and C75
C00	Terminal Box	Terminal Box with 1 x M25 hole. Feedback MS receptacle (17 pin)
C01	Motor & feedback connector	Motor receptacle (7 pin) & feedback receptacle (17 pin)
C04	Feedback plug & cable	Straight plug and cable clamp for C00, C01
C08	Motor Plug & cable	Straight plug and cable clamp for C01

* Standard feature

** Other line counts available on request

HR190 - OPTIONS (metric series)

12

THERMAL PROTECTION

P21*	Thermal overload.	Bi-metal thermal switch.
P17	Thermal overload.	Temperature sensor, Phillips type KTY 84-130.
P18	No thermal overload.	Thermal protection not fitted.

ENCLOSURE PROTECTION

W00*	IP64/65 enclosure.	Nitrile shaft seal for IP64/65 protection (factory fitted).
W01	IP64/65 enclosure.	Viton shaft seal for IP64/65 protection (factory fitted).
W02	IP64/65 enclosure.	Nitrile shaft seal for IP64/65 protection (supplied loose).
W03	IP64/65 enclosure.	Viton shaft seal for IP64/65 protection (supplied loose).
W99	No Shaft Seal Fitted	

UL APPROVAL

U00	UL approved motor
-----	-------------------

* Standard feature

** Other line counts available on request

USEFUL FORMULAE

All formulae given are for use in conjunction with the data published within this manual.

$$\text{Mechanical Time Constant, } \tau_m = (J.R)/(2.Kt_{rms}^2)$$

$$\text{Electrical Time Constant, } \tau_e = (R/L)$$

$$\text{Power, } P = (M_n.\omega)/9.55$$

Units

Mechanical time constant:	ms	τ_m
Electrical time constant:	ms	τ_e
Power:	W	P
Rotor polar moment of inertia:	kg cm ²	J
Resistance:	Ω	R
Torque constant:	Nm/A	Kt_{rms}
Inductance:	H	L
Torque (nominal):	Nm	M_n
Rotational speed:	rpm	ω

Conversion table

Length:	1" (inch) = 25.4 mm	1m = 3.281' (feet)
Mass:	1oz (ounce) = 0.0283 kg	1kg = 2.205lb (pounds)
Force:	1oz = 0.278 N	1N = 0.225lb
Temperature:	1F = (9/5)T _c + 32	1°C = 5/9 (T _f - 32)
Torque:	1lb-in = 0.113 Nm	1Nm = 0.7376 lb-ft
Inertia:	1oz-in ² = 1.83x10 ⁻⁵ kgm ²	1kgm ² = 8.85 lb-in s ²
Power:	1HP = 746 W	1kW = 1.34 HP

In accordance with our policy of continual product improvement, SEM reserves the right to amend the specification of these products without prior notification.

Everything possible is done to ensure the accuracy of the technical information published herewith. However, mistakes do occur and data should be double-checked with SEM prior to its use in any decisive design stage.