



PNOZ® Safety Relays

pitz
more than automation
safe automation

Safety relays PNOZ X, PNOZsigma and PNOZelog,
Modular safety relays PNOZmulti and PNOZpower

The optimum safety solution for every requirement.



Support

Technical help round the clock!

Technical support is available from Pilz round the clock. This service is provided free of charge beyond standard business hours.

Americas

- ▶ Brazil
+55 11 8245-8267
- ▶ Mexico
+52 55 5572 1300
- ▶ USA (toll-free)
+1 877-PILZUSA (745-9872)

Asia

- ▶ China
+86 21 62494658-216
- ▶ Japan
+81 45 471-2281
- ▶ Korea
+82 2 2263 9540

Australia

- ▶ Australia
+61 3 95446300

Europe

- ▶ Austria
+43 1 7986263-0
- ▶ Belgium, Luxembourg
+32 9 3217575
- ▶ England
+44 1536 462203
- ▶ France
+33 3 88104000
- ▶ Germany
+49 711 3409-444
- ▶ Ireland
+353 21 4804983
- ▶ Italy
+39 031 789511
- ▶ Scandinavia
+45 74436332
- ▶ Spain
+34 938497433
- ▶ Switzerland
+41 62 88979-30
- ▶ The Netherlands
+31 347 320477
- ▶ Turkey
+90 216 5452912

**You can reach our
international hotline on:**

+49 711 3409-444

Pilz GmbH & Co. KG
Sichere Automation
Felix-Wankel-Straße 2
73760 Ostfildern, Germany



Telephone: +49 711 3409-0
Telefax: +49 711 3409-133
E-Mail: pilz.gmbh@pilz.de
Internet: www.pilz.com

Business activities

Excellent Components

Sensor technology	<ul style="list-style-type: none"> ▶ Safety switches ▶ Secure safety gate systems ▶ Optoelectronic protective devices ▶ Safe camera systems 	
Control and communication	<ul style="list-style-type: none"> ▶ Electronic monitoring relays ▶ Safety relays ▶ Programmable safety and control systems ▶ Industrial communication 	
Motion Control	<ul style="list-style-type: none"> ▶ Control systems ▶ Servo amplifiers ▶ Motors 	
Operating and monitoring	<ul style="list-style-type: none"> ▶ Control and signal devices ▶ Operator terminals 	
Software	<ul style="list-style-type: none"> ▶ System software ▶ User software ▶ Software tools 	

Professional Services

Consulting and engineering	<ul style="list-style-type: none"> ▶ Risk analysis ▶ Safety concept ▶ Safety design ▶ System integration ▶ Validation ▶ CE services ▶ International conformity assessment ▶ Plant assessment ▶ Inspection of ESPE 	
Training	<ul style="list-style-type: none"> ▶ Seminars ▶ Courses 	



► Why does Pilz offer more?

Because the integrality of our business activities is what sets us apart.



Pilz is a solution supplier for all automation functions. Including standard control functions. Developments from Pilz protect man, machine and the environment. That's why all our experience and knowledge goes into individual products as well as consistently sophisticated system solutions.

- Sensor technology
- Control and communication
- Motion Control
- Operating and monitoring
- Software
- Consulting and engineering
- Training

Appropriate services relating to individual components and independent generic services guarantee that our customers obtain customized automation solutions, all from one source.

Pilz is a family business that's closer to its customers.

Pilz has a tradition as a family-run company stretching back over 50 years.

Real proximity to customers is visible in all areas, instilling confidence through individual consultation, flexibility and reliable service.

We are your contact, guide and competency leader en route to an optimum automation solution.



PNOZ safety relays – The original

Applications worldwide

Every day PNOZ safety relays prove themselves in millions of applications worldwide. With its PNOZ safety relays Pilz is world market leader.

Synonym for safety

In 1987 Pilz developed the first emergency stop relay to protect man and machine. That was a milestone in safety technology. The name PNOZ is now synonymous with safety relays.

For each application

In consultation with our customers we are constantly developing the technology for numerous applications. Our current product portfolio includes the following product ranges:

- ▶ PNOZ X
- ▶ PNOZsigma
- ▶ PNOZelog
- ▶ PNOZmulti
- ▶ PNOZpower

That way you get the optimum safety solution for each requirement!

Contents

▶ Pilz product areas	4
▶ PMDsrange electronic monitoring relays	
- Product range	6
- Selection guide	7
▶ PNOZ product group	
- Product group	8
- Benefits at a glance	10
▶ PNOZ X safety relays	
- Product range	12
- Selection guide	14
- Technical details	16
▶ PNOZsigma safety relays	
- Product range	22
- Selection guide	26
- Technical details	28
▶ PNOZelog safety relays	
- Product range	30
- Selection guide	34
- Technical details	36
▶ Modular safety system PNOZmulti	
- Product range	40
- Selection guide	50
- Technical details	52
▶ Modular safety system PNOZpower	
- Product range	64
- Selection guide	66
- Technical details	68



► Solution supplier for safety and standard

Pilz can offer a universal concept for solutions that can be applied right across industry – safety-related or standard control functions – plant or machine – centralised or decentralised – single product or total solution: With Pilz you will definitely find a solution for your automation function.

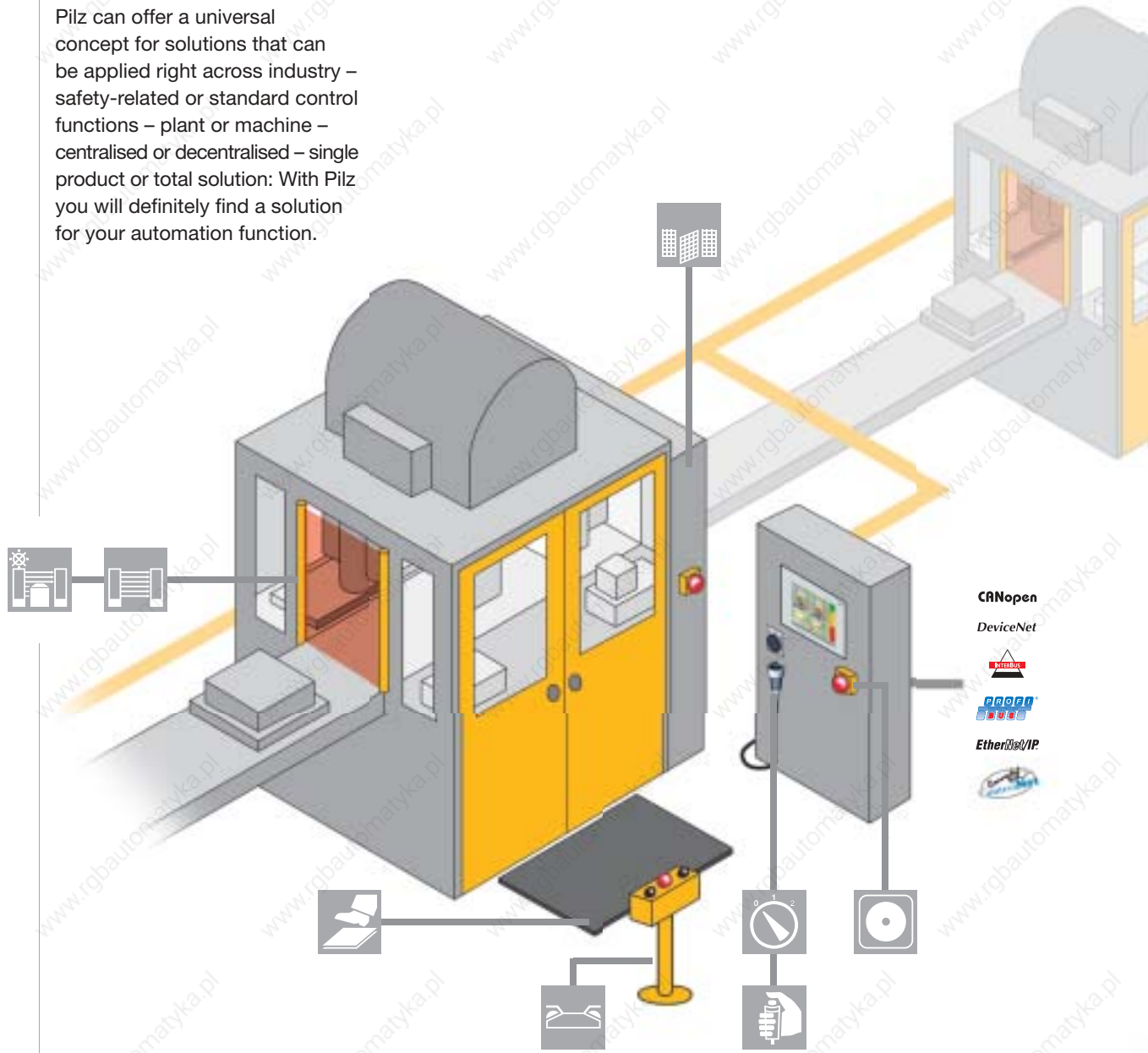

Sensor technology



Operating and monitoring



Electronic monitoring relays PMDsrange



Motion Control

SafetyBUS p[®] The Safe Standard!



- ▶ For electrical safety such as voltage or true power monitoring, electronic PMDSrange monitoring relays provide the optimum solution.
 - ▶ Pilz Motion Control (PMC) represents a flexible, modular and expandable automation system for complex motion and control functions. This automation system manages all the movements of a large number of physically separate servo axes within a plant.
 - ▶ For monitoring E-STOPS, safety gates, light curtains/light barriers, two-hand control and many other functions, we recommend Pilz safe control technology in terms of functional safety. Standard control functions are included.
- For simple plant and machinery with up to 4 safety functions, use the safety relays PNOZ X, PNOZsigma and PNOZelog.
 - To cover 4 to 14 safety functions, the modular safety system PNOZmulti is the most economical solution.
 - On complex machinery or distributed plants, PSS programmable safety and control systems can be used with decentralised networking via SafetyBUS p and SafetyNET p.

Enjoy the benefits of approved, co-ordinated, complete solutions. Our portfolio is being extended to include control and signal devices such as E-STOP pushbuttons, compatible sensor technology such as safety switches, light curtains/light grids and safe camera systems as well as operator terminals for diagnostics and visualisation. A wide range of services round off our business activities.

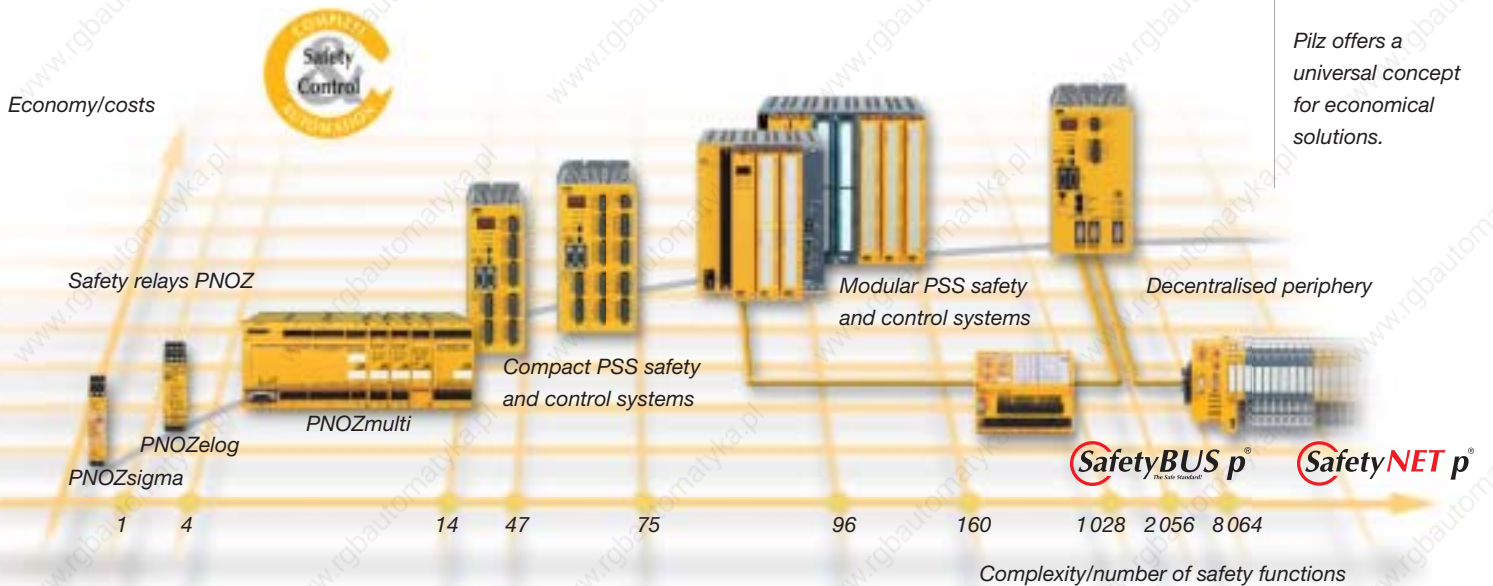



▶ PMDsrange electronic monitoring relays

Taking control of every situation

Reliable, electronic monitoring and control of plant and machinery are the primary focus for our monitoring relays. The units in 22.5 mm slimline housing cover up to 70 different functions.

In addition to current, voltage and insulation monitors, the range also includes relays for true power, phase sequence and thermistor monitoring. Quick and easy installation, practical terminals, a variety of operator elements as well as bright, informative displays all help to make commissioning easier and ensure the units are perfectly tailored to the specific application.

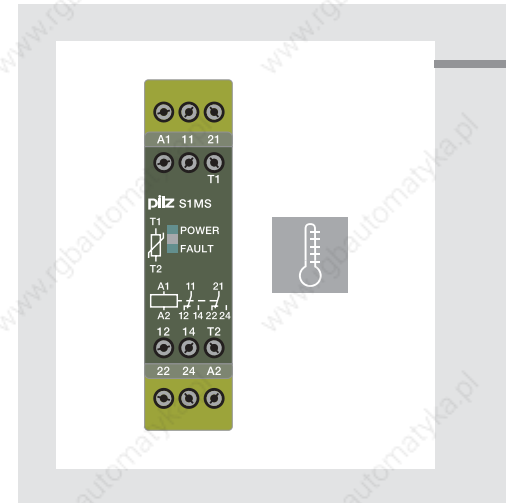

Electronic monitoring relays – PMDsrange

S3UM

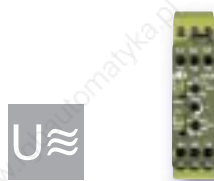

Monitors AC voltages for overvoltage and undervoltage, phase sequence/failure and asymmetry, three-phase

- ▶ Monitors supplies with and without neutral conductors
- ▶ Trip device for undervoltage and overvoltage
- ▶ Evaluates phase sequence
- ▶ Detects asymmetry and phase failure
- ▶ Supply voltage (U_B): AC: 120, 230 V; DC: 24 V
- ▶ Output contacts: 1 auxiliary contact (C/O)
- ▶ Measuring voltage (U_M): AC: 42, 230, 100/110, 400/440, 415/460, 500/550 V, selectable
- ▶ Dimensions (H x W x D): 87 x 22.5 x 122 mm

Order numbers¹⁾:
 24 VDC (U_B),
 230 V AC (U_M) 837 260
 24 VDC (U_B),
 400/440 V AC (U_M) 837 270
 24 VDC (U_B),
 415/460 V AC (U_M) 837 280

S1PN

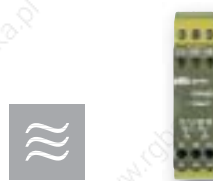

Monitors phase sequence and phase failure on three-phase supplies

- ▶ Measuring voltage up to 690 VAC
- ▶ Detects asymmetry
- ▶ Monitors phase sequence, phase failure, fuse
- ▶ Supply voltage (U_B): AC: 200 ... 240, 400 ... 500, 550 ... 690 V
- ▶ Output contacts: 2 auxiliary contacts (2 C/O)
- ▶ Dimensions (H x W x D): 87 x 22.5 x 122 mm

Order numbers¹⁾:
 200 ... 240 V 890 200
 400 ... 500 V 890 210
 550 ... 690 V 890 220

S1IM

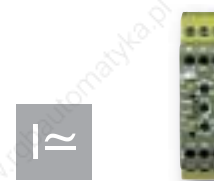

Monitors AC/DC currents for max. current values, single-phase

- ▶ 12 measuring ranges from 0.002 to 15 A, selectable
- ▶ Reaction time can be set up to 10 seconds
- ▶ Either normally energised or normally de-energised mode
- ▶ Galvanic isolation between measuring and supply voltage
- ▶ Supply voltage: 24, 42 ... 48, 110 ... 127, 230 ... 240 V; DC: 24 V
- ▶ Output contacts: 1 auxiliary contact (C/O)
- ▶ Dimensions (H x W x D): 87 x 22.5 x 122 mm

Order numbers¹⁾:
 110 ... 130 VAC (U_B),
 15 A (I_M) 828 040
 230 ... 240 VAC (U_B),
 15 A (I_M) 828 050
 24 VDC (U_B),
 15 A (I_M) 828 035

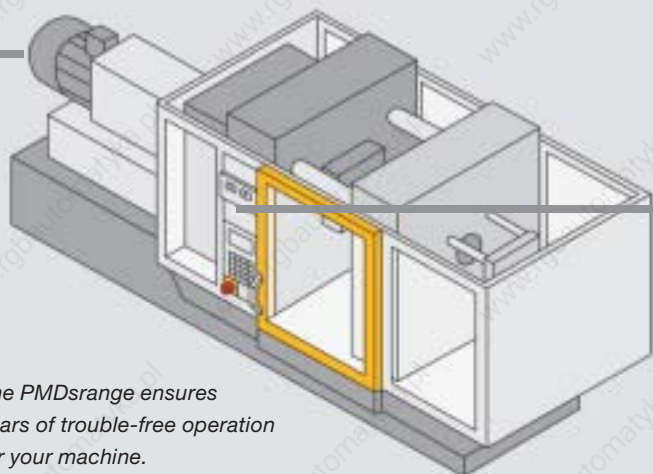

The PMDsrange ensures years of trouble-free operation for your machine.

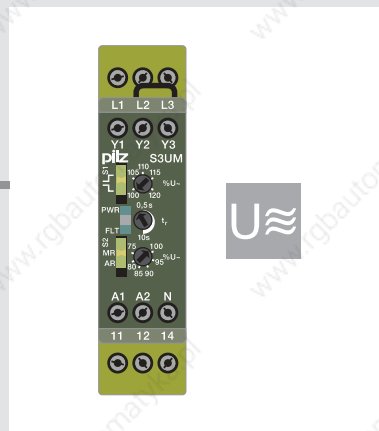

S1EN

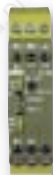

Insulation and fault voltage monitoring of AC/DC supplies, single and three-phase

- ▶ For DC and AC supplies
- ▶ Normally energised mode
- ▶ Fault latching or automatic reset
- ▶ Normal/test mode
- ▶ Supply voltage: 24 ... 240 VAC/DC
- ▶ Output contacts: 1 auxiliary contact (C/O)
- ▶ Rated mains voltage (monitored supply): 50 kΩ version: AC/DC: 0 ... 240 V
200 kΩ version: AC/DC: 0 ... 400 V
- ▶ Dimensions (H x W x D): 87 x 22.5 x 122 mm

Order numbers¹⁾:
24 ... 240 VAC/DC (U_B),
50 kΩ 884 100
24 ... 240 VAC/DC (U_B),
200 kΩ 884 110

S1WP

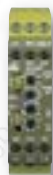

True power monitoring and conversion, DC supplies and single/three-phase AC supplies, relay and analogue output, monitors overload and underload

- ▶ 9 different measuring ranges
- ▶ Large voltage measuring range
- ▶ Analogue output can be switched for current and voltage
- ▶ Relay output for monitoring underload and overload
- ▶ Suitable for use with frequency-controlled motors
- ▶ Supply voltage: DC: 24 V, AC/DC: 230 V
- ▶ Output contacts: 1 auxiliary contact (C/O)
- ▶ Measuring voltage: 3 AC/1 AC/DC: 0 ... 120, 0 ... 240, 0 ... 415, 0 ... 550 V
- ▶ Dimensions (H x W x D): 87 x 22.5 x 122 mm

Order numbers¹⁾:
9 A (I_M), 24 VDC (U_B),
0 ... 240 VAC/DC 890 010
9 A (I_M), 24 VDC (U_B),
0 ... 415 VAC/DC 890 020
9 A (I_M), 24 VDC (U_B),
0 ... 550 VAC/DC 890 030

S1MS

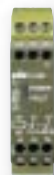

Monitors the temperature of PTC temperature sensors to protect the motor from overheating

- ▶ For DC and AC supplies
- ▶ Normally energised mode
- ▶ Automatic reset
- ▶ Supply voltage: AC: 48, 110, 120, 230, 400 V;
AC/DC: 24 V
- ▶ Output contacts: 2 auxiliary contacts (2 C/O)
- ▶ Dimensions (H x W x D): 87 x 22.5 x 122 mm

Order numbers¹⁾:
24 VAC/DC (U_B) 839 775
230 VAC (U_B) 839 760
400 VAC (U_B) 839 770





▶ PNOZ[®] safety relays

The optimum safety solution for each application! For us, safety is more than just a product. Safe control technology is based on experience and innovation.

We are continually expanding our product range in consultation with our customers. Based on their different features and functionalities, our safety relays

can be divided into the following product ranges:

PNOZ X

- ▶ Customised safety for each function
- ▶ Electromechanical, volt-free
- ▶ AC/DC versions

PNOZsigma

- ▶ Maximum functionality in minimum width
- ▶ Selectable operating modes and times
- ▶ Diagnostics in seconds

PNOZelog

- ▶ Easy to link
- ▶ Non-wearing
- ▶ Extended diagnostics

PNOZmulti

- ▶ Freely configurable
- ▶ Multifunctional
- ▶ Modular safety system

PNOZpower

- ▶ High loads from 8 A to 16 A
- ▶ Switch motor loads directly
- ▶ Modular output contacts

Finding your PNOZ

This diagram will help you choose. You have specific requirements, we have the right solution – the PNOZ product group!

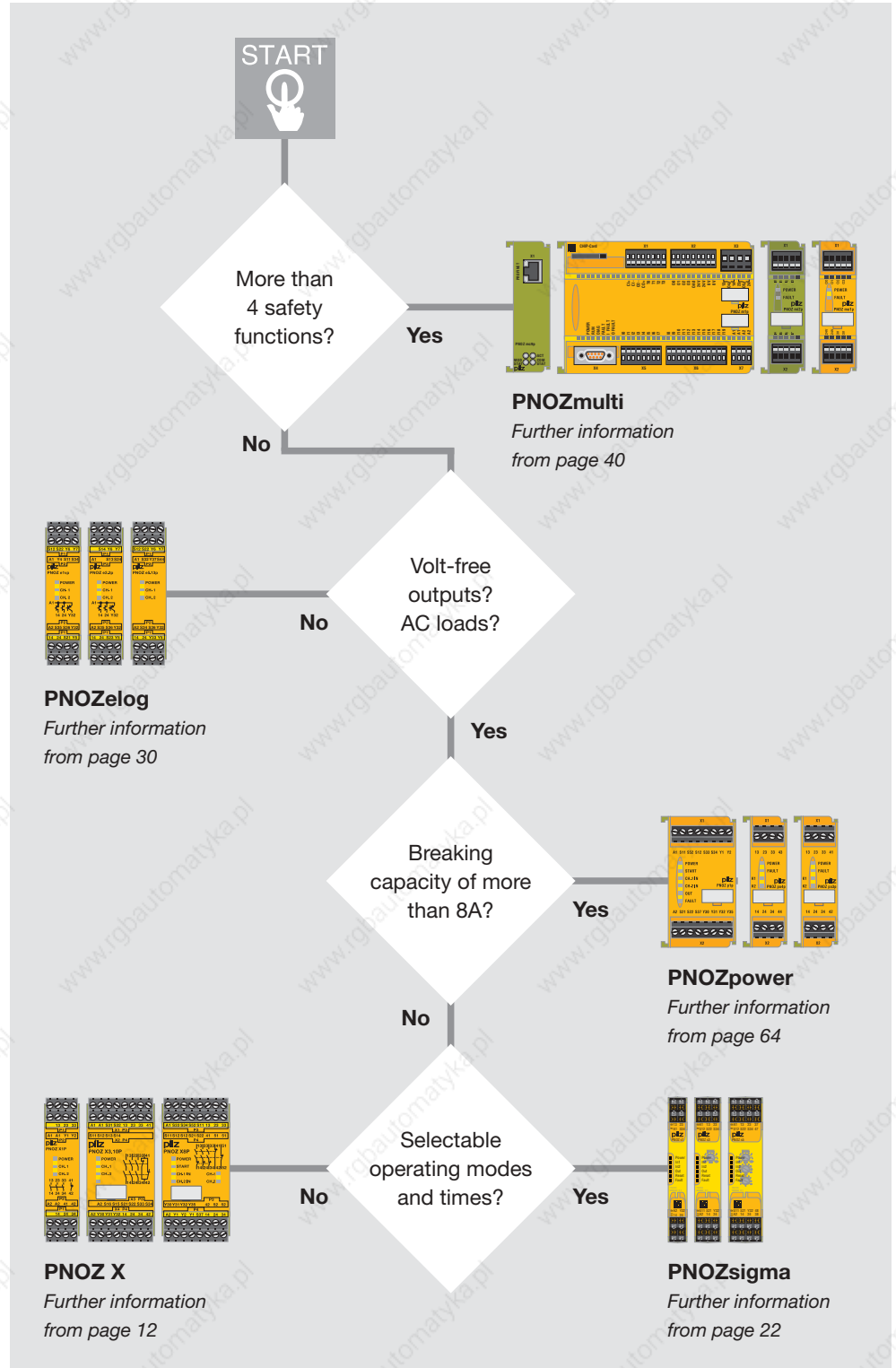



Benefits at a glance
PNOZ product group

► The standard in safe control technology

It pays to use safety technology

The protection of man and machine through the targeted control of hazardous movements, cost savings thanks to fewer accidents, reduced downtimes and fewer production losses – these are real benefits that you can enjoy when you use safe control technology from Pilz.

PNOZ safety relays – Certified worldwide

When using PNOZ safety relays, the aim is to keep the risk to man and machine as low as possible. Internationally co-ordinated statutory instruments have been introduced to ensure that the same level of protection is guaranteed in all countries. Our safety relays comply with these international standards and directives. The PNOZ safety relay has been approved by BG, TÜV and many other notified bodies and offers users considerable benefits. Long service life and high availability ensure it is cost-effective to use.

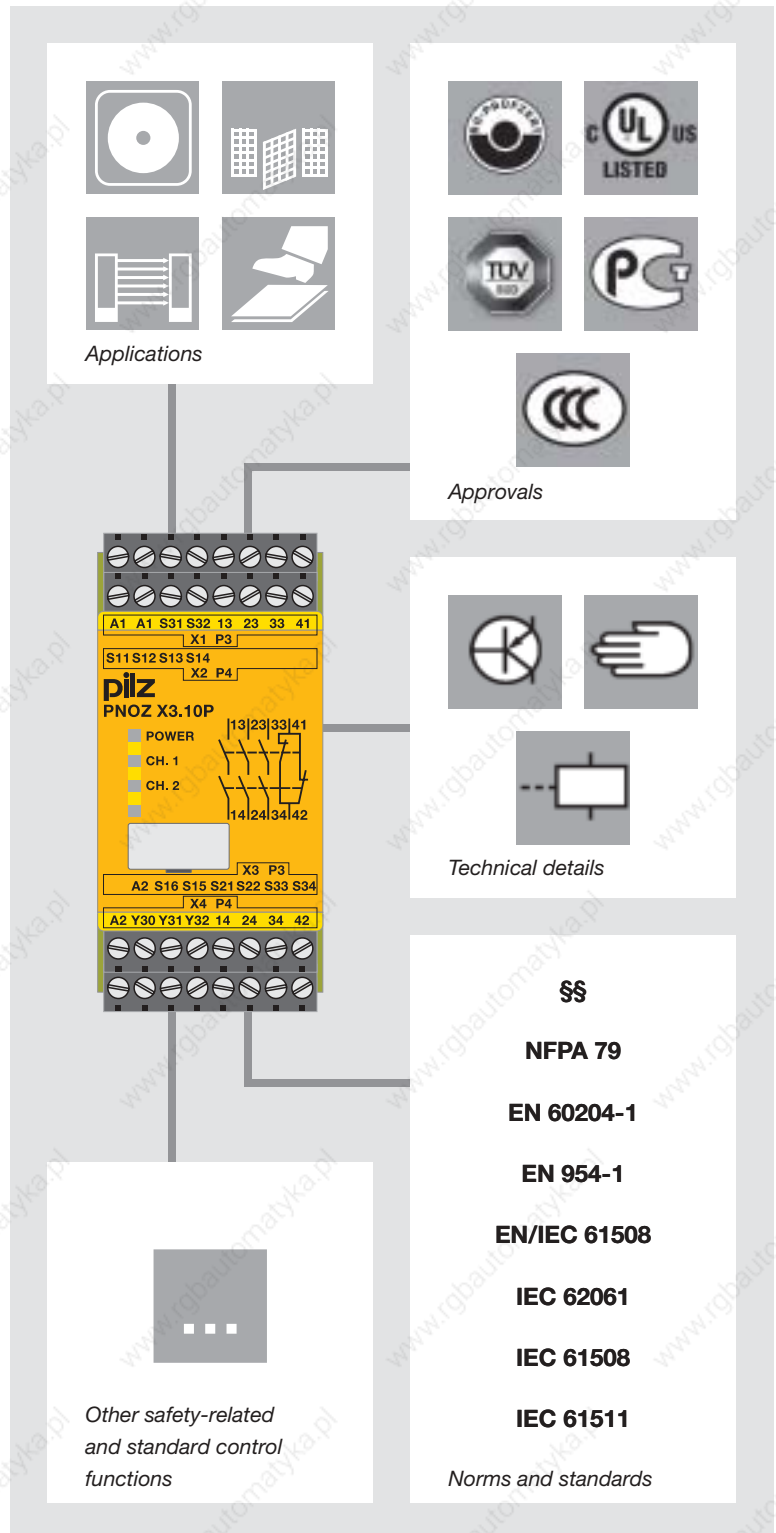

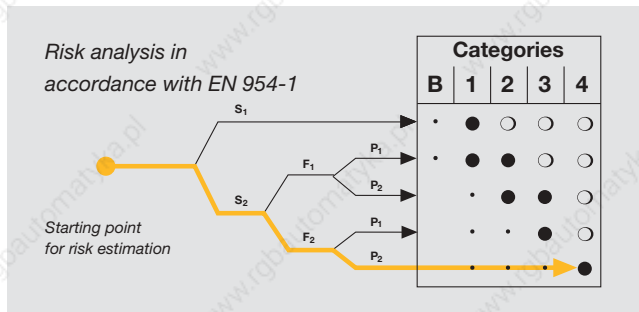

Safety assessment in accordance with EN 954-1

In accordance with the standard EN 954-1, safety requirements in control technology can be divided into five categories. Category 4, for instance, represents the highest risk reduction and protection level, where the safety function must always be maintained.

With PNOZ safety relays you can save yourself the laborious process of wiring contactors when constructing your safety-related circuit – and still enjoy maximum safety, up to and including Category 4 in accordance with EN 954-1.

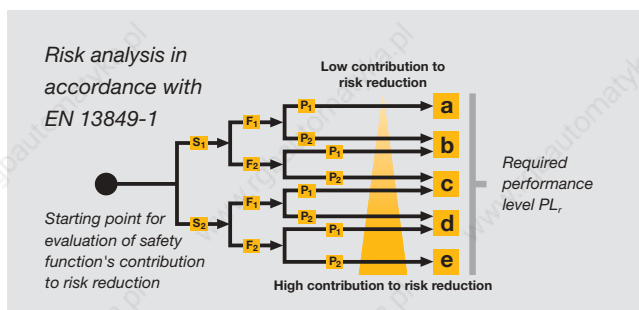

EN ISO 13849-1

As the successor standard to EN 954-1, EN ISO 13849-1 is based on the familiar categories. It also examines complete safety functions, including all the components involved in their design. EN ISO 13849-1 goes beyond

the qualitative approach of EN 954-1 to include a quantitative assessment of the safety functions. A performance level (PL) is used for this, building upon the categories.

Your benefits at a glance

The use of PNOZ safety relays offers you:

- ▶ The security and innovative strength of one of the leading brands in automation technology
- ▶ The appropriate solution for each application
- ▶ High plant availability thanks to user-friendly diagnostics
- ▶ Low downtimes for your plant or machinery
- ▶ Optimum cost/performance ratio
- ▶ Faster commissioning, for example, through units with plug-in terminals
- ▶ Maximum safety with minimum space requirement
- ▶ Simple wiring, fast commissioning
- ▶ A solid partner with expertise
- ▶ Certified safety, because our products comply with international standards and regulations and have been tested and approved worldwide
- ▶ Quality guarantee, we are certified to DIN ISO 9001
- ▶ Use of products that are geared towards the future, thank to innovative developments
- ▶ Complete solution comprising evaluation devices, compatible sensor technology and control and signal devices

Find out more about the standards:

Webcode 0240

Online information at www.pilz.com



▶ PNOZ X safety relays

Customised safety for each application

Safety relays from the PNOZ X product range are proven through their reliability and robustness and have developed a wide application range in the most varied of safety applications. PNOZ is the most widely used safety relay in the world. One PNOZ is used per safety function. Its technical features are based on voltage-free, electromechanical contacts in 2 relay technology. Sizes vary from 22.5 to 90 mm, the number of contacts from two to eight. Whatever your safety requirement – PNOZ X has already proved itself a million times over in the rugged everyday industrial environment – and is certain to be the proven solution for you too.

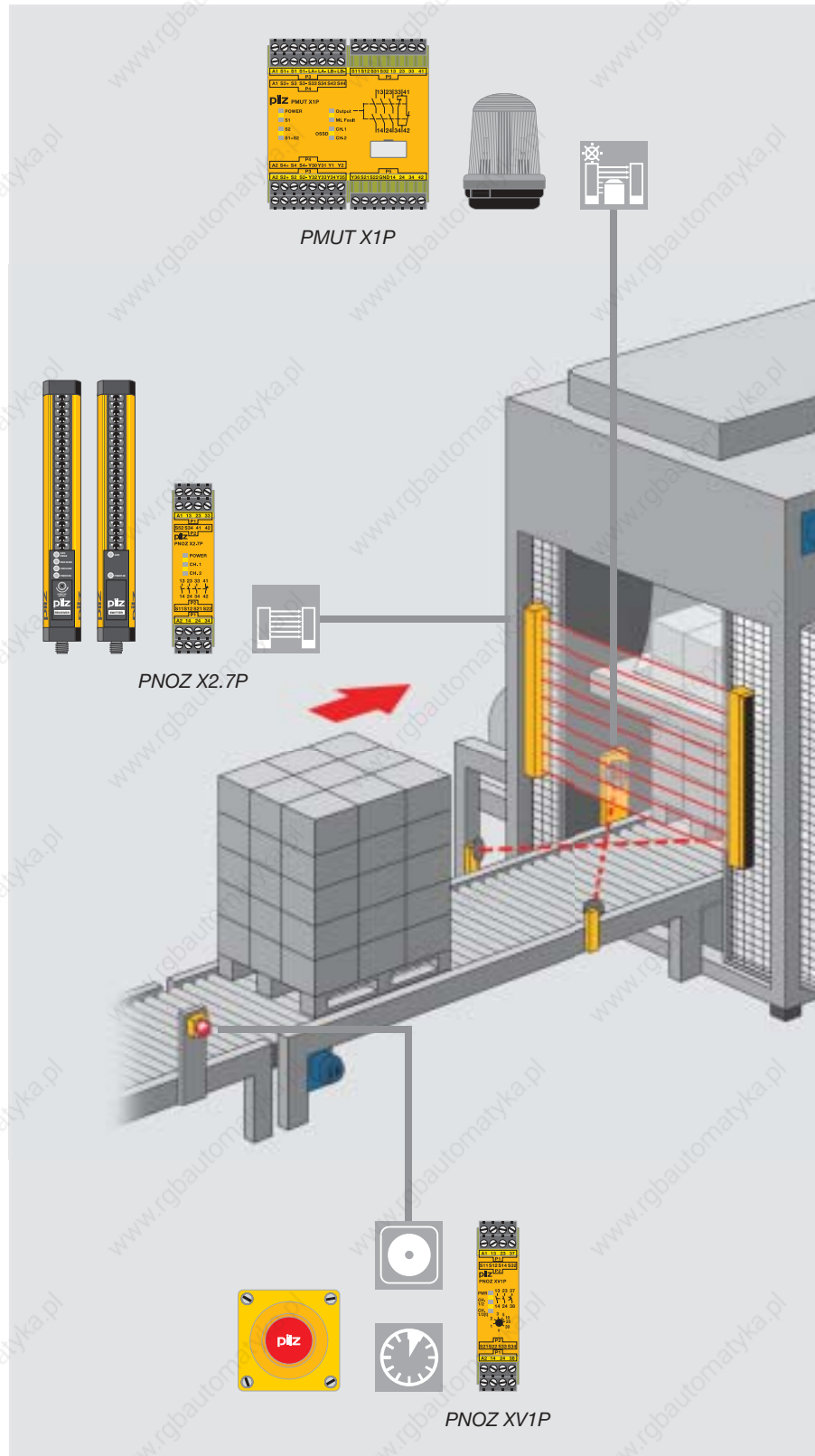

Example: using PNOZ X safety
relays on a packaging machine.

**Benefits at a glance
PNOZ X**

pilz

more than automation
safe automation



Your benefits at a glance

- ▶ Technology proven over many years of use
- ▶ Huge selection of products
- ▶ For all safety functions such as monitoring E-STOPS, safety gates, light beam devices, muting, two-hand control and much more
- ▶ Delayed and instantaneous expander modules, safe timers, safe monitoring relays for standstill, speed and other functions
- ▶ Excellent price/performance ratio
- ▶ Fast commissioning thanks to plug-in terminals with cage clamp and screw connection
- ▶ Maximum safety with minimum space requirement
- ▶ Complete solution comprising evaluation devices, compatible sensor technology and signal devices
- ▶ Low storage costs thanks to universal power supply and plug-in terminals

Keep up-to-date
on PNOZ X
safety relays:







 Webcode 0210

Online information
at www.pilz.com







► Selection guide – PNOZ X

Compact, electromechanical safety relays – PNOZ X

Type	Application						Category (in accordance with EN 954-1)		
							2	3	4
PNOZ X1P	◆	◆					◆		
PNOZ X2P	◆	◆					◆		◆
PNOZ X2.7P	◆	◆	◆				◆	◆	◆
PNOZ X2.8P	◆	◆	◆				◆	◆	◆
PNOZ X3P	◆	◆	◆				◆	◆	◆
PNOZ X7P	◆	◆					◆		
PNOZ X8P	◆	◆	◆				◆	◆	◆
PNOZ X9P	◆	◆	◆				◆	◆	◆
PNOZ X11P	◆	◆	◆				◆	◆	◆
PNOZ XV1P	◆	◆	◆				◆	◆	◆
PNOZ XV3P	◆	◆	◆				◆	◆	◆
PNOZ XV3.1P	◆	◆	◆				◆	◆	◆
PMUT X1P	◆		◆	◆			◆	◆	◆
P2HZ X1P					◆		EN 574, Type IIIC	EN 574, Type IIIC	EN 574, Type IIIC
P2HZ X4P					◆		EN 574, Type IIIC	EN 574, Type IIIC	EN 574, Type IIIC
PSWZ X1P						◆	◆	◆	

Compact, electromechanical safety relays – PNOZ X expander modules

Type	Application						Category (in accordance with EN 954-1)		
							2	3	4
PZE X4P							Depends on base unit		
PZE 9P							Depends on base unit		

Performance Level PL (EN ISO 13849-1)	Safety Integrity Level SIL CL (claim limit in accordance with IEC 62061)	Output contacts				Housing width in mm
		Safe		Non-safe		
d	3	3	-	1	-	22.5
e	3	2	-	-	-	22.5
e	3	3	-	1	-	22.5
e	3	3	-	1	-	22.5
e	3	3	-	1	1	45
d	3	2	-	-	-	22.5
e	3	3	-	2	2	45
e	3	7	-	2	2	90
e	3	7	-	1	2	90
e (d)	3	2	1	-	-	22.5
e (d)	3	3	2	-	-	45
d (e)	3	3	2	1	-	90
e	3	3	-	1	5	90
e	3	3	-	1	2	45
e	3	3	-	1	-	22.5
e	3	2	-	1	1	45

Technical documentation on PNOZ X safety relays:

 Webcode 0685

Online information at www.pilz.com

Performance Level PL (EN ISO 13849-1)	Safety Integrity Level SIL CL (claim limit in accordance with IEC 62061)	Output contacts				Housing width in mm
		Safe		Non-safe		
e	3	4	-	-	-	22.5
e	3	8	-	1	-	90



► Technical details – PNOZ X

Compact, electromechanical safety relays – PNOZ X



PNOZ X1P



PNOZ X2.7P



PNOZ X3P

Type	Supply voltage	Outputs: Voltage/current/ rating	Dimensions in mm (H x W x D)
PNOZ X1P	24 VDC	DC1: 24 V/6 A/150 W	101/94 ¹⁾ x 22.5 x 121
PNOZ X2P	24 VAC/DC 48 ... 240 VAC/DC	DC1: 24 V/6 A/150 W	101/94 ¹⁾ x 22.5 x 121
PNOZ X2.7P PNOZ X2.8P	24 VAC/DC 24 ... 240 VAC/DC	DC1: 24 V/6 A/150 W	101/94 ¹⁾ x 22.5 x 121
PNOZ X3P	24 VAC/DC 24 ... 240 VAC/DC	DC1: 24 V/8 A/200 W	101/94 ¹⁾ x 45 x 122
PNOZ X7P	24 VAC/DC 110 ... 120, 230 ... 240 VAC	DC1: 24 V/6 A/150 W	101/94 ¹⁾ x 22.5 x 121
PNOZ X8P	24 VDC 24, 110, 115, 120, 230 VAC	DC1: 24 V/8 A/200 W	101/94 ¹⁾ x 45 x 121

Features	Order numbers	
	Cage clamp terminals	Plug-in screw terminals
▶ 1-channel operation	787 100	777 100
▶ 2-channel operation with detection of shorts across contacts ▶ Automatic or monitored reset can be selected	24 VAC/DC 787 303 48 ... 240 VAC/DC 787 307	24 VAC/DC 777 303 48 ... 240 VAC/DC 777 307
▶ 2-channel operation with or without detection of shorts across contacts ▶ PNOZ X2.7P: Monitored reset ▶ PNOZ X2.8P: Automatic reset	▶ PNOZ X2.7P C 24 VAC/DC 787 305 24 ... 240 VAC/DC 787 306 ▶ PNOZ X2.8P C 24 VAC/DC 787 301 24 ... 240 VAC/DC 787 302	▶ PNOZ X2.7P 24 VAC/DC 777 305 24 ... 240 VAC/DC 777 306 ▶ PNOZ X2.8P 24 VAC/DC 777 301 24 ... 240 VAC/DC 777 302
▶ 2-channel operation with or without detection of shorts across contacts ▶ Monitored or automatic reset can be selected ▶ 1 semiconductor output ▶ Safety gate function with N/C / N/O combination	24 VAC/DC 787 310 24 ... 240 V AC/DC 787 313	24 VAC/DC 777 310 24 ... 240 V AC/DC 777 313
▶ 1-channel operation	24 VAC/DC 787 059 More available on request	24 VAC/DC 777 059 More available on request
▶ 2-channel operation with or without detection of shorts across contacts ▶ Monitored or automatic reset can be selected ▶ 2 semiconductor outputs	24 VAC 787 770 24 VDC 787 760 More available on request	24 VAC 777 770 24 VDC 777 760 More available on request

¹⁾ Height with cage clamp terminals/plug-in screw terminals



Technical documentation on PNOZ X safety relays:

Webcode 0685

Online information at www.pilz.com



► Technical details – PNOZ X

Compact, electromechanical safety relays – PNOZ X



PNOZ X9P



PNOZ XV1P



PNOZ XV3P

Type	Supply voltage	Outputs: Voltage/current/ rating	Dimensions in mm (H x W x D)
PNOZ X9P	24 VDC 24 VDC, 100 ... 240 VAC	DC1: 24 V/8 A/200 W	101/94 ¹⁾ x 90 x 121
PNOZ X11P	24 VDC, 24 VAC 110 ... 120, 230 ... 240 VAC	DC1: 24 V/8 A/200 W	101/94 ¹⁾ x 90 x 121
PNOZ XV1P	24 VDC	DC1: 24 V/5 A/125 W	101/94 ¹⁾ x 22.5 x 121
PNOZ XV3P	24 VDC	DC1: 24 V/8 A/200 W	101/94 ¹⁾ x 45 x 121
PNOZ XV3.1P	24 VDC 24 ... 240 VAC/DC	DC1: 24 V/8 A/200 W	101/94 ¹⁾ x 90 x 121

Features	Order numbers	
	Cage clamp terminals	Plug-in screw terminals
<ul style="list-style-type: none"> ▶ 2-channel operation with or without detection of shorts across contacts ▶ Monitored or automatic reset can be selected ▶ 2 semiconductor outputs 	24 VDC 787 609 24 VDC, 100 ... 240 VAC 787 606	24 VDC 777 609 24 VDC, 100 ... 240 VAC 777 606
<ul style="list-style-type: none"> ▶ 2-channel operation with or without detection of shorts across contacts ▶ Monitored or automatic reset can be selected ▶ 2 semiconductor outputs 	24 VDC, 24 VAC 787 080 110 ... 120 VAC 787 083 230 ... 240 VAC 787 086	24 VDC, 24 VAC 777 080 110 ... 120 VAC, 24 VDC 777 083 230 ... 240 VAC, 24 VDC 777 086
<ul style="list-style-type: none"> ▶ 2-channel operation with or without detection of shorts across contacts ▶ Monitored or automatic reset can be selected 	0.1 ... 3 s 787 601 1 ... 30 s 787 602	0.1 ... 3 s 777 601 1 ... 30 s 777 602
<ul style="list-style-type: none"> ▶ 2-channel operation with or without detection of shorts across contacts ▶ Monitored or automatic reset can be selected 	3 s 787 512 30 s 787 510 More available on request	3 s 777 512 30 s 777 510 More available on request
<ul style="list-style-type: none"> ▶ 2-channel operation with or without detection of shorts across contacts ▶ Monitored or automatic reset can be selected ▶ Universal power supply 24 ... 240 VAC/DC 	3 s selectable, 24 ... 240 VAC/DC 787 532 30 s selectable, 24 ... 240 VAC/DC 787 530 More available on request	3 s selectable, 24 ... 240 VAC/DC 777 532 30 s selectable, 24 ... 240 VAC/DC 777 530 More available on request

¹⁾ Height with cage clamp terminals/plug-in screw terminals



Technical documentation on PNOZ X safety relays:

Webcode 0685

Online information at www.pilz.com



► Technical details – PNOZ X

Compact, electromechanical safety relays – PNOZ X



PMUT X1P



PSWZ X1P



PZE X4P

Type	Supply voltage	Outputs: Voltage/current/ rating	Dimensions in mm (H x W x D)
PMUT X1P	24 VDC	DC1: 24 V/8 A/200 W	101/94 ¹⁾ x 90 x 121
P2HZ X1P	24 VDC 24, 42, 48 110, 115, 120, 230, 240 VAC	DC1: 24 V/2 A/50 W	101/94 ¹⁾ x 45 x 122
P2HZ X4P	24 VAC/DC	DC1: 24 V/5 A/125 W	101/94 ¹⁾ x 22.5 x 121
PSWZ X1P	24 ... 240 VAC/DC	DC1: 24 V/6 A/150 W	101/94 ¹⁾ x 45 x 122
PZE X4P	24 VDC	DC1: 24 V/5 A/120 W	101/94 ¹⁾ x 22.5 x 122
PZE 9P	24 VAC/DC 100 ... 240 VAC	DC1: 24 V/8 A/200 W	101/94 ¹⁾ x 90 x 121

Features	Order numbers	
	Cage clamp terminals	Plug-in screw terminals
<ul style="list-style-type: none"> ▶ Up to 4 muting sensors ▶ Monitors and switches muting lamps ▶ Parallel and serial muting ▶ Simultaneity monitoring ▶ 5 semiconductor outputs ▶ Reset input ▶ "Override" function via key switch in the case of a fault ▶ LED status indicators 	788 010	778 010
▶ 2 semiconductor outputs	24 VDC 787 340 More available on request	24 VDC 777 340 More available on request
▶ 22.5 mm width	24 VAC 787 354 24 VAC 787 355	24 VAC 777 354 24 VAC 777 355
<ul style="list-style-type: none"> ▶ Safe standstill monitoring ▶ 1 or 2-channel operation ▶ No external components required ▶ Fault signal if simultaneity time is exceeded ▶ Reset input ▶ Detects open circuits 	U _M : 0.5 V 787 949 U _M : 3 V 787 950	U _M : 0.5 V 777 949 U _M : 3 V 777 950
▶ 1-channel operation	787 585	777 585
<ul style="list-style-type: none"> ▶ Diverse structure ▶ 2-channel operation with ability to detect shorts across contacts 	24 VAC/DC 787 140 100 ... 240 VAC 787 148	24 VAC/DC 777 140 100 ... 240 VAC 777 148

¹⁾ Height with cage clamp terminals/plug-in screw terminals



Technical documentation on PNOZ X safety relays:

Webcode 0685

Online information at www.pilz.com



► Compact safety relays PNOZsigma

Maximum functionality in minimum width

The new compact safety relays PNOZsigma combine many years of experience with today's very latest safety technology: you can achieve maximum safety and cost-effectiveness with minimum effort.

All round efficiency – from planning to service

With particularly narrow housing widths and multifunctionality compressed into each unit, PNOZsigma provides maximum functionality in minimum width. Use safety technology that

- ▶ saves more space,
- ▶ is more flexible,
- ▶ is quicker,
- ▶ and therefore more efficient.

*PNOZsigma
brings maximum
efficiency – from
planning to service.*

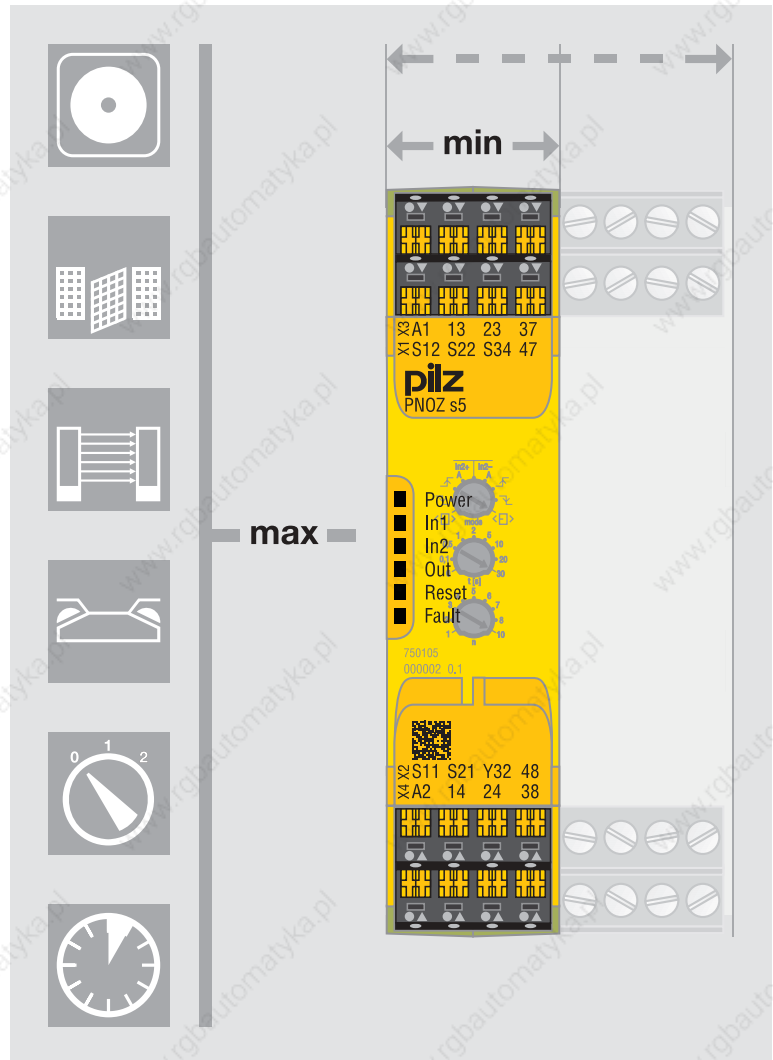

Up to 50 % space saving

- ▶ Widths from 12.5 mm
- ▶ Housings up to 50 % narrower with the same functionality¹⁾
- ▶ Reduced space requirement in the control cabinet saves costs

¹⁾ Compared with standard electromechanical safety relays on the market

Benefits at a glance PNOZsigma

Rapid commissioning and expansion thanks to innovative connection technology

- ▶ Just “click” to expand the contacts via a plug-in connection
- ▶ Plug-in connection terminals
- ▶ Innovative spring-loaded technology
- ▶ Reduces wiring by up to 20 %

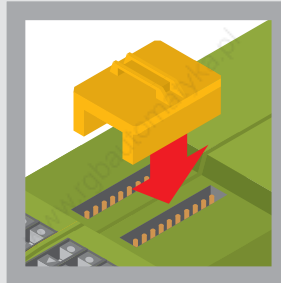
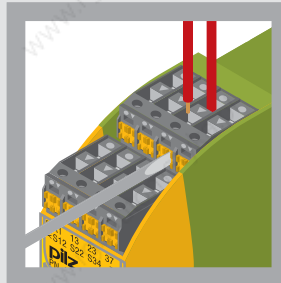

Your benefits at a glance

- ▶ Up to 50 % space saving in the control cabinet
- ▶ Rapid commissioning and expansion
- ▶ High availability and diagnostics in seconds
- ▶ Few unit types covering many safety functions

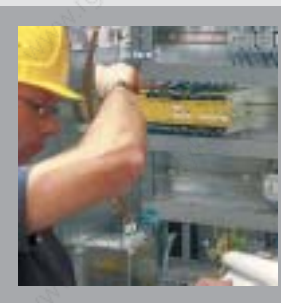
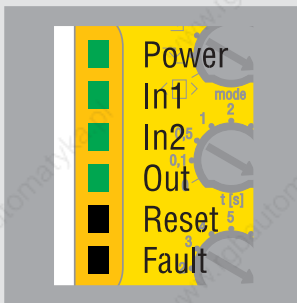

Fewer types – suitable for a variety of uses

- ▶ Selectable operating modes and timers enable each unit to be flexible in its application
- ▶ A single unit type monitors different safety functions
- ▶ Your stockholding can be reduced to a few unit types

High plant availability and long service life

- ▶ Rapid diagnostics at a glance
- ▶ 6 descriptive LEDs
- ▶ High switching capabilities up to 12 A
- ▶ Safe switching even of the smallest loads from 10 mA

Keep up-to-date
on PNOZsigma
safety relays:

 Webcode 0994

Online information
at www.pilz.com



► The sum of our experience – PNOZsigma

Selectable operating modes for maximum flexibility

- ▶ Selectable reset modes: manual reset, automatic reset, monitored reset or reset with start-up test
- ▶ Selectable operating mode: With or without detection of shorts across contacts
- ▶ Selectable time delay: from 0 ... 300 seconds – via value and factor
- ▶ Selectable timer function: delay-on energisation, delay-on de-energisation, pulsing

6 LEDs for diagnostics in seconds

- ▶ Display switch and fault status: Power, In1, In2, Out, Reset and Fault
- ▶ Identical on each PNOZsigma
- ▶ No external measuring devices are required

Homogenous functional setup for rapid engineering

- ▶ Standardised operator elements on each PNOZsigma
- ▶ Identical terminal designation and positioning
- ▶ Rapid allocation during configuration, installation and diagnostics

Contact expansion via connectors

- ▶ Quick and easy
- ▶ No wiring involved whatsoever

New spring-loaded technology

- ▶ Proven screwless terminal technology
- ▶ With 2 terminal chambers per terminal point
- ▶ For rapid wiring and a secure hold through the cage clamp
- ▶ The opening for the two terminal chambers may be separate or joint
- ▶ Wire may be removed individually

Spring clip for top-hat rail assembly

- ▶ Rapid assembly, housing simply clips on and off
- ▶ No need for tools



Wiring reduced by 20%:
Contact expansion
via connectors

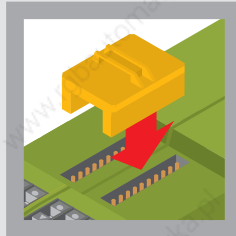

Rapid installation: new –
innovative spring-loaded
terminals, chambers operated
individually

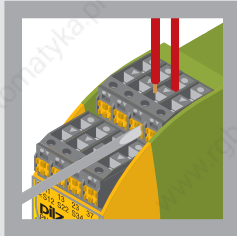

Simple configuration:
all unit versions have a
standardised terminal
designation/position



Maximum flexibility:
Selectable operating
modes and timer functions

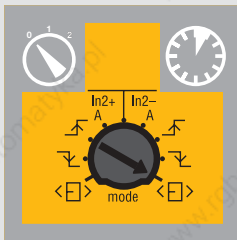

Rapid assembly via
spring clips: no need
for tools

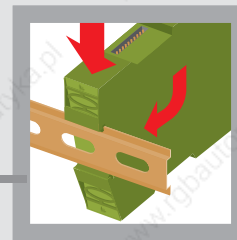

Diagnostics in seconds:
via 6 LEDs – no external
measuring devices
required

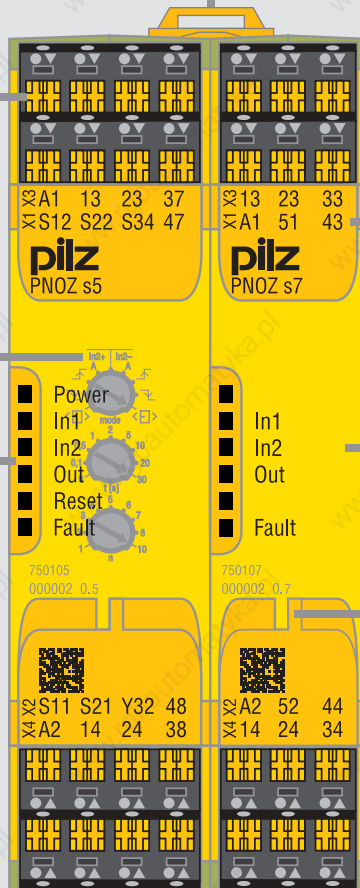
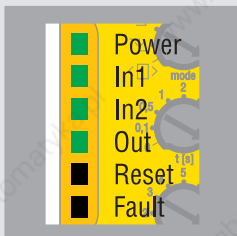



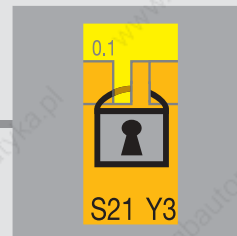

Safe from manipulation:
setting elements have
a lockable cover









▶ Selection guide – PNOZsigma

Compact safety relays – PNOZsigma

Type	Application	Category (in accordance with EN 954-1)	Performance Level PL (EN ISO 13849-1)
	    		
PNOZ s1	◆ ◆	2	d
PNOZ s2	◆ ◆	2	d
PNOZ s3	◆ ◆ ◆	4	e
PNOZ s4	◆ ◆ ◆	4	e
PNOZ s5	◆ ◆ ◆ ◆	4	e
PNOZ s6		◆	EN 574, Type IIIC
PNOZ s6.1		◆	EN 574, Type IIIA
PNOZ s7	Contact expansion	Depends on base unit	Depends on base unit
PNOZ s8	Contact expansion	Depends on base unit	Depends on base unit
PNOZ s9	Contact expansion or safe timer relay	◆	Depends on base unit as timer Cat. 4
PNOZ s10	Contact expansion	◆	Depends on base unit

Safety Integrity Level SIL CL (claim limit in accordance with IEC 62061)	Output contacts				Universal power supply 48 ... 240 VAC/DC	Housing width in mm
	Safe		Auxiliary contacts			
						
2	2	-	-	1		12.5
3	3	-	1	1		17.5
3	2	-	-	1		17.5
3	3	-	1	1	◆	22.5
3	2	2	-	1	◆	22.5
3	3	-	1	1	◆	22.5
3	3	-	1	1	◆	22.5
Depends on base unit	4	-	1	-		17.5
Depends on base unit	2	-	-	1		12.5
Depends on base unit as timer SIL3	-	3	1	-		17.5
Depends on base unit	4	-	1	-		45.0

Technical documentation on PNOZsigma safety relays:

 Webcode 0685

Online information at www.pilz.com



► Technical details – PNOZsigma

Compact safety relays – PNOZsigma



PNOZ s1



PNOZ s3



PNOZ s5



PNOZ s10

Type	Dimensions (H x W x D) in mm	Supply voltage (U _B)	Outputs: Voltage/current/ rating
PNOZ s1	95 x 12.5 x 122	24 VDC	DC1: 24 V/3 A/75 W
PNOZ s2	95 x 17.5 x 122	24 VDC	DC1: 24 V/8 A/200 W
PNOZ s3	95 x 17.5 x 122	24 VDC	DC1: 24 V/8 A/200 W
PNOZ s4	95 x 22.5 x 122	24 VDC, 48 ... 240 VAC/DC	DC1: 24 V/8 A/200 W, DC1: 24 V/6 A/150 W
PNOZ s5	95 x 22.5 x 122	24 VDC, 48 ... 240 VAC/DC	DC1: 24 V/6 A/150 W
PNOZ s6	95 x 22.5 x 122	24 VDC, 48 ... 240 VAC/DC	DC1: 24 V/8 A/200 W, DC1: 24 V/6 A/150 W
PNOZ s6.1	95 x 22.5 x 122	24 VDC, 48 ... 240 VAC/DC	DC1: 24 V/8 A/200 W, DC1: 24 V/6 A/150 W
PNOZ s7	95 x 17.5 x 122	24 VDC	DC1: 24 V/8 A/200 W
PNOZ s8	95 x 12.5 x 122	24 VDC	DC1: 24 V/3 A/75 W
PNOZ s9	95 x 17.5 x 122	24 VDC	DC1: 24 V/8 A/200 W
PNOZ s10	95 x 45.0 x 122	24 VDC	DC1: 24 V/12 A/300 W

Features	Order numbers	
	Spring-loaded terminals	Plug-in screw terminals
<ul style="list-style-type: none"> ▶ 1-channel operation ▶ Manual/automatic reset 	24 VDC751 101	24 VDC750 101
<ul style="list-style-type: none"> ▶ 1-channel operation ▶ Monitored reset ▶ Manual/automatic reset ▶ Safe separation 	24 VDC751 102	24 VDC750 102
<ul style="list-style-type: none"> ▶ 1 and 2-channel operation ▶ Detection of shorts across contacts ▶ Monitored reset ▶ Manual/automatic reset ▶ Start-up test 	24 VDC751 103	24 VDC750 103
<ul style="list-style-type: none"> ▶ 1 and 2-channel operation ▶ Detection of shorts across contacts ▶ Monitored reset ▶ Manual/automatic reset ▶ Start-up test 	24 VDC751 104 48 ... 240 VAC/DC.....751 134	24 VDC750 104 48 ... 240 VAC/DC.....750 134
<ul style="list-style-type: none"> ▶ 1 and 2-channel operation ▶ Detection of shorts across contacts ▶ Monitored reset ▶ Manual/automatic reset ▶ Start-up test ▶ Timer functions: delay-on de-energisation ▶ Time range: 0 ... 300 sec. 	24 VDC751 105 48 ... 240 VAC/DC.....751 135	24 VDC750 105 48 ... 240 VAC/DC.....750 135
<ul style="list-style-type: none"> ▶ 2-channel operation ▶ Detection of shorts across contacts 	24 VDC751 106 48 ... 240 VAC/DC.....751 136	24 VDC750 106 48 ... 240 VAC/DC.....750 136
<ul style="list-style-type: none"> ▶ 2-channel operation ▶ Detection of shorts across contacts 	24 VDC751 126 48 ... 240 VAC/DC.....751 156	24 VDC750 126 48 ... 240 VAC/DC.....750 156
<ul style="list-style-type: none"> ▶ Safe separation 	24 VDC751 107	24 VDC750 107
	24 VDC751 108	24 VDC750 108
<ul style="list-style-type: none"> ▶ Safe separation ▶ Timer functions: delay-on energisation, delay-on de-energisation, pulsing, retriggerable ▶ Time range: 0 ... 300 sec. 	24 VDC751 109	24 VDC750 109
<ul style="list-style-type: none"> ▶ Safe separation 	24 VDC751 110	24 VDC750 110



Technical
documentation
on PNOZsigma
safety relays:

Webcode 0685

Online information
at www.pilz.com



▶ PNOZelog electronic safety relays

Extended diagnostics, easy to link

Ideal for monitoring up to four safety functions, the innovative PNOZelog product range combines the experience of the electromechanical safety relays with the benefits of modern electronics. Wear-resistance, safety, long service life and high availability ensure it is cost-effective to use. PNOZelog is also easy to link through logic AND/OR operations. Diagnostics on the PNOZelog have been extended. Power-up tests, self-checking and runtime tests guarantee maximum safety.

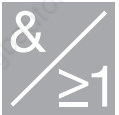

PNOZelog can be linked through logic AND/OR operations.

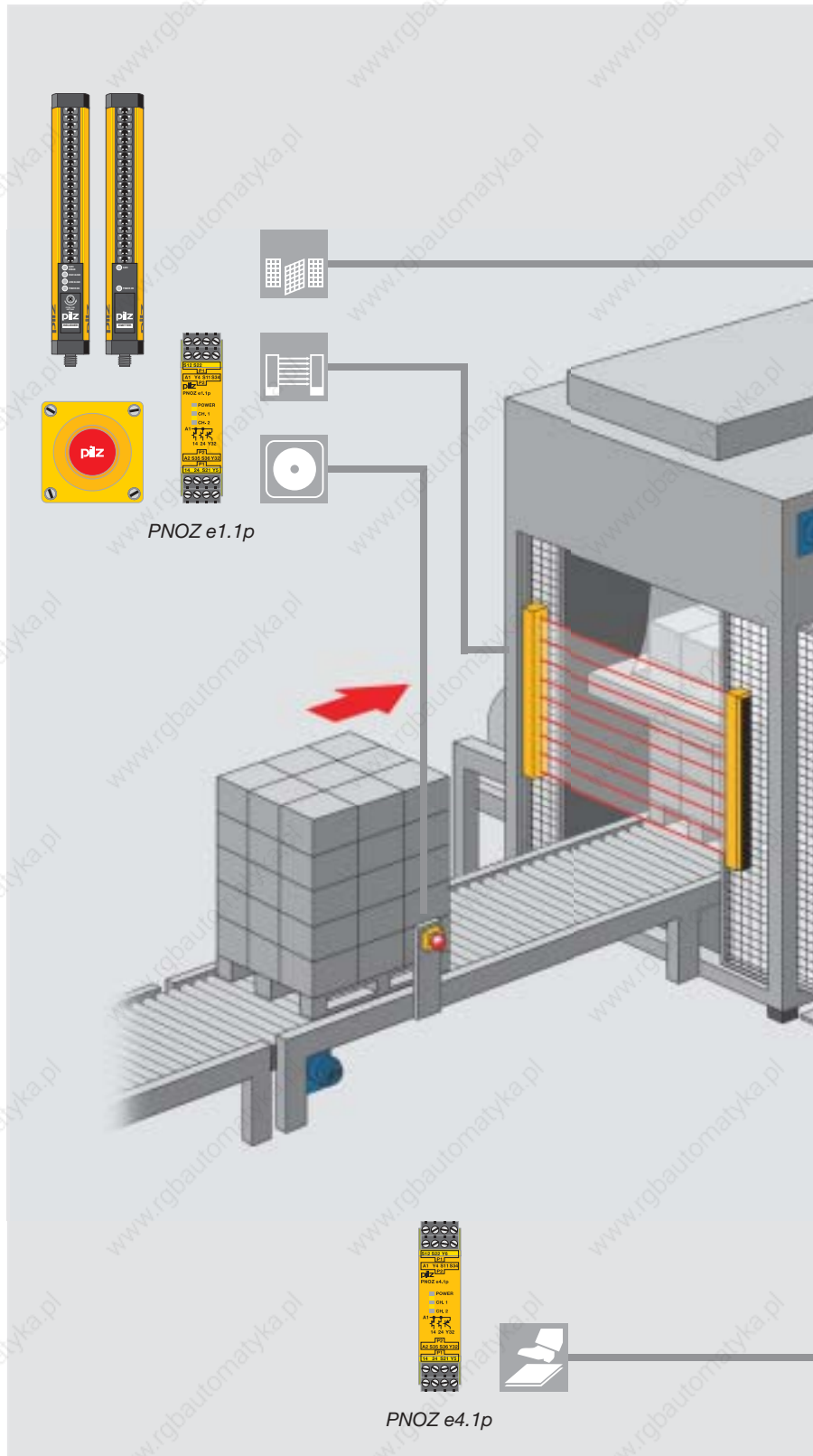

Example: using PNOZelog safety relays on a packaging machine.

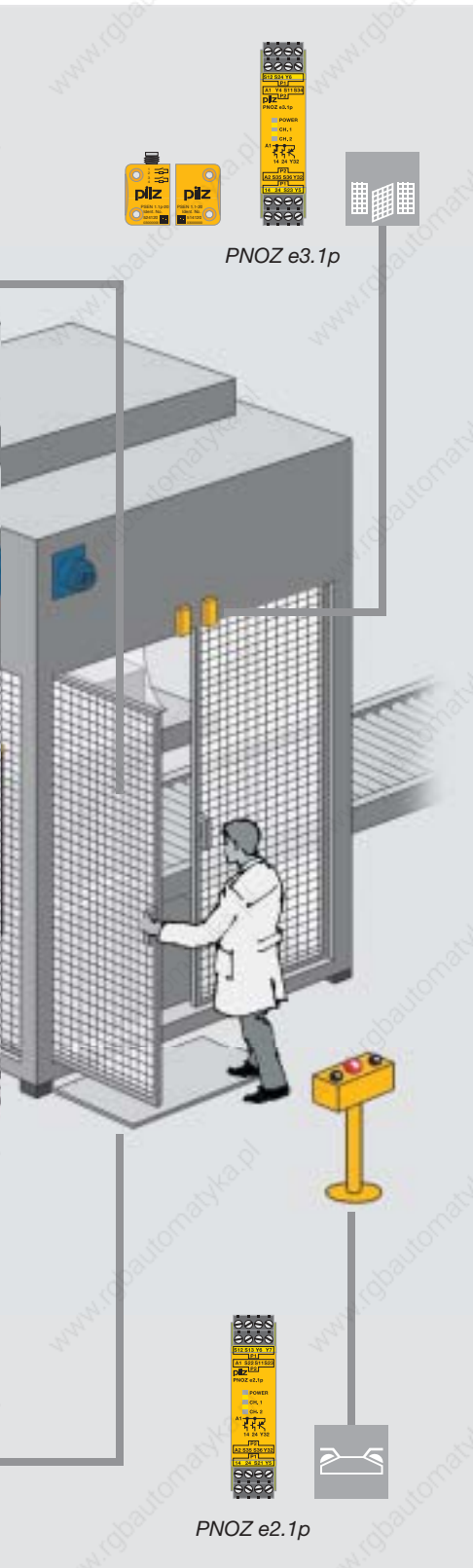

PNOZ e3.1p

PNOZ e2.1p

Solid-state safety

The PNOZelog product range is designed in accordance with failsafe technology to Category 4 of EN 954-1.

PNOZelog uses semiconductor technology and is therefore resistant to shock and vibration, making it suitable for use on mobile applications where there is a lot of vibration, for example. The use of modern electronics ensures the units are durable and maintenance-free.

PNOZelog with relay outputs

Two new versions, the PNOZ e6.1p and the PNOZ e6vp with time delay, integrate safe, non-wearing semi-conductor outputs and robust, volt-free relay outputs within a single unit. Your benefit: Saves on wiring!

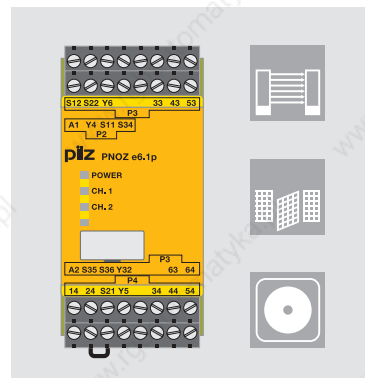

Your benefits at a glance

- ▶ Less wiring thanks to simple logic operations (AND/OR)
- ▶ High availability thanks to extended diagnostics
- ▶ Consistent use of semiconductor technology means no maintenance is necessary – there are no malfunctions due to contact welding, contamination, bounce or burning
- ▶ Continuous self-checks provide the highest level of safety – fault detection is not linked to the on/off cycle
- ▶ Long service life, even with frequent operations or cyclical functions
- ▶ Safe switching operations even on the smallest of loads
- ▶ Fast commissioning; plug-in terminals with cage clamp and screw connection mean that no additional tools are required
- ▶ Complete solution comprising evaluation devices, compatible sensor technology and control and signal devices

Keep up-to-date
on PNOZelog
safety relays:

Webcode 0209

Online information
at www.pilz.com

PNOZelog now available
with volt-free relay outputs!



▶ PNOZelog electronic safety relays

“2-in-1” – the bifunctional PNOZelog

Do you require E-STOP or safety gate monitoring within a compact safety unit? Monitor two safety functions simultaneously with just a single unit. You save on wiring. With a width of just 22.5 mm, the space requirement within the control cabinet is reduced to a minimum. Maximum functionality

Fewer downtimes thanks to extended diagnostics.

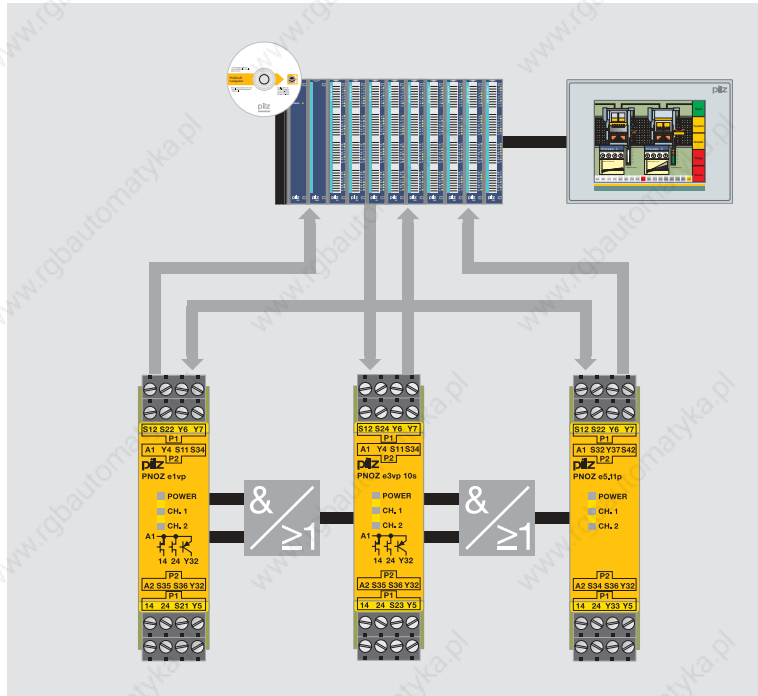

Easy-to-use diagnostics make the unit cost-effective

PNOZelog has extensive diagnostic options:

- ▶ Simple LED indicators and status output enable the easiest possible on-site diagnostics, without additional tools.
- ▶ Integral diagnostic PLC interface for all common PLC systems. Drivers are available. Internal and external faults are detected, such as shorts across contacts or wiring errors.

- ▶ Where several PNOZelog units are linked, all you need is one PLC output and one PLC input for each unit that you use. The device status plus faults in the input and output circuit are detected and signalled to the PLC system.

The detailed information that is gained about the products' system status reduces machine downtimes and enables any potential error sources to be removed immediately.

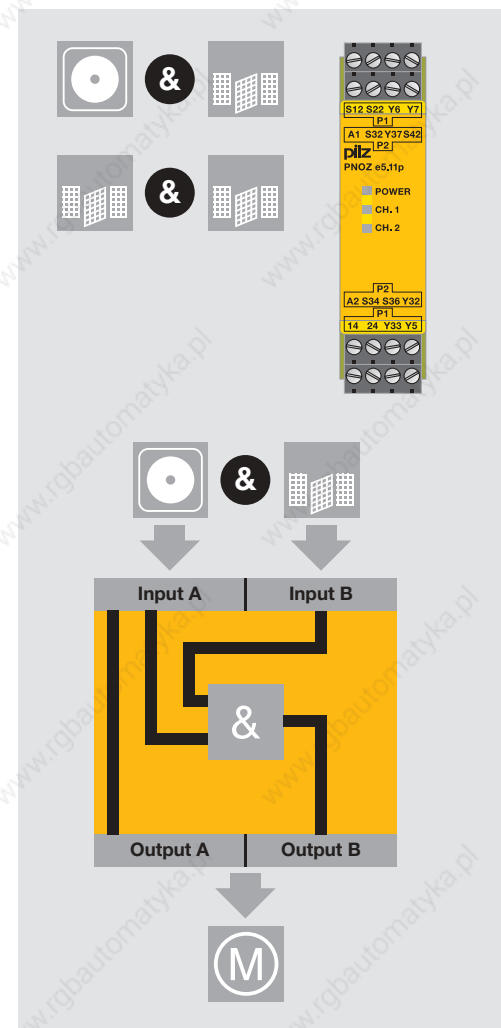

is achieved through the internal logic AND operation. Each safety function has a separate signal output.

- ▶ PNOZ e5.11p simultaneously monitors an E-STOP/safety gate combination or two safety gates
- ▶ The PNOZ e5.13p can also be connected to the PSENmag safety switches

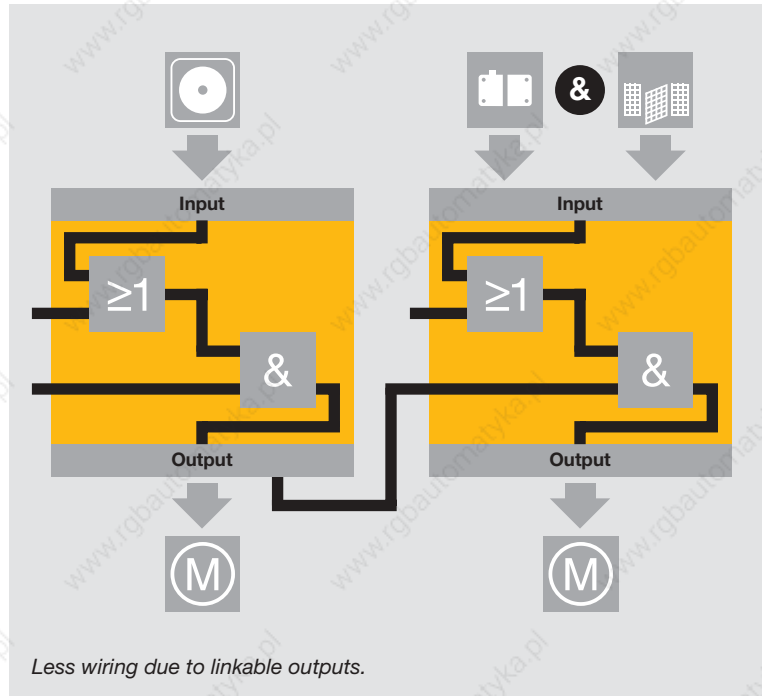

Complete safety functions through logic function links

Units in the PNOZelog product range can be linked via logic operations to form complete safety functions. AND/OR operations are both available.

The use of logic functions means that the output requires no additional wiring.

Both outputs on the PNOZelog units are available. As many units as necessary can be connected in series – ideal for monitoring up to four safety functions.

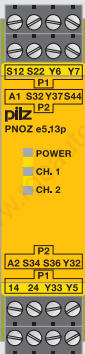





A bifunctional PNOZelog – Minimum space, maximum functionality.







As a result of the internal logic AND operation, two safety functions can be covered simultaneously – with just a single unit!



▶ Selection guide – PNOZelog

Compact, electronic safety relays – PNOZelog

Type	Application					Category (in accordance with EN 954-1)		
						2	3	4
PNOZ e1p	◆	◆	◆			◆	◆	◆
PNOZ e1.1p	◆	◆	◆			◆	◆	◆
PNOZ e1vp	◆	◆	◆			◆	◆	◆
PNOZ e2.1p				◆		EN 574, Type IIIC	EN 574, Type IIIC	EN 574, Type IIIC
PNOZ e2.2p				◆		EN 574, Type IIIA	EN 574, Type IIIA	EN 574, Type IIIA
PNOZ e3.1p		◆				◆	◆	◆
PNOZ e3vp		◆				◆	◆	◆
PNOZ e4.1p					◆		◆	
PNOZ e4vp					◆		◆	
PNOZ e5.11p	◆	◆				◆	◆	
PNOZ e5.13p	◆	◆				◆	◆	
PNOZ e6.1p	◆	◆	◆			◆	◆	◆
PNOZ e6vp	◆	◆	◆			◆	◆	◆

Performance Level PL (EN ISO 13849-1)	Safety Integrity Level SIL CL (claim limit in accordance with IEC 62061)	Semiconductor outputs		Relay outputs		Logic operations		
		Safe	Non-safe	Safe				
								
e	3	2	1	-	-			
e	3	2	1	-	-	◆	◆	
e	3	2	◆	1	-	-	◆	◆
e	3	2		1	-	-	◆	◆
e	3	2		1	-	-	◆	◆
e	3	2	◆	1	-	-	◆	◆
e	3	2		1	-	-	◆	◆
d	2	2		1	-	-	◆	◆
d	2	2	◆	1	-	-	◆	◆
e	3	2		2	-	-	◆ ¹⁾	
e	3	2		2	-	-	◆ ¹⁾	
e	3	2		1	4	-	◆	◆
e	3	2	◆	1	4	-	◆	◆

¹⁾ Also AND-linked internally

Technical documentation on PNOZelog safety relays:

 Webcode 0685

Online information at www.pilz.com



► Technical details – PNOZelog

Compact, electronic safety relays – PNOZelog



PNOZ e1.1p



PNOZ e2.1p



PNOZ e3.1p

Type	Application range	Outputs	Outputs: Voltage/ current/rating
PNOZ e1p	In accordance with EN 954-1, Category 2, 3 or 4: E-STOP, safety gate and light beam device monitoring	Use semiconductor technology: ▶ 2 safety outputs ▶ 1 auxiliary output, can be switched to a diagnostic output ▶ 2 test pulse outputs	24 VDC/ 2 A/50 W
PNOZ e1.1p	In accordance with EN 954-1, Category 2, 3 or 4: E-STOP, safety gate and light beam device monitoring	Use semiconductor technology: ▶ 2 safety outputs ▶ 1 auxiliary output, can be switched to a diagnostic output ▶ 2 test pulse outputs	24 VDC/ 2 A/50 W
PNOZ e1vp	In accordance with EN 954-1, Category 2, 3 or 4: E-STOP, safety gate and light beam device monitoring	Use semiconductor technology: ▶ 2 safety outputs delayed/instantaneous, delay-on de-energisation selectable ▶ 1 auxiliary output, can be switched to a diagnostic o/p ▶ 2 test pulse outputs	24 VDC/ 2 A/50 W
PNOZ e2.1p PNOZ e2.2p	PNOZ e2.1p: In accordance with EN 574, Req. class IIIC; PNOZ e2.2p: In accordance with EN 574, Req. class IIIA; Two-hand monitoring	Use semiconductor technology: ▶ 2 safety outputs ▶ 1 auxiliary output, can be switched to a diagnostic o/p ▶ 2 test pulse outputs	24 VDC/ 2 A/50 W
PNOZ e3.1p	In accordance with EN 954-1, Category 3 or 4: Safety gate monitoring	Use semiconductor technology: ▶ 2 safety outputs ▶ 1 auxiliary output, can be switched to a diagnostic output ▶ 2 test pulse outputs	24 VDC/ 2 A/50 W
PNOZ e3vp	In accordance with EN 954-1, Category 2, 3 or 4: Safety gate monitoring	Use semiconductor technology: ▶ 2 safety outputs delayed/instantaneous, delay-on de-energisation selectable ▶ 1 auxiliary output, can be switched to a diagnostic o/p ▶ 2 test pulse outputs	24 VDC/ 2 A/50 W

Common features

- ▶ Supply voltage (U_p): 24 VDC
- ▶ Dimensions (H x W x D): 101/94¹⁾ x 22.5 x 121 mm

Features	Order numbers	
	Cage clamp terminals	Plug-in screw terminals
<ul style="list-style-type: none"> ▶ Evaluation device for non-contact, coded safety switches PSENcode ▶ Monitored or automatic reset can be selected ▶ Selectable monitoring of shorts across contacts 	784 130	774 130
<ul style="list-style-type: none"> ▶ Evaluation device for non-contact, coded safety switches PSENcode ▶ Monitored or automatic reset can be selected ▶ One AND and one OR input for logic AND/OR operations between several PNOZelog units ▶ Selectable monitoring of shorts across contacts 	784 133	774 133
<ul style="list-style-type: none"> ▶ Evaluation device for non-contact, coded safety switches PSENcode ▶ Monitored or automatic reset can be selected ▶ One AND and one OR input for logic AND/OR operations between several PNOZelog units ▶ Selectable monitoring of shorts across contacts 	10 s 784 131 300 s 784 132	10 s 774 131 300 s 774 132
<ul style="list-style-type: none"> ▶ One AND and one OR input for logic AND/OR operations between several PNOZelog units ▶ Shorts across contacts are monitored via two test pulse outputs ▶ Status indicator ▶ Feedback loop for monitoring external contactors 	<ul style="list-style-type: none"> ▶ PNOZ e2.1p 784 136 ▶ PNOZ e2.2p 784 135 	<ul style="list-style-type: none"> ▶ PNOZ e2.1p 774 136 ▶ PNOZ e2.2p 774 135
<ul style="list-style-type: none"> ▶ Evaluation device for position switches and for non-contact, magnetic safety switches PSENmag (Series 2) ▶ Monitored or automatic reset can be selected ▶ One AND and one OR input for logic AND/OR operations between several PNOZelog units ▶ Selectable monitoring of shorts across contacts 	784 139	774 139
<ul style="list-style-type: none"> ▶ Evaluation device for position switches and for non-contact, magnetic safety switches PSENmag (Series 2) ▶ Monitored or automatic reset can be selected ▶ One AND and one OR input for logic AND/OR operations between several PNOZelog units ▶ Selectable monitoring of shorts across contacts 	10 s 784 137 300 s 784 138	10 s 774 137 300 s 774 138



Technical documentation on PNOZelog safety relays:

Webcode 0685

Online information at www.pilz.com

¹⁾ Height with cage clamp terminals/plug-in screw terminals



► Technical details – PNOZelog

Compact, electronic safety relays – PNOZelog



PNOZ e4.1p

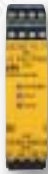

PNOZ e5.11p



PNOZ e6.1p

Type	Application range	Outputs	Outputs: Voltage/ current/rating
PNOZ e4.1p	In accordance with EN 954-1, Category 3: Evaluation device for safety mats	Use semiconductor technology: ▶ 2 safety outputs ▶ 1 auxiliary output, can be switched to a diagnostic o/p ▶ 2 test pulse outputs	24 VDC/ 2 A/50 W
PNOZ e4vp	In accordance with EN 954-1, Category 3: Evaluation device for safety mats	Use semiconductor technology: ▶ 2 safety outputs delayed/instantaneous, delay-on de-energisation selectable ▶ 1 auxiliary output, can be switched to a diagnostic o/p ▶ 2 test pulse outputs	24 VDC/ 2 A/50 W
PNOZ e5.11p	In accordance with EN 954-1, Category 2 or 3: Combined unit for monitoring E-STOP relay and/or safety gate, AND-linked internally	Use semiconductor technology: ▶ 2 safety outputs ▶ 2 auxiliary outputs	24 VDC/ 1.5 A/40 W
PNOZ e5.13p	Category 2 or 3: Combined unit for monitoring E-STOP relay and/or safety gate, PDF-M, AND-linked internally	Use semiconductor technology: ▶ 2 safety outputs ▶ 2 auxiliary outputs	24 VDC/ 1.5 A/40 W
PNOZ e6.1p	In accordance with EN 954-1, Category 2, 3 or 4: E-STOP, safety gate and light beam device monitoring	Use semiconductor technology: ▶ 2 safety outputs ▶ 1 auxiliary output, can be switched to a diagnostic o/p ▶ 2 test pulse outputs Relay outputs: ▶ 4 safety contacts (N/O)	Outputs use semiconductor technology: 24 VDC/4 A/50 W Relay outputs: 24 V/6 A/150 W
PNOZ e6vp	In accordance with EN 954-1, Category 2, 3 or 4: E-STOP, safety gate and light beam device monitoring	Use semiconductor technology: ▶ 2 safety outputs delayed/instantaneous, delay-on de-energisation selectable ▶ 1 auxiliary output, can be switched to a diagnostic o/p ▶ 2 test pulse outputs Relay outputs: ▶ 4 safety contacts (N/O)	Outputs use semiconductor technology: 24 V/4 A/50 W Relay outputs: 24 V/6 A/150 W

Common features

- ▶ Supply voltage (U_p): 24 VDC
- ▶ Dimensions (H x W x D): 101/94¹⁾ x 22.5 x 121 mm, PNOZ e6.1p and PNOZ e6vp: 101/94¹⁾ x 45 x 121 mm

Features	Order numbers	
	Cage clamp terminals	Plug-in screw terminals
<ul style="list-style-type: none"> ▶ Used to connect Mayser safety mats, type: SM/BK ▶ Suitable for controlling PSS/SafetyBUS p/PNOZmulti ▶ One AND and one OR input for logic AND/OR operations between several PNOZelog units ▶ With or without reset function 	784 180	774 180
<ul style="list-style-type: none"> ▶ Used to connect Mayser safety mats, type: SM/BK ▶ Suitable for controlling PSS/SafetyBUS p/PNOZmulti ▶ One AND and one OR input for logic AND/OR operations between several PNOZelog units ▶ With or without reset function 	10 s 784 181	10 s 774 181
<ul style="list-style-type: none"> ▶ 2 safety functions in one unit, AND-linked internally ▶ Evaluation device for position switches and non-contact, coded safety switches PSENcode ▶ One AND input for logic AND operations between several PNOZelog units ▶ Monitored or automatic reset can be selected 	784 190	774 190
<ul style="list-style-type: none"> ▶ 2 safety functions in one unit, AND-linked internally ▶ Evaluation device for position switches, non-contact safety switches PSENcode and PSENmag (Series 2) ▶ Monitored or automatic reset can be selected ▶ One AND input for logic AND operations between several PNOZelog units 	784 191	774 191
<ul style="list-style-type: none"> ▶ Connection option for E-STOP pushbuttons, safety gate limit switches, reset buttons, safety mats and safe edges made by Haake, proximity switch evaluation devices ▶ Monitored or automatic reset can be selected ▶ One AND and one OR input for logic AND/OR operations between several PNOZelog units ▶ Selectable monitoring of shorts across contacts 	784 192	774 192
<ul style="list-style-type: none"> ▶ Connection option for E-STOP pushbuttons, safety gate limit switches, reset buttons, safety mats and safe edges made by Haake, proximity switch evaluation devices ▶ Monitored or automatic reset can be selected ▶ One AND and one OR input for logic AND/OR operations between several PNOZelog units ▶ Selectable monitoring of shorts across contacts 	784 193	774 193



Technical documentation on PNOZelog safety relays:

 Webcode 0685

Online information at www.pilz.com

¹⁾ Height with cage clamp terminals/plug-in screw terminals



Product range
PNOZmulti

► Modular safety system PNOZmulti

Ingeniously simple, simply ingenious

The modular safety system PNOZmulti is multifunctional, freely configurable and tailor-made for use in many areas of mechanical engineering. Safety functions such as emergency stop, safety gates, light beam devices, two-hand control and many more are monitored safely. PNOZmulti can also be used to perform standard control functions economically. Instead of wiring, the safety circuit is easily generated on the PC using an intuitive configuration tool. The configuration is stored on a chip card and is downloaded to the PNOZmulti base unit.

Many functions – one solution

The latest highlights include the safe monitoring of safety mats, new muting functionalities, expanded diagnostics with PMLmicro diag and the PVIS diagnostic concept, plus connection to additional fieldbus systems. The continual expansion of the product range safeguards your investment – just talk to us!

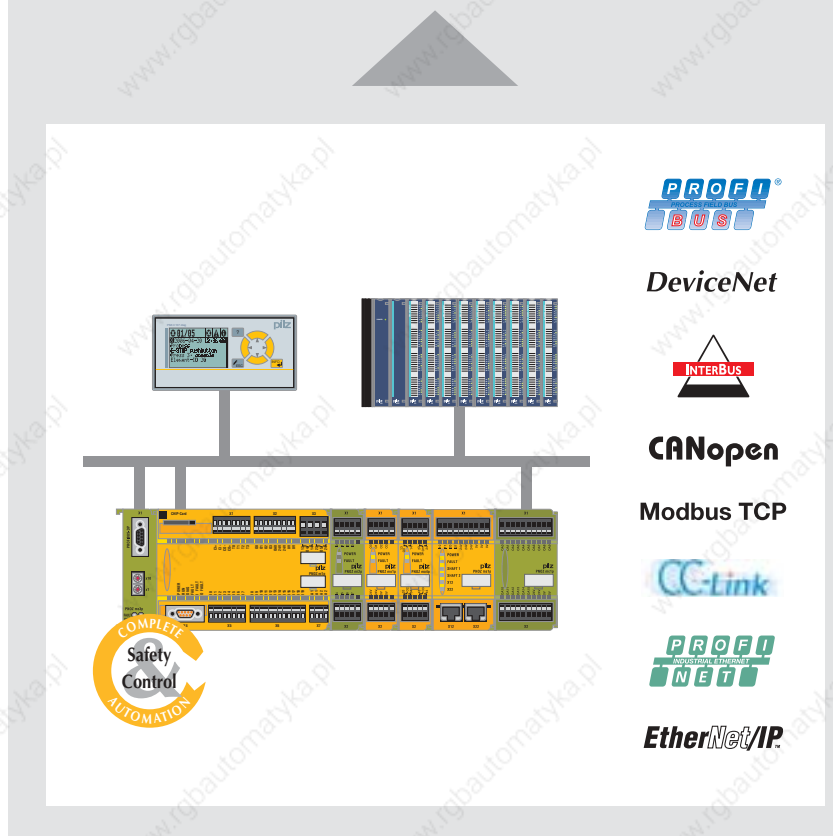
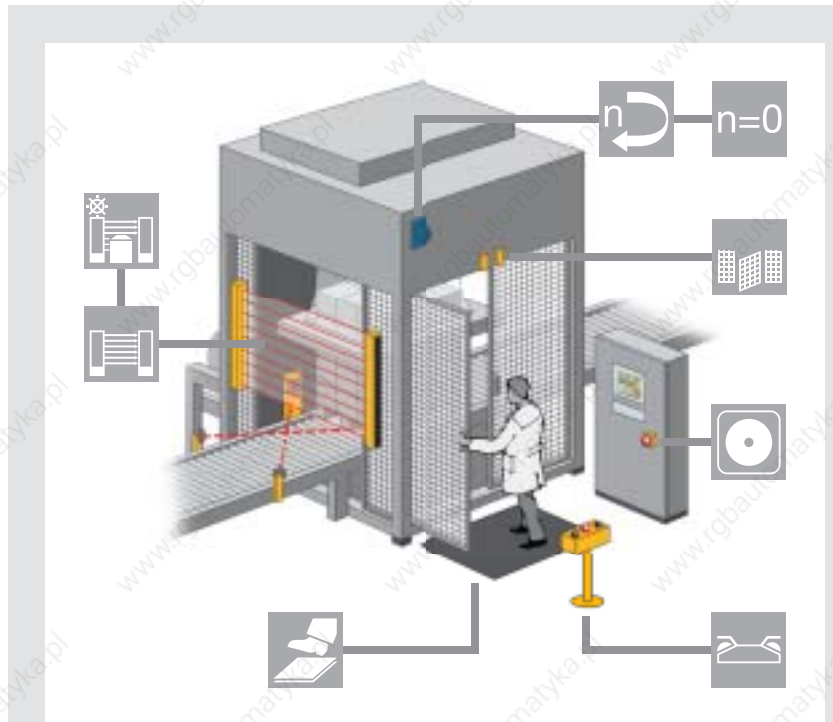

As simple as a PNOZ, as flexible as a controller

If you wish to extend the modular system, various expansion modules are available, which can be used in any combination to suit your requirements. Also available are input and output modules for both standard control and safety functions, fieldbus modules for connection to all common fieldbus systems, plus speed and standstill monitors.

Approved press blocks, muting functionalities and many other features make the PNOZmulti as simple to use as a PNOZ and as flexible as a controller.

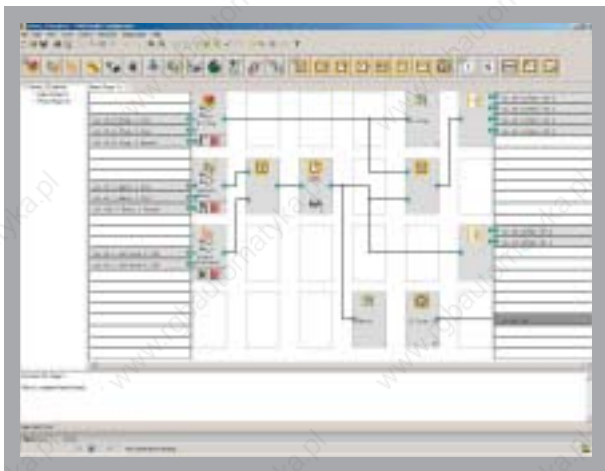
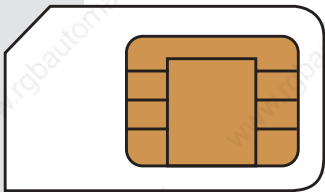

Keep up-to-date
on modular
safety systems
PNOZmulti:

 Webcode 0243

Online information
at www.pilz.com

Example: using the PNOZmulti
modular safety system on a
packaging machine.



► Customised application and child's play to

PNOZmulti Configurator

Your safety circuit is easy to configure on the PC using the PNOZmulti Configurator. The graphics-based user interface conforms to the Windows® standard; all elements are available either as symbols or in selection menus. Configuration of the elements is based on the required machine functions and the category that needs to be achieved. Online help with documentation is available during configuration.

Configuration rather than wiring

All inputs and outputs are freely configurable and can be linked using logic elements via a simple drag and drop function. All available function, logic and output elements are available to see at a glance. Rapid commissioning and the minimal wiring work involved will convince you. With intuitive operation, the PNOZmulti is absolute child's play!

Doubly safe

Once the configuration is complete, the configuration tool checks the circuit for any errors. The completed configuration can also be certified, thereby protecting it from unwanted modifications. If the configuration has not been certified, it can be edited, modified and extended at any time by calling it up in the Configurator. The completed configuration can be printed out and used as documentation.

Maintenance is simple with the PNOZmulti service tool

The PNOZmulti service tool is specifically used for troubleshooting and diagnostics during service and maintenance, directly on the machine for example. The current status of the configuration is visible during operation (powerflow). Any options that can be used to modify a project are disabled.

Function Elements

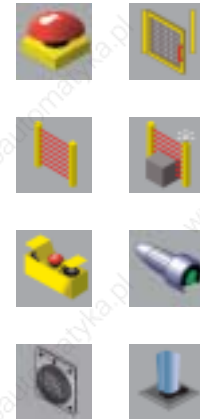

Logic Elements



Output elements



pilz

more than automation
safe automation

operate

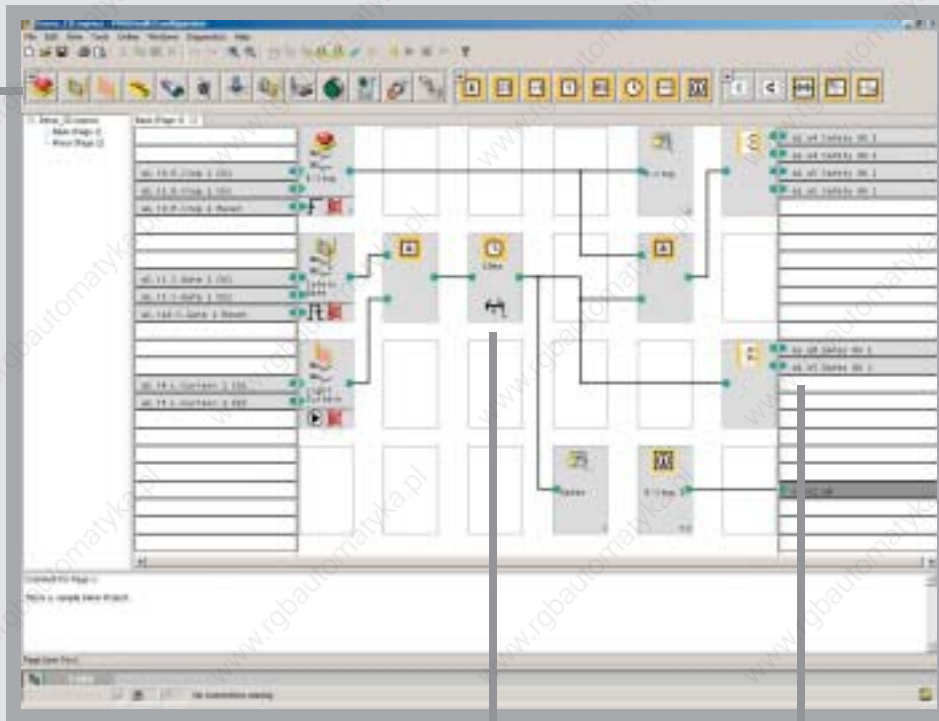

PVIS[®]
Based on Pilz
Diagnostic Concept

Configure Delay Time Element - Pulse Timer

Logic element: Delay Time Element

Timer type:
 Delay Timer Pulse

Delay Time:
 Switch-on delay Redundant Switch-off delay

Period:
Period: 600 ms

Range: 10 - 655360 ms

User text:
Enter user text:

Buttons: OK, Cancel, Help

Example of a time delay element with a delay time of 600 ms (selectable).

Configure Output Element

Output element: Semiconductor

Output type:
 Semiconductor Relay output

Number of outputs:
 Single output Redundant output

Feedback loop used:
 Feedback loop used

Connections:
Output 1: A1 .o0
Output 2: A1 .o1

User text:
Enter user text:

Buttons: OK, Cancel, Help

Example of a semi-conductor output in accordance with Category 4, EN 954-1, without feedback loop.



► Modular and flexible

Your benefits at a glance

- ▶ At least 40 % potential savings in all engineering phases thanks to a freely configurable graphics configuration tool
- ▶ Ideal for covering applications of four safety functions and above
- ▶ One system to cover safety-related and standard control functions
- ▶ High potential savings thanks to simple, intuitive operation
- ▶ Subsequent modifications and adjustments to the configuration are simple to make
- ▶ Flexible to apply, as only one solution is required for Category 2, 3 or 4
- ▶ No need to draw complex circuit diagrams: simply print out your configuration
- ▶ Save costs by reducing stockholdings
- ▶ Simple, user-friendly diagnostics mean short downtimes and high plant availability
- ▶ Simple wiring means short commissioning times
- ▶ Chip card for data transfer; easy copy function is of particular interest to series users
- ▶ Saves a lot of space in the control cabinet
- ▶ Simple and economical to expand by selecting compatible modules
- ▶ Future-proof and economical thanks to the flexibility of the software and the adaptability of the hardware
- ▶ Certified worldwide
- ▶ Complete solution comprising evaluation devices, compatible sensor technology and control and signal devices

From planning to maintenance

Faster time-to-market compared with conventional solutions! You can save over 40% of your time and costs – in all engineering phases – during planning, configuration, commissioning, operation and maintenance.

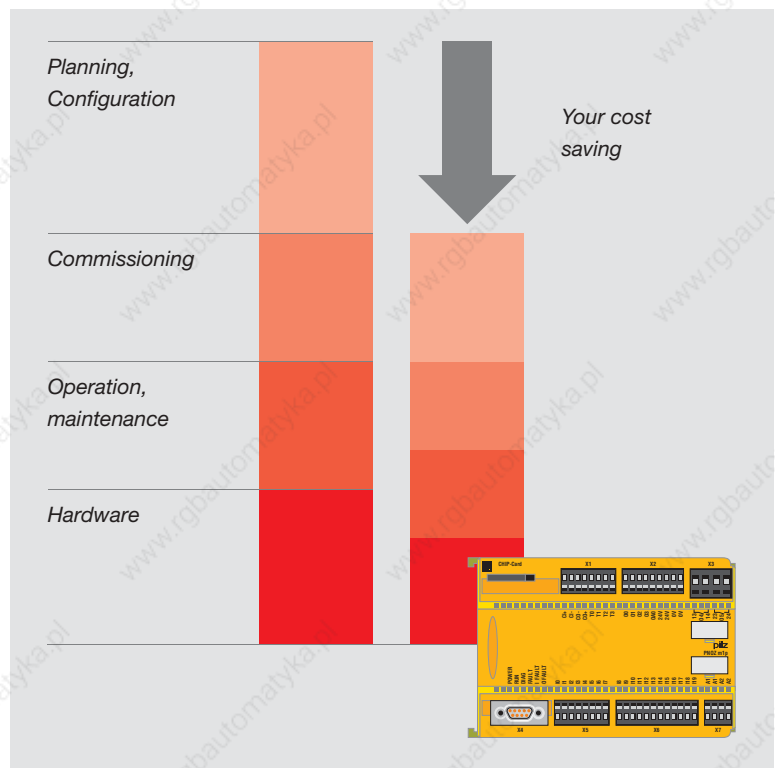

40% cost savings in all engineering phases by using PNOZmulti.

Applications and industries PNOZmulti



Safe and economical in all industries

PNOZmulti is used in numerous applications across the widest range of industries. The intelligent dovetailing of safety-related and standard control functions, a modular concept and simple configuration mean the system can control from the simplest machine to distributed plants. PNOZmulti is so flexible that it can also be adapted to suit your application – guaranteed.

Application areas may include:

- ▶ General mechanical engineering, e.g. lathes, milling and drilling machines
- ▶ Plastics processing machines, e.g. blow moulding machines
- ▶ Laser machines: e.g. laser welding and laser punching machines
- ▶ Packaging machines, e.g. drink dispensing and palletising machines
- ▶ Forming technology: Hydraulic presses, eccentric presses, press brakes, small presses and punch presses
- ▶ Robot cells: processing, welding and spraying robots
- ▶ Print and paper industry, e.g. printing, enveloping and paper machines
- ▶ Other applications, e.g. in airports, pleasure parks, cablecar technology, in the automotive industry, in the pharmaceutical industry and in many other areas





► The basis for each application: many func

Base unit PNOZ m0p – the compact solution ...

... for machines on which three to six safety functions are monitored. PNOZmulti is economical from just three functions. Your costs are even further reduced through simple diagnostics, for example via fieldbus modules for all common fieldbus systems. Particularly suitable for use on small machines, the PNOZ m0p manages without any expansion modules. You can enjoy all the benefits of the safety system, including the complete functionality of the PNOZmulti Configurator, at an excellent price/performance ratio.

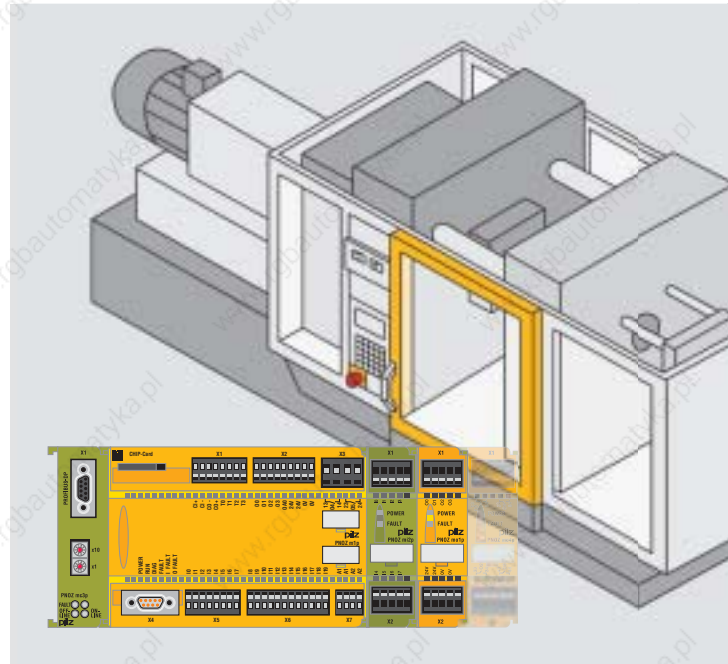

PNOZ m1p – The all-rounder ...

... for small to average-sized machines is your ideal choice if you are using more than four safety functions. What's more, standard control functions are also monitored. It is very simple to expand and, depending on the type and number of expansion modules that are used, up to 24 safety functions can be monitored. If you then take advantage of the cascading function as well, there are almost no limits for the application of the PNOZmulti.

*Ideal for three to
six safety functions!*

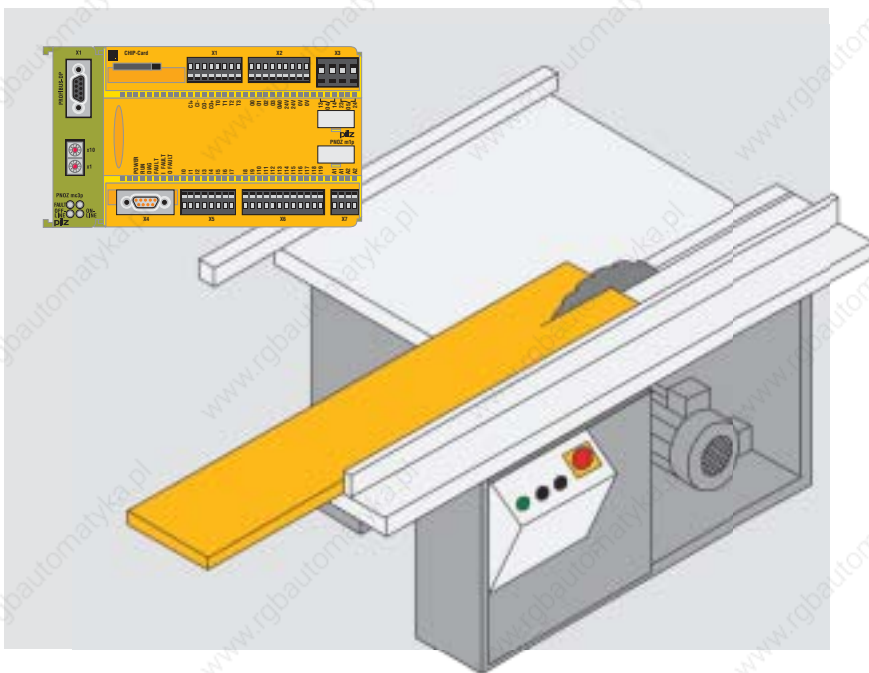

tions – one solution!

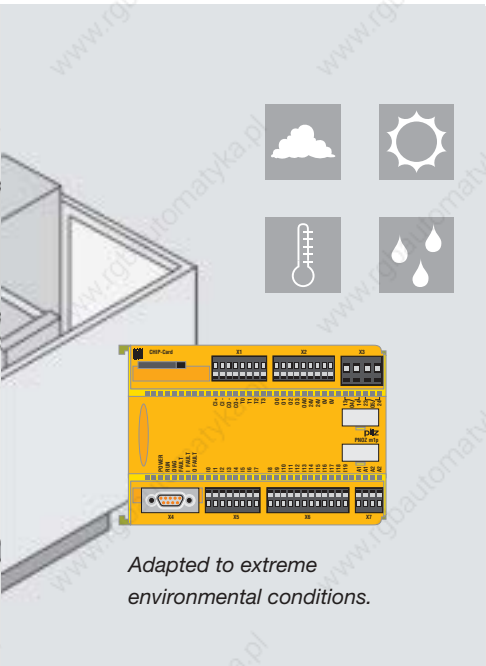

Adapted to extreme environmental conditions.

PNOZ m1p, coated version – Tough ...

... and specially designed for use in a rugged everyday industrial environment, the units' PCB boards are varnished and therefore protected from environmental influences. The benefits include an expanded temperature range, tolerance of condensation and resistance to corrosive gas.

All base units:
 20 inputs, 4 safe semiconductor outputs and 2 relay outputs.

PNOZ m2p – Withstands plenty ...

... and is specially designed to control and monitor small and average-sized eccentric and hydraulic presses. Approved software blocks are available for operating modes such as set-up mode, single-stroke and automatic; for monitoring safety light curtains in single-break or double-break mode and monitoring camshaft with run monitoring; these blocks make the system simple and economical to use.

In conjunction with the dual-pole semiconductor output module PNOZ mo3p, the PNOZ m2p can control press safety valves safely and economically.

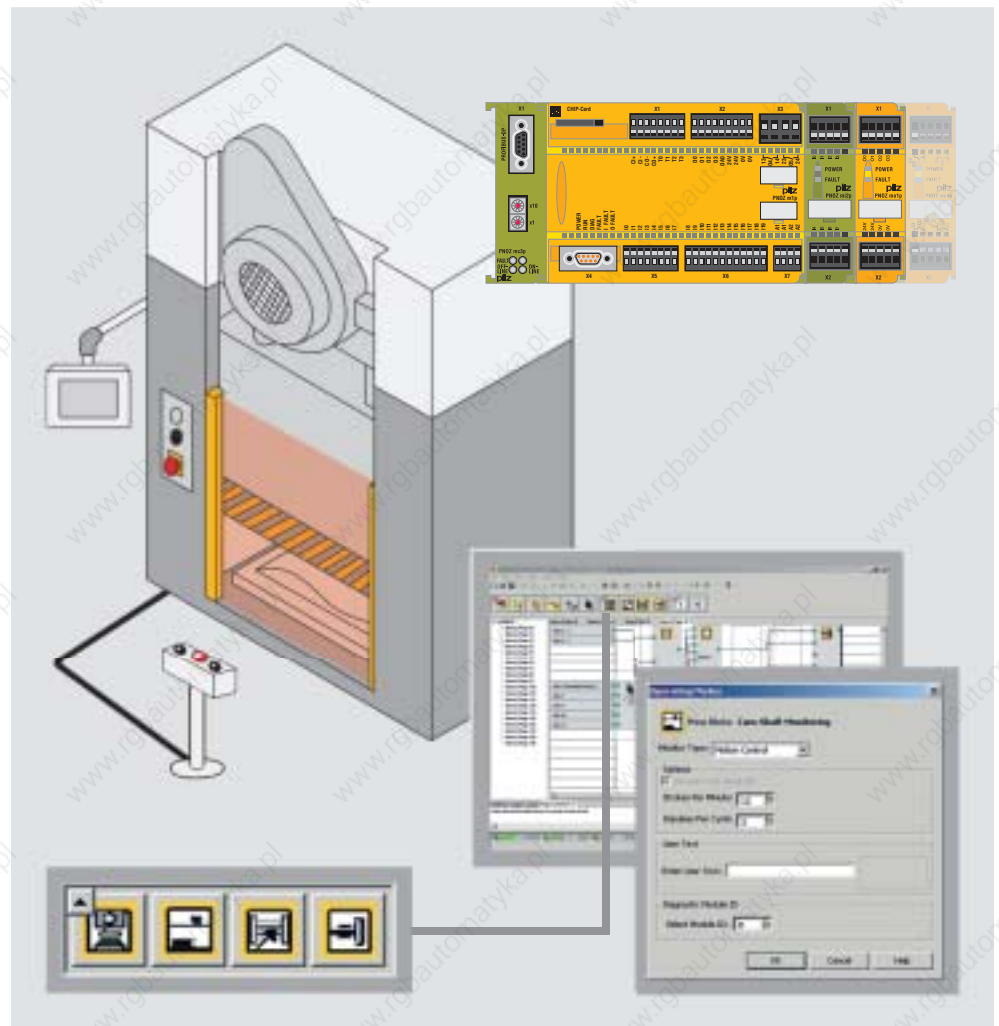



► For increased cost-effectiveness

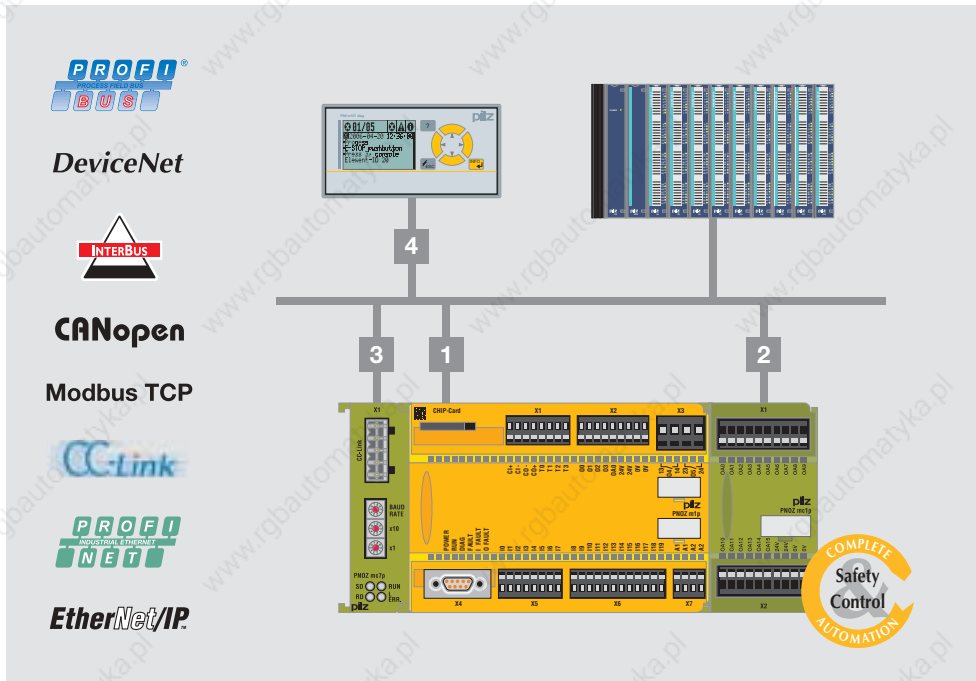

Diagnostics with PNOZmulti – Always in the picture

User-friendly diagnostic and control information guarantees short downtimes and high plant availability. With PNOZmulti there are several options for diagnostics:

- 1 Serial interface
- 2 Status messages to the PLC: PNOZ mc1p
- 3 Two-way signalling and control: all common fieldbus systems such as PROFIBUS-DP, DeviceNet, Interbus, CANopen or CC-Link
- 4 Diagnostic system PMI/micro diag

Reduce downtimes with PVIS

Thanks to the modern PVIS diagnostic concept, PNOZmulti and PMI operator terminals can provide an overall, integrated diagnostic solution¹⁾. If a fault occurs, features such as plain text messages with precise information on the location, clearly defined responsibilities and integrated first fault display all ensure that production is quickly restarted. The PNOZmulti Configurator contains the



PNOZmulti project, texts for diagnostics, proposed solutions and more. The benefits are obvious: there's less configuration required, greater flexibility and downtimes are reduced.

Further information on the PVIS diagnostic concept:

Webcode 1046

Online information at www.pilz.com

¹⁾ PNOZ m1p base unit from Version 5, PNOZ m0p and PNOZ m2p base units from Version 2, PNOZmulti Configurator from Version 5.0.0

**Effective symbiosis
of safety and standard**

Perform your automation functions more economically! PNOZmulti offers a selection of functionalities with which to monitor safety-related and standard control functions:

- ▶ The connection module PNOZ ml1p for safe connection of two PNOZmulti base units. Additional base units can be networked either in tree or in ring structure. Several plants or machines can be networked to implement larger projects, enabling plant sections to be shut down selectively and commissioned. Benefits to you: reduced downtimes and increased productivity.
- ▶ Fieldbus modules: in addition to diagnostic and status information, it is also possible to transmit controller information (commands) directly from the controller to the PNOZmulti via the fieldbus.

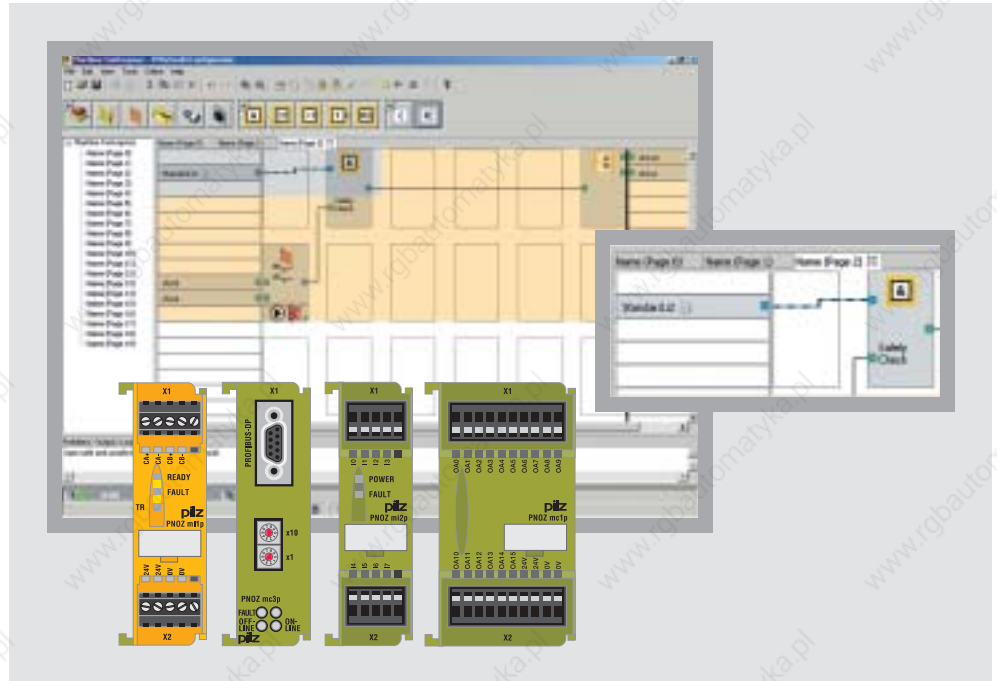

- ▶ Input module PNOZ mi2p with eight inputs to monitor standard control functions – cost benefit guaranteed.
- ▶ Output module PNOZ mc1p with 16 auxiliary outputs for issuing status messages to a higher-level PLC.

Monitor safety mats safely

Use the PNOZmulti as an evaluation device for safety mats. PNOZmulti is approved in accordance with Annex 4 of the Machinery Directive and EN 954-1 in conjunction with EN 1760. This means that the safety mat and the PNOZmulti safety relay are recognised as one unit. No additional evaluation devices are required. Take advantage of the possibilities of the multifunctional PNOZmulti safety system. Monitor safety functions such as E-STOP, safety gate, time and standstill, as well as monitoring safety mats, in just one unit. No need for wiring so you save valuable time.

Simple connection of standard control functions and safety functions in the PNOZmulti Configurator.

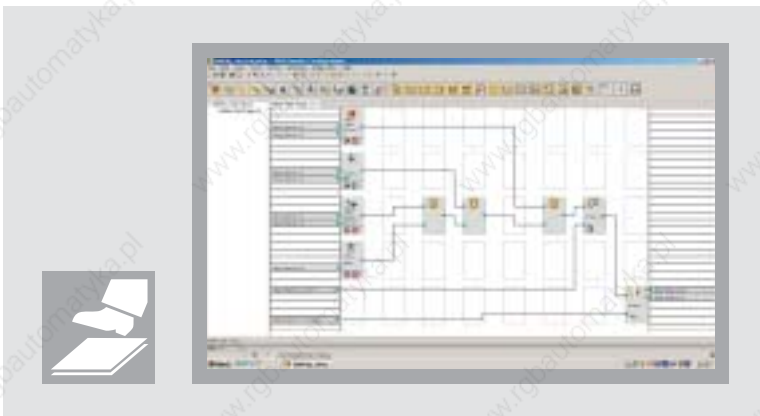



▶ Selection guide – PNOZmulti

Modular safety system – PNOZmulti

Type	Application area	Performance Level PL ¹⁾ (EN ISO 13849-1)	Safety Integrity Level SIL CL ¹⁾ (claim limit in accordance with IEC 62061)
PNOZ mi1p	Safe input module	e	3
PNOZ mi2p	Input module	e	3
PNOZ mo1p	Safe semiconductor output module	e	3
PNOZ mo3p	2-pole, safe semiconductor output module	e	3
PNOZ mo2p	Safe relay output module	e	3
PNOZ mo4p	Safe relay output module	e	3
PNOZ mc1p	Output module	-	-
PNOZ ms2p	Safe speed/standstill monitoring module	e	3
PNOZ ml1p	Safe connection module	e	3
PNOZ mc3p	Fieldbus module PROFIBUS-DP	-	-
PNOZ mc4p	Fieldbus module DeviceNet	-	-
PNOZ mc5p	Fieldbus module Interbus	-	-
PNOZ mc5.1p	Fieldbus module Interbus LWL	-	-
PNOZ mc0p	Power supply for Interbus fieldbus modules PNOZ mc5p and PNOZ mc5.1p	-	-
PNOZ mc6p	Fieldbus module CANopen	-	-
PNOZ mc7p	Fieldbus module CC-Link	-	-
PNOZ mc8p	Fieldbus module Ethernet IP/Modbus	-	-
PNOZ mc9p	Fieldbus module PROFINET	-	-



Connection of expansion modules to base unit²⁾

PNOZ m0p	PNOZ m1p	PNOZ m1p (coated version)	PNOZ m2p (press applications)
3 ... 6 Safety functions	≥ 4 Safety functions	≥ 4 Safety functions	≥ 4 Safety functions
	◆	◆	◆
	◆		◆
	◆	◆	◆
	◆		◆
	◆	◆	◆
	◆	◆	◆
	◆	◆	◆
	◆		◆
◆	◆	◆	◆
◆	◆		◆
◆	◆	◆	◆
◆	◆		◆
◆	◆	◆	◆
◆	◆		◆
◆	◆	◆	◆
◆	◆	◆	◆
◆	◆		◆
◆	◆	◆	◆
◆	◆		◆
◆	◆	◆	◆

Technical documentation on PNOZmulti modular safety systems:

 Webcode 0685

Online information at www.pilz.com

¹⁾ Maximum achievable value, depending on the application, e.g. number of outputs.

²⁾ All base units have Performance Level e and Safety Integrity Level 3.



► Technical details – PNOZmulti

Modular safety system PNOZmulti Controller – Base units

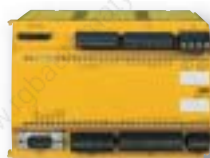

PNOZ m0p

Type	Application area	Application range in accordance with EN 954-1, Category 2, 3 and 4
PNOZ m0p	Base unit – from 3 ... 6 safety functions Fieldbus modules can be connected; no other expansion modules can be connected	E-STOP, two-hand buttons, safety gate limit switch, light barriers, scanner, enable switch, PSEN safety gate switch, operating mode selector switch, muting, safety mats, sensors
PNOZ m1p/ PNOZ m1p (coated version)	Base unit – from 4 safety functions; also for standard control functions	
PNOZ m2p	Base unit – specifically for press applications	As PNOZ m1p, additional monitoring of operating modes such as set-up mode, single-stroke and automatic; safety light curtains in single-break and double-break mode, camshaft with run monitoring, press safety valves, muting, safety mats, sensors

Modular safety system PNOZmulti I/O – Input modules



PNOZ mi1p

Type	Application range	Inputs/outputs
PNOZ mi1p/ PNOZ mi1p (coated version)	Safe input module	8 safe inputs
PNOZ mi2p	Input module	8 inputs

Common features

- Supply voltage (U_b): 24 VDC via base unit
- Dimensions (H x W x D): 94 x 22.5 x 121 mm

Features	Order numbers		
		Cage clamp terminals	Plug-in screw terminals
<ul style="list-style-type: none"> ▶ Can be configured using the PNOZmulti Configurator via chip card or RS 232 interface ▶ Exchangeable program memory ▶ Diagnostic interface ▶ Fieldbus modules can be connected ▶ Max. 8 expansion modules can be connected ▶ PNOZ m1p/PNOZ m2p: Max. 8 expansion modules can be connected ▶ Inputs/outputs: 20 freely configurable inputs, 4 test pulse outputs, 1 auxiliary output ▶ Outputs using semiconductor technology: - Category 4: 2 safety outputs - Category 3: 4 safety outputs ▶ Relay outputs: - Category 4: 1 safety contact - Category 2: 2 safety contacts ▶ Supply voltage (U_N): 24 VDC ▶ Voltage/current/rating: - Outputs using semiconductor technology: 24 VDC/2 A/48 W - Relay outputs: DC1: 24 V/6 A/144 W ▶ Dimensions (H x W x D): 94 x 135 x 121 mm 	773 110 (excl. terminals)	783 100 (1 set)	793 100 (1 set)
	<ul style="list-style-type: none"> ▶ 773 100 (excl. terminals) ▶ 773 105 (coated version, excl. terminals) 	783 100 (1 set)	793 100 (1 set)
	773 120 (excl. terminals)	783 100 (1 set)	793 100 (1 set)



Features	Order numbers		
		Cage clamp terminals	Plug-in screw terminals
<ul style="list-style-type: none"> ▶ Max. 8 input modules can be connected to the base unit ▶ Connected to base unit via a link on the back of the unit 	<ul style="list-style-type: none"> ▶ 773 400 (excl. terminals) ▶ 773 405 (coated version, excl. terminals) 	783 400 (1 set)	793 400 (1 set)
<ul style="list-style-type: none"> ▶ Max. 8 input modules can be connected to the base unit ▶ Connected to base unit via a link on the back of the unit 	773 410 (excl. terminals)	783 400 (1 set)	793 400 (1 set)

Technical documentation on PNOZmulti modular safety systems:

Webcode 0685

Online information at www.pilz.com

¹⁾ not for PNOZ mi2p



► Technical details – PNOZmulti

Modular safety system PNOZmulti I/O – Output modules



PNOZ mo1p



PNOZ mc1p

Type	Application range	Inputs/outputs	Supply voltage
PNOZ mo1p/ PNOZ mo1p (coated version)	Safe semiconductor output module: Switching 24 V actuators	► Outputs use semiconductor technology: - Category 4: 2 safety outputs - Category 3: 4 safety outputs	24 VDC
PNOZ mo3p	Safe semiconductor output module, 2-pole	► 2-pole outputs use semiconductor technology: - Category 4: 2 safety outputs	24 VDC via expansion module
PNOZ mo2p/ PNOZ mo2p (coated version)	Safe relay output module: Volt-free switching of actuators	► Relay outputs: - Category 4: 1 safety output - Category 2: 2 safety outputs	24 VDC via base unit
PNOZ mo4p/ PNOZ mo4p (coated version)	Safe relay output module: Volt-free switching of actuators	► Relay outputs: - Category 4: 2 safety outputs - Category 2: 4 safety outputs	24 VDC via base unit
PNOZ mc1p/ PNOZ mc1p (coated version)	Output module: Status message to SPS	► 16 auxiliary outputs use semiconductor technology	24 VDC

Common features

- Dimensions (H x W x D): 94 x 22.5 x 121 mm, PNOZ mc1p: 94 x 45 x 121 mm

Outputs: Voltage/ current/rating	Features	Order numbers		
			Cage clamp terminals	Plug-in screw terminals
24 VDC/2 A/48 W	<ul style="list-style-type: none"> ▶ Max. 6 semiconductor output modules can be connected to the base unit ▶ Connected to base unit via a link on the back of the unit 	<ul style="list-style-type: none"> ▶ 773 500 (excl. terminals) ▶ 773 505 (coated version, excl. terminals) 	783 400 (1 set)	793 400 (1 set)
24 VDC/2 A	<ul style="list-style-type: none"> ▶ Max. 6 semiconductor output modules can be connected to the base unit ▶ Connected to base unit via a link on the back of the unit 	773 510 (excl. terminals)	783 400 (1 set)	793 400 (1 set)
DC1: 24 V/6 A	<ul style="list-style-type: none"> ▶ Max. 6 semiconductor output modules can be connected to the base unit ▶ Connected to base unit via a link on the back of the unit 	<ul style="list-style-type: none"> ▶ 773 520 (excl. terminals) ▶ 773 525 (coated version, excl. terminals) 	783 520 (1 set)	793 520 (1 set)
DC1: 24 V/6 A	<ul style="list-style-type: none"> ▶ Max. 6 semiconductor output modules can be connected to the base unit ▶ Connected to base unit via a link on the back of the unit 	<ul style="list-style-type: none"> ▶ 773 536 (excl. terminals) ▶ 773 537 (coated version, excl. terminals) 	783 536 (1 set)	793 536 (1 set)
-	<ul style="list-style-type: none"> ▶ Max. 8 output modules can be connected to the base unit ▶ Connected to base unit via a link on the back of the unit 	<ul style="list-style-type: none"> ▶ 773 700 (excl. terminals) ▶ 773 705 (coated version, excl. terminals) 	783 700 (1 set)	793 700 (1 set)



Technical documentation on PNOZmulti modular safety systems:

Webcode 0685

Online information at www.pilz.com



► Technical details – PNOZmulti

Modular safety system PNOZmulti I/O – Monitoring module



PNOZ ms1p

Type	Application range	Dimensions (H x W x D) in mm
PNOZ ms1p/ PNOZ ms2p	Safe speed and standstill monitoring module in accordance with EN 954-1, Category 3: for safe speed and standstill monitoring via incremental encoders or proximity detectors.	94 x 45 x 121

Modular safety system PNOZmulti COM – Connection module

Type	Application range	Dimensions (H x W x D) in mm
PNOZ ml1p	Connection module: for safe connection of two PNOZmulti base units	94 x 22.5 x 121

Modular safety system PNOZmulti PAA – Cable



PNOZ msi1p

Type	Application range	Dimensions (H x W x D) in mm
PNOZ msi1p ... and more	Connection cable for PNOZ ms1p/ PNOZ ms2p in accordance with EN 954-1, Category 3: to connect incremental encoders	On request
PNOZ mli1p	Connection cable for the PNOZ ml1p	5 m, 10 m, 50 m

Features	Order numbers		
		Cage clamp terminals	Plug-in screw terminals
<ul style="list-style-type: none"> ▶ Supply voltage (U₀): 24 VDC via base unit ▶ Up to 8 limit values can be configured using the PNOZmulti Configurator ▶ Proximity detectors are connected directly to the terminals on the PNOZ ms1p/PNOZ ms2p ▶ Incremental encoders are connected via connection cable ▶ PNOZ ms2p: <ul style="list-style-type: none"> - Incremental encoder with differential output signals from 0.5 V_{ss} to 30 V_{ss}, i.e. now also suitable for HTL encoders - Independent from the supply voltage of the incremental encoder, i.e. also for encoders with 8 V supply voltage, for example ▶ Two axes can be monitored independently ▶ Max. 4 modules can be connected to the base unit ▶ Can be evaluated in the PNOZmulti Configurator ▶ Connected to base unit via plug-in connector on the back of the unit 	<ul style="list-style-type: none"> ▶ 773 800 PNOZ ms1p (excl. terminals) ▶ 773 810 PNOZ ms2p (excl. terminals) 	783 800 (1 set)	793 800 (1 set)



¹⁾



²⁾

Features	Order numbers		
		Cage clamp terminals	Plug-in screw terminals
<ul style="list-style-type: none"> ▶ Point-to-point connection via 4-core screened cable ▶ Transfer of 32 bit input data and 32 bit output data ▶ Several PNOZmulti base units can be networked by linking additional connection modules – either in tree or in ring structure 	<ul style="list-style-type: none"> ▶ 773 540 (excl. terminals) 	783 400 (1 set)	793 400 (1 set)

¹⁾ Pending for PNOZ ml1p

²⁾ Not for PNOZ ml1p

Features	Order numbers		
		Cage clamp terminals	Plug-in screw terminals
<ul style="list-style-type: none"> ▶ Used to connect an incremental encoder to the speed monitors PNOZ ms1p/PNOZ ms2p ▶ Connection cable for all common makes of drive ▶ Connection to drive and incremental encoder via 25-pin or 15-pin D-Sub male and female connector, or wired with stranded cable ▶ Variable cable lengths 	<ul style="list-style-type: none"> ▶ PNOZ msi1p 25/25 Si/Ha, 2.5 m773850 ▶ PNOZ msi5p 15/15 Bo/Rex, 2.5 m773857 ▶ PNOZ msi15p 15/15 PMctendo, 2.5 m773874 ▶ Other versions available 		
<ul style="list-style-type: none"> ▶ Ready-made as spring-loaded or screw terminal type ▶ Screened 	<ul style="list-style-type: none"> ▶ 5 m773890 ▶ Other versions available 		

Technical documentation on PNOZmulti modular safety systems:

Webcode 0685

Online information at www.pilz.com



► Technical details – PNOZmulti



DeviceNet



Modular safety system PNOZmulti COM – Fieldbus modules



Type	Application range	Supply voltage (U_B)
PNOZ mc3p	Fieldbus module PROFIBUS-DP	24 VDC via base unit
PNOZ mc4p/ PNOZ mc4p (coated version)	Fieldbus module DeviceNet	24 VDC via base unit
PNOZ mc5p	Fieldbus module Interbus	24 VDC via base unit
PNOZ mc5.1p	Fieldbus module Interbus LWL	24 VDC via base unit
PNOZ mc0p	Power supply for fieldbus modules PNOZ mc5p and PNOZ mc5.1p	24 VDC

Dimensions (H x W x D) in mm	Features	Order numbers
94 x 22.5 x 119	<ul style="list-style-type: none"> ▶ Can be configured using the PNOZmulti Configurator ▶ Station addresses from 0 ... 99, selected via rotary switch ▶ Status indicators via LEDs ▶ Subscriber (Slave) on PROFIBUS-DP ▶ Transmission rate: Max. 12 MBit/s ▶ Max. 1 fieldbus module can be connected to the base unit ▶ Connected to base unit via a link on the back of the unit 	773 721
94 x 22.5 x 122	<ul style="list-style-type: none"> ▶ Can be configured using the PNOZmulti Configurator ▶ Station addresses from 0 ... 63, selected via DIP switch ▶ Status indicators via LEDs ▶ Subscriber (Slave) on DeviceNet ▶ Transmission rate: 125, 250, 500 kBit/s ▶ Max. 1 fieldbus module can be connected to the base unit ▶ Connected to base unit via a link on the back of the unit 	773 722 coated version..... 773 729
94 x 22.5 x 119	<ul style="list-style-type: none"> ▶ Can be configured using the PNOZmulti Configurator ▶ Status indicators via LEDs ▶ Subscriber (Slave) on Interbus ▶ Transmission rate selected via jumper ▶ Transmission rate: 500 kBit/s, 2 MBit/s ▶ Max. 1 fieldbus module can be connected to the base unit ▶ Connected to base unit via a link on the back of the unit 	773 723
94 x 22.5 x 121	<ul style="list-style-type: none"> ▶ Can be configured using the PNOZmulti Configurator ▶ Subscriber (Slave) on Interbus with fibre-optic cable ▶ Transmission rate, selectable between 500 kBit/s or 2 MBit/s ▶ Status indicators for communication with Interbus and for errors ▶ Max. 1 fieldbus module can be connected to the base unit ▶ FSMA connection technology ▶ Connected to base unit via a link on the back of the unit 	773 728
94 x 22.5 x 121	<ul style="list-style-type: none"> ▶ Interface to connect the base unit and a fieldbus module ▶ Galvanic isolation ▶ Max. 1 fieldbus module (PNOZ mc5p or PNOZ mc5.1p) can be connected ▶ Status indicators ▶ Plug-in terminals (either with cage clamp or screw connection) ▶ Connected to base unit via a link on the back of the unit 	773 720



Technical
documentation
on PNOZmulti
modular safety
systems:

 Webcode 0685

Online information
at www.pilz.com



► Technical details – PNOZmulti



Modular safety system PNOZmulti COM – Fieldbus modules

CANopen



PNOZ mc6p

Type	Application range	Supply voltage (U _B)
PNOZ mc6p	Fieldbus module CANopen	24 VDC via base unit



PNOZ mc7p

CC-Link

PNOZ mc7p	Fieldbus module CC-Link	24 VDC via base unit
------------------	----------------------------	-------------------------



PNOZ mc8p

EtherNet/IP

Modbus TCP

PNOZ mc8p	Fieldbus module Ethernet/IP, Modbus TCP	24 VDC via base unit
------------------	--	-------------------------



PNOZ mc9p

PROFINET

PNOZ mc9p	Fieldbus module PROFINET IO Device	24 VDC via base unit
------------------	---------------------------------------	-------------------------

Dimensions (H x W x D) in mm	Features	Order numbers
94 x 22.5 x 122	<ul style="list-style-type: none"> ▶ Can be configured using the PNOZmulti Configurator ▶ Station addresses from 0 ... 99, selected via rotary switch ▶ Status indicators via LEDs ▶ Subscriber (Slave) on CANopen ▶ Transmission rate selected via rotary switch ▶ Transmission rate: Max. 1 MBit/s ▶ Max. 1 fieldbus module can be connected to the base unit ▶ Connected to base unit via a link on the back of the unit 	773 724 coated version..... 773 727
94 x 22.5 x 122	<ul style="list-style-type: none"> ▶ Can be configured using the PNOZmulti Configurator ▶ Station addresses from 1 ... 63, selected via rotary switch ▶ Status indicators via LEDs ▶ Subscriber (Slave) on CC-Link ▶ Occupied stations: 2 ▶ Transmission rate selected via rotary switch ▶ Transmission rate: Max. 10 MBit/s ▶ Max. 1 fieldbus module can be connected to the base unit ▶ Connected to base unit via a link on the back of the unit 	773 726 coated version..... 773 725
94 x 22.5 x 114	<ul style="list-style-type: none"> ▶ Can be configured using the PNOZmulti Configurator ▶ Subscriber on Ethernet/IP (Adapter) or Modbus TCP (Slave) ▶ Transmission rate 10 MBit/s ▶ Status indicators via LEDs ▶ IP address is set via DIP switches on the front of the unit ▶ Max. 1 fieldbus module can be connected to the base unit ▶ Connected to base unit via a link on the back of the unit 	773 730
94 x 22.5 x 114	<ul style="list-style-type: none"> ▶ Device name can be configured in the PNOZmulti Configurator ▶ Subscriber on PROFINET IO (PROFINET IO Device) ▶ Diagnostics and alarm functions are not supported ▶ Status indicators via LEDs ▶ Max. 1 fieldbus module can be connected to the base unit ▶ Connected to base unit via a link on the back of the unit 	773 731



Technical
documentation
on PNOZmulti
modular safety
systems:

 Webcode 0685

Online information
at www.pilz.com



► Technical details – PNOZmulti

Modular safety system PNOZmulti PASsystem – Software



Type	Features
PNOZmulti Configurator	<ul style="list-style-type: none"> ▶ Runs under Windows® 2000 and XP ▶ Project planning, configuration generation, documentation, commissioning ▶ Data transfer via standard serial cable or via a chip card ▶ Graphic configuration of safety circuit
PNOZmulti Service Tool	<ul style="list-style-type: none"> ▶ PNOZmulti service tool is a supplement for the configuration software PNOZmulti Configurator. ▶ Purpose: Troubleshooting and diagnostics for service and maintenance; downloading projects ▶ Any options that modify a project are disabled, i.e. the service tool is unable to change a project

Modular safety system PNOZmulti PAA – Accessories



Type	Features
PNOZmulti Tool Kit	<ul style="list-style-type: none"> ▶ The Tool Kit contains the accessories you need to start working with PNOZmulti: <ul style="list-style-type: none"> - Documentation folder with the PNOZmulti Configurator - Chip card reader to write and save the configuration on to a chip card - Chip card set consisting of 10 chip cards, including a chip card adapter for rewriting chips removed from the chip card - Configuration cable for reading diagnostic data

Order numbers		
Documentation folder with software on CD-ROM	Software incl. documentation on CD-ROM	Licence type
773 000 ²⁾	773 000D ²⁾	773 010... ³⁾
773 005 ²⁾	-	773 011... ³⁾



Order numbers					
PNOZmulti Tool Kit	Chip card reader	Chip card set	Configuration cable	Documentation folder with PNOZmulti Configurator	Licence type
779 000	779 230 ³⁾	8 kB ...779 200 ¹⁾ 32 kB ...779 212 ¹⁾	310 300 ¹⁾	773 000... ²⁾	773 010... ³⁾

¹⁾ For use only with subsequent orders

²⁾ Please order licence separately; it is required in order to enable the software.

³⁾ Please state the type of licence you require after the order number (.B for basic licence; ..K for user licence; ..G for project licence), e. g. 773 010B.
Time-restricted licences for PNOZmulti Configurator:
...S (2 months), ...R (3 months) or ...Q (4 months).

Technical documentation on PNOZmulti modular safety systems:

Webcode 0685

Online information at www.pilz.com



► Modular safety system PNOZpower

Switching high loads safely

The modular PNOZpower safety system is suitable for monitoring E-STOPS, safety gates and light beam devices. PNOZpower can switch currents of up to 16 A AC/DC per contact. An overall breaking capacity of 40 A is available per module. In each case, external contactors and contactor combinations are no longer required.

Modular and flexible

The base module processes the inputs, the output modules are specifically matched to the respective load. The number and capacity of the required safety contacts can be scaled, depending on the application. A maximum of five modules can be connected to the base unit. Modules are wired to the base unit via an internal bus system.

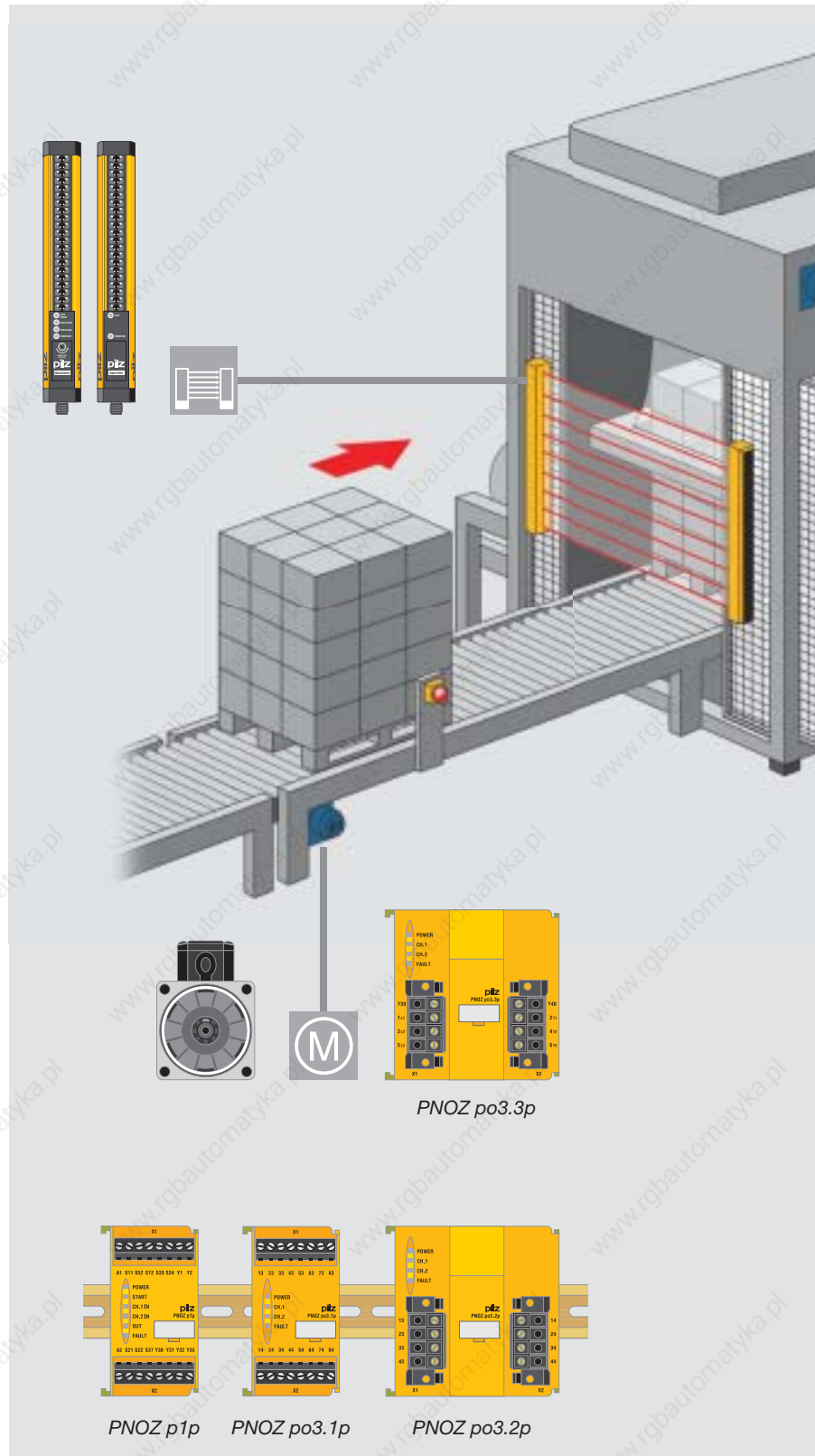

Example: using the modular safety system PNOZpower on a packaging machine.

Benefits at a glance
PNOZpower



Your benefits at a glance

- ▶ External contactor combinations and their respective wiring are no longer required, saving costs, space and commissioning time
- ▶ Diagnostics via LED: operating and fault status can be scanned on each module, resulting in fewer downtimes
- ▶ Plug-in connection terminals: pre-wired and easy to exchange if there is a fault
- ▶ Redundant load switching
- ▶ Scalable and flexible through the selection of compatible modules – you only pay for the functions that you actually use.
- ▶ Complete solution comprising evaluation devices, compatible sensor technology and control and signal devices

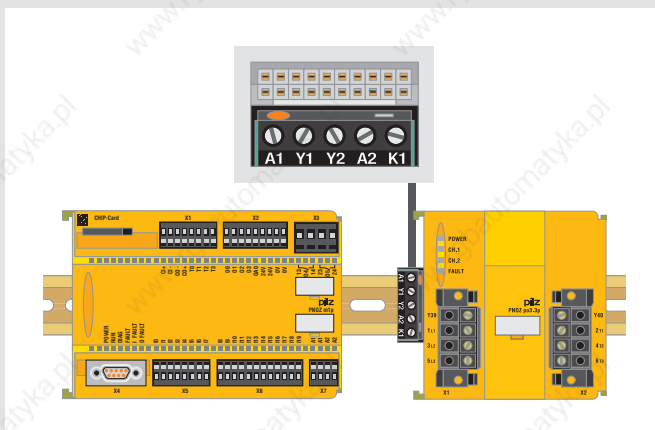

Combine the PNOZpower and PNOZmulti modular safety systems easily using the coupling connector PNOZ pe2p.

Connection to PNOZmulti

PNOZpower modules can be connected to the modular PNOZmulti safety system via the coupling connector PNOZ pe2p.

Keep up-to-date on PNOZpower modular safety systems:





 Webcode 0245

Online information at www.pilz.com





▶ Selection guide – PNOZpower

Modular safety system – PNOZpower

Type	Application area	Application				Performance Level PL (EN ISO 13849-1)
						
PNOZ p1p	Base unit	◆	◆	◆		e
PNOZ p1vp	Base unit, delayed	◆	◆	◆	◆	e (d)
PNOZ pe1p	Control module	For control via safety contacts or safe semiconductor outputs				e
PNOZ pe2p	Bus interface	Coupling connector to connect expansion modules to a higher-level control system				e
PNOZ pps1p	Power supply	-				-

Modular safety system – PNOZpower

Type	Output contacts		Performance Level PL (EN ISO 13849-1)
	Safe	Non-safe	
PNOZ po3p	 3	 1	e
PNOZ po3.1p	8		e
PNOZ po3.2p	4		e
PNOZ po3.3p	3		e
PNOZ po4p	4		e

Safety Integrity Level SIL CL (claim limit in accordance with IEC 62061)	Number of expansion modules	Supply voltage	Housing width in mm
3	Min. 1, max. 4 expansion modules	24 VDC	45
3	Min. 1, max. 8 expansion modules (max. 4 delayed and 4 instantaneous)	24 VDC	45
3	Min. 1, max. 4 expansion modules	24 VDC	22.5
3	Min. 1, max. 6 expansion modules	24 VDC	23.5
-	-	100 ... 240 VAC	45

Safety Integrity Level SIL CL (claim limit in accordance with IEC 62061)	Outputs: Voltage/current/rating			Housing width in mm
	AC1	AC3	DC1	
3	240 V/4 A/960 VA	-	24 V/4 A/96 W	22.5
3	240 V/8 A/2000 VA	-	24 V/8 A/200 W	45
3	240 V/16 A/4000 VA	-	24 V/16 A/400 W	90
3	240 V/16 A/4000 VA 400 V/10 A/4000 VA 500 V/8 A/4000 VA	240 V/3.0 kW 400 V/5.5 kW 500 V/4.0 kW	24 V/16 A/400 W	90
3	240 V/4 A/960 VA	-	24 V/4 A/96 W	22.5

Technical documentation on PNOZpower modular safety systems:

 Webcode 0685

Online information at www.pilz.com



► Technical details – PNOZpower

Modular safety system – PNOZpower



PNOZ p1p



PNOZ pe1p



PNOZ pe2p

Type	Application area	Supply voltage	Dimensions (H x W x D) in mm
PNOZ p1p	Base unit	24 VDC	94 x 45 x 135
PNOZ p1vp	Base unit, delayed	24 VDC	94 x 45 x 135
PNOZ pe1p	Control module	24 VDC	94 x 22.5 x 135
PNOZ pe2p	Bus interface	24 VDC	22 x 23.5 x 29

Features	Order numbers
	Plug-in screw terminals
<ul style="list-style-type: none"> ▶ 2-channel operation, with or without detection of shorts across contacts ▶ Monitored or automatic reset can be selected ▶ 2 semiconductor outputs ▶ Connection between PNOZ p1p and expansion modules via PNOZpower bus, via jumpers on the back of the unit 	773300
<ul style="list-style-type: none"> ▶ 2-channel operation, with or without detection of shorts across contacts ▶ Monitored or automatic reset can be selected ▶ 2 semiconductor outputs ▶ Delay time can be selected via rotary switch and potentiometer ▶ Connection between PNOZ p1vp and expansion modules via PNOZpower bus, via jumpers on the back of the unit 	30 s.....773950 300 s.....773951
<ul style="list-style-type: none"> ▶ 1-channel operation, without detection of shorts across contacts ▶ 2-channel operation, with or without detection of shorts across contacts ▶ Expansion module control output fed at the PNOZpower bus ▶ Connection between PNOZ pe1p and expansion modules via PNOZpower bus, via jumpers on the back of the unit ▶ Status indicator for output relay, supply voltage and fault ▶ Connection for feedback loop 	773900
<ul style="list-style-type: none"> ▶ Control via safety contacts or safe semiconductor outputs ▶ 1-channel operation, without detection of shorts across contacts ▶ Output connected to PNOZpower bus ▶ Connection between PNOZ pe2p and expansion modules via PNOZpower bus 	779125



Technical documentation on PNOZpower modular safety systems:

 Webcode 0685

Online information at www.pilz.com



► Technical details – PNOZpower

Modular safety system – PNOZpower

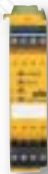

PNOZ po3p



PNOZ po3.2p



PNOZ pps1p

Type	Application area	Inputs/outputs	Supply voltage
PNOZ po3p/ PNOZ po4p	Expansion modules	<ul style="list-style-type: none"> ▶ PNOZ po3p: <ul style="list-style-type: none"> - 3 safety contacts (N/O) - 1 auxiliary contact (N/C) ▶ PNOZ po4p: <ul style="list-style-type: none"> - 4 safety contacts (N/O) 	Via PNOZpower bus
PNOZ po3.1p	Expansion module	▶ 8 safety contacts (N/O)	Via PNOZpower bus
PNOZ po3.2p	Expansion module	▶ 4 safety contacts (N/O)	Via PNOZpower bus
PNOZ po3.3p	Expansion module	▶ 3 safety contacts (N/O)	Via PNOZpower bus
PNOZ pps1p	Power supply	-	100 ... 240 VAC/DC

Outputs: Voltage/current/rating	Dimensions (H x W x D) in mm	Features	Order numbers Plug-in screw terminals
AC1: 240 V/4 A/960 VA DC1: 24 V/4 A/96 W	94 x 22.5 x 135	<ul style="list-style-type: none"> ▶ 2-channel operation with the ability to detect shorts across contacts via the base unit ▶ LEDs for switch status of channels 1/2, supply voltage and fault 	<ul style="list-style-type: none"> ▶ PNOZ po3p.....773 634 ▶ PNOZ po4p.....773 635
AC1: 240 V/8 A/2000 VA DC1: 24 V/8 A/200 W	94 x 45 x 135	<ul style="list-style-type: none"> ▶ 2-channel operation with the ability to detect shorts across contacts via the base unit ▶ LEDs for switch status of channels 1/2, supply voltage and fault 	773 630
AC1: 240 V/16 A/4000 VA, 400 V/10 A/4000 VA DC1: 24 V/16 A/400 W	94 x 90 x 144	<ul style="list-style-type: none"> ▶ 2-channel operation with the ability to detect shorts across contacts via the base unit ▶ LEDs for switch status of channels 1/2, supply voltage and fault 	773 631
AC1: 240 V/16 A/4000 VA; 400 V/10 A/4000 VA; 500 V/8 A/4000 VA AC3: 240 V/3 kW; 400 V/5,5 kW; 500 V/4 kW DC1: 24 V/16 A/400 W	94 x 90 x 144	<ul style="list-style-type: none"> ▶ 2-channel operation with the ability to detect shorts across contacts via the base unit ▶ Suitable for safety-related switching of loads with utilisation category AC3 (e.g. motor) ▶ External start/stop input for non-safety-related load switching ▶ LEDs for switch status of channels 1/2, supply voltage and fault 	773 632
-	94 x 45 x 135	<ul style="list-style-type: none"> ▶ Galvanic isolation ▶ Short circuit-proof ▶ 24 VDC at the plug-in connector on the back of the unit for the PNOZpower bus and at the terminals ▶ LEDs for supply voltage, output voltage and fault 	773 200



Technical documentation on PNOZpower modular safety systems:

 Webcode 0685

Online information at www.pilz.com

▶ AT

Pilz Ges.m.b.H.
Sichere Automation
Modecenterstraße 14
1030 Wien
Austria
Telephone: +43 1 7986263-0
Telefax: +43 1 7986264
E-Mail: pilz@pilz.at

▶ AU

Pilz Australia
Safe Automation
Suite C1, 756 Blackburn Road
Clayton, Melbourne VIC 3168
Australia
Telephone: +61 3 95446300
Telefax: +61 3 95446311
E-Mail: safety@pilz.com.au

▶ BE ▶ LU

Pilz Belgium
Safe Automation
Bijenstraat 4
9051 Gent (Sint-Denijs-Westrem)
Belgium
Telephone: +32 9 3217570
Telefax: +32 9 3217571
E-Mail: info@pilz.be

▶ BR

Pilz do Brasil
Automação Segura
Rua Ártico, 123 - Jd. do Mar
09726-300
São Bernardo do Campo - SP
Brazil
Telephone: +55 11 4337-1241
Telefax: +55 11 4337-1242
E-Mail: pilz@pilzbr.com.br

▶ CH

Pilz Industrieelektronik GmbH
Gewerbepark Hintermättli
Postfach 6
5506 Mägenwil
Switzerland
Telephone: +41 62 88979-30
Telefax: +41 62 88979-40
E-Mail: pilz@pilz.ch

▶ CN

Pilz Industrial Automation
Trading (Shanghai) Co., Ltd.
Safe Automation
Rm. 704-706
No. 457 Wu Lu Mu Qi (N) Road
Shanghai 200040
China
Telephone: +86 21 62494658
Telefax: +86 21 62491300
E-Mail: sales@pilz.com.cn

▶ DE

Pilz GmbH & Co. KG
Sichere Automation
Felix-Wankel-Straße 2
73760 Ostfildern
Germany
Telephone: +49 711 3409-0
Telefax: +49 711 3409-133
E-Mail: pilz.gmbh@pilz.de

▶ DK

Pilz Skandinavien K/S
Safe Automation
Ellegaardvej 25 L
6400 Sonderborg
Denmark
Telephone: +45 74436332
Telefax: +45 74436342
E-Mail: pilz@pilz.dk

▶ ES

Pilz Industrieelektronik S.L.
Safe Automation
Camí Ral, 130
Polígono Industrial Palou Nord
08400 Granollers
Spain
Telephone: +34 938497433
Telefax: +34 938497544
E-Mail: pilz@pilz.es

▶ FI

Pilz Skandinavien K/S
Safe Automation
Nuijamiestentie 5 A
00400 Helsinki
Finland
Telephone: +358 9 27093700
Telefax: +358 9 27093709
E-Mail: pilz.fi@pilz.dk

▶ FR

Pilz France Electronic
1, rue Jacob Mayer
BP 12
67037 Strasbourg Cedex 2
France
Telephone: +33 3 88104000
Telefax: +33 3 88108000
E-Mail: siege@pilz-france.fr

▶ GB

Pilz Automation Technology
Safe Automation
Willow House, Medicott Close
Oakley Hay Business Park
Corby
Northants NN18 9NF
United Kingdom
Telephone: +44 1536 460766
Telefax: +44 1536 460866
E-Mail: sales@pilz.co.uk

▶ IE

Pilz Ireland Industrial Automation
Cork Business and Technology Park
Model Farm Road
Cork
Ireland
Telephone: +353 21 4346535
Telefax: +353 21 4804994
E-Mail: sales@pilz.ie

▶ IT

Pilz Italia Srl
Automazione sicura
Via Meda 2/A
22060 Novedrate (CO)
Italy
Telephone: +39 031 789511
Telefax: +39 031 789555
E-Mail: info@pilz.it

▶ JP

Pilz Japan Co., Ltd.
Safe Automation
Shin-Yokohama Fujika Building 5F
2-5-9 Shin-Yokohama
Kohoku-ku
Yokohama 222-0033
Japan
Telephone: +81 45 471-2281
Telefax: +81 45 471-2283
E-Mail: pilz@pilz.co.jp

▶ KR

Pilz Korea Ltd.
Safe Automation
9F Jo-Yang Bld. 50-10
Chungmuro2-Ga Jung-Gu
100-861 Seoul
Republic of Korea
Telephone: +82 2 2263 9541
Telefax: +82 2 2263 9542
E-Mail: info@pilzkorea.co.kr

▶ MX

Pilz de Mexico, S. de R.L. de C.V.
Automatización Segura
Circuito Pintores # 170
Cd. Satellite
C.P. 53100
Naucalpan de Juarez, Edo. de Mexico
Mexico
Telephone: +52 55 5572 1300
Telefax: +52 55 5572 4194
E-Mail: info@mx.pilz.com

▶ NL

Pilz Nederland
Veilige automatisering
Postbus 186
4130 ED Vianen
Netherlands
Telephone: +31 347 320477
Telefax: +31 347 320485
E-Mail: info@pilz.nl

▶ ...

In many countries we are represented by sales partners.

Please refer to our homepage for further details or contact our headquarters.

Pilz GmbH & Co. KG
Sichere Automation
Felix-Wankel-Straße 2
73760 Ostfildern, Germany
Telephone: +49 711 3409-0
Telefax: +49 711 3409-133
E-Mail: pilz.gmbh@pilz.de

▶ NZ

Pilz New Zealand
Safe Automation
5 Nixon Road
Mangere
Auckland
New Zealand
Telephone: +64 9 6345350
Telefax: +64 9 6345352
E-Mail: t.catterson@pilz.co.nz

▶ PL

Pilz Polska Sp. z o.o.
Safe Automation
ul. Odlewnicza 1
03-231 Warszawa
Poland
Telephone: +48 22 8847100
Telefax: +48 22 8847109
E-Mail: pilz.pl@pilz.de

▶ PT

Pilz Industrieelektronik S.L.
R. Eng Duarte Pacheco, 120
4 Andar Sala 21
4470-174 Maia
Portugal
Telephone: +351 229407594
Telefax: +351 229407595
E-Mail: pilz@pilz.es

▶ SE

Pilz Skandinavien K/S
Safe Automation
Energigatan 10 B
43437 Kungsbacka
Sweden
Telephone: +46 300 13990
Telefax: +46 300 30740
E-Mail: pilz.se@pilz.dk

▶ TR

Pilz Emniyet Otomasyon
Ürünleri ve Hizmetleri Tic. Ltd. Şti.
İsmail Paşa Sokak No: 8
Koşuyolu/Kadiköy
34718 İstanbul
Turkey
Telephone: +90 216 5452910
Telefax: +90 216 5452913
E-Mail: pilz.tr@pilz.de

▶ US ▶ CA

Pilz Automation Safety L.P.
7150 Commerce Boulevard
Canton
Michigan 48187
USA
Telephone: +1 734 354 0272
Telefax: +1 734 354 3355
E-Mail: info@pilzusa.com

▶ www

www.pilz.com

▶ Technical support

+49 711 3409-444



pilz
more than automation
safe automation