

Altivar 38 Telemecanique

User's manual

Variable speed controllers
for asynchronous motors,



When the drive is powered up, the power components and some of the control components are connected to the line supply. It is extremely dangerous to touch them. The drive cover must be kept closed.

After the ALTIVAR has been switched off and the green LED has gone out, wait for 3 to 10 minutes before working on the equipment. This is the time required for the capacitors to discharge.

The motor can be stopped during operation by inhibiting run commands or the speed reference while the drive remains powered up. If personnel safety requires prevention of sudden restarts, this electronic locking system is not sufficient: fit a cut-off on the power circuit.

The drive is fitted with safety devices which, in the event of a fault, can shut down the drive and consequently the motor. The motor itself may be stopped by a mechanical blockage. Finally, voltage variations, especially line supply failures, can also cause shutdowns.

If the cause of the shutdown disappears, there is a risk of restarting which may endanger certain machines or installations, especially those which must conform to safety regulations.

In this case the user must take precautions against the possibility of restarts, in particular by using a low speed detector to cut off power to the drive if the motor performs an unprogrammed shutdown.

Equipment should be designed in accordance with the specifications laid down in the IEC standards.

As a rule, the drive power supply must be disconnected before any operation on either the electrical or mechanical parts of the installation or machine.

The products and equipment described in this document may be changed or modified at any time, either from a technical point of view or in the way they are operated. Their description can in no way be considered contractual.

The Altivar 38 must be considered as a component: it is neither a machine nor a device ready for use in accordance with European directives (machinery directive and electromagnetic compatibility directive). It is the responsibility of the end user to ensure that the machine meets these standards.

The drive must be installed and set up in accordance with both international and national standards. Bringing the device into conformity is the responsibility of the systems integrator who must observe the EMC directive among others within the European Union.

The specifications contained in this document must be applied in order to comply with the essential requirements of the EMC directive.

Contents

Preliminary Recommendations	68
Selecting a Drive with Heatsink	69
Available Torque	70
Technical Specifications	71
Dimensions - Fan output	73
Mounting and Temperature Conditions	74
Removing the IP 41 Protective Blanking Cover	76
Mounting in a Wall-fixing or Floor-standing Enclosure	77
Access to Terminals - Power Terminals	78
Control Terminals	80
Electromagnetic Compatibility - Wiring	81
Wiring Recommendations, Use	83
Connection Diagrams	84
Keypad operation	87
Access to Menus	88
Access to Menus - Programming Principle	89
Macro-Configurations	90
Display Menu	91
Adjust Menu	92
Drive Menu	95
Control Menu	98
I/O Menu	101
Configurable I/O Application Functions	105
Fault Menu	114
Files Menu	116
Communication and Application Menus / Return to factory settings	118
Operation - Maintenance - Spares and Repairs	119
Faults - causes - remedies	120
Record of configuration and adjustments	123
Summary of menus	125
Index	128

Preliminary Recommendations

Acceptance

Check that the drive reference printed on the label is the same as that on the delivery note corresponding to the purchase order.

Remove the Altivar 38 from its packaging and check that it has not been damaged in transit.

Handling and storage

To ensure the drive is protected before installation, handle and store the device in its packaging.

Handling on installation

The Altivar 38 range comprises 9 sizes of device, with various weights and dimensions.

Small drives can be removed from their packaging and installed without a handling device.

A hoist must be used with large drives; for this reason they are supplied with 4 handling "lugs". The precautions described below must be observed:

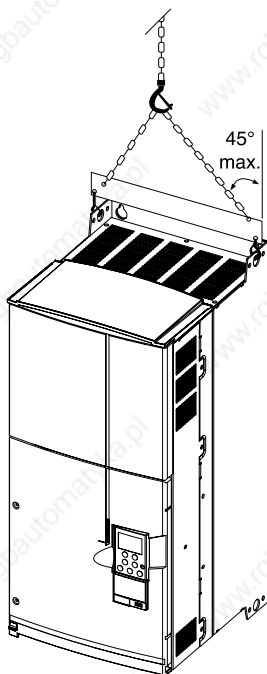

Selecting a Drive with Heatsink

Three-phase supply voltage: 380...460 V 50/60 Hz

Line current at 400 V	Isc prospective line	Motor power (2)	Nominal current (In)	Max. transient current (3)	Power dissipated at nominal load (4)	Reference (5)	Weight
A	kA	kW	A	A	W		kg
3.1	5	0.75	2.1	2.3	55	ATV38HU18N4	3.8
5.4	5	1.5	3.7	4.1	65	ATV38HU29N4	3.8
7.3	5	2.2	5.4	6	105	ATV38HU41N4	3.8
10	5	3	7.1	7.8	145	ATV38HU54N4	6.9
12.3	5	4	9.5	10.5	180	ATV38HU72N4	6.9
16.3	5	5.5	11.8	13	220	ATV38HU90N4	6.9
24.3	22	7.5	16	17.6	230	ATV38HD12N4	13
33.5	22	11	22	24.2	340	ATV38HD16N4	13
43.2	22	15	30	33	410	ATV38HD23N4	15
42	22	18.5	37	41	670	ATV38HD25N4(X)	34
49	22	22	44	49	750	ATV38HD28N4(X)	34
65	22	30	60	66	925	ATV38HD33N4(X)	34
79	22	37	72	80	1040	ATV38HD46N4(X)	34
95	22	45	85	94	1045	ATV38HD54N4(X)	57
118	22	55	105	116	1265	ATV38HD64N4(X)	57
158	22	75	138	152	1730	ATV38HD79N4(X)	57
156 (1)	22	90	173	190	2250	ATV38HC10N4X	49
191 (1)	22	110	211	232	2750	ATV38HC13N4X	75
229 (1)	22	132	253	278	3300	ATV38HC15N4X	77
279 (1)	22	160	300	330	4000	ATV38HC19N4X	77
347 (1)	22	200	370	407	5000	ATV38HC23N4X	159
384 (1)	22	220	407	448	5500	ATV38HC25N4X	166
433 (1)	22	250	450	495	6250	ATV38HC28N4X	168
485 (1)	22	280	503	553	7000	ATV38HC31N4X	168
536 (1)	22	315	564	620	7875	ATV38HC33N4X	168

(4) Current values given with an additional line choke.

(5) These power levels are for a maximum switching frequency of 2 or 4 kHz, depending on the rating, and continuous operation. Switching frequencies are detailed in the section on "Technical Specifications".

Using the ATV38 with a higher switching frequency:

- For continuous operation derate by one power rating, for example:

ATV38HU18N4 for 0.37 kW – ATV38HD12N4 for 5.5 kW.

- If no power derating is applied, do not exceed the following operating conditions:

Cumulative running time 36 s maximum per 60 s cycle (load factor 60%).

(6) For 60 seconds.

(7) These power levels are given for the maximum permissible switching frequency in continuous operation (2 or 4 kHz, depending on the rating).

(8) For ATV38HU18N4 to D79N4: the Altivar 38 is fitted with an integral EMC filter.

For ATV38HD25N4(X) to D79N4(X): add X to the reference to receive an Altivar 38 without integral EMC filter.

For ATV38HC10N4X to C33N4X: the Altivar 38 is not fitted with an integral EMC filter. Optional external filters are available.

Available Torque

Torque characteristics:

- Variable torque applications:

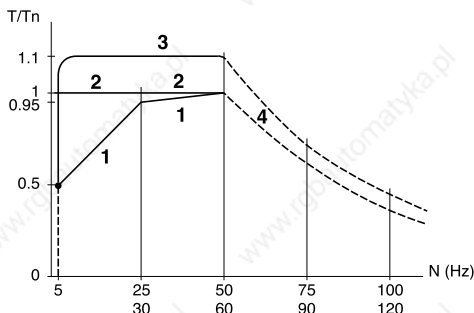

- 1 Self-cooled motor: permanent useful torque
- 2 Force-cooled motor: permanent useful torque
- 3 Transient overtorque for max. 60 seconds.
- 4 Torque at overspeed with constant power

Available overtorque:

Variable torque applications:

- 110% of the nominal motor torque for 60 seconds.

Continuous operation

For self-cooled motors, cooling is linked to the motor speed. Derating therefore occurs at speeds of less than half the nominal speed.

Overspeed operation

As the voltage can no longer change with the frequency, induction in the motor is reduced which results in a reduction in torque. Check with the manufacturer that the motor can operate at overspeed.

Note: With a special motor, the nominal and maximum frequencies can be adjusted between 10 and 500 Hz using the operator terminal or PowerSuite tools.

Technical Specifications

Environment

	ATV38 HU18N4 to ATV38HD23N4	ATV38 HD25N4(X) to ATV38HC33N4X
Degree of protection	IP21 and IP41 on upper part (conforming to EN 50178)	ATV38HD25N4(X) to ATV38HD79N4(X) drives: IP21 and IP41 on upper part (conforming to EN 50178) ATV38HC10N4X to ATV38HC33N4X drives: - IP00 on underside (requires addition of protection against direct contact by personnel) - IP20 on other sides
Vibration resistance	Conforming to IEC 68-2-6: 1.5 mm peak from 2 to 13 Hz 1 gn from 13 to 200 Hz	ATV38HD25N4(X) to ATV38HD79N4(X) drives: Conforming to IEC 68-2-6: 1.5 mm peak from 2 to 13 Hz 1 gn from 13 to 200 Hz ATV38HC10N4X to ATV38HC33N4X drives: 0.6 gn from 10 to 55 Hz
Maximum ambient pollution	ATV38HU18N4 to ATV38 HD23N4 drives: Degree 2 conforming to IEC 664-1 and EN 50718	ATV38HD25N4(X) to ATV38HD79N4(X) drives: - Degree 3 conforming to UL508C ATV38HC10N4X to ATV38 HC33N4X drives: Degree 2 conforming to IEC 664-1 and EN 50718
Maximum relative humidity	93% without condensation or dripping water, conforming to IEC 68-2-3	
Ambient temperature around the unit	Storage: -25 °C to +65 °C Operation: ATV38HU18N4 to ATV38HU90N4 drives: <ul style="list-style-type: none"> -10 °C to +50 °C without derating up to +60 °C with current derating of 2.2% per °C above 50 °C ATV38HD12N4 to ATV38HD23N4 drives: <ul style="list-style-type: none"> -10 °C to +40 °C without derating up to +50 °C with current derating of 2.2% per °C above 40 °C 	Storage: -25 °C to +65 °C Operation: ATV38HD25N4(X) to ATV38HD79N4(X) drives: <ul style="list-style-type: none"> -10 °C to +40 °C without derating up to +60 °C with the ventilation kit with current derating of 2.2% per °C above 40 °C ATV38HC10N4X to ATV38HC33N4X drives: <ul style="list-style-type: none"> -10 °C to +40 °C without derating up to +50 °C with current derating of 2.2% per °C above 40 °C
Maximum operating altitude	1000 m without derating (above this, derate the current by 1% per additional 100 m)	
Operating position	Vertical	

Technical Specifications

Electrical characteristics

Power supply	Voltage	• 380 V - 10% to 460 V + 10% 3-phase
	Frequency	• 50/60 Hz ± 5%
Output voltage	Maximum voltage equal to line supply voltage	
Electrical isolation	Electrical isolation between power and control (inputs, outputs, power supplies)	
Output frequency range	0.1 to 500 Hz	
Switching frequency	Configurable: <ul style="list-style-type: none">• without derating:<ul style="list-style-type: none">0.5 - 1 - 2 - 4 kHz for ATV38HU18N4 to D46N4(X) drives0.5 - 1 - 2 kHz for ATV38HD54N4(X) to C33N4X drives• without derating with intermittent operating cycle or with derating by one power rating in continuous operation:<ul style="list-style-type: none">8 - 12 - 16 kHz for ATV38HU18N4 to D23N4 drives8 - 12 kHz for ATV38HD25N4(X) to D46N4(X) drives4 - 8 kHz for ATV38HD54N4(X) to D79N4(X) drives4 kHz for ATV38HC10N4X to C33N4X drives	
Speed range	1 to 10	
Braking torque	30% of nominal motor torque without braking resistor (typical value) for low power ratings	
Transient overtorque	110% of nominal motor torque (typical values to ±10%) for 60 seconds	
Protection and safety features of drive	<ul style="list-style-type: none">• Short-circuit protection:<ul style="list-style-type: none">- between output phases- between output phases and earth- on internal supply outputs• Thermal protection against overheating and overcurrents• Supply undervoltage and overvoltage safety circuits• Loss of input phase safety circuit (avoids single-phase operation, on all 3-phase drives)	
Motor protection	<ul style="list-style-type: none">• Thermal protection integrated in drive via continuous calculation of I^2t taking speed into account Motor thermal state saved when the drive is switched off. This function can be modified (via the operator terminal or programming terminal or via the PC software), depending on the type of motor cooling• Protection against motor phase breaks• Protection via PTC probes with option card	

Dimensions - Fan output

Dimensions

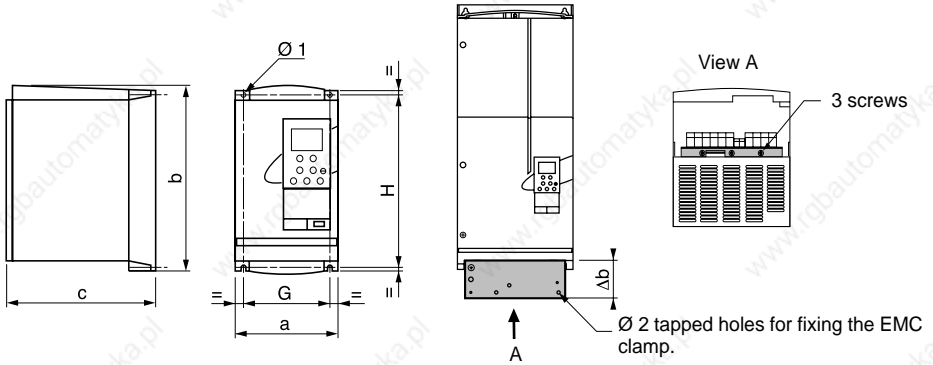

The EMC mounting plate is supplied with clamps for ATV38HU18N4 to D79N4(X) drives. Fix the EMC equipotentiality mounting plate to the holes in the ATV38 heatsink using the screws supplied, as shown in the drawings above.

	EMC mounting plate								
	a	b	c	G	H	Ø1	Δ b	Ø2	
ATV38H									
U18N4, U29N4, U41N4	150	230	184	133	210	5	64.5	4	
U54N4, U72N4, U90N4	175	286	184	155	270	5.5	64.5	4	
D12N4, D16N4	230	325	210	200	310	5.5	76	4	
D23N4	230	415	210	200	400	5.5	76	4	
D25N4(X), D28N4(X), D33N4(X), D46N4(X)	240	550	283	205	530	7	80	5	
D54N4(X), D64N4(X), D79N4(X)	350	650	304	300	619	9	110	5	
C10N4X	370	630	360	317.5	609	12			
C13N4X, C15N4X, C19N4X	480	680	400	426	652	12			
C23N4X, C25N4X, C28N4X, C31N4X, C33N4X	660	950	440	598	920	15			

Fan output

ATV38HU18N4	not cooled
ATV38HU29N4, U41N4, U54N4	36 m ³ /hour
ATV38HU72N4, U90N4, D12N4, D16N4, D23N4	72 m ³ /hour
ATV38HD25N4(X), HD28N4(X), D33N4(X), D46N4(X)	292 m ³ /hour
ATV38HD54N4(X), D64N4(X), D79N4(X)	492 m ³ /hour
ATV38HC10N4X	600 m ³ /hour
ATV38HC13N4X, C15N4X, C19N4X	900 m ³ /hour
ATV38HC23N4X, C25N4X, C28N4X, C31N4X, C33N4X	900 m ³ /hour

Mounting and Temperature Conditions

Install the unit vertically to within $\pm 10^\circ$.

Do not place it close to heating elements.

Leave sufficient free space to ensure that the air required for cooling purposes can circulate from the bottom to the top of the unit.

ATV38HU18N4 to D23N4

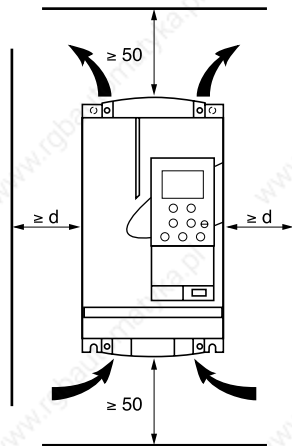

Free space in front of unit: 10 mm minimum.

ATV38HU18N4 to U90N4:

From -10°C to 40°C : $d \geq 50$ mm: no special precautions.

$d = 0$: remove the protective blanking cover from the top of the drive as shown overleaf (the degree of protection is then IP 20).

From 40°C to 50°C : $d \geq 50$ mm: remove the protective blanking cover from the top of the drive as shown overleaf (the degree of protection is then IP 20).

$d = 0$: add control ventilation kit VW3A5882• (see ATV38 catalogue).

From 50°C to 60°C : $d \geq 50$ mm: add control ventilation kit VW3A5882• (see ATV38 catalogue).
Derate the operating current by 2.2% per $^\circ\text{C}$ over 50°C .

ATV38HD12N4 to D23N4:

From -10°C to 40°C : $d \geq 50$ mm: no special precautions.

$d = 0$: remove the protective blanking cover from the top of the drive as shown overleaf (the degree of protection is then IP 20).

From 40°C to 50°C : $d \geq 50$ mm: remove the protective blanking cover from the top of the drive as shown overleaf (the degree of protection is then IP 20).
Derate the current by 2.2% per $^\circ\text{C}$ over 40°C .

$d = 0$: add control ventilation kit VW3A5882 (see ATV38 catalogue). Derate the current by 2.2% per $^\circ\text{C}$ over 40°C .

Mounting and Temperature Conditions

ATV38HD25N4(X) to D79N4(X)

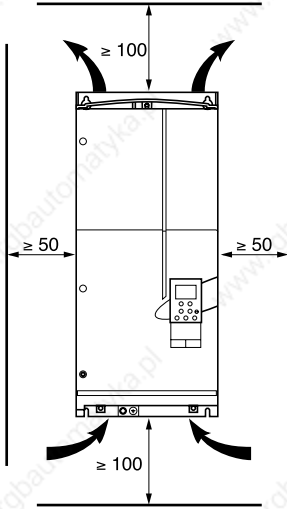

- Free space in front of unit: 50 mm minimum.
- From - 10 °C to 40 °C: no special precautions.
- From 40 °C to 60 °C: add control ventilation kit VW3A588*** (see ATV38 catalogue). Derate the current by 2.2% per °C over 40 °C.

ATV38HC10N4X to C23N4X

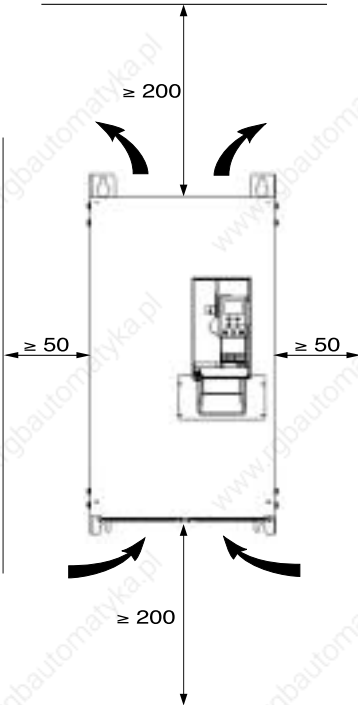

- Free space in front of unit: 50 mm minimum.
- From - 10 °C to 40 °C: no special precautions.
- Up to 50 °C, derating the operating current by 2.2% for each °C above 40 °C.

Removing the IP 41 Protective Blanking Cover

ATV38HU18N4 to U90N4

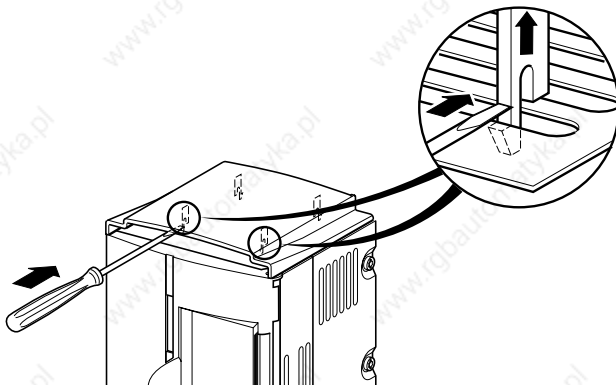

ATV38HD12N4 to D23N4

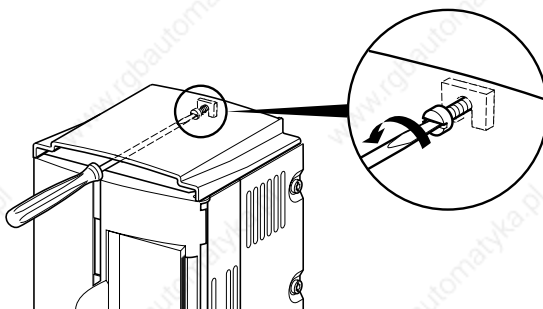

ATV38HD25N4(X) to D79N4(X)

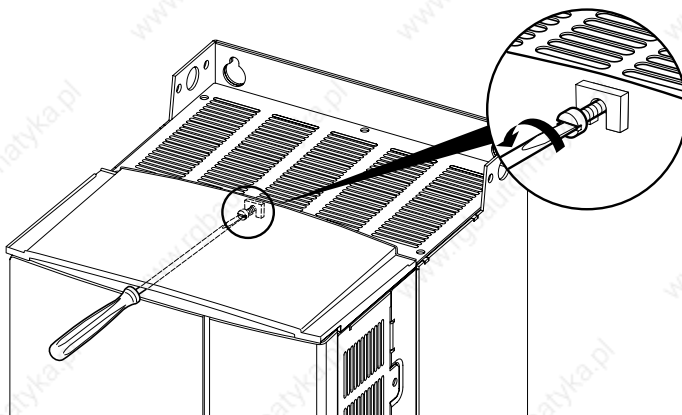

Mounting in a Wall-fixing or Floor-standing Enclosure

Observe the mounting recommendations on the previous page.

To ensure proper air circulation in the drive:

- Fit ventilation grilles
- Ensure that ventilation is adequate: if not, install forced ventilation with a filter
- Use special IP 54 filters

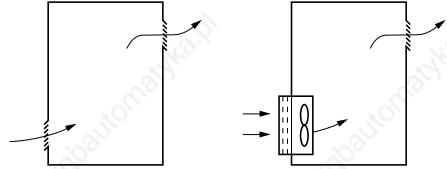

Dust and damp proof metal wall-fixing or floor-standing enclosure (IP 54 degree of protection)

The drive must be mounted in a dust and damp proof casing in certain environmental conditions: dust, corrosive gases, high humidity with risk of condensation and dripping water, splashing liquid, etc.

To avoid hot spots in the drive, add a fan to circulate the air inside the enclosure, reference VW3A5882• (see ATV38 catalogue).

This enables the drive to be used in an enclosure where the maximum internal temperature can reach 60 °C.

Calculating the size of the enclosure

Maximum thermal resistance R_{th} (°C/W) :

$$R_{th} = \frac{\theta^{\circ} - \theta^{\circ}e}{P}$$

θ° = maximum temperature inside enclosure in °C
 $\theta^{\circ}e$ = maximum external temperature in °C
 P = total power dissipated in the enclosure in W

Power dissipated by the drive: see section Selecting a drive.
Add the power dissipated by the other equipment components.

Useful heat dissipation surface of enclosure S (m²):
(sides + top + front panel if wall-mounted)

$$S = \frac{K}{R_{th}} \quad K = \text{enclosure thermal resistance per m}^2$$

For metal enclosure: $K = 0.12$ with internal fan
 $K = 0.15$ without fan

Caution: Do not use insulated enclosures, as they have a poor level of conductivity.

Access to Terminals - Power Terminals

Access to terminals

Switch off the drive.

ATV38HU18N4 to ATV38HD79N4(X):

- control terminals: unlock and open the hinged cover
- power terminals: accessible on the underside of the Altivar 38

Location of terminals: on the underside of the Altivar.

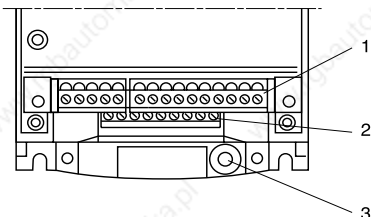

- 1 Control
- 2 Power
- 3 Terminal for connection of a protective conductor, 10 mm² cross-section conforming to EN50178 (earth leakage current)

ATV38HC10N4X to HC33N4X:





- the control and power terminals can be accessed by removing the front cover

Power terminals

Terminal characteristics

Altivar ATV38H	Terminals	Maximum connection capacity		Tightening torque in Nm
		AWG	mm ²	
U18N4, U29N4, U41N4	all terminals	AWG 8	6	0.75
U54N4, U72N4, U90N4	all terminals	AWG 8	6	0.75
D12N4, D16N4, D23N4	all terminals	AWG 6	10	2
D25N4(X), D28N4(X)	L1, L2, L3, U, V, W, ⏚	AWG 4	16	3
D33N4(X), D46N4(X)	L1, L2, L3, U, V, W, ⏚	AWG 2	35	4
D54N4(X), D64N4(X), D79N4(X)	L1, L2, L3, U, V, W, ⏚	AWG 2/0	70	10
C10N4X	⏚	AWG 3/0	60	8
	other terminals	AWG 3/0	100	16
C13N4X	⏚	AWG 4/0	60	16
	other terminals	AWG 4/0	100	16
C15N4X	⏚	AWG 1/0 x 2	60	16
	other terminals	AWG 1/0 x 2	100	16
C19N4X	⏚	AWG 3/0 x 2	100	16
	other terminals	AWG 3/0 x 2	150	16
C23N4X	⏚	AWG 4/0 x 2	100	32
	other terminals	AWG 4/0 x 2	200	32



Power Terminals

Altivar ATV38H	Terminals	Maximum connection capacity		Tightening torque in Nm
		AWG	mm ²	
C25N4X		AWG 2/0 x 3 - AWG 300 x 2	100	32
	other terminals	AWG 2/0 x 3 - AWG 300 x 2	200	32
C28N4X		AWG 3/0 x 3 - AWG 350 x 2	150	32
	other terminals	AWG 3/0 x 3 - AWG 350 x 2	150 x 2	32
C31N4X,		AWG 4/0 x 3 - AWG 400 x 2	150	32
	other terminals	AWG 4/0 x 3 - AWG 400 x 2	150 x 2	32
C33N4X		AWG 250 x 3 - AWG 500 x 2	150	32
	other terminals	AWG 250 x 3 - AWG 500 x 2	150 x 2	32



Terminal layout

	L1	L2	L3	PA	PB	U	V	W	
---	----	----	----	----	----	---	---	---	---

ATV38HU18N4 to D23N4

	L1	L2	L3	+	-	PA	PB	U	V	W	
---	----	----	----	---	---	----	----	---	---	---	---

ATV38HD25N4(X) and D79N4(X)

				+	+	-	
	L1	L2	L3	U	V	W	

ATV38HC10N4X

L1	L2	L3		
+		-		
			U	V
			W	

ATV38HC13N4X to C19N4X

L1	L2	L3		
-			+	+
			U	V
			W	

ATV38HC23N4X to C33N4X

 Do not use

Terminal functions

Terminals	Function	For Altivar ATV38H
	Altivar ground terminal	All ratings
L1 L2 L3	Power supply	All ratings
+	DC bus outputs	All ratings except HU18N4 to HD23N4
-		
PA PB	Not used	ATV38HU18N4 to HD79N4(X)
U V W	Outputs to motor	All ratings

Control Terminals

Terminal characteristics:

- Shielding connection terminal: for metal clamp or tag connector
- 2 removable terminals, one for the relay contacts, the other for the low-level I/O
- Maximum connection capacity : 1.5 mm² - AWG 14
- Max. tightening torque: 0.4 Nm

Terminal layout:

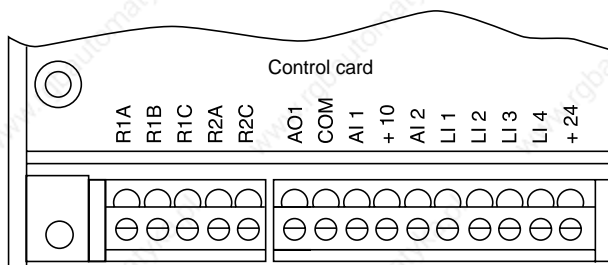

Terminal functions

Terminal	Function	Electrical characteristics
R1A R1B R1C	Common point C/O contact (R1C) of R1 fault relay	Min. switching capacity • 10 mA for 24 V _{DC} Max. switching capacity on inductive load (cos φ 0.4 and L/R 7 ms): • 1.5 A for 250 V _{AC} and 30 V _{DC}
R2A R2C	N/O contact of R2 programmable relay	
AO1	Analog current output	X-Y mA analog output, where X and Y can be configured Factory setting 0 - 20 mA impedance 500 Ω
COM	Common for logic and analog inputs	
AI1	Analog voltage input	Analog input 0 + 10 V impedance 30 kΩ
+10	Power supply for reference potentiometer 1 to 10 kΩ	+10 V (- 0, + 10%) 10 mA max. short-circuit and overload protection
AI2	Analog current input	X-Y mA analog input, where X and Y can be configured Factory setting 4 - 20 mA impedance 100 Ω
LI1 LI2 LI3 LI4	Logic inputs	Programmable logic inputs impedance 3.5 kΩ + 24 V power supply (max. 30 V) State 0 if < 5 V, state 1 if > 11 V
+ 24	Power supply for inputs	+ 24 V protected against short-circuits and overloads, min. 18 V, max. 30 V Max. current 200 mA

Altivar 38 with integral EMC filter ATV38HU18N4 to HD79N4

Principle

- Grounds between drive, motor and cable shielding must have "high frequency" equipotentiality.
- Use shielded cables with shielding connected to the ground at both ends of the motor cable, braking resistor (if fitted) and control-signalling cables. Conduit or metal ducting can be used for part of the shielding length provided that there is no break in continuity.
- Ensure maximum separation between the power supply cable (line supply) and the motor cable.

Installation diagram

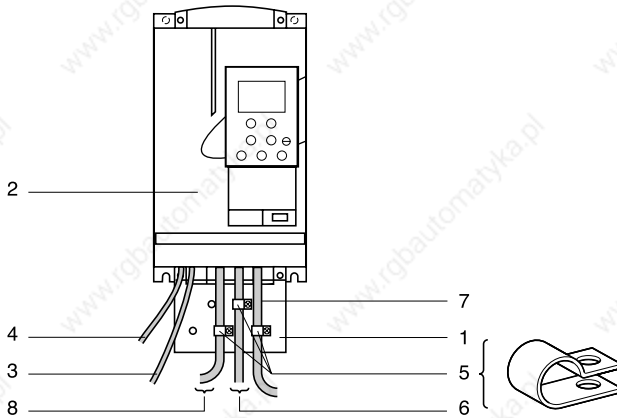

- 1 Sheet steel machine ground supplied with the drive, to be fitted as indicated on the diagram.
- 2 Altivar 38.
- 3 Non-shielded power supply wires or cable.
- 4 Non-shielded wires for the output of the safety relay contacts.
- 5 Fix and ground the shielding of cables 6, 7 and 8 as close as possible to the drive:
 - strip the cable to expose the shielding
 - use the clamps supplied to fix the stripped part of the shielding to the metal plate 1The shielding must be clamped tightly enough to the metal plate to ensure good contact.
- 6 Shielded cable for motor connection with shielding connected to ground at both ends.
The shielding must be continuous and intermediate terminals must be in EMC shielded metal boxes.
- 7 Shielded cable for connecting the control/signalling wiring.
For applications requiring several conductors, use small cross-sections (0.5 mm^2).
The shielding must be connected to ground at both ends. The shielding must be continuous and intermediate terminals must be in EMC shielded metal boxes.
- 8 Shielded cable for connecting braking resistor (if fitted). The shielding must be connected to ground at both ends. The shielding must be continuous and intermediate terminals must be in EMC shielded metal boxes.

Note:

- If using an additional input filter, it should be mounted behind the drive and connected directly to the line supply via an unshielded cable. Link 3 to the drive is then via the filter output cable.
- The HF equipotential ground connection between the drive, motor and cable shielding does not remove the need to connect the PE protective conductors (green-yellow) to the appropriate terminals on each unit.

Electromagnetic Compatibility - Wiring

Altivar 38 without integral EMC filter ATV38HC10N4X to HC33N4X

Line chokes are compulsory if the line supply prospective short-circuit current is less than 22 kA. These chokes can be used to provide improved protection against overvoltages on the line supply and to reduce harmonic distortion of the current produced by the drive. The chokes are used to limit the line current.

Principle

- Grounds between drive, motor and cable shielding must have "high frequency" equipotentiality.
- Use shielded cables with shielding connected to the ground at both ends of the motor cable, and control-signalling cables. Conduit or metal ducting can be used for part of the shielding length provided that there is no break in continuity.
- Ensure maximum separation between the power supply cable (line supply) and the motor cable.

Power wiring

The power wiring should consist of cables with 4 conductors or individual cables maintained as close as possible to the PE cable. Take care to route the motor cables well away from the power supply cables.

The power supply cables are not shielded. If a radio interference filter is used, the grounds for the filter and the drive should be at the same potential with low-impedance links at high frequency (fixed to unpainted metal plate with anti-corrosion treatment/machine ground wiring). The filter should be fitted as close as possible to the drive.

If the environment is sensitive to radiated radio interference, the motor cables should be shielded. On the drive side, fix and connect the shielding to the machine ground with rustproof clamps. The main function of the motor cable shielding is to limit their radio frequency radiation. Therefore, use 4-pole cables for the motor, connecting each end of the shielding in accordance with established practice for High Frequency wiring. The type of protective material (copper or steel) is less important than the quality of the connection at both ends. An alternative is to use a metal cable duct with good conductivity and no break in continuity.

Note: when using a cable with a protective sleeve (NYCY type) which fulfils the dual function of PE + screen, it must be connected correctly to both the drive and the motor (its radiation efficiency is reduced).

Control wiring

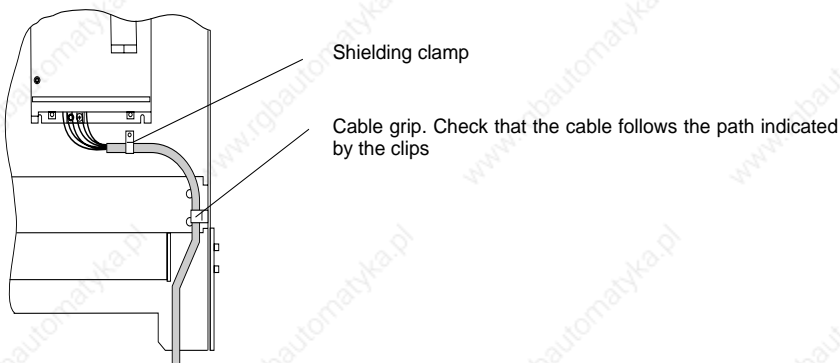

Wiring Recommendations, Use

Wiring recommendations

Power

Observe the cable cross-sectional areas recommended in the standards.

The drive must be earthed to conform with the regulations concerning high leakage currents (over 3.5 mA). Do not use a residual current device for upstream protection on account of the DC elements which may be generated by leakage currents. If the installation involves several drives on the same line, each drive must be earthed separately. If necessary, fit a line choke (consult the catalogue).

Keep the power cables separate from circuits in the installation with low-level signals (detectors, PLCs, measuring apparatus, video, telephone).

Control

Keep the control circuits away from the power cables. For control and speed reference circuits, we recommend using shielded twisted cables with a pitch of between 25 and 50 mm connecting the shielding to each end.

Recommendations for use

With power switching via line contactor:



- **Avoid operating contactor KM1 frequently** (premature ageing of the filter capacitors). **Use inputs LI1 to LI4 to control the drive**

- **these steps are essential in the event of cycles:**

of less than 60 seconds for ATV38HU18N4 to HD79N4(X)

of less than 180 seconds for ATV38HC10N4X to ATV38HC33N4X

If safety standards necessitate isolation of the motor, fit a contactor on the drive output and use the "downstream contactor control" function (consult the programming manual).

Fault relay, unlocking

The fault relay is energized when the drive is powered up and is not faulty. It has one C/O contact at the common point.

The drive is unlocked after a fault by:

- powering down the drive until both the display and indicator lamps go out, then powering up again
- automatically or remotely via logic input: **consult the programming manual**

Connection Diagrams

3-phase power supply

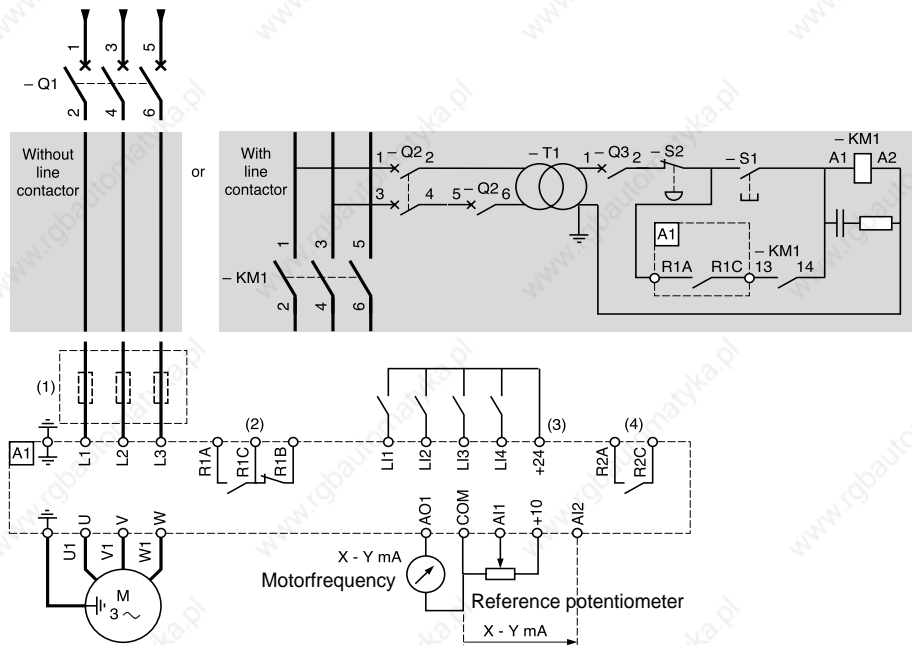

- (1) ATV38HC10N4X to C33N4X: Line choke compulsory.
ATV38HU18N4 to D23N4: Line choke if necessary.
- (2) Fault relay contacts for remote signalling of drive status.
- (3) Internal + 24 V. If an external + 24 V supply is used, connect the 0 V from that source to the COM terminal, do not use the + 24 terminal on the drive, and connect the common of the LI inputs to the + 24 V of the external supply.
- (4) R2 reassignable relay.

Note:

Fit interference suppressors to all inductive circuits near the drive or connected in the same circuit, such as relays, contactors, solenoid valves, fluorescent lighting, etc.

Components which can be used in association with the Altivar: see catalogue.

Connection Diagrams

Diagram with downstream contactor for ATV38HD25N4(X) to C33N4X.

The shaded part should be added to the 3-phase power supply diagram.

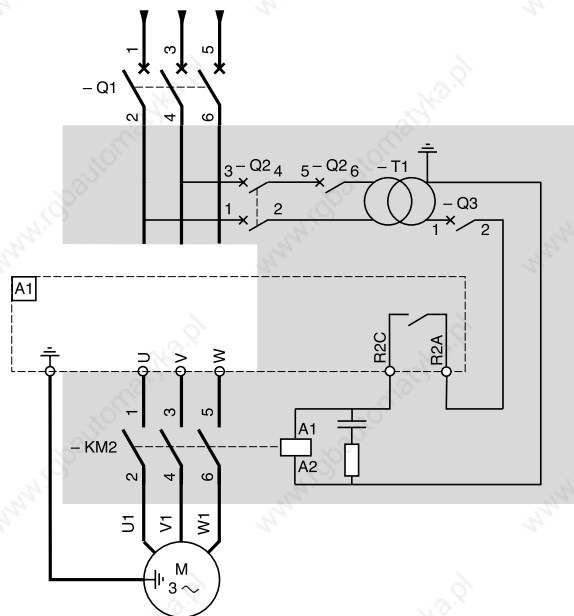

Use the "downstream contactor control" function with relay R2, or logic output LO (---24V) switching the coil using an I/O extension card. Consult the programming manual.

Note: Fit interference suppressors to all inductive circuits near the drive or connected in the same circuit, such as relays, contactors, solenoid valves, fluorescent lighting, etc.

Components which can be used in association with the Altivar: see catalogue.

24 V external supply for supplying logic inputs

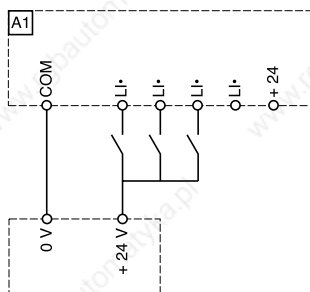





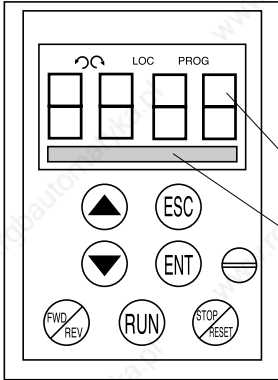

Keypad operation

Front panel





Use of keys and meaning of displays

- 

 - Flashing: indicates the selected direction of rotation
 - Steady: indicates the direction of motor rotation
- LOC Indicates control via the terminal
- PROG Appears in setup and programming mode
- Flashing: indicates that a value has been modified but not saved
- 4-character display: displays numeric values and codes
- One line of 16 characters: displays messages in plain text

- 

 Scroll through menus or parameters and adjust a value.
- 
 Return to the previous menu or abort the current adjustment and return to the original value.
- 
 Select a menu, confirm and save a selection or adjustment.

If control via the terminal is active:

- 
 Reverses the direction of rotation.
- 
 Command to start the motor running.
- 
 Command to stop the motor or reset the fault. The key's "STOP" function can be inhibited via the program ("CONTROL" menu).



Use the display module delivered with the ATV38 or a version 5.1 or above display module (see label on the rear view).

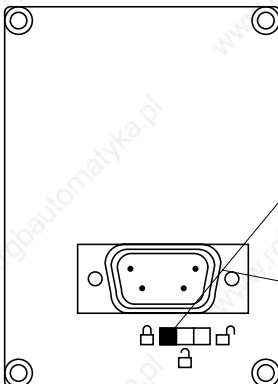

Rear view



Notes:

The operator terminal may be connected and disconnected with the power on. If the terminal is disconnected when control of the drive via the terminal is enabled, the drive locks in fault mode SLF.

Access locking switch:

- position  : Adjustment and configuration not accessible
- position  : Adjustment accessible
- position  : Adjustment and configuration accessible

Connector:

- for direct connection of the terminal to the drive
- for remote operation, the terminal can be connected via a cable provided in the VW3A58103 kit

Remote mounting of the terminal:

Use the kit, reference VW3A58103, comprising 1 cable with connectors, the kit for mounting on an enclosure door and the installation guide.

Access to Menus

The number of menus which can be accessed depends on the position of the access locking switch. Each menu is made up of a number of parameters.

Language: French, English, German, Spanish, Italian

Macro-config: variable torque (factory setting)

If an input/output has been reassigned,

C u 5: Customised is displayed

Identification: display of the drive power and voltage

Display: display of electrical values, operation or fault

Adjust: configuration of parameters which can be accessed while the motor is rotating

Drive: motor-drive configuration

Control: configuration of drive control: terminal strip, operator terminal, RS485

I/O: configuration of the I/O assignment

Faults: configuration of the behaviour of the motor-drive in the event of a fault, and the protection devices

Files: saving and restoring the configuration or return to factory settings

Only accessible if the "application" or "communication" card is installed

CAUTION: If an access code has already been programmed, it may be impossible to modify some menus; these may not even be visible. In this case, see the section entitled "FILES menu" explaining how to enter the access code.

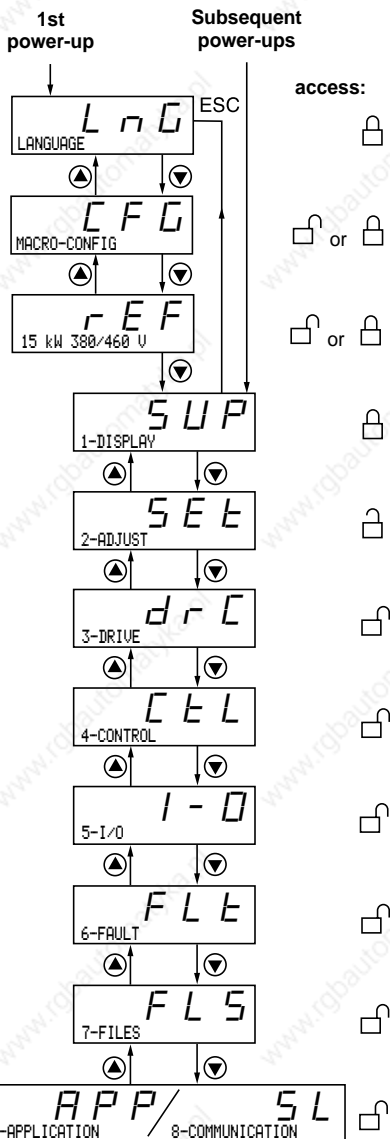

Access to Menus - Programming Principle

Language:

This menu can be accessed whatever position the access switch is in, and can be modified in stop or run mode.

Example :

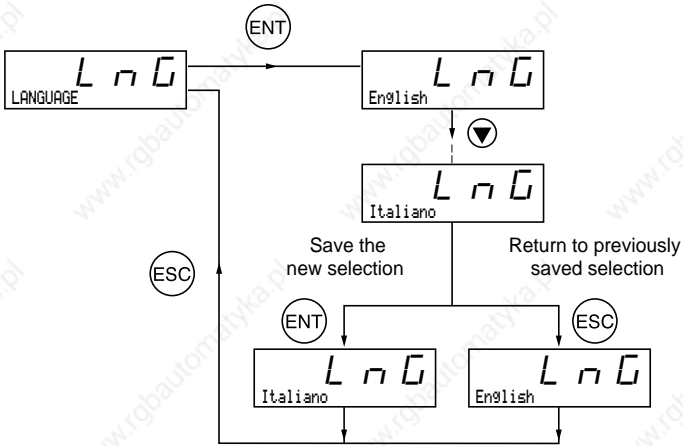

Possible selections: English (factory setting), French, German, Spanish, Italian.

Programming principle:

The principle is always the same, with 1 or 2 levels:

- 1 level: see the "language" example above.
- 2 levels: see the "acceleration ramp" example below.

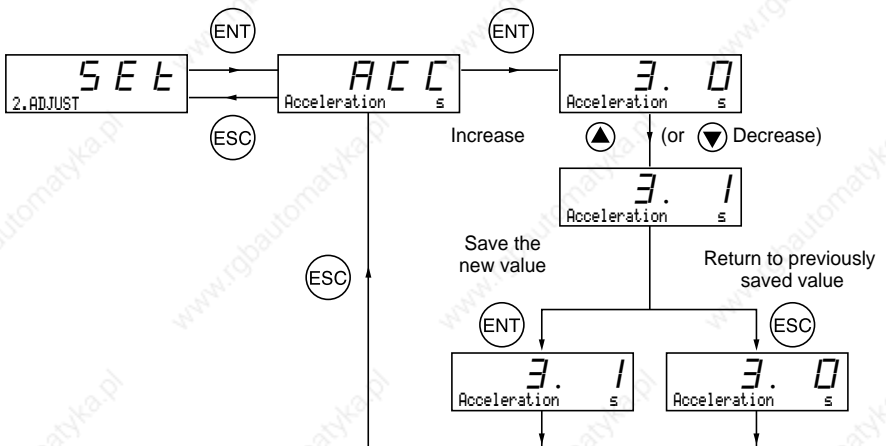

Macro-Configurations

This parameter can always be displayed and indicates whether an input/output has been reassigned. Factory macro-configuration = Variable torque

Customizing the configuration:

The drive configuration can be customized by changing the I/O assignment in the I/O menu which can be accessed in programming mode (access switch in position).

This customization modifies the displayed macro-configuration value:

display of



I/O assignment in variable torque macro-configuration

Logic input LI1	forward	Logic input LI5	ramp switching
Logic input LI2	reverse	Logic input LI6	Not assigned
Logic input LI3	Fault reset	Analog input AI3 or	summed ref.
Logic input LI4	Not assigned	Inputs A, A+, B, B+	summed ref.
Analog input AI1	motor frequency	Logic output LO	high speed reached
Analog input AI2	summed ref.	Analog output AO	motor current
Relay R1	drive fault		
Relay R2	drive running		
Analog output AO1	motor frequency		

 The assignments with a grey background appear if an I/O extension card has been installed.

Display Menu



Display menu (selection of parameter displayed during operation)

The following parameters can be accessed whatever position the access switch is in, stop or run mode.

Code	Function	Unit
	Drive State	–
---	State of the drive: indicates a fault or the motor operation:	
rdY	rdY = drive ready	
rUn	rUn = motor in steady state or run command present and zero reference	
ACC	ACC = accelerating	
dEC	dEC = decelerating	
CLl	CLl = current limit	
dCb	dCb = injection braking	
nSt	nSt = freewheel stop control	
Obr	Obr = braking by adapting the deceleration ramp (see the "drive" menu)	
FrH	Freq. Ref.	Hz
	Frequency reference	
rFr	Output Freq.	Hz
	Output frequency applied to the motor	
SPd	Motor Speed	rpm
	Motor speed estimated by the drive	
LcR	MotorCurrent	A
	Motor current	
USP	Machine Spd.	–
	Machine speed estimated by the drive. This is proportional to rFr, according to a coefficient USC which can be regulated in the adjust menu. Displays a value corresponding to the application (metres/second, for example). Caution, if USP becomes greater than 9999 the display is divided by 1000.	
DPr	Output Power	%
	Power supplied by the motor, estimated by the drive. 100% corresponds to nominal power.	
ULn	MainsVoltage	V
	Line voltage	
tHr	MotorThermal	%
	Thermal state: 100% corresponds to the nominal thermal state of the motor. Above 118%, the drive triggers an OLF fault (motor overload)	
tHd	DriveThermal	%
	Thermal state of the drive: 100% corresponds to the nominal thermal state of the drive. Above 118%, the drive triggers an OHF fault (drive overheating). It can be reset below 70%.	
LfL	Last Fault	–
	Displays the last fault which occurred.	
LFr	Freq. Ref.	Hz
	This adjustment parameter appears instead of the FrH parameter when drive control via the terminal is activated: LCC parameter in the control menu	
APH	Power Used	kWh or MWh
	Energy consumption	
rtH	Run Time	hr
	Continuous operating time (motor powered up), in hours	

Adjust Menu



This menu can be accessed when the switch  and . Adjustment parameters can be modified in stop mode OR during operation. Ensure that any changes made during operation are not dangerous; changes should preferably be made in stop mode.

List of adjustment parameters which can be accessed in the factory configuration, without an I/O extension card present.

Code	Description	Adjustment range	Factory setting
LFr	Freq. Ref. - Hz	LSP to HSP	-
	Appears when control via the terminal is activated: parameter LC in the control menu		
ACC DEC	Acceleration - s	0.05 to 999.9	3 s
	Deceleration - s	0.05 to 999.9	3 s
Acceleration and deceleration ramp times (0 to nominal motor frequency (FrS)).			
LSP	Low Speed - Hz	0 to HSP	0 Hz
	Low speed		
HSP	High Speed - Hz	LSP to tFr	50 Hz
	High speed: ensure that this setting is suitable for the motor and the application.		
FLG	Gain - %	0 to 100	20
	Frequency loop gain: used to adapt the response of the machine speed according to the dynamics. For high resistive torque, high inertia or fast cycle machines, increase the gain gradually.		
StA	Stability - %	0 to 100	20
	Used to adapt the return to steady state after a speed transient, according to the dynamics of the machine. Gradually increase the stability to avoid any overspeed.		
lth	ThermCurrent - A	0.25 to 1.1 In (1)	According to drive rating
	Current used for the motor thermal protection. Set lth to the nominal current on the motor rating plate.		
tdC	DC Inj. Time - s	0 to 30 s Cont	0.5 s
	DC injection braking time. If this is increased to more than 30 s, "Cont" is displayed, Continuous current injection. The injection current will equal SdC after 30 s.		
FFt	NST Threshold - Hz	0 to HSP	0 Hz
	Freewheel stop trip threshold: on a stop on ramp or fast stop request, the selected type of stop is activated until the speed drops below this threshold. Below this threshold, freewheel stopping is activated.		
JPF JF2 JF3	Jump Freq. - Hz	0 to HSP	0 Hz
	Jump frequency: prohibits prolonged operation over a frequency range of +/-2.5 Hz around JPF. This function prevents a critical speed which leads to resonance.		
USC	Machine Coef	0.01 to 100	1
	Coefficient applied to parameter rFr (output frequency applied to the motor), the machine speed is displayed via parameter USP: USP = rFr x USC		
tL5	LSP Time - s	0 to 999.9	0 (no time limit)
	Low speed operating time. After operating at LSP for a given time, the motor is stopped automatically. The motor restarts if the frequency reference is greater than LSP and if a run command is still present. Caution : value 0 corresponds to an unlimited period		

(1) In is the drive nominal current shown in the catalogue and on the rating plate.

Adjust Menu

The following parameters may be accessible following reassignment of the I/O in the standard product or modification of the settings.

Code	Description	Adjustment range	Factory setting
ACC2	Accel. 2 - s	0.05 to 999.9	5 s
	2 nd acceleration ramp time		
DEC2	Decel. 2 - s	0.05 to 999.9	5 s
	2 nd deceleration ramp time. These parameters can be accessed if the ramp switching threshold (Frt parameter) is other than 0 Hz or if a logic input has been assigned to ramp switching.		
tdC	dc I at rest - A	0.1 to 1.1 In (1)	According to drive rating
	Level of injection braking current applied after 30 seconds if tdC = Cont.  Check that the motor will withstand this current without overheating.		
IdC	DC Inj.Curr. - A	0.1 to 1.1 In (1)	According to drive rating
	Level of DC injection braking current This parameter can be accessed if a logic input has been assigned to current injection braking. After 30 seconds the injection current is limited to 0.5 Ith if set to a higher value.		
PFL	U/f Profile - %	0 to 100%	20%
	Can be used to adjust the motor quadratic power supply ratio when the energy-saving function has been inhibited.		
SP2	Preset SP.2 - Hz	LSP to HSP	10 Hz
	2 nd preset speed		
SP3	Preset SP.3 - Hz	LSP to HSP	15 Hz
	3 rd preset speed		
SP4	Preset SP.4 - Hz	LSP to HSP	20 Hz
	4 th preset speed		
SP5	Preset SP.5 - Hz	LSP to HSP	25 Hz
	5 th preset speed		
SP6	Preset SP.6 - Hz	LSP to HSP	30 Hz
	6 th preset speed		
SP7	Preset SP.7 - Hz	LSP to HSP	35 Hz
	7 th preset speed		
SP8	Preset SP.8 - Hz	LSP to HSP	50 Hz
	8 th preset speed		
UFr	IR Compens. - %	0 to 800%	0%
	UFr only appears if the SPC parameter (special motor) of the drive menu is set to "yes". Used to adjust the value measured during auto-tuning that corresponds to 100%.		
JOG	Jog Freq. - Hz	0 to 10 Hz	10 Hz
	Jog frequency		
JGt	Jog Delay - s	0 to 2 s	0.5 s
	Anti-repeat delay between two consecutive jog operations		

(1) In corresponds to the drive nominal current indicated in the catalogue and on the drive rating plate.

Adjust Menu

Code	Description	Adjustment range	Factory setting
dt5	Tacho Coeff.	1 to 2	1
	Multiplication coefficient of the feedback associated with the tachogenerator function: $dtS = \frac{9}{\text{tachogenerator voltage at max. speed HSP}}$		
rPG	PI Prop. Gain	0.01 to 100	1
	PI regulator proportional gain		
rIG	PI Int. Gain	0.01 to 100/s	1/s
	PI regulator integral gain		
Fb5	PI Coeff.	1 to 100	1
	PI feedback multiplication coefficient		
PII	PI Inversion	no - yes	no
	Reversal of the direction of correction of the PI regulator no: normal yes: reverse		
Ftd	Freq. Lev. Att - Hz	LSP to HSP	50 Hz
	Motor frequency threshold above which the logic output changes to 1		
F2d	Freq.2 Att - Hz	LSP to HSP	50 Hz
	Frequency 2 threshold: same function as Ftd, for a 2nd frequency value		
Ctd	Curr. Lev. Att - A	0 to 1.1 In (1)	1.1 In (1)
	Current threshold above which the logic output or the relay changes to 1		
ttt	Therm Lev. Att - %	0 to 118%	100%
	Motor thermal state threshold above which the logic output or the relay changes to 1		
P5P	PI Filter - s	0.0 to 10.0	0 s
	Used to adjust the filter time constant on the PI feedback		
P12	PI Preset 2 - %	0 to 100%	30%
	2 nd preset PI reference, when a logic input has been assigned to the 4 preset PI references function. 100% = process max 0% = process min		
P13	PI Preset 3 - %	0 to 100%	60%
	3 rd preset PI reference, when a logic input has been assigned to the 4 preset PI references function. 100% = process max 0% = process min		
dt d	ATV th. fault	0 to 118%	105%
	Drive thermal threshold above which the logic output or the relay changes to 1		

(1) In corresponds to the drive nominal current indicated in the catalogue and on the drive rating plate.

The parameters with a grey background appear if an I/O extension card has been installed.

Drive Menu

This menu can be accessed when the switch is in position .
The parameters can only be modified in stop mode with the drive locked.

Drive performance can be optimized by:

- entering the values given on the rating plate in the drive menu
- performing an auto-tune operation (on a standard asynchronous motor)



Code	Description	Adjustment range	Factory setting
<i>Un5</i>	Nom.Mot.Volt - V	200 to 480 V	400 V
	Nominal motor voltage marked on the rating plate. The adjustment range depends on the drive model.		
<i>Frs</i>	Nom.Mot.Freq - Hz	10 to 500 Hz	50 Hz
	Nominal motor frequency given on the rating plate		
<i>nCr</i>	Nom.Mot.Curr - A	0.25 to 1.1 In (1)	according to drive rating
	Nominal motor current given on the rating plate		
<i>nSP</i>	Nom.Mot.Speed - rpm	0 to 9999 rpm	according to drive rating
	Nominal motor speed given on the rating plate		
<i>CD5</i>	Mot. Cos Phi	0.5 to 1	according to drive rating
	Motor Cos Phi given on the rating plate		
<i>tUn</i>	Auto Tuning	no - yes	no
	Used to auto-tune motor control once this parameter has been set to "yes". Once auto-tuning is complete, the parameter automatically returns to "done" or "no" in the event of a fault. Caution: Auto-tuning will only be performed if no command has been activated. If a "freewheel stop" or "fast stop" function has been assigned to a logic input, this input must be set to 1 (active at 0).		
<i>tFr</i>	Max. Freq. - Hz	10 to 500 Hz	60 Hz
	Maximum output frequency. The maximum value depends on the switching frequency. See SFR parameter (drive menu)		
<i>nLd</i>	Energy Eco	no - yes	yes
	Optimizes motor efficiency		
<i>Fdb</i>	I lim adapt.	no - yes	no
	Adaptation of the limit current as a function of the output frequency (ventilation applications where the load curve changes as a function of the gas density).		
<i>brA</i>	DecRampAdapt	no - yes	yes
	Activating this function automatically increases the deceleration time, if this has been set at too low a value for the inertia of the load, thus avoiding the drive going into ObF fault. This function may be incompatible with positioning on a ramp and with the use of a braking resistor.		
<i>Frt</i>	SwitchRamp2 - Hz	0 to HSP	0 Hz
	Ramp switching frequency Once the output frequency exceeds Frt, the ramp times taken into account are AC2 and dE2.		

(1) In is the drive nominal current shown in the catalogue and on the rating plate.

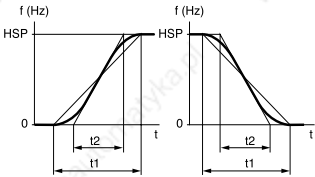
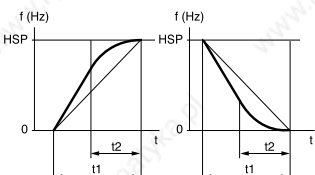
Drive Menu

Code	Description	Adjustment range	Factory setting
Stt	Stop Type	STN - FST - NST - DCI	STN
	Type of stop. On a stop request, the type of stop is activated up to the FFT threshold (adjust menu). Below the threshold, freewheel stopping occurs. STN: follow ramp FST: fast stop NST: freewheel stop DCI: DC injection stop		
rPt	Ramp Type	LIN - S - U	LIN
	Defines the shape of the acceleration and deceleration ramps. LIN: linear S: S ramp U: U ramp		
	S-shape ramps 	The rounding coefficient is fixed, where $t_2 = 0.6 \times t_1$ and $t_1 = \text{set ramp time}$.	
	U-shape ramps 	The rounding coefficient is fixed, where $t_2 = 0.5 \times t_1$ and $t_1 = \text{set ramp time}$.	
dCF	DecRAMPcoef	1 to 10	4
	Deceleration ramp time reduction coefficient when the fast stop function is active.		
CLl	Int. I Lim - A	0 to 1.1 In (1)	1.1 In
	The current limit is used to limit motor overheating.		
AdC	Auto DC Inj.	no - yes	yes
	Used to deactivate automatic DC injection braking on stopping.		
PCC	Motor P Coef.	0.2 to 1	1
	Defines the relationship between the drive nominal power and the lowest-rated motor when a logic input has been assigned to the motor switching function.		

Drive Menu

Code	Description	Adjustment range	Factory setting															
SFt	Sw Freq. Type	LF-HF1-HF2	LF															
	<p>Used to select a low switching frequency (LF) or a high switching frequency (HF1 or HF2). HF1 switching is designed for applications with a low load factor without derating the drive. If the thermal state of the drive exceeds 95%, the frequency automatically changes to 2 or 4 kHz depending on the drive rating. When the thermal state of the drive drops back to 70%, the selected switching frequency is re-established. HF2 switching is designed for applications with a high load factor with derating of the drive by one rating: the drive parameters are scaled automatically (torque limit, thermal current, etc).</p> <p> Modifying this parameter results in the following parameters returning to factory settings :</p> <ul style="list-style-type: none"> • nCr, CLI, Sfr, nrd (Drive menu) • ItH, IdC, Ctd (Adjust menu) 																	
SFr	Sw Freq - kHz	0.5-1-2-4 -8-12-16 kHz	According to drive rating															
	<p>Used to select the switching frequency. The adjustment range depends on the SFt parameter. If SFt = LF: 0.5 to 2 or 4 kHz according to the drive rating If SFt = HF1 or HF2: 2 or 4 to 16 kHz according to the drive rating The maximum operating frequency (tFr) is limited according to the switching frequency:</p> <table border="1"> <tr> <td>SFr(kHz)</td> <td>0.5</td> <td>1</td> <td>2</td> <td>4</td> <td>8</td> <td>12</td> <td>16</td> </tr> <tr> <td>tFr (Hz)</td> <td>62</td> <td>125</td> <td>250</td> <td>500</td> <td>500</td> <td>500</td> <td>500</td> </tr> </table>			SFr(kHz)	0.5	1	2	4	8	12	16	tFr (Hz)	62	125	250	500	500	500
SFr(kHz)	0.5	1	2	4	8	12	16											
tFr (Hz)	62	125	250	500	500	500	500											
nrd	Noise Reduct.	no - yes	(1)															
	This function modulates the switching frequency randomly to reduce motor noise.																	
SPC	Special Motor	no - yes - PSM	no															
	<p>It should be used for a motor supply in U/f ratio with the IR compensation set via the UFr parameter in the "Adjust" menu. No: normal motor Yes: special motor PSM: small motor. It inhibits detection of "Uncontrolled loss downstream". Deactivate the function nLd in the Drive menu for this to operate correctly.</p> <p> Perform an auto-tune</p>																	
PGt	PG Type	INC-DET	DET															
	<p>Defines the type of sensor used when an encoder feedback I/O card is installed: INC: incremental encoder (A, A+, B, B+ are hard-wired) DET: detector (only A is hard-wired)</p>																	
PLS	Num. Pulses	1 to 1024	1024															
	Defines the number of pulses per sensor revolution.																	

(1) yes if **SFt = LF**, no if **SFt = HF1** or **HF2**

The parameters with a grey background appear if a VW3 A58202 I/O extension card has been installed.

Control Menu

This menu can be accessed when the switch is in position . The parameters can only be modified in stop mode with the drive locked.

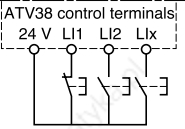
Code	Description	Adjustment range	Factory setting														
t c c	TermStripCon	2W- 3W (2-wire - 3-wire)	2W														
<p>Configuration of terminal strip control: 2-wire or 3-wire control.</p> <p> Modification of this parameter requires double confirmation as it results in reassignment of the logic inputs. By changing from 2-wire control to 3-wire control, the logic input assignments are shifted by one input. The LI3 assignment in 2-wire control becomes the LI4 assignment in 3-wire control. In 3-wire control, inputs LI1 and LI2 cannot be reassigned.</p> <table border="0" style="width: 100%;"> <tr> <td style="text-align: center;">Macro-configuration</td> <td style="text-align: center;">Variable torque</td> </tr> <tr> <td style="text-align: center;">LI1</td> <td style="text-align: center;">STOP</td> </tr> <tr> <td style="text-align: center;">LI2</td> <td style="text-align: center;">RUN forward</td> </tr> <tr> <td style="text-align: center;">LI3</td> <td style="text-align: center;">RUN reverse</td> </tr> <tr> <td style="text-align: center;">LI4</td> <td style="text-align: center;">Fault reset</td> </tr> <tr> <td style="text-align: center;">LI5</td> <td style="text-align: center;">ramp switching</td> </tr> <tr> <td style="text-align: center;">LI6</td> <td style="text-align: center;">not assigned</td> </tr> </table> <p>The I/O with a grey background can be accessed if an I/O extension card has been installed.</p> <p>3-wire control (Pulse control: one pulse is sufficient to control start-up). This option inhibits the "automatic restart" function.</p> <p>Wiring example:</p> <div style="display: flex; align-items: center;"> <div style="margin-right: 20px;"> <p>LI1: stop</p> <p>LI2: forward</p> <p>LIx: reverse</p> </div>  </div>				Macro-configuration	Variable torque	LI1	STOP	LI2	RUN forward	LI3	RUN reverse	LI4	Fault reset	LI5	ramp switching	LI6	not assigned
Macro-configuration	Variable torque																
LI1	STOP																
LI2	RUN forward																
LI3	RUN reverse																
LI4	Fault reset																
LI5	ramp switching																
LI6	not assigned																

This option only appears if 2-wire control is configured.

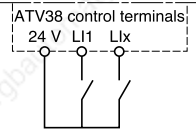
Code	Description	Adjustment range	Factory setting
t c t	Type 2 Wire	LEL-TRN-PFo	LEL
<p>Defines 2-wire control:</p> <ul style="list-style-type: none"> - according to the state of the logic inputs (LEL: 2 wire) - according to a change in state of the logic inputs (TRN: 2 wire trans) - according to the state of the logic inputs with forward always having priority over reverse (PFo: Priorit. FW) <p>Wiring example:</p> <div style="display: flex; align-items: center;"> <div style="margin-right: 20px;"> <p>LI1: forward</p> <p>LIx: reverse</p> </div>  </div>			
r l n	RV Inhibit	no - yes	no
<ul style="list-style-type: none"> • Inhibition of operation in the opposite direction to that controlled by the logic inputs, even if this reversal is required by a summing or loop control function. • Inhibition of reverse operation if it is controlled by the FWD/REV key on the terminal. 			

 The parameters with a grey background appear if an I/O extension card has been installed.



Control Menu

ENGLISH

Code	Description	Adjustment range	Factory setting
b5P	deadb./Pedst	no BNS: pedestal BLS: deadband	no
<p>Management of operation at low speed:</p> <div style="display: flex; justify-content: space-around;"> <div style="text-align: center;"> <p>F : motor frequency</p> <p>No</p> </div> <div style="text-align: center;"> <p>F : motor frequency</p> <p>Pedestal (BNS)</p> </div> </div> <div style="text-align: center; margin-top: 10px;"> <p>F : motor frequency</p> <p>Deadband (BLS)</p> </div>			
CrL	AI2 min Ref. - mA	0 to 20 mA	4 mA
CrH	AI2 Max Ref. - mA	4 to 20 mA	20 mA
<p>Minimum and maximum values of the signal on input AI2. These two parameters are used to define the signal sent to AI2. There are several configuration possibilities, one of which is to configure the input for a 0-20 mA, 4-20 mA, 20-4 mA, etc signal.</p> <div style="text-align: center;"> <p>Frequency</p> <p>CrL CrH 20 AI 2 (mA)</p> </div>			
RDL	Min. Val AO - mA	0 to 20 mA	0 mA
RDH	Max. Val AO - mA	0 to 20 mA	20 mA
<p>Parameter</p> <div style="display: flex; justify-content: space-between;"> <div style="text-align: center;"> <p>Max.</p> <p>AOL AOH 20</p> </div> <div style="text-align: right;"> <p>Minimum and maximum values of the signal on outputs AO and AO1 (1) These two parameters are used to define the output signal on AO and AO1. Eg: 0-20 mA, 4-20 mA, 20-4mA, etc</p> </div> </div>			

(1) The AO output is available if an I/O extension card has been installed.

Control Menu

Code	Description	Adjustment range	Factory setting
<i>5 t r</i>	Save Ref.	NO-RAM-EEP	NO
	Associated with the + speed/- speed function, this function is used to save the reference: when run commands disappear (saved in RAM) or when the line supply disappears (saved in EEPROM). On the next start-up, the speed reference is the last reference saved.		
<i>L I C</i>	Keypad Comm.	No - Yes	No
	Used to activate drive control via the terminal. The STOP/RESET, RUN and FWD/REV keys are active. The speed reference is given by parameter LFr. Only the freewheel stop, fast stop, DC injection stop commands and external fault remain active at the terminals. If the drive/terminal connection is cut, the drive locks in SLF fault mode.		
	 This function is no longer accessible by the keypad if LIX=FTK.		
<i>P S t</i>	STOP Priorit	No - Yes	Yes
	This function gives priority to the STOP key irrespective of the control channel (terminals or fieldbus). To change the PSt parameter to "no": 1 - Display "no" 2 - Press the "ENT" key 3 - The drive displays "See manual" 4 - Press ▲ then ▼ then "ENT" For applications with continuous processes, it is advisable to configure the key as inactive (set to "no").		
<i>A d d</i>	DriveAddress	0 to 31	0
	Drive address when it is controlled via the connector port (with the operator terminal and programming terminal removed).		
<i>t b r</i>	BdRate RS485	9600-19200	19200
	Transmission speed via the RS485 serial link (effective on the next power-up) 9600 bps 19200 bps  If <i>t b r</i> ≠ 19200, the terminal can no longer be used. To reactivate the terminal, reconfigure <i>t b r</i> as 19200 via the serial link or revert to factory settings (see page 119).		
<i>r P r</i>	Reset cnts	No-APH-RTH	No
	Reset kWh or the operating time. No APH: Reset kWh to zero RTH: Reset operating time to zero The reset command must be confirmed with "ENT" APH and RTH take effect immediately. The parameter then automatically reverts to No		

I/O Menu

This menu can be accessed when the switch is in position .
The assignments can only be modified in stop mode with the drive locked.

Code	Function
L I2	LI2 Assiḡn.
	See the summary table and description of the functions.

The inputs and outputs available in the menu depend on the I/O cards installed (if any) in the drive, as well as the selections made previously in the control menu.

Summary table of the logic input assignments (exc. 2-wire / 3-wire option)

I/O extension option cards		2 logic inputs LI5-LI6
Drive without option		3 logic inputs LI2 to LI4
NO :Not assigned	(Not assigned)	X
RV :Reverse	(Reverse)	X
RP2:Switch ramp2	(Ramp switching)	X
JOG	(Jog operation)	X
+SP: + Speed	(+ speed)	X
-SP: - Speed	(- speed)	X
PS2: 2 Preset Speeds	(2 preset speeds)	X
PS4 : 4 Preset Speeds	(4 preset speeds)	X
PS8 : 8 Preset Speeds	(8 preset speeds)	X
NST:Freewhl Stop	(Freewheel stop)	X
DCI:DC inject.	(Injection stop)	X
FST:Fast stop	(Fast stop)	X
CHP:Multi. Motor	(Motor switching)	X
FLO:Forced Local	(Forced local mode)	X
RST:Fault Reset	(Fault reset)	X
RFC:Auto/Manu	(Reference switching)	X
ATN:Auto Tuning	(Auto-tuning)	X
PAU:PI Auto/Man	(PI Auto/Man) If one AI = PIF	X
PR2:PI 2 Preset	(2 preset PI references) If one AI = PIF	X
PR4:PI 4 Preset	(4 preset PI references) If one AI = PIF	X
EDD:Ext flt.	(external fault)	X
FTK: Forc.KeyP.	(Force to keypad)	X



CAUTION: If a logic input is assigned to "Freewheel stop" or "Fast stop", start-up can only be performed by linking this input to the +24V, as these stop functions are active when the inputs are at state 0.

Summary table of the encoder and analog input assignments

I/O extension option cards			Analog input AI3	Encoder input A+, A-, B+, B- (1)
Drive without option		Analog input AI2		
NO :Not assigned	(Not assigned)	X	X	X
FR2:Speed Ref2	(Speed reference 2)	X	X	
SAI:Summed Ref.	(Summed reference)	X	X	X
PIF:PI Regulator	(PI regulator feedback)	X	X	
PIM:PI Man.ref.	(Manual PI speed reference) If one AI = PIF		X	
SFB:Tacho feedbk	(Tachogenerator)		X	
PTC:Therm.Sensor	(PTC probes)		X	
RGI:PG feedbk	(Encoder or detector feedback)			X

(1) NB: The menu for assigning encoder input A+, A-, B+, B- is called "Assign AI3".

Summary table for logic output assignments

I/O extension option card			Logic output LO
Drive without option		Relay R2	
NO :Not assigned	(Not assigned)	X	X
RUN:DriveRunning	(Drive running)	X	X
OCC:OutPut Cont.	(Downstream contactor control)	X	X
FTA:Fre1 Attain.	(Frequency threshold reached)	X	X
FLA:HSP Attained	(HSP reached)	X	X
CTA:I Attained	(Current threshold reached)	X	X
SRA:FRH Attained	(Frequency reference reached)	X	X
TSA:MtrTherm Lvl	(Motor thermal threshold reached)	X	X
APL:LossFollower	(Loss of 4/20 mA signal)	X	X
F2A:Fre1.2 Att.	(Frequency 2 threshold reached)	X	X
tAd:ATV th.alarm	(Drive thermal threshold reached)	X	X

Summary table for the analog output assignments

I/O extension option card		Analog output AO
Drive without option		Analog output AO1
NO :Not assigned	(Not assigned)	X
OCR:Motor Curr.	(Motor current)	X
OFR:Motor Freq	(Motor speed)	X
ORP:OutPut ramp	(Ramp output)	X
ORS:Signed ramp	(Signed ramp output)	X
OPS:PI ref.	(PI reference output) If one AI = PIF	X
OPF:PI Feedback	(PI feedback output) If one AI = PIF	X
OPE:PI Error	(PI error output) If one AI = PIF	X
OPI:PI Integral	(PI integral output) If one AI = PIF	X
OPR:OutPut Power	(Motor power)	X
THR:MotorThermal	(Motor thermal state)	X
THD:DriveThermal	(Drive thermal state)	X

Once the I/O have been reassigned, the parameters related to the function automatically appear in the menus, and the macro-configuration indicates "CUS: Customised". Some reassignments result in new adjustment parameters which the user must not forget to configure in the adjust menu:

I/O	Assignments	Parameters to set
LI	RP2 Ramp switching	<i>RC2 dE2</i>
LI	JOG Jog operation	<i>JOG JGt</i>
LI	PS2 2 preset speeds	<i>SP2</i>
LI	PS4 4 preset speeds	<i>SP2 - SP3 - SP4</i>
LI	PS8 8 preset speeds	<i>SP5 - SP6 - SP7 - SP8</i>
LI	DCI Injection stop	<i>IdC</i>
LI	PR4 4 preset PI references	<i>P 12 - P 13</i>
AI	PIF PI regulator feedback	<i>r PG - r IG - P IC - P5P</i>
AI	SFB Tachogenerator	<i>dt5</i>
LO/R2	FTA Frequency threshold reached	<i>Ftd</i>
LO/R2	CTA Current threshold reached	<i>Ctd</i>
LO/R2	TSA Motor thermal threshold reached	<i>ttd</i>
LO/R2	F2A Frequency 2 threshold reached	<i>F2d</i>
LO/R2	TAD Drive thermal threshold reached	<i>dt d</i>

I/O Menu

Some reassignments result in new adjustment parameters which the user must not forget to configure in the control, drive or fault menu:

I/O	Assignments		Parameters to set
LI	-SP	- speed	5 t r (control menu)
LI	FST	Fast stop	d L F (drive menu)
LI	RST	Fault reset	r 5 t (fault menu)
LI	CHP	Motor switching	P L L (drive menu)
AI	SFB	Tachogenerator	5 d d (fault menu)
A+, A-, B+, B-	SAI	Summed reference	P L t , P L 5 (drive menu)
A+, A-, B+, B-	RGI	PG feedback	P L t , P L 5 (drive menu)

Configurable I/O Application Functions

Function compatibility table

The choice of application functions may be limited by incompatibility between certain functions. Functions which are not listed in this table are fully compatible.

	DC injection braking	Summed inputs	PI regulator	+/- speed	Reference switching	Freewheel stop	Fast stop	Jog operation	Preset speeds	Speed regulation with tachogenerator or encoder
DC injection braking						↑				
Summed inputs					●					
PI regulator								●	●	●
+/- speed					●			↑	●	
Reference switching		●		●					●	
Freewheel stop	←						←			
Fast stop						↑				
Jog operation			●	←					←	
Preset speeds			●	●	●			↑		
Speed regulation with tachogenerator or encoder			●							

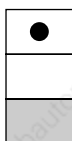

● Incompatible functions

□ Compatible functions

■ Not applicable

Priority functions (functions which cannot be active simultaneously):

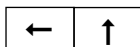

← ↑ The function indicated by the arrow has priority over the other.

Stop functions have priority over run commands.

Speed references via logic command have priority over analog references.

Logic input application functions

Operating direction: forward/reverse

Reverse operation can be disabled for applications requiring only a single direction of motor rotation.

2-wire control

Run (forward or reverse) and stop are controlled by the same logic input, for which state 1 (run) or 0 (stop), or a change in state is taken into account (see the 2-wire control menu).

3-wire control

Run (forward or reverse) and stop are controlled by 2 different logic inputs.

LI1 is always assigned to the stop function. A stop is obtained on opening (state 0).

The pulse on the run input is stored until the stop input opens.

During power-up or a manual or automatic fault reset, the motor can only be supplied with power after prior resetting of the "forward", "reverse", and "injection stop" commands.

Ramp switching : 1st ramp: ACC, dEC; 2nd ramp: AC2, dE2

Two types of activation are possible:

- activation of a logic input LIx
- detection of an adjustable frequency threshold

If a logic input is assigned to the function, ramp switching can only be performed by this input.

Step by step operation (JOG): Low speed operation pulse

If the JOG contact is closed and then the operating direction contact is actuated, the ramp is 0.1 s irrespective of the ACC, dEC, AC2, dE2 settings. If the direction contact is closed and the JOG contact is then actuated, the configured ramps are used.

Parameters which can be accessed in the adjust menu:

- JOG speed
- anti-repeat delay (minimum time between 2 "JOG" commands)

Configurable I/O Application Functions

+/- speed: Two types of operation are available.

- 1 Use of single action buttons: two logic inputs are required in addition to the operating direction(s).
The input assigned to the "+ speed" command increases the speed, the input assigned to the "- speed" command decreases the speed.

This function accesses the ST_r save reference parameter in the Control menu.

- 2 Use of double action buttons: only one logic input assigned to + speed is required.

+ speed/- speed with double action buttons:

Description: 1 button pressed twice for each direction of rotation.

Each action closes a volt-free contact.

	Released (- speed)	Press 1 (speed maintained)	Press 2 (+ speed)
forward button	–	a	a and b
reverse button	–	c	c and d

Wiring example:

LI1: forward
LIx: reverse
LIy: + speed

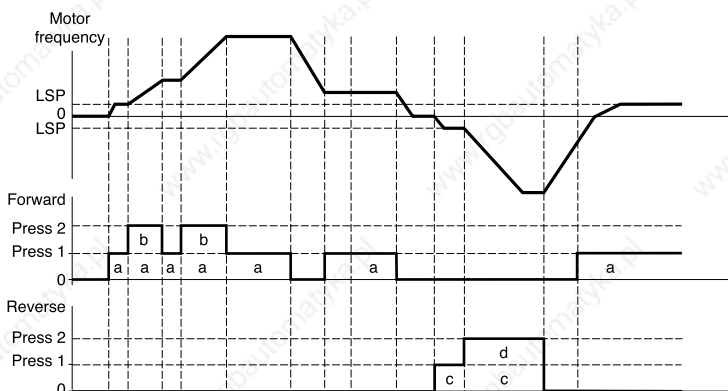
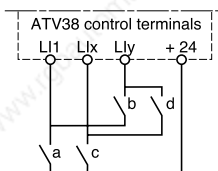

This type of +/- speed is incompatible with 3-wire control. In this case, the - speed function is automatically assigned to the logic input with the highest number (for example: LI3 (+ speed), LI4 (- speed)).

In both cases, the maximum speed is given by the references applied to the analog inputs. For example, connect AI1 to the +10V.

Configurable I/O Application Functions

Preset speeds

2, 4 or 8 speeds can be preset, requiring 1, 2 or 3 logic inputs respectively.

The following assignment order must be observed : PS2 (Llx), then PS4 (Lly), then PS8 (Llz).

2 preset speeds		4 preset speeds			8 preset speeds			
Assign: Llx to PS2		Assign: Llx to PS2 then Lly to PS4			Assign: Llx to PS2 Lly to PS4, then Llz to PS8			
Llx	speed reference	Lly	Llx	speed reference	Llz	Lly	Llx	speed reference
0	LSP+reference	0	0	LSP+reference	0	0	0	LSP+reference
1	SP2	0	1	SP2	0	0	1	SP2
		1	0	SP3	0	1	0	SP3
		1	1	SP4	0	1	1	SP4
					1	0	0	SP5
					1	0	1	SP6
					1	1	0	SP7
					1	1	1	SP8

To unassign the logic inputs, the following order must be observed: PS8 (Llz), then PS4 (Lly), then PS2 (Llx).

Reference switching

To configure the AI1/AI2 reference switching:

- Verify that the LI is not configured to "RFC:Auto/Manu" (if so, configure the LI to "NO:Not assigned").
- Configure a LI to "RFC:Auto/Manu". The second reference is then AI2.

To configure the AI1/AI3 reference switching:

- Verify that the LI is not configured to "RFC:Auto/Manu" (if so, configure the LI to "NO:Not assigned").
- Configure AI3 to "FR2:Speed Ref2".
- Configure a LI to "RFC:Auto/Manu". The second reference is then AI3.

Connection diagram

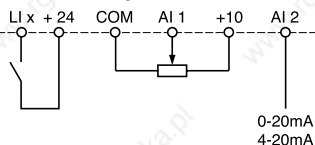

Open contact, reference = AI2 or AI3
Closed contact, reference = AI1

Freewheel stop

Causes the motor to stop using the resistive torque only. The motor power supply is cut. A freewheel stop is obtained when the logic input opens (state 0).

DC injection stop

An injection stop is obtained when the logic input closes (state 1).

Fast stop

Braked stop with the deceleration ramp time reduced by a reduction factor dCF which appears in the drive menu.

A fast stop is obtained when the logic input opens (state 0).

Configurable I/O Application Functions

Motor switching

This function enables two motors with different ratings to be powered by the same drive in succession, with switching performed by an appropriate sequence at the drive output. Switching must take place with the motor stopped, and the drive locked. The following internal parameters are switched automatically by the logic command:

- nominal motor current
- injection current

This function automatically disables thermal protection on the second motor.
Accessible parameter: Ratio of PCC motor ratings in the drive menu.

Fault reset

Two types of reset are available: partial or general (rSt parameter in the "fault" menu).

Partial reset (rSt = RSP):

Used to clear the stored fault and reset the drive if the cause of the fault has disappeared.

Faults affected by partial clearing:

- | | | |
|----------------------|-----------------------|---------------------|
| - line overvoltage | - communication fault | - motor overheating |
| - DC bus overvoltage | - motor overload | - serial link fault |
| - motor phase loss | - loss of 4-20 mA | - drive overheating |
| - overhauling | - external fault | - overspeed |

General reset (rSt = RSG):

This inhibits all faults (forced operation) except SCF (motor short circuit) while the assigned logic input is closed.

Forced local mode

Used to switch between line control mode (serial link) and local mode (controlled via the terminal strip or via the terminal).

Auto-tuning

When the assigned logic input changes to 1 an auto-tuning operation is triggered, in the same way as parameter tUn in the "drive" menu.



Caution: Auto-tuning will only be performed if no command has been activated. If a "freewheel stop" or "fast stop" function has been assigned to a logic input, this input must be set to 1 (active at 0).
Application: Motor switching for example.

Preset PI auto-man, PI reference: See PI function (page 111)

External fault

When the assigned logic input changes to 1, the motor stops (according to the configuration of the L5F StOP+flt parameter in the Drive menu), and the drive locks in EPF external fault fault mode.

Force to keypad

Enables a LI to be used to select for local control:

If LIX=FTK and FTK=0: operation by the control terminals

If LIX=FTK and FTK=1: control by the keypad



- If LIX=FTK, the LCC function in the control menu is no longer accessible by the keypad. In consequence it is impossible to control the drive by the keypad.
- When FTK has been deactivated it is necessary to revalidate the function LCC again in the control menu.

Configurable I/O Application Functions

Analog input application functions

Input AI1 is always the speed reference.

Assignment of AI2 and AI3

Summed speed reference: The frequency references provided by AI2 and AI3 can be summed with AI1.

Speed regulation with tachogenerator: (Assignment to AI3 only with an I/O extension card with analog input): used for speed correction via tachogenerator feedback.

An external divider bridge is required to adapt the voltage of the tachogenerator. The maximum voltage must be between 5 and 9 V. A precise setting is then obtained by setting parameter dtS available in the adjust menu.

PTC probe protection: (only with an I/O extension card with analog input). Used for the direct thermal protection of the motor by connecting the PTC probes in the motor windings to analog input AI3.

PTC probe characteristics:

Total resistance of the probe circuit at 20 °C = 750 Ohms.

PI regulator: Used to regulate a process with a reference and a feedback given by a sensor. In PI mode the ramps are all linear, even if they are configured differently.

With the PI regulator, it is possible to:

- Adapt the feedback via FbS.
 - Correct PI inversion.
 - Adjust the proportional and integral gain (RPG and RIG).
 - Assign an analog output for the PI reference, PI feedback and PI error.
 - Apply a ramp to establish the action of the PI (AC2) on start-up if PSP > 0.
- If PSP = 0 the active ramps are ACC/dEC. The dEC ramp is always used when stopping.

The motor speed is limited to between LSP and HSP.

Note: PI regulator mode is active if an AI input is assigned to PI feedback. This AI assignment can only be made after disabling any functions incompatible with PI (see page 106).

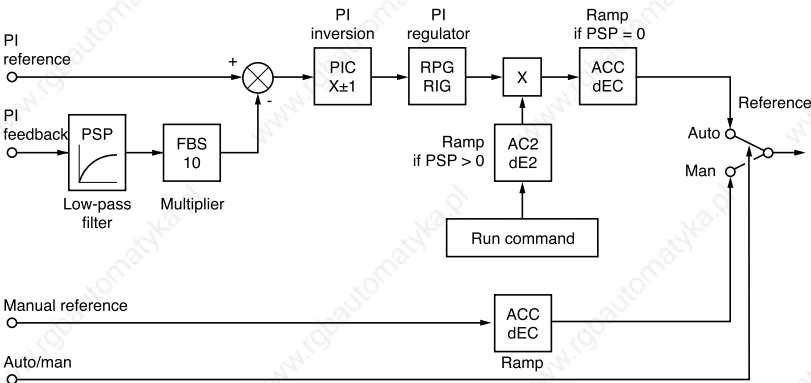

Auto/Man: This function can only be accessed when the PI function is active, and requires an I/O extension card with analog input

- Via logic input LI, this is used to switch operation to speed regulation if LIx = 0 (manual reference on AI3), and PI regulation if LIx = 1 (auto).

ENGLISH

Configurable I/O Application Functions

Preset references:

2 or 4 preset references require the use of 1 or 2 logic inputs respectively:

2 preset references		4 preset references		
Assign: Llx to Pr2		Assign: Llx to Pr2, then Lly to Pr4		
Llx	Reference	Lly	Llx	Reference
0	Analog reference	0	0	Analog reference
1	Process max (= 10 V)	0	1	PI2 (adjustable)
		1	0	PI3 (adjustable)
		1	1	Process max (= 10 V)

Encoder input application functions

(only with an I/O extension card with encoder input)

Speed regulation: Used to correct the speed via an incremental encoder or detector. (See documentation supplied with the card).

Summed speed reference: The reference provided by the encoder input is summed with AI1. (see documentation supplied with the card)

Applications:

- Synchronization of the speed of a number of drives. Parameter PLS on the "drive" menu is used to adjust the speed ratio of one motor in relation to that of another.
- Reference via encoder.

Logic output application functions

Relay R2, LO solid state output (with I/O extension card)

Downstream contactor control (OCC): can be assigned to R2 or LO

Enables the drive to control an output contactor (located between the drive and the motor). The request to close the contactor is made when a run command appears. The request to open the contactor is made when there is no current to the motor.



If a DC injection braking function has been configured, it should not be left operating too long in stop mode, as the contactor only opens at the end of braking.

Drive running (RUN): can be assigned to R2 or LO

The logic output is at state 1 if the motor power supply is provided by the drive (current present) or if a run command is present with a zero reference.

Frequency threshold reached (FTA): can be assigned to R2 or LO

The logic output is at state 1 if the motor frequency is greater than or equal to the frequency threshold set by Ftd in the adjust menu.

Frequency 2 threshold reached (F2A): can be assigned to R2 or LO

The logic output is at state 1 if the motor frequency is greater than or equal to the frequency threshold set by F2d in the adjust menu.

Reference reached (SRA): can be assigned to R2 or LO

The logic output is at state 1 if the motor frequency is equal to the reference value.

Configurable I/O Application Functions

High speed reached (FLA): can be assigned to R2 or LO
The logic output is at state 1 if the motor frequency is equal to HSP.

Current threshold reached (CTA): can be assigned to R2 or LO
The logic output is at state 1 if the motor current is greater than or equal to the current threshold set by Ctd in the adjust menu.

Motor thermal state reached (TSA): can be assigned to R2 or LO
The logic output is at state 1 if the motor thermal state is greater than or equal to the thermal state threshold set by ttd in the adjust menu.

Drive thermal state reached (TAD): can be assigned to R2 or LO
The logic output is at state 1 if the drive thermal state is greater than or equal to the thermal state threshold set by dtd in the adjust menu.

Loss follower (APL): can be assigned to R2 or LO
The logic output is at 1 if the signal on the 4-20 mA input is below 2 mA.

Analog output AO and AO1 application functions

Analog outputs AO and AO1 are current outputs, from AOL (mA) to AOH (mA),

- AOL and AOH can be configured between 0 and 20 mA.

Examples of AOL – AOH: 0 - 20 mA
4 - 20 mA
20 - 4 mA

Motor current (code OCR): the image of the motor rms current.

- AOH corresponds to twice the drive nominal current.
- AOL corresponds to zero current.

Motor frequency (code OFR): the motor frequency estimated by the drive.

- AOH corresponds to the maximum frequency (parameter tFr).
- AOL corresponds to zero frequency.

Ramp output (code ORP): the image of the ramp output frequency.

- AOH corresponds to the maximum frequency (parameter tFr).
- AOL corresponds to zero frequency.

Signed ramp (code ORS): the image of the ramp output frequency and direction.

- AOL corresponds to the maximum frequency (parameter tFr) in reverse direction.
- AOH corresponds to the maximum frequency (parameter tFr) in forward direction.
- $\frac{AOH + AOL}{2}$ corresponds to zero frequency.

PI reference (code OPS): the image of the PI regulator reference.

- AOL corresponds to the minimum reference.
- AOH corresponds to the maximum reference.

PI feedback (code OPF): the image of the PI regulator feedback.

- AOL corresponds to the minimum feedback.
- AOH corresponds to the maximum feedback.

Configurable I/O Application Functions

PI error (code OPE): the image of the PI regulator error as a % of the sensor range (maximum feedback - minimum feedback).

- AOL corresponds to the maximum error < 0 .
- AOH corresponds to the maximum error > 0 .
- $\frac{AOH + AOL}{2}$ corresponds to a zero error (OPE = 0).

PI integral (code OPI): the image of the PI regulator error integral.

- AOL corresponds to a zero integral.
- AOH corresponds to a saturated integral.

Motor power (code OPR): the image of the motor power consumption.

- AOL corresponds to 0% of the nominal motor power.
- AOH corresponds to 200% of the nominal motor power.

Motor thermal state (code THR): the image of the motor thermal state, calculated.

- AOL corresponds to 0%.
- AOH corresponds to 200%.

Drive thermal state (code THD): the image of the drive thermal state, calculated.

- AOL corresponds to 0%.
- AOH corresponds to 200%.

Fault Menu

This menu can be accessed when the switch is in position  .
Modifications can only be made in stop mode with the drive locked.

Code	Description	Factory setting												
Atr	Auto Restart This function is used to restart the drive automatically if the fault has disappeared (Yes/No option). Automatic restarting is possible after the following faults: <ul style="list-style-type: none"> - line overvoltage - DC bus overvoltage - external fault - motor phase loss - serial link fault - communication fault - loss of 4-20 mA signal - motor overload (condition: motor thermal state less than 100%) - drive overheating (condition: drive thermal state less than 70%) - motor overheating (condition: resistance of probes less than 1,500 Ohms) When the function is activated, following appearance of one or more of these faults, the R1 relay stays closed: the drive attempts to start every 30 s. A maximum of 6 attempts are made with the drive unable to start (fault present). If all 6 fail, the drive remains locked definitively with the fault relay open, until it is reset by being switched off.  This function requires the associated sequence to be maintained. Ensure that accidental restarting will not pose any danger to either equipment or personnel.	No												
rSt	Reset Type This function can be accessed if fault reset is assigned to a logic input. 2 possible options: partial reset (RSP), general reset (RSG) Faults affected by a partial reset (rSt = RSP) <table style="width: 100%; border: none;"> <tr> <td style="width: 50%;">- line overvoltage</td> <td style="width: 50%;">- DC bus overvoltage</td> </tr> <tr> <td>- motor overload</td> <td>- loss of 4-20 mA</td> </tr> <tr> <td>- motor overheating</td> <td>- overhauling</td> </tr> <tr> <td>- motor phase loss</td> <td>- drive overheating</td> </tr> <tr> <td>- serial link fault</td> <td>- external fault</td> </tr> <tr> <td>- communication fault</td> <td>- overspeed</td> </tr> </table> Faults affected by a general reset (rSt = RSG): all faults. The general reset actually inhibits all faults (forced operation). To configure rSt = RSG: <ol style="list-style-type: none"> 1 Display RSG 2 Press the "ENT" key 3 The drive displays "See manual" 4 Press ▲ then ▼ then "ENT" 	- line overvoltage	- DC bus overvoltage	- motor overload	- loss of 4-20 mA	- motor overheating	- overhauling	- motor phase loss	- drive overheating	- serial link fault	- external fault	- communication fault	- overspeed	RSP
- line overvoltage	- DC bus overvoltage													
- motor overload	- loss of 4-20 mA													
- motor overheating	- overhauling													
- motor phase loss	- drive overheating													
- serial link fault	- external fault													
- communication fault	- overspeed													
OPL	OutPhaseLoss Used to enable the motor phase loss fault. (Fault is eliminated if an isolator is used between the drive and the motor). Choice Yes/No	Yes												
IPL	InPhaseLoss Used to enable the line phase loss fault (fault is eliminated if there is a direct power supply via a DC bus). Choice Yes/No	Yes												

Fault Menu

Code	Description	Factory setting
THt	ThermProtType	ACL
	Defines the type of indirect motor thermal protection provided by the drive. If PTC probes are connected to the drive, this function is not available. No thermal protection: N0: No protection Self-cooled motor (ACL): the drive takes account of any derating depending on the rotation frequency. Force-cooled motor (FCL): the drive does not take account of any derating depending on the rotation frequency.	
LFL	LossFollower	No
	Used to enable the loss of 4-20 mA reference fault. This fault can only be configured if the AI2 min/max reference parameters (CrL and CrH) are greater than 3 mA or if CrL>CrH. <ul style="list-style-type: none"> - No: no fault - Yes: immediate fault - Stt: stop according to the Stt parameter, without a fault, restart when the signal returns - LSF: stop according to the Stt parameter, then fault at the end of stopping - LFF: force to the fallback speed set by the LFF parameter - RLS: maintaining the speed reached on appearance of the loss of 4-20 mA signal, without a fault, restarting when the signal returns. 	
LFF	4-20 Flt Spd	0
	Fallback speed in the event of loss of 4-20 mA signal. Adjustment from 0 to HSP.	
FLr	Catch On Fly	Yes
	Used to enable a smooth restart after one of the following events: <ul style="list-style-type: none"> - loss of line supply or simple power off - fault reset or automatic restart - freewheel stop or injection stop with logic input - uncontrolled loss downstream of the drive Choice Yes/No	
StP	Cont. Stop	No
	Controlled stop on a line phase loss. This function is only operational if parameter IPL is set to No. If IPL is set to Yes, leave StP in position No. Possible options: No : locking on loss of line supply MMS : Maintain Bus: the drive control unit continues to be powered by the kinetic energy generated by the inertia forces, until the USF fault (undervoltage) occurs FRP : Follow Ramp: deceleration following the programmed dEC or dE2 ramp until a stop or until the USF fault (undervoltage) occurs	
Sdd	RampNotFoll	Yes
	This function can be accessed if a tachogenerator or pulse generator feedback has been programmed. When enabled, it is used to lock the drive if a speed error is detected (difference between the stator frequency and the measured speed). Choice Yes/No	
EPL	External fault	Yes
	Defines the type of stop on external fault: <ul style="list-style-type: none"> - Yes: immediate fault - LSF Stop+flt: stop according to the Stt parameter, then fault at the end of stopping 	

Files Menu

This menu can be accessed when the switch is in position  .
The operations are only possible in stop mode with the drive locked.

The terminal is used to store 4 files containing the drive configurations.

Code	Description	Factory setting
F 15	File 1 State	FRE
F 25	File 2 State	FRE
F 35	File 3 State	FRE
F 45	File 4 State	FRE
	Used to display the state of the corresponding file. Possible states: FRE : file free (state in which terminal is delivered) EnG : a configuration has already been saved to this file	
F 0t	Operat.Type	NO
	Used to select the operation to be performed on the files. Possible operations: NO : no operation requested (default value on each new terminal connection to the drive) STR : operation to save the drive configuration to a file on the terminal REC : transfer the content of a file to the drive Ini : return the drive to factory settings  A return to factory settings cancels all your adjustments and your configuration.	

Operating mode

Select STR, REC or Ini and press "ENT".

1 If Operat.Type = STR:

The file numbers are displayed. Select a file using ▲ or ▼ and confirm with "ENT".

2 If Operat.Type = REC:

The file numbers are displayed. Select a file using ▲ or ▼ and confirm with "ENT".

- The display indicates:

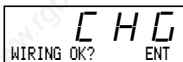

Check that the wiring is compatible with the file configuration.

Cancel with "ESC" or confirm with "ENT".

- The display then requests a second confirmation using "ENT" or cancellation using "ESC".

3 If Operat.Type = Ini:

- Confirm with "ENT".

- The display indicates:

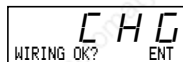

Check that the wiring is compatible with the factory configuration.

Cancel with "ESC" or confirm with "ENT".

- The display then requests a second confirmation using "ENT" or cancellation using "ESC".

At the end of each operation the display returns to the "Operat.Type" parameter set to "NO".

Files Menu

Files Menu (continued)

Code	Description
COd	Password
	Confidential code

The drive configuration can be protected by a password (COd).

CAUTION: THIS PARAMETER SHOULD BE USED WITH CAUTION. IT MAY PREVENT ACCESS TO ALL PARAMETERS. ANY MODIFICATION TO THE VALUE OF THIS PARAMETER MUST BE CAREFULLY NOTED AND SAVED.

The code value is given by four figures, the last of which is used to define the level of accessibility required by the user.



This figure gives the level of access permitted, without the correct code.

Access to the menus according to the position of the access locking switch on the rear of the terminal is always operational, within the limits authorized by the code.

The Code value 0000 (factory setting) does not restrict access.

The table below defines access to the menus according to the last figure in the code.

Menu	Last figure in the code		
	Access locked	Display	Modification
Adjustments	0 exc. 0000 and 9	1	2
Level 2: Adjustments, Macro-config, Drive, Control, I/O, Faults, Files (excluding code), Communication (if card present)	0 exc. 0000 and 9	3	4
Application (if card present)	0 exc. 0000 and 9	5	6
Level 2 and Application (if card present)	0 exc. 0000 and 9	7	8

For access to the APPLICATION menu, refer to the application card documentation.

The code is modified using the ▲ and ▼ keys.

If an incorrect code is entered, it is refused and the following message is displayed:

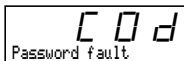

After pressing the ENT or ESC key on the keypad, the value displayed for the Code parameter changes to 0000: the level of accessibility does not change. The operation should be repeated.

To access menus protected by the access code, the user must first enter this code which can always be accessed in the Files menu.

Communication and Application Menus / Return to factory settings

Communication or Application menu

This menu is only displayed if a communication or application card is installed. It can be accessed when the switch is in position . Configuration is only possible in stop mode with the drive locked.

For use with a communication or application option card, refer to the document provided with this card.

For communication via the RS485 link on the base product, refer to the document provided with the RS485 connection kit.

Return to factory settings

- In order to use the keypad only (see page117)
- Proceed using the following method:

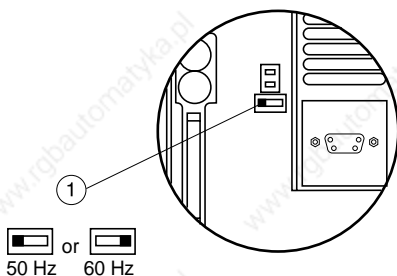

- Switch off the drive
- Unlock and open the Altivar cover in order to access the 50/60 Hz switch (1) on the control card. If an option card is present, the selector switch can be accessed through it.
- Change the position of the 50/60 Hz switch (1) on the control card
- Switch on the drive
- Switch off the drive
- Reset the 50/60 Hz switch (1) on the control card to its initial position (nominal motor frequency)
- Switch on the drive, and it reverts to its factory configuration.

Operation - Maintenance - Spares and Repairs

Operation

Signalling on the front panel of the Altivar

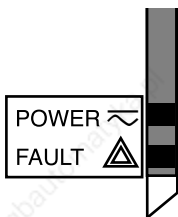

green POWER LED

red FAULT LED



on: Altivar powered up



• on: Altivar faulty

• flashing: Altivar locked once the "STOP" key has been pressed on the terminal or after a change to the configuration. The motor can then only be supplied with power after first resetting the "forward", "reverse", and "injection stop" commands.

Display mode on terminal screen

Displays preset frequency reference, or fault.

The display mode can be modified via the terminal: consult the programming manual.

Maintenance

Before performing any work on the drive, **switch off the power supply, check that the green LED has gone off, and wait for the capacitors to discharge** (3 to 10 minutes depending on the drive power rating).



The DC voltage at the + and - terminals or PA and PB terminals may reach 850 V depending on the line supply voltage.

If a problem arises during setup or operation, ensure that the recommendations relating to the environment, mounting and connections have been observed.

Servicing

The Altivar 38 does not require preventative maintenance. We nevertheless advise you regularly to:

- Check the condition and tightness of connections
- Ensure that the temperature around the unit remains at an acceptable level and that ventilation is effective (average service life of fans: 3 to 5 years depending on operating conditions)
- Remove any dust from the drive

Assistance with maintenance

The first fault detected is stored and displayed on the terminal display: the drive locks, the red LED (FAULT) illuminates, and fault relay R1 trips.

Clearing the fault

- Cut the power supply to the drive in the event of a non-resettable fault.
- Locate the cause of the fault in order to eliminate it.
- Reconnect the power supply: this clears the fault if it has disappeared.
- In some cases there may be an automatic restart once the fault has disappeared if this function has been programmed.

Spares and repairs

For spare parts and repairs to Altivar 38 drives, consult Schneider group product support.

Faults - causes - remedies

Fault displayed	Probable cause	Procedure, remedy
PHF Mains Phase Loss	<ul style="list-style-type: none"> drive incorrectly supplied or fuses blown transient fault on one phase drive supplied by DC bus 	<ul style="list-style-type: none"> check the power connection and the fuses reset configure the "InPhaseLoss" fault (code IPL) as "No", in the FAULT menu
USF Undervoltage	<ul style="list-style-type: none"> line supply too low transient voltage dip damaged load resistor 	<ul style="list-style-type: none"> check the line voltage change the load resistor
OSF Overvoltage	<ul style="list-style-type: none"> line supply too high 	<ul style="list-style-type: none"> check the line voltage
DHF Drive Overheated	<ul style="list-style-type: none"> heatsink temperature too high ($t_{Hd} > 118\%$) 	<ul style="list-style-type: none"> monitor the motor load, the drive ventilation and wait for the drive to cool down before resetting
DLF Mot Overload	<ul style="list-style-type: none"> thermal trip due to prolonged overload ($t_{Hr} > 118\%$) 	<ul style="list-style-type: none"> check the thermal protection setting, monitor the motor load a reset will be possible after approximately 7 minutes
DBF Overbraking	<ul style="list-style-type: none"> braking too sudden or driving load line supply overvoltage during operation 	<ul style="list-style-type: none"> increase the deceleration time, add a braking resistor if necessary check for any line overvoltages
DPF Motor Phase Loss	<ul style="list-style-type: none"> one phase open-circuit at the drive output 	<ul style="list-style-type: none"> check the motor connections and that the downstream contactor is closed (if it exists) if a motor starter is being used in a macro configuration, check that the R2 relay is configured as a downstream contactor
LFF LossFollower	<ul style="list-style-type: none"> loss of the 4-20 mA signal on input AI2 	<ul style="list-style-type: none"> check the connection of the reference circuits
OCF Overcurrent	<ul style="list-style-type: none"> ramp too short inertia or load too high mechanical locking 	<ul style="list-style-type: none"> check the settings check the size of the motor/drive/load check the state of the mechanism
SCF Short Circuit	<ul style="list-style-type: none"> short-circuit or grounding at the drive output 	<ul style="list-style-type: none"> check the connection cables with the drive disconnected, and the motor insulation. Check the drive transistor bridge
CrF Precharge Fault	<ul style="list-style-type: none"> load relay control fault damaged load resistor 	<ul style="list-style-type: none"> check the connectors in the drive and the load resistor
S1F RS485 F1t	<ul style="list-style-type: none"> incorrect connection on the drive connector port 	<ul style="list-style-type: none"> check the connection on the drive connector port
DtF Motor Overheated	<ul style="list-style-type: none"> motor temperature too high (PTC probes) 	<ul style="list-style-type: none"> check the motor ventilation and the ambient temperature, monitor the motor load check the type of probes used
tSF PTC Probe Fault	<ul style="list-style-type: none"> incorrect connection of probes to the drive 	<ul style="list-style-type: none"> check the connection of the probes to the drive check the probes

Faults - causes - remedies

Fault displayed	Probable cause	Procedure, remedy
<i>EEF</i> EEProm Fault	<ul style="list-style-type: none"> error saving in EEPROM 	<ul style="list-style-type: none"> cut the power supply to the drive and reset
<i>InF</i> Internal Fault	<ul style="list-style-type: none"> internal fault connector fault 	<ul style="list-style-type: none"> check the connectors in the drive
<i>EPF</i> External Fault	<ul style="list-style-type: none"> fault triggered by an external device 	<ul style="list-style-type: none"> check the device which has caused the fault and reset
<i>SPF</i> SP. Feedbk. Loss	<ul style="list-style-type: none"> no speed feedback 	<ul style="list-style-type: none"> check the connection and the mechanical coupling of the speed sensor
<i>RnF</i> Load Veer. Flt	<ul style="list-style-type: none"> non-following of ramp speed inverse to the reference 	<ul style="list-style-type: none"> check the speed feedback settings and the wiring check the suitability of the settings for the load check the size of the motor-drive and the possible need for a braking resistor
<i>SDF</i> Overspeed	<ul style="list-style-type: none"> instability driving load too high 	<ul style="list-style-type: none"> check the settings and the parameters add a braking resistor check the size of the motor/drive/load
<i>CnF</i> Network Fault	<ul style="list-style-type: none"> communication fault on the fieldbus 	<ul style="list-style-type: none"> check the network connection to the drive check the time-out
<i>ILF</i> Int. Comm. Flt	<ul style="list-style-type: none"> communication fault between the option card and the control card 	<ul style="list-style-type: none"> check the connection of the option card to the control card
<i>FFF</i> Rating Fault-ENT Option Fault-ENT Opt. Missing-ENT CKS Fault - ENT	<p>Error probably caused when changing the card:</p> <ul style="list-style-type: none"> change of rating of the power card change of the type of option card or installation of an option card if there was not one already and if the macro-config is CUS option card removed inconsistent configuration saved <p>Pressing ENT brings up the message: Fact.Set? ENT/ESC</p>	<ul style="list-style-type: none"> check the drive hardware configuration (power card, others) cut the power supply to the drive then reset save the configuration in a file in the terminal press ENT to return to factory settings
<i>CFI</i> Config. Fault	<ul style="list-style-type: none"> inconsistent configuration sent to drive via serial link 	<ul style="list-style-type: none"> check the configuration sent previously send a consistent configuration

Faults - causes - remedies

Malfunction with no fault display

Display	Probable cause	Procedure, remedy
No code, LEDs not illuminated	<ul style="list-style-type: none">No power supply	<ul style="list-style-type: none">Check power supply to drive
No code, green LED illuminated, red LED illuminated or not illuminated	<ul style="list-style-type: none">Terminal defective	<ul style="list-style-type: none">Change the terminal
<i>rdy</i> green LED illuminated	<ul style="list-style-type: none">Drive in line mode with communication card or RS 485 kitAn LI input is assigned to "Freewheel stop" or "Fast stop", and this input is not energized These stops are controlled by loss of the input	<ul style="list-style-type: none">Set parameter LI4 to forced local mode then use LI4 to confirm this forced modeConnect the input to 24 V to disable the stop

Record of configuration and adjustments

Drive reference ATV38 Display rEF:
 Customer identification number (if applicable):
 Option card: no yes : reference

Access code: no yes :
 Configuration in file no. on the operator terminal
 Macro-configuration:

For a **CUS: customised** configuration, assign the I/O as follows:

	ALTIVAR	Option card
Logic inputs	LI 1: LI 2: LI 3: LI 4:	LI 5: LI 6:
Analog inputs	AI 1: AI 2:	AI 3:
Encoder input		AI3:
Relay	R2:	
Logic output		LO:
Analog output	AO1:	AO:

Adjustment parameters:

Code	Factory setting	Customer setting (1)	Code	Factory setting	Customer setting (1)
<i>RCC</i>	3 s	s	<i>SP5</i>	25 Hz	Hz
<i>dEC</i>	3 s	s	<i>SP6</i>	30 Hz	Hz
<i>L5P</i>	0 Hz	Hz	<i>SP7</i>	35 Hz	Hz
<i>H5P</i>	50 Hz	Hz	<i>SP8</i>	50 Hz	Hz
<i>FLG</i>	20%	%	<i>JGG</i>	10 Hz	Hz
<i>5tR</i>	20%	%	<i>JGt</i>	0.5 s	s
<i>ltH</i>	According to model	A	<i>FFt</i>	0 Hz	Hz
<i>ldC</i>	According to model	A	<i>bIP</i>	no	
<i>tdC</i>	0.5 s	s	<i>rPG</i>	1	
<i>5dC</i>	0.5 ltH	A	<i>rIG</i>	1/s	/s
<i>RC2</i>	5 s	s	<i>Fb5</i>	1	
<i>dE2</i>	5 s	s	<i>PIC</i>	no	
<i>JPF</i>	0 Hz	Hz	<i>dt5</i>	1	
<i>JF2</i>	0 Hz	Hz	<i>Ctd</i>	1.1 In	A
<i>JF3</i>	0 Hz	Hz	<i>ttt</i>	100%	%
<i>tt5</i>	0	s	<i>P5P</i>	0 s	s
<i>USC</i>	1		<i>P12</i>	30%	%
<i>UFr</i>	100%	%	<i>P13</i>	60%	%
<i>PFL</i>	20%	%	<i>dttd</i>	105%	%
<i>SP2</i>	10 Hz	Hz	<i>Ftd</i>	50 Hz	Hz
<i>SP3</i>	15 Hz	Hz	<i>F2d</i>	50 Hz	Hz
<i>SP4</i>	20 Hz	Hz			

(1) leave blank when the parameter is missing

Record of configuration and adjustments

Drive menu parameters:

Code	Factory setting	Customer setting (1)	Code	Factory setting	Customer setting (1)
<i>Un5</i>	according to model	V	<i>rPt</i>	LIN	
<i>Fr5</i>	50 Hz	Hz	<i>dCf</i>	4	
<i>nCr</i>	according to model	A	<i>CLl</i>	1.1 In	A
<i>n5P</i>	according to model	rpm	<i>AdC</i>	yes	
<i>CO5</i>	according to model		<i>PCC</i>	1	
<i>tUn</i>	no		<i>5Ft</i>	LF	
<i>tFr</i>	60 Hz	Hz	<i>5Fr</i>	according to model	kHz
<i>nLd</i>	yes		<i>nrd</i>	yes	
<i>Fdb</i>	no		<i>5Pc</i>	no	
<i>brR</i>	yes		<i>Pct</i>	DET	
<i>Fr t</i>	0 Hz		<i>PL5</i>	1024	
<i>St t</i>	STN				

(1) leave blank when the parameter is missing

Control menu parameters:

Code	Factory setting	Customer setting (1)	Code	Factory setting	Customer setting (1)
<i>tCC</i>	2 W		<i>RDH</i>	20 mA	mA
<i>tCt</i>	LEL		<i>St r</i>	No	
<i>rIn</i>	no		<i>LCC</i>	no	
<i>b5P</i>	no		<i>PSt</i>	yes	
<i>CrL</i>	4 mA	mA	<i>Rdd</i>	0	
<i>CrH</i>	20 mA	mA	<i>tbr</i>	19200	
<i>RDl</i>	0 mA	mA	<i>rPr</i>	No	

(1) leave blank when the parameter is missing

Fault menu parameters:

Code	Factory setting	Customer setting (1)	Code	Factory setting	Customer setting (1)
<i>Rt r</i>	no		<i>LFf</i>	0 Hz	Hz
<i>rSt</i>	RSP		<i>FLr</i>	yes	
<i>OPL</i>	yes		<i>StP</i>	no	
<i>IPL</i>	yes		<i>Sdd</i>	yes	
<i>tHt</i>	ACL		<i>EPL</i>	yes	
<i>LFL</i>	no				

(1) leave blank when the parameter is missing

Summary of menus

LANGUAGE menu

Name	Code
English	<i>LnG</i>
Français	<i>LnG</i>
Deutsch	<i>LnG</i>
Español	<i>LnG</i>
Italiano	<i>LnG</i>

MACRO-CONFIG menu

Name	Code
UT: Var. Torque	<i>LF</i>

1 - DISPLAY menu

Name	Code
Drive State	<i>---</i>
Freq. Ref.	<i>FrH</i>
Output Freq.	<i>rFr</i>
Motor Speed	<i>SPd</i>
Motor Current	<i>LCr</i>
Mach. Speed	<i>USP</i>
Output Power	<i>DPp</i>
Mains Voltage	<i>ULn</i>
Motor Thermal	<i>tHr</i>
Drive Thermal	<i>tHd</i>
Last Fault	<i>LFt</i>
Freq. Ref.	<i>LFr</i>
Power Used	<i>APH</i>
Run time	<i>rEtH</i>

2 - ADJUST menu

Name	Code
Freq. Ref. - Hz	<i>LFr</i>
Acceleration - s	<i>ACC</i>
Deceleration - s	<i>dEC</i>
Accel. 2 - s	<i>ACC2</i>
Decel. 2 - s	<i>dEC2</i>
Low Speed - Hz	<i>LSP</i>
High Speed - Hz	<i>HSP</i>
Gain - %	<i>FLG</i>
Stability - %	<i>StA</i>
ThermCurrent - A	<i>tEtH</i>
DC Inj. Time - s	<i>tEdC</i>
dc I at rest - A	<i>SdC</i>
Jump Freq. - Hz	<i>JPF</i>
Jump2 Freq. - Hz	<i>JF2</i>
Jump3 Freq. - Hz	<i>JF3</i>

2 - ADJUST menu (continued)

Name	Code
Machine Coef.	<i>USC</i>
IR Compens.	<i>UFr</i>
LSP Time - s	<i>tLS</i>
DC Inj.Curr. - A	<i>IdC</i>
V/f Profile - %	<i>PFL</i>
Preset SP.2 - Hz	<i>SP2</i>
Preset SP.3 - Hz	<i>SP3</i>
Preset SP.4 - Hz	<i>SP4</i>
Preset SP.5 - Hz	<i>SP5</i>
Preset SP.6 - Hz	<i>SP6</i>
Preset SP.7 - Hz	<i>SP7</i>
Preset SP.8 - Hz	<i>SP8</i>
Jo9 Freq. - Hz	<i>JOG</i>
Jo9 Delay - s	<i>JGt</i>
NST Threshold - Hz	<i>FFt</i>
Tacho Coeff.	<i>tEtS</i>
PI Prop.Gain	<i>rPG</i>
PI Int.Gain - /s	<i>rIG</i>
PI Coeff.	<i>FbS</i>
PI Inversion	<i>PIC</i>
Freq.Lev.Att - Hz	<i>FtEd</i>
Freq.2 Att - Hz	<i>F2d</i>
Curr.Lev.Att - A	<i>Ctd</i>
PI Filter - s	<i>PSP</i>
PI Preset 2 - %	<i>P12</i>
PI Preset 3 - %	<i>P13</i>
ATV th.fault	<i>dtd</i>

3 - DRIVE menu

Name	Code
Nom.Mot.Volt -V	<i>UnS</i>
Nom.Mot.Freq - Hz	<i>FrS</i>
Nom. Mot.Curr - A	<i>nCr</i>
Nom.MotSpeed - rpm	<i>nSP</i>
Mot. Cos Phi	<i>COs</i>
Auto Tuning	<i>tUn</i>
Max Freq. - Hz	<i>tFr</i>
Energy Eco	<i>nLd</i>
I lim adapt.	<i>Fdb</i>
DecRampAdapt	<i>brA</i>
SwitchRamp2 - Hz	<i>FrE</i>
Stop Type	<i>StE</i>
Ramp Type	<i>rPE</i>

Summary of menus

3 - DRIVE menu (continued)

Name	Code
DecrAmpCoeff	<i>dCF</i>
Int. I Lim - A	<i>CL I</i>
Auto DC Inj.	<i>AdC</i>
Motor P Coef	<i>PCC</i>
Sw Freq. Type	<i>SFt</i>
Sw Freq - kHz	<i>SFr</i>
Noise Reduct	<i>nrd</i>
Special Motor	<i>SPC</i>
PG Type	<i>PGt</i>
Num. Pulses	<i>PLS</i>

4 - CONTROL menu

Name	Code
TermStrip Con	<i>tCC</i>
Type 2 Wire	<i>tCt</i>
RV inhibit	<i>rIn</i>
deadb/Pedst	<i>bSP</i>
AI2 min Ref. - mA	<i>CrL</i>
AI2 Max Ref. - mA	<i>CrH</i>
Min Val. AO - mA	<i>ADL</i>
Max Val. AO - mA	<i>ADH</i>
Save Ref.	<i>StR</i>
Keypad Comm.	<i>LCC</i>
STOP Priorit	<i>PSt</i>
DriveAddress	<i>AdD</i>
BdRate RS485	<i>tbr</i>
Reset cnts	<i>rPr</i>

5 - I/O menu

Name	Code
LI2 Assi9n.	<i>L 12</i>
LI3 Assi9n.	<i>L 13</i>
LI4 Assi9n.	<i>L 14</i>
LI5 Assi9n.	<i>L 15</i>
LI6 Assi9n.	<i>L 16</i>
NO :Not assigned	
RV :Reverse	
RP2:Switch ramp2	
JOG	
+SP: + Speed	
-SP: - Speed	
PS2: 2 Preset Speeds	
PS4 : 4 Preset Speeds	
PS8 : 8 Preset Speeds	

5 - I/O menu (continued)

Name	Code
NST:Freewhl Stop	
DCI:DC inject.	
FST:Fast stop	
CHP:Multi. Motor	
FLO:Forced Local	
RST:Fault Reset	
RFC:Auto/Manu	
ATN:Auto Tuning	
PAU:PI Auto/Man	
PR2:PI 2 Preset	
PR4:PI 4 Preset	
EDD:External flt	
FTK: Forc.KeyP.	
R2 Assi9n.	<i>r 2</i>
LO assi9n.	<i>L 0</i>
NO :Not assigned	
RUN:Drive Running	
OCC:OutPut Cont.	
FTA:Freq Attain.	
FLA:HSP Attained	
CTA:I Attained	
SRA:FRH Attained	
TSA:MtrTherm Lvl	
APL:LossFollower	
F2A:Freq 2 Attain.	
tAd:ATU th.alarm	
AI2 assi9n.	<i>A 12</i>
AI3 Assi9n.	<i>A 13</i>
NO :Not assigned	
FR2:Speed Ref2	
SAI:Summed Ref.	
PIF:PI Regulator	
PIM:PI Man.ref.	
SFB:Tacho feedbk	
PTC:Therm.Sensor	
AI3 assi9n. (encoder)	<i>A 13</i>
NO :Not assigned	
SAI:Summed Ref.	
RGI:Retour GI	
AO assi9n.	<i>AO</i>
NO :Not assigned	

Summary of menus

5 - I/O menu (continued)

Name	Code
OCR:Motor Curr.	
OFr:Motor Freq	
ORP:OutPut ramp	
ORS:Signed ramp	
OPS:PI ref.	
OPF:PI Feedback	
OPE:PI Error	
OPI:PI Integral	
OPr:OutPut Power	
tHr:MotorThermal	
tHd:DriveThermal	

6 - FAULT menu

Name	Code
Auto Restart	<i>Rt r</i>
Reset Type	<i>rSt</i>
OutPhaseLoss	<i>OPL</i>
InPhaseLoss	<i> IPL</i>
Cont. Stop	<i>StP</i>
ThermProType	<i>tHt</i>
LossFollower	<i>LFL</i>
4-20 Flt Spd	<i>LFF</i>
Catch On Fly	<i>FLr</i>
RampNotFoll	<i>Sdd</i>
External fault	<i>EPL</i>

7 - FILES menu

Name	Code
File 1 State	<i>F1S</i>
File 2 State	<i>F2S</i>
File 3 State	<i>F3S</i>
File 4 State	<i>F4S</i>
Operat.Type	<i>F0t</i>
Password	<i>C0d</i>

8 - COMMUNICATION menu

Refer to the documentation provided with the communication card.

8 - APPLICATION menu

Refer to the documentation provided with the application card.

Function	Menus	Pages
Acceleration	ADJUST - DRIVE	93-97
Automatic ramp adaptation	DRIVE	96
Serial link address	CONTROL	101
Controlled stop	I/O - FAULT	102-116
Auto Tuning	DRIVE - I/O	96-102-110
Speed loop with encoder	DRIVE - I/O	98-103-104-112
Speed loop with tachometer	ADJUST - I/O	95-103-104-111
Password	FILES	118
2/3-wire control	CONTROL	99-107
Motor switching	DRIVE - I/O	97-102-110
Ramp switching	ADJUST - DRIVE - I/O	94-96-102-104-107
Reference switching	I/O	102-109
Downstream contactor	I/O	103-112
Deceleration	ADJUST - DRIVE	93-97
External fault	I/O	110
Energy saving	DRIVE	96
Analog input AI2	CONTROL	100
Configurable inputs	I/O	102-103-104
Force to keypad	CONTROL - I/O	102-110
Forced local mode	CONTROL - I/O	102-110
Injection braking	ADJUST - DRIVE	93-94-97
Switching frequency	DRIVE	98
Jump frequencies	ADJUST	93
Current limit	DRIVE	96-97
Low speed limit time	ADJUST	93
Save reference	CONTROL	101
Step by step (JOG)	ADJUST - I/O	94-102-104-107
Loss of 4-20mA	FAULT	113
+/- speed	I/O	102-105-108
Stop priority	CONTROL	101
Motor thermal protection	ADJUST - I/O - FAULT	93-95-103-104-116
Auto catching (flying restart)	FAULT	116
Automatic restart	FAULT	115
Factory setting / Save	FILES	117
PI regulator	ADJUST - I/O	95-103-104-111
Fault reset	I/O - FAULT	102-105-110-115
PTC probes	I/O	103-111
Configurable outputs	CONTROL - I/O	100-103-104-112-113
Preset speeds	ADJUST - I/O	94-102-104-109

VVDED302071

039481

W9 1623845 01 11 A01

2002-07

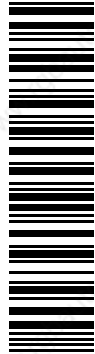

0 01 62384 5 1101 2