

SGMJV-□, SGMJV-□, SGMEV-□, SGMGV-□, SGMSV-□

# Sigma-5 rotary servo motors

The ideal servo family for motion control. Fast response, high speed, and high accuracy.

- Contributing to machine performance in conjunction with a medium-inertia motor.
- Peak torque 350% of nominal during 3 seconds
- Automatic motor recognition by servo drive
- IP67 and shaft oil seal available
- High resolution encoders
- Absolute multiturn encoder solution
- Compact design and robust construction

### Ratings

- 230 VAC from 50 W to 1.5 kW (rated torque from 0.159 to 4.77 Nm)
- 400 VAC from 200 W to 15 kW (rated torque from 0.637 Nm to 95.4 Nm)



## System configuration

(Refer to servo drive chapter)

Drive options

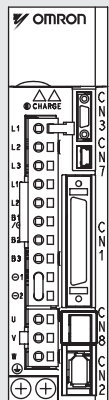

Analog Pulse Models

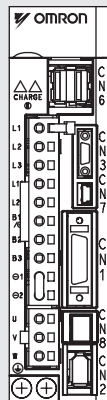

MECHATROLINK-II Models

Power, encoder and brake cables

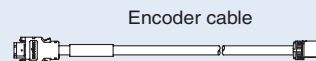

Encoder cable

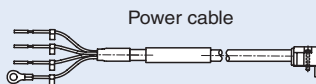

Power cable

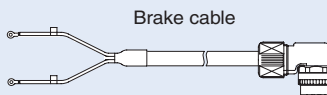

Brake cable

(a separate brake cable to use only for SGMGV and SGMSV servo motors from 850W)

Servo motors

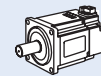

SGMJV Servo Motor  
3000 rpm (50-750 W)

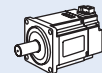

SGMAV Servo Motor  
3000 rpm (50W-1kW)



SGMEV Servo Motor  
3000 rpm (100W-1.5kW)

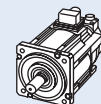



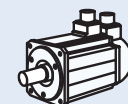

SGMGV Servo Motor  
1500 rpm (300W-15 kW)



SGMSV Servo Motor  
3000 rpm (1-5kW)

Servo motor / servo drive combination

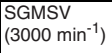
| Sigma-5 rotary servo motor  |         |  |          |            | Sigma-5 servo drive             |                                    |                                 |                                    |                |                |
|---|---------|--|----------|------------|---------------------------------|------------------------------------|---------------------------------|------------------------------------|----------------|----------------|
|   | Voltage | Rated torque   | Capacity | Model      | 230 V (1-phase)<br>Analog Pulse | 200 V (1-phase)<br>MECHATROLINK-II | 400 V (3-phase)<br>Analog Pulse | 400 V (3-phase)<br>MECHATROLINK-II |                |                |
| <br>SGMJV<br>(3000 min <sup>-1</sup> )   | 230 V   | 0.159 Nm   | 50 W     | SGMJV-A5A□ | SGDV-A5A01A-OY                  | SGDV-A5A11A-OY                     | -                               | -                                  |                |                |
|   |         | 0.318 Nm   | 100 W    | SGMJV-01A□ | SGDV-01A01A-OY                  | SGDV-01A11A-OY                     | -                               | -                                  |                |                |
|   |         | 0.637 Nm   | 200 W    | SGMJV-02A□ | SGDV-02A01A-OY                  | SGDV-02A11A-OY                     | -                               | -                                  |                |                |
|   |         | 1.27 Nm  | 400 W    | SGMJV-04A□ | SGDV-04A01A-OY                  | SGDV-04A11A-OY                     | -                               | -                                  |                |                |
|   |         | 2.39 Nm  | 750 W    | SGMJV-08A□ | SGDV-08A01A-OY                  | SGDV-08A11A-OY                     | -                               | -                                  |                |                |
| <br>SGMAV<br>(3000 min <sup>-1</sup> )   | 230 V   | 0.159 Nm   | 50 W     | SGMAV-A5A□ | SGDV-A5A01A-OY                  | SGDV-A5A11A-OY                     | -                               | -                                  |                |                |
|   |         | 0.318 Nm   | 100 W    | SGMAV-01A□ | SGDV-01A01A-OY                  | SGDV-01A11A-OY                     | -                               | -                                  |                |                |
|   |         | 0.477 Nm   | 150 W    | SGMAV-C2A□ | SGDV-02A01A-OY                  | SGDV-02A11A-OY                     | -                               | -                                  |                |                |
|   |         | 0.637 Nm   | 200 W    | SGMAV-02A□ | SGDV-02A01A-OY                  | SGDV-02A11A-OY                     | -                               | -                                  |                |                |
|   |         | 1.27 Nm  | 400 W    | SGMAV-04A□ | SGDV-04A01A-OY                  | SGDV-04A11A-OY                     | -                               | -                                  |                |                |
|   |         | 1.75 Nm  | 550 W    | SGMAV-06A□ | SGDV-08A01A-OY                  | SGDV-08A11A-OY                     | -                               | -                                  |                |                |
|   |         | 2.39 Nm  | 750 W    | SGMAV-08A□ | SGDV-08A01A-OY                  | SGDV-08A11A-OY                     | -                               | -                                  |                |                |
|   |         | 3.18 Nm  | 1 kW     | SGMAV-10A□ | SGDV-15A01A-OY-008000           | SGDV-15A11A-OY-008000              | -                               | -                                  |                |                |
| <br>SGMEV<br>(3000 min <sup>-1</sup> )   | 230 V   | 0.318 Nm   | 100 W    | SGMEV-01A□ | SGDV-01A01A-OY                  | SGDV-01A11A-OY                     | -                               | -                                  |                |                |
|   |         | 0.637 Nm   | 200 W    | SGMEV-02A□ | SGDV-02A01A-OY                  | SGDV-02A11A-OY                     | -                               | -                                  |                |                |
|   |         | 1.27 Nm  | 400 W    | SGMEV-04A□ | SGDV-04A01A-OY                  | SGDV-04A11A-OY                     | -                               | -                                  |                |                |
|   |         | 2.39 Nm  | 750 W    | SGMEV-08A□ | SGDV-08A01A-OY                  | SGDV-08A11A-OY                     | -                               | -                                  |                |                |
|   |         | 4.77 Nm  | 1.5 kW   | SGMEV-15A□ | SGDV-15A01A-OY-008000           | SGDV-15A11A-OY-008000              | -                               | -                                  |                |                |
|   | 400 V   | 0.637 Nm   | 200 W    | SGMEV-02D□ | -                               | -                                  | SGDV-05D01A-OY                  | SGDV-05D11A-OY                     |                |                |
|   |         | 0.955 Nm   | 300 W    | SGMEV-03D□ | -                               | -                                  | SGDV-05D01A-OY                  | SGDV-05D11A-OY                     |                |                |
|   |         | 1.27 Nm  | 400 W    | SGMEV-04D□ | -                               | -                                  | SGDV-05D01A-OY                  | SGDV-05D11A-OY                     |                |                |
|   |         | 2.07 Nm  | 650 W    | SGMEV-07D□ | -                               | -                                  | SGDV-10D01A-OY                  | SGDV-10D11A-OY                     |                |                |
|   |         | 2.39 Nm  | 750 W    | SGMEV-08D□ | -                               | -                                  | SGDV-10D01A-OY                  | SGDV-10D11A-OY                     |                |                |
| <br>SGMGV<br>(1500 min <sup>-1</sup> ) | 400 V   | 1.96 Nm  | 300 W    | SGMGV-03D□ | -                               | -                                  | SGDV-05D01A-OY                  | SGDV-05D11A-OY                     |                |                |
|   |         | 2.86 Nm  | 450 W    | SGMGV-05D□ | -                               | -                                  | SGDV-05D01A-OY                  | SGDV-05D11A-OY                     |                |                |
|   |         | 5.39 Nm  | 850 W    | SGMGV-09D□ | -                               | -                                  | SGDV-10D01A-OY                  | SGDV-10D11A-OY                     |                |                |
|   |         | 8.34 Nm  | 1.3 kW   | SGMGV-13D□ | -                               | -                                  | SGDV-15D01A-OY                  | SGDV-15D11A-OY                     |                |                |
|   |         | 11.5 Nm  | 1.8 kW   | SGMGV-20D□ | -                               | -                                  | SGDV-20D01A-OY                  | SGDV-20D11A-OY                     |                |                |
|   |         | 18.6 Nm  | 2.9 kW   | SGMGV-30D□ | -                               | -                                  | SGDV-30D01A-OY                  | SGDV-30D11A-OY                     |                |                |
|   |         | 28.4 Nm  | 4.4 kW   | SGMGV-44D□ | -                               | -                                  | SGDV-50D01A-OY                  | SGDV-50D11A-OY                     |                |                |
|   |         | 35.0 Nm  | 5.5 kW   | SGMGV-55D□ | -                               | -                                  | SGDV-210D01A                    | SGDV-210D11A                       |                |                |
|   |         | 48.0 Nm  | 7.5 kW   | SGMGV-75D□ | -                               | -                                  | SGDV-260D01A                    | SGDV-260D11A                       |                |                |
|   |         | 70.0 Nm  | 11 kW    | SGMGV-1AD□ | -                               | -                                  | SGDV-280D01A                    | SGDV-280D11A                       |                |                |
|   |         | 95.4 Nm  | 15 kW    | SGMGV-1ED□ | -                               | -                                  | SGDV-370D01A                    | SGDV-370D11A                       |                |                |
|   |         | <br>SGMSV<br>(3000 min <sup>-1</sup> ) | 400 V    | 3.18 Nm    | 1 kW                            | SGMSV-10D□                         | -                               | -                                  | SGDV-10D01A-OY | SGDV-10D11A-OY |
|   |         |  |          | 4.9 Nm     | 1.5 kW                          | SGMSV-15D□                         | -                               | -                                  | SGDV-15D01A-OY | SGDV-15D11A-OY |
| 6.36 Nm   | 2 kW    |  |          | SGMSV-20D□ | -                               | -                                  | SGDV-20D01A-OY                  | SGDV-20D11A-OY                     |                |                |
| 7.96 Nm   | 2.5 kW  |  |          | SGMSV-25D□ | -                               | -                                  | SGDV-30D01A-OY                  | SGDV-30D11A-OY                     |                |                |
| 9.8 Nm  | 3 kW    |  |          | SGMSV-30D□ | -                               | -                                  | SGDV-30D01A-OY                  | SGDV-30D11A-OY                     |                |                |
| 12.6 Nm   | 4 kW    |  |          | SGMSV-40D□ | -                               | -                                  | SGDV-50D01A-OY                  | SGDV-50D11A-OY                     |                |                |
| 15.8 Nm   | 5 kW    |  |          | SGMSV-50D□ | -                               | -                                  | SGDV-50D01A-OY                  | SGDV-50D11A-OY                     |                |                |

**Note:** 1. For servo motor and cables part numbers refer to ordering information at the end of this chapter  
 2. Refer to the servo drive chapter for drive options selection and detailed specifications

Type designation

Servo motor

**SGMJV - 01 A 1 A 6 S - OY**

Sigma-5 servo motor type

- SGMJV: Middle-inertia
- SGMAV: Low-inertia and high dynamics
- SGMEV: Flat type
- SGMGV: High-torque type
- SGMSV: Low-inertia and high dynamics

Omron-Yaskawa Motion Control B.V.  
(Note: all models except 5.5 to 15 kW)

Brake, oil seal specifications

| Code | Options                    | Type  |       |       |       |       |
|------|----------------------------|-------|-------|-------|-------|-------|
|      |                            | SGMJV | SGMAV | SGMEV | SGMGV | SGMSV |
| 1    | No brake, no oil/dust seal | ●     | ●     | ●     | ○     | ○     |
| B    | 90 VDC brake               | ○     | ○     | ○     | ○     | ○     |
| C    | 24 VDC brake               | ○     | ○     | ○     | ○     | ○     |
| D    | Oil seal + 90 VDC brake    | ○     | ○     | ○     | ○     | ○     |
| E    | Oil seal + 24 VDC brake    | ○     | ○     | ○     | ○     | ○     |
| F    | Dust seal                  | ○     | ○     | ○     | ●     | ●     |
| G    | Dust seal + 90 VDC brake   | ○     | ○     | ○     | ○     | ○     |
| H    | Dust seal + 24 VDC brake   | ○     | ○     | ○     | ○     | ○     |
| S    | Oil seal                   | ○     | ○     | ○     | ○     | ○     |

●: Standard ○: Option

Capacity (kW)

| Code | SGMJV                  | SGMAV                  | SGMEV                  | SGMGV                  | SGMSV                  |
|------|------------------------|------------------------|------------------------|------------------------|------------------------|
|      | 3000 min <sup>-1</sup> | 3000 min <sup>-1</sup> | 3000 min <sup>-1</sup> | 1500 min <sup>-1</sup> | 3000 min <sup>-1</sup> |
| A5   | 0.05                   | 0.05                   |                        |                        |                        |
| 01   | 0.1                    | 0.1                    | 0.1                    |                        |                        |
| C2   |                        | 0.15                   |                        |                        |                        |
| 02   | 0.2                    | 0.2                    | 0.2                    |                        |                        |
| 03   |                        |                        | 0.3                    | 0.3                    |                        |
| 04   | 0.4                    | 0.4                    | 0.4                    |                        |                        |
| 05   |                        |                        |                        | 0.45                   |                        |
| 06   |                        | 0.55                   |                        |                        |                        |
| 07   |                        |                        | 0.65                   |                        |                        |
| 08   | 0.75                   | 0.75                   | 0.75                   |                        |                        |
| 09   |                        |                        |                        | 0.85                   |                        |
| 10   |                        | 1.0                    |                        |                        | 1.0                    |
| 13   |                        |                        |                        | 1.3                    |                        |
| 15   |                        |                        | 1.5                    |                        | 1.5                    |
| 20   |                        |                        |                        | 1.8                    | 2.0                    |
| 25   |                        |                        |                        |                        | 2.5                    |
| 30   |                        |                        |                        | 2.9                    | 3.0                    |
| 40   |                        |                        |                        |                        | 4.0                    |
| 44   |                        |                        |                        | 4.4                    |                        |
| 50   |                        |                        |                        |                        | 5.0                    |
| 55   |                        |                        |                        | 5.5                    |                        |
| 70   |                        |                        |                        |                        |                        |
| 75   |                        |                        |                        | 7.5                    |                        |
| 1A   |                        |                        |                        | 11                     |                        |
| 1E   |                        |                        |                        | 15                     |                        |

Shaft end specifications

| Code | Shaft end                | Type  |       |       |       |       |
|------|--------------------------|-------|-------|-------|-------|-------|
|      |                          | SGMJV | SGMAV | SGMEV | SGMGV | SGMSV |
| 2    | Straight, no key         | ○     | ○     | ○     | ○     | ○     |
| 6    | Straight, key, tapped    | ●     | ●     | ●     | ●     | ●     |
| 8    | Straight, no key, tapped | ○     | ○     | ○     | ○     | ○     |
| B    | With two flat seats      | ○     | ○     | ○     | ○     | ○     |

●: Standard ○: Option

Design Revision Order:

- A: Standard
- E: IP67 (SGMEV-01, 02, 04, 08, 15)
- F: Prepared for oil seal mounting (SGMEV-03, 07)

Serial encoder specifications

| Code | Encoder            | Type  |       |       |       |       |
|------|--------------------|-------|-------|-------|-------|-------|
|      |                    | SGMJV | SGMAV | SGMEV | SGMGV | SGMSV |
| A    | 13-bit incremental | ○     | ○     | ○     | ○     | ○     |
| D    | 20-bit incremental | ●     | ●     | ●     | ●     | ●     |
| 3    | 20-bit absolute    | ○     | ○     | ○     | ○     | ○     |

●: Standard ○: Option

Voltage

| Code | Voltage | Type  |       |       |       |       |
|------|---------|-------|-------|-------|-------|-------|
|      |         | SGMJV | SGMAV | SGMEV | SGMGV | SGMSV |
| A    | 230 V   | ●     | ○     | ○     | ○     | ○     |
| D    | 400 V   | ○     | ○     | ○     | ○     | ○     |

Servo motor specifications

Type SGMJV, 230 V

Ratings and specifications

| Applied voltage                         |   | 230 V   |        |       |       |       |      |
|---|---|---|--------|-------|-------|-------|------|
| Servo motor model SGMJV-□               |   | A5A□  | 01A□   | 02A□  | 04A□  | 08A□  |      |
| Rated output <sup>1</sup>               | W   | 50  | 100    | 200   | 400   | 750   |      |
| Rated torque <sup>1,2</sup>             | N·m   | 0.159   | 0.318  | 0.637 | 1.27  | 2.39  |      |
| Instantaneous peak torque <sup>1</sup>  | N·m   | 0.557   | 1.11   | 2.23  | 4.46  | 8.36  |      |
| Rated current <sup>1</sup>              | A (rms)   | 0.61  | 0.84   | 1.6   | 2.7   | 4.7   |      |
| Instantaneous max. current <sup>1</sup> | A (rms)   | 2.1   | 2.9    | 5.8   | 9.3   | 16.9  |      |
| Rated speed <sup>1</sup>                | min <sup>-1</sup>                                   | 3000  |        |       |       |       |      |
| Max. speed <sup>1</sup>                 | min <sup>-1</sup>                                   | 6000  |        |       |       |       |      |
| Torque constant                         | N·m/A (rms)   | 0.285   | 0.413  | 0.435 | 0.512 | 0.544 |      |
| Rotor moment of inertia (JM)            | kg·m <sup>2</sup> ×10 <sup>-4</sup> (without brake) | 0.0414  | 0.0665 | 0.259 | 0.442 | 1.57  |      |
|   | kg·m <sup>2</sup> ×10 <sup>-4</sup> (with brake)    | 0.0489  | 0.0740 | 0.323 | 0.506 | 1.74  |      |
| Allowable load moment of inertia (JL)   | Multiple of (JM)                                    | 15  |        |       | 10    |       |      |
| Rated power rate <sup>1</sup>           | kW/s  | 6.11  | 15.2   | 15.7  | 36.5  | 36.3  |      |
| Rated angular acceleration <sup>1</sup> | rad/s <sup>2</sup>                                  | 38400   | 47800  | 24600 | 28800 | 15200 |      |
| Encoder                                 | Standard  | Incremental encoder (20 bits)                                 |        |       |       |       |      |
|   | Option  | Incremental encoder (13 bits)/ Absolute encoder (20 bits)     |        |       |       |       |      |
| Allowable radial load                   | N   | 78  |        | 245   |       | 392   |      |
| Allowable thrust load                   | N   | 54  |        | 74    |       | 147   |      |
| Approx. mass                            | Kg (without brake)                                  | 0.3   | 0.4    | 0.9   | 1.3   | 2.7   |      |
|   | Kg (with brake)                                     | 0.6   | 0.7    | 1.5   | 1.9   | 3.6   |      |
| Brake specifications                    | Rated voltage                                       | 24 VDC  |        |       |       |       |      |
|   | Power consumption (at 20°C)                         | W   | 6      |       | 6.9   |       |      |
|   | Current consumption (at 20°C)                       | A   | 0.25   |       | 0.29  |       |      |
|   | Holding torque                                      | N·m   | 0.159  | 0.318 | 0.637 | 1.27  | 2.39 |
|   | Rise time for holding torque                        | ms (max)  | 100    |       |       |       |      |
|   | Release time  | ms (max)  | 60     |       |       |       | 80   |
| Basic specifications                    | Time rating   | Continuous  |        |       |       |       |      |
|   | Thermal class                                       | Class B   |        |       |       |       |      |
|   | Usage/ storage temperature                          | 0 to +40 °C/ -20 to 60 °C without freezing                    |        |       |       |       |      |
|   | Usage/ storage humidity                             | 20 to 80% RH (non-condensing)                                 |        |       |       |       |      |
|   | Vibration class                                     | 15 µm or below  |        |       |       |       |      |
|   | Insulation resistance                               | 500 VDC, 10 MOhm min.   |        |       |       |       |      |
|   | Withstand voltage                                   | 1500 VAC for one minute                                       |        |       |       |       |      |
|   | Enclosure   | Totally-enclosed, self-cooled, IP65 (excluding shaft opening) |        |       |       |       |      |
|   | Vibration resistance                                | Vibration acceleration 49 m/s <sup>2</sup>                    |        |       |       |       |      |
|   | Altitude  | 1000 m or less above sea level                                |        |       |       |       |      |
| Mounting                                | Flange-mounted                                      |   |        |       |       |       |      |

**Note:** 1. These items and torque/speed characteristics quoted in combination with an SGD servo drive are at an armature winding temperature of 100°C. Other values quoted are at 20°C.

2. The rated torques listed here are the values for the continuous allowable torque at 40°C with an aluminium heatsink of the following dimensions attached: SGMJV-A5/01: 200 mm x 200 mm x 6 mm, SGMJV-02/04/08: 250 mm x 250 mm x 6 mm

Torque-speed characteristics

( A : Continuous duty zone B : Intermittent duty zone )

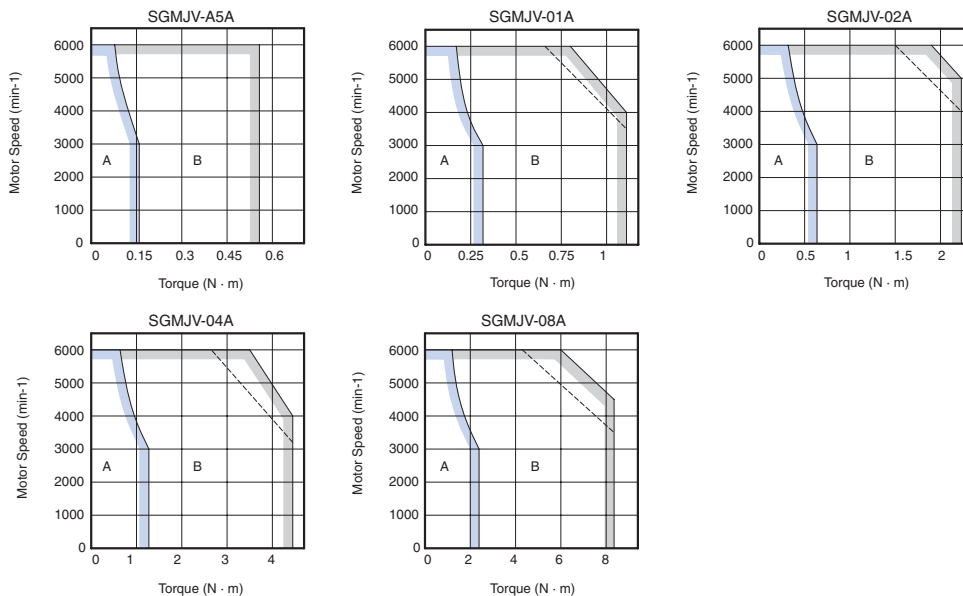

Type SGMAV, 230 V

Ratings and specifications

| Applied voltage                         |   | 230 V   |        |        |       |       |       |       |       |      |
|---|---|---|--------|--------|-------|-------|-------|-------|-------|------|
| Servo motor model SGMAV-□               |   | A5A□  | 01A□   | C2A□   | 02A□  | 04A□  | 06A□  | 08A□  | 10A□  |      |
| Rated output <sup>1</sup>               | W   | 50  | 100    | 150    | 200   | 400   | 550   | 750   | 1000  |      |
| Rated torque <sup>1,2</sup>             | N·m   | 0.159   | 0.318  | 0.477  | 0.637 | 1.27  | 1.75  | 2.39  | 3.18  |      |
| Instantaneous peak torque <sup>1</sup>  | N·m   | 0.477   | 0.955  | 1.43   | 1.91  | 3.82  | 5.25  | 7.16  | 9.55  |      |
| Rated current <sup>1</sup>              | A (rms)   | 0.66  | 0.91   | 1.3    | 1.5   | 2.6   | 3.8   | 5.3   | 7.4   |      |
| Instantaneous max. current <sup>1</sup> | A (rms)   | 2.1   | 2.8    | 4.2    | 5.3   | 8.5   | 12.2  | 16.6  | 23.9  |      |
| Rated speed <sup>1</sup>                | min <sup>-1</sup>                                   | 3000  |        |        |       |       |       |       |       |      |
| Max. speed <sup>1</sup>                 | min <sup>-1</sup>                                   | 6000  |        |        |       |       |       |       |       |      |
| Torque constant                         | N·m/A (rms)   | 0.265   | 0.375  | 0.381  | 0.450 | 0.539 | 0.496 | 0.487 | 0.467 |      |
| Rotor moment of inertia (JM)            | kg·m <sup>2</sup> ×10 <sup>-4</sup> (without brake) | 0.0242  | 0.0380 | 0.0531 | 0.116 | 0.190 | 0.326 | 0.769 | 1.2   |      |
|   | kg·m <sup>2</sup> ×10 <sup>-4</sup> (with brake)    | 0.0312  | 0.0450 | 0.0601 | 0.180 | 0.254 | 0.390 | 0.940 | 1.41  |      |
| Allowable load moment of inertia (JL)   | Multiple of (JM)                                    | 30  |        |        |       | 20    |       |       | 10    |      |
| Rated power rate <sup>1</sup>           | kW/s  | 10.4  | 26.6   | 42.8   | 35.0  | 84.9  | 93.9  | 74.1  | 84.3  |      |
| Rated angular acceleration <sup>1</sup> | rad/s <sup>2</sup>                                  | 65800   | 83800  | 89900  | 54900 | 67000 | 53700 | 31000 | 26500 |      |
| Encoder                                 | Standard  | Incremental encoder (20 bits)                                 |        |        |       |       |       |       |       |      |
|   | Option  | Absolute encoder (20 bits)                                    |        |        |       |       |       |       |       |      |
| Allowable radial load                   | N   | 68  | 78     |        | 245   |       |       | 392   |       |      |
| Allowable thrust load                   | N   | 54  |        |        | 74    |       |       | 147   |       |      |
| Approx. mass                            | Kg (without brake)                                  | 0.3   | 0.4    | 0.5    | 0.9   | 1.2   | 1.7   | 2.3   | 3.6   |      |
|   | Kg (with brake)                                     | 0.6   | 0.7    | 0.8    | 1.5   | 1.8   | 2.4   | 3.2   | 4.6   |      |
| Brake specifications                    | Rated voltage                                       | 24 VDC  |        |        |       |       |       |       |       |      |
|   | Power consumption (at 20°C)                         | W   | 6      |        |       | 6.9   |       | 8.7   | 7.7   | 7    |
|   | Current consumption (at 20°C)                       | A   | 0.25   |        |       | 0.29  |       | 0.36  | 0.32  | 0.29 |
|   | Holding torque                                      | N·m   | 0.159  | 0.318  | 0.477 | 0.637 | 1.27  | 1.75  | 2.39  | 3.18 |
|   | Rise time for holding torque                        | ms (max)  | 100    |        |       |       |       |       |       |      |
|   | Release time  | ms (max)  | 60     |        |       |       |       |       | 80    |      |
| Basic specifications                    | Time rating   | Continuous  |        |        |       |       |       |       |       |      |
|   | Thermal class                                       | Class B   |        |        |       |       |       |       |       |      |
|   | Usage/ storage temperature                          | 0 to +40 °C/ -20 to 60 °C without freezing                    |        |        |       |       |       |       |       |      |
|   | Usage/ storage humidity                             | 20 to 80% RH (non-condensing)                                 |        |        |       |       |       |       |       |      |
|   | Vibration class                                     | 15 µm or below  |        |        |       |       |       |       |       |      |
|   | Insulation resistance                               | 500 VDC, 10 MOhm min.   |        |        |       |       |       |       |       |      |
|   | Withstand voltage                                   | 1500 VAC for one minute                                       |        |        |       |       |       |       |       |      |
|   | Enclosure   | Totally-enclosed, self-cooled, IP65 (excluding shaft opening) |        |        |       |       |       |       |       |      |
|   | Vibration resistance                                | Vibration acceleration 49 m/s <sup>2</sup>                    |        |        |       |       |       |       |       |      |
|   | Altitude  | 1000 m or less above sea level                                |        |        |       |       |       |       |       |      |
| Mounting                                | Flange-mounted                                      |   |        |        |       |       |       |       |       |      |

**Note: 1.** These items and torque/speed characteristics quoted in combination with an SGD servo drive are at an armature winding temperature of 100°C. Other values quoted are at 20°C.

**2.** The rated torques listed here are the values for the continuous allowable torque at 40°C with an aluminium heatsink of the following dimensions attached (SGMJV-A5/01:200 mm x 200 mm x 6 mm, SGMJV-02/04/08:250 mm x 250 mm x 6 mm).

Torque-speed characteristics

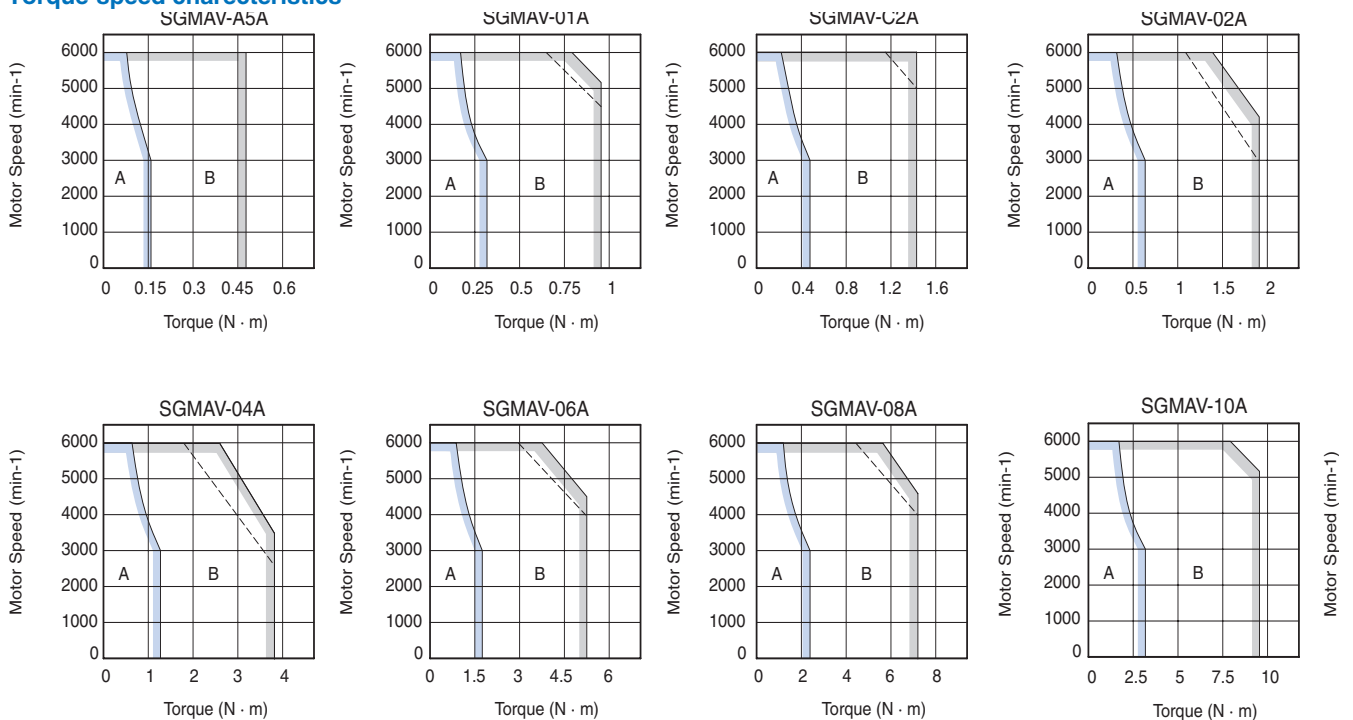

Type SGMEV, 230 V/400 V

Ratings and specifications

| Applied voltage                         |   | 230 V  |       |       |       |       | 400 V |       |       |       |       |       |
|---|---|--|-------|-------|-------|-------|-------|-------|-------|-------|-------|-------|
| Servo motor model SGMEV-□               |   | 01A□   | 02A□  | 04A□  | 08A□  | 15A□  | 02D□  | 03D□  | 04D□  | 07D□  | 08D□  | 15D□  |
| Rated output <sup>1</sup>               | W   | 100  | 200   | 400   | 750   | 1500  | 200   | 300   | 400   | 650   | 750   | 1500  |
| Rated torque <sup>1,2</sup>             | N·m   | 0.318  | 0.637 | 1.27  | 2.39  | 4.77  | 0.637 | 0.955 | 1.27  | 2.07  | 2.39  | 4.77  |
| Instantaneous peak torque <sup>1</sup>  | N·m   | 0.955  | 1.91  | 3.82  | 7.16  | 14.3  | 0.191 | 3.82  | 3.82  | 7.16  | 7.16  | 14.3  |
| Rated current <sup>1</sup>              | A (rms)   | 0.89   | 2.0   | 2.6   | 4.1   | 7.5   | 1.4   | 1.3   | 1.4   | 2.2   | 2.6   | 4.5   |
| Instantaneous max. current <sup>1</sup> | A (rms)   | 2.8  | 6.5   | 8.5   | 13.9  | 23.0  | 4.5   | 5.1   | 4.4   | 8.4   | 7.8   | 13.7  |
| Rated speed <sup>1</sup>                | min <sup>-1</sup>                                   | 3000   |       |       |       |       |       |       |       |       |       |       |
| Max. speed <sup>1</sup>                 | min <sup>-1</sup>                                   | 5000   |       |       |       |       |       |       |       |       |       |       |
| Torque constant                         | N·m/A (rms)   | 0.392  | 0.349 | 0.535 | 0.641 | 0.687 | 0.481 | 0.837 | 0.963 | 1.02  | 0.994 | 1.135 |
| Rotor moment of inertia (JM)            | kg·m <sup>2</sup> ×10 <sup>-4</sup> (without brake) | 0.049  | 0.193 | 0.331 | 2.1   | 4.02  | 0.193 | 0.173 | 0.331 | 0.672 | 2.1   | 4.02  |
|   | kg·m <sup>2</sup> ×10 <sup>-4</sup> (with brake)    | 0.078  | 0.302 | 0.440 | 2.975 | 4.895 | 0.302 | 0.231 | 0.440 | 0.812 | 2.975 | 4.895 |
| Allowable load moment of inertia (JL)   | Multiple of (JM)                                    | 25   | 15    | 7     | 5     | 5     | 15    | 20    | 7     | 20    | 5     | 5     |
| Rated power rate <sup>1</sup>           | kW/s  | 20.6   | 21.0  | 49.0  | 27.1  | 56.7  | 21    | 52.9  | 49.0  | 63.8  | 27.1  | 56.7  |
| Rated angular acceleration <sup>1</sup> | rad/s <sup>2</sup>                                  | 64800  | 33000 | 38500 | 11400 | 11900 | 33000 | 55300 | 38500 | 30800 | 11400 | 11900 |
| Encoder                                 | Standard  | Incremental encoder (20 bits)                    |       |       |       |       |       |       |       |       |       |       |
|   | Option  | Absolute encoder (20 bits)                       |       |       |       |       |       |       |       |       |       |       |
| Allowable radial load                   | N   | 78   | 245   | 392   | 490   | 245   | 245   | 345   | 245   | 392   | 490   | 490   |
| Allowable thrust load                   | N   | 49   | 68    | 147   | 147   | 68    | 68    | 74    | 68    | 147   | 147   | 147   |
| Approx. mass                            | Kg (without brake)                                  | 0.7  | 1.4   | 2.1   | 4.2   | 6.6   | 1.4   | 1.7   | 2.1   | 3.4   | 4.2   | 6.6   |
|   | Kg (with brake)                                     | 0.9  | 1.9   | 2.6   | 5.7   | 8.1   | 1.9   | 2.2   | 2.6   | 4.3   | 5.7   | 8.1   |
| Holding brake moment of inertia J       | kg·m <sup>2</sup> ×10 <sup>-4</sup>                 | 0.029  | 0.109 | 0.875 | 0.875 | 0.109 | 0.109 | 0.058 | 0.109 | 0.140 | 0.875 | 0.875 |
| Basic specifications                    | Time rating   | Continuous                                       |       |       |       |       |       |       |       |       |       |       |
|   | Thermal class                                       | Class B  |       |       |       |       |       |       |       |       |       |       |
|   | Usage/ storage temperature                          | 0 to +40 °C/ -20 to 60 °C without freezing       |       |       |       |       |       |       |       |       |       |       |
|   | Usage/ storage humidity                             | 20 to 80% RH (non-condensing)                    |       |       |       |       |       |       |       |       |       |       |
|   | Vibration class                                     | 15 μm or below                                   |       |       |       |       |       |       |       |       |       |       |
|   | Insulation resistance                               | 500 VDC, 10 MOhm min.                            |       |       |       |       |       |       |       |       |       |       |
|   | Withstand voltage                                   | 1500 VAC for one minute                          |       |       |       |       |       |       |       |       |       |       |
|   | Enclosure   | Totally-enclosed, self-cooled, IP55 <sup>3</sup> |       |       |       |       |       |       |       |       |       |       |
|   | Vibration resistance                                | Vibration acceleration xx m/s <sup>2</sup>       |       |       |       |       |       |       |       |       |       |       |
|   | Altitude  | 1000 m or less above sea level                   |       |       |       |       |       |       |       |       |       |       |
| Mounting                                | Flange-mounted                                      |  |       |       |       |       |       |       |       |       |       |       |

- Note:**
1. These items and torque/speed characteristics quoted in combination with an SGD servo drive are at an armature winding temperature of 100°C. Other values quoted are at 20°C.
  2. The rated torques listed here are the values for the continuous allowable torque at 40°C with an aluminium heatsink of the following dimensions attached (SGMEV-01A/02A/04A/02D/03D/04D/07D: 250 mm x 250 mm x 6 mm, SGMEV-08A/15A/08D/15D: 300 mm x 300 mm x 12 mm)
  3. IP55 in case of standard cable attaching. IP67 is possible unless SGMEV-03D/07D servomotors.

Torque-speed characteristics

( A : Continuous Duty Zone B : Intermittent Duty Zone )

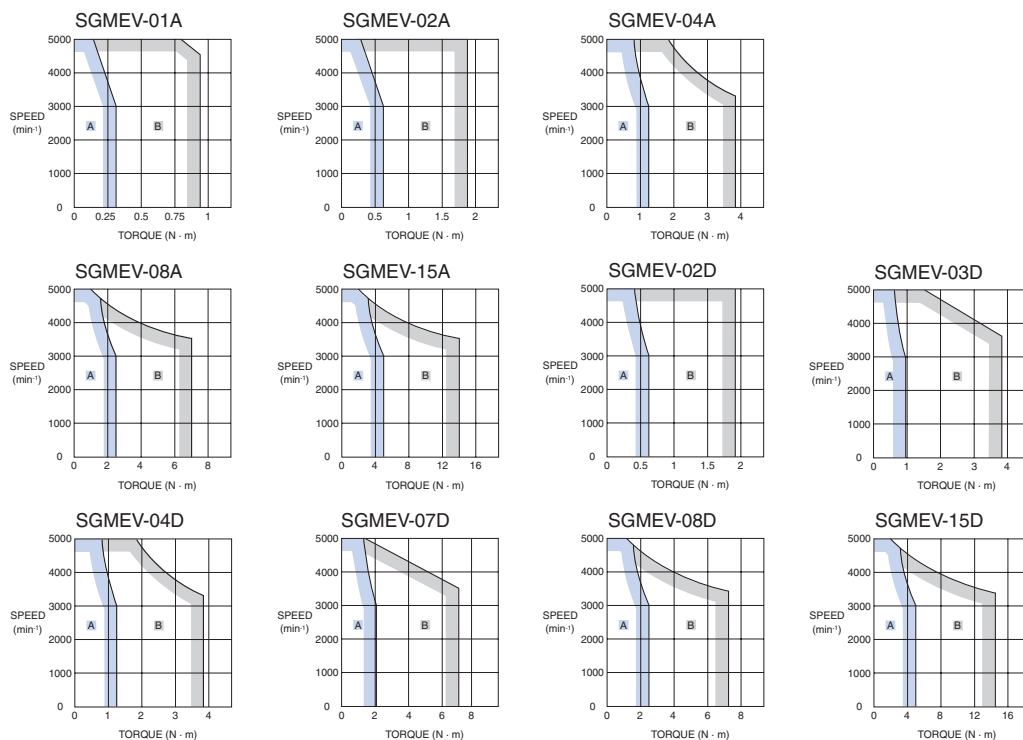

Type SGMGV, 400 V

Ratings and specifications

| Applied voltage                         |   | 400 V   |      |      |      |      |                          |      |      |      |      |      |  |       |
|---|---|---|------|------|------|------|--------------------------|------|------|------|------|------|--|-------|
| Servo motor model SGMGV-□               |   | 03D□  | 05D□ | 09D□ | 13D□ | 20D□ | 30D□                     | 44D□ | 55D□ | 75D□ | 1AD□ | 1ED□ |  |       |
| Rated output <sup>1</sup>               | kW  | 0.3   | 0.45 | 0.85 | 1.3  | 1.8  | 2.9                      | 4.4  | 5.5  | 7.5  | 11   | 15   |  |       |
| Rated torque <sup>1</sup>               | N·m   | 1.96  | 2.86 | 5.39 | 8.34 | 11.5 | 18.6                     | 28.4 | 35.0 | 48.0 | 70.0 | 95.4 |  |       |
| Instantaneous peak torque <sup>1</sup>  | N·m   | 5.88  | 8.92 | 13.8 | 23.3 | 28.7 | 45.1                     | 71.1 | 87.6 | 119  | 175  | 224  |  |       |
| Rated current <sup>1</sup>              | A (rms)   | 1.4   | 1.9  | 3.5  | 5.4  | 8.4  | 11.9                     | 16.5 | 20.8 | 25.7 | 28.1 | 37.2 |  |       |
| Instantaneous max. current <sup>1</sup> | A (rms)   | 4   | 5.5  | 8.5  | 14   | 20   | 28                       | 40.5 | 52   | 65   | 70   | 85   |  |       |
| Rated speed <sup>1</sup>                | min <sup>-1</sup>                                   | 1500  |      |      |      |      |                          |      |      |      |      |      |  |       |
| Max. speed <sup>1</sup>                 | min <sup>-1</sup>                                   | 3000  |      |      |      |      |                          |      |      |      |      | 2000 |  |       |
| Torque constant                         | N·m/A (rms)   | 1.55  | 1.71 | 1.72 | 1.78 | 1.50 | 1.70                     | 1.93 | 1.80 | 1.92 | 2.64 | 2.74 |  |       |
| Rotor moment of inertia (JM)            | kg·m <sup>2</sup> ×10 <sup>-4</sup> (without brake) | 2.48  | 3.33 | 13.9 | 19.9 | 26   | 46                       | 67.5 | 89.0 | 125  | 242  | 303  |  |       |
|   | kg·m <sup>2</sup> ×10 <sup>-4</sup> (with brake)    | 2.69  | 3.54 | 16   | 22   | 28.1 | 54.5                     | 76   | 97.5 | 134  | 261  | 322  |  |       |
| Allowable load moment of inertia (JL)   | Multiple of (JM)                                    | 5   |      |      |      |      |                          |      |      |      |      |      |  |       |
| Rated power rate <sup>1</sup>           | kW/s (without brake)                                | 15.5  | 24.6 | 20.9 | 35.0 | 50.9 | 75.2                     | 119  | 138  | 184  | 202  | 300  |  |       |
|   | kW/s (with brake)                                   | 14.3  | 23.1 | 18.2 | 31.6 | 47.1 | 63.5                     | 106  | 126  | 172  | 188  | 283  |  |       |
| Rated angular acceleration <sup>1</sup> | rad/s <sup>2</sup> (without brake)                  | 7900  | 8590 | 3880 | 4190 | 4420 | 4040                     | 4210 | 3930 | 3840 | 2890 | 3150 |  |       |
|   | rad/s <sup>2</sup> (with brake)                     | 7290  | 8080 | 3370 | 3790 | 4090 | 3410                     | 3740 | 3590 | 3580 | 2680 | 2960 |  |       |
| Encoder                                 | Standard  | Incremental encoder (20 bits)                                 |      |      |      |      |                          |      |      |      |      |      |  |       |
|   | Option  | Absolute encoder (20 bits)                                    |      |      |      |      |                          |      |      |      |      |      |  |       |
| Allowable radial load                   | N   | 490   |      |      | 686  | 980  | 1470                     |      | 1764 |      | 4998 |      |  |       |
| Allowable thrust load                   | N   | 98  |      |      | 343  | 392  | 490                      |      | 588  |      | 2156 |      |  |       |
| Approx. mass                            | Kg (without brake)                                  | 2.6   | 3.2  | 5.5  | 7.1  | 8.6  | 13.4                     | 17.5 | 21.5 | 29.5 | 57   | 67   |  |       |
|   | Kg (with brake)                                     | 4.5   | 5.0  | 7.5  | 9.0  | 11.0 | 19.5                     | 23.5 | 27.5 | 35   | 65   | 85   |  |       |
| Brake specifications                    | Rated voltage                                       | 24 /90 VDC  |      |      |      |      |                          |      |      |      |      |      |  |       |
|   | Power consumption (at 20°C)                         | W (24 VDC)  | 10   |      |      | 9.8  |                          | 18.5 |      | 25   |      | 32   |  | 35    |
|   |   | W (90 VDC)  | 10   |      |      | 10.1 |                          | 18.5 |      | 25   |      | 32   |  | 35    |
|   | Current consumption (at 20°C)                       | A (24 VDC)  | 0.42 |      |      | 0.41 |                          | 0.77 |      | 1.05 |      | 1.33 |  | 1.46  |
|   |   | A (90 VDC)  | 0.11 |      |      | 0.11 |                          | 0.21 |      | 0.28 |      | 0.36 |  | 0.39  |
|   | Holding torque                                      | N·m   | 4.5  |      | 12.7 | 19.6 |                          | 43.1 |      | 72.6 |      | 84.3 |  | 114.6 |
| Rise time for holding torque            | ms (max)  | 80  |      |      |      |      | 100 (24 V),<br>80 (90 V) |      | 80   |      |      |      |  |       |
| Release time                            | ms (max)  | 100   |      |      |      |      | 170                      |      |      |      |      |      |  |       |
| Basic specifications                    | Time rating   | Continuous  |      |      |      |      |                          |      |      |      |      |      |  |       |
|   | Thermal class                                       | Class F   |      |      |      |      |                          |      |      |      |      |      |  |       |
|   | Usage/ storage temperature                          | 0 to +40 °C/ -20 to 60 °C without freezing                    |      |      |      |      |                          |      |      |      |      |      |  |       |
|   | Usage/ storage humidity                             | 20 to 80% RH (non-condensing)                                 |      |      |      |      |                          |      |      |      |      |      |  |       |
|   | Insulation resistance                               | 500 VDC, 10 MOhm min.   |      |      |      |      |                          |      |      |      |      |      |  |       |
|   | Withstand voltage                                   | 1800 VAC for one minute                                       |      |      |      |      |                          |      |      |      |      |      |  |       |
|   | Vibration class                                     | 15 µm or below  |      |      |      |      |                          |      |      |      |      |      |  |       |
|   | Enclosure   | Totally-enclosed, self-cooled, IP67 (excluding shaft opening) |      |      |      |      |                          |      |      |      |      |      |  |       |
|   | Vibration resistance                                | Vibration acceleration 24.5 m/s <sup>2</sup>                  |      |      |      |      |                          |      |      |      |      |      |  |       |
| Altitude                                | 1000 m or less above sea level                      |   |      |      |      |      |                          |      |      |      |      |      |  |       |
| Mounting                                | Flange-mounted                                      |   |      |      |      |      |                          |      |      |      |      |      |  |       |

**Note: 1.** These items and torque/speed characteristics quoted in combination with an SGD servo drive are at an armature winding temperature of 20°C.

Torque-speed characteristics

( A : Continuous duty zone B : Intermittent duty zone )

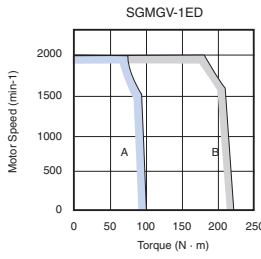
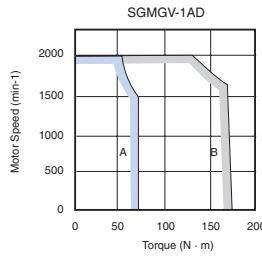
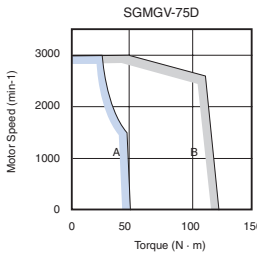
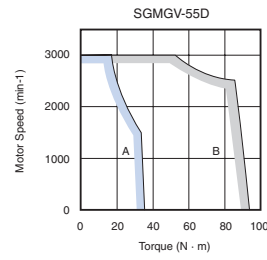
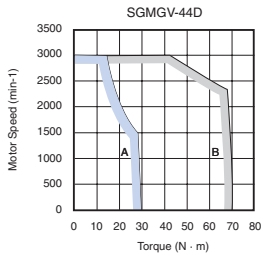
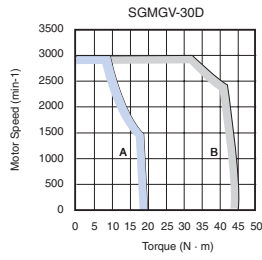
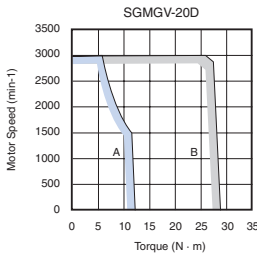
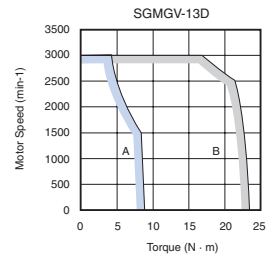
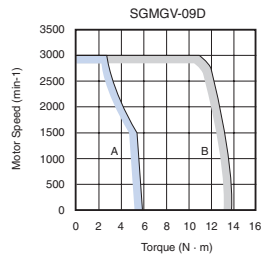
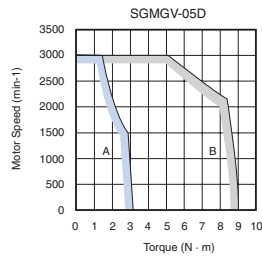
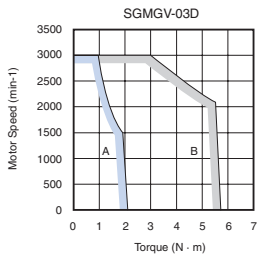



Type SGMSV, 400 V

Ratings and specifications

| Applied voltage                         |   | 400 V   |       |       |       |       |       |       |  |
|---|---|---|-------|-------|-------|-------|-------|-------|--|
| Servo motor model SGMSV- □              |   | 10D□  | 15D□  | 20D□  | 25D□  | 30D□  | 40D□  | 50D□  |  |
| Rated output <sup>1</sup>               | kW  | 1.0   | 1.5   | 2.0   | 2.5   | 3.0   | 4.0   | 5.0   |  |
| Rated torque <sup>1,2</sup>             | N·m   | 3.18  | 4.9   | 6.36  | 7.96  | 9.8   | 12.6  | 15.8  |  |
| Instantaneous peak torque <sup>1</sup>  | N·m   | 9.54  | 14.7  | 19.1  | 23.9  | 29.4  | 37.8  | 47.6  |  |
| Rated current <sup>1</sup>              | A (rms)   | 2.8   | 4.7   | 6.1   | 7.4   | 8.9   | 12.5  | 13.8  |  |
| Instantaneous max. current <sup>1</sup> | A (rms)   | 8.5   | 14    | 19.5  | 22.3  | 28    | 38    | 42    |  |
| Rated speed <sup>1</sup>                | min <sup>-1</sup>                                   | 3000  |       |       |       |       |       |       |  |
| Max. speed <sup>1</sup>                 | min <sup>-1</sup>                                   | 6000  | 5000  |       |       |       |       |       |  |
| Torque constant                         | N·m/A (rms)   | 1.27  | 1.15  | 1.12  | 1.15  | 1.16  | 1.06  | 1.21  |  |
| Rotor moment of inertia (JM)            | kg·m <sup>2</sup> ×10 <sup>-4</sup> (without brake) | 1.74  | 2.0   | 2.47  | 3.19  | 7.0   | 9.60  | 12.3  |  |
|   | kg·m <sup>2</sup> ×10 <sup>-4</sup> (with brake)    | 1.99  | 2.25  | 2.72  | 3.44  | 9.2   | 11.8  | 14.5  |  |
| Allowable load moment of inertia (JL)   | Multiple of (JM)                                    | 5   |       |       |       |       |       |       |  |
| Rated power rate <sup>1</sup>           | kW/s  | 57.9  | 97.2  | 127   | 199   | 137   | 165   | 203   |  |
| Rated angular acceleration <sup>1</sup> | rad/s <sup>2</sup>                                  | 18300   | 24500 | 25700 | 25000 | 14000 | 13100 | 12800 |  |
| Encoder                                 | Standard  | Incremental encoder (20 bits)                                 |       |       |       |       |       |       |  |
|   | Option  | Absolute encoder (20 bits)                                    |       |       |       |       |       |       |  |
| Allowable radial load                   | N   | 686   |       |       |       | 980   | 1176  |       |  |
| Allowable thrust load                   | N   | 196   |       |       |       | 392   |       |       |  |
| Approx. mass                            | Kg (without brake)                                  | 4.6   | 5.1   | 5.8   | 7.0   | 11    | 14    | 17    |  |
|   | Kg (with brake)                                     | 5.5   | 6     | 6.8   | 8.7   | 13    | 16    | 19    |  |
| Basic specifications                    | Time rating   | Continuous  |       |       |       |       |       |       |  |
|   | Thermal class                                       | Class F   |       |       |       |       |       |       |  |
|   | Usage/ storage temperature                          | 0 to +40 °C/ -20 to 60°C without freezing                     |       |       |       |       |       |       |  |
|   | Usage/ storage humidity                             | 20 to 80% RH (non-condensing)                                 |       |       |       |       |       |       |  |
|   | Vibration class                                     | 15 µm or below  |       |       |       |       |       |       |  |
|   | Insulation resistance                               | 500 VDC, 10 MOhm min.   |       |       |       |       |       |       |  |
|   | Withstand voltage                                   | 1500 VAC for one minute                                       |       |       |       |       |       |       |  |
|   | Enclosure   | Totally-enclosed, self-cooled, IP67 (excluding shaft opening) |       |       |       |       |       |       |  |
|   | Vibration resistance                                | Vibration acceleration xx.x m/s <sup>2</sup>                  |       |       |       |       |       |       |  |
|   | Altitude  | 1000 m or less above sea level                                |       |       |       |       |       |       |  |
| Mounting                                | Flange-mounted                                      |   |       |       |       |       |       |       |  |

**Note: 1.** These items and torque/speed characteristics quoted in combination with an SGD servo drive are at an armature winding temperature of 20°C.

**2.** The rated torques listed here are the values for the continuous allowable torque value with an aluminium heatsink of the following dimensions attached (SGMSV-10/15/20/25: 300 mm x 300 mm x 12 mm, SGMSV-30/40/50: 400 mm x 400 mm x 20 mm ).

Torque-speed characteristics

**A** : Continuous Duty Zone    **B** : Intermittent Duty Zone

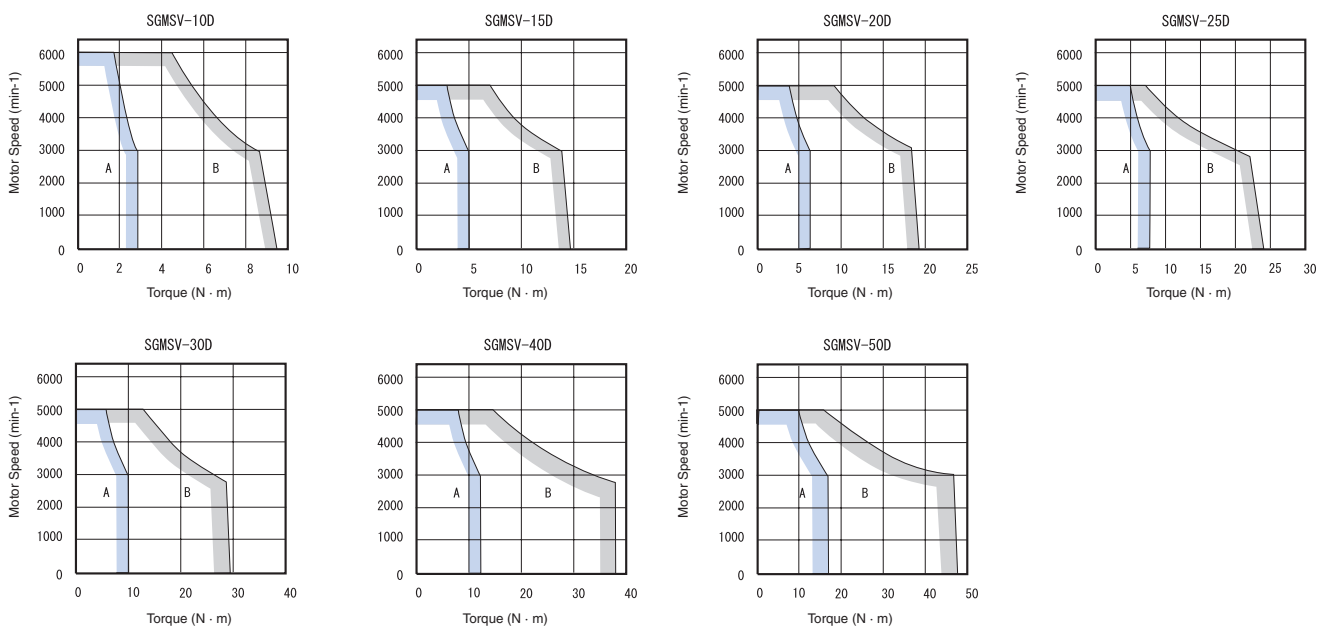

Dimensions

Servomotors

Type SGMJV (230 V, 50 - 100 W)

| Dimensions (mm)<br>Model | Without brake |      | With brake |       | LM   | Shaft End Dimensions |    |     |   |   | Approx. Mass (Kg) |            |
|--------------------------|---------------|------|------------|-------|------|----------------------|----|-----|---|---|-------------------|------------|
|                          | L             | LL   | L          | LL    |      | Tap × Depth          | QK | U   | W | T | Without brake     | With brake |
| SGMJV-A5A□A6□-OY         | 94            | 69   | 139        | 114   | 37   | M3 x 6L              | 14 | 1.8 | 3 | 3 | 0.3               | 0.6        |
| SGMJV-01A□A6□-OY         | 107.5         | 82.5 | 152.5      | 127.5 | 50.5 |                      |    |     |   |   | 0.4               | 0.7        |

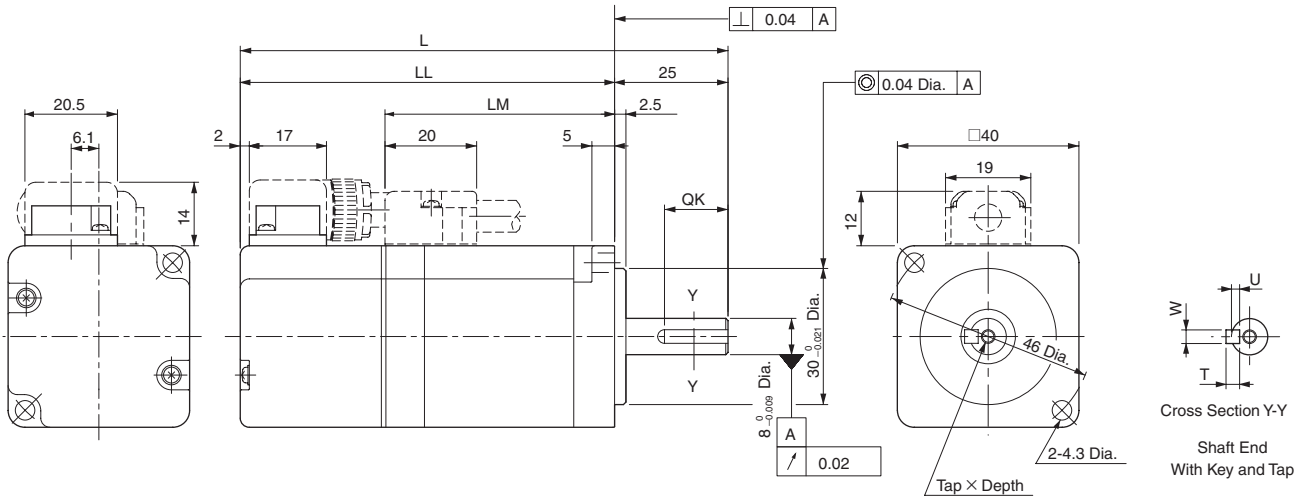

Type SGMJV (230 V, 200 - 750 W)

| Dimensions (mm)<br>Model | Without brake |      | With brake |       | LM   | Flange Face Dimensions |    |    |    |    |                 |     | Shaft End Dimensions |             |    |     |   | MD | MW   | MH | Approx. Mass Kg |               |            |
|--------------------------|---------------|------|------------|-------|------|------------------------|----|----|----|----|-----------------|-----|----------------------|-------------|----|-----|---|----|------|----|-----------------|---------------|------------|
|                          | L             | LL   | L          | LL    |      | LR                     | LE | LG | LC | LA | LB              | LZ  | S                    | Tap × Depth | QK | U   | W |    |      |    | T               | Without brake | With brake |
| SGMJV-02A□A6□-OY         | 110           | 80   | 150        | 120   | 51   | 30                     | 3  | 6  | 60 | 70 | 50 <sup>0</sup> | 5.5 | 14 <sup>0</sup>      | M5x8L       | 14 | 3   | 5 | 5  | 8.3  | 21 | 13              | 0.9           | 1.5        |
| SGMJV-04A□A6□-OY         | 128.5         | 98.5 | 168.5      | 138.5 | 69.5 |                        |    |    |    |    | -0.025          |     | -0.011               |             |    |     |   |    |      |    |                 | 1.3           | 1.9        |
| SGMJV-08A□A6□-OY         | 155           | 115  | 200        | 160   | 85   | 40                     |    | 8  | 80 | 90 | 70 <sup>0</sup> | 7   | 19 <sup>0</sup>      | M6x10L      | 22 | 3.5 | 6 | 6  | 13.8 | 27 | 15              | 2.3           | 3.2        |

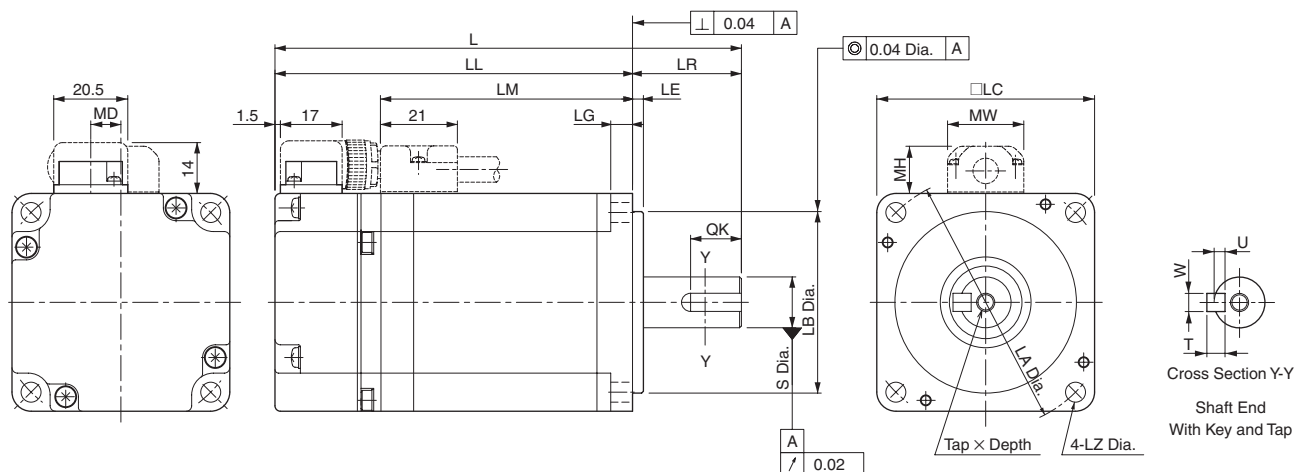

Type SGMAV (230 V, 50 - 150 W)

| Dimensions (mm)  | Without brake |      | With brake |       | LM   | Shaft End Dimensions |    |     |   |   | Approx. Mass (Kg) |            |
|------------------|---------------|------|------------|-------|------|----------------------|----|-----|---|---|-------------------|------------|
|                  | L             | LL   | L          | LL    |      | Tap x Depth          | QK | U   | W | T | Without brake     | With brake |
| SGMAV-A5A□A6□-OY | 95.5          | 70.5 | 140.5      | 115.5 | 38.5 | M3x6L                | 14 | 1.8 | 3 | 3 | 0.3               | 0.6        |
| SGMAV-01A□A6□-OY | 107.5         | 82.5 | 152.5      | 127.5 | 50.5 |                      |    |     |   |   | 0.4               | 0.7        |
| SGMAV-C2A□A6□-OY | 119.5         | 94.5 | 164.5      | 139.5 | 62.5 |                      |    |     |   |   | 0.5               | 0.8        |

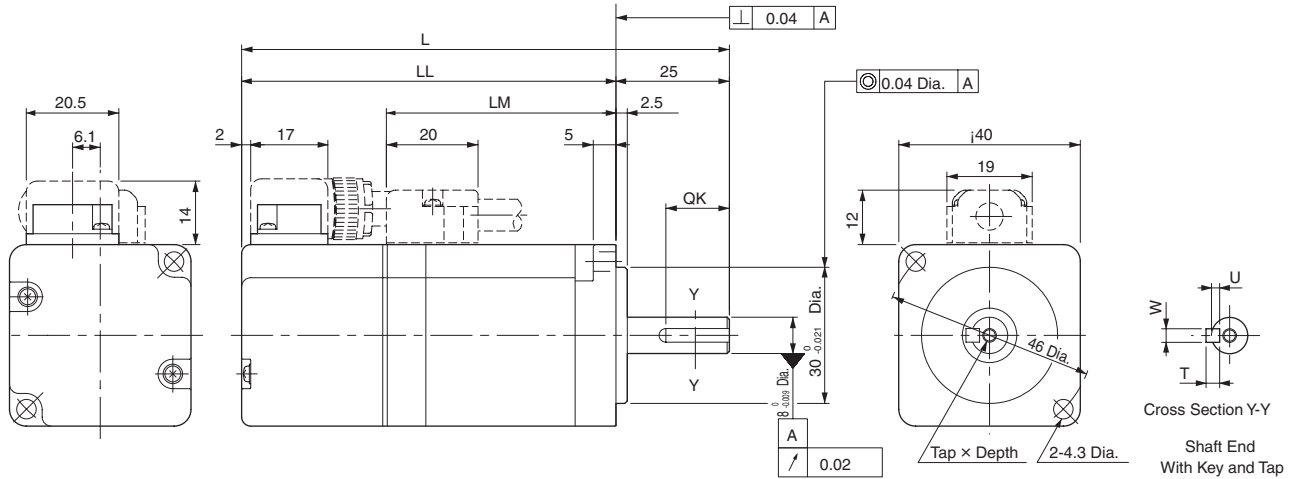

Type SGMAV (230 V, 200 - 750 W)

| Dimensions (mm)  | Without brake |       | With brake |       | LM   | Flange Face Dimensions |    |    |    |    |                 |     | Shaft End Dimensions |             |    |     |   | MD | MW   | MH | Approx. Mass (Kg) |               |            |
|------------------|---------------|-------|------------|-------|------|------------------------|----|----|----|----|-----------------|-----|----------------------|-------------|----|-----|---|----|------|----|-------------------|---------------|------------|
|                  | L             | LL    | L          | LL    |      | LR                     | LE | LG | LC | LA | LB              | LZ  | S                    | Tap x Depth | QK | U   | W |    |      |    | T                 | Without brake | With brake |
| SGMAV-02A□A6□-OY | 110           | 80    | 150        | 120   | 51   | 30                     | 3  | 6  | 60 | 70 | 50 <sup>0</sup> | 5.5 | 14 <sup>0</sup>      | M5x8L       | 20 | 3   | 5 | 5  | 8.5  | 21 | 13                | 0.9           | 1.5        |
| SGMAV-04A□A6□-OY | 128.5         | 98.5  | 168.5      | 138.5 | 69.5 |                        |    |    |    |    | -0.025          |     | -0.011               |             | 14 |     |   |    |      |    |                   | 1.2           | 1.9        |
| SGMAV-06A□A6□-OY | 154.5         | 124.5 | 200.5      | 170.5 | 95.5 |                        |    |    |    |    |                 |     |                      |             |    |     |   |    |      |    |                   | 1.7           | 2.4        |
| SGMAV-08A□A6□-OY | 155           | 115   | 200        | 160   | 85   | 40                     |    | 8  | 80 | 90 | 70 <sup>0</sup> | 7   | 19 <sup>0</sup>      | M6x10L      | 22 | 3.5 | 6 | 6  | 13.8 | 27 | 15                | 2.3           | 3.2        |
| SGMAV-10A□A6□-OY | 185           | 145   | 235        | 195   | 115  |                        |    |    |    |    | -0.030          |     | -0.013               |             |    |     |   |    |      |    |                   | 3.6           | 4.6        |

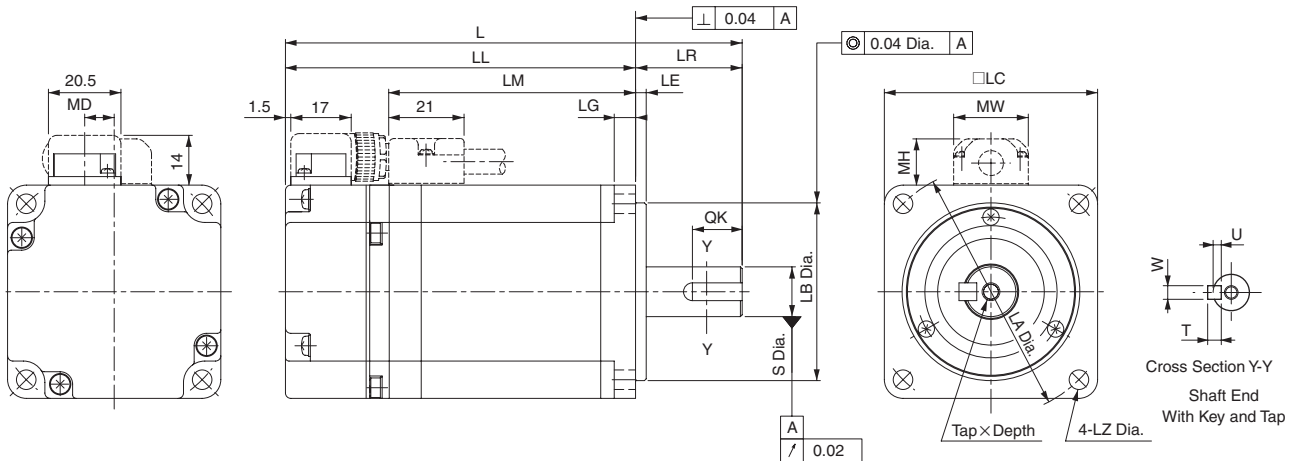

Type SGMEV (230/400 V, 100 - 1500 W)

| Dimensions (mm)  | Without brake |       | With brake |       | LM | Flange Face Dimensions |                            |     |     |    |    | Shaft End Dimensions                         |    |   |     |          | Approx. Mass (Kg) |               |            |
|------------------|---------------|-------|------------|-------|----|------------------------|----------------------------|-----|-----|----|----|--|----|---|-----|----------|-------------------|---------------|------------|
|                  | L             | LL    | L          | LL    |    | LA                     | LB                         | LC  | LE  | LG | LZ | S  | QK | W | T   | U        | Tap x Depth       | Without brake | With brake |
| SGMEV-01A□A6□-OY | 87            | 62    | 116        | 91    | 25 | 70                     | 50 <sup>0</sup><br>-0.030  | 60  | 3   | 6  |    | 8 <sup>0</sup><br>14 <sup>0</sup><br>-0.011  | 14 | 3 | 3   | 1.8      | M3 x 6L           | 0.7           | 0.9        |
| SGMEV-02A□A6□-OY | 97            | 67    | 128.5      | 98.5  | 30 | 90                     | 70 <sup>0</sup><br>-0.030  | 80  |     | 8  | 7  |  | 16 | 5 | 5   | 3        | M5 x 8L           | 1.4           | 1.9        |
| SGMEV-02D□A6□-OY |               |       |            |       |    |                        |                            |     |     |    |    |  |    |   |     |          |                   | 2.1           | 2.6        |
| SGMEV-04A□A6□-OY | 117           | 87    | 148.5      | 118.5 |    |                        |                            |     |     |    |    |  |    |   |     |          |                   |               |            |
| SGMEV-04D□A6□-OY |               |       |            |       |    |                        |                            |     |     |    |    |  |    |   |     |          |                   |               |            |
| SGMEV-08A□A6□-OY | 126.5         | 86.5  | 160        | 120   | 40 | 145                    | 110 <sup>0</sup><br>-0.035 | 120 | 3.5 | 10 | 10 | 16 <sup>0</sup><br>14 <sup>0</sup><br>-0.011 | 22 |   |     |          |                   | 4.2           | 4.7        |
| SGMEV-08D□A6□-OY |               |       |            |       |    |                        |                            |     |     |    |    |  |    |   |     |          |                   |               |            |
| SGMEV-15A□A6□-OY | 154.5         | 114.5 | 188        | 148   |    |                        |                            |     |     |    |    | 19 <sup>0</sup><br>16 <sup>0</sup><br>-0.013 | 6  | 6 | 3.5 | M6 x 10L | 6.6               | 8.1           |            |
| SGMEV-15D□A6□-OY |               |       |            |       |    |                        |                            |     |     |    |    |  |    |   |     |          |                   |               |            |

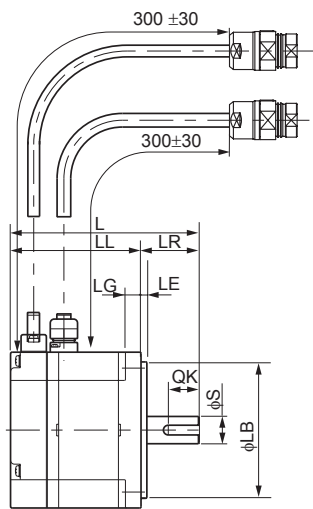

Models without Brake

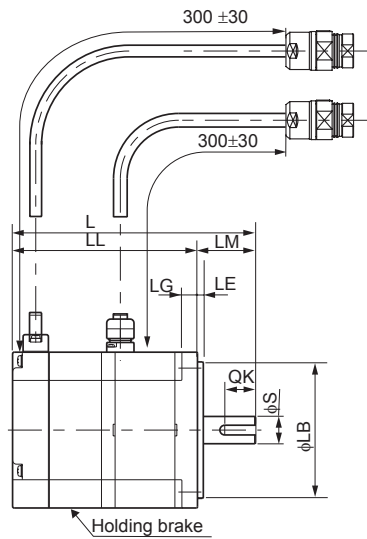

Models with Brake

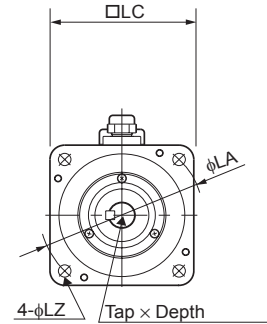
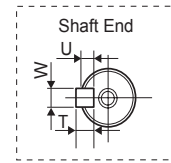

Type SGMEV (400 V, 300 - 650 W)

| Dimensions (mm)  | Without brake |       | With brake |       | LM | Flange Face Dimensions |                           |    |    |    |     | Shaft End Dimensions      |    |   |   |   | Approx. Mass (Kg) |               |            |
|------------------|---------------|-------|------------|-------|----|------------------------|---------------------------|----|----|----|-----|---------------------------|----|---|---|---|-------------------|---------------|------------|
|                  | L             | LL    | L          | LL    |    | LA                     | LB                        | LC | LE | LG | LZ  | S                         | QK | W | T | U | Tap x Depth       | Without brake | With brake |
| SGMEV-03D□A6□-OY | 154.5         | 124.5 | 194        | 164   | 30 | 70                     | 50 <sup>0</sup><br>-0.025 | 60 | 3  | 6  | 5.5 | 14 <sup>0</sup><br>-0.011 | 20 | 5 | 5 | 3 | M5 x 8L           | 1.7           | 2.2        |
| SGMEV-07D□A6□-OY | 185           | 145   | 229.5      | 189.5 | 40 | 90                     | 70 <sup>0</sup><br>-0.030 | 80 | 3  | 8  | 70  | 16 <sup>0</sup><br>-0.011 | 30 |   |   |   |                   | 3.4           | 4.3        |

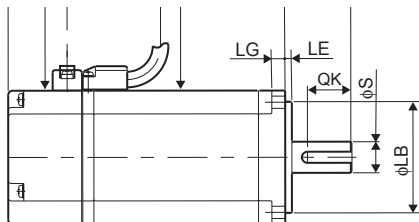

Models without Brake

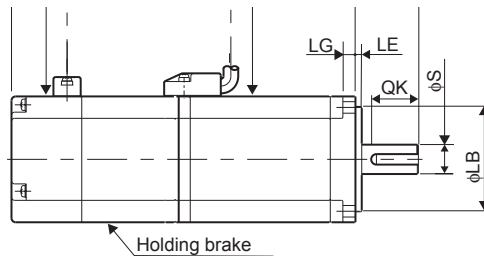

Models with Brake

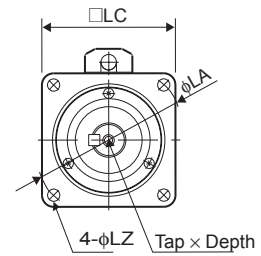

Type SGMGV (400 V, 300 - 450 W)

| Dimensions (mm)  | Without brake |     |     |     | With brake |     |     |     | LR | KB1 | Shaft End Dimensions |    |    |   |   |   | Approx. Mass (Kg) |               |            |
|------------------|---------------|-----|-----|-----|------------|-----|-----|-----|----|-----|----------------------|----|----|---|---|---|-------------------|---------------|------------|
|                  | L             | LL  | LM  | KB2 | L          | LL  | LM  | KB2 |    |     | S                    | Q  | QK | W | T | U | Tap x Depth       | Without brake | With brake |
| SGMGV-03D□A6□-OY | 163           | 126 | 90  | 114 | 196        | 159 | 123 | 147 | 37 | 75  | $14^{0}_{-0.011}$    | 25 | 15 | 5 | 5 | 3 | M4 x 10L          | 2.6           | 3.6        |
| SGMGV-05D□A6□-OY | 179           | 139 | 103 | 127 | 212        | 172 | 136 | 160 | 40 | 88  | $16^{0}_{-0.011}$    | 30 | 20 |   |   |   | M4 x 12L          | 3.2           | 4.2        |

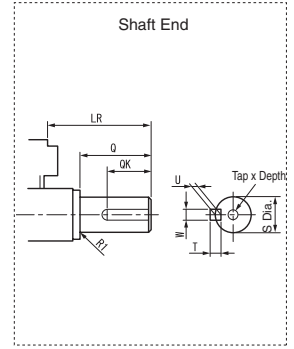
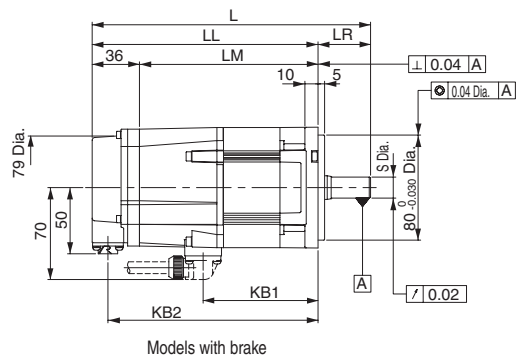
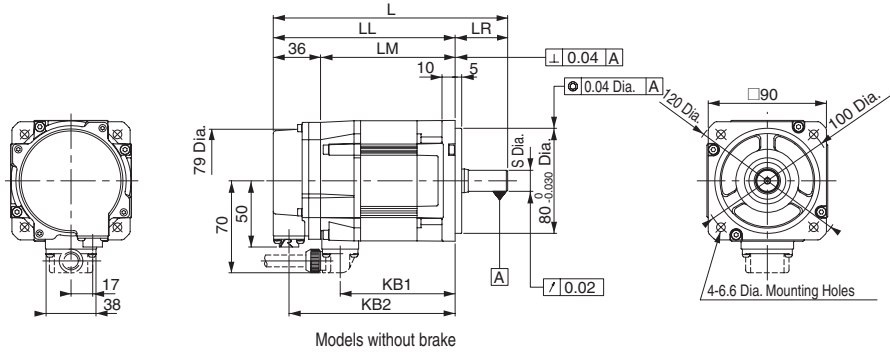

Type SGMGV (400 V, 850 W- 7.5 kW)

| Dimensions (mm)      | Without brake |     |     |      | With brake |     |     |     |      | LR  | KB1 | IE  | KL1 | Flange Face Dimensions |                            |                              |     |     |     | Shaft End Dimensions |                           |                           |     |     |     | Approx. Mass (Kg) |          |             |               |            |
|----------------------|---------------|-----|-----|------|------------|-----|-----|-----|------|-----|-----|-----|-----|------------------------|----------------------------|------------------------------|-----|-----|-----|----------------------|---------------------------|---------------------------|-----|-----|-----|-------------------|----------|-------------|---------------|------------|
|                      | L             | LL  | LM  | KB 2 | L          | LL  | LM  | KB2 | KB 3 |     |     |     |     | KL 3                   | LA                         | LB                           | LC  | LE  | LG  | LH                   | LZ                        | S                         | Q   | Q K | W   | T                 | U        | Tap x Depth | Without brake | With brake |
| SGMGV-09D□A6<br>□-OY | 195           | 137 | 101 | 125  | 231        | 173 | 137 | 161 | 115  | 80  | 58  | -   | 104 | 145                    | 110 <sup>0</sup><br>-0.035 | 130                          | 6   | 12  | 165 | 9                    | 19 <sup>0</sup><br>-0.013 | 40                        | 25  | 5   | 5   | 3                 | M5 x 12L | 5.5         | 7.5           |            |
| SGMGV-13D□A6<br>□-OY | 211           | 153 | 117 | 141  | 247        | 189 | 153 | 177 | 131  |     | 99  | -   |     |                        |                            |                              |     |     |     |                      | 22 <sup>0</sup><br>-0.013 |                           | 6   | 6   | 3.5 |                   | 7.1      | 9.0         |               |            |
| SGMGV-20D□A6<br>□-OY | 229           | 171 | 135 | 159  | 265        | 207 | 171 | 195 | 149  |     | 117 | -   |     |                        |                            |                              |     |     |     |                      | 24 <sup>0</sup><br>-0.013 |                           | 8   | 7   | 4   |                   | 8.6      | 11.0        |               |            |
| SGMGV-30D□A6<br>□-OY | 239           | 160 | 124 | 148  | 287        | 208 | 172 | 196 | 148  | 110 | 79  | 108 | -   | 134                    | 200                        | 114.3 <sup>0</sup><br>-0.025 | 180 | 3.2 | 18  | 230                  | 13.5                      | 35 <sup>+0.01</sup><br>0  | 76  | 60  | 10  | 8                 | 5        | M12 x 25L   | 13.4          | 19.5       |
| SGMGV-44D□A6<br>□-OY | 263           | 184 | 148 | 172  | 311        | 232 | 196 | 220 | 172  |     | 132 | -   |     |                        |                            |                              |     |     |     |                      |                           |                           |     |     |     | 17.5              | 23.5     |             |               |            |
| SGMGV-55D□A6<br>□    | 334           | 221 | 185 | 209  | 378        | 265 | 229 | 253 | 205  |     | 113 | 163 | 123 | 144                    |                            |                              |     |     |     |                      |                           | 42 <sup>0</sup><br>-0.016 | 110 | 90  | 12  | M16 x 32L         | 21.5     | 27.5        |               |            |
| SGMGV-75D□A6<br>□    | 380           | 267 | 231 | 255  | 424        | 311 | 275 | 299 | 251  |     | 209 |     |     |                        |                            |                              |     |     |     |                      |                           |                           |     |     |     | 29.5              | 35       |             |               |            |

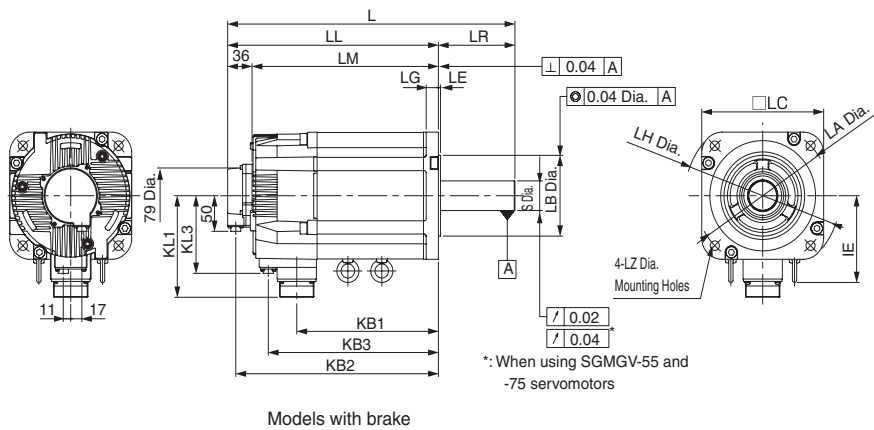
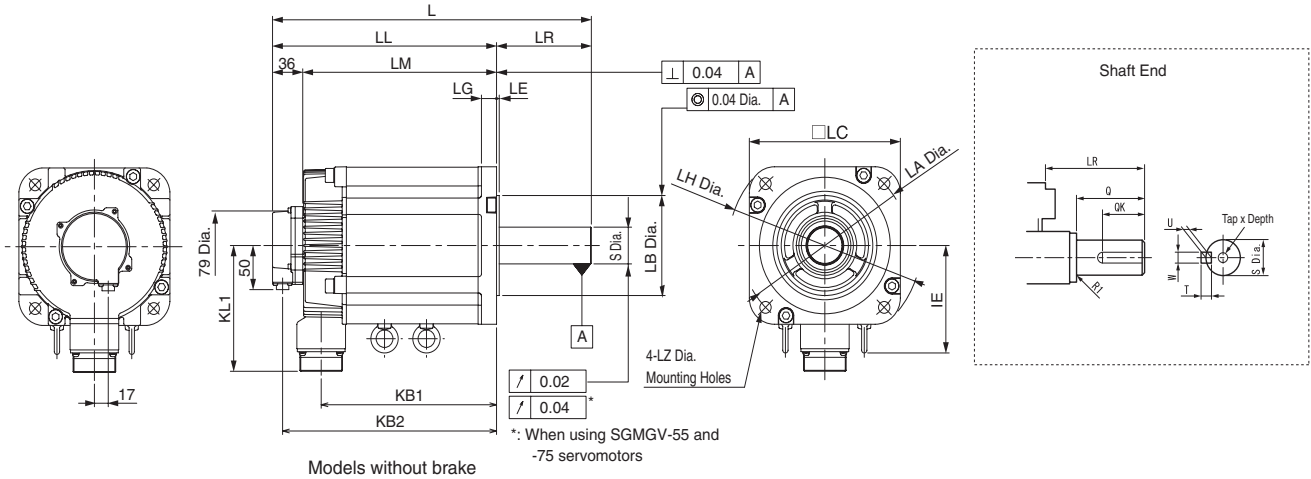

Type SGMGV (400 V, 11 - 15 kW)

| Dimensions (mm) | Without brake |     |     |      | With brake |     |     |      |      |      | LR  | KB 1 | IE  | KL1 | Flange Face Dimensions |                  |     |    |    |     |      | Shaft End Dimensions |     |    |    |    |   | Approx. Mass (Kg) |               |            |    |
|-----------------|---------------|-----|-----|------|------------|-----|-----|------|------|------|-----|------|-----|-----|------------------------|------------------|-----|----|----|-----|------|----------------------|-----|----|----|----|---|-------------------|---------------|------------|----|
|                 | L             | LL  | LM  | KB 2 | L          | LL  | LM  | KB 2 | KB 3 | KL 3 |     |      |     |     | LA                     | LB               | LC  | LE | LG | LH  | LZ   | S                    | Q   | QK | W  | T  | U | Tap x Depth       | Without brake | With brake |    |
| SGMGV-1AD□A6    | 447           | 331 | 295 | 319  | 498        | 382 | 346 | 370  | 315  | 125  | 116 | 247  | 150 | 168 | 235                    | 200 <sup>U</sup> | 220 | 4  | 20 | 270 | 13.5 | 42 <sup>U</sup>      | 110 | 90 | 12 | 8  | 5 | M16 x 32L         | 57            | 65         |    |
| SGMGV-1ED□A6    | 509           | 393 | 357 | 381  | 598        | 482 | 446 | 470  | 385  |      |     | 309  |     |     |                        |                  |     |    |    |     |      |                      |     |    |    | 16 | 1 | 6                 | M20 x 40L     | 67         | 85 |

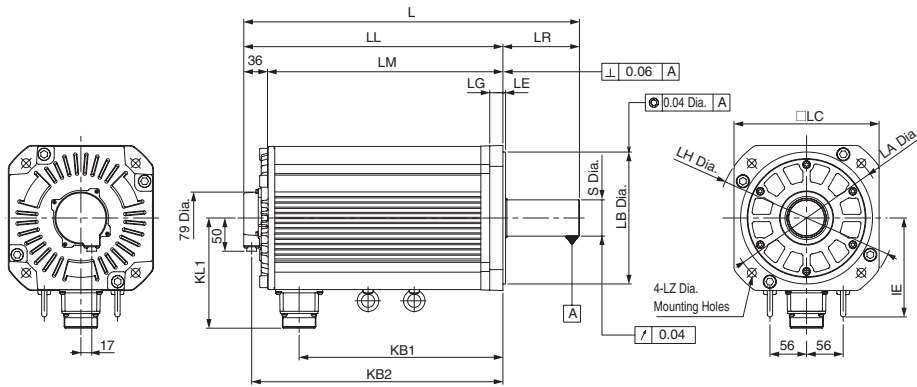

Models without brake

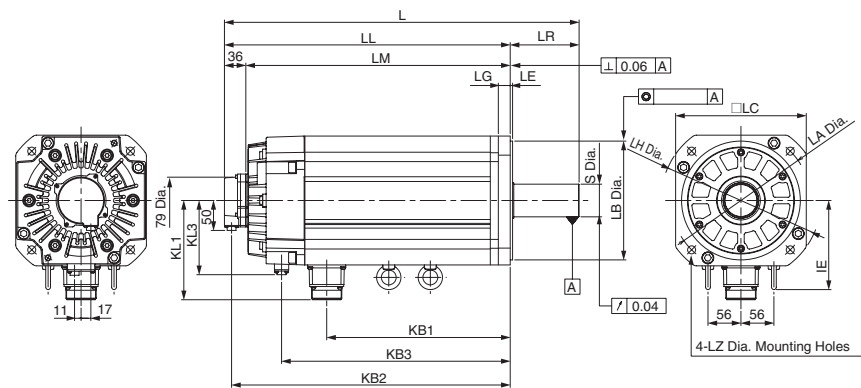
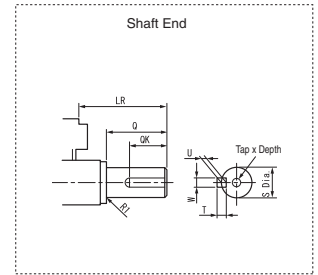

Models with brake

Type SGMSV (400 V, 1 - 5 kW)

| Dimensions (mm)  | Without brake |     |     |    |     | With brake |     |     |    |     |     |     | KB1 | KL1 | Flange Face Dimensions |                            |     |    |    |    |     |    | Shaft End Dimensions      |    |    |   |   |   | Approx. Mass (Kg) |               |            |
|------------------|---------------|-----|-----|----|-----|------------|-----|-----|----|-----|-----|-----|-----|-----|------------------------|----------------------------|-----|----|----|----|-----|----|---------------------------|----|----|---|---|---|-------------------|---------------|------------|
|                  | L             | LL  | LM  | LR | KB2 | L          | LL  | LM  | LR | KB2 | KB3 | KL2 |     |     | LA                     | LB                         | LC  | LE | LF | LG | LH  | LZ | S                         | Q  | QK | W | T | U | Tap x Depth       | Without brake | With brake |
| SGMSV-10D□A2□-OY | 192           | 147 | 111 | 45 | 135 | 233        | 188 | 152 | 45 | 118 | 176 | 69  | 76  | 96  | 115                    | 95 <sup>0</sup><br>-0.035  | 100 | 3  | 3  | 10 | 130 | 7  | 24 <sup>0</sup><br>-0.013 | 40 | 32 | 8 | 7 | 4 | M8 x 16L          | 4.1           | 5.5        |
| SGMSV-15D□A2□-OY | 211           | 153 | 117 | 58 | 141 | 243        | 198 | 162 | 45 | 128 | 186 |     | 99  |     |                        |                            |     |    |    |    |     |    |                           |    |    |   |   |   |                   | 4.6           | 6          |
| SGMSV-20D□A2□-OY | 229           | 171 | 135 | 58 | 159 | 259        | 214 | 178 | 45 | 144 | 202 |     | 117 |     |                        |                            |     |    |    |    |     |    |                           |    |    |   |   |   |                   | 5.4           | 6.8        |
| SGMSV-25D□A2□-OY | 239           | 160 | 124 | 79 | 148 | 292        | 247 | 211 | 45 | 177 | 225 |     | 108 |     |                        |                            |     |    |    |    |     |    |                           |    |    |   |   |   |                   | 6.8           | 8.7        |
| SGMSV-30D□A2□-OY | 259           | 196 | 160 | 63 | 184 | 295        | 232 | 196 | 63 | 176 | 220 | 81  | 124 | 114 | 145                    | 110 <sup>0</sup><br>-0.035 | 130 | 6  | 6  | 12 | 165 | 9  | 28 <sup>0</sup><br>-0.013 | 55 | 50 |   |   |   |                   | 10.5          | 13         |
| SGMSV-40D□A2□-OY | 296           | 233 | 197 | 63 | 221 | 332        | 269 | 233 | 63 | 213 | 257 |     | 161 |     |                        |                            |     |    |    |    |     |    |                           |    |    |   |   |   |                   | 13.5          | 16         |
| SGMSV-50D□A2□-OY | 336           | 273 | 237 | 63 | 261 | 372        | 309 | 273 | 63 | 253 | 297 |     | 201 |     |                        |                            |     |    |    |    |     |    |                           |    |    |   |   |   |                   | 16.5          | 19         |

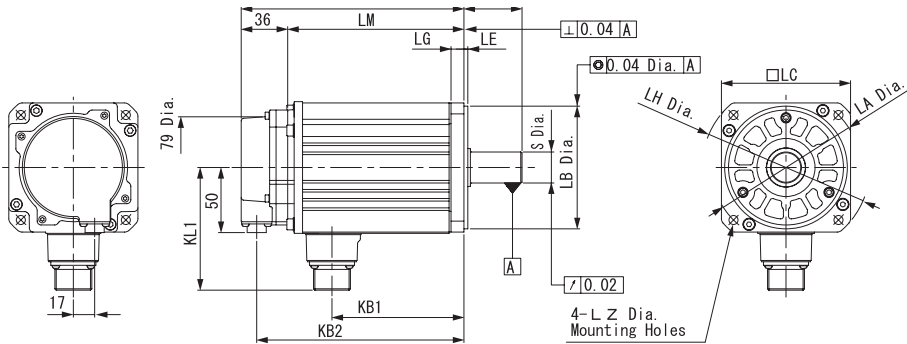

Models without brake

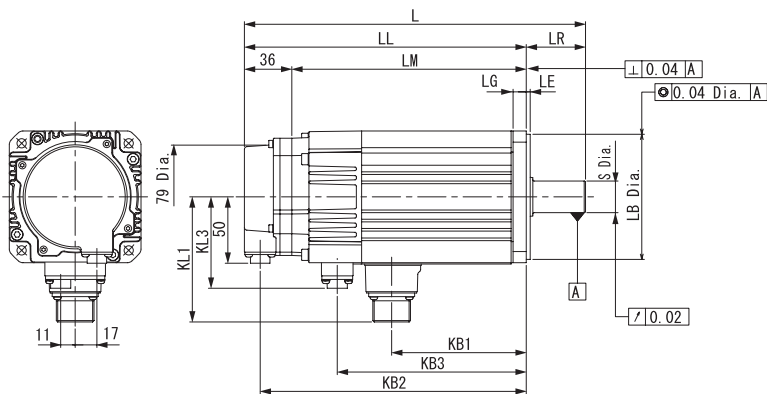
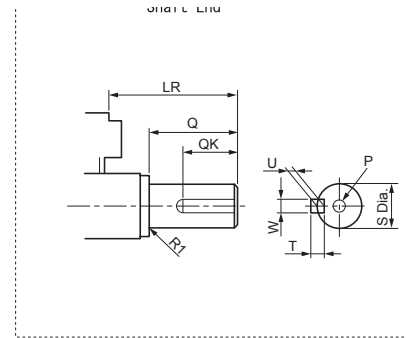

Models with brake



Ordering information

(Refer to servo drive chapter)

Drive options

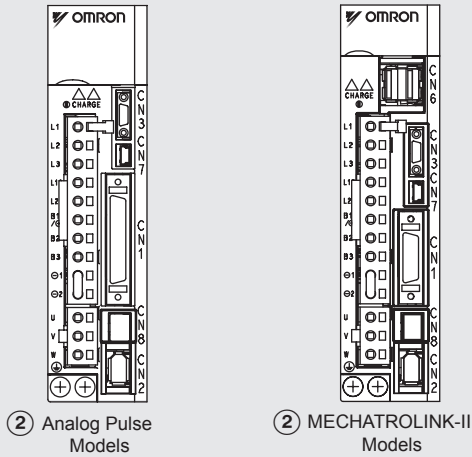

Power, encoder and brake cables

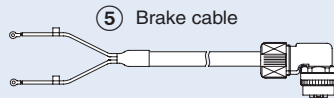
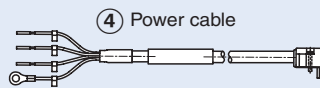
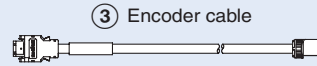

(a separate brake cable to use only for SGMGV and SGMSV servo motors from 850W)

Servo motors

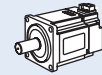

① SGMJV Servo Motor  
3000 rpm (50-750 W)

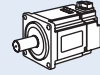

① SGMAV Servo Motor  
3000 rpm (50W-1kW)



① SGMEV Servo Motor  
3000 rpm (100W-1.5kW)

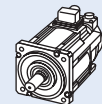

① SGMGV Servo Motor  
1500 rpm (300W-15 kW)

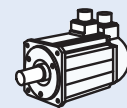

① SGMSV Servo Motor  
3000 rpm (1-5kW)

**Note:** The symbols ①②③... show the recommended sequence to select the servo motor and cables

**Servo motor**

① Select motor from families SGMJV, SGMAV, SGMEV, SGMGV, SGMSV using motor tables in next pages.

**Servo drive**

② Refer to Sigma-5 servo drive chapter for detailed drive specifications and selection of drive accessories.

SGMJV - servo motors 3000 r/min (50 - 750 W)

| Symbol  | Specifications |   |               |                  | Servo motor model | Compatible servo drives (2) |                |
|---|----------------|---|---------------|------------------|-------------------|-----------------------------|----------------|
|   | Voltage        | Encoder and design  | Rated torque  | Capacity         |                   |                             | Sigma-5        |
|  | 230 V          | Incremental encoder (13 bit)<br>Straight shaft with key and tap | Without brake | 0.159 Nm         | 50 W              | SGMJV-A5AAA61-OY            | SGDV-A5□1A-OY  |
|   |                |   |               | 0.318 Nm         | 100 W             | SGMJV-01AAA61-OY            | SGDV-01A□1A-OY |
|   |                |   |               | 0.637 Nm         | 200 W             | SGMJV-02AAA61-OY            | SGDV-02A□1A-OY |
|   |                |   |               | 1.27 Nm          | 400 W             | SGMJV-04AAA61-OY            | SGDV-04A□1A-OY |
|   |                |   |               | 2.39 Nm          | 750 W             | SGMJV-08AAA61-OY            | SGDV-08A□1A-OY |
|   |                |   |               | 2.39 Nm          | 750 W             | SGMJV-08AAA61-OY            | SGDV-08A□1A-OY |
|   |                |   | With brake    | 0.159 Nm         | 50 W              | SGMJV-A5AAA6C-OY            | SGDV-A5□1A-OY  |
|   |                |   |               | 0.318 Nm         | 100 W             | SGMJV-01AAA6C-OY            | SGDV-01A□1A-OY |
|   |                |   |               | 0.637 Nm         | 200 W             | SGMJV-02AAA6C-OY            | SGDV-02A□1A-OY |
|   |                |   |               | 1.27 Nm          | 400 W             | SGMJV-04AAA6C-OY            | SGDV-04A□1A-OY |
|   |                |   |               | 2.39 Nm          | 750 W             | SGMJV-08AAA6C-OY            | SGDV-08A□1A-OY |
|   |                |   |               | 2.39 Nm          | 750 W             | SGMJV-08AAA6C-OY            | SGDV-08A□1A-OY |
|   |                | Incremental encoder (20 bit)<br>Straight shaft with key and tap | Without brake | 0.159 Nm         | 50 W              | SGMJV-A5ADA61-OY            | SGDV-A5□1A-OY  |
|   |                |   |               | 0.318 Nm         | 100 W             | SGMJV-01ADA61-OY            | SGDV-01A□1A-OY |
|   |                |   |               | 0.637 Nm         | 200 W             | SGMJV-02ADA61-OY            | SGDV-02A□1A-OY |
|   |                |   |               | 1.27 Nm          | 400 W             | SGMJV-04ADA61-OY            | SGDV-04A□1A-OY |
|   |                |   |               | 2.39 Nm          | 750 W             | SGMJV-08ADA61-OY            | SGDV-08A□1A-OY |
|   |                |   |               | 2.39 Nm          | 750 W             | SGMJV-08ADA61-OY            | SGDV-08A□1A-OY |
|   |                |   | With brake    | 0.159 Nm         | 50 W              | SGMJV-A5ADA6C-OY            | SGDV-A5□1A-OY  |
|   |                |   |               | 0.318 Nm         | 100 W             | SGMJV-01ADA6C-OY            | SGDV-01A□1A-OY |
|   |                |   |               | 0.637 Nm         | 200 W             | SGMJV-02ADA6C-OY            | SGDV-02A□1A-OY |
|   |                |   |               | 1.27 Nm          | 400 W             | SGMJV-04ADA6C-OY            | SGDV-04A□1A-OY |
|   |                |   |               | 2.39 Nm          | 750 W             | SGMJV-08ADA6C-OY            | SGDV-08A□1A-OY |
|   |                |   |               | 2.39 Nm          | 750 W             | SGMJV-08ADA6C-OY            | SGDV-08A□1A-OY |
| Absolute encoder (20 bit)<br>Straight shaft with key and tap                      | Without brake  | 0.159 Nm  | 50 W          | SGMJV-A5A3A61-OY | SGDV-A5□1A-OY     |                             |                |
|   |                | 0.318 Nm  | 100 W         | SGMJV-01A3A61-OY | SGDV-01A□1A-OY    |                             |                |
|   |                | 0.637 Nm  | 200 W         | SGMJV-02A3A61-OY | SGDV-02A□1A-OY    |                             |                |
|   |                | 1.27 Nm   | 400 W         | SGMJV-04A3A61-OY | SGDV-04A□1A-OY    |                             |                |
|   |                | 2.39 Nm   | 750 W         | SGMJV-08A3A61-OY | SGDV-08A□1A-OY    |                             |                |
|   |                | 2.39 Nm   | 750 W         | SGMJV-08A3A61-OY | SGDV-08A□1A-OY    |                             |                |
|   | With brake     | 0.159 Nm  | 50 W          | SGMJV-A5A3A6C-OY | SGDV-A5□1A-OY     |                             |                |
|   |                | 0.318 Nm  | 100 W         | SGMJV-01A3A6C-OY | SGDV-01A□1A-OY    |                             |                |
|   |                | 0.637 Nm  | 200 W         | SGMJV-02A3A6C-OY | SGDV-02A□1A-OY    |                             |                |
|   |                | 1.27 Nm   | 400 W         | SGMJV-04A3A6C-OY | SGDV-04A□1A-OY    |                             |                |
|   |                | 2.39 Nm   | 750 W         | SGMJV-08A3A6C-OY | SGDV-08A□1A-OY    |                             |                |
|   |                | 2.39 Nm   | 750 W         | SGMJV-08A3A6C-OY | SGDV-08A□1A-OY    |                             |                |

SGMAV - servo motors 3000 r/min (50 - 750 W)

| Symbol  | Specifications |   |               |          | Servo motor model | Compatible servo drives (2) |                       |
|---|----------------|---|---------------|----------|-------------------|-----------------------------|-----------------------|
|   | Voltage        | Encoder and design  | Rated torque  | Capacity |                   |                             | Sigma-5               |
|  | 230 V          | Incremental encoder (20 bit)<br>Straight shaft with key and tap | Without brake | 0.159 Nm | 50 W              | SGMAV-A5ADA61-OY            | SGDV-A5□1A-OY         |
|   |                |   |               | 0.318 Nm | 100 W             | SGMAV-01ADA61-OY            | SGDV-01A□1A-OY        |
|   |                |   |               | 0.477 Nm | 150 W             | SGMAV-C2ADA61-OY            | SGDV-02A□1A-OY        |
|   |                |   |               | 0.637 Nm | 200 W             | SGMAV-02ADA61-OY            | SGDV-02A□1A-OY        |
|   |                |   |               | 1.27 Nm  | 400 W             | SGMAV-04ADA61-OY            | SGDV-04A□1A-OY        |
|   |                |   |               | 1.75 Nm  | 550 W             | SGMAV-06ADA61-OY            | SGDV-08A□1A-OY        |
|   |                |   |               | 2.39 Nm  | 750 W             | SGMAV-08ADA61-OY            | SGDV-08A□1A-OY        |
|   |                |   |               | 3.18 Nm  | 1 kW              | SGMAV-10ADA61-OY            | SGDV-15A□1A-OY-008000 |
|   |                |   |               | 3.18 Nm  | 1 kW              | SGMAV-10ADA61-OY            | SGDV-15A□1A-OY-008000 |
|   |                |   | With brake    | 0.159 Nm | 50 W              | SGMAV-A5ADA6C-OY            | SGDV-A5□1A-OY         |
|   |                |   |               | 0.318 Nm | 100 W             | SGMAV-01ADA6C-OY            | SGDV-01A□1A-OY        |
|   |                |   |               | 0.477 Nm | 150 W             | SGMAV-C2ADA6C-OY            | SGDV-02A□1A-OY        |
|   |                |   |               | 0.637 Nm | 200 W             | SGMAV-02ADA6C-OY            | SGDV-02A□1A-OY        |
|   |                |   |               | 1.27 Nm  | 400 W             | SGMAV-04ADA6C-OY            | SGDV-04A□1A-OY        |
|   |                |   |               | 1.75 Nm  | 550 W             | SGMAV-06ADA6C-OY            | SGDV-08A□1A-OY        |
|   |                |   |               | 2.39 Nm  | 750 W             | SGMAV-08ADA6C-OY            | SGDV-08A□1A-OY        |
|   |                |   |               | 3.18 Nm  | 1 kW              | SGMAV-10ADA6C-OY            | SGDV-15A□1A-OY-008000 |
|   |                |   |               | 3.18 Nm  | 1 kW              | SGMAV-10ADA6C-OY            | SGDV-15A□1A-OY-008000 |
|   |                | Absolute encoder (20 bit)<br>Straight shaft with key and tap    | Without brake | 0.159 Nm | 50 W              | SGMAV-A5A3A61-OY            | SGDV-A5□1A-OY         |
|   |                |   |               | 0.318 Nm | 100 W             | SGMAV-01A3A61-OY            | SGDV-01A□1A-OY        |
|   |                |   |               | 0.477 Nm | 150 W             | SGMAV-C2A3A61-OY            | SGDV-02A□1A-OY        |
|   |                |   |               | 0.637 Nm | 200 W             | SGMAV-02A3A61-OY            | SGDV-02A□1A-OY        |
|   |                |   |               | 1.27 Nm  | 400 W             | SGMAV-04A3A61-OY            | SGDV-04A□1A-OY        |
|   |                |   |               | 1.75 Nm  | 550 W             | SGMAV-06A3A61-OY            | SGDV-08A□1A-OY        |
|   |                |   |               | 2.39 Nm  | 750 W             | SGMAV-08A3A61-OY            | SGDV-08A□1A-OY        |
|   |                |   |               | 3.18 Nm  | 1 kW              | SGMAV-10A3A61-OY            | SGDV-15A□1A-OY-008000 |
|   |                |   |               | 3.18 Nm  | 1 kW              | SGMAV-10A3A61-OY            | SGDV-15A□1A-OY-008000 |
|   |                |   | With brake    | 0.159 Nm | 50 W              | SGMAV-A5A3A6C-OY            | SGDV-A5□1A-OY         |
|   |                |   |               | 0.318 Nm | 100 W             | SGMAV-01A3A6C-OY            | SGDV-01A□1A-OY        |
|   |                |   |               | 0.477 Nm | 150 W             | SGMAV-C2A3A6C-OY            | SGDV-02A□1A-OY        |
|   |                |   |               | 0.637 Nm | 200 W             | SGMAV-02A3A6C-OY            | SGDV-02A□1A-OY        |
|   |                |   |               | 1.27 Nm  | 400 W             | SGMAV-04A3A6C-OY            | SGDV-04A□1A-OY        |
|   |                |   |               | 1.75 Nm  | 550 W             | SGMAV-06A3A6C-OY            | SGDV-08A□1A-OY        |
|   |                |   |               | 2.39 Nm  | 750 W             | SGMAV-08A3A6C-OY            | SGDV-08A□1A-OY        |
|   |                |   |               | 3.18 Nm  | 1 kW              | SGMAV-10A3A6C-OY            | SGDV-15A□1A-OY-008000 |
|   |                |   |               | 3.18 Nm  | 1 kW              | SGMAV-10A3A6C-OY            | SGDV-15A□1A-OY-008000 |

SGMEV - servo motors 3000 r/min ( 100 W - 1.5 kW)

| Symbol   | Specifications |                              |               |                  | Servo motor model | Compatible servo drives <sup>(2)</sup> |                       |
|--|----------------|------------------------------|---------------|------------------|-------------------|--|-----------------------|
|  | Voltage        | Encoder and design           |               | Rated torque     |                   |  | Capacity              |
| <p>①</p>  | 230 V          | Incremental encoder (20 bit) | Without brake | 0.318 Nm         | 100 W             | SGMEV-01ADA61-OY                       | SGDV-01A□1A-OY        |
|  |                |                              |               | 0.637 Nm         | 200 W             | SGMEV-02ADA61-OY                       | SGDV-02A□1A-OY        |
|  |                |                              |               | 1.27 Nm          | 400 W             | SGMEV-04ADA61-OY                       | SGDV-04A□1A-OY        |
|  |                |                              |               | 2.39 Nm          | 750 W             | SGMEV-08ADA61-OY                       | SGDV-08A□1A-OY        |
|  |                |                              |               | 4.77 Nm          | 1.5 kW            | SGMEV-15ADA61-OY                       | SGDV-15A□1A-OY-008000 |
|  |                |                              | With brake    | 0.318 Nm         | 100 W             | SGMEV-01ADA6C-OY                       | SGDV-01A□1A-OY        |
|  |                |                              |               | 0.637 Nm         | 200 W             | SGMEV-02ADA6C-OY                       | SGDV-02A□1A-OY        |
|  |                |                              |               | 1.27 Nm          | 400 W             | SGMEV-04ADA6C-OY                       | SGDV-04A□1A-OY        |
|  |                |                              |               | 2.39 Nm          | 750 W             | SGMEV-08ADA6C-OY                       | SGDV-08A□1A-OY        |
|  |                |                              |               | 4.77 Nm          | 1.5 kW            | SGMEV-15ADA6C-OY                       | SGDV-15A□1A-OY-008000 |
|  |                | Absolute encoder (20 bit)    | Without brake | 0.318 Nm         | 100 W             | SGMEV-01A3A61-OY                       | SGDV-01A□1A-OY        |
|  |                |                              |               | 0.637 Nm         | 200 W             | SGMEV-02A3A61-OY                       | SGDV-02A□1A-OY        |
|  |                |                              |               | 1.27 Nm          | 400 W             | SGMEV-04A3A61-OY                       | SGDV-04A□1A-OY        |
|  |                |                              |               | 2.39 Nm          | 750 W             | SGMEV-08A3A61-OY                       | SGDV-08A□1A-OY        |
|  |                |                              |               | 4.77 Nm          | 1.5 kW            | SGMEV-15A3A61-OY                       | SGDV-15A□1A-OY-008000 |
|  |                |                              | With brake    | 0.318 Nm         | 100 W             | SGMEV-01A3A6C-OY                       | SGDV-01A□1A-OY        |
|  |                |                              |               | 0.637 Nm         | 200 W             | SGMEV-02A3A6C-OY                       | SGDV-02A□1A-OY        |
|  |                |                              |               | 1.27 Nm          | 400 W             | SGMEV-04A3A6C-OY                       | SGDV-04A□1A-OY        |
|  | 2.39 Nm        |                              |               | 750 W            | SGMEV-08A3A6C-OY  | SGDV-08A□1A-OY                         |                       |
|  | 4.77 Nm        |                              |               | 1.5 kW           | SGMEV-15A3A6C-OY  | SGDV-15A□1A-OY-008000                  |                       |
|  | 400 V          | Incremental encoder (20 bit) | Without brake | 0.637 Nm         | 200 W             | SGMEV-02DDA61-OY                       | SGDV-05D□1A-OY        |
|  |                |                              |               | 0.955 Nm         | 300 W             | SGMEV-03DDA61-OY                       | SGDV-05D□1A-OY        |
|  |                |                              |               | 1.27 Nm          | 400 W             | SGMEV-04DDA61-OY                       | SGDV-05D□1A-OY        |
|  |                |                              |               | 2.07 Nm          | 650 W             | SGMEV-07DDA61-OY                       | SGDV-10D□1A-OY        |
|  |                |                              |               | 2.39 Nm          | 750 W             | SGMEV-08DDA61-OY                       | SGDV-10D□1A-OY        |
|  |                |                              | With brake    | 0.637 Nm         | 200 W             | SGMEV-02DDA6C-OY                       | SGDV-05D□1A-OY        |
|  |                |                              |               | 0.955 Nm         | 300 W             | SGMEV-03DDA6C-OY                       | SGDV-05D□1A-OY        |
|  |                |                              |               | 1.27 Nm          | 400 W             | SGMEV-04DDA6C-OY                       | SGDV-05D□1A-OY        |
|  |                |                              |               | 2.07 Nm          | 650 W             | SGMEV-07DDA2C-OY                       | SGDV-10D□1A-OY        |
|  |                |                              |               | 2.39 Nm          | 750 W             | SGMEV-08DDA2C-OY                       | SGDV-10D□1A-OY        |
|  |                | Absolute encoder (20 bit)    | Without brake | 0.637 Nm         | 200 W             | SGMEV-02D3A61-OY                       | SGDV-05D□1A-OY        |
|  |                |                              |               | 0.955 Nm         | 300 W             | SGMEV-03D3A61-OY                       | SGDV-05D□1A-OY        |
|  |                |                              |               | 1.27 Nm          | 400 W             | SGMEV-04D3A61-OY                       | SGDV-05D□1A-OY        |
|  |                |                              |               | 2.07 Nm          | 650 W             | SGMEV-07D3A61-OY                       | SGDV-10D□1A-OY        |
|  |                |                              |               | 2.39 Nm          | 750 W             | SGMEV-08D3A61-OY                       | SGDV-10D□1A-OY        |
|  |                |                              | With brake    | 0.637 Nm         | 200 W             | SGMEV-02D3A6C-OY                       | SGDV-05D□1A-OY        |
| 0.955 Nm   |                |                              |               | 300 W            | SGMEV-03D3A6C-OY  | SGDV-05D□1A-OY                         |                       |
| 1.27 Nm  |                |                              |               | 400 W            | SGMEV-04D3A6C-OY  | SGDV-05D□1A-OY                         |                       |
| Straight shaft with key and tap  | Without brake  | 2.07 Nm                      | 650 W         | SGMEV-07D3A61-OY | SGDV-10D□1A-OY    |  |                       |
|  |                | 2.39 Nm                      | 750 W         | SGMEV-08D3A61-OY | SGDV-10D□1A-OY    |  |                       |
|  |                | 4.77 Nm                      | 1.5 kW        | SGMEV-15D3A61-OY | SGDV-15D□1A-OY    |  |                       |
|  | With brake     | 0.637 Nm                     | 200 W         | SGMEV-02D3A6C-OY | SGDV-05D□1A-OY    |  |                       |
|  |                | 0.955 Nm                     | 300 W         | SGMEV-03D3A6C-OY | SGDV-05D□1A-OY    |  |                       |
|  |                | 1.27 Nm                      | 400 W         | SGMEV-04D3A6C-OY | SGDV-05D□1A-OY    |  |                       |
| Straight shaft with key and tap  | Without brake  | 2.07 Nm                      | 650 W         | SGMEV-07D3A61-OY | SGDV-10D□1A-OY    |  |                       |
|  |                | 2.39 Nm                      | 750 W         | SGMEV-08D3A61-OY | SGDV-10D□1A-OY    |  |                       |
| With brake   | Without brake  | 2.39 Nm                      | 750 W         | SGMEV-08D3A6C-OY | SGDV-10D□1A-OY    |  |                       |
|  |                | 4.77 Nm                      | 1.5 kW        | SGMEV-15D3A6C-OY | SGDV-15D□1A-OY    |  |                       |

SGMGV - servo motors 1500 r/min (300 W - 15 kW)





| Symbol  | Specifications |  |   |            | Servo motor model | Compatible servo drives <sup>(2)</sup> |                  |                  |
|---|----------------|--|---|------------|-------------------|--|------------------|------------------|
|   | Voltage        | Encoder and design   | Rated torque  | Capacity   |                   |  | Sigma-5          |                  |
| ①  | 400 V          | <b>Incremental encoder (20 bit)</b><br>Straight shaft with key and tap | Without brake   | 1.96 Nm    | 300 W             | SGMGV-03DDA6F-OY                       | SGDV-05D□1A-OY   |                  |
|   |                |  |   | 2.86 Nm    | 450 W             | SGMGV-05DDA6F-OY                       | SGDV-05D□1A-OY   |                  |
|   |                |  |   | 5.39 Nm    | 850 W             | SGMGV-09DDA6F-OY                       | SGDV-10D□1A-OY   |                  |
|   |                |  |   | 8.34 Nm    | 1.3 kW            | SGMGV-13DDA6F-OY                       | SGDV-15D□1A-OY   |                  |
|   |                |  |   | 11.5 Nm    | 1.8 kW            | SGMGV-20DDA6F-OY                       | SGDV-20D□1A-OY   |                  |
|   |                |  |   | 18.6 Nm    | 2.9 kW            | SGMGV-30DDA6F-OY                       | SGDV-30D□1A-OY   |                  |
|   |                |  |   | 28.4 Nm    | 4.4 kW            | SGMGV-44DDA6F-OY                       | SGDV-50D□1A-OY   |                  |
|   |                |  |   | 35.0 Nm    | 5.5 kW            | SGMGV-55DDA6F                          | SGDV-210D□1A     |                  |
|   |                |  |   | 48.0 Nm    | 7.5 kW            | SGMGV-75DDA6F                          | SGDV-260D□1A     |                  |
|   |                |  |   | 70.0 Nm    | 11 kW             | SGMGV-11DDA6F                          | SGDV-280D□1A     |                  |
|   |                |  |   | 95.4 Nm    | 15 kW             | SGMGV-15DDA6F                          | SGDV-370D□1A     |                  |
|   |                |  |   | With brake | 1.96 Nm           | 300 W                                  | SGMGV-03DDA6H-OY | SGDV-05D□1A-OY   |
|   |                |  | 2.86 Nm   |            | 450 W             | SGMGV-05DDA6H-OY                       | SGDV-05D□1A-OY   |                  |
|   |                |  | 5.39 Nm   |            | 850 W             | SGMGV-09DDA6H-OY                       | SGDV-10D□1A-OY   |                  |
|   |                |  | 8.34 Nm   |            | 1.3 kW            | SGMGV-13DDA6H-OY                       | SGDV-15D□1A-OY   |                  |
|   |                |  | 11.5 Nm   |            | 1.8 kW            | SGMGV-20DDA6H-OY                       | SGDV-20D□1A-OY   |                  |
|   |                |  | 18.6 Nm   |            | 2.9 kW            | SGMGV-30DDA6H-OY                       | SGDV-30D□1A-OY   |                  |
|   |                |  | 28.4 Nm   |            | 4.4 kW            | SGMGV-44DDA6H-OY                       | SGDV-50D□1A-OY   |                  |
|   |                |  | 35.0 Nm   |            | 5.5 kW            | SGMGV-55DDA6H                          | SGDV-210D□1A     |                  |
|   |                |  | 48.0 Nm   |            | 7.5 kW            | SGMGV-75DDA6H                          | SGDV-260D□1A     |                  |
|   |                |  | 70.0 Nm   |            | 11 kW             | SGMGV-11DDA6H                          | SGDV-280D□1A     |                  |
|   |                |  | 95.4 Nm   |            | 15 kW             | SGMGV-15DDA6H                          | SGDV-370D□1A     |                  |
|   |                |  | <b>Absolute encoder (20 bit)</b><br>Straight shaft with key and tap |            | Without brake     | 1.96 Nm                                | 300 W            | SGMGV-03D3A6F-OY |
|   |                |  |   | 2.86 Nm    |                   | 450 W                                  | SGMGV-05D3A6F-OY | SGDV-05D□1A-OY   |
|   |                | 5.39 Nm  |   | 850 W      |                   | SGMGV-09D3A6F-OY                       | SGDV-10D□1A-OY   |                  |
|   |                | 8.34 Nm  |   | 1.3 kW     |                   | SGMGV-13D3A6F-OY                       | SGDV-15D□1A-OY   |                  |
|   |                | 11.5 Nm  |   | 1.8 kW     |                   | SGMGV-20D3A6F-OY                       | SGDV-20D□1A-OY   |                  |
|   |                | 18.6 Nm  |   | 2.9 kW     |                   | SGMGV-30D3A6F-OY                       | SGDV-30D□1A-OY   |                  |
|   |                | 28.4 Nm  |   | 4.4 kW     |                   | SGMGV-44D3A6F-OY                       | SGDV-50D□1A-OY   |                  |
|   |                | 35.0 Nm  |   | 5.5 kW     |                   | SGMGV-55D3A6F                          | SGDV-210D□1A     |                  |
|   |                | 48.0 Nm  |   | 7.5 kW     |                   | SGMGV-75D3A6F                          | SGDV-260D□1A     |                  |
|   |                | 70.0 Nm  |   | 11 kW      |                   | SGMGV-11D3A6F                          | SGDV-280D□1A     |                  |
|   |                | 95.4 Nm  |   | 15 kW      |                   | SGMGV-15D3A6F                          | SGDV-370D□1A     |                  |
|   |                | With brake   |   | 1.96 Nm    |                   | 300 W                                  | SGMGV-03D3A6H-OY | SGDV-05D□1A-OY   |
|   |                |  |   | 2.86 Nm    | 450 W             | SGMGV-05D3A6H-OY                       | SGDV-05D□1A-OY   |                  |
|   |                |  |   | 5.39 Nm    | 850 W             | SGMGV-09D3A6H-OY                       | SGDV-10D□1A-OY   |                  |
|   |                |  |   | 8.34 Nm    | 1.3 kW            | SGMGV-13D3A6H-OY                       | SGDV-15D□1A-OY   |                  |
|   |                |  |   | 11.5 Nm    | 1.8 kW            | SGMGV-20D3A6H-OY                       | SGDV-20D□1A-OY   |                  |
|   |                |  |   | 18.6 Nm    | 2.9 kW            | SGMGV-30D3A6H-OY                       | SGDV-30D□1A-OY   |                  |
|   |                |  |   | 28.4 Nm    | 4.4 kW            | SGMGV-44D3A6H-OY                       | SGDV-50D□1A-OY   |                  |
|   |                |  |   | 35.0 Nm    | 5.5 kW            | SGMGV-55D3A6H                          | SGDV-210D□1A     |                  |
|   |                |  |   | 48.0 Nm    | 7.5 kW            | SGMGV-75D3A6H                          | SGDV-260D□1A     |                  |
|   |                |  |   | 70.0 Nm    | 11 kW             | SGMGV-11D3A6H                          | SGDV-280D□1A     |                  |
|   |                |  |   | 95.4 Nm    | 15 kW             | SGMGV-15D3A6H                          | SGDV-370D□1A     |                  |

SGMSV - servo motors 3000 r/min ( 1 - 5 kW)



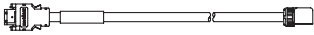

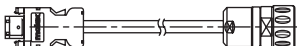
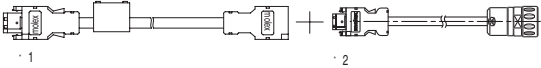

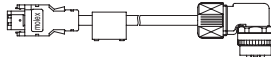
| Symbol  | Specifications |                                     |                |                  | Servo motor model | Compatible servo drives (2) |                |
|---------|----------------|-------------------------------------|----------------|------------------|-------------------|-----------------------------|----------------|
|         | Voltage        | Encoder and design                  |                | Rated torque     |                   |                             | Capacity       |
| ①       | 400 V          | <b>Incremental encoder (20 bit)</b> | Without brake  | 3.18 Nm          | 1 kW              | SGMSV-10DDA6F-OY            | SGDV-10D□1A-OY |
|         |                |                                     |                | 4.9 Nm           | 1.5 kW            | SGMSV-15DDA6F-OY            | SGDV-15D□1A-OY |
|         |                |                                     |                | 6.36 Nm          | 2 kW              | SGMSV-20DDA6F-OY            | SGDV-20D□1A-OY |
|         |                |                                     |                | 7.96 Nm          | 2.5 kW            | SGMSV-25DDA6F-OY            | SGDV-30D□1A-OY |
|         |                |                                     |                | 9.8 Nm           | 3 kW              | SGMSV-30DDA6F-OY            | SGDV-30D□1A-OY |
|         |                |                                     |                | 12.6 Nm          | 4 kW              | SGMSV-40DDA6F-OY            | SGDV-50D□1A-OY |
|         |                |                                     | 15.8 Nm        | 5 kW             | SGMSV-50DDA6F-OY  | SGDV-50D□1A-OY              |                |
|         |                |                                     | With brake     | 3.18 Nm          | 1 kW              | SGMSV-10DDA6H-OY            | SGDV-10D□1A-OY |
|         |                |                                     |                | 4.9 Nm           | 1.5 kW            | SGMSV-15DDA6H-OY            | SGDV-15D□1A-OY |
|         |                |                                     |                | 6.36 Nm          | 2 kW              | SGMSV-20DDA6H-OY            | SGDV-20D□1A-OY |
|         |                |                                     |                | 7.96 Nm          | 2.5 kW            | SGMSV-25DDA6H-OY            | SGDV-30D□1A-OY |
|         |                |                                     |                | 9.8 Nm           | 3 kW              | SGMSV-30DDA6H-OY            | SGDV-30D□1A-OY |
|         |                | 12.6 Nm                             |                | 4 kW             | SGMSV-40DDA6H-OY  | SGDV-50D□1A-OY              |                |
|         |                | 15.8 Nm                             | 5 kW           | SGMSV-50DDA6H-OY | SGDV-50D□1A-OY    |                             |                |
|         |                | <b>Absolute encoder (20 bit)</b>    | Without brake  | 3.18 Nm          | 1 kW              | SGMSV-10D3A6F-OY            | SGDV-10D□1A-OY |
|         |                |                                     |                | 4.9 Nm           | 1.5 kW            | SGMSV-15D3A6F-OY            | SGDV-15D□1A-OY |
|         |                |                                     |                | 6.36 Nm          | 2 kW              | SGMSV-20D3A6F-OY            | SGDV-20D□1A-OY |
|         |                |                                     |                | 7.96 Nm          | 2.5 kW            | SGMSV-25D3A6F-OY            | SGDV-30D□1A-OY |
|         |                |                                     |                | 9.8 Nm           | 3 kW              | SGMSV-30D3A6F-OY            | SGDV-30D□1A-OY |
|         |                |                                     |                | 12.6 Nm          | 4 kW              | SGMSV-40D3A6F-OY            | SGDV-50D□1A-OY |
|         |                |                                     | 15.8 Nm        | 5 kW             | SGMSV-50D3A6F-OY  | SGDV-50D□1A-OY              |                |
|         |                |                                     | With brake     | 3.18 Nm          | 1 kW              | SGMSV-10D3A6H-OY            | SGDV-10D□1A-OY |
|         |                |                                     |                | 4.9 Nm           | 1.5 kW            | SGMSV-15D3A6H-OY            | SGDV-15D□1A-OY |
|         |                |                                     |                | 6.36 Nm          | 2 kW              | SGMSV-20D3A6H-OY            | SGDV-20D□1A-OY |
| 7.96 Nm | 2.5 kW         |                                     |                | SGMSV-25D3A6H-OY | SGDV-30D□1A-OY    |                             |                |
| 9.8 Nm  | 3 kW           |                                     |                | SGMSV-30D3A6H-OY | SGDV-30D□1A-OY    |                             |                |
| 12.6 Nm | 4 kW           | SGMSV-40D3A6H-OY                    |                | SGDV-50D□1A-OY   |                   |                             |                |
| 15.8 Nm | 5 kW           | SGMSV-50D3A6H-OY                    | SGDV-50D□1A-OY |                  |                   |                             |                |

Encoder Cables

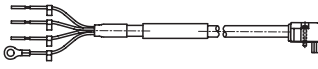
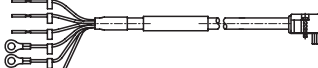
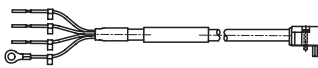
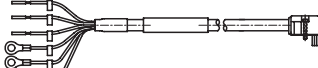
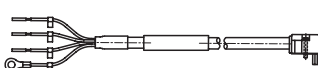
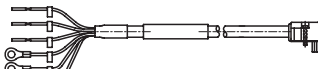
for sigma-5 servo drive

| Symbol   | Specifications  | Model              | Appearance   |   |
|--|---|--------------------|--|---|
| ③  | Sigma-5 incremental encoder cable for SGMJV/AV Servo motors<br>SGMJV-□□ADA□□-OY,<br>SGMJV-□□AAA□□-OY,<br>SGMAV-□□ADA□□-OY | 3 m                | JZSP-CSP21-03-E-G1   |  |
|  |   | 5 m                | JZSP-CSP21-05-E-G1   |   |
|  |   | 10 m               | JZSP-CSP21-10-E-G1   |   |
|  |   | 15 m               | JZSP-CSP21-15-E-G1   |   |
|  |   | 20 m               | JZSP-CSP21-20-E-G1   |   |
|  | Sigma-5 absolute encoder cable (with a battery case) for SGMJV/AV Servo motors<br>SGMJV-□□A3A□□-OY<br>SGMAV-□□A3A□□-OY    | 3 m                | JZSP-CSP25-03-G1   |  |
|  |   | 5 m                | JZSP-CSP25-05-G1   |   |
|  |   | 10 m               | JZSP-CSP25-10-G1   |   |
|  |   | 15 m               | JZSP-CSP25-15-G1   |   |
|  |   | 20 m               | JZSP-CSP25-20-G1   |   |
|  | Sigma-5 incremental encoder cable for SGMEV Servo motors  | 3 m                | R88A-CRWA003C-DE   |  |
|  |   | 5 m                | R88A-CRWA005C-DE   |   |
|  |   | 10 m               | R88A-CRWA010C-DE   |   |
|  |   | 15 m               | R88A-CRWA015C-DE   |   |
|  |   | 20 m               | R88A-CRWA020C-DE   |   |
|  | Sigma-5 absolute encoder cable extension with a battery case for SGMEV Servo motors                                       | 0.3 m              | JZSP-CSP12-E   |   |
|  | Sigma-5 incremental encoder cable for SGMGV/SV Servo motors<br>SGMGV-□□DD□<br>SGMSV-□□DD□                                 | 3 m                | JZSP-CVP12-03-E-G1   |  |
|  |   | 5 m                | JZSP-CVP12-05-E-G1   |   |
|  |   | 10 m               | JZSP-CVP12-10-E-G1   |   |
|  |   | 15 m               | JZSP-CVP12-15-E-G1   |   |
| 20 m   |   | JZSP-CVP12-20-E-G1 |  |   |
| Sigma-5 absolute encoder cable (with a battery case) for SGMGV/SV Servo motors<br>SGMGV-□□D3□<br>SGMSV-□□D3□ | 3 m   | JZSP-CVP27-03-G1   |  |   |
|  | 5 m   | JZSP-CVP27-05-G1   |  |   |
|  | 10 m  | JZSP-CVP27-10-G1   |  |   |
|  | 15 m  | JZSP-CVP27-15-G1   |  |   |
|  | 20 m  | JZSP-CVP27-20-G1   |  |   |

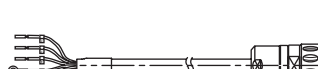
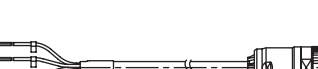
Power cables

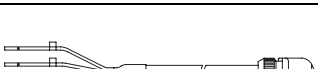
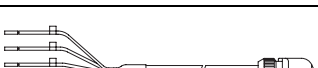
| Symbol   | Specifications  | Model              | Appearance  |   |
|--|---|--------------------|---|---|
| ④  | For 200 V servo motors without brake<br>SGMJV-(A5/01)A□A□1-OY<br>SGMAV-(A5/01/C2)ADA□1-OY | 3 m                | JZSP-CSM21-03-E-G1  |  |
|  |   | 5 m                | JZSP-CSM21-05-E-G1  |   |
|  |   | 10 m               | JZSP-CSM21-10-E-G1  |   |
|  |   | 15 m               | JZSP-CSM21-15-E-G1  |   |
|  |   | 20 m               | JZSP-CSM21-20-E-G1  |   |
|  | For 200 V servo motors with brake<br>SGMJV-(A5/01)A□A□C-OY<br>SGMAV-(A5/01/C2)A□A□C-OY    | 3 m                | JZSP-CSM31-03-E-G1  |  |
|  |   | 5 m                | JZSP-CSM31-05-E-G1  |   |
|  |   | 10 m               | JZSP-CSM31-10-E-G1  |   |
|  |   | 15 m               | JZSP-CSM31-15-E-G1  |   |
|  |   | 20 m               | JZSP-CSM31-20-E-G1  |   |
|  | For 200 V servo motors without brake<br>SGMJV-(02/04)A□A□1-OY<br>SGMAV-(02/04/06)A□A□1-OY | 3 m                | JZSP-CSM22-03-E-G1  |  |
|  |   | 5 m                | JZSP-CSM22-05-E-G1  |   |
|  |   | 10 m               | JZSP-CSM22-10-E-G1  |   |
|  |   | 15 m               | JZSP-CSM22-15-E-G1  |   |
|  |   | 20 m               | JZSP-CSM22-20-E-G1  |   |
|  | For 200 V servo motors with brake<br>SGMJV-(02/04)A□A□C-OY<br>SGMAV-(02/04/06)A□A□C-OY    | 3 m                | JZSP-CSM32-03-E-G1  |  |
|  |   | 5 m                | JZSP-CSM32-05-E-G1  |   |
|  |   | 10 m               | JZSP-CSM32-10-E-G1  |   |
|  |   | 15 m               | JZSP-CSM32-15-E-G1  |   |
|  |   | 20 m               | JZSP-CSM32-20-E-G1  |   |
| For 200 V servo motors without brake<br>SGMJV-08A□A□1-OY<br>SGMAV-08A□A□1-OY<br>SGMAV-10A□A□1-OY | 3 m   | JZSP-CSM23-03-E-G1 |    |   |
|  | 5 m   | JZSP-CSM23-05-E-G1 |   |   |
|  | 10 m  | JZSP-CSM23-10-E-G1 |   |   |
|  | 15 m  | JZSP-CSM23-15-E-G1 |   |   |
|  | 20 m  | JZSP-CSM23-20-E-G1 |   |   |
| For 200 V servo motors with brake<br>SGMJV-08A□A□C-OY<br>SGMAV-08A□A□C-OY<br>SGMAV-10A□A□C-OY    | 3 m   | JZSP-CSM33-03-E-G1 |    |   |
|  | 5 m   | JZSP-CSM33-05-E-G1 |   |   |
|  | 10 m  | JZSP-CSM33-10-E-G1 |   |   |
|  | 15 m  | JZSP-CSM33-15-E-G1 |   |   |
|  | 20 m  | JZSP-CSM33-20-E-G1 |   |   |
| For 200 V servo motors without brake<br>SGMEV-(01/02/04/08)A□A□1-OY                              | 3 m   | R88A-CAWA003S-DE   |  |   |
|  | 5 m   | R88A-CAWA005S-DE   |   |   |
|  | 10 m  | R88A-CAWA010S-DE   |   |   |
|  | 15 m  | R88A-CAWA015S-DE   |   |   |
|  | 20 m  | R88A-CAWA020S-DE   |   |   |
| For 200 V servo motors with brake<br>SGMEV-(01/02/04/08)A□A□C-OY                                 | 3 m   | R88A-CAWA003B-DE   |  |   |
|  | 5 m   | R88A-CAWA005B-DE   |   |   |
|  | 10 m  | R88A-CAWA010B-DE   |   |   |
|  | 15 m  | R88A-CAWA015B-DE   |   |   |
|  | 20 m  | R88A-CAWA020B-DE   |   |   |
| For 200 V servo motors without brake<br>SGMEV-15A□A□1-OY   | 3 m   | R88A-CAWB003S-DE   |  |   |
|  | 5 m   | R88A-CAWB005S-DE   |   |   |
|  | 10 m  | R88A-CAWB010S-DE   |   |   |
|  | 15 m  | R88A-CAWB015S-DE   |   |   |
|  | 20 m  | R88A-CAWB020S-DE   |   |   |
| For 200 V servo motors with brake<br>SGMEV-15A□A□C-OY  | 3 m   | R88A-CAWB003B-DE   |  |   |
|  | 5 m   | R88A-CAWB005B-DE   |   |   |
|  | 10 m  | R88A-CAWB010B-DE   |   |   |
|  | 15 m  | R88A-CAWB015B-DE   |   |   |
|  | 20 m  | R88A-CAWB020B-DE   |   |   |
| For 400 V servo motors without brake<br>SGMEV-(02/03/04/07/08/15)D□A□1-OY                        | 3 m   | R88A-CAWK003S-DE   |  |   |
|  | 5 m   | R88A-CAWK005S-DE   |   |   |
|  | 10 m  | R88A-CAWK010S-DE   |   |   |
|  | 15 m  | R88A-CAWK015S-DE   |   |   |
|  | 20 m  | R88A-CAWK020S-DE   |   |   |
| For 400 V servo motors without brake<br>SGMEV-(02/03/04/07/08/15)D□A□C-OY                        | 3 m   | R88A-CAWK003B-DE   |  |   |
|  | 5 m   | R88A-CAWK005B-DE   |   |   |
|  | 10 m  | R88A-CAWK010B-DE   |   |   |
|  | 15 m  | R88A-CAWK015B-DE   |   |   |
|  | 20 m  | R88A-CAWK020B-DE   |   |   |
| For 400 V servo motors without brake<br>SGMGV-(03/05)D□A□1-OY                                    | 3 m   | JZSP-VVM21-03-E    |  |   |
|  | 5 m   | JZSP-VVM21-05-E    |   |   |
|  | 10 m  | JZSP-VVM21-10-E    |   |   |
|  | 15 m  | JZSP-VVM21-15-E    |   |   |
|  | 20 m  | JZSP-VVM21-20-E    |   |   |
| For 400 V servo motors with brake<br>SGMGV-(03/05)D□A□C-OY                                       | 3 m   | JZSP-VVM41-03-E    |  |   |
|  | 5 m   | JZSP-VVM41-05-E    |   |   |
|  | 10 m  | JZSP-VVM41-10-E    |   |   |
|  | 15 m  | JZSP-VVM41-15-E    |   |   |
|  | 20 m  | JZSP-VVM41-20-E    |   |   |

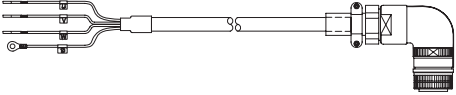
| Symbol   | Specifications   | Model           | Appearance           |  |
|--|--|-----------------|----------------------|--|
|  | For 400 V servo motors<br>SGMGV-09D□<br>SGMSV-10D□                             | 3 m             | JZSP-CVMCA11-03-E-G1 |  |
|  |  | 5 m             | JZSP-CVMCA11-05-E-G1 |  |
|  |  | 10 m            | JZSP-CVMCA11-10-E-G1 |  |
|  |  | 15 m            | JZSP-CVMCA11-15-E-G1 |  |
|  |  | 20 m            | JZSP-CVMCA11-20-E-G1 |  |
|  | For servomotors with brake, a separate cable<br>(JZSP-CVB12-□□-E-G1) is needed | 3 m             | JZSP-CVMCA12-03-E-G1 |  |
|  |  | 5 m             | JZSP-CVMCA12-05-E-G1 |  |
|  |  | 10 m            | JZSP-CVMCA12-10-E-G1 |  |
|  |  | 15 m            | JZSP-CVMCA12-15-E-G1 |  |
|  |  | 20 m            | JZSP-CVMCA12-20-E-G1 |  |
|  | For 400 V servo motors<br>SGMGV-(13/20)D□<br>SGMSV-(15/20/25)D□                | 3 m             | JZSP-CVMCA13-03-E-G1 |  |
|  |  | 5 m             | JZSP-CVMCA13-05-E-G1 |  |
|  |  | 10 m            | JZSP-CVMCA13-10-E-G1 |  |
|  |  | 15 m            | JZSP-CVMCA13-15-E-G1 |  |
|  |  | 20 m            | JZSP-CVMCA13-20-E-G1 |  |
|  | For servomotors with brake, a separate cable<br>(JZSP-CVB12-□□-E-G1) is needed | 3 m             | R88A-CAWF003S-E      |  |
|  |  | 5 m             | R88A-CAWF005S-E      |  |
|  |  | 10 m            | R88A-CAWF010S-E      |  |
|  |  | 15 m            | R88A-CAWF015S-E      |  |
|  |  | 20 m            | R88A-CAWF020S-E      |  |
| For 400 V servo motors<br>SGMGV-(30/44)D□<br>SGMSV-(30/40/50)D□                | 3 m  | R88A-CAWH003S-E |                      |  |
|  | 5 m  | R88A-CAWH005S-E |                      |  |
|  | 10 m   | R88A-CAWH010S-E |                      |  |
|  | 15 m   | R88A-CAWH015S-E |                      |  |
|  | 20 m   | R88A-CAWH020S-E |                      |  |
| For servomotors with brake, a separate cable<br>(JZSP-CVB12-□□-E-G1) is needed | 3 m  | R88A-CAWJ003S-E |                      |  |
|  | 5 m  | R88A-CAWJ005S-E |                      |  |
|  | 10 m   | R88A-CAWJ010S-E |                      |  |
|  | 15 m   | R88A-CAWJ015S-E |                      |  |
|  | 20 m   | R88A-CAWJ020S-E |                      |  |

**Brake cable (for SGMGV-09/13/20/30/44/55/75/1A/1E and SGMSV-10/15/20/25/30/40/50 Motors)**

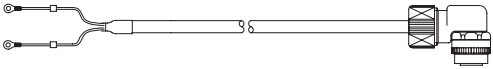
| Symbol | Specifications   | Model  | Appearance   |
|--------|--|--|--|
| ⑤      | Brake cable only.<br>For 400 V servo motors with brake<br>SGMGV-(09/13/20/30/44/55/75/1A/<br>1E)D□A□C□<br>SGMSV-(10/15/20/25/30/40/50)D□A□C-OY | 3 m<br>5 m<br>10 m<br>15 m<br>20 m   |  |
|        |  | JZSP-CVB12-03-E-G1<br>JZSP-CVB12-05-E-G1<br>JZSP-CVB12-10-E-G1<br>JZSP-CVB12-15-E-G1<br>JZSP-CVB12-20-E-G1 |  |



Connectors for power and encoder cables

| Description  |   | Applicable Servo motor   | Manufacturer                             | Model             | Appearance |
|--|---|--|--|-------------------|------------|
| Power connector kit                                | Servomotor side   | SGMJV-(A5/01)□, SGMAV-(A5/01)□, SGMAV-C2□                          | J.S.T.                                   | JZSP-CSM9-1-E-G1  |            |
|  |   | SGMJV-(02/04)□, SGMAV-(02/04/06)□                                  | J.S.T.                                   | JZSP-CSM9-2-E-G1  |            |
|  |   | SGMJV-08□, SGMAV-(08/10)□  | J.S.T.                                   | JZSP-CSM9-3-E-G1  |            |
|  |   | SGMGV-(03/05)□   | Japan Aviation Electronics Industry, Ltd | JZSP-CVM9-1-E     |            |
|  |   | SGMGV-(09/13/20)□, SGMSV-(10/15/20/25)□                            | DDK Ltd                                  | MS3108E18-10S     |            |
|  |   | SGMGV-(30/44)□, SGMSV-(30/40/50)□                                  | DDK Ltd                                  | MS3108E22-22S     |            |
|  |   | SGMGV-(55/75/1A/1E)□   | DDK Ltd                                  | MS3108E32-17S     |            |
|  |   | SGMEV-□□A□   | Hypertac                                 | SPOC-06K-FSDN169  |            |
|  |   | SGMEV-□□D□   | Hypertac                                 | LPRA-06B-FRBN170  |            |
| Brake connector kit                                | Servomotor side   | SGMGV-(09/13/20/30/44/55/75/1A/1E)□, SGMSV-(10/15/20/25/30/40/50)□ | DDK Ltd <sup>*1</sup>                    | CM10Y-AP2S-M-D-G1 |            |
| Encoder connector kit                              | Servo drive side  | SGMJV-□, SGMAV-□, SGMGV-□, SGMEV-□                                 | Molex                                    | JZSP-CMP9-1-E-G1  |            |
|  | Servomotor side   | SGMJV-□, SGMAV-□   | Molex                                    | JZSP-CSP9-2-E-G1  |            |
|  |   | SGMGV-□, SGMSV-□   | DDK Ltd <sup>*1</sup>                    | CM10-AP10S-M-D    |            |
|  |   | SGMEV-□  | Hypertac                                 | SPOC-17H-FRON169  |            |
| Power connector kit -spare part connector male -   | Servomotor side (connector included with 200 V models SGMEV motors) | SGMEV-□□A□   | Hypertac                                 | SRUC-06J-MSCN236  |            |
| Power connector kit -spare part connector male -   | Servomotor side (connector included with 400 V models SGMEV motors) | SGMEV-□□D□   | Hypertac                                 | LRRR-06A-MRPN182  |            |
| Encoder connector kit -spare part connector male - | Servomotor side (connector included with SGMEV motors)              | SGMEV-□  | Hypertac                                 | SRUC-17G-MRWN087  |            |

**Note:** All connectors and cables listed have IP67 protection.

<sup>\*1</sup>The DDK connectors are not supplied. Use the model reference to request the connector to the manufacturer.

ALL DIMENSIONS SHOWN ARE IN MILLIMETERS.  
To convert millimeters into inches, multiply by 0.03937. To convert grams into ounces, multiply by 0.03527.