

Σ Series SGM/SGMP/DR2 USER'S MANUAL

AC Servomotors and Driver

SGM/SGMP Servomotors

DR2 Servopack

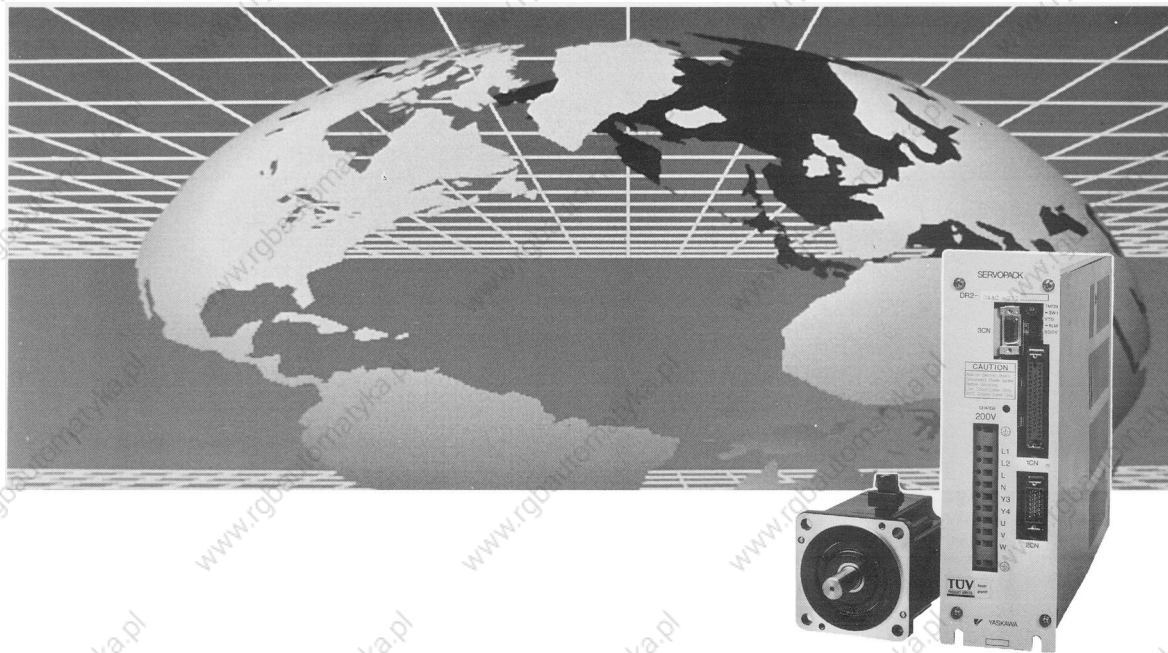

PREFACE

The rapid progress being made in today's automation and information technologies is resulting in a growing need for even more-advanced motion control for future high-tech equipment. The end result is a need for devices that can provide more-precise and quicker motion at higher speeds. Servo control technology makes this possible. Launched by Yaskawa in 1993, the Σ Series consists of innovative AC Servos that were developed using leading-edge servo control technology.

This manual covers all products information on the Σ Series SGM□/DR2, which feature superior functions and performance. This manual was designed to provide comprehensible information for users who are about to use a servo for the first time as well as for users who already have experience in using servos. This manual enables users to understand what Σ -Series AC Servos are all about and how to design, install, operate, and maintain a servo system. Keep this manual in a convenient location and refer to it whenever necessary in operating and maintaining the servo system.

YASKAWA ELECTRIC CORPORATION

General Precautions

- Some drawings in this manual are shown with the protective cover or shields removed, in order to describe the detail with more clarity. Make sure all covers and shields are replaced before operating this product.
- Some drawings in this manual are shown as typical example and may differ from the shipped product.
- This manual may be modified when necessary because of improvement of the product, modification or changes in specifications.
Such modification is made as a revision by renewing the manual No.
- To order a copy of this manual, if your copy has been damaged or lost, contact your YASKAWA representative listed on the last page stating the manual No. on the front cover.
- YASKAWA is not responsible for accidents or damages due to any modification of the product made by the user since that will void our guarantee.

NOTES FOR SAFE OPERATION

Read this manual thoroughly before installation, operation, maintenance or inspection of the AC Servo Drives. In this manual, the NOTES FOR SAFE OPERATION are classified as “WARNING” or “CAUTION”.



Indicates a potentially hazardous situation which, if not avoided, could result in death or serious personal injury.



Indicates a potentially hazardous situation which, if not avoided, may result in minor or moderate personal injury and/or damage to the equipment.

In some instances, items described in  CAUTION may also result in a serious accident. In either case, follow these important items.



WARNING

(INSTALLATION)

- After voltage resistance test, wait at least five minutes before servicing the product.
Failure to observe this warning may result in electric shock.

(WIRING)

- Grounding must be in accordance with the national code and consistent with sound local practices.
Failure to observe this warning may lead to electric shock or fire.

(OPERATION)

- Never touch any rotating motor parts during operation.
Failure to observe this warning may result in personal injury.

(INSPECTION AND MAINTENANCE)

- Be sure to turn OFF power before inspection or maintenance.
Otherwise, electric shock may result.
- After turning OFF power, wait at least five minutes before servicing the product.
Otherwise, residual electric charges may result in electric shock.



CAUTION

(RECEIVING)

- Use the specified combination of SERVOMOTOR and SERVOPACK.
Failure to observe this caution may lead to fire or failure.

(INSTALLATION)

- Never use the equipment where it may be exposed to splashes of water, corrosive or flammable gases, or near flammable materials.
Failure to observe this caution may lead to electric shock or fire.

(WIRING)

- Do not connect three-phase power supply to output terminals U V and W .
Failure to observe this caution may lead to personal injury or fire.
- Securely tighten screws on the power supply and motor output terminals.
Failure to observe this caution can result in a fire.



CAUTION

(OPERATION)

- To avoid inadvertent accidents, run the SERVOMOTOR only in test run (without load).
Failure to observe this caution may result in personal injury.
- Before starting operation with a load connected, set up user constants suitable for the machine.
Starting operation without setting up user constants may lead to overrun failure.
- Before starting operation with a load connected, make sure emergency-stop procedures are in place.
Failure to observe this caution may result in personal injury.
- During operation, do not touch the heat sink.
Failure to observe this caution may result in burns.

(INSPECTION AND MAINTENANCE)

- Do not disassemble the SERVOMOTOR.
Failure to observe this caution may result in electric shock or personal injury.
- Never change wiring while power is ON.
Failure to observe this caution may result in electric shock or personal injury.

Manual Contents

This manual provides Σ -Series users with information on the following:

- An overview of servo systems for first-time users.
- Checking the product on delivery and basic applications of the servo.
- Servo applications.
- Selecting an appropriate servo for your needs and placing an order.
- Inspection and maintenance.

Manual Structure

All chapters in this manual are classified into one or more of three areas according to their contents: **A**, **B**, and **C**. Refer to the applicable chapters for the information you require.

A: Chapters explaining how to select a servo: For users who wish to gain a basic understanding of Σ Series products or who need to select an appropriate servo.

B: Chapters explaining how to design a servo system: For users who are about to design, install, and operate a Σ -Series Servo Control System.

C: Chapters explaining maintenance: For users who are going to maintain and troubleshoot Σ -Series products.

Chapter	Title	Page	Area
CHAPTER 1	For First-time Users of AC Servos	1	A, B
	Provides an overview of servos and the Σ Series		
CHAPTER 2	Basic Uses of Σ-series Products	15	B
	Describes steps to take when product is received, plus basic wiring and application methods.		
CHAPTER 3	Applications of Σ-series Products	49	B
	Describes the effective usage of Σ -Series features according to application.		
CHAPTER 4	Using the Digital Operator	169	B
	Describes operating procedures for Σ -Series servos, turning features ON and OFF, setting control constants, etc.		
CHAPTER 5	Servo Selection and Data Sheets	203	A, B
	Describes selection methods for Σ -Series servos and peripherals and provides servo specifications.		
CHAPTER 6	Inspection, Maintenance, and Troubleshooting	387	C
	Describes user maintenance and troubleshooting.		
CHAPTER 7	Measures to Satisfy the Requirements of EMC Directive	415	B
	Provides the measures to conform to the EMC Directive.		

APPENDIXES

A	Differences between DR2 and DR1, SGDA and SGD Servopacks	423	A, B, C
B	Servo Adjustment	429	B, C
C	List of I/O Signals	445	A, B, C
D	List of User Constants	465	B, C
E	List of Alarm Displays	477	B, C
F	Relationship between Reference Forms and User Constants ..	481	B, C
G	Reviewing the Full-closed Loop Specifications	489	B, C

<u>INDEX</u>	497□	A, B, C
---------------------------	------------	----------------

Basic Terms

Unless otherwise specified, the following definitions are used:

Servomotor: Σ -Series SGM/SGMP Servomotor

Servopack: An amplifier (Trademark of Yaskawa servo amplifier “DR2 Servopack”)

Servodrive: A SGM/SGMP Servomotor and an amplifier (DR2 Servopack)

Servo system: A complete servo control system consisting of servodrive, host controller, and peripheral devices

Visual Aids

The following aids are used to indicate certain types of information for easier reference.



Indicates references for additional information.



Technical terms placed in bold in the text are briefly explained in a “TERMS” section at the bottom of the page. The following kinds of technical terms are explained: Technical terms that need to be explained to users who are not very familiar with servo systems or electronic devices and technical terms specific to Σ Series Servos that need to be explained in descriptions of functions.

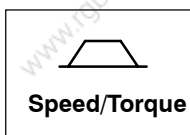

The text indicated by this icon is applicable only to Servopack in speed/torque control mode.

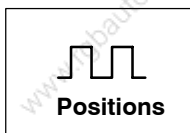

The text indicated by this icon is applicable only to Servopack in position control mode.

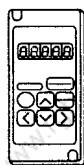

JUSP-OP02A-1

The text indicated by this icon explains the operating procedure using hand-held type digital operator (Type: JUSP-OP02A-1).

NOTE A Σ -Series Servodrive alone cannot ensure the functionality and performance of the entire machine control system. It must be combined with an appropriate machine and host controller so that the entire control system works properly. Therefore, carefully read the instruction manuals for the machine to be used before attempting to operate the servodrive.

©Yaskawa, 1996

All rights reserved. No part of this publication may be reproduced, stored in a retrieval system, or transmitted, in any form, or by any means, mechanical, electronic, photocopying, recording, or otherwise, without the prior written permission of Yaskawa. No patent liability is assumed with respect to the use of the information contained herein. Moreover, because Yaskawa is constantly striving to improve its high-quality products, the information contained in this manual is subject to change without notice. Every precaution has been taken in the preparation of this manual. Nevertheless, Yaskawa assumes no responsibility for errors or omissions. Neither is any liability assumed for damages resulting from the use of the information contained in this publication.

CONTENTS

CHAPTER 1	FOR FIRST-TIME USERS OF AC SERVOS	1
1.1	Basic Understanding of AC Servos	2
1.1.1	Servo Mechanisms	2
1.1.2	Servo Configuration	5
1.1.3	Features of Σ -Series Servos	11
CHAPTER 2	BASIC USES OF Σ-SERIES PRODUCTS	15
2.1	Precautions	16
2.1.1	Notes on Use	16
2.2	Installation	18
2.2.1	Checking on Delivery	18
2.2.2	Installing the Servomotor	19
2.2.3	Installing the Servopack	22
2.3	Connection and Wiring	25
2.3.1	Connecting to Peripheral Devices	25
2.3.2	Main Circuit Wiring and Power ON Sequence	28
2.3.3	Examples of Connecting I/O Signal Terminals	30
2.4	Conducting a Test Run	37
2.4.1	Test Run in Two Steps	37
2.4.2	Step 1: Conducting a Test Run for Motor without Load	39
2.4.3	Step 2: Conducting a Test Run with the Motor Connected to the Machine	43
2.4.4	Supplementary Information on Test Run	45
2.4.5	Minimum User Constants Required and Input Signals	47
CHAPTER 3	APPLICATIONS OF Σ-SERIES PRODUCTS	49
3.1	Setting User Constants According to Machine Characteristics	52
3.1.1	Changing the Direction of Motor Rotation	52
3.1.2	Setting the Overtravel Limit Function	54
3.1.3	Restricting Torque	57
3.2	Setting User Constants According to Host Controller	64
3.2.1	Inputting Speed Reference	64
3.2.2	Inputting Position Reference	69
3.2.3	Using Encoder Output	76
3.2.4	Using Contact I/O Signals	80
3.2.5	Using Electronic Gear	82
3.2.6	Using Contact Input Speed Control	86
3.2.7	Using Torque Control	91
3.2.8	Using Torque Feed-forward Function	97
3.2.9	Using Torque Restriction by Analog Voltage Reference	98
3.2.10	Using the Reference Pulse Inhibit Function (INHIBIT)	100
3.2.11	Using the Reference Pulse Input Filter Selection Function	101
3.2.12	Using the Analog Monitor	102
3.3	Setting Up the Σ Servopack	103
3.3.1	Setting User Constants	103
3.3.2	Setting the Jog Speed	104
3.3.3	Setting the Number of Encoder Pulses	105
3.3.4	Setting the Motor Type	106

CONTENTS

3.4	Setting Stop Mode	107
3.4.1	Adjusting Offset	107
3.4.2	Using Dynamic Brake	108
3.4.3	Using Zero-Clamp	109
3.4.4	Using Holding Brake	110
3.5	Running the Motor Smoothly	114
3.5.1	Using the Soft Start Function	114
3.5.2	Using the Smoothing Function	115
3.5.3	Adjusting Gain	115
3.5.4	Adjusting Offset	116
3.5.5	Setting the Torque Reference Filter Time Constant	116
3.6	Minimizing Positioning Time	118
3.6.1	Using Autotuning Function	118
3.6.2	Setting Servo Gain	118
3.6.3	Using Feed-forward Control	120
3.6.4	Using Proportional Control	120
3.6.5	Setting Speed Bias	121
3.6.6	Using Mode Switch	122
3.7	Forming a Protective Sequence	128
3.7.1	Using Servo Alarm Output and Alarm Code Output	128
3.7.2	Using Servo ON Input Signal	132
3.7.3	Using Positioning Complete Signal	133
3.7.4	Using Speed Coincidence Output Signal	134
3.7.5	Using Running Output Signal	136
3.7.6	Using Servo Ready Output Signal	138
3.8	Special Wiring	140
3.8.1	Wiring Instructions	140
3.8.2	Wiring for Noise Control	142
3.8.3	Using More Than One Servo Drive	147
3.8.4	Using Regenerative Units	148
3.8.5	Using an Absolute Encoder	151
3.8.6	Extending an Encoder Cable	159
3.8.7	Using DR2 Servopack with High Voltage Line	161
3.8.8	Connector Terminal Layouts	163
CHAPTER 4 USING THE DIGITAL OPERATOR		169
4.1	Basic Operations	170
4.1.1	Connecting the Digital Operator	170
4.1.2	Resetting Servo Alarms	171
4.1.3	Basic Functions and Mode Selection	172
4.1.4	Operation in Status Display Mode	173
4.1.5	Operation in User Constant Setting Mode	176
4.1.6	Operation in Monitor Mode	179

CONTENTS

4.2	Using the Functions	183
4.2.1	Operation in Alarm Trace-back Mode	183
4.2.2	Operation Using the Digital Operator	186
4.2.3	Autotuning	188
4.2.4	Reference Offset Automatic Adjustment	195
4.2.5	Speed Reference Offset Manual Adjustment Mode	197
4.2.6	Clearing Alarm Trace-back Data	200
4.2.7	Checking Motor Type	201
4.2.8	Checking Software Version	201
CHAPTER 5 SERVO SELECTION AND DATA SHEETS		203
5.1	Selecting a Σ -Series Servo	205
5.1.1	Selecting a Servomotor	205
5.1.2	Selecting a Servopack	212
5.1.3	Digital Operator	216
5.2	SGM Servomotor	217
5.2.1	Ratings and Specifications	217
5.2.2	Mechanical Characteristics	230
5.3	Servopack Ratings and Specifications	233
5.3.1	Ratings and Specifications	233
5.3.2	Power Consumption	238
5.3.3	Overload Characteristics	239
5.3.4	Starting Time and Stopping Time	240
5.3.5	Load Inertia	241
5.3.6	Overhanging Loads	246
5.4	Σ -Series Dimensional Drawings	247
5.4.1	Servomotor Dimensional Drawings	247
5.4.2	Servomotor Dimensional Drawings (TUV approved, conforming to the machine instructions)	289
5.4.3	Servopack Dimensional Drawings	329
5.4.4	Digital Operator Dimensional Drawing	334
5.5	Selecting Peripheral Devices	335
5.5.1	Selecting Peripheral Devices	335
5.5.2	Order List	341
5.6	Specifications and Dimensional Drawings of Peripheral Devices	349
5.6.1	Cable Specifications and Peripheral Devices	349
5.6.2	Motor Cables	355
5.6.3	Connector Kits	358
5.6.4	Brake Power Supply	363
5.6.5	Encoder Cables	365
5.6.6	Battery for Absolute Encoder	371
5.6.7	1CN Connector	371
5.6.8	Circuit Breaker	373
5.6.9	Noise Filter	374
5.6.10	Magnetic Contactor	375
5.6.11	Surge Suppressor	376
5.6.12	Regenerative Unit	376
5.6.13	Variable Resistor for Speed Setting	379

CONTENTS

5.6.14	Encoder Signal Converter Unit	379
5.6.15	Cables for Connecting PC and Servopack	381
5.6.16	4CN Connector	385

CHAPTER 6 INSPECTION, MAINTENANCE, AND TROUBLESHOOTING . 387

6.1	Inspection and Maintenance	388
6.1.1	Servomotor	388
6.1.2	Servopack	389
6.1.3	Replacing Battery for Absolute Encoder	390
6.2	Troubleshooting	391
6.2.1	Troubleshooting Problems with Alarm Display	391
6.2.2	Troubleshooting Problems with No Alarm Display	409
6.2.3	Internal Connection Diagram and Instrument Connection Examples	411

CHAPTER 7 MEASURES TO SATISFY THE REQUIREMENTS OF EMC DIRECTIVE 415

7.1	What is European Safe Standard?	416
7.1.1	What is EN Standard?	416
7.1.2	What is CE Marking?	416
7.1.3	EMC Directive	417
7.1.4	Certification Body TÜV Authorized by EU	417
7.2	Measures to Satisfy the Requirements of EMC Directive	418
7.2.1	Applicable Servomotor	418
7.2.2	Applicable Noise Filter	418
7.2.3	Motor Cables	419
7.2.4	Encoder Cables	419
7.2.5	Control I/O	420
7.2.6	Digital Operator and Monitoring by Personal Computer	420
7.2.7	The Core on the Cable	421
7.2.8	Wiring	421

APPENDIXES

A	Differences Between DR2 and DR1, SGDA and SGD Servopacks	423
B	Servo Adjustment	429
B.1	Σ -Series AC Servopack Gain Adjustment	430
B.1.1	Σ -Series AC Servopacks and Gain Adjustment Methods	430
B.1.2	Basic Rules for Gain Adjustment	431
B.2	Adjusting a Servopack for Speed Control	432
B.2.1	Adjusting Using Auto-tuning	432
B.2.2	Manual Adjustment	433
B.3	Adjusting a Servopack for Position Control	436
B.3.1	Adjusting Using Auto-tuning	436
B.3.2	Manual Adjustment	437
B.4	Gain Setting References	441
B.4.1	Guidelines for Gain Settings According to Load Inertia Ratio	441
C	List of I/O Signals	445
D	List of User Constants	465

CONTENTS

E	List of Alarm Displays	477
F	Relationship between Reference Forms and User Constants	481
G	Reviewing the Full-closed Loop Specifications	489

INDEX	497
--------------------	------------

FOR FIRST-TIME USERS OF AC SERVOS

1

1

This chapter is intended for first-time users of AC servos. It describes the basic configuration of a servo mechanism and basic technical terms relating to servos.

Users who already have experience in using a servo should also take a look at this chapter to understand the features of Σ -Series AC Servos.

1.1 Basic Understanding of AC Servos	2
1.1.1 Servo Mechanisms	2
1.1.2 Servo Configuration	5
1.1.3 Features of Σ -Series Servos	11

1.1 Basic Understanding of AC Servos

This section describes the basic configuration of a servo mechanism and technical terms relating to servos and also explains the features of Σ-Series AC Servos.

1.1.1	Servo Mechanisms	2
1.1.2	Servo Configuration	5
1.1.3	Features of Σ-Series Servos	11

1.1.1 Servo Mechanisms

You may be familiar with the following terms:

- Servo
- **Servo mechanism**
- Servo control system

In fact, these terms are synonymous. They have the following meaning:

A control mechanism that monitors physical quantities such as specified positions.

In short, a servo mechanism is like a servant who does tasks faithfully and quickly according to his master's instructions. In fact, "servo" originally derives from the word "servant."



Servo mechanism

According to Japanese Industrial Standard (JIS) terminology, a "servo mechanism" is defined as a mechanism that uses the position, direction, or orientation of an object as a process variable to control a system to follow any changes in a target value (set point). More simply, a servo mechanism is a control mechanism that monitors physical quantities such as specified positions. Feedback control is normally performed by a servo mechanism. (Source: JIS B0181)

Servo system could be defined in more detail as a mechanism that:

- Moves at a specified speed and
- Locates an object in a specified position

To develop such a servo system, an automatic control system involving **feedback control** must be designed. This automatic control system can be illustrated in the following block diagram:

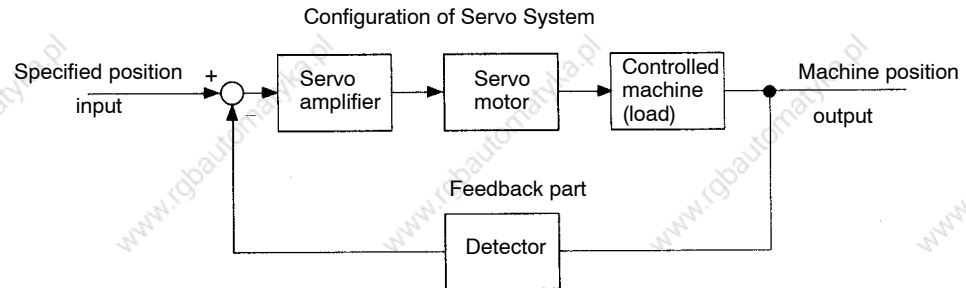

This servo system is an automatic control system that detects the machine position (output data), feeds back the data to the input side, compares it with the specified position (input data), and moves the machine by the difference between the compared data.

In other words, the servo system is a system to control the output data to match the specified input data.

If, for example, the specified position changes, the servo system will reflect the changes.

In the above example, input data is defined as a position, but input data can be any physical quantities such as orientation (angle), water pressure, or voltage.

Position, speed, force (torque), electric current, and so on are typical controlled values for a servo system.

The main technical terms used in this manual are as follows:

- 1) Servo mechanism
- 2) Servo

Normally, servo is synonymous with servo mechanism. However, because “mechanism” is omitted, the meaning becomes somewhat ambiguous. Servo may refer to the entire servo mechanism but may also refer to an integral part of a servo mechanism such as a servomotor or a servo amplifier. This manual also follows this convention in the use of the term “servo”.



Feedback control

A control that returns process variables to the input side and forms a closed loop. It is also called closed-loop control.

3) Servo control system

Servo control system is almost synonymous with servo mechanism but places the focus on system control. In this manual, the term “servo system” is also used as a synonym of servo control system.

Related Terms	Meaning
Servomotor	General servomotors or Yaskawa SGM/SGMP Servomotors. In some cases, a position detector (encoder) is included in a servomotor.
Servopack	Trademark of Yaskawa servo amplifier “DR2 Servopack.”
Servo drive	A Servomotor and amplifier pair. Also called “servo.”
Servo system	A closed control system consisting of a host controller, servo drive and controlled system to form a servo mechanism.

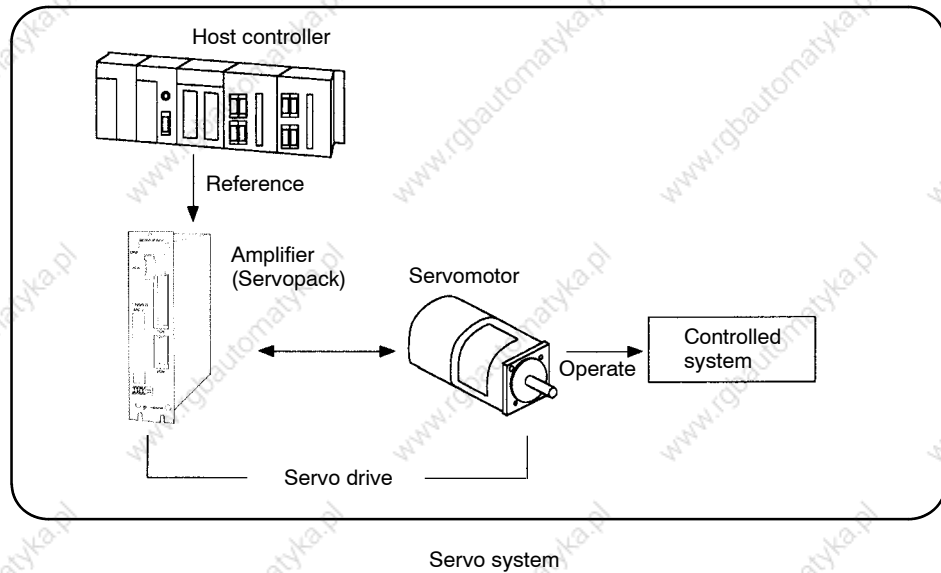

1.1.2 Servo Configuration

1) Configuration of Servo System

The following diagram illustrates a servo system in detail:

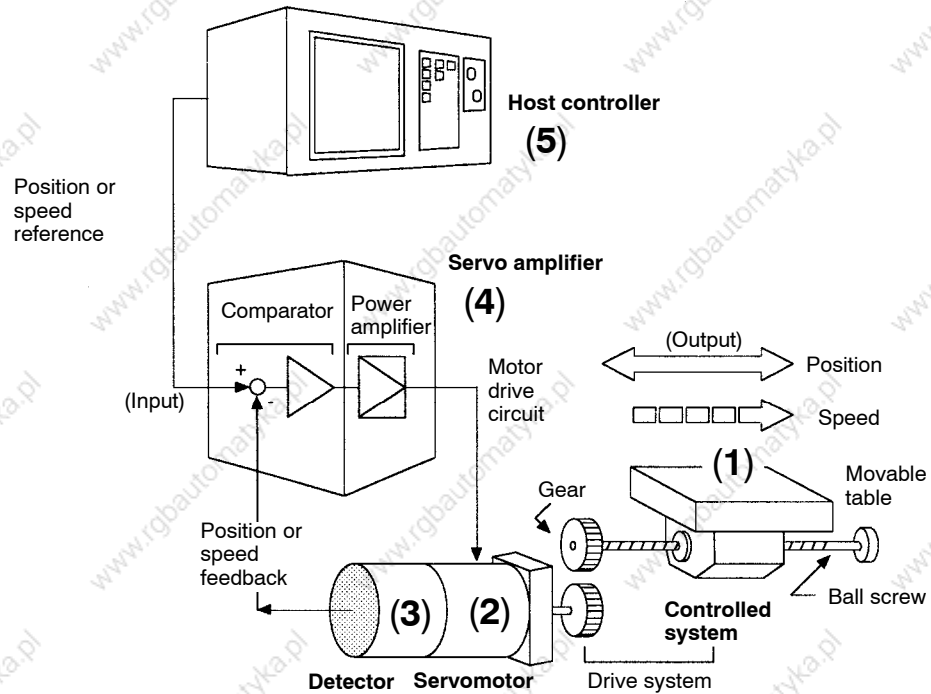

- (1) **Controlled system:** Mechanical system for which the position or speed is to be controlled. This includes a drive system that transmits torque from a servomotor.
- (2) **Servomotor:** A main actuator that moves a controlled system. Two types are available: AC servomotor and DC servomotor.
- (3) **Detector:** A position or speed detector. Normally, an encoder mounted on a motor is used as a position detector.
- (4) **Servo amplifier:** An amplifier that processes an error signal to correct the difference between a reference and feedback data and operates the servomotor accordingly. A servo amplifier consists of a comparator, which processes error signals, and a power amplifier, which operates the servomotor.
- (5) **Host controller:** A device that controls a servo amplifier by specifying a position or speed as a set point.

Servo components (1) to (5) are outlined below:

(1) Controlled system

In the previous figure, the controlled system is a movable table for which the position or speed is controlled. The movable table is driven by a ball screw and is connected to the servomotor via gears.

So, the **drive system** consists of:

Gears + Ball Screw

This drive system is most commonly used because the power transmission ratio (gear ratio) can be freely set to ensure high positioning accuracy. However, play in the gears must be minimized.

The following drive system is also possible when the controlled system is a movable table:

Coupling + Ball Screw

When the power transmission ratio is 1 : 1, a coupling is useful because it has no play.

This drive system is widely used for machining tools.

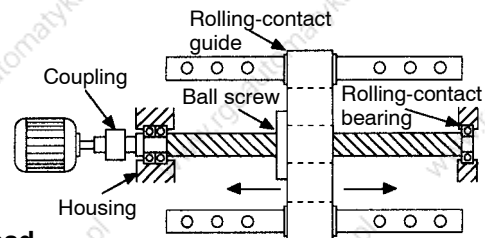

Timing Belt + Trapezoidal Screw Thread

A timing belt is a coupling device that allows the power transmission ratio to be set freely and that has no play.

A trapezoidal screw thread does not provide excellent positioning accuracy, so can be treated as a minor coupling device.

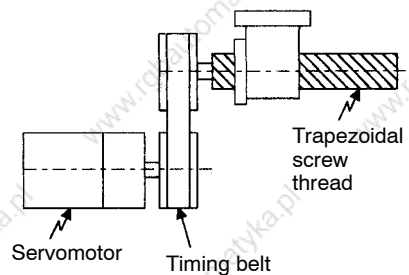

To develop an excellent servo system, it is important to select a rigid drive system that has no play.

Configure the controlled system by using an appropriate drive system for the control purpose.



Drive system

Also called a drive mechanism.

A drive system connects an actuator (such as a servomotor) to a controlled system and serves as a mechanical control component that transmits torque to the controlled system, orientates the controlled system, and converts motion from rotation to linear motion and vice versa.

(2) Servomotor

(a) DC Servomotor and AC Servomotor

Servomotors are divided into two types: DC servomotors and AC servomotors.

DC servomotors are driven by direct current (DC). They have a long history. Up until the 1980s, the term “servomotor” used to imply a DC servomotor.

From 1984, AC servomotors were emerging as a result of rapid progress in micro-processor technology. Driven by alternating current (AC), AC servomotors are now widely used because of the following advantages:

- Easy maintenance: No brush
- High speed: No limitation in rectification rate

Note however that servomotors and Servopacks use some parts that are subject to mechanical wear or aging. For preventive maintenance, inspect and replace parts at regular intervals.

For details, refer to *Chapter 6 Inspection, Maintenance, and Troubleshooting*.

(b) AC Servomotor

AC servomotors are divided into two types: synchronous type and induction type. The synchronous type is more commonly used.

For a synchronous type servomotor, motor speed is controlled by changing the frequency of alternating current.

A synchronous type servomotor provides strong holding torque when stopped, so this type is ideal when precise positioning is required. Use this type for a servo mechanism for position control.

The following figure illustrates the structure of a synchronous type servomotor:

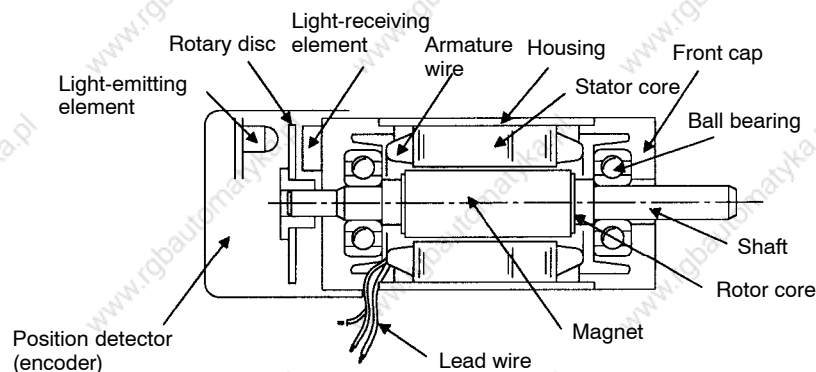

Yaskawa SGM and SGMP Servomotors are of the synchronous type.

(c) Performance of Servomotor

A servomotor must have “instantaneous power” so that it can start as soon as a start reference is received.

The term “power rating (kW/s)” is used to represent instantaneous power. It refers to the electric power (kW) that a servomotor generates per second. The greater the power rating, the more powerful the servomotor.

(3) Detector

A servo system requires a position or speed detector. It uses an encoder mounted on a servomotor. Optical and magnetic detection methods are both available. Encoders are divided into the following two types:

(a) Incremental Encoder

An incremental encoder is a pulse generator, which generates a certain number of pulses per revolution (e.g., 2,000 pulses per revolution). If this encoder is connected to the mechanical system and one pulse is defined as a certain length (e.g., 0.001 mm), it can be used as a position detector.

However, this encoder does not detect an absolute position and merely outputs a pulse train. Hence zero return operation must be performed before positioning. The following figure illustrates the operation principle of a pulse generator (Optical method):

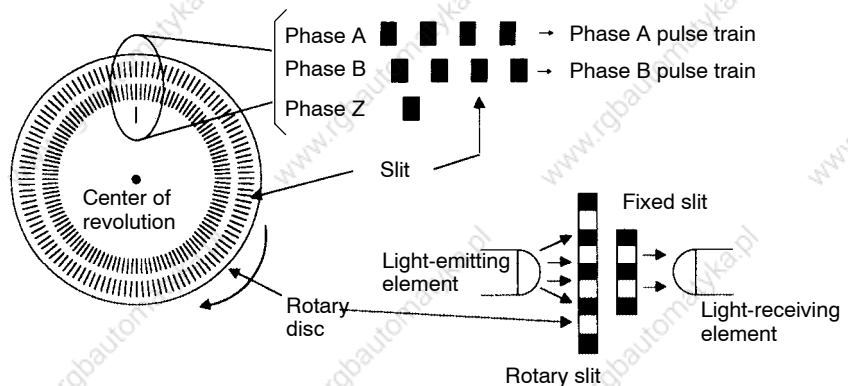

(b) Absolute Encoder

An absolute encoder is designed to detect an absolute angle of rotation as well as to perform the general functions of an incremental encoder. With an absolute encoder, therefore, it is possible to create a system that does not require zero return operation at the beginning of each operation.

- Difference between an absolute and incremental encoder:
An absolute encoder will keep track of the motor shaft position even if system power is lost and some motion occurs during that period of time. The incremental encoder is incapable of the above.

(4) Servo amplifier

A servo amplifier is required to operate an AC servomotor.

The following figure illustrates the configuration of a servo amplifier:

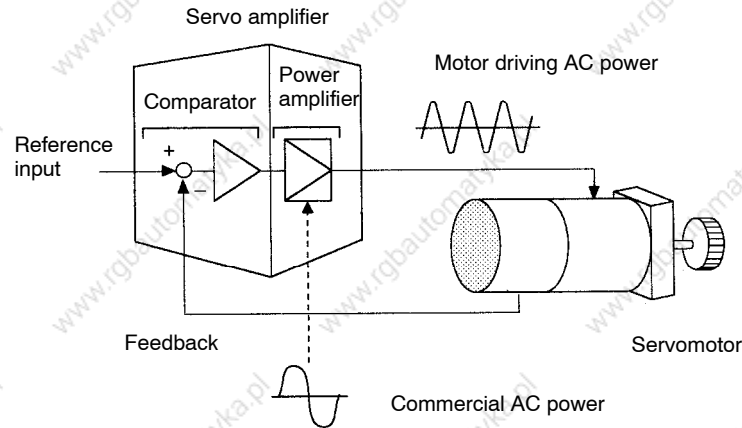

A servo amplifier consists of the following two sections:

(a) Comparator

A comparator consists of a comparison function and a control function. The comparison function compares reference input (position or speed) with a feedback signal and generates a differential signal.

The control function amplifies and transforms the differential signal. In other words, it performs proportional (P) control or **proportional/integral (PI) control**. (It is not important if you do not understand these control terms completely at this point.)

(b) Power Amplifier

A power amplifier runs the servomotor at a speed or torque proportional to the output of the comparator. In other words, from the commercial power supply of 50/60 Hz, it generates alternating current with a frequency proportional to the reference speed and runs the servomotor with this current.

**Proportional/integral (PI) control**

PI control provides more accurate position or speed control than proportional control, which is more commonly used.

(5) Host Controller

A host controller controls a servo amplifier by specifying a position or speed as a set point.

For speed reference, a position control loop may be formed in the host controller when a position feedback signal is received. Yaskawa **PROGIC-8** is a typical host controller.



PROGIC-8

A programmable machine controller. If combined with a servo amplifier for speed control (maximum eight axis control), the PROGIC-8 can provide position control. The PROGIC-8 also provides programmable controller functions.

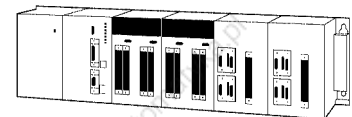

1.1.3 Features of Σ -Series Servos

1) Σ -Series SGM/SGMP Servomotors are synchronous type servomotors and have the following features:

- Size and weight reduced to one-third those of our conventional models.
Compact Servomotor for saving installation space.
- Servo performance (power rating) enhanced to three times that of our conventional models.
Enhanced **power rating (kW/s)** to satisfy every need.
- A wide product range covering rated output of 30 W to 750 W.

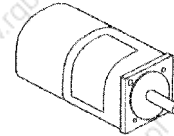

SGM type

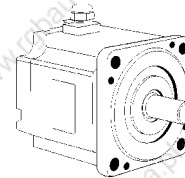

SGMP type

Supply Voltage	Rated Output
100 VAC:	30 W, 50 W, 100 W, 200 W, 300 W (0.04 HP, 0.07 HP, 0.13 HP, 0.27 HP, 0.40 HP)
200 VAC:	30 W, 50 W, 100 W, 200 W, 400 W, 750 W (0.04 HP, 0.07 HP, 0.13 HP, 0.27 HP, 0.53 HP, 1.01 HP)

2) DR2 Servopacks can perform speed/torque or position control. Select the control mode by setting of the user constant Cn-02 (memory switch).

- Speed/Torque Control Mode: User constant Cn-02 (memory switch) Bit B = 0
This mode uses speed or torque reference input. Reference input is by analog voltage.
- Position Control Mode: User constant Cn-02 (memory switch) Bit B = 1
This mode uses position reference input. Reference input is by pulse train.

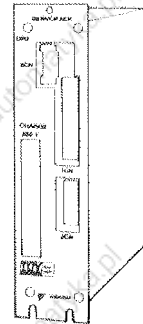

DR2 Servopack



Power rating (kW/s)

A constant that represents response performance of a servomotor. It can be determined by dividing squared rated torque by motor inertia. Power rating is the electric power (kW) that a servomotor can generate per second.

The greater the power rating, the more powerful the servomotor.

3) The most common usage of a speed/torque control Servopack is shown below:

- Using Servopack in Speed/Torque Control Mode (Speed Control)

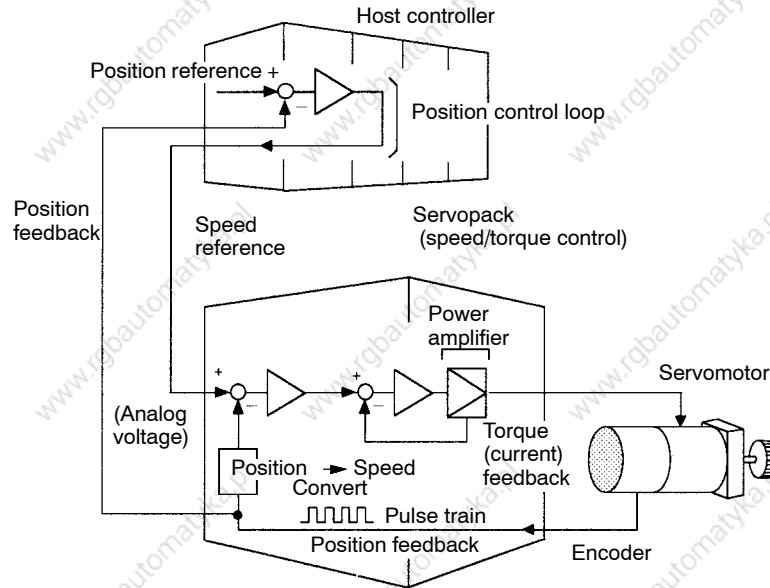

As shown in the figure above, a position control loop is formed in the host controller. The host controller compares a position reference with a position feedback signal and sends processing results to the Servopack as a speed reference.

In this way, the host controller can freely perform the control required for the servo mechanism.

The Servopack undertakes the speed control loop and subsequent control processing.

Yaskawa programmable machine controller PROGIC-8 is available as a typical host controller.

4) Speed/torque control Servopack can also provide torque control as shown below.

- Using Servopack in Speed/Torque Control Mode (Torque Control)

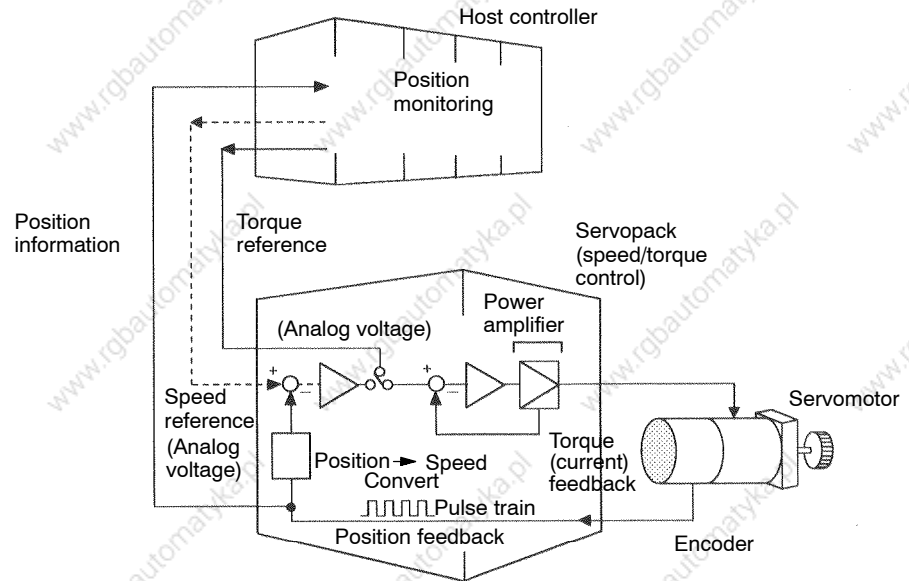

Set the user constants for Servopack to switch between the following torque control modes:

- (1) Controlling servomotor torque by torque reference (Torque control I)
- (2) Operating servomotor by switching between torque reference and speed reference (Torque control II)

The host controller outputs a torque reference or speed reference to control the Servopack.

It also receives a pulse train (position information) from the Servopack and uses it to monitor the position.

5) Position control Servopack can be used as below.

- Using Servopack in Position Control Mode

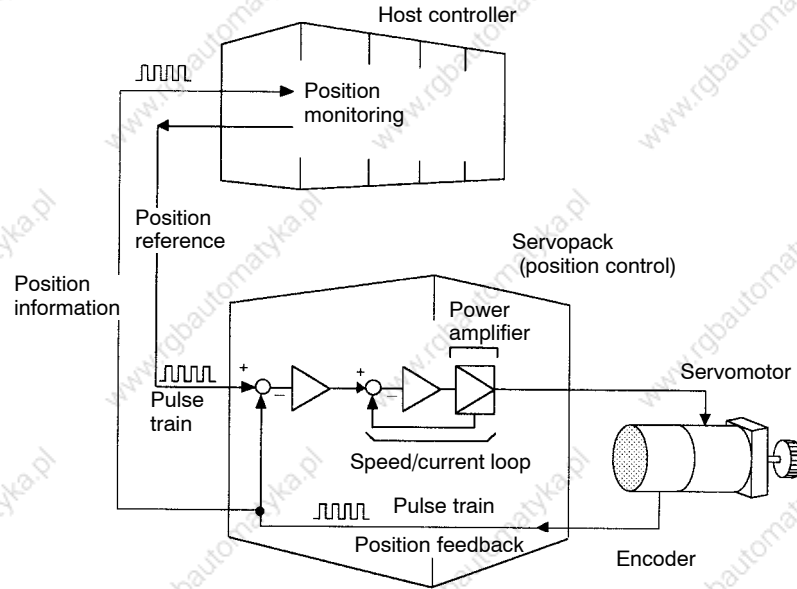

The host controller can send a position reference (pulse train) to the Servopack to perform positioning or interpolation. This type of Servopack contains a position control loop.

User constants can be used to select either of the following pulse trains:

- (1) Code and pulse train
- (2) Two-phase pulse train with 90° phase difference
- (3) Forward and reverse pulse trains

The host controller receives a pulse train (position information) from the Servopack and uses it to monitor the position.

6) A Digital Operator can be used to set user constants for a Servopack as follows:

- (1) Setting user constants to enable or disable each function
- (2) Setting user constants required for functions to be used

Set user constants according to the servo system to be set up.

BASIC USES OF Σ -SERIES PRODUCTS

2

This chapter describes the first things to do when Σ -Series products are delivered. It also explains the most fundamental ways of connecting and operating Σ -Series products. Both first-time and experienced servo users **must read** this chapter.

2.1	Precautions	16
2.1.1	Notes on Use	16
2.2	Installation	18
2.2.1	Checking on Delivery	18
2.2.2	Installing the Servomotor	19
2.2.3	Installing the Servopack	22
2.3	Connection and Wiring	25
2.3.1	Connecting to Peripheral Devices	25
2.3.2	Main Circuit Wiring and Power ON Sequence	28
2.3.3	Examples of Connecting I/O Signal Terminals	30
2.4	Conducting a Test Run	37
2.4.1	Test Run in Two Steps	37
2.4.2	Step 1: Conducting a Test Run for Motor without Load	39
2.4.3	Step 2: Conducting a Test Run with the Motor Connected to the Machine	43
2.4.4	Supplementary Information on Test Run	45
2.4.5	Minimum User Constants Required and Input Signals	47

2.1 Precautions

This section provides notes on using Σ-Series products.

2.1.1 Notes on Use 16

2.1.1 Notes on Use

NOTE Always note the following to ensure safe use.

Two types of supply voltage are available, 100 V and 200 V.

Both Σ-Series Servomotor and Servopack have 100 V and 200 V types. Be sure to use the correct type.

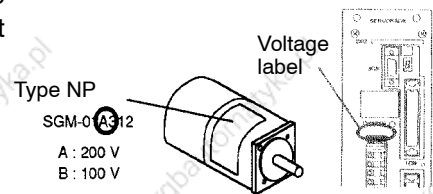

Always use the SGM/SGMP Servomotor and DR2 Servopack in pairs.

The SGM/SGMP Servomotor cannot run without the DR2 Servopack. Do not plug the SGM Servomotor directly into the commercial power supply. (Direct connection to the commercial power supply will damage the Servomotor.)

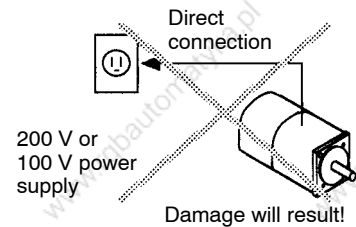

Do not change wiring when power is ON.

Always turn the power OFF before connecting or disconnecting a connector. (Except for Digital Operator (Type: JUSP-OP02A-1))

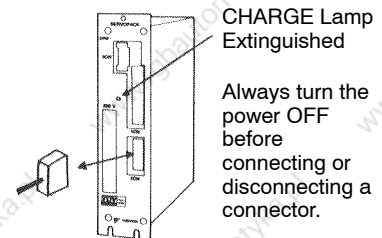

Note that residual voltage still remains in the Servopack even after the power is turned OFF.

Even after the power is turned OFF, residual voltage still remains in the capacitor inside the Servopack. Before inspection is to be performed, make sure if CHARGE lamp is extinguished.

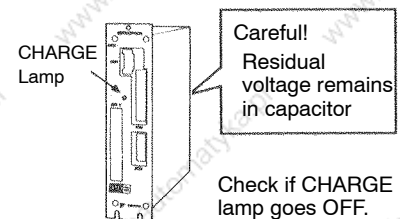

Always follow the specified installation method.

The Servopack generates heat. Install the Servopack so that it can radiate heat freely. Note also that the Servopack must be in an environment free from condensation, vibration and shock.

Provide sufficient clearance

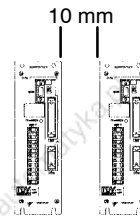

Ambient temperature: 0 to 55°C

Perform noise reduction and grounding properly.

If the signal line is noisy, vibration or malfunction will result.

- Separate high-voltage cables from low-voltage cables.
- Use cables as short as possible.
- Use at least class 3 grounding (ground resistance 100Ω or below) for the Servomotor and Servopack.
- Never use a line filter for the power supply in the motor circuit.

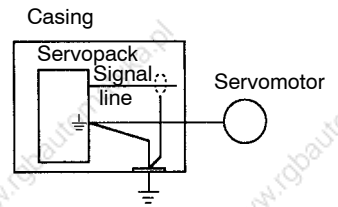

2

Conduct a voltage resistance test under the following conditions.

- Voltage: 1500 Vrms AC, one minute
- Braking current: 30 mA
- Frequency: 50/60 Hz
- Voltage applied point: Between L1, L2, L, N, +, -, Y3, Y4, U, V, W terminals and ground terminal ⊕ (connect between terminals securely.)



Conduct a voltage resistance test as described on the left.

Use a fast-response type ground-fault detector.

For a ground-fault detector, always use a fast-response type or one designed for PWM inverters. Do not use a time-delay type.

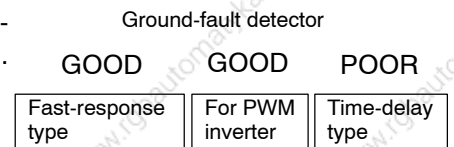

Do not perform continuous operation under overhanging load.

Continuous operation cannot be performed by rotating the motor from the load and applying regenerative braking. Regenerative braking by the Servopack can be applied only for a short period, such as the motor deceleration time.

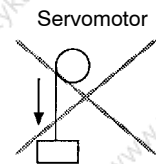

Regenerative braking continuously applied

The Servomotor cannot be operated by turning the power ON and OFF.

Frequently turning the power ON and OFF causes the internal circuit elements to deteriorate. Always start or stop the servomotor by using reference pulses.

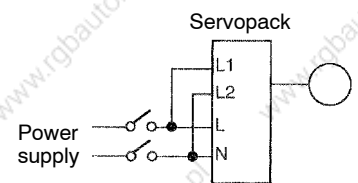

Starting and stopping by turning power ON and OFF

2.2 Installation

This section describes how to check Σ -Series products on delivery and how to install them.

2.2.1	Checking on Delivery	18
2.2.2	Installing the Servomotor	19
2.2.3	Installing the Servopack	22

2.2.1 Checking on Delivery

1) When Σ -Series products are delivered, check the following items:

Check Items	Remarks
Check if the delivered products are the ones you ordered.	Check the types marked on the nameplates of Servomotor and Servopack (see the table below).
Check if the motor shaft rotates smoothly.	If the motor shaft is smoothly turned by hand, it is normal. However, if the motor has brakes, it cannot be turned manually.
Check for damage.	Check the overall appearance, and check for damage or scratches resulting from transportation.
Check screws for looseness.	Check for looseness by using a screwdriver as necessary.

If any of the above items are faulty or incorrect, contact the dealer from which you purchased the products or your nearest local sales representative.

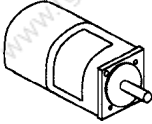
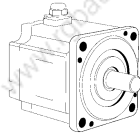
Appearance	Nameplate	Type
 <p>Σ-Series SGM Servomotor</p>  <p>Σ-Series SGMP Servomotor</p>	<p>Rated output</p> <p>Servomotor type</p> <p>Rated current</p> <p>Rated torque</p> <p>AC SERVO MOTOR SGM-02A312</p> <p>W 200 N·m 0.637 2.0</p> <p>r/min 3000 1995.06</p> <p>S/N 598022-1-3</p> <p>YASKAWA ELECTRIC CORPORATION JAPAN</p> <p>Serial number</p> <p>Manufacturing date</p> <p>Rated rotation speed</p>	<p>SGM-01A312</p> <p>Σ-Series SGM: SGM Servomotor SGMP: SGM Servomotor</p> <p>Rated Output A3:0.04HP A5:0.07HP 01:0.13HP 02:0.27HP 03:0.40HP 04:0.53HP 08:1.01HP</p> <p>Power supply A:200V B:100V</p> <p>Encoder specifications 3: 2048P/R incremental encoder W: 12-bit absolute encoder</p> <p>Design revision order</p> <p>Shaft specifications 2: Straight without key 4: Straight with key</p> <p>Option B: With brake S: With oil seal D: With brake and oil seal P: Drip-proof provision</p>

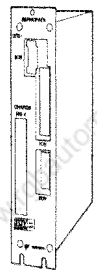
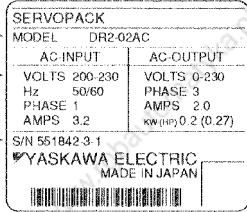
Appearance	Nameplate	Type
 <p>Servo-pack</p> <p>Σ-Series DR2 Servopack</p>	<p>Servopack type</p>  <p>Serial number</p> <p>Output power voltage</p> <p>Applicable power supply</p>	<p>DR2-01ACP-F</p> <p>Σ-Series DR2 Servopack</p> <p>Rated Output A3:0.04HP A5:0.07HP 01:0.13HP 02:0.27HP 03:0.40HP 04:0.53HP 08:1.01HP</p> <p>Power Supply</p> <p>Type C: Incremental/absolute encoder available</p> <p>Applicable motor Blank: SGM Servomotor P: SGMP Servomotor</p> <p>Option Blank: Semi-closed loop (standard) P: Full-closed loop</p>

2.2.2 Installing the Servomotor

Servomotor SGM and SGMP types can be installed either horizontally or vertically. However, if the Servomotor is installed incorrectly or in an inappropriate location, the service life will be shortened or unexpected problems will occur. To prevent this, always observe the installation instructions described below.

Before installation:

Anticorrosive paint is coated on the edge of the motor shaft. Clean off the anticorrosive paint thoroughly using a cloth moistened with thinner.

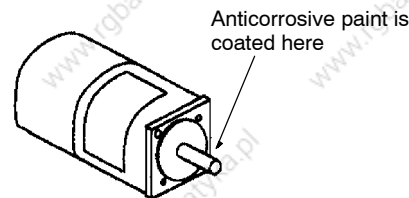

NOTE Avoid getting thinner on other parts of the Servomotor when cleaning the shaft.

Storage:

When the Servomotor is to be stored with the power cable disconnected, store it in the following temperature range:

Between -20°C and 60°C

Installation sites:

The Servomotor SGM and SGMP types are designed for indoor use. Install Servomotor in an environment which meets the following conditions:

- a) Free from corrosive and explosive gases
- b) Well-ventilated and free from dust and moisture
- c) Ambient temperature of 0 to 40°C
- d) Relative humidity of 20% to 80% (non-condensing)
- e) Inspection and cleaning can be performed easily

If the Servomotor is used in a location subject to water or oil mist, install a shield cover over the Servomotor.

Alignment:

Align the shaft of the Servomotor with that of the equipment to be controlled, then connect the shafts with couplings. Install the Servomotor so that alignment accuracy falls within the range shown below.

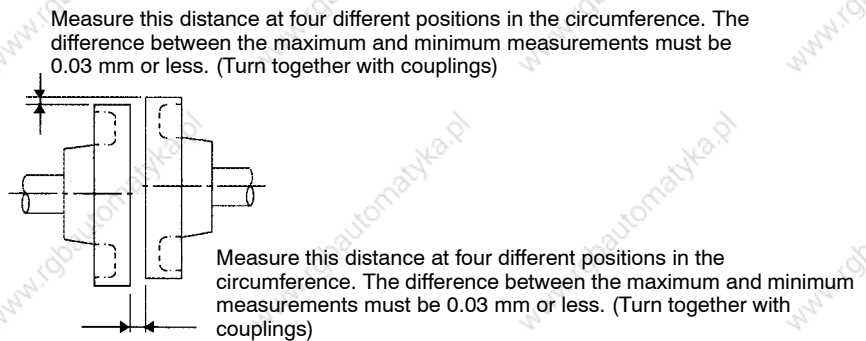

NOTE If the shafts are not aligned properly, vibration will occur, resulting in damage to the bearings.

Mechanical shock to the shaft end must be less than 98m/s² (10G) and must be applied no more than twice.

Design the mechanical system so that **thrust load and radial load** applied to the servomotor shaft end during operation falls within the range shown in the following table.



Thrust load and radial load

- 1. Thrust load: Shaft-end load applied parallel to the centerline of a shaft
- 2. Radial load: Shaft-end load applied perpendicular to the centerline of a shaft

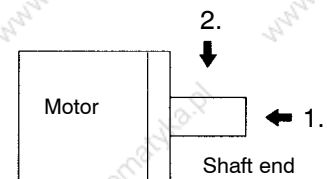

- Servomotor with incremental encoder

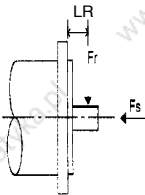
Motor Type	Allowable Radial Load Fr [N(lb)]	Allowable Thrust Load Fs [N(lb)]	LR mm (in.)	Reference Drawing
SGM-A3	68 (15)	54 (12)	20 (0.82)	
SGM-A5	68 (15)	54 (12)	20 (0.82)	
SGM-01	78 (17)	54 (12)	20 (0.82)	
SGM-02	245 (55)	74 (16)	25 (1.02)	
SGM-03	245 (55)	74 (16)	25 (1.02)	
SGM-04	245 (55)	74 (16)	25 (1.02)	
SGM-08	392 (88)	147 (33)	35 (1.43)	
SGMP-01	78 (17)	49 (11)	20 (0.82)	
SGMP-02	245 (55)	68 (15)	25 (1.02)	
SGMP-03	245 (55)	68 (15)	25 (1.02)	
SGMP-04	245 (55)	69 (15)	25 (1.02)	
SGMP-08	392 (88)	147 (33)	35 (1.43)	

- Servomotor with absolute encoder

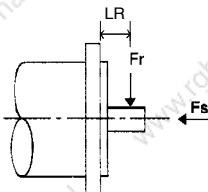
Motor Type	Allowable Radial Load Fr [N(lb)]	Allowable Thrust Load Fs [N(lb)]	LR mm (in.)	Reference Drawing
SGM-A3	49 (11)	19 (4)	20 (0.82)	
SGM-A5	68 (15)	19 (4)	20 (0.82)	
SGM-01	68 (15)	19 (4)	20 (0.82)	
SGM-02	196 (44)	49 (11)	25 (1.02)	
SGM-03	196 (44)	49 (11)	25 (1.02)	
SGM-04	196 (44)	68 (15)	25 (1.02)	
SGM-08	343 (77)	98 (22)	35 (1.43)	
SGMP-01	78 (17)	49 (11)	20 (0.82)	
SGMP-02	245 (55)	68 (15)	25 (1.02)	
SGMP-03	245 (55)	68 (15)	25 (1.02)	
SGMP-04	245 (55)	69 (15)	25 (1.02)	
SGMP-08	392 (88)	147 (33)	35 (1.43)	

Note The radial load and thrust load values shown above are the maximum allowed values for the sum of the load generated by motor torque and the load externally applied to the shaft.

2.2.3 Installing the Servopack

Σ-Series DR2 Servopack is a rack-mounted type servo controller.

Incorrect installation will cause problems. Always observe the installation instructions described in the next page.

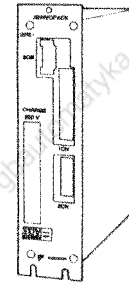

DR2 Servopack

Storage:

When the Servopack is to be stored with the power cable disconnected, store it in the following temperature range:

Between -20°C and 85°C

Installation sites:

Situation	Notes on Installation
When installed in a control panel	Design the control panel size, unit layout, and cooling method so that the temperature around the periphery of the Servopack does not exceed 55°C .
When installed near a heating unit	Suppress radiation heat from the heating unit and a temperature rise caused by convection so that the temperature around the periphery of the Servopack does not exceed 55°C .
When installed near a source of vibration	Install a vibration isolator underneath the Servopack to prevent it from receiving vibration.
When installed in a place receiving corrosive gases	Corrosive gases do not immediately affect the Servopack but will eventually cause contactor-related devices to malfunction. Take appropriate action to prevent corrosive gases.
Others	Avoid installation in a hot and humid place or where excessive dust or iron powder is present in the air.

Orientation:

Install the Servopack perpendicularly as shown in the figure.

The Servopack must be orientated as shown in the figure because it is designed to be cooled by natural convection.

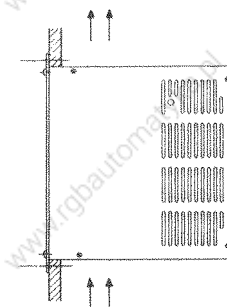

Ventilation

- Firmly secure the Servopack through three or four mounting holes.

Installation method:

When installing multiple Servopacks side by side in a control panel, observe the following installation method:

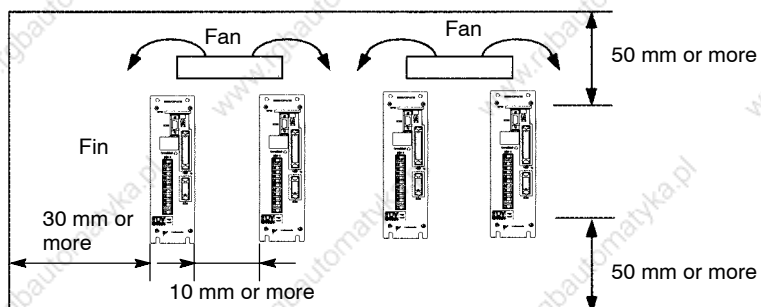

- a) Install Servopack perpendicularly so that the front panel (containing connectors) faces outward.
- b) Provide sufficient space around each Servopack to allow cooling by natural convection.

BASIC USES OF Σ-SERIES PRODUCTS

2.2.3 Installing the Servopack cont.

- c) When installing Servopacks side by side, provide at least 10 mm space between them and at least 50 mm space above and below them as shown in the figure above. Install cooling fans above the Servopacks to prevent the temperature around each Servopack from increasing excessively and also to maintain the temperature inside the control panel evenly.
- d) Maintain the following conditions inside the control panel:
- Ambient temperature for Servopack: 0 to 55°C
 - Humidity: 90%RH or less
 - Vibration: 0.5G (4.9 m/s²)
 - Condensation and freezing: None
 - Ambient temperature to ensure long-term reliability: 45°C or less

2.3 Connection and Wiring

This section describes how to connect Σ -Series products to peripheral devices and explains a typical example of wiring the main circuit. It also describes an example of connecting to main host controllers.

2.3.1	Connecting to Peripheral Devices	25
2.3.2	Main Circuit Wiring and Power ON Sequence	28
2.3.3	Examples of Connecting I/O Signal Terminals	30

2.3.1 Connecting to Peripheral Devices

This section shows a standard example of connecting Σ -Series products to peripheral devices and briefly explains how to connect to each peripheral device.

NOTE Read the following notes before wiring:

- Connect only one cable to one terminal. Never connect two cables to one terminal.
- Do not solder the cable.
- Peel back the cable shield by about 10mm (0.39in.) min. Then insert the cable into the terminal securely and tighten the screw. Never leave the bare wires outside of the terminal.
- When the cable is inserted into the flat terminal, use the following ferrules.
Non-insulated ferrules, 2.5mm² or less (Made by PHOENIX CONTACT)

<Reference> Terminal block type: FRONT 2.5H/SA5
(Made by PHOENIX CONTACT)

Standard connection method for Σ -Series AC Servo Drives:

Molded-case circuit breaker (MCCB)

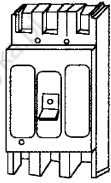

Used to protect power supply line. Shuts the circuit off when overcurrent is detected.

Noise filter

Used to eliminate external noise from power supply line.

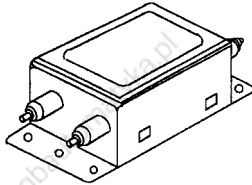

Note: The following noise filters do not conform to the EMC instructions. As for the noise filters conforming to EMC instructions, refer to 7.2.2.

Types: LF-205A (for DR2-A3A, A5A, 01A, 02A, A3B, A5B, and 01B)
 LF-210 (for DR2-04A and 02B)
 LF-220 (for DR2-03B and 08A)

Magnetic contactor

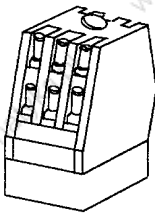

Turns the main power ON or OFF. Use a surge suppressor for the magnetic contactor.
 Type: HI-15E5 (30 A)

Brake power supply

Used for Servomotor with brake.

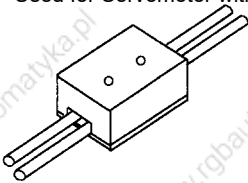

Types: LPSE-2H01 (for 200 V input)
 LPDE-1H01 (for 100 V input)

Regenerative unit

(For types DR2-A3A, A5A, 01A, 02A)

Type: JUSP-RG08 (Not applicable to types DR2-A3B, A5B, 01B)

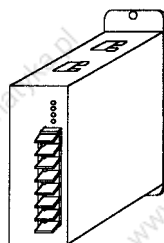

Exterior type regenerative resistor

Applicable to DR2-04ACY8, 08ACY8, 02BCY8, 03BCY8)

Digital Operator

Allows the user to set user constants or operation references and display operation status or alarm status.

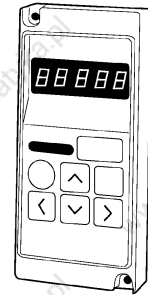

Hand-held type (JUSP-OP02A-1)
 1-meter(3.3ft.) cable included

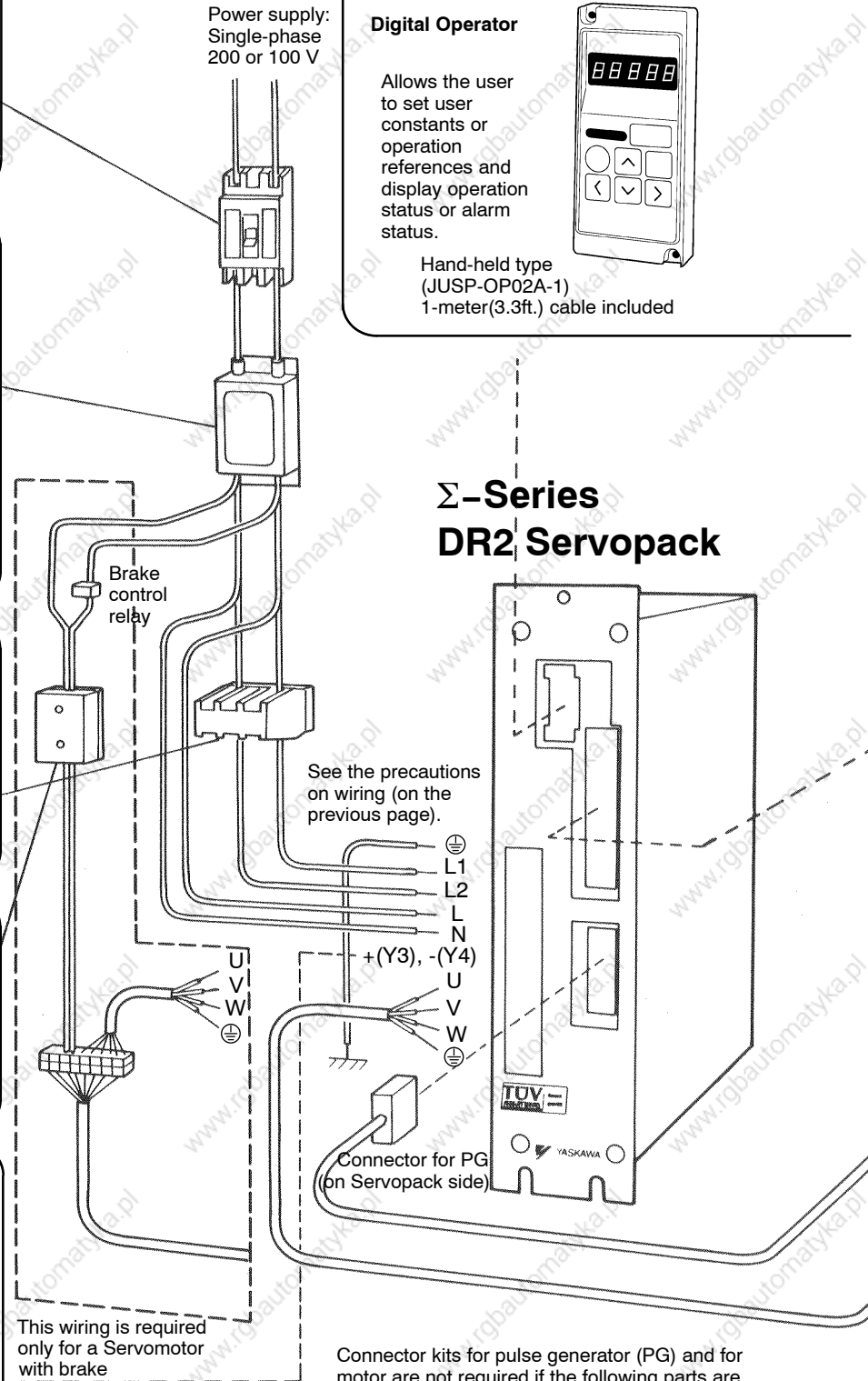

Σ -Series DR2 Servopack

Connector kits for pulse generator (PG) and for motor are not required if the following parts are ordered:

- Cable with terminal connectors
- Cable with connector and amplifier terminal

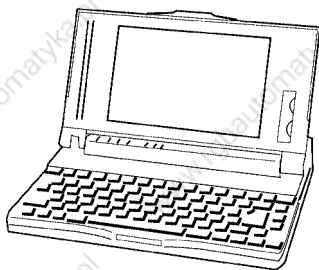

Personal computer

Exclusive-use cable between personal computer and Servopack (for NEC PC) is available. Type: DE9405258 (2m, 6.6ft.) consult factory about cable for IBM PC.

Host controller

Servopack is compatible with most P.L.C. motion controllers and indexers.

References are input as analog signals or pulse trains.

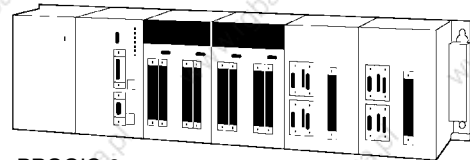

PROGIC-8

1CN connector kit (Type: DP9420010)



Cable for PG

This cable is used to connect a Servomotor encoder to a Servopack.

The following two types of cable are available according to the encoder type.

As for the PG cables conforming to EMC instructions, refer to 7.2.4.

- Cable for incremental encoder (with connector on both ends)

9.8ft: DP9320082-1	16.4ft: DP9320082-2
32.8ft: DP9320082-3	49.2ft: DP9320082-4
65.6ft: DP9320082-5	
- Cable for absolute encoder (with connectors on both ends)

9.8ft: DP9320084-1	16.4ft: DP9320084-2
32.8ft: DP9320084-3	49.2ft: DP9320084-4
65.6ft: DP9320084-5	

A cable with a single connector (without connector on Servopack side) and a cable without connectors are also available.

Connector kit for PG

On Servomotor side



On Servopack side



This connector kit is required for cables without connectors. For moving parts, a cable for robot must be ordered separately.

Connector for PG (on motor side)

Connector for motor

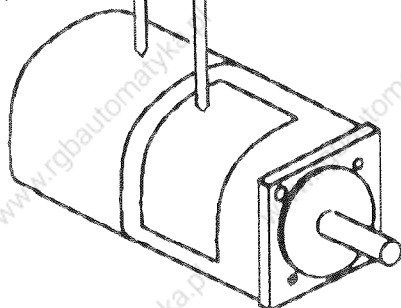

Σ-Series Servomotor

Cable for motor

This is a power cable for connecting a Servomotor to a Servopack.

For a Servomotor with brake, this cable is also used to wire the brake.

As for the motor cables conforming to EMC instructions, refer to 5.6.1.

- Without brake (connector included)

9.8ft: DP9320659-1	16.4ft: DP9320659-2
32.8ft: DP9320659-3	49.2ft: DP9320659-4
65.6ft: DP9320659-5	
- With brake (connector included)

9.8ft: DP9320660-1	16.4ft: DP9320660-2
32.8ft: DP9320660-3	49.2ft: DP9320660-4
65.6ft: DP9320660-5	

A cable without connector and spare solder is also available.

Connector kit for motor

Connector for motor (on motor side)



This connector kit is required for cables without connector and amplifier terminal.

2.3.2 Main Circuit Wiring and Power ON Sequence

1) The following diagram shows a typical example of wiring the main circuit for Σ-Series products:

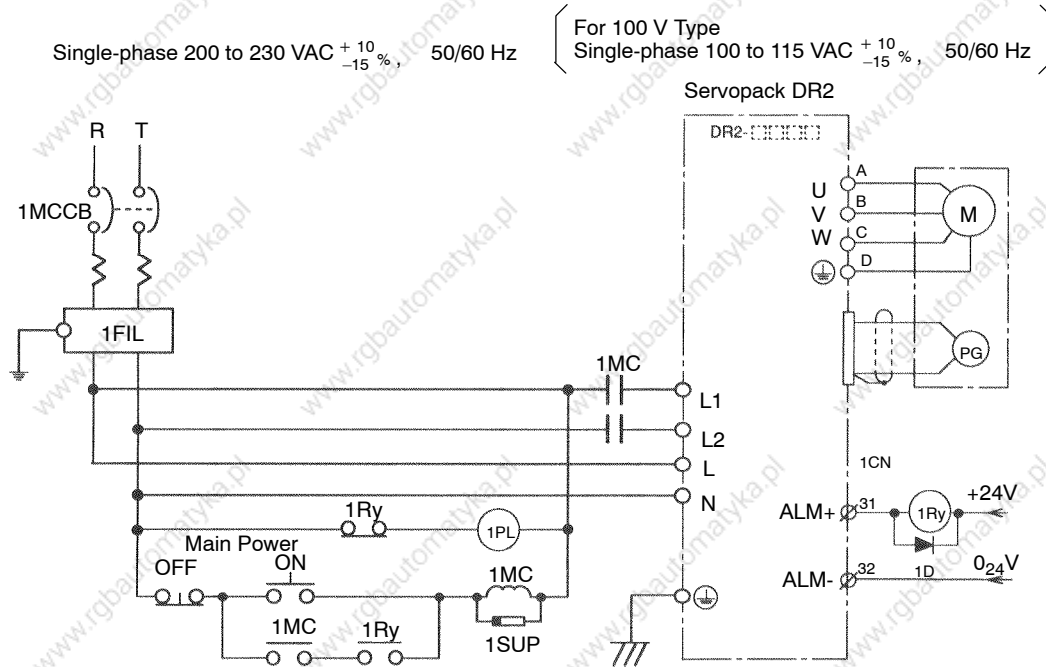

2) The following table shows the name and description of each main circuit terminal:

Terminal Symbol	Name	Description
L1, L2	Main circuit AC input	Single-phase 200 to 230 VAC $\pm 10\%$ / -15% , 50/60Hz*1
L, N	Control power supply input	Single-phase 200 to 230 VAC $\pm 10\%$ / -15% , 50/60Hz*1
U, V, W	Motor connection	Connects terminal U to motor terminal (red), V to (white) and W to (blue).
⊕ × 2	Ground terminal	Connects to ground and motor terminal (for ground and motor grounding)
Y3, Y4	Regenerative resistor connection	Regenerative resistor connection (External connection is not normally required.)*2
+, -	Regenerative unit connection	Regenerative unit connection terminal (Connection is not normally required.)*3

*1 For 100 V power supply: Single-phase 100 to 115 VAC $\pm 10\%$ / -15% , 50/60Hz

*2 Provided only for types 400W, 750W (200VAC) and 200W, 300W (100VAC).

*3 Provided only for types 30W to 200W (200VAC).

3) Form a power ON sequence as follows:

- a) Form a power ON sequence so that the main power is turned OFF when a servo alarm signal is output. (See the circuit diagram shown on the previous page.)
- b) Hold down the power ON push-button for at least two seconds. The Servopack outputs a servo alarm signal for approximately two seconds or less when the power is turned ON. This operation is required to initialize the Servopack.

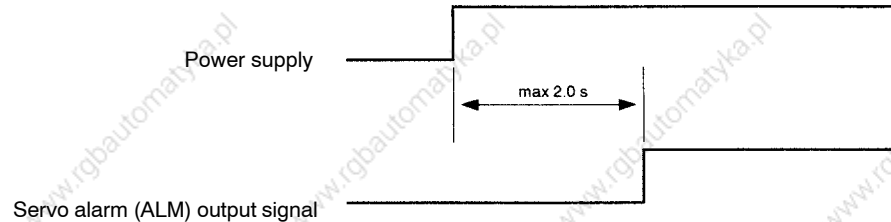

- NOTE**
- After turning the power OFF, do not touch the power terminals for 5 minutes. High voltage may remain in the Servopack.
 - Avoid frequently turning the power ON and OFF. Since the Servopack has a capacitor in the power supply, a high charging current flows (for 0.2 second) when the power is turned ON. Therefore, frequently turning the power ON and OFF causes the main power devices (such as capacitors and fuses) to deteriorate, resulting in unexpected problems.

2.3.3 Examples of Connecting I/O Signal Terminals

1) This sub-section provides typical examples of connecting to main host controllers. Connection to other host controllers is also possible. Connect to the host controller according to the connection examples shown below by referring to technical documentation for the host controller.

NOTE This sub-section describes signals related to the DR2 Servopack only. For other signals, refer to the relevant technical documentation.

2) Example of Connecting to PROGIC-8

2

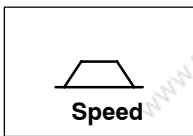

Servopack for Speed Control

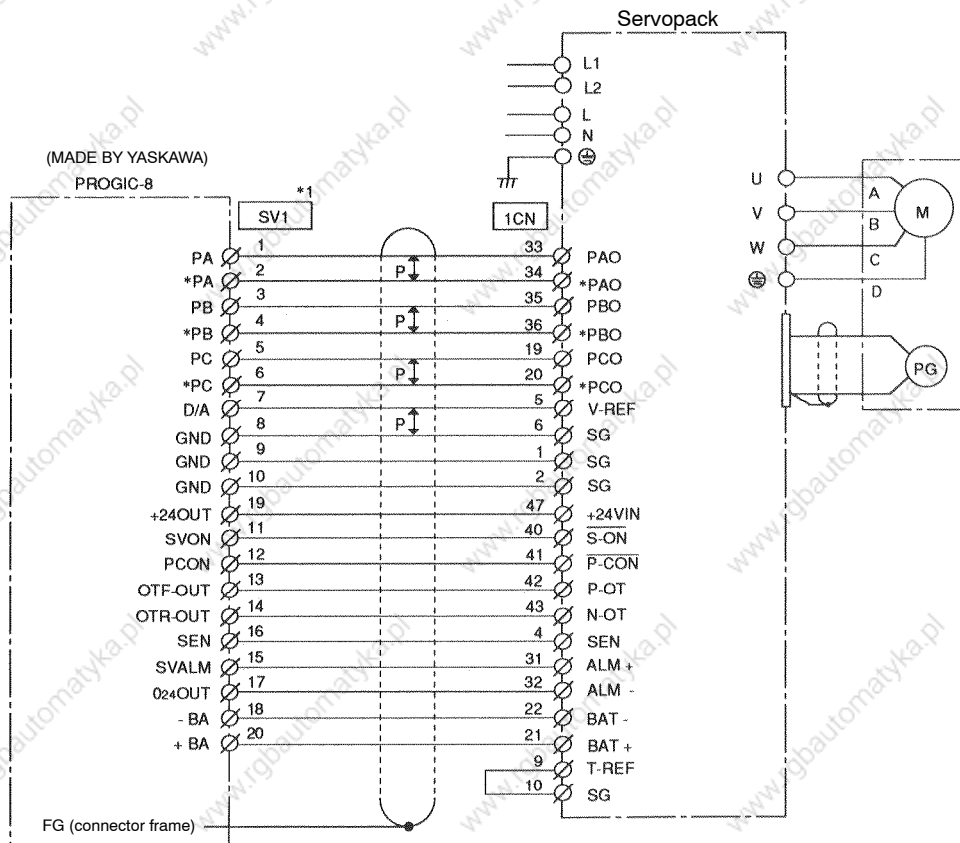

*1 These pin numbers are also applicable to SV2 to SV4.

*2 Do not change the standard settings of user constants for the Servopack.



Cable between PROGIC-8 and DR2 Servopack

- Type JEPMC – W5521 – 05 (1.6ft.)
- JEPMC – W5521 – 10 (3.3ft.)
- JEPMC – W5521 – 30 (9.8ft.)

3) Example of Connecting to GL-Series Positioning Module B2833

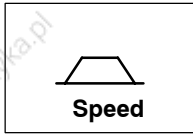

Servopack for Speed Control

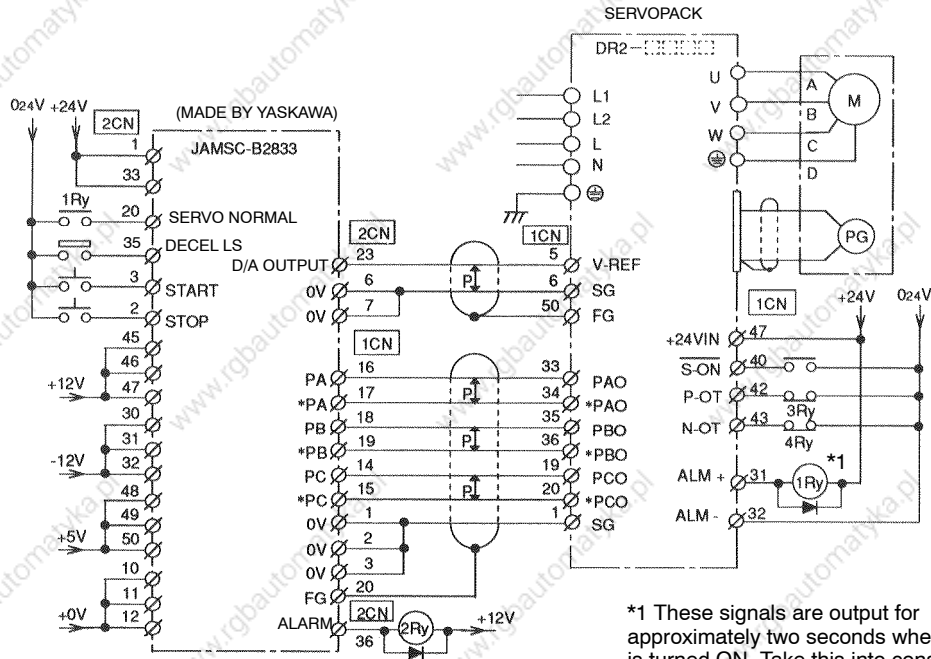

*1 These signals are output for approximately two seconds when the power is turned ON. Take this into consideration when designing a power ON sequence. Relay 1Ry is used to stop main circuit power supply to the Servopack.

BASIC USES OF Σ-SERIES PRODUCTS

2.3.3 Examples of Connecting I/O Signal Terminals cont.

4) Example of Connecting to GL-Series Positioning Module B2813

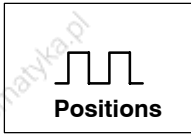

Servopack for Position Control

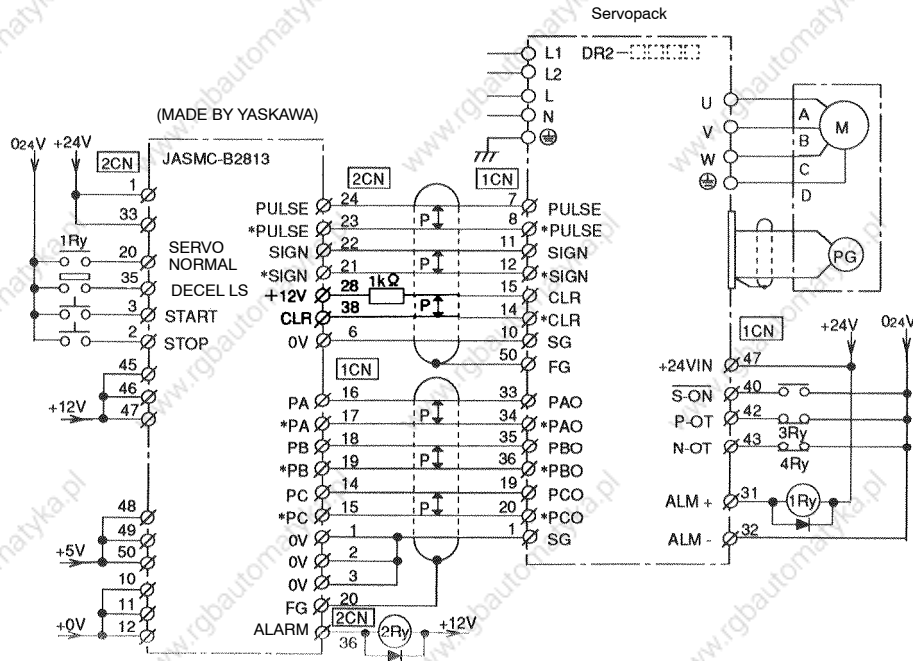

*1 These signals are output for approximately two seconds when the power is turned ON. Take this into consideration when designing a power ON sequence. Relay 1Ry is used to stop main circuit power supply to Servopack.

*2 Change the Cn-02 setting as follows:
 Bit No. 3 = 0
 Bit No. 4 = 0
 Bit No. 5 = 0
 Bit No. B = 1

*3 Pull up the CLR signal with 1 kΩ resistance.
 Change the Cn-02 setting as follows:
 Bit No. A = 1

5) Example of Connecting to OMRON Position Control Unit C500-NC222

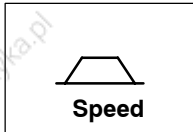

Servopack for Speed Control

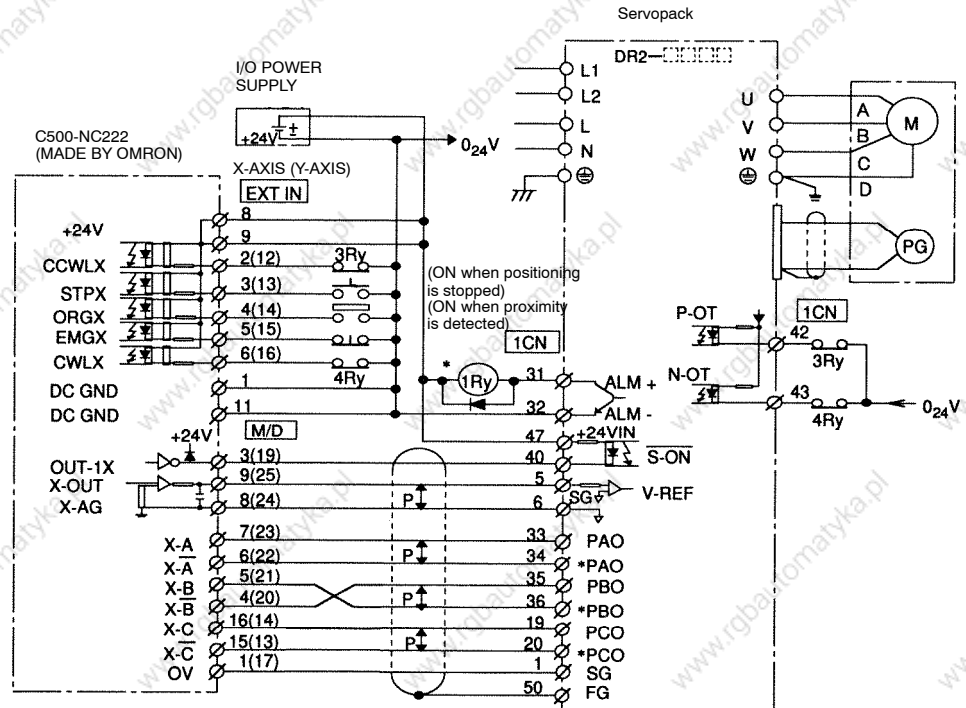

* These signals are output for approximately two seconds when the power is turned ON. Take this into consideration when designing a power ON sequence. Relay 1Ry is used to stop main circuit power supply to Servopack.

Note The signals shown here are applicable only to OMRON Sequencer C500-NC222 and Yaskawa Servopack DR2-□□□□.

BASIC USES OF Σ-SERIES PRODUCTS

2.3.3 Examples of Connecting I/O Signal Terminals cont.

6) Example of Connecting to OMRON Position Control Unit C500-NC112

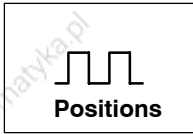

Servopack for Position Control

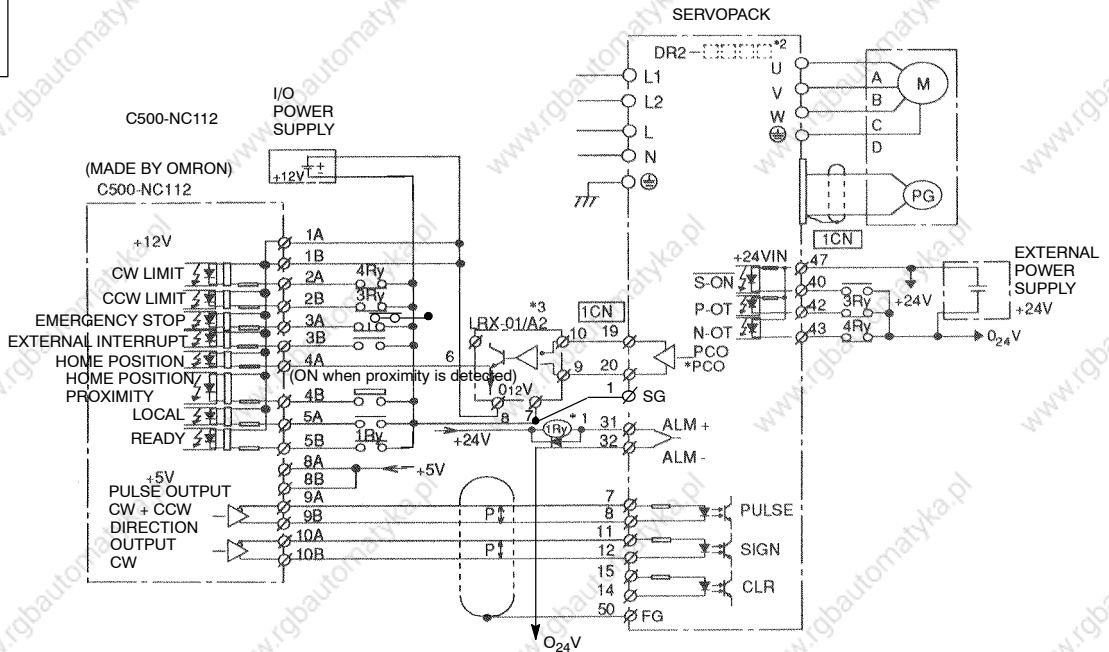

*1 These signals are output for approximately two seconds when the power is turned ON. Take this into consideration when designing a power ON sequence. Relay 1Ry is used to stop main circuit power supply to Servopack.

*2 Change the Cn-02 setting as follows:
 Bit No. 3 = 1
 Bit No. 4 = 0
 Bit No. 5 = 0

*3 Manufactured by Yaskawa Controls Co., Ltd.

Note The signals shown here are applicable only to OMRON Sequencer C500-NC112 and Yaskawa Servopack DR2-□□□□.

7) Example of Connecting to MITSUBISHI Positioning Unit AD72

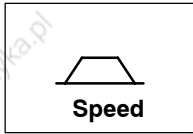

Servopack for Speed Control

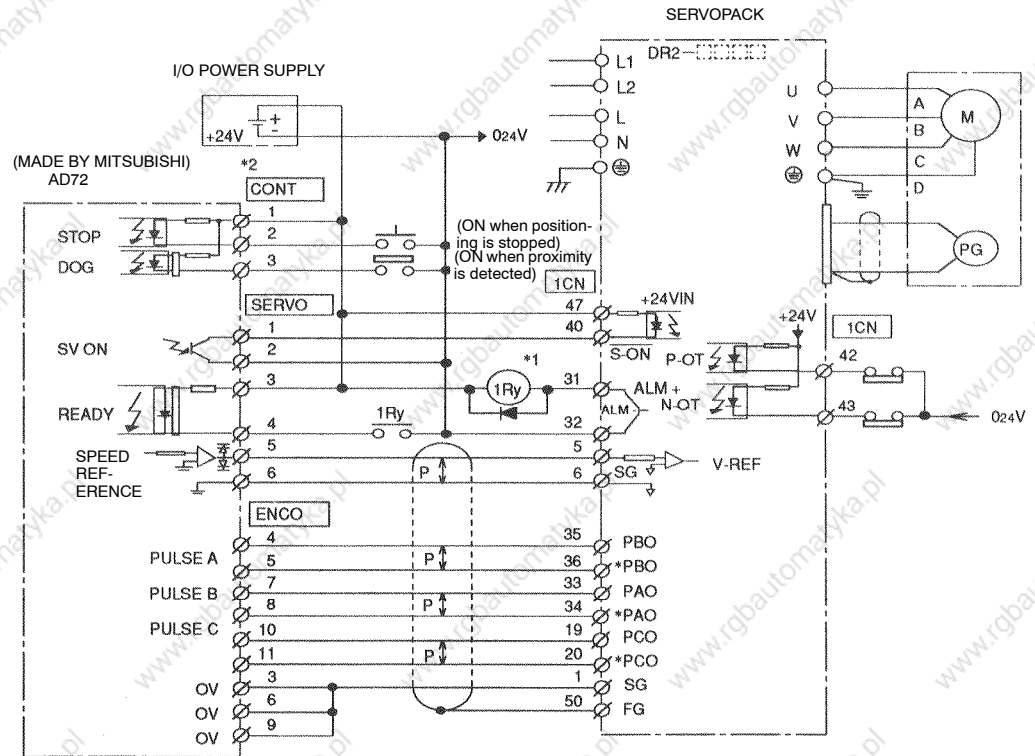

*1 These signals are output for approximately two seconds when the power is turned ON. Take this into consideration when designing a power ON sequence. Relay 1Ry is used to stop main circuit power supply to Servopack.

*2 These pin numbers are the same for both X and Y axes.

Note The signals shown here are applicable only to MITSUBISHI Sequencer AD72 and Yaskawa Servopack DR2-□□□□.

BASIC USES OF Σ -SERIES PRODUCTS

2.3.3 Examples of Connecting I/O Signal Terminals cont.

8) Example of Connecting to MITSUBISHI Positioning Unit AD71 (B Type)

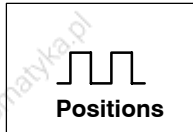

Servopack for Position Control

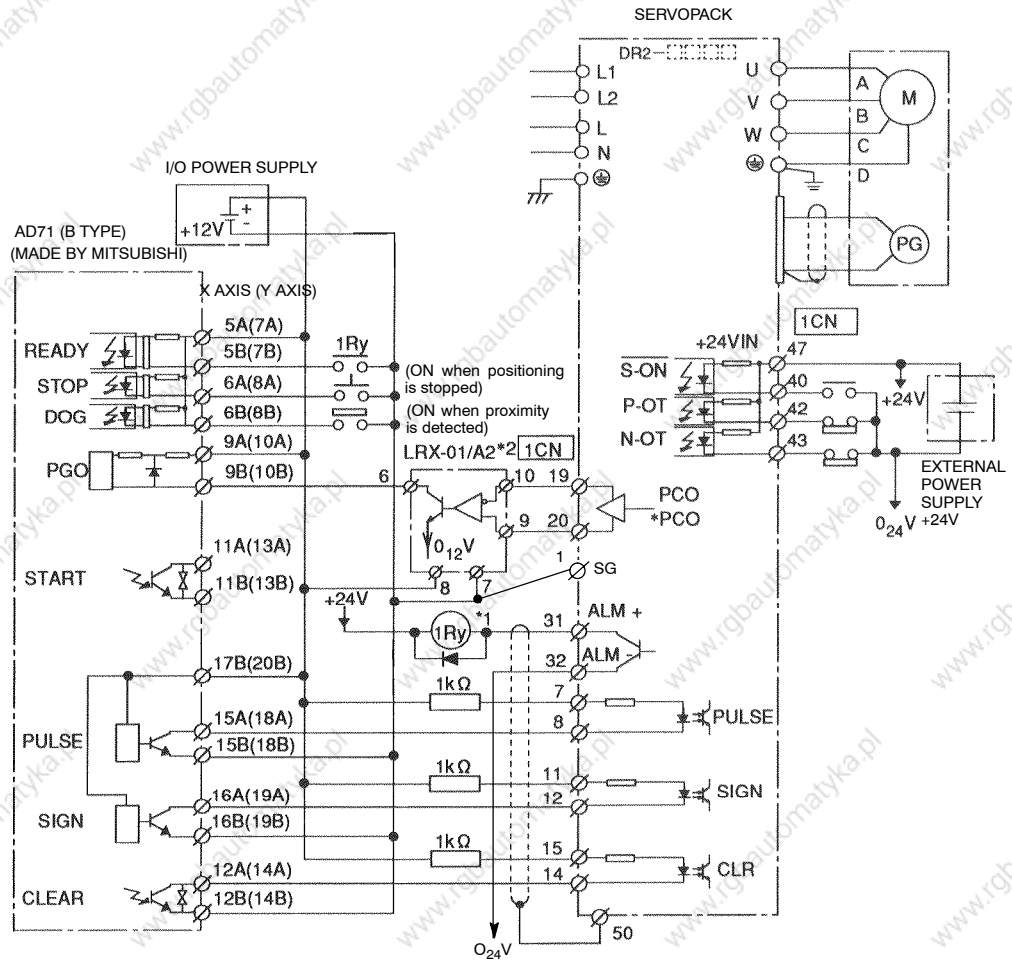

*1 These signals are output for approximately two seconds when the power is turned ON. Take this into consideration when designing a power ON sequence. Relay 1Ry is used to stop main circuit power supply to Servopack.

*2 Manufactured by Yaskawa Controls Co., Ltd.

Note The signals shown here are applicable only to MITSUBISHI Sequencer AD71 (B Type) and Yaskawa Servopack DR2-□□□□.

2.4 Conducting a Test Run

This section describes how to conduct a full test run. The test run is divided into two steps. Complete a test run in step 1 first, then proceed to step 2.

2.4.1	Test Run in Two Steps	37
2.4.2	Step 1: Conducting a Test Run for Motor without Load	39
2.4.3	Step 2: Conducting a Test Run with the Motor Connected to the Machine	43
2.4.4	Supplementary Information on Test Run	45
2.4.5	Minimum User Constants Required and Input Signals	47

2.4.1 Test Run in Two Steps

Conduct the test run when wiring is complete.

Generally, conducting a test run for servo drives can be difficult. However, by following the two steps described below, the test run can be performed safely and correctly.

NOTE To prevent accidents, initially conduct a test run only for a servomotor under no load (i.e., with all couplings and belts disconnected). Do not run the servomotor while it is connected to a machine.

The test run is divided here into steps 1 and 2.

Complete the test run in step 1 first, then proceed to step 2. The purposes of each step are described on the next page.

2.4.1 Test Run in Two Steps cont.

2

Step 1: Conducting a test run for the motor without load . . . Check that the motor is wired correctly.

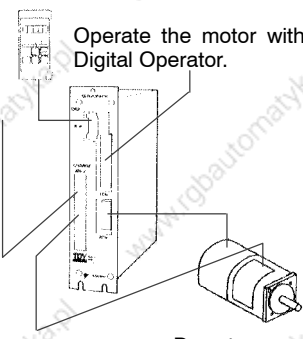

Operate the motor with a Digital Operator.

Check wiring. Do not connect to a machine.

Conduct a test run with the motor shaft disconnected from the machine.

Purpose:

- To check power supply circuit wiring
- To check motor wiring
- To check I/O signal (1CN) wiring

Outline:

- Turn the power ON.
- Operate the motor with a digital operator.
- Check I/O signals (1CN).
- Conduct a test run using I/O signals.

Step 2: Conducting a test run with the motor and machine connected Adjust Servopack according to machine characteristics.

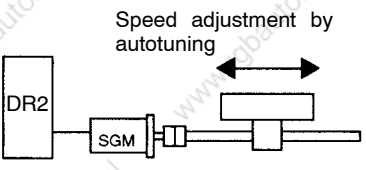

Speed adjustment by autotuning

DR2 SGM

Connect to the machine.

Connect to the machine and conduct a test run.

Purpose:

- To perform autotuning to adjust the motor according to machine characteristics
- To match the speed and direction of rotation with the machine specifications
- To check the final control mode

Outline:

- Perform autotuning.
- Adjust user constant settings.
- Record user constant settings.

End of test run

For customers who use a servomotor with a brake, refer to *Section 2.4.4 Supplementary Information on Test Run* before starting a test run.

The following pages describe the test run procedure in detail.

2.4.2 Step 1: Conducting a Test Run for Motor without Load

Check that the motor is wired correctly.

If the motor fails to rotate properly during a servo drive test run, the cause most frequently lies in incorrect wiring.

Conduct a test run for the motor without load according to the procedure described below.

For customers who use a servomotor with brake, refer to *Section 2.4.4 Supplemental Information on Test Run* before starting a test run.

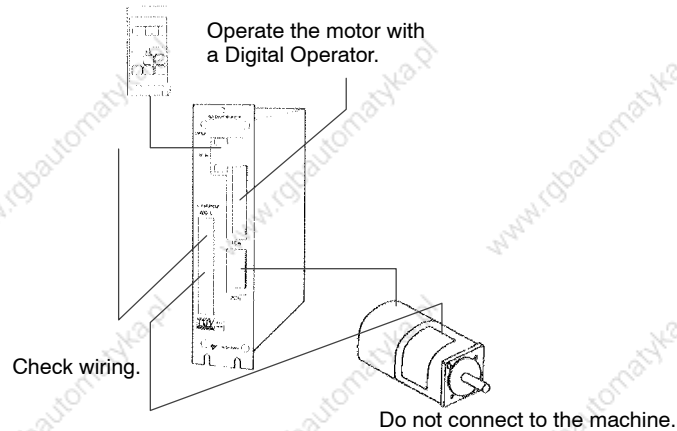

(1) Secure the servomotor.

Secure the servomotor to mounting holes to prevent it from moving during operation. Alternatively, install the servomotor on the machine and disconnect couplings and belts.

Secure servomotor to mounting holes.

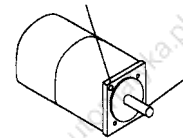

Do not connect anything to the motor shaft (no-load status).

(2) Disconnect connector 1CN, then check the motor wiring in the power supply circuit.

(When incremental encoder is used)

I/O signals (1CN) are not to be used so leave connector 1CN disconnected.

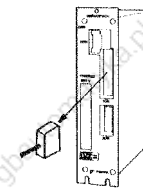

Disconnect connector 1CN

(When absolute encoder is used)

Connect the battery to the battery terminals 1CN-21, -22.

(3) Short the alarm signal circuit.

Because connector 1CN is disconnected, the alarm signal prevents the power supply circuit from being turned ON. Therefore, temporarily short the alarm signal circuit.

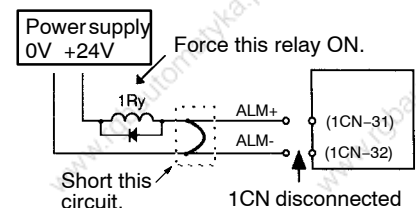

BASIC USES OF Σ-SERIES PRODUCTS

2.4.2 Step 1: Conducting a Test Run for Motor without Load cont.

- (4) Turn the power ON.
Turn the Servopack power ON. If the Servopack is turned ON normally, the LED on the Digital Operator lights up as shown in the figure.
Power is not supplied to the servomotor because the servo is OFF.

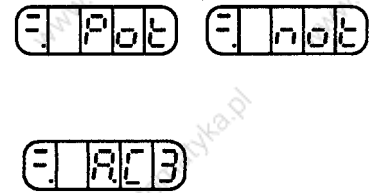

If an alarm display appears on the LED as shown in the figure above, the power supply circuit, motor wiring or encoder wiring is incorrect. In this case, turn the power OFF, then correct the problem.

- (5) Operate using the Digital Operator

Operate the motor with the Digital Operator. Check that the motor runs normally.

Refer to 4.2.2 *Operating Using the Digital Operator*.

Operation by Digital Operator

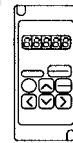

If an alarm occurs, the power supply circuit, motor wiring, or encoder wiring is incorrect.

- (6) Connect signal lines.

Connect connector 1CN as follows:

- (1) Turn the power OFF.
- (2) Return the alarm signal circuit shorted in the above step (3) to its original state.
- (3) Connect connector 1CN.
- (4) Turn the power ON again.

After turning the power OFF, remove the short circuit.

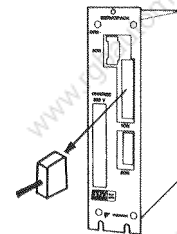
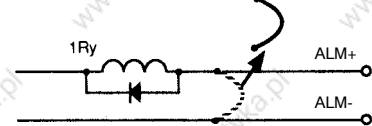

Connect connector 1CN.

- (7) Check input signals.

Check the input signal wiring in monitor mode. For the checking method, refer to 4.1.6 *Operation in Monitor Mode*.

- Checking method
Turn each connected signal line ON and OFF to check that the monitor bit display changes accordingly.

Example of Internal status bit display (Un-05, Un-06)

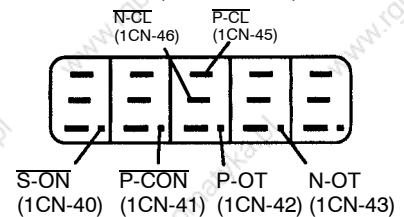

The memory switch can be used to eliminate the need for external short-circuits in wiring (Refer to 3.1.2).

Input Signal	ON/OFF	Monitor Bit Display
High level or open	OFF	Extinguished
0 V level	ON	Lit

If the signal lines below are not wired correctly, the motor fails to rotate. Always wire them correctly. (If signal lines are not to be used, short them as necessary.)

P-OT	1CN-42	Motor can rotate in forward direction when this input signal is at 0 V.
N-OT	1CN-43	Motor can reverse when this input signal is at 0 V.
S-ON	1CN-40	Servo is turned ON when this input signal is at 0 V. However, leave the servo in OFF status.

(8) Turn servo (motor) ON.

Turn the servo ON as follows:

- (1) Check that no reference has been input.

Speed/torque control mode :

V-REF (1CN-5) and T-REF (1CN-9) are at 0 V.

Position control mode:

PULS (1CN-7) and SIGN (1CN-11) are fixed.

- (2) Turn the servo ON signal ON.

Set $\overline{S-ON}$ (1CN-40) to 0 V. If normal, the motor is turned ON and the Digital Operator displays the data as shown in the figure. If an alarm display appears, take appropriate action as described in *Appendix E List of Alarm Displays*.

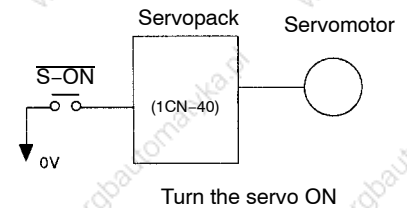

Display when servo is turned ON



(9) Operate by reference input.

The operating procedure differs according to the Servopack control mode used.



Speed/Torque Control Mode

(This section describes the standard speed control setting.)

- (1) Gradually increase the speed reference input (V-REF, 1CN-5) voltage. The motor will rotate.

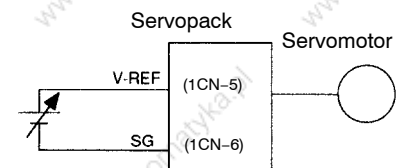

Servomotor rotates at a speed proportional to the reference voltage.

When a host controller such as a programmable controller performs position control, it may be difficult to directly input the speed reference voltage. In this case, constant voltage reference should be input once to ensure correct operation.

BASIC USES OF Σ-SERIES PRODUCTS

2.4.2 Step 1: Conducting a Test Run for Motor without Load cont.

(2) Check the following items in monitor mode (Refer to 4.6.1.):

- (1) Has a reference speed been input?
- (2) Is the motor speed as designed?
- (3) Does the reference speed match the actual motor speed?
- (4) Does the motor stop when no reference is input?

Un-00	Actual motor speed
Un-01	Reference speed

- (3) If the motor rotates at an extremely slow speed when 0 V is specified as the reference voltage, correct the reference offset value as described in *Section 4.2.4 Reference Offset Automatic Adjustment*
- (4) To change motor speed or the direction of rotation, reset the user constants shown below.

Cn-03	Speed reference gain (Refer to 3.2.7.)
Cn-02 bit 0	Reverse rotation mode (Refer to 3.1.1.)



Positions

Position Control Mode

- (1) Set user constant Cn-02 so that the reference pulse form matches the host controller output form. (Refer to 4.1.5 for details on how to set user constants.)

Selecting reference pulse form (Refer to 3.2.2.)

Cn-02	Bit 3
	Bit 4
	Bit 5

- (2) Input a slow speed pulses from the host controller and execute low-speed operation.

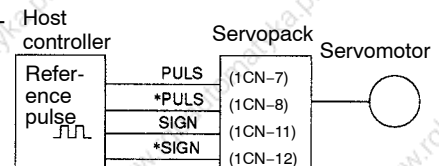

(3) Check the following items in monitor mode
(Refer to 4.6.1.):

- (1) Has a reference pulse been input?
- (2) Is the motor speed as set?
- (3) Does the reference speed match the actual motor speed?
- (4) Does the motor stop when no reference is input?

Un-00	Actual motor speed
Un-07	Reference pulse speed display
Un-08	Position error

(4) To change motor speed or the direction of rotation, reset the user constants shown below.

Cn-24,Cn-25	Electronic gear ratio (Refer to 3.2.5.)
Cn-02 bit 0	Reverse rotation mode (Refer to 3.1.1.)

If an alarm occurs or the motor fails to rotate during the above operation, connector 1CN wiring is incorrect or the user constant settings do not match the host controller specifications.

In this case, check the wiring and review the user constant settings, then repeat step 1.

Refer to Appendix E List of Alarm Displays and Appendix D List of User Constants.

This is all that is required to complete step 1 (conducting a test run for motor without load). Whenever possible, perform tuning associated with the host controller and other necessary adjustments in step 1 (before installing the motor on the machine).

2.4.3 Step 2: Conducting a Test Run with the Motor Connected to the Machine

After step 1 is complete, proceed to step 2 in which a test run is conducted with the motor connected to the machine. The purpose of step 2 is to adjust the Servopack according to the machine characteristics.

Conduct a test run according to the procedure described below.

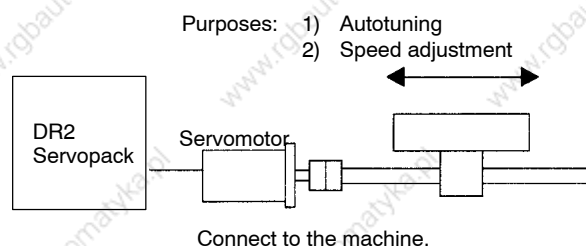

BASIC USES OF Σ-SERIES PRODUCTS

2.4.3 Step 2: Conducting a Test Run with the Motor Connected to the Machine cont.

NOTE Before proceeding to step 2, repeat step 1 (conducting a test run for the motor without load) until you are fully satisfied that the test has been completed successfully. Operation faults that arise after the motor is connected to the machine not only damage the machine but may also cause an accident resulting in injury or death. Therefore, all items including user constants setting and wiring should be tested as conclusively as possible before step 1 is complete.

- (1) Check that power is OFF.
Turn the Servopack power OFF.

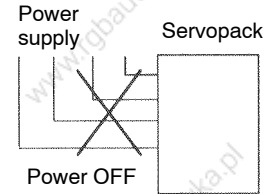

- (2) Connect the servomotor to the machine.
Refer to 2.2.2 *Installing the Servomotor*.

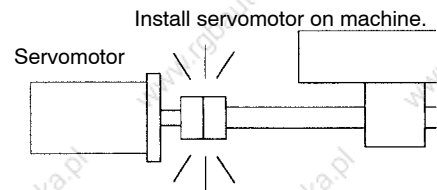

- (3) Perform autotuning.
Tune the Servopack according to the machine characteristics. Refer to 4.2.3 *Autotuning*.

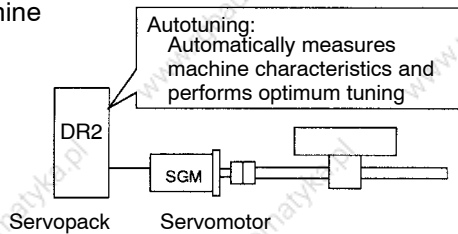

- (4) Operate by reference input.
As in step 1 (conducting a test run for motor without load), perform (9) *Operate by reference input* on page 41. Perform tuning associated with the host controller.

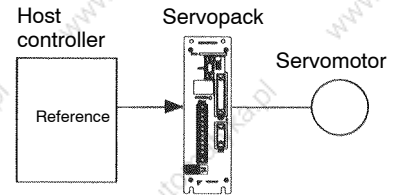

- (5) Set user constants and record the settings.
Set user constants as necessary. Record all the user constant settings for maintenance purposes.

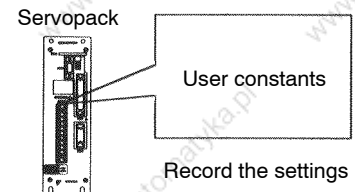

This is all that is required to conduct the test run.

Normally, the machine may cause much friction because of an insufficient running-in period. After a test run is complete, perform adequate running-in.

2.4.4 Supplementary Information on Test Run

In the following cases, always refer to the information described below before starting a test run:

- When using a servomotor with a brake
- When performing position control from the host controller

1) When using a servomotor with brake

The brake prevents the motor shaft from rotating due to a backdriving torque. Such a torque may be created by an external force or the force of gravity acting on the load and may result in undesired motion or the load, should motor power be lost.

Servopack uses the brake interlock output (BK) signal to control holding brake operation for a servomotor with brake.

- Vertical axis

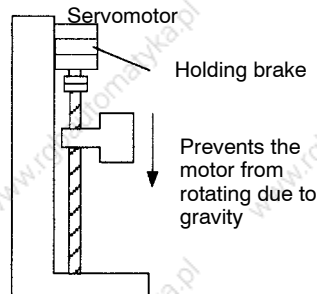

- Axis to which external force is applied

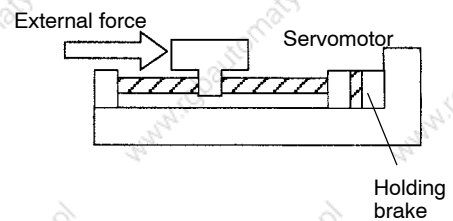

NOTE To prevent faulty operation caused by gravity (or external force), first check that the motor and holding brake operate normally with the motor disconnected from the machine. Then, connect the motor to the machine and conduct a test run.

For wiring of a servomotor with a brake, refer to *3.4.4 Using Holding Brake*.

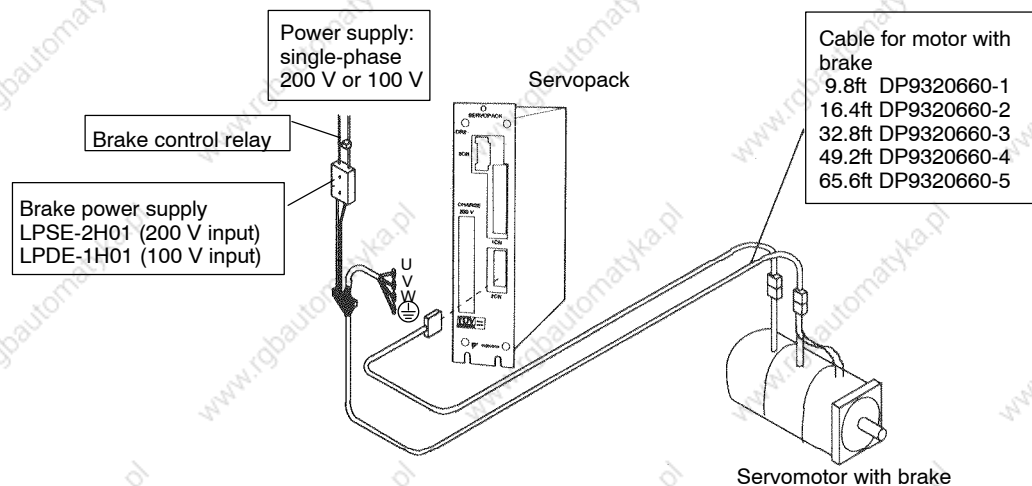

BASIC USES OF Σ-SERIES PRODUCTS

2.4.4 Supplementary Information on Test Run cont.

2) When performing position control from the host controller

Check motor operation first and then conduct a test run as described in the table below.

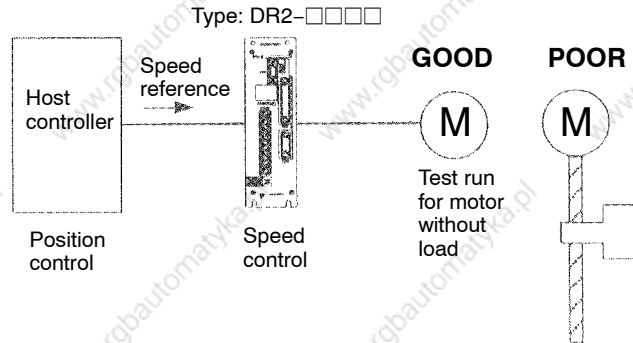

NOTE Check the motor operation with the motor disconnected from the machine. If the host controller does not perform position control correctly, the motor may run out of control.

Reference from Host Controller	Check Items	Check Method	Review Items
Jogging (constant-speed reference input from host controller)	Motor speed	<p>Check the motor speed as follows:</p> <ul style="list-style-type: none"> Use the speed monitor (Un-00) of the digital operator. Run the motor at low speed. For example, input a speed reference of 60 r/min and check that the motor makes one revolution per one second. 	Check whether the speed reference gain value (user constant Cn-03) is correct.
Simple positioning	Number of motor revolutions	<ul style="list-style-type: none"> Input a reference equivalent to one motor revolution and visually check that the motor shaft makes one revolution. 	Check whether the dividing ratio count (user constant Cn-0A) is correct.
Overtravel (when P-OT and N-OT signals are used)	Whether the motor stops rotating when P-OT and N-OT signals are input	<ul style="list-style-type: none"> Check that the motor stops when P-OT and N-OT signals are input during continuous motor operation. 	If the motor does not stop, review the P-OT and N-OT wiring.

2.4.5 Minimum User Constants Required and Input Signals

- 1) This section describes the minimum user constants that must be set to conduct a test run. For details on how to set each user constant, refer to *4.1.5 Operation in User Constant Setting Mode*.

- a) Servopack in speed/torque control mode

Cn-03	Speed reference gain
Cn-0A	Dividing ratio setting

- b) Servopack in torque control mode

Cn-13	Torque reference adjustment gain
Cn-0A	Dividing ratio setting

- c) Servopack in position control mode

Cn-02 bits 3, 4 and 5	Reference pulse form selection
Cn-24	Electronic gear ratio (numerator)
Cn-25	Electronic gear ratio (denominator)

After changing the Cn-02 setting, always turn the power OFF, then ON. This makes the new setting valid.

- 2) If the specified direction of rotation differs from the actual direction of rotation, the wiring may be incorrect. In this case, recheck the wiring and correct it accordingly. Then, if the direction of rotation is to be reversed, set the following user constant:

Cn-02 (bit 0)	Reverse rotation mode
---------------	-----------------------

After changing the Cn-02 setting, always turn the power OFF, then ON. This makes the new setting valid.

- 3) The following table lists the minimum input signals required to conduct a test run. For details of each input signal, refer to the relevant page.

Signal Name	Pin Number	Function
$\overline{S-ON}$ (servo ON)	1CN-40	Switching between motor ON and OFF status. The memory switch can be used to eliminate the need for external short-circuit wiring (see page 132).
P-OT (forward rotation prohibited)	1CN-42	Overtravel limit switch The memory switch can be used to eliminate the need for external short-circuit wiring (see page 54).
N-OT (reverse rotation prohibited)	1CN-43	

APPLICATIONS OF Σ -SERIES PRODUCTS

3

This chapter is prepared for readers who wish to learn more about the applications of Σ -series products after fully understanding *Chapter 2 Basic Uses of Σ -series Products*. It explains how to set user constants for each purpose and how to use each function. Read the applicable sections according to your requirements.

Before Reading this Chapter	51
3.1 Setting User Constants According to Machine Characteristics	52
3.1.1 Changing the Direction of Motor Rotation	52
3.1.2 Setting the Overtravel Limit Function	54
3.1.3 Restricting Torque	57
3.2 Setting User Constants According to Host Controller	64
3.2.1 Inputting Speed Reference	64
3.2.2 Inputting Position Reference	69
3.2.3 Using Encoder Output	76
3.2.4 Using Contact I/O Signals	80
3.2.5 Using Electronic Gear	82
3.2.6 Using Contact Input Speed Control	86
3.2.7 Using Torque Control	91
3.2.8 Using Torque Feed-forward Function	97
3.2.9 Using Torque Restriction by Analog Voltage Reference	98
3.2.10 Using the Reference Pulse Inhibit Function (INHIBIT)	100
3.2.11 Using the Reference Pulse Input Filter Selection Function ..	101
3.2.12 Using the Analog Monitor	102
3.3 Setting Up the Σ Servopack	103
3.3.1 Setting User Constants	103
3.3.2 Setting the Jog Speed	104
3.3.3 Setting the Number of Encoder Pulses	105
3.3.4 <input type="checkbox"/> Setting the Motor Type	106
3.4 Setting Stop Mode	107
3.4.1 <input type="checkbox"/> Adjusting Offset	107

3.4.2 Using Dynamic Brake 108

3.4.3 Using Zero-Clamp 109

3.4.4 Using Holding Brake 110

3.5 Running the Motor Smoothly 114

3.5.1 Using the Soft Start Function 114

3.5.2 Using the Smoothing Function 115

3.5.3 Adjusting Gain 115

3.5.4 Adjusting Offset 116

3.5.5 Setting the Torque Reference Filter Time Constant 116

3.6 Minimizing Positioning Time 118

3.6.1 Using Autotuning Function 118

3.6.2 Setting Servo Gain 118

3.6.3 Using Feed-forward Control 120

3.6.4 Using Proportional Control 120

3.6.5 Setting Speed Bias 121

3.6.6 Using Mode Switch 122

3.7 Forming a Protective Sequence 128

3.7.1 Using Servo Alarm Output and Alarm Code Output 128

3.7.2 Using Servo ON Input Signal 132

3.7.3 Using Positioning Complete Signal 133

3.7.4 Using Speed Coincidence Output Signal 134

3.7.5 Using Running Output Signal 136

3.7.6 Using Servo Ready Output Signal 138

3.8 Special Wiring 140

3.8.1 Wiring Instructions 140

3.8.2 Wiring for Noise Control 142

3.8.3 Using More Than One Servo Drive 147

3.8.4 Using Regenerative Units 148

3.8.5 Using an Absolute Encoder 151

3.8.6 Extending an Encoder Cable 159

3.8.7 Using DR2 Servopack with High Voltage Line 161

3.8.8 Connector Terminal Layouts 163

Before Reading this Chapter

- 1) This chapter describes how to use each 1CN connector I/O signal for the DR2 Servopack and how to set the corresponding user constant.
- 2) For a list of I/O signals of 1CN connector, refer to *Appendix C List of I/O Signals*. For terminal arrangement for I/O signals of 1CN connector, refer to *3.8.8 Connector Terminal Layouts*.

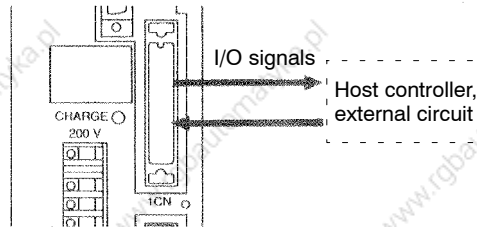

- 3) For a list of user constants, refer to *Appendix D List of User Constants*.
- 4) User constants are divided into the following two types.

1) Memory switch Cn-01 and Cn-02	Set each bit to ON or OFF to select a function.
2) Constant setting Cn-03 and later	Set a numerical value such as a torque limit value or speed loop gain.

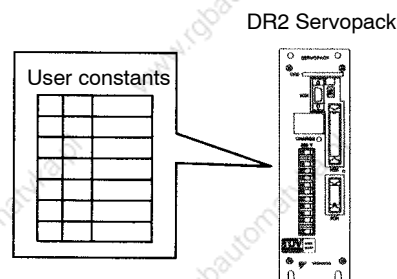

- 5) For details on how to set user constants, refer to *4.1.5 Operation in User Constant Setting Mode*.

3.1 Setting User Constants According to Machine Characteristics

This section describes how to set user constants according to the dimensions and performance of the machine to be used.

3.1.1	Changing the Direction of Motor Rotation	52
3.1.2	Setting the Overtravel Limit Function	54
3.1.3	Restricting Torque	57

3.1.1 Changing the Direction of Motor Rotation

- 1) This Servopack provides a reverse rotation mode in which the direction of rotation can be reversed without altering the servomotor wiring. With the standard setting, forward rotation is defined as counterclockwise (CCW) rotation when viewed from the drive end.
- 2) If reverse rotation mode is used, the direction of motor rotation can be reversed without other items being changed. The direction (+/-) of axial motion is reversed.

	Standard Setting	Reverse Rotation Mode
Forward Run Reference	<p>Encoder output from Servopack (Phase A) PAO (Phase B) PBO</p>	<p>Encoder output from Servopack (Phase A) PAO (Phase B) PBO</p>
Reverse Run Reference	<p>Encoder output from Servopack (Phase A) PAO (Phase B) PBO</p>	<p>Encoder output from Servopack (Phase A) PAO (Phase B) PBO</p>

3) Setting Reverse Rotation Mode:

Reverse rotation mode can be set in either of the following two ways. Normally, method 1 is easier to use.

a) Method 1: Setting Memory Switch

Set bit 0 of memory switch Cn-02 to select reverse rotation mode.

Cn-02 Bit 0	Rotation Direction Selection	Factory Setting: 0	For Speed/Torque Control and Position Control
--------------------	------------------------------	--------------------	---

Set the direction of rotation.

Setting	Meaning
0	Forward rotation is defined as counterclockwise rotation when viewed from the drive end. (Standard setting)
1	Forward rotation is defined as clockwise rotation when viewed from the drive end. (Reverse rotation mode)

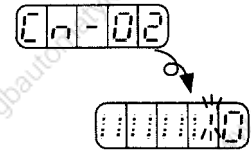

b) Method 2: Shorting the Wiring in the 2CN Connector

Reverse rotation mode can be set for the 2CN connector for the encoder. This method is used to standardize user constant settings without using the memory switch.

In this case, reverse rotation mode is set regardless of the memory switch setting.

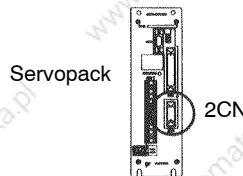
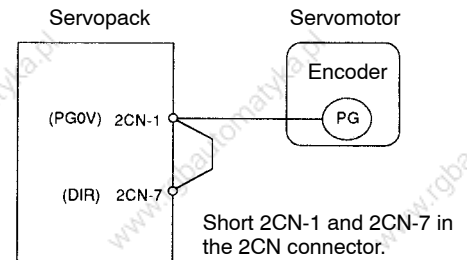

3.1.2 Setting the Overtravel Limit Function

- 1) The overtravel limit function forces the moving part of the machine to stop when it exceeds the movable range.
- 2) To use the overtravel limit function, connect the following input signal terminals correctly.

→ Input P-OT 1CN-42	Forward Rotation Prohibited (Forward Overtravel)	For Speed/Torque Control and Position Control
→ Input N-OT 1CN-43	Reverse Rotation Prohibited (Reverse Overtravel)	For Speed/Torque Control and Position Control

Inputs terminals for overtravel limit switch.

For linear motion, connect a limit switch to prevent damage to the machine.

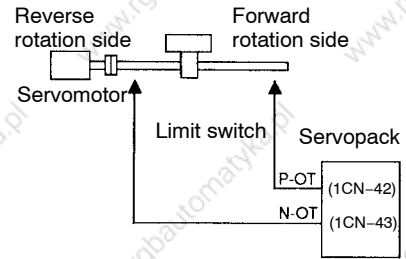

P-OT	ON: 1CN-42 is at low level.	Forward rotation allowed. Normal operation status.
	OFF: 1CN-42 is at high level.	Forward rotation prohibited (reverse rotation allowed).
N-OT	ON: 1CN-43 is at low level.	Reverse rotation allowed. Normal operation status.
	OFF: 1CN-43 is at high level.	Reverse rotation prohibited (forward rotation allowed).

3) Use the following user constants (memory switch) to specify whether input signals for overtravel are to be used.

Cn-01 Bit 2	Use of P-OT Input Signal	Factory Setting: 0	For Speed/Torque Control and Position Control
Cn-01 Bit 3	Use of N-OT Input Signal	Factory Setting: 0	For Speed/Torque Control and Position Control

Specifies whether the P-OT input signal for prohibiting forward rotation at overtravel (1CN-42) is to be used and whether the N-OT input signal for prohibiting reverse rotation at overtravel (1CN-43) is to be used.

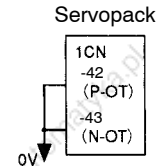

The short-circuit wiring shown in the figure can be omitted when P-OT and N-OT are not used.

Specifies "1" when external short-circuit wiring is to be omitted.

Bit	Setting	Meaning
Bit 2	0	Uses the P-OT input signal for prohibiting forward rotation. (Forward rotation is prohibited when 1CN-16 is open. Forward rotation is allowed when 1CN-42 is at 0 V.)
	1	Does not use the P-OT input signal for prohibiting forward rotation. (Forward rotation is always allowed. This has the same effect as shorting 1CN-42 to 0 V.)
Bit 3	0	Uses the N-OT input signal for prohibiting reverse rotation. (Reverse rotation is prohibited when 1CN-17 is open. Reverse rotation is allowed when 1CN-43 is at 0 V.)
	1	Does not use the N-OT input signal for prohibiting reverse rotation. (Reverse rotation is always allowed. This has the same effect as shorting 1CN-43 to 0 V.)

4) If the P-OT and N-OT input signals are used, set the following user constants to specify how to stop the motor.

Cn-01 Bit 8	How to Stop Motor at Overtravel	Factory Setting: 0	For Speed Control and Position Control
Cn-01 Bit 9	Operation to be Performed when Motor Stops after Overtravel	Factory Setting: 0	For Speed Control and Position Control

- Inputs signal for prohibiting forward rotation (P-OT, 1CN-42)
- Inputs signal for prohibiting reverse rotation (N-OT, 1CN-43)

Specify how to stop the motor when either of the above signals is input.

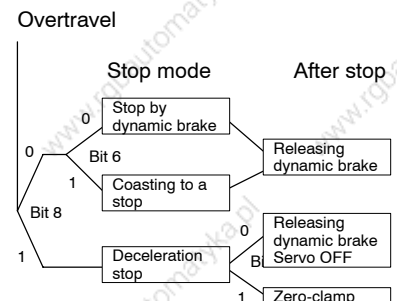

APPLICATIONS OF Σ-SERIES PRODUCTS

3.1.2 Setting the Overtravel Limit Function cont.

	Setting	Meaning
Cn-01 bit 8	0	Stops the motor in the same way as when the servo is turned OFF. The motor is stopped by dynamic brake or coasts to a stop. Either of these stop modes can be selected by setting bit 6 of Cn-01.
	1	Stops the motor by decelerating it with the preset torque. Preset value: Cn-06 (EMGTRQ) emergency stop torque

If deceleration stop mode is selected, specify the operation to be done after the motor stops.

	Setting	Meaning
Cn-01 bit 9	0	Turns the servo OFF when the motor stops in deceleration stop mode.
	1	Causes the motor to enter zero-clamp status after it stops in deceleration stop mode.

If torque control mode is selected, the motor stops in the same way as when the servo is turned OFF, regardless of the setting of Cn-01 bit 8.

Cn-06	EMGTRQ Emergency Stop Torque	Unit: %	Setting Range: 0 to Maximum Torque	Factory Setting: Maximum Torque	For Speed/Torque Control and Position Control
--------------	---------------------------------	------------	---	--	---

Specifies the stop torque to be applied at overtravel when the input signal for prohibiting forward or reverse rotation is to be used.

Specifies a torque value in terms of a percentage of the rated torque.

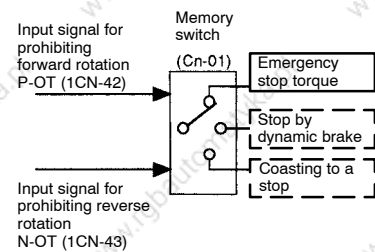

Cn-01 Bit 6	How to Stop Motor at Servo OFF	Factory Setting: 0	For Speed/Torque Control and Position Control
Cn-01 Bit 7	Operation to Be Performed when Motor Stops after Servo OFF	Factory Setting: 1	For Speed/Torque Control and Position Control

The Servopack enters servo OFF status when:

- Servo ON input signal (S-ON, 1CN-40) is turned OFF.
- Servo alarm arises.
- Main power is turned OFF.

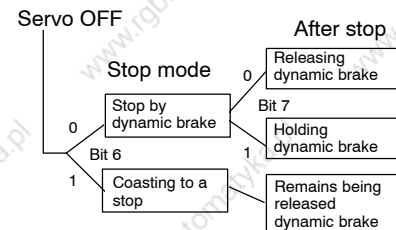

Specify how to stop the motor when one of the above events occurs during operation.

Dynamic brake is a function that electrically applies brakes by using a resistor to consume motor rotation energy.

	Setting	Meaning
Cn-01 bit 6	0	Stops the motor by dynamic brake.
	1	Causes the motor to coast to a stop. The motor power is OFF and stops due to machine friction.

If dynamic brake stop mode is selected, specify the operation to be performed when the motor stops.

	Setting	Meaning
Cn-01 bit 7	0	Releases dynamic brake after the motor stops.
	1	Does not release dynamic brake even after the motor stops.

3.1.3 Restricting Torque

1) The Servopack can provide the following torque control:

- Torque restriction
 - Level 1: To restrict the maximum output torque to protect the machine or workpiece
 - Level 2: To restrict torque after the motor moves the machine to a specified position
- Torque control
 - Level 3: To always control output torque, not speed
 - Level 4: To alternately use speed control and torque control

This section describes how to use levels 1 and 2 of the torque restriction function.

2) **How to Set Level 1: Internal Torque Limit**

The maximum torque is restricted to the values set in the following user constants.

Cn-08	TLMTF Forward Rotation Torque Limit	Unit: %	Setting Range: 0 to Maximum Torque	Factory Setting: Maximum Torque	For Speed/Torque Control and Position Control
Cn-09	TLMTR Reverse Rotation Torque Limit	Unit: %	Setting Range: 0 to Maximum Torque	Factory Setting: Maximum Torque	For Speed/Torque Control and Position Control

3.1.3 Restricting Torque cont.

Sets the maximum torque values for forward rotation and reverse rotation, respectively.

Sets these user constants when torque must be restricted according to machine conditions.

This torque restriction function always monitors torque, and outputs the signal shown on the right when the limit value is reached.

Specifies a torque limit value in terms of a percentage of the rated torque.

Output Signal for Torque Restriction Function

- $\overline{\text{CLT}}+$ (1CN-25), $\overline{\text{CLT}}-$ (1CN-26)
 - Status indication mode bit data
 - Monitor mode (Un-05) bit 4
- User Constant Setting:
Memory switch (Cn-01) bit 4 = 0

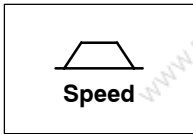

Example of Use: Machine Protection

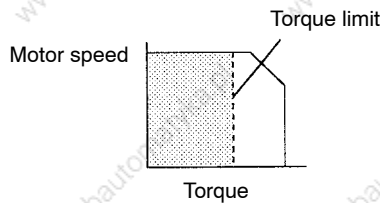

Note that too small a torque limit value will result in torque shortage at acceleration or deceleration.

- Using $\overline{\text{CLT}}+$, $\overline{\text{CLT}}-$ Signals

This section describes how to use contact output signals $\overline{\text{CLT}}+$, $\overline{\text{CLT}}-$ as a torque limit output signal.

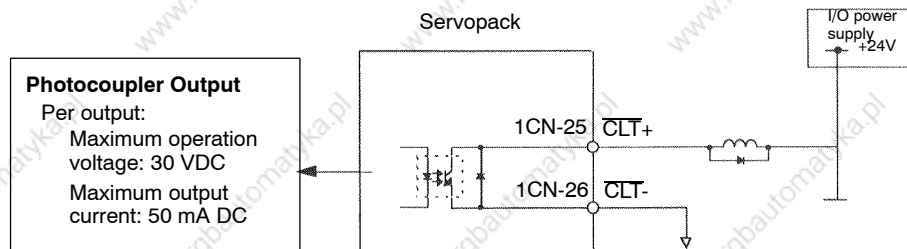

Photocoupler Output
Per output:
Maximum operation voltage: 30 VDC
Maximum output current: 50 mA DC

Output → $\overline{\text{CLT}}+$ 1CN-25	Torque Limit Output (Running Output)	For Speed/Torque Control
Output → $\overline{\text{CLT}}-$ 1CN-26		

This signal indicates whether motor output torque (current) is being restricted.

ON status: The circuit between 1CN-25 and 1CN-26 is closed. 1CN-25 is at low level.	Motor output torque is being restricted. (Internal torque reference is greater than the preset value.)
OFF status: The circuit between 1CN-25 and 1CN-26 is open. 1CN-25 is at high level.	Motor output torque is not being restricted. (Internal torque reference is equal to or below the preset value.)

Preset Value: Cn-08 (TLMTF)
 Cn-09 (TLMTR)
 Cn-18 (CLMIF) : $\overline{P-CL}$ input only
 Cn-19 (CLMIR) : $\overline{N-CL}$ input only

Note This function is changed to another function depending on the setting of bit 4 of memory switch Cn-01.

To use output signals $\overline{CLT+}$, $\overline{CLT-}$ as a torque limit output signal, set the following memory switch to 0.

This memory switch can also be used to set level 2 torque restriction (described in the next subsection).

Cn-01 Bit 4	$\overline{CLT+}$, $\overline{CLT-}$ Output Signals Selection	Factory Setting: 0	For Speed/Torque Control
--------------------	--	--------------------	--------------------------

Sets the output conditions for output signals $\overline{CLT+}$ (1CN-25) and $\overline{CLT-}$ (1CN-26).

Setting	Meaning				
0	<p>Uses $\overline{CLT+}$, $\overline{CLT-}$ output signals as a torque limit output signal.</p> <p>Compares the DR2 Servopack internal torque (current) reference with the preset value.</p> <p>Preset Value: Cn-08 (TLMTF) Cn-09 (TLMTR) Cn-18 (CLMIF): P-CL input only Cn-19 (CLMIR): N-CL input only</p> <table border="1"> <tr> <td>Internal torque (current) reference \geq preset value</td> <td>Opens the circuit between 1CN-25 and 1CN-26</td> </tr> <tr> <td>Internal torque (current) reference < preset value</td> <td>Closes the circuit between 1CN-25 and 1CN-26</td> </tr> </table>	Internal torque (current) reference \geq preset value	Opens the circuit between 1CN-25 and 1CN-26	Internal torque (current) reference < preset value	Closes the circuit between 1CN-25 and 1CN-26
Internal torque (current) reference \geq preset value	Opens the circuit between 1CN-25 and 1CN-26				
Internal torque (current) reference < preset value	Closes the circuit between 1CN-25 and 1CN-26				
1	<p>Uses $\overline{CLT+}$, $\overline{CLT-}$ output signals as a speed coincide output signal.</p> <p>For details, refer to 3.7.4.</p>				

Bit 4 of memory switch Cn-01

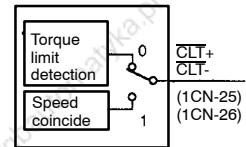

When $\overline{CLT+}$, $\overline{CLT-}$ output signals are changed, the following bit data are also changed:

- Status indication mode bit data
- Monitor mode Un-05 bit 4

3) How to Set Level 2: External Torque Limit

First, use a contact input signal to make the torque (current) limit value set in the user constant valid. Torque limit can be set separately for forward and reverse rotation.

To use this function, always set bit 2 of memory switch Cn-02 to 0 (standard setting). The contact input speed control function cannot be used.

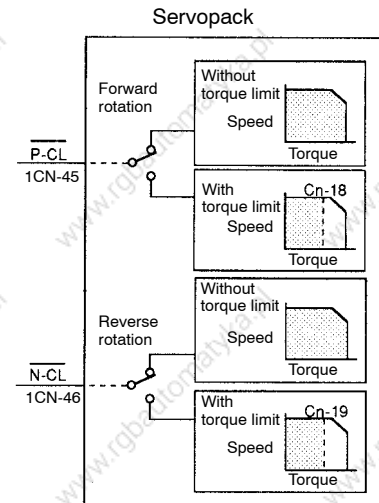

P-CL	ON: 1CN-45 is at low level.	Torque restriction applies during forward rotation.	Limit value: Cn-18
	OFF: 1CN-45 is at high level.	Torque restriction does not apply during forward rotation.	
N-CL	ON: 1CN-46 is at low level.	Torque restriction applies during reverse rotation.	Limit value: Cn-19
	OFF: 1CN-46 is at high level.	Torque restriction does not apply during reverse rotation.	

This torque restriction function outputs the signal shown on the right.

Output Signal for Torque Restriction Function

- $\overline{CLT}+$ (1CN-25), $\overline{CLT}-$ (1CN-26)
 - Status indication mode bit data
 - Monitor mode Un-05 bit 4
- User Constant Setting:
Memory switch Cn-01 bit 4 = 0

Examples of Use:

- Forced stopping
- Holding workpiece by robot

Cn-18	CLMIF Forward External Torque Limit	Unit: %	Setting Range: 0 to Maximum Torque	Factory Setting: 100	For Speed/Torque Control and Position Control
Cn-19	CLMIR Reverse External Torque Limit	Unit: %	Setting Range: 0 to Maximum Torque	Factory Setting: 100	For Speed/Torque Control and Position Control

Sets a torque limit value when torque is restricted by external contact input.

This function is valid when bit 2 of memory switch Cn-02 is set to 0.

When $\overline{P-CL}$ (1CN-45) is input	Applies torque restriction as specified in Cn-18
When $\overline{N-CL}$ (1CN-46) is input	Applies torque restriction as specified in Cn-19

For torque restriction by analog voltage reference, refer to 3.2.9 Using Torque Restriction by Analog Voltage Reference.

- Using $\overline{P-CL}$ and $\overline{N-CL}$ Signals

This section describes how to use input signals $\overline{P-CL}$ and $\overline{N-CL}$ as torque limit input signals.

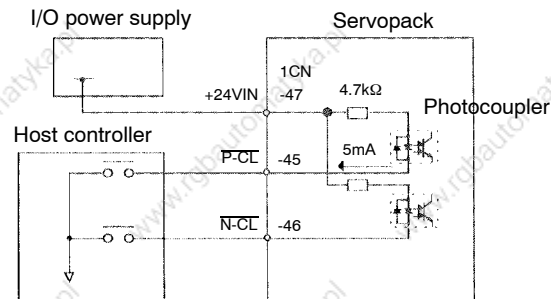

→ Input $\overline{P-CL}$ 1CN-45	Forward External Torque Limit Input (Speed Selection 1)	For Speed/Torque Control and Position Control
→ Input $\overline{N-CL}$ 1CN-46	Reverse External Torque Limit Input (Speed Selection 2)	For Speed/Torque Control and Position Control

These signals are for forward and reverse external torque (current) limit input.

This function is useful in forced stopping.

Output Signal for Torque Restriction Function

- $\overline{CLT+}$ (1CN-25), $\overline{CLT-}$ (1CN-26)
- Status indication mode bit data
- Monitor mode Un-05 bit 4
- User Constant Setting:
Memory switch Cn-01 bit 4 = 0

APPLICATIONS OF Σ-SERIES PRODUCTS

3.1.3 Restricting Torque cont.

$\overline{P-CL}$	ON: 1CN-45 is at low level.	Torque restriction applies during forward rotation.	Limit value: Cn-18
	OFF: 1CN-45 is at high level.	Torque restriction does not apply during forward rotation. Normal operation status.	
$\overline{N-CL}$	ON: 1CN-46 is at low level.	Torque restriction applies during reverse rotation.	Limit value: Cn-19
	OFF: 1CN-46 is at high level.	Torque restriction does not apply during reverse rotation. Normal operation status.	

The signal shown on the right is output while torque is being restricted.

Note This function is changed to another function depending on the setting of bit 2 of memory switch Cn-02 (see below).

To use input signals $\overline{P-CL}$ and $\overline{N-CL}$ as torque limit input signals, set the following memory switch to 0.

Cn-02 Bit 2	Contact Input Speed Control Selection	Factory Setting: 0	For Speed/Torque Control and Position Control
--------------------	---------------------------------------	--------------------	---

Prohibits the contact input speed control function.

If the contact input speed control function is used, the contents of the input signals shown below will change.

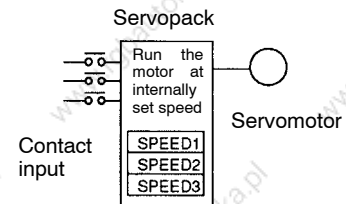

After this memory switch is reset, the meanings of the following signals will also change:

Monitor mode (Un-05) bit 7 and bit 8

Setting	Meaning	Input Signal																							
0	Does not use the contact input speed control function.	<table border="1"> <tr> <td>$\overline{P-CON}$ (1CN-41)</td> <td colspan="3">Used to switch between P control and PI control. (For speed/torque control, bits A and B of Cn-01 take precedence over this signal.)</td> </tr> <tr> <td>$\overline{P-CL}$ (1CN-45)</td> <td colspan="3">Used for forward external torque limit input</td> </tr> <tr> <td>$\overline{N-CL}$ (1CN-46)</td> <td colspan="3">Used for reverse external torque limit input</td> </tr> </table>				$\overline{P-CON}$ (1CN-41)	Used to switch between P control and PI control. (For speed/torque control, bits A and B of Cn-01 take precedence over this signal.)			$\overline{P-CL}$ (1CN-45)	Used for forward external torque limit input			$\overline{N-CL}$ (1CN-46)	Used for reverse external torque limit input										
$\overline{P-CON}$ (1CN-41)	Used to switch between P control and PI control. (For speed/torque control, bits A and B of Cn-01 take precedence over this signal.)																								
$\overline{P-CL}$ (1CN-45)	Used for forward external torque limit input																								
$\overline{N-CL}$ (1CN-46)	Used for reverse external torque limit input																								
1	Uses the contact input speed control function.	<p style="text-align: right;">0: OFF, 1: ON</p> <table border="1"> <thead> <tr> <th>$\overline{P-CON}$</th> <th>$\overline{P-CL}$</th> <th>$\overline{N-CL}$</th> <th>Speed Setting</th> </tr> </thead> <tbody> <tr> <td>Direction of rotation 0: Forward 1: Reverse</td> <td>0</td> <td>0</td> <td>Normal speed/torque or position control</td> </tr> <tr> <td></td> <td>0</td> <td>1</td> <td>Cn-1F (SPEED1)</td> </tr> <tr> <td></td> <td>1</td> <td>1</td> <td>Cn-20 (SPEED2)</td> </tr> <tr> <td></td> <td>1</td> <td>0</td> <td>Cn-21 (SPEED3)</td> </tr> </tbody> </table>				$\overline{P-CON}$	$\overline{P-CL}$	$\overline{N-CL}$	Speed Setting	Direction of rotation 0: Forward 1: Reverse	0	0	Normal speed/torque or position control		0	1	Cn-1F (SPEED1)		1	1	Cn-20 (SPEED2)		1	0	Cn-21 (SPEED3)
$\overline{P-CON}$	$\overline{P-CL}$	$\overline{N-CL}$	Speed Setting																						
Direction of rotation 0: Forward 1: Reverse	0	0	Normal speed/torque or position control																						
	0	1	Cn-1F (SPEED1)																						
	1	1	Cn-20 (SPEED2)																						
	1	0	Cn-21 (SPEED3)																						

- Handling of the $\overline{CLT+}$, $\overline{CLT-}$ signals are the same as for level 1 (internal torque limit). Refer to *Using $\overline{CLT+}$, $\overline{CLT-}$ Signals* on page 58.

3.2 Setting User Constants According to Host Controller

This section describes how to connect a Σ-series Servo to a host controller and how to set user constants.

3.2.1	Inputting Speed Reference	64
3.2.2	Inputting Position Reference	69
3.2.3	Using Encoder Output	76
3.2.4	Using Contact I/O Signals	80
3.2.5	Using Electronic Gear	82
3.2.6	Using Contact Input Speed Control	86
3.2.7	Using Torque Control	91
3.2.8	Using Torque Feed-forward Function	97
3.2.9	Using Torque Restriction by Analog Voltage Reference	98
3.2.10	Using the Reference Pulse Inhibit Function (INHIBIT)	100
3.2.11	Using the Reference Pulse Input Filter Selection Function	101
3.2.12	Using the Analog Monitor	102

3.2.1 Inputting Speed Reference

- Using the following memory switch, select the speed/torque control.

Cn-02 Bit B	Selection of Speed/Torque Control or Position Control	Factory Setting: 0	For Speed/Torque Control and Position Control
--------------------	---	--------------------	---

Select the control mode (speed/torque control or position control) by bit B of memory switch Cn-02.

Setting	Meaning
0	Selects speed or torque control. Select the control form by bits A and B of memory switch Cn-01.
1	Selects position control.

Note For the memory switch Cn-02, always turn the power OFF and then ON after changing the setting. This makes the new setting valid.

- Input a speed reference by using the following input signal "speed reference input." Since this signal can be used in different ways, set the optimum reference input for the system to be created.

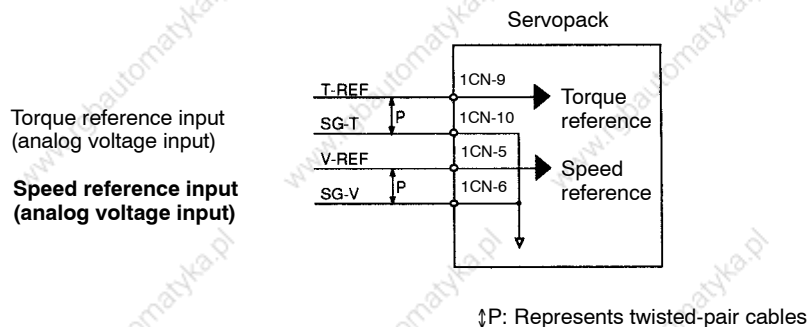

→ Input V-REF	1CN-5	Speed Reference Input	For Speed/Torque Control Only
→ Input SG-V	1CN-6	Signal Ground for Speed Reference Input	For Speed/Torque Control Only

Use these signals when speed control is selected (memory switch Cn-02 bit B = 0).

For ordinary speed control, always wire the V-REF and SG-V terminals.

Motor speed is controlled in proportion to the input voltage between V-REF and SG-V.

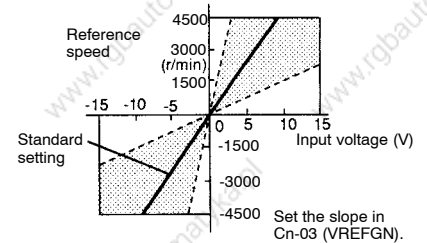

• Standard Setting:

Cn-03 = 500: This setting means that 6 V is equivalent to rated speed (3,000 r/min)

Examples:

- +6 V input → 3000 r/min in forward direction
- +1 V input → 500 r/min in forward direction
- 3 V input → 1500 r/min in reverse direction

User constant Cn-03 can be used to change the voltage input range.

• Example of Input Circuit (See the figure on the right)

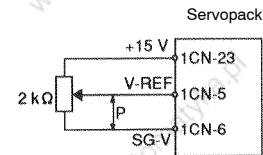

For noise control, always use twisted-pair cables.

Recommended Variable Resistor for Speed Setting:
Type 25HP-10B manufactured by Sakae Tsushin Kogyo Co., Ltd.

When position control is performed by a host controller such as a programmable controller.

Connect V-REF and SG-V to speed reference output terminals on the host controller. In this case, adjust Cn-03 according to output voltage specifications.

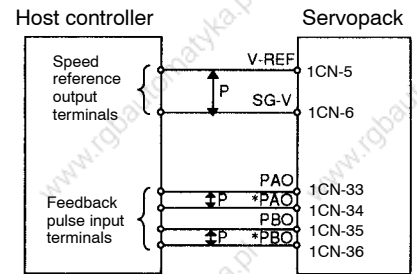

↑P: Represents twisted-pair cables

Output → +15V	1CN-23	+15V power supply for speed/torque control	For Speed/Torque Control Only
Output → -15V	1CN-24	-15V power supply for speed/torque control	For Speed/Torque Control Only

Power output for speed/torque control.
Max. output current is 30mADC.

APPLICATIONS OF Σ -SERIES PRODUCTS

3.2.1 Inputting Σ Speed Reference cont.

- 3) Use the memory switch and input signal P-CON to specify one of the four modes shown below.

Cn-01 Bit A	Control Mode Selection	Factory Setting: 0	For Speed/Torque Control Only
Cn-01 Bit B	Control Mode Selection	Factory Setting: 0	For Speed/Torque Control Only

The Servopack for speed/torque control provides four different control modes.

Cn-01 Setting		Control Mode					
Bit B	Bit A						
0	0	<p>Speed Control</p> <p>This is normal speed control.</p> <ul style="list-style-type: none"> Speed reference is input from V-REF (1CN-5). P-CON (1CN-41) signal is used to switch between P control and PI control. <table border="1"> <tr> <td>1CN-41 is open</td> <td>PI control</td> </tr> <tr> <td>1CN-41 is at 0 V</td> <td>P control</td> </tr> </table> <ul style="list-style-type: none"> Torque reference input T-REF (1CN-9) cannot be used. 	1CN-41 is open	PI control	1CN-41 is at 0 V	P control	<p>DR2 Servopack</p>
1CN-41 is open	PI control						
1CN-41 is at 0 V	P control						
0	1	<p>Zero-clamp Speed Control</p> <p>This speed control allows the zero-clamp function to be set when the motor stops.</p> <ul style="list-style-type: none"> Speed reference is input from V-REF (1CN-5). P-CON (1CN-41) signal is used to turn the zero-clamp function ON or OFF. <table border="1"> <tr> <td>1CN-41 is open</td> <td>Turns zero-clamp function OFF</td> </tr> <tr> <td>1CN-41 is at 0 V</td> <td>Turns zero-clamp function ON</td> </tr> </table> <ul style="list-style-type: none"> Torque reference input T-REF (1CN-9) cannot be used. 	1CN-41 is open	Turns zero-clamp function OFF	1CN-41 is at 0 V	Turns zero-clamp function ON	<p>DR2 Servopack</p> <p>Zero-clamp is performed when the following two conditions are met:</p> <p>Condition 1: P-CON is turned ON.</p> <p>Condition 2: Motor speed drops below the preset value.</p> <p>Preset value: Cn-29 (ZCLVL)</p>
1CN-41 is open	Turns zero-clamp function OFF						
1CN-41 is at 0 V	Turns zero-clamp function ON						
1	0	Torque control I					
1	1	Torque control II					

For torque control, refer to 3.2.7 Using Torque Control.

3.2.1 Inputting Speed Reference cont.

- Using $\overline{\text{P-CON}}$ Signal:

→ Input $\overline{\text{P-CON}}$ 1CN-41	Proportional Control, etc.	For Speed/Torque Control and Position Control
--	----------------------------	---

The function of input signal $\overline{\text{P-CON}}$ changes with the memory switch setting.

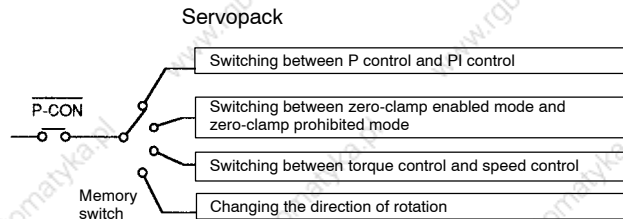

Memory Switch			Meaning of $\overline{\text{P-CON}}$ Signal
Cn-02 Bit 2	Cn-01 Bit B	Cn-01 Bit A	
0	0	0	Switching between proportional (P) control and proportional/integral (PI) control
0	0	1	Switching between zero-clamp enabled/prohibited mode Speed control with zero-clamp function
0	1	0	Torque control I ($\overline{\text{P-CON}}$ is not used.)
0	1	1	Switching between torque control and speed control (Torque control II)
1	-	-	Changing the direction of rotation during contact input speed control

4) Adjust the speed reference gain using the following user constant.

Cn-03	VREFGN Speed Reference Gain	Unit: (r/min)/V	Setting Range: 10 to 2162	Factory Setting: 500	For Speed/Torque Control Only
--------------	-----------------------------	-----------------	---------------------------	----------------------	-------------------------------

This user constant is for speed/torque control only. Sets the voltage range for speed reference input V-REF (1CN-5). Sets this user constant according to the output form of the host controller or external circuit.

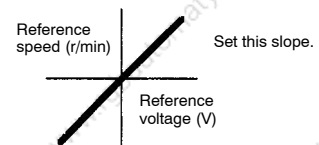

The factory setting is as follows:
Rated speed (3000 r/min)/6 V = 500



Zero-clamp function

This function is used for a system in which the host controller does not form a position loop. In this case, the stopping position may shift even if a speed reference is set to 0. If the zero-clamp function is turned ON, a position loop is internally formed so that the stopping position is firmly “clamped.”

3.2.2 Inputting Position Reference

1) Using the following memory switch, select the position control.

Cn-02 Bit B	Selection of Speed/Torque Control or Position Control	Factory Setting: 0	For Speed/Torque Control and Position Control
--------------------	---	--------------------	---

Select the control mode (speed/torque control or position control) by bit B of memory switch Cn-02.

Setting	Meaning
0	Selects speed or torque control. Select the control form by bits A and B of memory switch Cn-01.
1	Selects position control.

Note For the memory switch Cn-02, always turn the power OFF and then ON after changing the setting. This makes the new setting valid.



2) Input a position reference by using the following input signal "reference pulse input." Since there are several specifications for input signal, select reference input for the system to be created.

Inputs a move reference by pulse input.

Position reference can correspond to the following three types of output form:

- Line driver output
- +12V Open collector output
- +5V Open collector output

Connection Example 1: Line Driver Output

Line Driver Used:

SN75174 manufactured by Texas Instruments Inc., or MC3487 or equivalent.

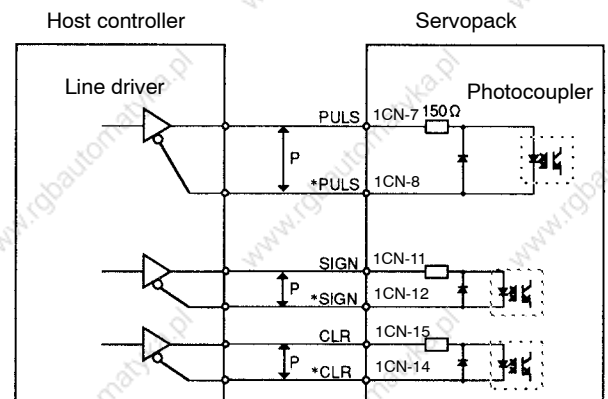
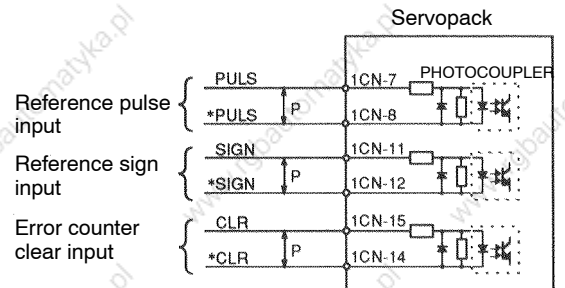

Connection Example 2: Open Collector Output

Sets the value of limiting resistor R1 so that input current *i* falls within the following range:

Input Current *i*: 7 to 15 mA

Examples:

- When Vcc is 12 V, R1 = 1 kΩ
- When Vcc is 5 V, R1 = 180 Ω

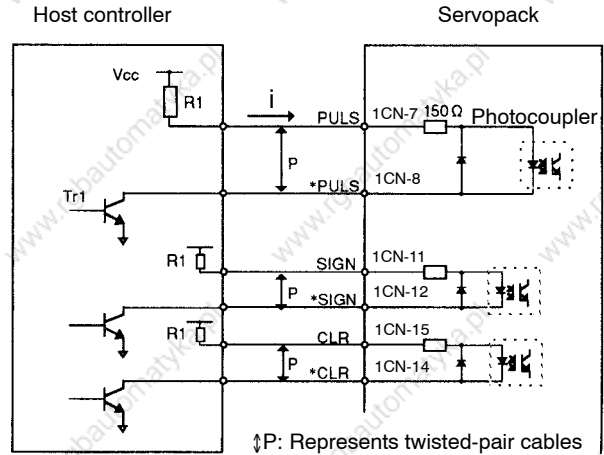

Note The signal logic for open collector output is as follows.

When Tr1 is ON	Equivalent to high level input
When Tr1 is OFF	Equivalent to low level input

Output → PL1 1CN-3	Power for Open Collector Reference	For Position Control Only
Output → PL2 1CN-13		
Output → PL3 1CN-18		

For details, refer to the Connection Example 3 (When Power for Open Collector Reference is Used) shown below:

Connection Example 3: When Power for Open Collector Reference is Used

When power for open collector reference (PL1, PL2, PL3) is used, connect between PL1 and PULS, PL2 and SIGN, PL3 and CLR as follows:

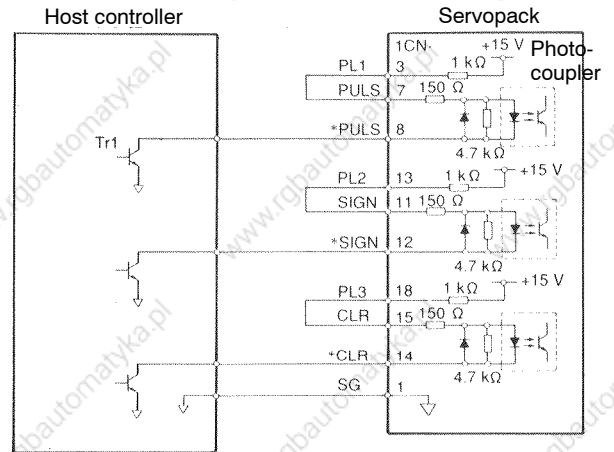

⚡P: Represents twisted-pair cables

Note The signal logic for open collector output is as follows.

When Tr1 is ON	Equivalent to high level input
When Tr1 is OFF	Equivalent to low level input

3) Use the following memory switch to select the reference pulse form to be used:

→ Input PULS	1CN-7	Reference Pulse Input	For Position Control Only
→ Input *PULS	1CN-8	Reference Pulse Input	For Position Control Only
→ Input SIGN	1CN-11	Reference Sign Input	For Position Control Only
→ Input *SIGN	1CN-12	Reference Sign Input	For Position Control Only

The motor only rotates at an angle proportional to the input pulse.

Cn-02 Bit 3	Reference Pulse Form Selection	Factory Setting: 0	For Position Control Only
Cn-02 Bit 4	Reference Pulse Form Selection	Factory Setting: 0	For Position Control Only
Cn-02 Bit 5	Reference Pulse Form Selection	Factory Setting: 0	For Position Control Only

Sets the form of a reference pulse that is external-ly output to the Servopack.

Sets the pulse form according to the host controller specifications.

Set also the input pulse logic in bit D of Cn-02.

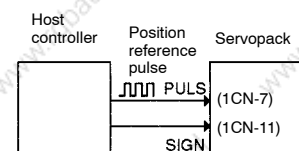

APPLICATIONS OF Σ-SERIES PRODUCTS

3.2.2 Inputting Position Reference cont.

Bit D	Cn-02			Input Pulse Multiplier	Reference Pulse Form	Motor Forward Run Reference	Motor Reverse Run Reference
	Bit 5	Bit 4	Bit 3				
0 (Positive logic setting)	0	0	0	/	Sign + pulse train		
	0	1	0	×1	Two-phase pulse train with 90° phase difference		
	0	1	1	×2			
	1	0	0	×4			
	0	0	1	/	CW *1 pulse + CCW pulse		
1 (Negative logic setting)	0	0	0	/	Sign + pulse train		
	0	1	0	×1	Two-phase pulse train with 90° phase difference		
	0	1	1	×2			
	1	0	0	×4			
	0	0	1	/	CW *2 pulse + CCW pulse		

*1 When CW pulse + CCW pulse and positive logic setting, make sure to set each of the signals (the one not being input the pulse) to Low level.

*2 When CW pulse + CCW pulse and negative logic setting, make sure to set each of the signals (the one not being input the pulse) to High level.

Input Pulse Multiply Function:

When the reference form is two-phase pulse train with 90° phase difference, the input pulse multiply function can be used.

The electronic gear function can also be used to convert input pulses.

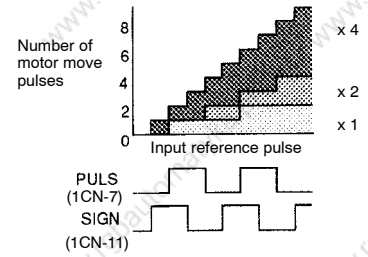

Example of I/O Signal Generation Timing

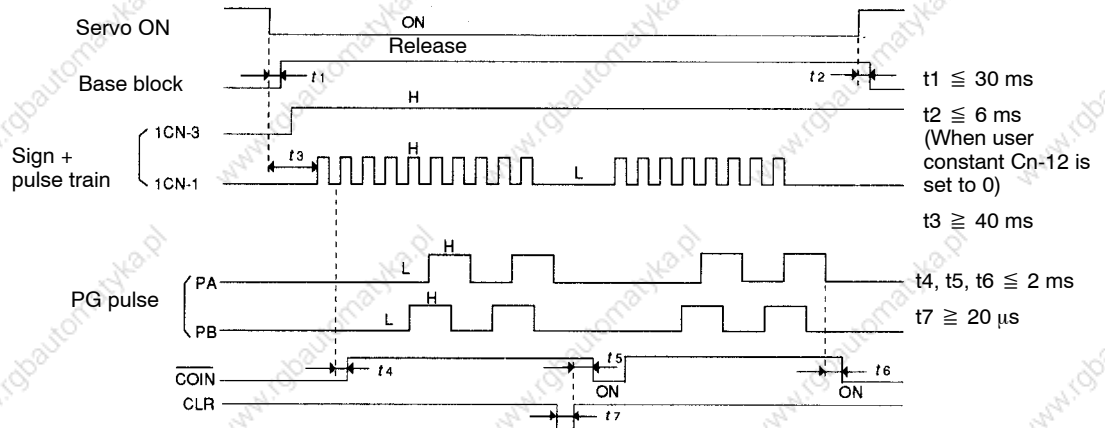

Note The interval from the time the servo ON signal is turned ON until a reference pulse is input must be at least 40 ms. Otherwise, the reference pulse may not be input. The error counter clear (CLR) signal must be ON for at least 20 μs. Otherwise, it becomes invalid.

Allowable Voltage Level and Timing for Reference Pulse Input

Reference Pulse Form	Electrical Specifications	Remarks
Sign + pulse train input (SIGN + PULS signal) Maximum reference frequency: 450 kpps	<p> $t_1, t_2 \leq 0.1 \mu s$ $\tau \geq 1.1 \mu s$ $t_3, t_7 \leq 0.1 \mu s$ $t_4, t_5, t_6 > 3 \mu s$ </p>	The signs for each reference pulse are as follows: ⊕: High level ⊖: Low level
90° different two-phase pulse train (phase A + phase B) Maximum reference frequency x 1 multiplier: 450 kpps x 2 multiplier: 400 kpps x 4 multiplier: 200 kpps	<p> $t_1, t_2 \leq 0.1 \mu s$ $\tau \geq 1.1 \mu s$ $\frac{\tau}{T} \times 100 \leq 50\%$ </p> <p>Phase B is 90° forward from phase A Phase B is 90° behind phase A</p>	User constant Cn-02 (bits 3, 4 and 5) is used to switch the input pulse multiplier mode.
CCW pulse + CW pulse Maximum reference frequency: 450 kpps	<p> $t_1, t_2 \leq 0.1 \mu s$ $\tau \geq 1.1 \mu s$ $t_3 > 3 \mu s$ $\frac{\tau}{T} \times 100 \leq 50\%$ </p>	

4) The following describes how to clear the error counter.

→ Input CLR 1CN-15	Error Counter Clear Input	For Position Control Only
→ Input ★CLR 1CN-14	Error Counter Clear Input	For Position Control Only

Setting the CLR signal to high level does the following:

- Sets the error counter inside the Servopack to 0.
- Prohibits position loop control.

Use this signal to clear the error counter from the host controller.

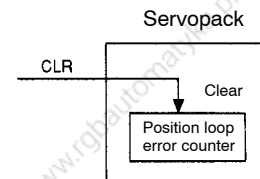

Bit A of memory switch Cn-02 can be set so that the error counter is cleared only once when the leading edge of an input pulse rises.

Cn-02 Bit A	Error Counter Clear Signal Selection	Factory Setting: 0	For Position Control Only
--------------------	--------------------------------------	--------------------	---------------------------

Selects the pulse form of error counter clear signal CLR (1CN-15).

Setting	Meaning	
0	Clears the error counter when the CLR signal is set at high level. Error pulses do not accumulate while the signal remains at high level.	
1	Clears the error counter only once when the rising edge of the CLR signal rises.	

Cn-01 Bit A	Error Counter Processing at Servo OFF	Factory Setting: 0	For Position Control Only
--------------------	---------------------------------------	--------------------	---------------------------

Select the error counter processing at Servo OFF.

Setting	Meaning
0	Error counter is cleared at Servo OFF.
1	Error counter is not cleared at servo OFF.

3.2.3 Using Encoder Output

- Encoder output signals **divided** inside the Servopack can be output externally. These signals can be used to form a position control loop in the host controller.

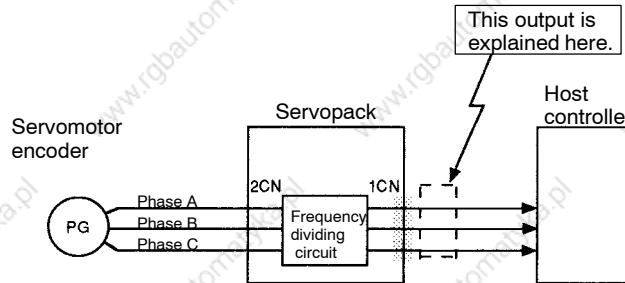

The output circuit is for line driver output. Connect each signal line according to the following circuit diagram.

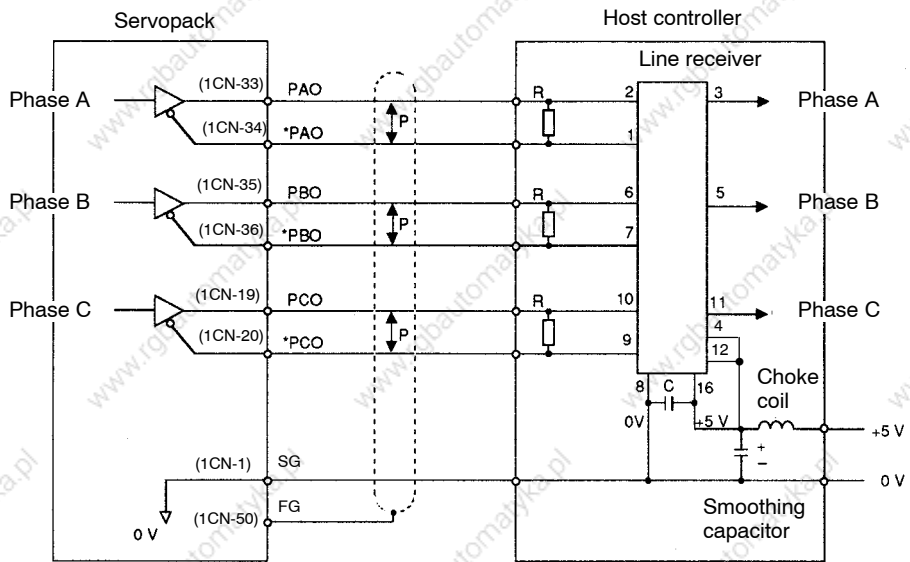

↓P: Represents twisted-pair cables

Line receiver used: SN75175 manufactured by Texas Instruments Inc. or MC3486 (or equivalent)

R (termination resistor): 220 to 470 Ω
C (decoupling capacitor): 0.1 μF



Divided (or dividing)

“Dividing” means converting an input pulse train from the encoder mounted on the motor according to the preset pulse density and outputting the converted pulse. The unit is pulses per revolution.

2) I/O signals are described below.

Output → PAO 1CN-33	Encoder Output Phase-A	For Speed/Torque Control and Position Control
Output → * PAO 1CN-34	Encoder Output Phase-A	For Speed/Torque Control and Position Control
Output → PBO 1CN-35	Encoder Output Phase-B	For Speed/Torque Control and Position Control
Output → * PBO 1CN-36	Encoder Output Phase-B	For Speed/Torque Control and Position Control
Output → PCO 1CN-19	Encoder Output Phase-C	For Speed/Torque Control and Position Control
Output → * PCO 1CN-20	Encoder Output Phase-C	For Speed/Torque Control and Position Control

Divided encoder signals are output.

Always connect these signal terminals when a position loop is formed in the host controller to perform position control.

Set a dividing ratio in the following user constant.

Dividing ratio setting	Cn-0A	PGRAT
-------------------------------	-------	-------

The dividing ratio setting is not relevant to the gear ratio setting (Cn-24, 25) for the electronic gear function of the Servopack for position control.

Output Phase Form

(Incremental Encoder)

Forward rotation

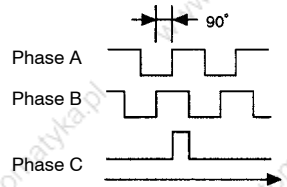

Reverse rotation

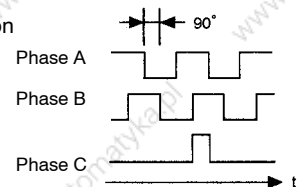

(Absolute Encoder)

Forward rotation

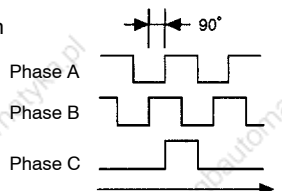

Reverse rotation

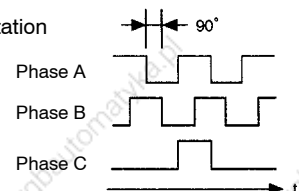

APPLICATIONS OF Σ -SERIES PRODUCTS

3.2.3 Using Encoder Output cont.

→ Input SEN 1CN-4	SEN Signal Input	For Speed/Torque Control and Position Control
→ Input 0SEN 1CN-2	SEN Signal Input	For Speed/Torque Control and Position Control
Output → PSO 1CN-48	Encoder Output Phase-S	For Speed/Torque Control and Position Control
Output → ★PSO 1CN-49	Encoder Output Phase-S	For Speed/Torque Control and Position Control
→ Input BAT \oplus 1CN-21	Battery (+)	For Speed/Torque Control and Position Control
→ Input BAT \ominus 1CN-22	Battery (-)	For Speed/Torque Control and Position Control

Use these signals (SEN to BAT \ominus) for absolute encoders. For details, refer to 3.8.5 Using an Absolute Encoder.

Output → SG 1CN-1	Signal Ground for Encoder Output	For Speed/Torque Control and Position Control
Output → FG 1CN-50	Frame Ground	For Speed/Torque Control and Position Control

SG: Connect to 0 V on the host controller.

FG: Connect to the cable shielded wire.

- 3) Use the following memory switch to specify the type of the encoder to be used.

Cn-02 Bit 9	Encoder Type Selection	Factory Setting: 0	For Speed/Torque Control and Position Control
-------------	------------------------	--------------------	---

Sets the encoder type according to the servomotor type as shown in the table.

After changing the memory switch setting, always turn the power OFF, then ON.

Motor Type	Encoder Type	Setting
SGM-□□□31□ SGMP-□□□31□	Incremental encoder	0
SGM-□□□W1□ SGMP-□□□W1□	Absolute encoder	1

4) Set the pulse dividing ratio in the following user constant.

Cn-0A	PGRAT Dividing Ratio Setting	Unit: P/R	Setting Range: 16 to No. of Encoder Pulses	Factory Setting: 2048	For Speed/Torque Control and Position Control
--------------	---------------------------------	--------------	--	-----------------------------	---

Sets the number of output pulses for PG output signals (PAO, *PAO, PBO and *PBO).

Pulses from motor encoder (PG) are divided by the preset number of pulses before being output.

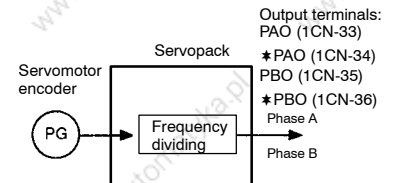

The number of output pulses per revolution is set in this user constant. Set this value according to the reference unit of the machine or controller to be used.

The setting range varies according to the encoder used.

Setting example:

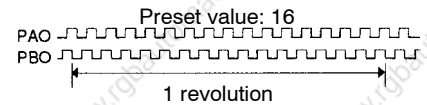

Motor Type	Number of Encoder Pulses Per Revolution	Setting Range
SGM-□□□31□ SGMP-□□□31□	Incremental encoder: 2048 pulses per revolution	16 to 2048
SGM-□□□W1□ SGMP-□□□W1□	Absolute encoder: 1024 pulses per revolution	16 to 1024

For the user constant Cn-0A, always turn the power OFF and then ON after changing the setting. This makes the new setting valid.

3.2.4 Using Contact I/O Signals

1) Contact Input Signal Terminal Connections

These signals are used to control DR2 Servopack operation. Connect these signal terminals as necessary.

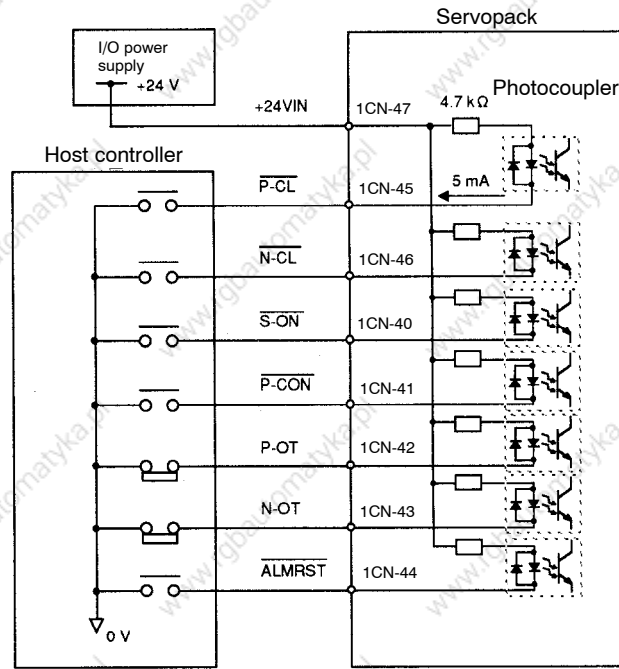

Note Provide an external I/O power supply separately. There are no power terminals to which the DR2 Servopack outputs signals externally.

External Power Supply: 24 ± 1 VDC
50 mA or more

Yaskawa recommends that this external power supply be the same type as for the output circuit.

→ Input +24VIN 1CN-47	I/O Power Supply	For Speed/Torque Control and Position Control
-----------------------	------------------	---

This external power supply input terminal is common to the following contact input signals:

- Contact Input Signals:**
- P-CL** (1CN-45)
 - N-CL** (1CN-46)
 - S-ON** (1CN-40)
 - P-CON** (1CN-41)
 - P-OT** (1CN-42)
 - N-OT** (1CN-43)
 - ALMRST** (1CN-44)

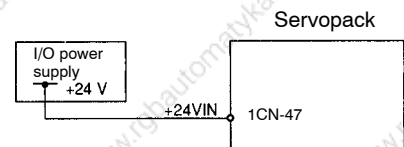

Connect an external I/O power supply.

2) Contact Output Signal Terminal Connections

These output signals are used to indicate DR2 Servopack operation status.

Photocoupler output
Per output
Maximum operational voltage: 30 VDC
Maximum output current: 50 mA DC

Open collector output
Per output
Maximum operational voltage: 30 VDC
Maximum output current: 20 mA DC

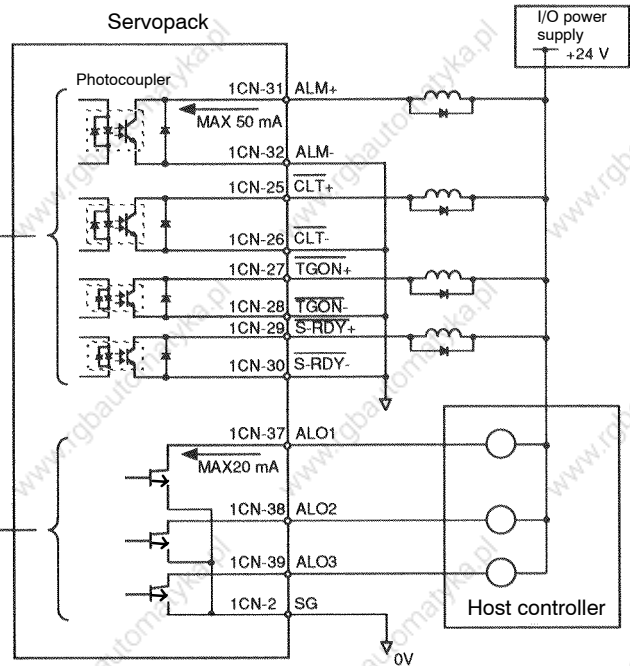

Note Provide an external I/O power supply separately. There are no power terminals to which the DR2 Servopack outputs signals externally. Yaskawa recommends that this external power supply be the same type as for the input circuit.

Output → SG	1CN-2	Signal Ground for Alarm Code Output Signal	For Speed/Torque Control and Position Control
--------------------	--------------	--	---

This signal ground is used for the following output signals. Connect to 0 V on the external power supply.

Contact Output Signals: ALO1 (1CN-37)
ALO2 (1CN-38)
ALO3 (1CN-39)

3.2.5 Using Electronic Gear

For position control only.

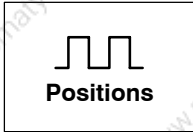

1) Outline

The electronic gear function enables the motor travel distance per input reference pulse to be set to any value. It allows the host controller to perform control without having to consider the machine gear ratio and the number of encoder pulses.

When Electronic Gear Function is Not Used

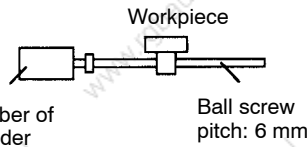

To move a workpiece 10 mm,

One revolution is equivalent to 6 mm, so
 $10 \div 6 = 1.6666$ (revolutions)

2048 x 4 (pulses) is equivalent to one revolution, so
 $1.6666 \times 2048 \times 4 = 13653$ (pulses)

A total of 13653 pulses must be input as a reference.
 the host controller needs to make this calculation.

When Electronic Gear Function is Used

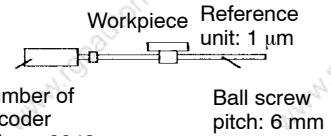

Machine conditions and reference unit must be defined for the electronic gear function beforehand.

To move a workpiece 10 mm:

Reference unit is 1 μm, so
 $10 \text{ mm} \div 1 \mu\text{m} = 10000$ pulses

2) Setting the Electronic Gear

Calculate the electronic gear ratio (B/A) according to the procedure below and set the value in Cn-24 and Cn-25.

a) Check the machine specifications.

Items related to electronic gear:

- Gear ratio
- Ball screw pitch
- Pulley diameter

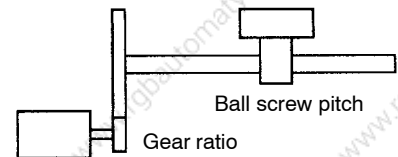

b) Check the number of encoder pulses for the SGM Servomotor.

Motor Type	Encoder Type	Number of Encoder Pulses Per Revolution
SGM-□□□31□ SGMP-□□□31□	Incremental encoder	2048
SGM-□□□W1□ SGMP-□□□W1□	Absolute encoder	1024

Same as user constant Cn-11 settings.

- c) Determine the reference unit to be used.

Reference unit is the minimum unit of position data used for moving the load. (Minimum unit of reference from host controller)

Examples:
0.01 mm, 0.001 mm, 0.1°, 0.01 inch

Reference input of one pulse moves the load by one reference unit.

Example: When reference unit is 1 μm
 If a reference of 50,000 pulses is input, the load moves 50 mm (50,000 × 1 μm).

To move a table in 0.001 mm units
 Reference unit: 0.001 mm

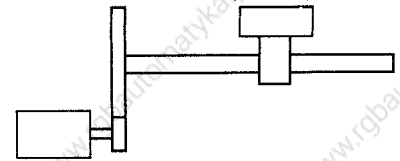

Determine the reference unit according to machine specifications and positioning accuracy.

- d) Determine the load travel distance per revolution of load shaft in reference units.

Load travel distance per revolution of load shaft (in reference units)

$$= \frac{\text{Load travel distance per revolution of load shaft (in unit of distance)}}{\text{Reference unit}}$$

Example: When ball screw pitch is 5 mm and reference unit is 0.001 mm
5/0.001 = 5,000 (reference units)

Ball Screw	Disc Table	Belt & Pulley
<p>1 revolution = $\frac{P}{\text{Reference unit}}$</p>	<p>1 revolution = $\frac{360^\circ}{\text{Reference unit}}$</p>	<p>1 revolution = $\frac{\pi D}{\text{Reference unit}}$</p>

- e) Determine the electronic gear ratio $\left(\frac{B}{A}\right)$.

If the load shaft makes “n” revolutions when the motor shaft makes “m” revolutions, the gear ratio of motor shaft and load shaft is $\frac{n}{m}$.

$$\text{Electronic gear ratio } \left(\frac{B}{A}\right) = \frac{\text{Number of encoder pulses} \times 4}{\text{Travel distance per revolution of load shaft (in reference units)}} \times \frac{m}{n}$$

NOTE Make sure that the electronic gear ratio meets the following condition:

$$0.01 \leq \text{Electronic gear ratio } \left(\frac{B}{A}\right) \leq 100$$

If the electronic gear ratio is outside this range, the Servopack does not work properly. In this case, modify the load configuration or reference unit.

APPLICATIONS OF Σ-SERIES PRODUCTS

3.2.5 Using Electronic Gear cont.

- f) Set the electronic gear ratio in the user constants below.

Reduce the electronic gear ratio $\left(\frac{B}{A}\right)$ to their lowest terms so that both A and B are an integer smaller than 65535, then set A and B in the following user constants.

$\left(\frac{B}{A}\right)$	Cn-24	RATB	Electronic gear ratio (numerator)
	Cn-25	RATA	Electronic gear ratio (denominator)

This is all that is required to set the electronic gear.

Cn-24	RATB Electronic Gear Ratio (Numerator)	Unit: None	Setting Range: 1 to 65535	Factory Setting: 4	For Position Control Only
Cn-25	RATA Electronic Gear Ratio (Denominator)	Unit: None	Setting Range: 1 to 65535	Factory Setting: 1	For Position Control Only

These user constants are for position control only.

Set the electronic gear ratio according to machine specifications.

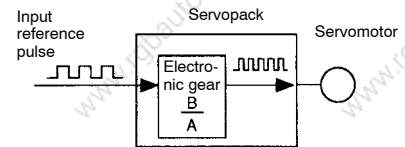

$$\text{Electronic gear ratio } \left(\frac{B}{A}\right) = \frac{\text{Cn-24}}{\text{Cn-25}}$$

$$B = [(\text{Number of encoder pulses}) \times 4] \times [\text{Motor shaft rotating speed}]$$

$$A = [\text{Load travel distance per revolution of load shaft (Reference unit)}] \times [\text{Load shaft rotating speed}]$$

Note that the user constant settings must meet the following condition:

$$0.01 \leq \left(\frac{B}{A}\right) \leq 100$$

3) Examples of Setting an Electronic Gear Ratio for Different Load Mechanisms

Ball Screw

Reference unit: 0.001 mm

Travel distance per revolution of load shaft = $\frac{6mm}{0.001mm} = 6000$

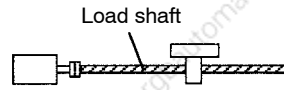

Incremental encoder:
2048 pulses per revolution

Ball screw pitch: 6 mm

$$\text{Electronic gear ratio } \left(\frac{B}{A}\right) = \frac{2048 \times 4 \times 1}{6000 \times 1} = \frac{Cn-24}{Cn-25}$$

Preset values	Cn-24	8192
	Cn-25	6000

Disc Table

Reference unit:
0.1°

Travel distance per revolution of load shaft = $\frac{360^\circ}{0.1^\circ} = 3600$

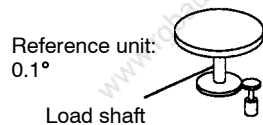

Incremental encoder:
2048 pulses per revolution

Gear ratio:
3 : 1

$$\text{Electronic gear ratio } \left(\frac{B}{A}\right) = \frac{2048 \times 4 \times 3}{3600 \times 1} = \frac{Cn-24}{Cn-25}$$

Preset values	Cn-24	24576
	Cn-25	3600

Belt & Pulley

Reference unit: 0.0254 mm
Load shaft

Travel distance per revolution of load shaft = $\frac{3.14 \times 100mm}{0.0254mm} = 12362$

Gear ratio:
2.4 : 1

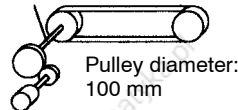

Absolute encoder:
1024 pulses per revolution

Pulley diameter:
100 mm

$$\text{Electronic gear ratio } \left(\frac{B}{A}\right) = \frac{1024 \times 4 \times 2.4}{12362 \times 1} = \frac{Cn-24}{Cn-25}$$

$$= \frac{9830.4}{12362} = \frac{49152}{61810}$$

Preset values	Cn-24	49152
	Cn-25	61810

4) Control Block Diagram for Servopack for Position Control

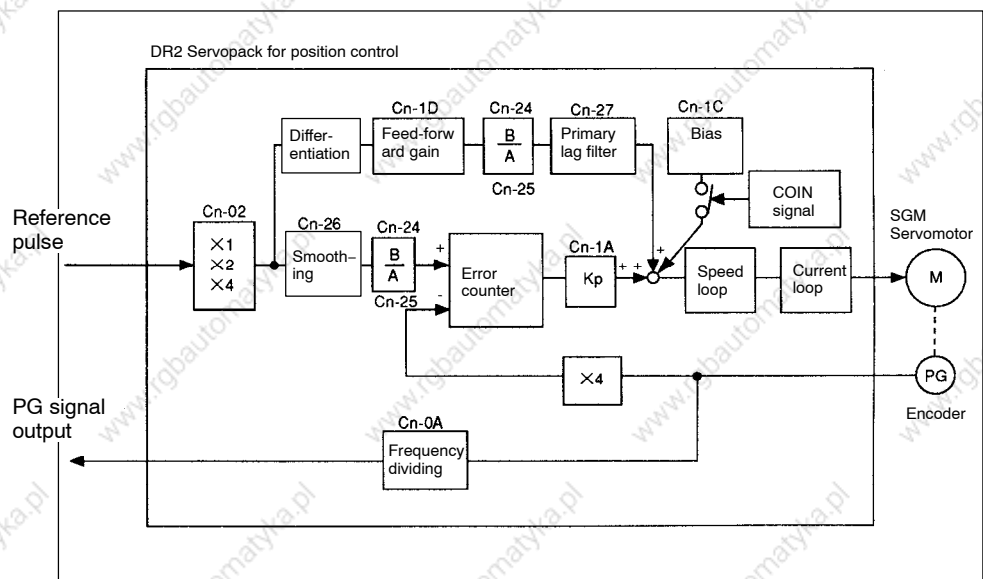

3.2.6 Using Contact Input Speed Control

- 1) The contact input speed control function provides easy-to-use speed control. It allows the user to initially set three different motor speeds in user constants, select one of the speeds externally by contact input and run the motor.

This function can be used for both speed/torque control and position control.

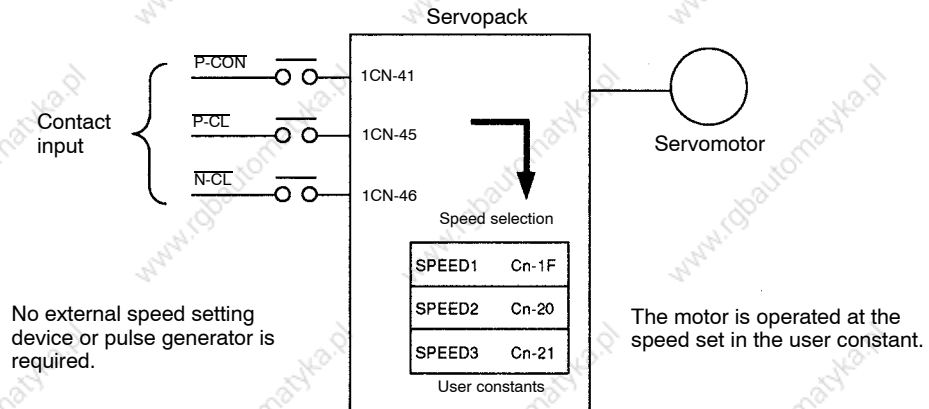

- 2) To use the contact input speed control function, perform Steps a) to c).

- a) Set the following memory switch to 1.

Cn-02 Bit 2	Contact Input Speed Control Selection	Factory Setting: 0	For Speed/Torque Control and Position Control
--------------------	---------------------------------------	--------------------	---

Enables the contact input speed control function.

If the contact input speed control function is used, the contents of the input signals shown below will change.

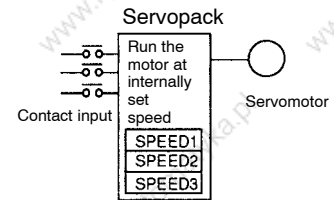

When this memory switch is reset, the meanings of the following signals will also change:

Monitor mode (Un-05) bit 7 and bit 8

Setting	Meaning	Input Signal	
0	Does not use the contact input speed control function.	P-CON(1CN-41)	Used to switch between P control and PI control.
		P-CL(1CN-45)	Used for forward external torque limit input
		N-CL(1CN-46)	Used for reverse external torque limit input
1	<p>Uses the contact input speed control function.</p> <p>Note In the case of the position control type, the reference pulse inhibit function (INHIBIT) cannot be used.</p>	0: OFF, 1: ON	
		P-CON	P-CL
		N-CL	Speed Setting
		Direction of rotation	0 0 Stop (or pulse reference)
		0: Forward	0 1 Cn-1F, SPEED1
		1: Reverse	1 1 Cn-20, SPEED2
			1 0 Cn-21, SPEED3

b) Set three motor speeds in the following user constants.

Constant	Description	Unit	Setting Range	Factory Setting	Application
Cn-1F	SPEED1 1st Speed (Contact Input Speed Control)	r/min	Setting Range: 0 to Maximum Speed	Factory Setting: 100	For Speed/Torque Control and Position Control
Cn-20	SPEED2 2nd Speed (Contact Input Speed Control)	r/min	Setting Range: 0 to Maximum Speed	Factory Setting: 200	For Speed/Torque Control and Position Control
Cn-21	SPEED3 3rd Speed (Contact Input Speed Control)	r/min	Setting Range: 0 to Maximum Speed	Factory Setting: 300	For Speed/Torque Control and Position Control

Use these user constants to set motor speeds when the contact input speed control function is used (set bit 2 of memory switch Cn-02).

Speed selection input signals $\overline{P-CL}$ (1CN-45) and $\overline{N-CL}$ (1CN-46), and rotation direction selection signal $\overline{P-CON}$ (1CN-41) enable the motor to run at the preset speeds.

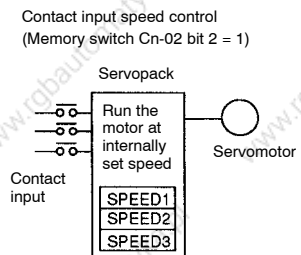

c) Set the soft start time (for speed/torque control only).

Constant	Description	Unit	Setting Range	Factory Setting	Application
Cn-07	SFSACC Soft Start Time (Acceleration)	ms	Setting Range: 0 to 10000	Factory Setting: 0	For Speed/Torque Control and Position Control
Cn-23	SFSDEC Soft Start Time (Deceleration)	ms	Setting Range: 0 to 10000	Factory Setting: 0	For Speed/Torque Control and Position Control

3.2.6 Using Contact Input Speed Control.

In the Servopack, a speed reference is multiplied by the preset acceleration or deceleration value to provide speed control.

When a progressive speed reference is input or contact input speed control is used, smooth speed control can be performed. (For normal speed control, set "0" in each user constant.)

Set the following value in each user constant.

- Cn-07: Time interval from the time the motor starts until it reaches the maximum speed (4,500 r/min)
- Cn-23: Time interval from the time the motor is running at the maximum speed (4500 r/min) until it stops

Note For position control type, the soft start function is available only when the contact input speed control function is used.

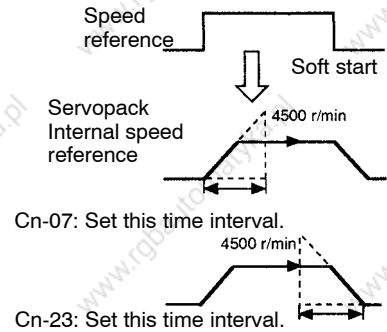

3) Contact input speed control performs the following operation.

The following input signals are used to start and stop the motor.

→ Input P-CL 1CN-45	Speed Selection 1 (Forward External Torque Limit Input)	For Speed/Torque Control and Position Control
→ Input N-CL 1CN-46	Speed Selection 2 (Reverse External Torque Limit Input)	For Speed/Torque Control and Position Control

a) Contact Input Speed Control when Cn-02 bit 2 = 1

- For Speed/Torque Control:

0: OFF, 1: ON

Contact Signal			User Constant			Selected Speed	
P-CON	P-CL	N-CL	Cn-02	Cn-01			
			Bit 2	Bit A	Bit B		
----	0	0	1	0	0	Stop	Stopped by speed reference 0
				1	0		Stopped by zero-clamp (Refer to 3.4.3.)
				0	1		Analog speed reference (V-REF) input
				1	1		With zero-clamp function
Direction of rotation 0: Forward 1: Reverse	0	1		----	----		SPEED1 (Cn-1F)
	1	1					SPEED2 (Cn-20)
	1	0					SPEED3 (Cn-21)

Preset values (0 or 1) and input signal status in the portions indicated by horizontal bars (-) are optional.

- For Position Control:

0: OFF, 1: ON

Contact Signal			User Constant		Selected Speed
P-CON	P-CL	N-CL	Cn-02	Cn-01	
			Bit 2	Bit F	
----	0	0	1	0	Stop
				1	Pulse reference input
Direction of rotation 0: Forward rotation 1: Reverse rotation	0	1		----	SPEED (Cn-1F)
	1	1			SPEED (Cn-20)
	1	0			SPEED (Cn-21)

Preset values (0 or 1) and input signal status in the portions indicated by horizontal bars (–) are optional.

Note When the contact input speed control function is used, the reference pulse inhibit function is not available.

b) Standard Setting when Cn-02 bit 2 = 0

Input signals are used as external torque limit input.

Input signal $\overline{\text{P-CON}}$ is used to specify the direction of motor rotation.

→ Input $\overline{\text{P-CON}}$ 1CN-41	Proportional Control, etc.	For Speed/Torque Control and Position Control
--	----------------------------	---

a) Contact Input Speed Control when Cn-02 bit 2 = 1

Use input signal $\overline{\text{P-CON}}$ to specify the direction of motor rotation.

P-CON	Meaning
1	Reverse rotation
0	Forward rotation

0: OFF (high level), 1: ON (low level)

b) Standard Setting when Cn-02 bit 2 = 0

$\overline{\text{P-CON}}$ signal is used for proportional control, zero-clamp and torque/speed control changeover.

Note For the speed/torque control, control by external reference (voltage reference) is possible when the contact input speed control function is used by setting bits A and B of user constant Cn-01.

For the position control, control by external reference (pulse reference) is possible when the contact input speed control function is used by setting bit F of user constant Cn-01.

3.2.6 Using Contact Input Speed Control cont.

- 4) The figure below illustrates an example of operation in contact input speed control mode. Using the soft start function reduces physical shock at speed changeover.

When Contact Input Speed Control is Used

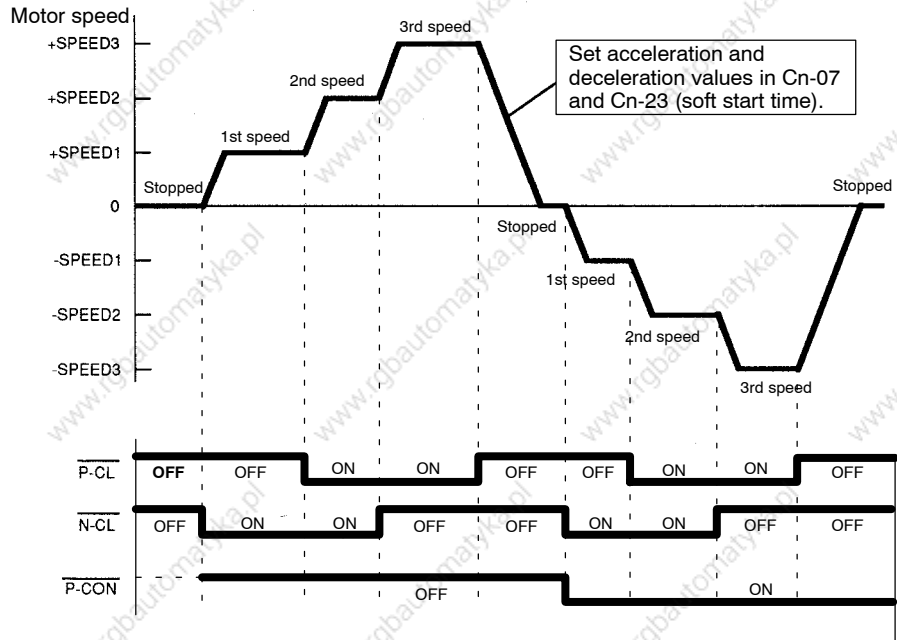

Note For the position control, the soft start function is available only when contact input speed control is used. The soft start function is not available when pulse reference input is used.

For the position control type, if contact input speed control mode is switched to pulse reference input mode when the motor is running at the 1st, 2nd or 3rd speed, the Servopack does not receive a pulse reference until positioning complete signal $\overline{\text{COIN}}$ is output.

Always start outputting a pulse reference from the host controller after a positioning complete signal is output from the Servopack.

Signal Generation Timing for Position Control Type

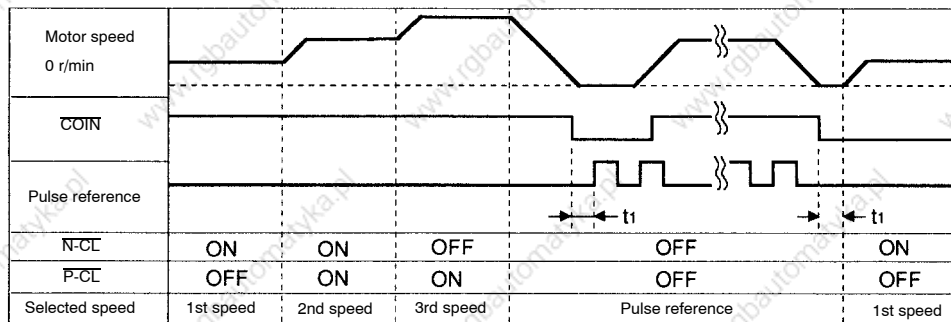

$t_1 > 6 \text{ ms}$

The above figure illustrates signal generation timing when the soft start function is used.

The value of t_1 is not influenced by use of the soft start function.

A maximum of 6 ms delay occurs when $\overline{\text{P-CL}}$ or $\overline{\text{N-CL}}$ signal is read.

3.2.7 Using Torque Control

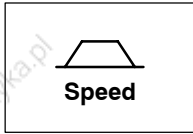

1) The Servopack can provide the following torque control:

- Torque restriction
 - Level 1: To restrict the maximum output torque to protect the machine or workpiece
 - Level 2: To restrict torque after the motor moves the machine to a specified position
- Torque control
 - Level 3: To always control output torque, not speed
 - Level 4: To switch between speed control and torque control

This section describes how to use levels 3 and 4 of the torque control function.

2) Use the following memory switch to select level 3 (torque control I) or level 4 (torque control II).

Cn-01 Bit A	Control Mode Selection	Factory Setting: 0	For Speed/Torque Control Only
Cn-01 Bit B	Control Mode Selection	Factory Setting: 0	For Speed/Torque Control Only

This is dedicated torque control.

A motor torque reference value is externally input into the Servopack to control torque.

Examples of Use: Tension control Pressure control

Cn-01 Setting		Control Mode
Bit B	Bit A	
1	0	<p>Torque Control I</p> <p>This is a dedicated torque control mode.</p> <div style="text-align: right;"> </div> <ul style="list-style-type: none"> • A torque reference is input from T-REF (1CN-9). • P-CON is not used. • Speed reference input V-REF (1CN-5) cannot be used. • User constant Cn-14 can be used for maximum speed control. <p>Example of Use:</p> <div style="text-align: center;"> </div>

Cn-01 Setting		Control Mode				
Bit B	Bit A					
1	1	<p>Torque Control II</p> <p>Torque control and speed control can be switched.</p> <ul style="list-style-type: none"> • A speed reference or speed limit value is input from V-REF (1CN-5). • T-REF (1CN-9) inputs a torque reference, torque feed-forward reference or torque limit value depending on the control mode used. • P-CON (1CN-41) is used to switch between torque control and speed control. <table border="1"> <tr> <td>When 1CN-41 is open</td> <td>Torque control</td> </tr> <tr> <td>When 1CN-41 is at 0 V</td> <td>Speed control</td> </tr> </table> <div style="float: right; margin-top: 20px;"> <p>Servopack</p> <p>Speed reference V-REF (1CN-5)</p> <p>Torque reference T-REF (1CN-9)</p> <p>Switching between speed and torque reference P-CON (1CN-41)</p> </div>	When 1CN-41 is open	Torque control	When 1CN-41 is at 0 V	Speed control
When 1CN-41 is open	Torque control					
When 1CN-41 is at 0 V	Speed control					
1	1	<p>For Torque Control when P-CON is OFF:</p> <ul style="list-style-type: none"> • T-REF reference controls torque. • V-REF can be used to limit motor speed. • V-REF voltage (+) limits motor speed during forward or reverse rotation. <p>Principle of Speed Restriction:</p> <p>When the speed exceeds the speed limit, negative feedback of torque proportional to the difference between the current speed and the limit speed is performed to return the speed to within the normal speed range. Therefore, the actual motor speed limit value has a certain range depending on the load conditions.</p> <div style="float: right; margin-top: 20px;"> <p>Motor speed</p> <p>Speed limit range</p> <p>V-REF</p> </div>				

3

Cn-01 Setting		Control Mode				
Bit B	Bit A					
1	1	For Speed Control when P-CON is ON: Values set in bit F of user constant Cn-01 and bit F of Cn-02 determine the following:				
		User Constant		Speed Reference Input (V-REF) (1CN-5,-6)	Torque Reference Input (T-REF) (1CN-9,-10)	Remarks
		Cn-01	Cn-02			
		Bit F	Bit F			
0	0	Speed control				
		Speed reference	Cannot be used			
1	---	Speed control with torque feed-forward		Any value can be set in bit F of Cn-02 (0 and 1 have the same effect).		
		Speed reference	Torque feed-forward	For details of speed control with torque feed-forward, refer to 3.2.8 Using Torque Feed-forward Function.		
0	1	Speed control with torque limit by analog voltage reference		For details of speed control with torque limit by analog voltage reference, refer to 3.2.9 Using Torque Restriction by Analog Voltage Reference.		
		Speed reference	Torque limit value			
0	0	Speed control (Standard setting)				
0	1	Zero-clamp speed control (Refer to 3.4.3.)				

3) The following input signals perform torque control.

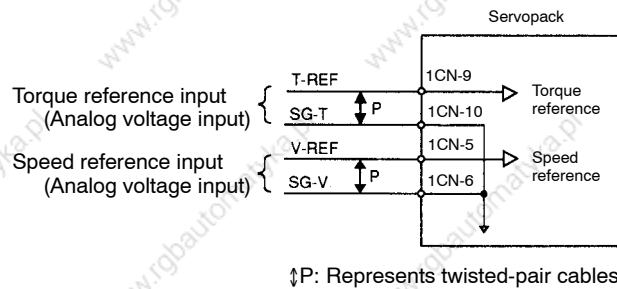

3.2.7 Using Torque Control cont.

→ Input T-REF 1CN-9	Torque Reference Input	For Speed/Torque Control Only
→ Input SG-T 1CN-10	Signal Ground for Torque Reference Input	For Speed/Torque Control Only

These signals are used when torque control is selected (bits A and B of memory switch Cn-01).

Motor torque is controlled so that it is proportional to the input voltage between T-REF and SG-T.

Standard Setting

Cn-13 = 30: This setting means that 3 V is equivalent to rated torque.

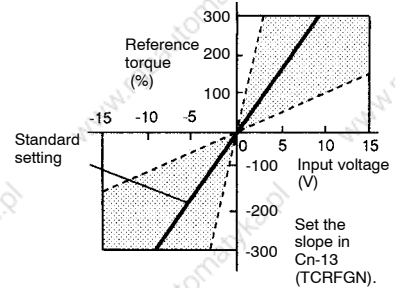

- Examples:
- +3 V input → Rated torque in forward direction
 - +9 V input → 300% of rated torque in forward direction
 - 0.3 V input → 10% of rated torque in reverse direction

User constant Cn-13 can be used to change the voltage input range.

Example of Input Circuit:
See the figure on the right.

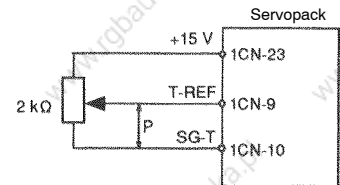

- For noise control, always use twisted-pair cables.
- Example of Variable Resistor for Speed Setting:
Type 25HP-10B manufactured by Sakae Tsushin Kogyo Co., Ltd.

→ Input V-REF 1CN-5	Speed Reference Input (or Speed Limit Input)	For Speed/Torque Control Only
→ Input SG-V 1CN-6	Signal Ground for Speed Reference Input	For Speed/Torque Control Only

These signals are used when speed control is selected (bits A and B of memory switch Cn-01).

For normal speed control, always connect these signal terminals.

Motor speed is controlled so that it is proportional to the input voltage between V-REF and SG-V.

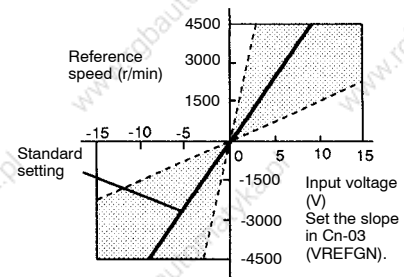

Standard Setting

Cn-03 = 500: This setting means that 6 V is equivalent to rated speed (3000 r/min).

- Examples:
- +6 V input → 3000 r/min in forward direction
 - +1 V input → 500 r/min in forward direction
 - 3 V input → 1500 r/min in reverse direction

User constant Cn-03 can be used to change the voltage input range. (This is also applicable to speed restriction.)

Example of Input Circuit:
See the figure on the right.

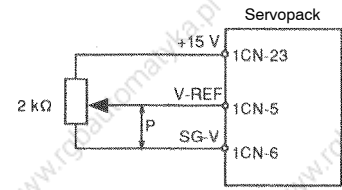

- For noise control, always use twisted-pair cables.
- Example of Variable Resistor for Speed Setting:
Type 25HP-10B manufactured by Sakae Tsushin Kogyo Co., Ltd.

When input signal $\overline{\text{P-CON}}$ is used to switch between speed reference and torque reference for torque control II, set both bits A and B of memory switch Cn-01 to 1.

→ Input $\overline{\text{P-CON}}$ 1CN-41	Proportional Control, etc.	For Speed/Torque Control and Position Control
--	----------------------------	---

The function of this input signal varies according to the memory switch setting.

Cn-02 Bit 2	Cn-01 Bit B	Cn-01 Bit A	Function of $\overline{\text{P-CON}}$
0	0	0	Proportional control (Standard setting)
0	0	1	Speed control with zero-clamp function Switching between zero-clamp enabled/prohibited mode
0	1	0	Torque control I (P-CON is not used.)
0	1	1	Torque control II
1	-	-	Changing the direction of rotation during contact input speed control.

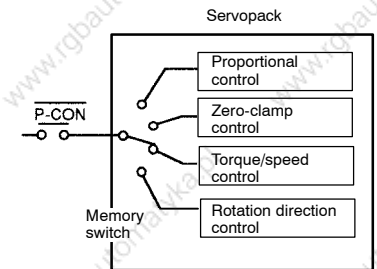

The function of $\overline{\text{P-CON}}$ signal varies according to the memory switch setting.

APPLICATIONS OF Σ-SERIES PRODUCTS

3.2.7 Using Torque Control cont.

• Torque/Speed Changeover Control

This function is used to switch between torque control and speed control in torque control II mode.

ON: 1CN-41 is at low level.	Speed control
OFF: 1CN-41 is at high level.	Torque control

4) Set the following user constants for torque control according to the servo system used.

Cn-13	TCRFGN Torque Reference Gain	Unit: 0.1 V/Rated Torque	Setting Range: 10 to 100	Factory Setting: 30	For Speed/Torque Control Only
--------------	---------------------------------	-----------------------------	-----------------------------	------------------------	-------------------------------

Sets the voltage range of torque reference input T-REF (1CN-9) according to the output form of the host controller or external circuit.

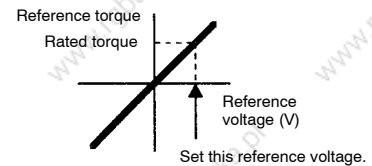

The factory setting is 30, so the rated torque is 3 V (30×0.1).

Cn-14	TCRLMT Speed Limit for Torque Control I	Unit: r/min	Setting Range: 0 to Maximum Speed	Factory Setting: Maximum Speed	For Speed/Torque Control Only
--------------	--	----------------	-----------------------------------	-----------------------------------	-------------------------------

Sets a motor speed limit value in this constant when torque control I is selected.

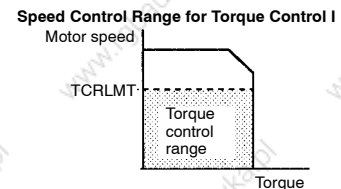

This user constant is used to prevent machine overspeed during torque control.

For torque control I, set bits A and B of memory switch Cn-01.

Cn-03	VREFGN Speed Reference Gain	Unit: (r/min)/V	Setting Range: 10 to 2162	Factory Setting: 500	For Speed/Torque Control Only
--------------	--------------------------------	--------------------	------------------------------	-------------------------	-------------------------------

Sets the voltage range of speed reference input V-REF (1CN-3) according to the output form of the host controller or external circuit.

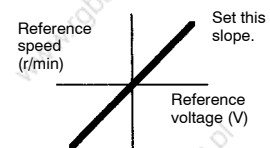

The factory setting is 500 [rated speed (3000 r/min)/6 V = 500].

3.2.8 Using Torque Feed-forward Function

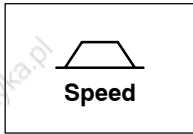

For speed control only.

1) Outline

The torque feed-forward function reduces positioning time. It differentiates a speed reference at the host controller (prepared by the customer) to generate a torque feed-forward reference, then sends this torque feed-forward reference and the speed reference to the Servopack.

Too high a torque feed-forward value will result in overshoot or undershoot. To prevent this, set the optimum value while observing system response.

Connect a speed reference signal line and torque feed-forward reference signal line from the host controller to V-REF (1CN-5, 1CN-6) and T-REF (1CN-9, 1CN-10), respectively.

Schematic Block Diagram for Torque Feed-forward Control

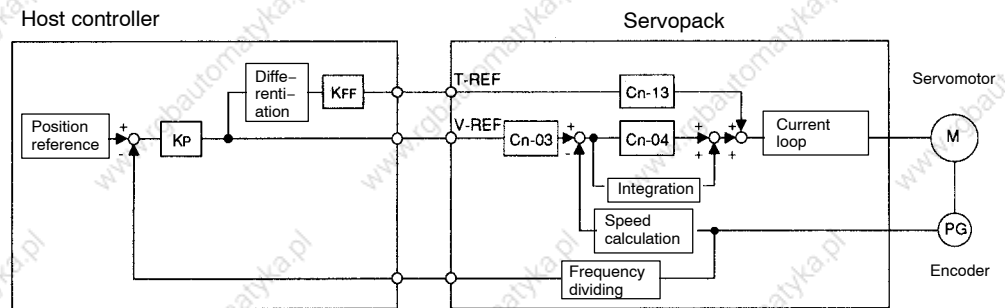

K_P: Position loop gain
K_{FF}: Feed-forward gain

2) How to Use Torque Feed-forward Function

To use the torque feed-forward function, set the following memory switch to 1.

Cn-01 Bit F	Selection of Torque Feed-forward Function	Factory Setting: 0	For Speed Control Only
--------------------	---	--------------------	------------------------

Enables the torque feed-forward function.

To use the torque feed-forward function, input a speed reference to the V-REF terminal and a torque feed-forward reference to the T-REF terminal.

The host controller must generate a torque feed-forward reference from a speed reference.

Setting	Meaning
0	Does not use the torque feed-forward function.
1	Uses the torque feed-forward function.

3.2.9 Using Torque Restriction by Analog Voltage Reference

- This function cannot be used with the function for torque restriction by analog voltage reference, described in 3.2.9 Using Torque Restriction by Analog Voltage Reference.
- For user constants and control modes, refer to Appendix D List of User Constants.

3) Setting a Torque Feed-forward Value in User Constant Cn-13

The factory setting is Cn-13 = 30. If, for example, the torque feed-forward value is ± 3 V, torque is restricted to $\pm 100\%$ (rated torque).

Cn-13	TCRFGN Torque Reference Gain	Unit: 0.1 V/Rated Torque	Setting Range: 10 to 100	Factory Setting: 30	For Speed/Torque Control Only
--------------	------------------------------------	--------------------------------	--------------------------------	---------------------------	----------------------------------

3

3.2.9 Using Torque Restriction by Analog Voltage Reference

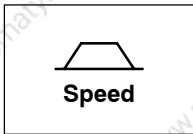

For speed control only.

1) Outline

This function restricts torque by assigning the T-REF terminal (1CN-9, 1CN-10) a torque limit value in terms of analog voltage. Since torque reference input terminal T-REF is used as an input terminal, this function cannot be used for torque control.

Schematic Block Diagram for Torque Restriction by Analog Voltage Reference

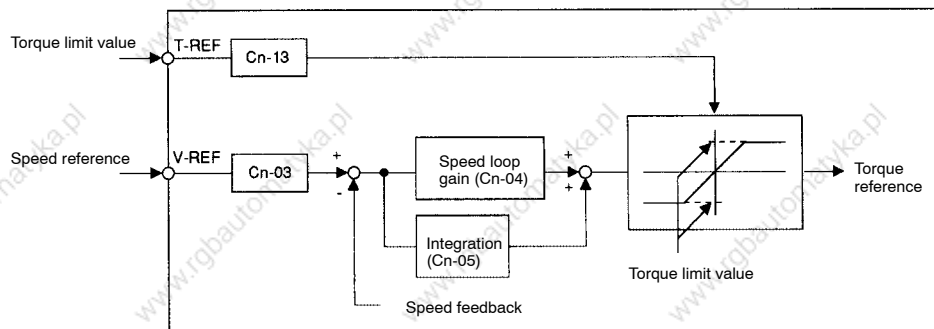

2) How to Use Torque Restriction by Analog Voltage Reference

To use this torque restriction function, set the following memory switch to 1.

Cn-02 Bit F	Torque Restriction by Analog Voltage Reference	Factory Setting: 0	For Speed Control Only
--------------------	--	--------------------	------------------------

Enables this torque restriction function.

To use this function, input a speed reference to the V-REF terminal and a torque limit value to the T-REF terminal.

This function cannot be used for torque control.

Torque restriction cannot be set separately for forward and reverse rotation. (The same setting applies to both forward and reverse rotation.)

Setting	Meaning
0	Uses the T-REF terminal as a torque reference or torque feed-forward reference input terminal.
1	Uses the T-REF terminal as a torque limit value input terminal.

- This function cannot be used with the torque feed-forward function described in 3.2.8 *Using Torque Feed-forward Function*.
- For user constants and control modes, refer to *Appendix D List of User Constants*.

3) Setting a Torque Limit Value in User Constant Cn-13

The factory setting is Cn-13 = 30. If, for example, the torque limit value is 3 V, torque is restricted to 100% (rated torque).

Cn-13	TCRFGN Torque Reference Gain	Unit: 0.1 V/ Rated Torque	Setting Range: 10 to 100	Factory Setting: 30	For Speed/Torque Control Only
--------------	------------------------------	---------------------------	--------------------------	---------------------	-------------------------------

3.2.10 Using the Reference Pulse Inhibit Function (INHIBIT)

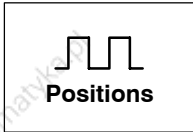

For position control only.

1) Outline

This function inhibits a position control from counting input reference pulses.

While this function is being used, the motor remains in servo locked (clamped) status. The P-CON signal is used to enable or prohibit this function.

When this function is used, therefore, the P-CON signal cannot be used to switch between proportion (P) control and proportional/integral (PI) control for speed loop. (PI control is always used.)

Schematic Block Diagram for INHIBIT Function

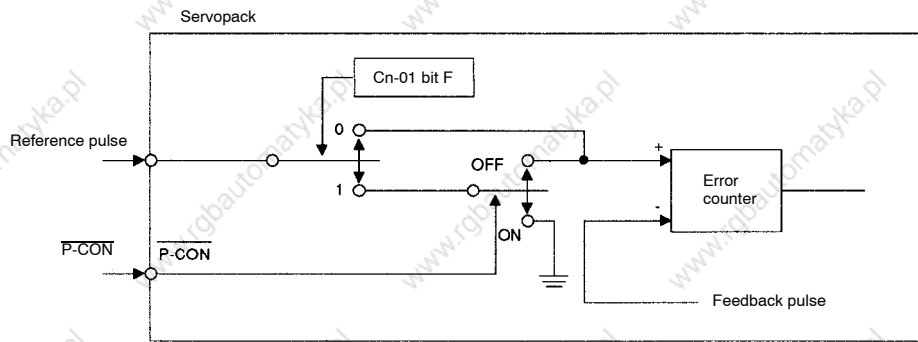

2) How to Use Reference Pulse Inhibit Function: INHIBIT

To use the INHIBIT function, set the following memory switch to 1:

Cn-01 Bit F	Reference Pulse Inhibit Function (INHIBIT)	Factory Setting: 0	For Position Control Only
--------------------	--	--------------------	---------------------------

Enables the INHIBIT function.

Setting	Meaning						
0	Does not use the INHIBIT function. Reference pulses are always counted.						
1	Uses the INHIBIT function. P-CON signal is used to enable or prohibit the INHIBIT function.						
	<table border="1"> <thead> <tr> <th>P-CON</th> <th>Meaning</th> </tr> </thead> <tbody> <tr> <td>OFF</td> <td>Counts reference pulses.</td> </tr> <tr> <td>ON</td> <td>Prohibits the Servopack from counting reference pulses. The motor remains in servo locked (clamped) status.</td> </tr> </tbody> </table>	P-CON	Meaning	OFF	Counts reference pulses.	ON	Prohibits the Servopack from counting reference pulses. The motor remains in servo locked (clamped) status.
	P-CON	Meaning					
OFF	Counts reference pulses.						
ON	Prohibits the Servopack from counting reference pulses. The motor remains in servo locked (clamped) status.						

- Always set bit 2 of memory switch Cn-02 to 0.
If bit 2 is set to 1, the contact input speed control function is selected, and the INHIBIT function cannot be used. (The P-CON signal is used for changing the motor rotation direction. For the contact input speed function, refer to 3.2.6 Using Contact Input Speed Control.)

3) Relationship between INHIBIT Signal and Reference Pulse

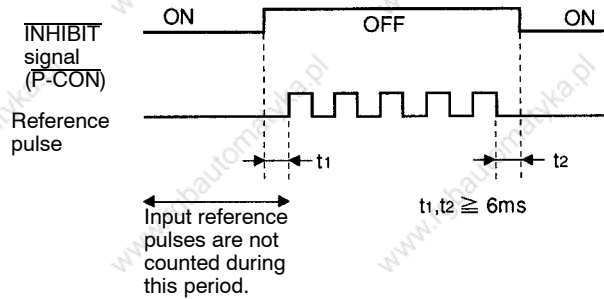

3.2.11 Using the Reference Pulse Input Filter Selection Function

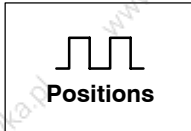

For position control only.

1) Outline

This function selects a reference pulse input filter inside the Servopack according to the output form of reference pulses from the host controller.

2) How to Use Reference Pulse Input Filter

Set the following memory switch according to the output form of reference pulses from the host controller:

Cn-02 Bit F	Reference Pulse Input Filter Selection Function	Factory Setting: 0	For Position Control Only
--------------------	---	--------------------	---------------------------

Sets the memory switch according to the output form (line driver or open collector) of reference pulses from the host controller.

Setting	Meaning
0	Output form of reference pulses from host controller: Line driver output (maximum frequency of reference pulse: 450 kpps)
1	Output form of reference pulses from host controller: Open collector output (maximum frequency of reference pulse: 200 kpps)

- For open collector output, the wire length must be as short as possible (maximum 3 m).

3.2.12 Using the Analog Monitor

1) The following two analog voltage monitor signals are output.

Output → TRQ-M 1CN-16	Torque monitor	For Speed/Torque Control
Output → VTG-M 1CN-17	Speed monitor	

TRQ-M : Torque monitor output ($\pm 3V/\pm 100\%$ torque)

VTG-M : Speed monitor output ($\pm 3V/\pm 1000$ r/min)

- As for the check terminals of the front panel:
 TMON is the same signal as TRQ-M
 VTG is the same signal as VTG-M

Signal ground for TMON and VTG is SG0V of check terminals.

The following memory switch is used to modify the signal specifications.

Cn-02	Bit 6	TRQ-M Specifications	Factory Setting: 0	For Speed/Torque Control
--------------	--------------	----------------------	--------------------	--------------------------

Setting	Meaning
0	Uses TRQ-M as the torque reference monitor output.
1	Uses TRQ-M as the speed reference monitor output.

3

3.3 Setting Up the Σ Servopack

This section describes how to set user constants to operate the DR2 Servopack.

3.3.1	Setting User Constants	103
3.3.2	Setting the Jog Speed	104
3.3.3	Setting the Number of Encoder Pulses	105
3.3.4	Setting the Motor Type	106

3.3.1 Setting User Constants

1) Σ -series Servopacks provide many functions, and have parameters called “user constants” to allow the user to specify each function and perform fine adjustment.

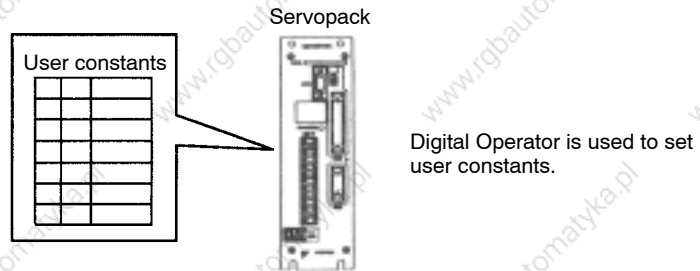

2) User constants are divided into the following two types.

1) Memory switch Cn-01, Cn-02	Each bit of this switch is turned ON or OFF to specify a function.
2) User constant setting Cn-03 and later	A numerical value such as a torque limit value or speed loop gain is set in this constant.

• For Speed/Torque Control:

User Constant	Name and Code		Remarks
Cn-01	Memory switch		Each bit number has a switch (ON/OFF).
Cn-02	Memory switch		
Cn-03	VREFGN	Speed reference gain	User constant setting
Cn-..	
Cn-..	
Cn-2A	PULSNO2	Number of external PG pulses	

3.3.2 Setting the Jog Speed

- For Position Control:

User Constant	Name and Code		Remarks
Cn-01	Memory switch		Each bit number has a switch (ON/OFF).
Cn-02	Memory switch		
Cn-04	LOOPHZ	Speed loop gain	User constant setting
Cn-..	
Cn-..	
Cn-2A	PULSNO2	Number of external PG pulses	

- 3) For a list of user constants, refer to *Appendix D List of User Constants*.

Some user constants for speed/torque control and position control have different meanings. Refer to a list of user constants for each type.

- 4) For details of how to set user constants, refer to *4.1.5 Operation in User Constant Setting Mode*

3.3.2 Setting the Jog Speed

- 1) Use the following user constant to set or modify a motor speed when operating the Σ -series Servo from a Digital Operator:

User Constant	Parameter Name	Unit	Setting Range	Factory Setting	Remarks
Cn-10	JOGSPD Jog Speed	r/min	Setting Range: 0 to Maximum Speed	Factory Setting: 500	For Speed/Torque Control and Position Control

This constant is used to set a motor speed when the motor is operated using a Digital Operator.

Operation Using Digital Operator



3.3.3 Setting the Number of Encoder Pulses

- 1) To ensure that the Σ -series Servo System operates properly, set the type of the encoder to be used and the number of encoder pulses per revolution in the following user constants:

Cn-02	Bit 9	Encoder Type Selection	Factory Setting: 0	For Speed/Torque Control and Position Control
--------------	--------------	------------------------	--------------------	---

Set the encoder type according to the servomotor type to be used.

After changing the memory switch setting, turn the power OFF, then ON.

Motor Type	Encoder Type	Preset Value
SGM-□□□31□ SGMP-□□□31□	Incremental encoder	0
SGM-□□□W1□ SGMP-□□□W1□	Absolute encoder	1

Cn-11	PULSNO Number of Encoder Pulses	Unit: Pulses Per Revolution	Setting Range: Number of Encoder Pulses	Factory Setting: 2048	For Speed/Torque Control and Position Control
--------------	------------------------------------	-----------------------------	---	-----------------------	---

Set the number of encoder pulses according to the servomotor type to be used. If this user constant is set incorrectly, system operation cannot be guaranteed.

After changing the user constant setting, turn the power OFF, then ON.

Motor Type	Number of Encoder Pulses Per Revolution	Preset Value
SGM-□□□31□ SGMP-□□□31□	Incremental encoder: 2048 pulses per revolution	2048
SGM-□□□W1□ SGMP-□□□W1□	Absolute encoder: 1024 pulses per revolution	1024

3.3.4 Setting the Motor Type

- 1) To ensure that the Σ -series Servo System operates properly, set the type of the servomotor to be used in the following user constant.

Cn-02 Bit 8	Motor Selection	Factory Setting: DR2-□□□□: 0 DR2-□□□□P: 1	For Speed/Torque Control and Position Control
--------------------	-----------------	---	--

Set this memory switch according to the servomotor type to be used (SGM or SGMP). After changing the memory switch setting, turn the power OFF, then ON. This makes the new setting valid.

Motor Type	Preset Value
SGM-□□□□□□	0
SGMP-□□□□□□	1

3

3.4 Setting Stop Mode

This section describes how to stop the motor properly.

3.4.1	Adjusting Offset	107
3.4.2	Using Dynamic Brake	108
3.4.3	Using Zero-Clamp	109
3.4.4	Using Holding Brake	110

3.4.1 Adjusting Offset

1) "Why does not the motor stop?"

When 0 V is specified as reference voltage for Servopack for speed/torque control, the motor may rotate at a very slow speed and fail to stop. This happens when reference voltage from the host controller or external circuit has a slight reference offset (in mV units). If this offset is adjusted to 0 V, the motor will stop.

When reference voltage from the host controller or external circuit has an offset

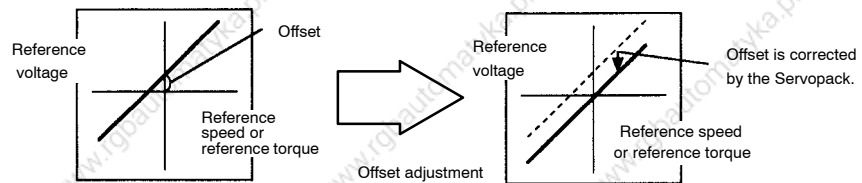

2) The following two methods can be used to adjust the reference offset to 0 V.

1) Automatic adjustment of reference offset	Reference offset is automatically adjusted to 0 V.
2) Manual adjustment of reference offset	Reference offset can be intentionally set to a specified value.

NOTE If a position control loop is formed in the host controller, do not use automatic adjustment in 1. Always use manual adjustment in 2.

3) For detailed adjustment procedures, refer to the following sections.

	Adjustment Method
1) Automatic adjustment of reference offset	4.2.4 Reference Offset Automatic Adjustment
2) Manual adjustment of reference offset	4.2.5 Speed Reference Offset Manual Adjustment Mode

3.4.2 Using Dynamic Brake

1) To stop the servomotor by applying **dynamic brake (DB)**, set desired values in the following memory switch. If dynamic brake is not used, the servomotor will stop naturally due to machine friction.

Cn-01 Bit 6	How to Stop Motor When Servo is Turned OFF	Factory Setting: 0	For Speed/Torque Control and Position Control
Cn-01 Bit 7	Operation to Be Performed When Motor Stops After Servo is Turned OFF	Factory Setting: 1	For Speed/Torque Control and Position Control

The Servopack enters servo OFF status when:

- Servo ON input signal ($\overline{S-ON}$, 1CN-40) is turned OFF
- Servo alarm arises
- Main power is turned OFF

Specify how to stop the motor when one of the above events occurs during operation.

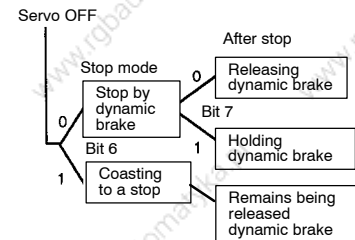

	Setting	Meaning
Cn-01 bit 6	0	Stops the motor by dynamic brake.
	1	Causes the motor to coast to a stop. The motor power is OFF and stops due to machine friction.

If dynamic brake stop mode is selected, specify the operation to be performed when the motor stops.

	Setting	Meaning
Cn-01 bit 7	0	Releases dynamic brake after the motor stops.
	1	Does not release dynamic brake even after the motor stop.



Dynamic brake (DB)

One of the general methods to cause a motor sudden stop. "Dynamic brake" suddenly stops a servomotor by shorting its electrical circuit. This dynamic brake circuit is incorporated in the Servopack.

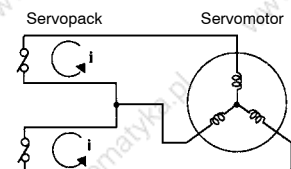

3.4.3 Using Zero-Clamp



- 1) The zero-clamp function is used for a system in which the host controller does not form a position loop by speed reference input.

In other words, this function is used to cause the motor to stop and enter a servo locked status when the input voltage of speed reference V-REF is not 0 V. When the zero-clamp function is turned ON, an internal position loop is temporarily formed, causing the motor to be clamped within one pulse. Even if the motor is forcibly rotated by external force, it returns to the zero-clamp position.

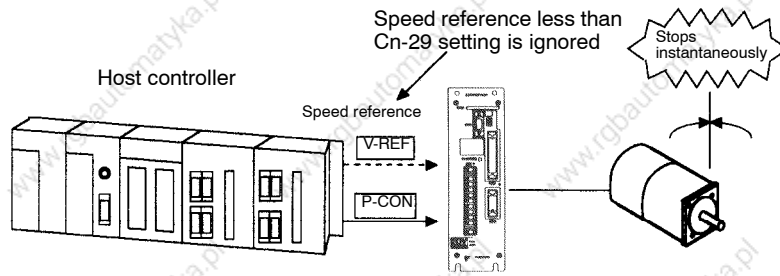

- 2) Set the following memory switch so that input signal P-CON can be used to enable or disable the zero-clamp function.

Cn-01Bit A	Control Mode Selection	Factory Setting:0	For Speed/Torque Control Only
Cn-01Bit B	Control Mode Selection	Factory Setting:0	For Speed/Torque Control Only

→ Input P-CON 1CN-41	Proportional Control, etc.	For Speed/Torque Control and Position Control
-----------------------------	----------------------------	---

Cn-01 Setting		Control Mode					
Bit B	Bit A						
0	1	<p>Zero-clamp Speed Control</p> <p>This speed control allows the zero-clamp function to be set when the motor stops.</p> <ul style="list-style-type: none"> • A speed reference is input from V-REF (1CN-5). • P-CON (1CN-41) is used to turn the zero-clamp function ON or OFF. <table border="1"> <tr> <td>P-CON (1CN-41) is open (OFF)</td> <td>Turns zero-clamp function OFF</td> </tr> <tr> <td>P-CON (1CN-41) is closed (ON)</td> <td>Turns zero-clamp function ON</td> </tr> </table> <ul style="list-style-type: none"> • Torque reference input T-REF (1CN-9) cannot be used. 	P-CON (1CN-41) is open (OFF)	Turns zero-clamp function OFF	P-CON (1CN-41) is closed (ON)	Turns zero-clamp function ON	<p>Servopack</p> <p>Zero-clamp is performed when the following two conditions are met: P-CON signal is closed. Motor speed is below the value set in Cn-29 (ZCLVL).</p>
P-CON (1CN-41) is open (OFF)	Turns zero-clamp function OFF						
P-CON (1CN-41) is closed (ON)	Turns zero-clamp function ON						

3.4.4 Using Holding Brake

- 3) Set in the following user constant the motor speed level at which zero-clamp is to be performed:

Cn-29	ZCLVL Zero-Clamp Level	Unit: r/min	Setting Range: 0 to Maximum Speed	Factory Setting: 10	For Speed Control Only
--------------	------------------------	-------------	-----------------------------------	---------------------	------------------------

If zero-clamp speed control is selected, set the motor speed level at which zero-clamp is to be performed.

Conditions for Zero-clamp

Zero-clamp is performed when all the following conditions are met:

- a) Zero-clamp speed control is selected. (Bits A and B of memory switch Cn-01 are set to 1 and 0, respectively.)
- b) $\overline{P-CON}$ (1CN-41) is turned ON (0 V).
- c) Motor speed drops below the preset value.

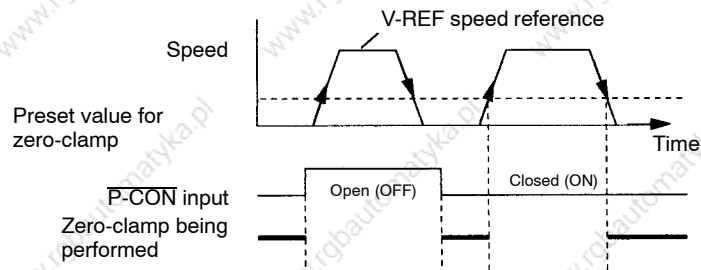

3.4.4 Using Holding Brake

1) Outline

Holding brake is useful when a servo drive is used to control a vertical axis. A servomotor with brake prevents the movable part from dropping due to gravitation when the system power is turned OFF.

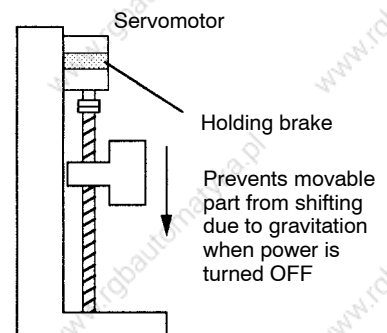

NOTE The built-in brake in Servomotor with brake is a de-energization operation type, which is used for holding purposes only and cannot be used for braking purposes. Use the holding brake only to retain a stopped motor. Brake torque is more than 100% of the rated motor torque.

- 2) Use Servopack contact output-signal $\overline{\text{TGON}}+$, $\overline{\text{TGON}}-$ and brake power supply to form a brake ON/OFF circuit.

An example of standard wiring is shown below.

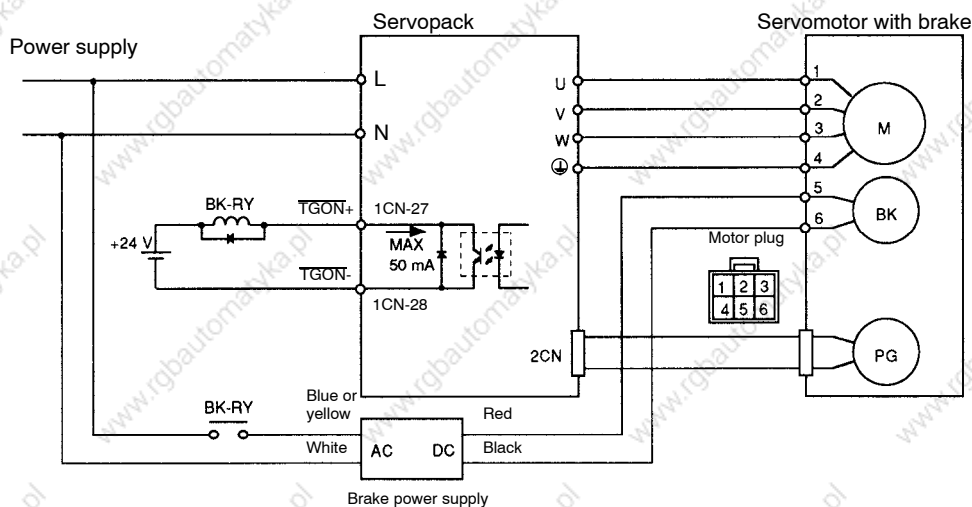

BK-RY: Brake control relay

Brake power supply has two types (200 V, 100 V).

Set the following memory switch to select the brake interlock output.

Cn-01	Bit E	Selection of $\overline{\text{TGON}}+$, $\overline{\text{TGON}}-$ Signals	Factory Setting: 0	For Speed/Torque Control and Position Control
--------------	--------------	--	--------------------	---

Set bit E of Cn-01 to 1 to select the brake interlock output.

Setting	Meaning
0	Uses the $\overline{\text{TGON}}+$, $\overline{\text{TGON}}-$ signals as the running output.
1	Uses the $\text{TGON}+$, $\text{TGON}-$ signals as the brake interlock output.

Output → $\text{TGON}+$ 1CN-27	Brake Interlock Output, etc.	For Speed/Torque Control and Position Control
Output → $\text{TGON}-$ 1CN-28		

This output signal controls the brake when a motor with brake is used. This signal terminal need not be connected when a motor without brake is used.

Related User Constants

Cn-12	Time delay from brake signal until servo OFF
Cn-15	Speed level for brake signal output during operation
Cn-16	Output timing of brake signal during motor operation

ON Status: Circuit between 1CN-27 and 1CN-28 is closed. 1CN-27 is at low level.	Releases the brake.
OFF Status: Circuit between 1CN-27 and 1CN-28 is open. 1CN-27 is at high level.	Applies the brake.

3.4.4 Using Holding Brake cont.

- 3) Between the brake is released and applied by brake power ($\overline{\text{TGON+}}$) ON/OFF, time delay occurs as follows:

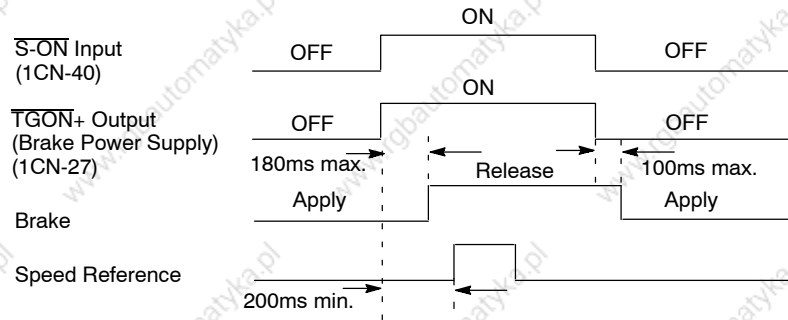

Min. 200ms is required between brake power ON ($\overline{\text{TGON+}}$) and speed reference input. As for the brake holding timing at servo OFF, refer to 4) and 5) shown below.

- 4) If the machine moves slightly due to gravity when the brake is applied, set the following user constant to adjust brake ON (brake holding) timing:

Cn-12	BRKTIM	Time delay from the time a brake signal is output until servo OFF status occurs	Unit: 10 ms	Setting Range: 0 to 50	Factory Setting: 0	For Speed/Torque Control and Position Control
--------------	--------	---	----------------	---------------------------	-----------------------	---

This user constant is used to set output timing of brake control signals $\overline{\text{TGON+}}$ (1CN-27), $\overline{\text{TGON-}}$ (1CN-28) and servo OFF operation (motor output stop) when SGM/SGMP Servomotor with brake is used.

This user constant is not available for alarm occurrence and main power OFF.

Brake Timing when Motor is in Stopped Status

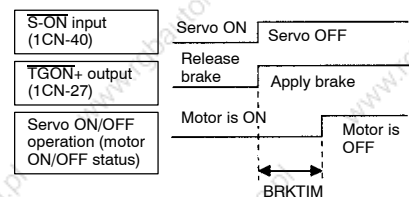

With the standard setting, the servo is turned OFF when $\overline{\text{TGON+}}$ signal (brake operation) is output. The machine may move slightly due to gravitation. This movement depends on machine configuration and brake characteristics. If this happens, use this user constant to delay servo OFF timing to prevent the machine from moving.

Set in this constant the brake ON timing used when the motor is in stopped status.

For brake ON timing during motor operation, use Cn-15 and Cn-16.

- 5) Set the following user constants to adjust brake ON timing so that holding brake is applied when the motor stops.

Cn-15	BRKSPD	Speed Level at which Brake Signal Is Output during Motor Operation	Unit: r/min	Setting Range: 0 to Maximum Speed	Factory Setting: 100	For Speed/Torque Control and Position Control
Cn-16	BRKWAI	Output Timing of Brake Signal during Motor Operation	Unit: 10 ms	Setting Range: 10 to 100	Factory Setting: 50	For Speed/Torque Control and Position Control

Cn-15 and Cn-16 are used for SGM/SGMP Servomotors with brake. Use these user constants to set brake timing used when the servo is turned OFF by input signal $\bar{S-ON}$ (1CN-40) or alarm occurrence during motor rotation.

Since brakes for SGM/SGMP Servomotors are designed as holding brakes, if brake is applied at motor running, brake generates excessive friction. Therefore, brake ON timing when the motor stops must be appropriate. Adjust the user constant settings while observing machine operation.

- Conditions for $\overline{TGON+}$ signal (1CN-27) output during motor operation. The circuit between 1CN-27 and 1CN-28 is opened in either of the following situations.

1	Motor speed drops below the value set in Cn-15 (BRKSPD) after servo OFF occurs.
2	The time set in Cn-16 (BRKWAI) has elapsed since servo OFF occurred.

Brake Timing when Motor is in Stopped Status

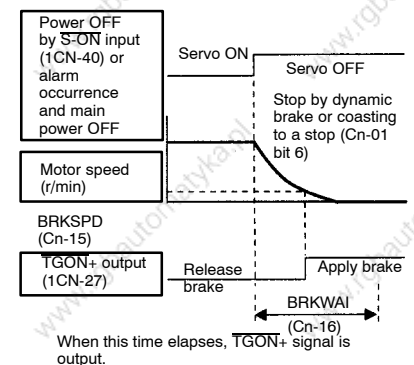

3.5 Running the Motor Smoothly

This section explains how to run the servomotor smoothly.

- 3.5.1 Using the Soft Start Function 114
- 3.5.2 Using the Smoothing Function 115
- 3.5.3 Adjusting Gain 115
- 3.5.4 Adjusting Offset 116
- 3.5.5 Setting the Torque Reference Filter Time Constant 116

3.5.1 Using the Soft Start Function

1) The soft start function adjusts progressive speed reference input inside the Servopack so that acceleration and deceleration can be as constant as possible. To use this function, set the following user constants.

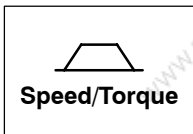

Cn-07	SFSACC Soft Start Time (Acceleration)	Unit: ms	Setting Range: 0 to 10000	Factory Setting: 0	For Speed/Torque Control Only
Cn-23	SFSDEC Soft Start Time (Deceleration)	Unit: ms	Setting Range: 0 to 10000	Factory Setting: 0	For Speed/Torque Control Only

In the Servopack, a speed reference is multiplied by the acceleration or deceleration value set in Cn-07 or Cn-23 to provide speed control.

Smooth speed control can be achieved when progressive speed references are input or when contact input speed control is used.

Set these user constants as follows.

Cn-07: Time interval from the time the motor starts until the maximum speed (4500 r/min) is reached

Cn-23: Time interval from the time the motor is running at the maximum speed (4500 r/min) until it stops

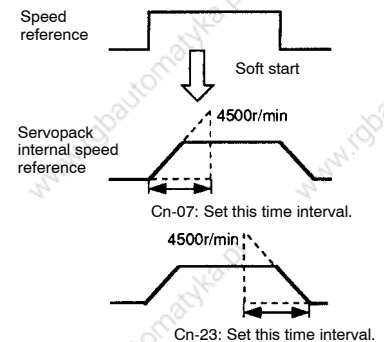

3.5.2 Using the Smoothing Function



- The smoothing function adjusts constant-frequency reference input inside the Servopack so that acceleration and deceleration can be as constant as possible. To use this function, set the following user constant.

Cn-26	ACCTME	Position Reference Acceleration/Deceleration Time Constant (Smoothing)	Unit: 0.1 ms	Setting Range: 0 to 640	Factory Setting: 0	For Position Control Only
--------------	--------	--	--------------	-------------------------	--------------------	---------------------------

This user constant is used for position control only.

This function performs acceleration/deceleration processing for input reference pulses (primary lag characteristics).

This function prevents the motor from running at progressive speeds in the following cases:

- When the host controller which outputs references cannot perform acceleration/deceleration processing
- When reference pulse frequency is too low
- When reference electronic gear ratio is too high (more than 10 times)

This function does not change the travel distance (number of pulses).

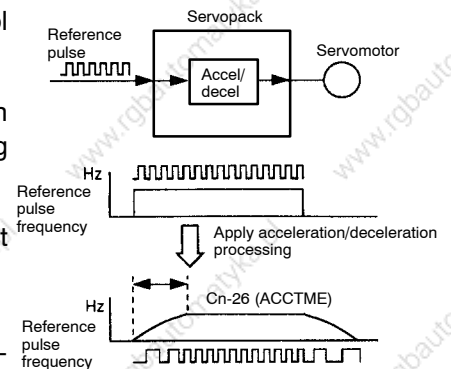

3.5.3 Adjusting Gain

- If speed loop gain or position loop gain exceeds the allowable limit for the servo system including the machine to be controlled, the system will vibrate or become too susceptible. Under such conditions, smooth operation cannot be expected. Reduce each loop gain value to an appropriate value.
- For servo gain adjustment, refer to the following section:

3.6.2 Setting Servo Gain

3.5.4 Adjusting Offset

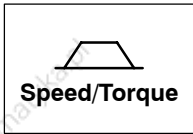

- 1) If reference voltage from the host controller or external circuit has an offset in the vicinity of 0 V, smooth operation cannot be expected. Adjust the reference offset to 0 V.

When Reference Voltage from Host Controller or External Circuit has an Offset

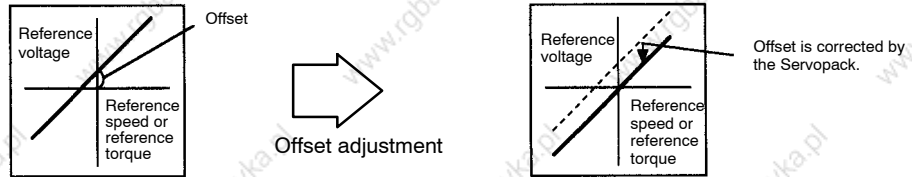

- 2) The following two methods are available to adjust the reference offset to 0 V.

1) Automatic adjustment of reference offset	Reference offset is automatically adjusted.
2) Manual adjustment of reference offset	Reference offset can be intentionally set to a specified value.

NOTE If a position control loop is formed in the host controller, do not use automatic adjustment in 1). Always use manual adjustment in 2).

- 3) For detailed adjustment procedures, refer to the following sections:

	Adjustment Method
1) Automatic adjustment of reference offset	4.2.4 Reference Offset Automatic Adjustment
2) Manual adjustment of reference offset	4.2.5 Speed Reference Offset Manual Adjustment Mode

3.5.5 Setting the Torque Reference Filter Time Constant

- 1) If the machine causes vibration, possibly resulting from the servo drive, adjust the following filter time constant. Vibration may stop.

Cn-17	TRQFIL Torque Reference Filter Time Constant	Unit: 100 μ s	Setting Range: 0 to 250	Factory Setting: 4	For Speed/Torque Control and Position Control
--------------	--	----------------------	----------------------------	-----------------------	---

Cn-17 is a torque reference filter time constant for the DR2 Servopack. The smaller the value, the higher the torque control response. There is, however, a certain limit depending on machine conditions.

With the standard setting, the machine may cause vibration resulting from the servo drive. In this case, increase the constant setting. Vibration may stop. Vibration can be caused by incorrect gain adjustment, machine problems and so on.

Set the following memory switch to select the torque reference filter degree.

Cn-02	Bit C	Torque Reference Filter Degree	Factory Setting: 0	For Speed/Torque Control and Position Control
--------------	--------------	--------------------------------	--------------------	---

Setting	Meaning
0	Primary filter
1	Secondary filter

3.6 Minimizing Positioning Time

■ This section describes how to minimize positioning time.

3.6.1	Using Autotuning Function	118
3.6.2	Setting Servo Gain	118
3.6.3	Using Feed-forward Control	120
3.6.4	Using Proportional Control	120
3.6.5	Setting Speed Bias	121
3.6.6	Using Mode Switch	122

3.6.1 Using Autotuning Function

- 1) If speed loop gain and position loop gain for the servo system are not set properly, positioning may become slow. Techniques and experience are required to set these servo gain values according to machine configuration and machine rigidity.
- 2) Σ -series Servopacks have an autotuning function that automatically measures machine characteristics and sets the necessary servo gain values. With this function, even first-time servo users can easily perform tuning for servo gain. Servo gain values are set in user constants.
- 3) The following user constants can be automatically set by the autotuning function.

User Constant	Meaning
Cn-04	Speed loop gain
Cn-05	Speed loop integration time constant
Cn-1A	Position loop gain

- 4) For details of how to perform autotuning, refer to 4.2.3 *Autotuning*

3.6.2 Setting Servo Gain

- 1) Check and reset the servo gain when:
 - a) Automatically set servo gain values need to be checked after autotuning.
 - b) Each servo gain value checked in a) is to be directly set for another Servopack.
 - c) Response performance needs to be further enhanced after autotuning, or servo gain values need to be reset for a system with lower response performance.

2) Set the following user constants related to speed loop as necessary.

Cn-04	LOOPHZ Speed Loop Gain (Kv)	Unit: Hz	Setting Range: 1 to 2000	Factory Setting: 80	For Speed/Torque Control and Position Control
Cn-05	PITIME Speed Loop Integration Time Constant (Ti)	Unit: ms	Setting Range: 2 to 10000	Factory Setting: 2000	For Speed/Torque Control and Position Control

Cn-04 and Cn-05 are a speed loop gain and an integration time constant for the Servopack, respectively.

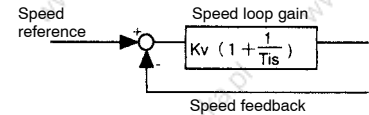

The higher the speed loop gain value or the smaller the speed loop integration time constant value, the higher the speed control response. There is, however, a certain limit depending on machine characteristics.

These user constants are automatically set by the autotuning function.

The unit of speed loop integration time constant Cn-05 (Ti) can be changed to 0.01 ms.

3) Set the following user constants related to position loop as necessary.

Cn-1A	POSGN Position Loop Gain (Kp)	Unit: 1/s	Setting Range: 1 to 500	Factory Setting: 40	For Position Control Only
--------------	----------------------------------	--------------	-------------------------------	---------------------------	------------------------------

This user constant is a position loop gain for the Servopack.

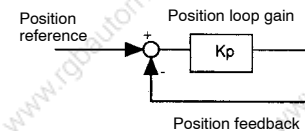

Increasing the position loop gain value provides position control with higher response and less error. However, there is a certain limit depending on machine characteristics.

This user constant is automatically set by the autotuning function.

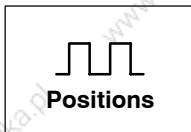

Cn-1E	OVERLV Overflow	Unit: 256 References	Setting Range: 1 to 32767	Factory Setting: 1024	For Position Control Only
--------------	--------------------	-------------------------	---------------------------------	-----------------------------	------------------------------

This user constant is for position control only.

Set in this user constant the error pulse level at which a position error pulse overflow alarm (alarm A.31) is detected.

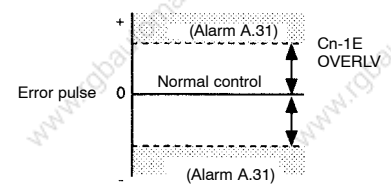

If the machine permits only a small position loop gain value to be set in Cn-1A, an overflow alarm may arise during high-speed operation. In this case, increase the value set in this user constant to suppress alarm detection.

3.6.3 Using Feed-forward Control



Feed-forward control shortens positioning time. To use **feed-forward control**, set the following user constant.

Cn-1D	FFGN Feed-forward Gain	Unit: %	Setting Range: 0 to 100	Factory Setting: 0	For Position Control Only
Cn-27	FFFILT Feed-forward Reference Filter	Unit: 100 μs	Setting Range: 0 to 640	Factory Setting: 0	For Position Control Only

This user constant is for position control only.

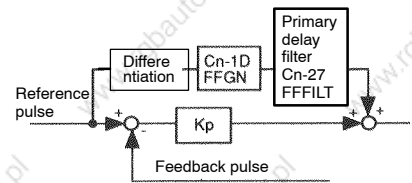

This user constant is set to apply feed-forward frequency compensation to position control inside the Servopack.

Use this user constant to shorten positioning time. Too high a value may cause the machine to vibrate. For ordinary machines, set 80% or less in this constant.

3.6.4 Using Proportional Control



1) If both bits A and B of memory switch Cn-01 are set to 0 as shown below, input signal $\overline{P-CON}$ serves as a PI/P control changeover switch for speed control loop.

- PI Control: Proportional/Integral control
- P Control: Proportional control

Cn-01 Bit A	Control Mode Selection	Factory Setting: 0	For Speed/Torque Control and Position Control
Cn-01 Bit B	Control Mode Selection	Factory Setting: 0	For Speed/Torque Control and Position Control



Feed-forward control

Control for making necessary corrections beforehand to prevent the control system from receiving the effects of disturbance. Using feed-forward control increases effective servo gain, enhancing response performance.

For speed/torque control only.

Cn-01 Setting		Control Mode					
Bit B	Bit A						
0	0	<ul style="list-style-type: none"> Signal P-CON (1CN-41) is used to switch between P control and PI control. <table border="1"> <tr> <td>P-CON (1CN-41) is open (OFF)</td> <td>PI control</td> </tr> <tr> <td>P-CON (1CN-41) is closed (ON)</td> <td>P control</td> </tr> </table> <ul style="list-style-type: none"> Torque reference input T-REF (1CN-9) cannot be used. 	P-CON (1CN-41) is open (OFF)	PI control	P-CON (1CN-41) is closed (ON)	P control	
P-CON (1CN-41) is open (OFF)	PI control						
P-CON (1CN-41) is closed (ON)	P control						

2) Proportional control can be used in the following two ways.

- a) The host controller can selectively use P control mode for particular conditions only. This method can prevent the occurrence of overshoot and also shorten settling time. For particular conditions, refer to 3.6.6 Using Mode Switch.
- b) In the speed control mode, if PI control mode is used when the speed reference has a reference offset, the motor may rotate at a very slow speed and fail to stop even if 0 is specified as a speed reference. In this case, use P control mode to stop the motor.

3

3.6.5 Setting Speed Bias

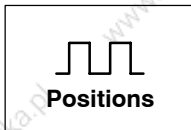

The settling time for positioning can be reduced by assigning bias to the speed reference output part in the Servopack. To assign bias, use the following constant.

Cn-1C	BIASLV Bias	Unit: r/min	Setting Range: 0 to 450	Factory Setting: 0	For Position Control Only

This user constant is for position control only.

This user constant is set to assign an offset to a speed reference in the DR2 Servopack.

Use this constant to shorten settling time.

Set this user constant according to machine conditions.

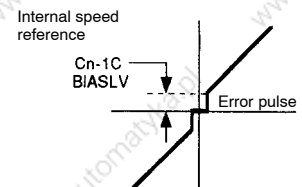

3.6.6 Using Mode Switch

- 1) Use the mode switch for the following purposes:
 - a) To prevent overshoot during acceleration or deceleration (for speed control).
 - b) To prevent undershoot during positioning in order to reduce settling time (for position control).

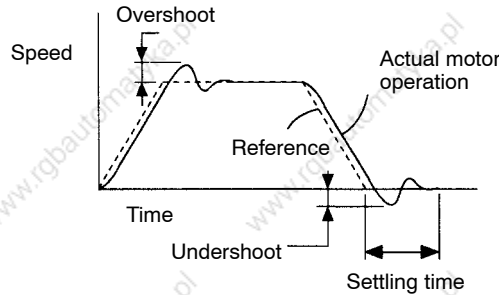

- 2) In other words, the mode switch is a function that automatically switches the speed control mode inside the Servopack **from PI control to P control** while certain conditions are being established.

NOTE The mode switch is used to fully utilize performance of a servo drive to achieve very high-speed positioning. The speed response waveform must be observed to adjust the mode switch.

For normal use, the speed loop gain and position loop gain set by autotuning provide sufficient speed/position control.

Even if overshoot or undershoot occurs, they can be suppressed by setting the acceleration/deceleration time constant for the host controller, the soft start time constants (Cn-07, Cn-23), or position reference accel/decel time constant (Cn-26) for the Servopack.



From PI control to P control

PI control means proportional/integral control and P control means proportional control. In short, switching “from PI control to P control” reduces effective servo gain, making the servo system more stable.

- 3) Servopacks can use four types of mode switches (1 to 4). To select a mode switch, use the following memory switch. Note that the mode switch setting methods for speed/torque control and position control are slightly different.

For Speed/Torque Control		For Position Control			Mode Switch Setting	User Constant	Unit
Memory Switch Cn-01		Memory Switch Cn-01					
Bit D	Bit C	Bit D	Bit C	Bit B			
1	1	-	-	1	Does not use mode switch.		
0	0	0	0	0	Uses torque reference as a detection point. (Standard setting)	Cn-0C	Percentage of rated torque: %
0	1	0	1	0	Uses speed reference as a detection point.	Cn-0D	Motor speed: r/min
1	0	1	0	0	Uses acceleration reference as a detection point.	Cn-0E	Acceleration reference inside the Servopack: 10 (r/min)/s
		1	1	0	Uses error pulse as a detection point.	Cn-0F	Reference unit

When Torque Reference Is Used as a Detection Point of Mode Switch (Standard Setting)

If a torque reference exceeds the torque value set in user constant Cn-0C, the speed loop switches to P control.

The DR2 Servopack is factory set to this standard mode (Cn-0C = 200).

Example of Use:

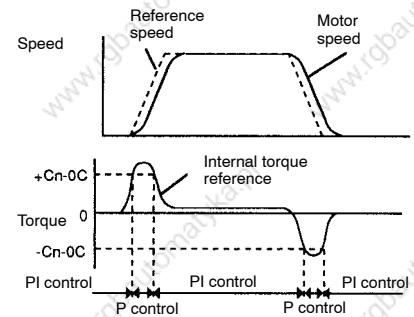

If a mode switch is not used and PI control is always performed, torque may enter a saturation state during acceleration or deceleration, causing the motor speed to have overshoot or undershoot.

Using the mode switch suppresses torque saturation and prevents the motor speed from having overshoot and undershoot.

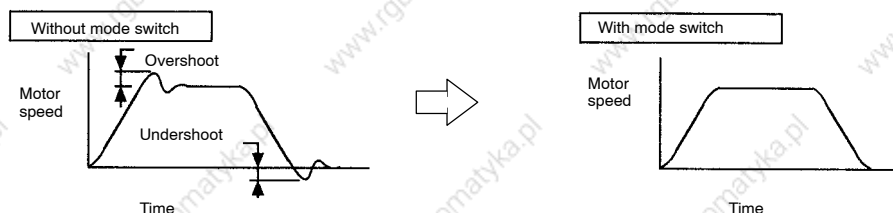

When Speed Reference Is Used as a Detection Point of Mode Switch

If a speed reference exceeds the value set in user constant Cn-0D, the speed loop switches to P control.

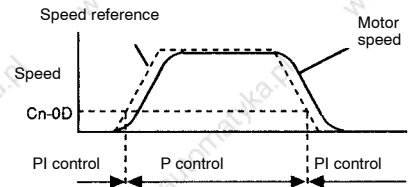

Example of Use:

The mode switch is used to reduce settling time.

Generally, speed loop gain must be increased to reduce settling time. Using the mode switch suppresses the occurrence of overshoot and undershoot when speed loop gain is increased.

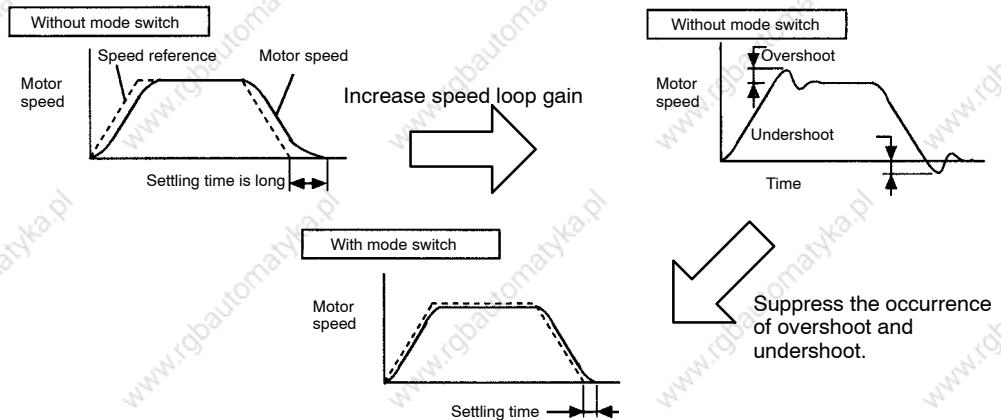

When Acceleration Is Used as a Detection Point of Mode Switch

If motor acceleration exceeds the value set in user constant Cn-0E, the speed loop switches to P control.

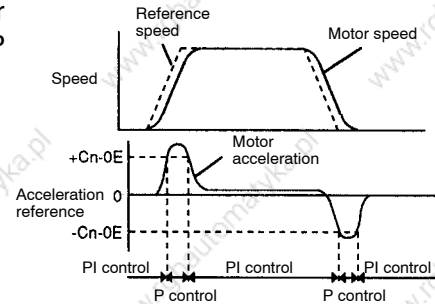

Example of Use:

If a mode switch is not used and PI control is always performed, torque may enter a saturation state during acceleration or deceleration, causing the motor speed to have overshoot or undershoot.

Using the mode switch suppresses torque saturation and prevents the motor speed from having overshoot and undershoot.

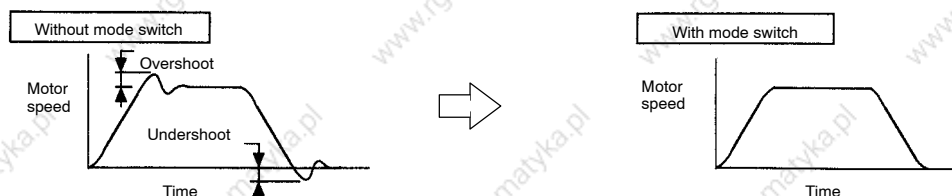

When Error Pulse Is Used as a Detection Point of Mode Switch

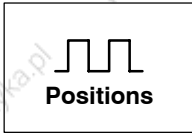

For position control only.

If an error pulse exceeds the value set in user constant Cn-0F, the speed loop switches to P control.

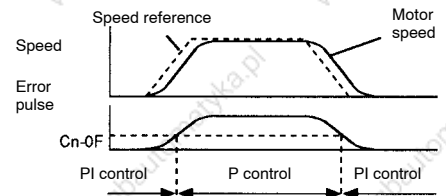

Example of Use:

The mode switch is used to reduce settling time.

Generally, speed loop gain must be increased to reduce settling time. Using the mode switch suppresses the occurrence of overshoot and undershoot when speed loop gain is increased.

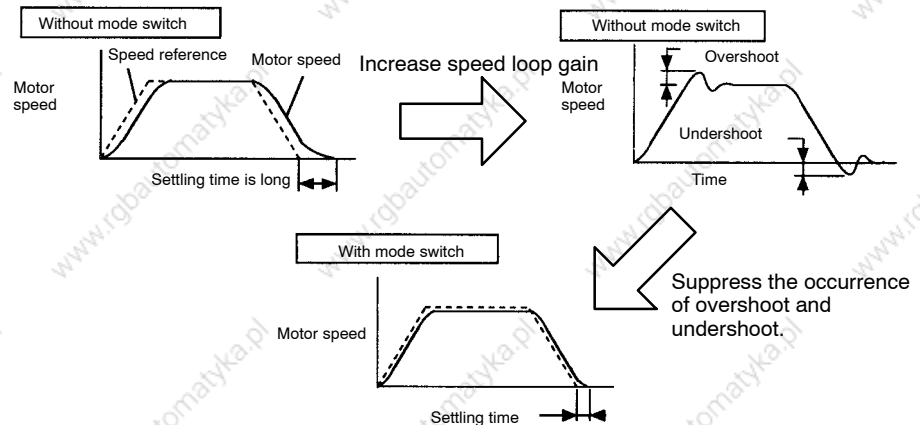

3

4) The user constants required to set each mode switch are summarized as follows.

Cn-01Bit B	Mode Switch ON/OFF	Factory Setting: 0	For Position Control Only
-------------------	--------------------	--------------------	---------------------------

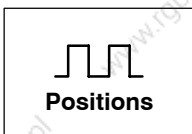

For position control only.

This user constant is used to enable or disable the mode switch function.

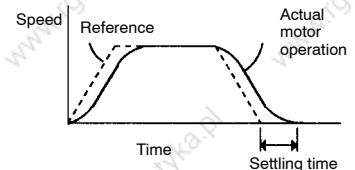

Setting	Meaning
0	Uses the mode switch function
1	Does not use the mode switch function

Mode switch is used to reduce settling time and suppress undershoot when the motor stops. It switches PI control to P control when certain conditions are met.

The Servopack allows use of four different types of mode switch. To select a mode switch, set bits C and D of memory switch Cn-01.

For speed/torque control, bits C and D are used to enable or disable the mode switch function.

APPLICATIONS OF Σ -SERIES PRODUCTS

3.6.6 Using Mode Switch cont.

Cn-01 Bit C	Mode Switch Selection	Factory Setting: 0	For Speed/Torque Control and Position Control
Cn-01 Bit D	Mode Switch Selection	Factory Setting: 0	For Speed/Torque Control and Position Control

Use the following user constants to set the mode switch to be used.

Memory Switch Cn-01		Mode Switch Type		User Constant for Setting Detection Point
Bit D	Bit C			
0	0	Uses torque reference as a detection point.		Cn-0C
0	1	Uses speed reference as a detection point.		Cn-0D
1	0	Uses acceleration reference as a detection point.		Cn-0E
1	1	For speed/torque control	Does not use mode switch.	/
		For position control	Uses error pulse as a detection point.	

Mode switch is used to reduce settling time and suppress undershoot when the motor stops. It switches PI control to P control when certain conditions are met.

Cn-0C	TRQMSW	Mode Switch (Torque Reference)	Unit: %	Setting Range: 0 to 800	Factory Setting: 200	For Speed/Torque Control and Position Control
Cn-0D	REFMSW	Mode Switch (Speed Reference)	Unit: r/min	Setting Range: 0 to 4500	Factory Setting: 0	For Speed/Torque Control and Position Control
Cn-0E	ACCMSW	Mode Switch (Acceleration Reference)	Unit: 10 (r/min)/s	Setting Range: 0 to 3000	Factory Setting: 0	For Speed/Torque Control and Position Control
Cn-0F	ERPMSW	Mode Switch (Error Pulse)	Unit: Reference Unit	Setting Range: 0 to 10000	Factory Setting: 0	For Position Control Only

Mode switch is used to reduce settling time and suppress undershoot when the motor stops. It switches PI control to P control when certain conditions are met.

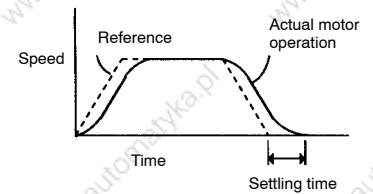

The Servopack allows use of four different types of mode switch. To select a mode switch, set bits B, C and D of memory switch Cn-01.

Memory Switch Cn-01			Mode Switch Setting	User Constant	Unit
Bit D	Bit C	Bit B			
-	-	1	Does not use mode switch.		
0	0	0	Uses torque reference as a detection point.	Cn-0C	Percentage of rated torque: %
0	1	0	Uses speed reference as a detection point.	Cn-0D	Motor speed: r/min
1	0	0	Uses acceleration reference as a detection point.	Cn-0E	Acceleration reference inside the DR2 Servopack: 10 (r/min)/s
1	1	0	Uses error pulse as a detection point.	Cn-0F	Reference unit

User constant Cn-0F is for position control only.

3.7 Forming a Protective Sequence

This section describes how to use I/O signals from the Servopack to form a protective sequence for safety purposes.

3.7.1	Using Servo Alarm Output and Alarm Code Output	128
3.7.2	Using Servo ON Input Signal	132
3.7.3	Using Positioning Complete Signal	133
3.7.4	Using Speed Coincidence Output Signal	134
3.7.5	Using Running Output Signal	136
3.7.6	Using Servo Ready Output Signal	138

3.7.1 Using Servo Alarm Output and Alarm Code Output

1) Basic Wiring for Alarm Output Signals

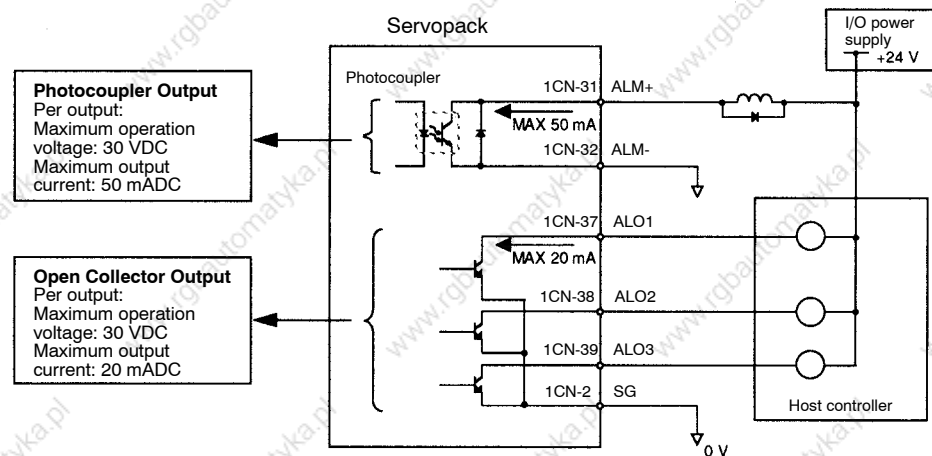

Provide an external I/O power supply separately. There are no DC power available from Servopack for output signals.

2) Contact Output Signal ALM+, ALM-

Output → ALM+ 1CN-31	Servo Alarm Output	For Speed Torque Control and Position Control
Output → ALM- 1CN-32	Signal Ground for Servo Alarm Output	For Speed Torque Control and Position Control

Signal ALM+ is output when the Servopack detects an alarm.

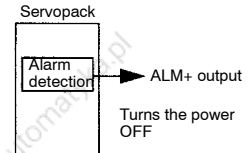

Form an external circuit so that this alarm output (ALM) turns the Servopack main power OFF.

ON status:	Circuit between 1CN-31 and 1CN-32 is closed. 1CN-31 is at low level.	Normal state
OFF status:	Circuit between 1CN-31 and 1CN-32 is open. 1CN-31 is at high level.	Alarm state

Alarm codes ALO1, ALO2, and ALO3 are output to indicate each alarm type.

3) Contact Output Signals ALO1, ALO2, and ALO3

Output → ALO1 1CN-37	Alarm Code Output	For Speed/Torque Control and Position Control
Output → ALO2 1CN-38	Alarm Code Output	For Speed/Torque Control and Position Control
Output → ALO3 1CN-39	Alarm Code Output	For Speed/Torque Control and Position Control
Output → SG 1CN-2	Signal Ground for Alarm Code Output	For Speed/Torque Control and Position Control

These signals output an alarm code to indicate the type of an alarm detected by the Servopack.

Use these signals to display alarm codes at the host controller.

4) Relationship between Alarm Display and Alarm Code Output

Alarm Display and Alarm Code Output:

Alarm Display	Alarm Code Output			Servo Alarm (ALM+) Output	Alarm Type	Alarm Description
	ALO1	ALO2	ALO3			
R0*	×	×	×	×	User constant error	An absolute encoder error occurred or user constant is faulty.
R10	○	×	×	×	Overcurrent	Overcurrent flowed through the main circuit. Servopack overheated.
R20	×	○	×	×	Fuse blown	Fuse of main circuit power supply is blown.
R30	○	○	×	×	Regenerative error	Failure of regenerative circuit
R31	○	○	×	×	Position error pulse overflow	The number of pulses in error counter has exceeded the preset value.
R40	×	×	○	×	Overvoltage or undervoltage	Main circuit DC voltage is overvoltage or undervoltage.
R51	○	×	○	×	Overspeed	Motor speed has exceeded the 110% of the maximum allowable speed.
R70	○	○	○	×	Overload	Motor and Servopack are overloaded.
R8*	×	×	×	×	Absolute encoder error	Absolute encoder is faulty.
R61	×	×	×	×	Reference input read error	Failure of analog voltage reference input read
RC*	○	×	○	×	Overrun Disconnection of PG signal line	Overrun occurred due to motor or encoder signal wiring faults. Encoder signal line is disconnected.

○ : Output transistor is ON

× : Output transistor is OFF

* : Displays an alarm category number.

For details, refer to *Appendix E List of Alarm Displays*.

Alarm Display	Alarm Code Output			Servo Alarm (ALM+) Output	Alarm Type	Alarm Description
	ALO1	ALO2	ALO3			
CPFD0	Undefined				Digital Operator transmission error	Communication error occurred between Digital Operator and Servopack.
CPFD1						
R99	×	×	×	○	No error	

○ : Output transistor is ON

× : Output transistor is OFF

* : Displays an alarm category number.

For details, refer to *Appendix E List of Alarm Displays*.

- 5) When the servo alarm (ALM+) is output, eliminate the cause of the alarm and set the following $\overline{\text{ALMRST}}$ input signal at low level (0V) to reset the alarm state.

→ Input $\overline{\text{ALMRST}}$ 1CN-44	Alarm Reset	For Speed/Torque Control and Position Control
---	-------------	---

This signal is used to reset the servo alarm state.

Alarm state can be reset using the Digital Operator. Also, alarm state is reset at control power ON/OFF.

When an alarm occurs, always eliminate the cause before resetting the alarm state. 6.2.1 Troubleshooting Problems with Alarm Display describes how to troubleshoot the system when an alarm arises.

3.7.2 Using Servo ON Input Signal

1) This section describes how to wire and use contact input signal “servo ON ($\overline{S-ON}$).” Use this signal to forcibly turn the servomotor OFF from the host controller.

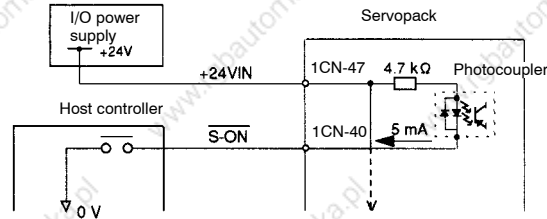

→ Input $\overline{S-ON}$ 1CN-40	Servo ON	For Speed/Torque Control and Position Control
----------------------------------	----------	---

This signal is used to turn the motor ON or OFF.

ON: 1CN-40 is at low level	Turns the motor ON. This is normal operation state. Motor is operated according to input signals. (called “servo ON state”).
OFF: 1CN-40 is at high level	Turns the motor OFF. This is inoperable state (called “servo OFF state”). If the servo is turned OFF during motor operation, the motor is decelerated to a stop by applying dynamic brake (standard setting). This function can be selected by setting bits 6 and 7 of memory switch Cn-01.

NOTE Do not use the $\overline{S-ON}$ signal to start or stop the motor. Always use an input reference to start and stop the motor.

2) If the $\overline{S-ON}$ signal is not to be used, set the following memory switch to 1:

Cn-01 Bit 0	Use of Servo ON Input Signal	Factory Setting: 0	For Speed/Torque Control and Position Control
--------------------	------------------------------	--------------------	---

This memory switch is used to enable or disable the servo ON input signal $\overline{S-ON}$ (1CN-40).

When external short-circuit wiring is omitted, set the memory switch to “1.”

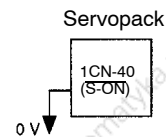

When S-ON is not used, this short-circuit wiring can be omitted.

Setting	Meaning
0	Uses servo ON signal $\overline{S-ON}$. (When 1CN-40 is open, servo is OFF. When 1CN-14 is at 0 V, servo is ON.)
1	Does not use servo ON signal $\overline{S-ON}$. (Always servo is ON. Equivalent to shortcircuit 1CN-14 and 0V.)

3.7.3 Using Positioning Complete Signal

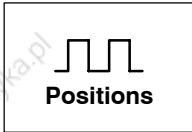

1) This section describes how to wire and use contact output-signal “positioning complete output (COIN).” This signal is output to indicate that servomotor operation is complete.

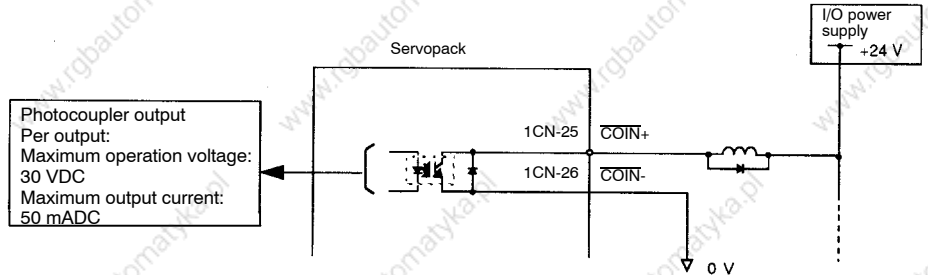

Photocoupler output
Per output:
Maximum operation voltage:
30 VDC
Maximum output current:
50 mADC

Output → COIN+ 1CN-25	Positioning Complete Output	For Position Control Only
Output → COIN- 1CN-26		

3

For position control only.

This output signal indicates that motor operation is complete during position control. The host controller uses this signal as an interlock to confirm that positioning is complete.

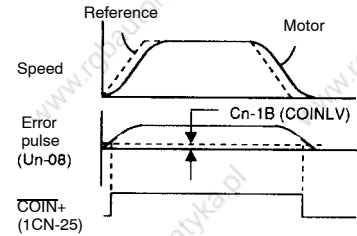

ON status:	Circuit between 1CN-25 and 1CN-26 is closed. 1CN-25 is at low level.	Positioning is complete (position error is below the preset value).
OFF status:	Circuit between 1CN-25 and 1CN-26 is open. 1CN-25 is at high level.	Positioning is not complete (position error is over the preset value.)

Preset Value: Cn-1B (positioning complete range)

2) Set the number of error pulses in the following user constant Cn-1B to adjust output timing of COIN (positioning complete output).

APPLICATIONS OF Σ -SERIES PRODUCTS

3.7.4 Using Speed Coincidence Output Signal

Cn-1B	COINLV	Positioning Complete Range	Unit: Reference Unit	Setting Range: 0 to 250	Factory Setting: 7	For Position Control Only
--------------	--------	----------------------------	----------------------	-------------------------	--------------------	---------------------------

For position control only.

This user constant is used to set output timing of positioning complete signal ($\overline{\text{COIN}}+$, 1CN-25) to be output when motor operation is complete after a position reference pulse has been input.

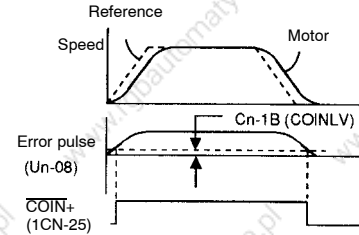

Set the number of error pulses in terms of reference unit (the number of input pulses that is defined using the electronic gear function).

If too large a value is set in this user constant, error may become too small when the motor runs at a low speed, causing $\overline{\text{COIN}}+$ to be output continuously.

COINLV does not affect the final positioning accuracy.

3.7.4 Using Speed Coincidence Output Signal



- 1) This section describes how to wire and use contact output signal "speed coincidence outputs ($\overline{\text{LCT}}+$, $\overline{\text{CLT}}-$)." This signal is output to indicate that actual motor speed matches a reference speed. The host controller uses this signal as an interlock.

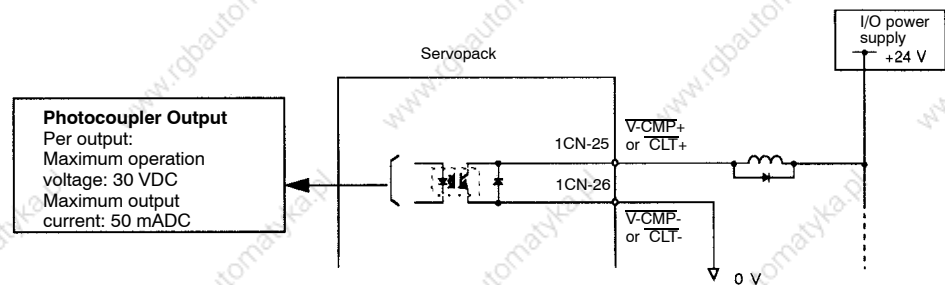

Output → $\overline{\text{CLT}}+$ 1CN-25	Speed Coincidence Output	For Speed/Torque Control Only
Output → $\overline{\text{CLT}}-$ 1CN-26	Speed Coincidence Output	For Speed/Torque Control Only

For speed/torque control only.

This output signal indicates that actual motor speed matches the input speed reference during speed control.

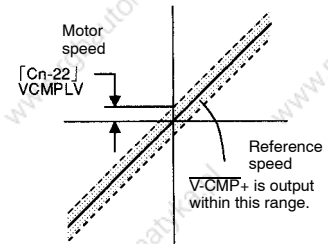

ON status:	Circuit between 1CN-25 and 1CN-26 is closed. 1CN-25 is at low level.	Actual motor speed matches the speed reference (speed difference is below the preset value).
OFF status:	Circuit between 1CN-25 and 1CN-26 is open. 1CN-25 is at high level.	Actual motor speed does not match the speed reference (speed difference is greater than the preset value).

Preset value: Cn-22 (speed coincidence signal output width)

- 2) Set the following user constant to specify the output conditions for speed coincidence signal $\overline{\text{V-CMP}}$.

Cn-22	VCMP+ Speed Coincidence Signal Output Width	Unit: r/min	Setting Range: 0 to Max. Speed	Factory Setting: 10	For Speed/Torque Control Only
--------------	---	-------------	--------------------------------	---------------------	-------------------------------

For speed/torque control only

Set the output conditions for speed coincidence signal $\overline{\text{V-CMP}}$ (1CN-25).

$\overline{\text{V-CMP}}$ signal is output when the difference between the reference speed and actual motor speed is not greater than the preset value.

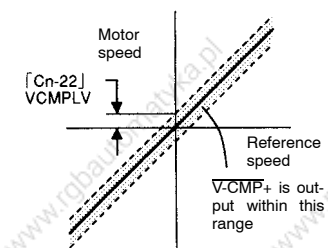

Example: When preset value is 100 and reference speed is 2000 r/min.

$\overline{\text{V-CMP}}$ is ON (circuit between 1CN-25 and 1CN-26 is closed) when the speed is between 1900 and 2100 r/min.

3.7.5 Using Running Output Signal

Note When output signals $\overline{CLT+}$ and $\overline{CLT-}$ are used as the speed coincide output, set the following memory switch (Cn-01 bit4) to 1.

Cn-01 Bit 4	$\overline{CLT+}$, $\overline{CLT-}$ Output Signals Selection	Factory Setting: 0	For Speed/Torque Control and Position Control
--------------------	--	--------------------	---

Sets the output conditions for output signals $\overline{CLT+}$ (1CN-25) and $\overline{CLT-}$ (1CN-26).

Setting	Meaning
0	Uses $\overline{CLT+}$, $\overline{CLT-}$ output signals as a torque limit output signal. Refer to 3.1.3 for details.
1	Uses $\overline{CLT+}$, $\overline{CLT-}$ output signals as a speed coincide output signal.

Bit 4 of memory switch Cn-01

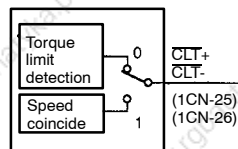

When $\overline{CLT+}$, $\overline{CLT-}$ output signals are changed, the following bit data are also changed:

- Status indication mode bit data
- Monitor mode Un-05 bit 4

3.7.5 Using Running Output Signal

1) This section describes how to wire and use contact output signals $\overline{TGON+}$, $\overline{TGON-}$ as a running output signal. This signal indicates that a servomotor is currently running.

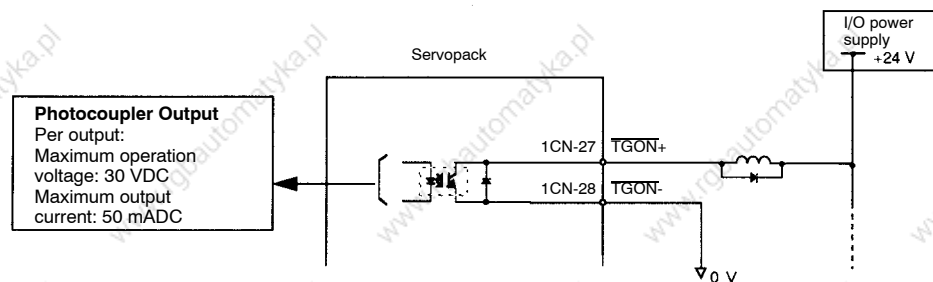

Photocoupler Output
Per output:
Maximum operation voltage: 30 VDC
Maximum output current: 50 mADC

Output → $\overline{TGON+}$ 1CN-27	Running Output (Brake Interlock Output)	For Speed/Torque Control and Position Control
Output → $\overline{TGON-}$ 1CN-28		

This output signal indicates that the motor is currently running.

It is used as an external interlock.

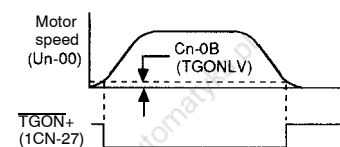

ON status:	Circuit between 1CN-27 and 1CN-28 is closed. 1CN-27 is at low level.	Motor is running. (Motor speed is greater than the preset value.)
OFF status:	Circuit between 1CN-27 and 1CN-28 is open. 1CN-27 is at high level.	Motor is stopped. (Motor speed is below the preset value.)

Preset value: Cn-0B (zero-speed level)

Note This function is changed to another function depending on the setting of bit E of memory switch Cn-01.

- 2) To use $\overline{\text{TGON+}}$, $\overline{\text{TGON-}}$ as a running output signals, set the following memory switch to "0."

Cn-01 Bit E	$\overline{\text{TGON+}}$, $\overline{\text{TGON-}}$ Output Signals Selection	Factory Setting: 0	For Speed/Torque Control and Position Control
--------------------	--	--------------------	---

This memory switch is used to set output conditions for output signals $\overline{\text{TGON+}}$, $\overline{\text{TGON-}}$ (1CN-27).

Memory switch
Cn-01 bit E

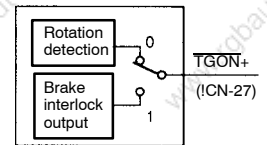

When $\overline{\text{TGON+}}$, $\overline{\text{TGON-}}$ signals are changed, the following bit data are also changed:

- Status indication mode bit data
- Monitor mode Un-05 bit 4

Setting	Meaning	
0	Uses $\overline{\text{TGON+}}$, $\overline{\text{TGON-}}$ as a running output signals. $\overline{\text{TGON+}}$, $\overline{\text{TGON-}}$ compare motor speed with the value set in Cn-0B (TGONLY).	
	Motor speed \geq preset value	Closes circuit between 1CN-27 and 1CN-28.
	Motor speed $<$ preset value	Opens circuit between 1CN-27 and 1CN-28.
1	Uses $\overline{\text{TGON+}}$, $\overline{\text{TGON-}}$ as a torque limit output signal. For details, refer to 3.4.4.	

3.7.6 Using Servo Ready Output

- 3) Use the following user constant to specify the output conditions for running output signals $\overline{\text{TGON+}}$, $\overline{\text{TGON-}}$.

Cn-0B	TGONLV	Zero-Speed Level	Unit: r/min	Setting Range: 1 to Maximum Speed	Factory Setting: 20	For Speed/Torque Control and Position Control
--------------	--------	------------------	-------------	-----------------------------------	---------------------	---

This user constant is used to set the speed level at which the Servopack determines that the motor is running and then outputs a signal.

The following signals are output when motor speed exceeds the preset value. (The circuit between 1CN-27 and 1CN-28 is closed when motor speed exceeds the preset value.)

Signals are output when motor speed exceeds the preset value.

<ul style="list-style-type: none"> • TGON+ (1CN-27) • Status indication mode bit data • Monitor mode Un-05 bit 4
User Constant Setting: Memory switch Cn-01 bit E = 0

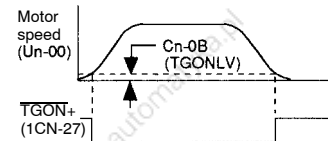

3.7.6 Using Servo Ready Output

- 1) This section describes how to wire and use photocoupler output signal $\overline{\text{S-RDY}}$ (servo ready).

“Servo ready” means that the Servopack is not in servo alarm state when the main circuit is turned ON. For absolute encoder specifications, “servo ready” means that, in addition to the above, the SEN signal is at high level and the absolute encoder is also in ready state.

Also, alarm state is reset at control power ON/OFF.

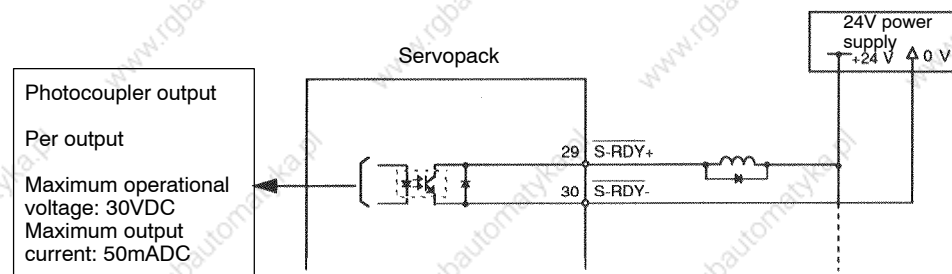

Photocoupler output
 Per output
 Maximum operational voltage: 30VDC
 Maximum output current: 50mADC

Output → S-RDY

Servo Ready Output

For Speed/Torque
Control and
Position Control

This signal indicates that the Servopack is ready to receive servo ON signals.

ON status:	Circuit is closed or signal is at low level.	servo ready state
OFF status:	Circuit is open or signal is at high level.	Not in servo ready state

3.8 Special Wiring

This section describes special wiring methods including the one for noise control. Always refer to 3.8.1 Notes on Wiring and 3.8.2 Wiring for Noise Control, and refer to other sections as necessary.

3.8.1	Wiring Instructions	140
3.8.2	Wiring for Noise Control	142
3.8.3	Using More Than One Servo Drive	147
3.8.4	Using Regenerative Units	148
3.8.5	Using an Absolute Encoder	151
3.8.6	Extending an Encoder Cable	159
3.8.7	Using DR2 Servopack with High Voltage Line	161
3.8.8	Connector Terminal Layouts	163

3.8.1 Wiring Instructions

To ensure safe and stable operation, always refer to the following wiring instructions.

NOTE Always use the following cables for reference input and encoder wiring.

	Cable Type	Yaskawa Drawing No.	Maximum Allowable Length
For reference input	Twisted-pair cables	-	3 m (9.8 ft.)
For encoder	Multiconductor shielded twisted-pair cable	B9400064 (for incremental encoder) DP8409123 (for absolute encoder)	20 m (65.6 ft.)

- Trim off the excess portion of the cable to minimize the cable length.

NOTE For a ground wire, use as thick a cable as possible.

- At least class 3 grounding (ground to 100 Ω or less) is recommended.
- Always use one-line grounding.
- If the motor is insulated from the machine, ground the motor directly.

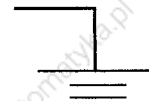

NOTE Do not bend or apply tension to cables.

- Since the conductor of a signal cable is very thin (0.2 to 0.3 mm), handle it with adequate care.

NOTE Use a noise filter to prevent noise interference.
(For details, refer to the following *Caution*.)

- If the servo is to be used near private houses or may receive noise interference, install a noise filter on the input side of the power supply line. Since this Servopack is designed as an industrial device, it provides no mechanism to prevent noise interference.

Noise filter

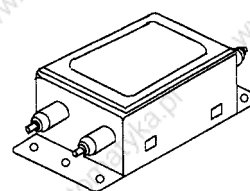

NOTE To prevent malfunction due to noise, take the following actions:

- Position the input reference device and noise filter as close to the Servopack as possible.
- Always install a surge absorber circuit in the relay, solenoid and magnetic contactor coils.
- The distance between a power line (such as a power supply line or motor cable) and a signal line must be at least 30 cm (12 in). Do not put the power and signal lines in the same duct or bundle them together.
- Do not share the power supply with an electric welder or electrical discharge machine. When the Servopack is placed near a high-frequency oscillator, install a noise filter on the input side of the power supply line.

- Note** a) Since Servopack uses high-speed switching elements, signal lines may receive noise. To prevent this, always take the above actions.
b) For details of grounding and noise filters, refer to 3.8.2 *Wiring for Noise Control*.

NOTE Use a molded-case circuit breaker (MCCB) or fuse to protect the power supply line from high voltage.

- This Servopack is directly connected to commercial power supply without a transformer. Always use an MCCB or fuse to protect the servo system from accidental high voltage.
- Select an appropriate MCCB or fuse according to the Servopack capacity and the number of Servopacks to be used as shown below.

MCCB

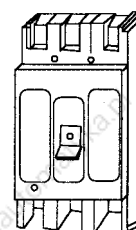

MCCB or Fuse for Each Power Capacity

Power Voltage	Servopack Type	Power Capacity Per Servopack (kVA) (see note 1)	Power Capacity Per MCCB or Fuse (A) (see note 2)
200 V	DR2-A3A□	0.25	5
	DR2-A5A□	0.3	
	DR2-01A□	0.5	
	DR2-02A□	0.75	9
	DR2-04A□	1.2	
	DR2-08A□	2.2	
100 V	DR2-A3B□	0.25	5
	DR2-A5B□	0.3	
	DR2-01B□	0.5	
	DR2-02B□	0.75	8
	DR2-03B□	1.4	15

- Note**
- 1) Power capacity at rated load
 - 2) Operating characteristics (25°C): 2 seconds or more for 200%, 0.01 second or more for 700%
When control circuit breaker and main circuit breaker are used separately, be aware of in-rush current (30 to 40A, for 5ms or less) flows at control power ON.
 - 3) A fast-operating fuse cannot be used because the Servopack power supply is a capacitor input type. A fast-operating fuse may blow out when the power is turned ON.

3.8.2 Wiring for Noise Control

This noise control do not conform to the EMC instructions.
To adapt DR2 Servopack to EMC instructions, refer to *7 Measures to Satisfy the Requirements of EMC Instructions*.

1) Example of Wiring for Noise Control

- a) This Servopack uses high-speed switching elements in the main circuit. It may receive “switching noise” from these high-speed switching elements if wiring or grounding around the Servopack is not appropriate. To prevent this, always wire and ground the Servopack correctly.
- b) This Servopack has a built-in microprocessor (CPU). To protect the microprocessor from external noise, install a noise filter in place.

c) The following is an example of wiring for noise control.

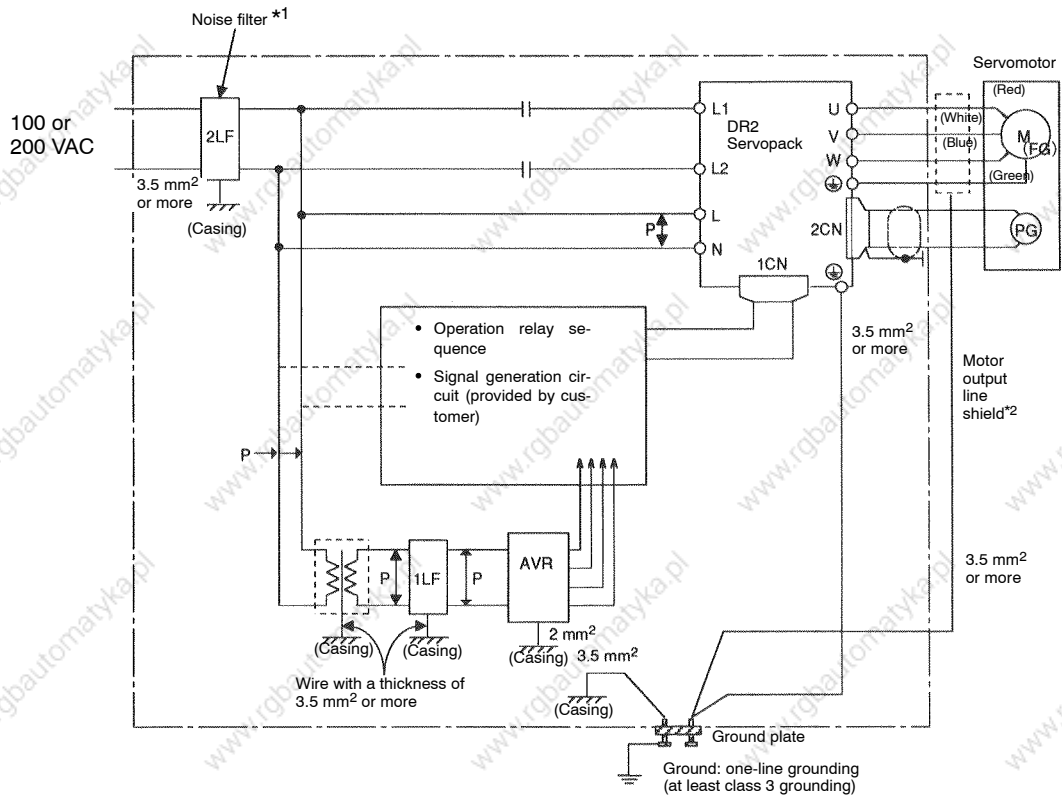

* 1 When using a noise filter, always observe the following wiring instructions:

*2 Normally, motor output line shield² is not required.

Note 1 For a ground wire to be connected to the casing, use a thick wire with a thickness of at least 3.5 mm² (preferably, plain stitch cooper wire). However, be aware that max. connectable size of ground terminal ⊕ of Servopack is 2.5mm².

2 For wires indicated by P↕, use twisted-pair cables whenever possible.

2) Correct Grounding

- Always ground the motor ground terminal.

Always connect servomotor ground terminal FG (green) to the Servopack ground terminal ⊕. Be sure to ground the ground terminal ⊕.

- If the servomotor is grounded via the machine, a switching noise current will flow from the Servopack power unit through motor stray capacitance. The above grounding is required to prevent the adverse effects of switching noise.

- If the reference input line receives noise, do the following.

APPLICATIONS OF Σ -SERIES PRODUCTS

3.8.2 Wiring for Noise Control cont.

Ground the 0 V line (such as SG-V and SG-T) of the reference input line. If the main circuit wiring for the motor is accommodated in a metal conduit, ground the conduit and its junction box. For all grounding, always use one-line grounding.

3) Noise Filter Installation

- a) Use an inhibit type noise filter to prevent noise from the power supply line.

Install a noise filter on the power supply line for peripheral equipment as necessary.

The following table lists recommended noise filters for each Servopack type.

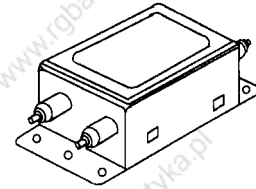

Noise Filter Types

Power Voltage	Servopack Type		Noise Filter Connection	Recommended Noise Filter	
				Type	Specifications
200 V	30 W (0.04 HP)	DR2-A3A□	(Correct) 	LF-205A	Single-phase 200 VAC, 5 A
	50 W (0.07 HP)	DR2-A5A□			
	100 W (0.13 HP)	DR2-01A□			
	200 W (0.27 HP)	DR2-02A□		LF-210	Single-phase 200 VAC, 10 A
	400 W (0.53 HP)	DR2-04A□		LF-220	Single-phase 200 VAC, 20 A
	750 W (1.01 HP)	DR2-08A□			
100 V	30 W (0.04 HP)	DR2-A3B□	(Incorrect) 	LF-205A	Single-phase 200 VAC, 5 A
	50 W (0.07 HP)	DR2-A5B□			
	100 W (0.13 HP)	DR2-01B□			
	200 W (0.27 HP)	DR2-02B□		LF-210	Single-phase 200 VAC, 10 A
	300 W (0.39 HP)	DR2-03B□		LF-220	Single-phase 200 VAC, 20 A

Note These noise filters are manufactured by Tokin Corp. and available from Yaskawa. For noise filters, contact your nearest Yaskawa sales representatives.

b) Always observe the following installation and wiring instructions. Incorrect use of a noise filter halves its benefits.

- Separate input lines from output lines.

Do not put the input and output lines in the same duct or bundle them together.

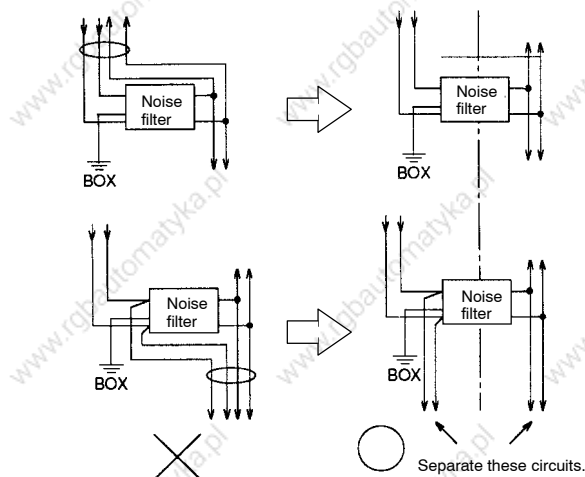
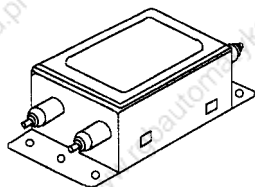

- Separate the noise filter ground wire from the output lines.

Do not accommodate the noise filter ground wire, output lines and other signal lines in the same duct or bundle them together.

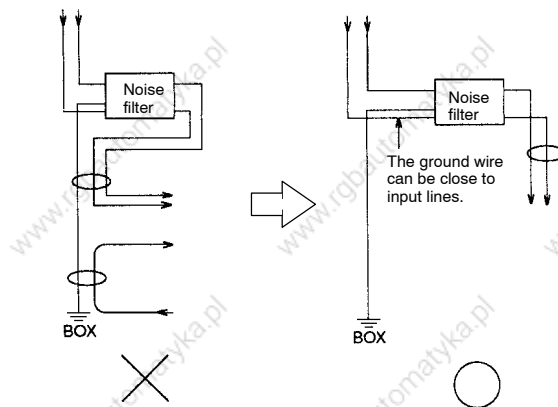

APPLICATIONS OF Σ -SERIES PRODUCTS

3.8.2 Wiring for Noise Control cont.

- Connect the noise filter ground wire directly to the ground plate.

Do not connect the noise filter ground wire to other ground wires.

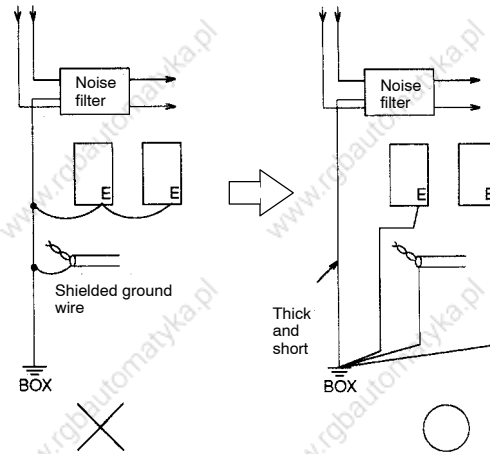

- When grounding a noise filter inside a Unit.

If a noise filter is located inside a Unit, connect the noise filter ground wire and the ground wires from other devices inside the Unit to the ground plate for the Unit first, then ground these wires.

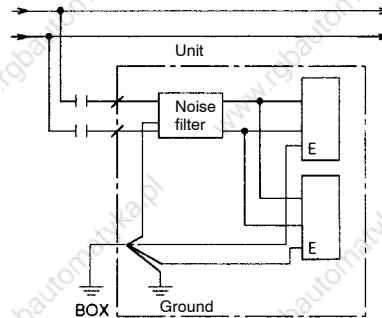

3.8.3 Using More Than One Servo Drive

Example of Wiring More than One Servo Drive

Note Make sure to connect only one cable to power input terminals (L1, L2, L, N). Never connect more than one cables to one terminal.

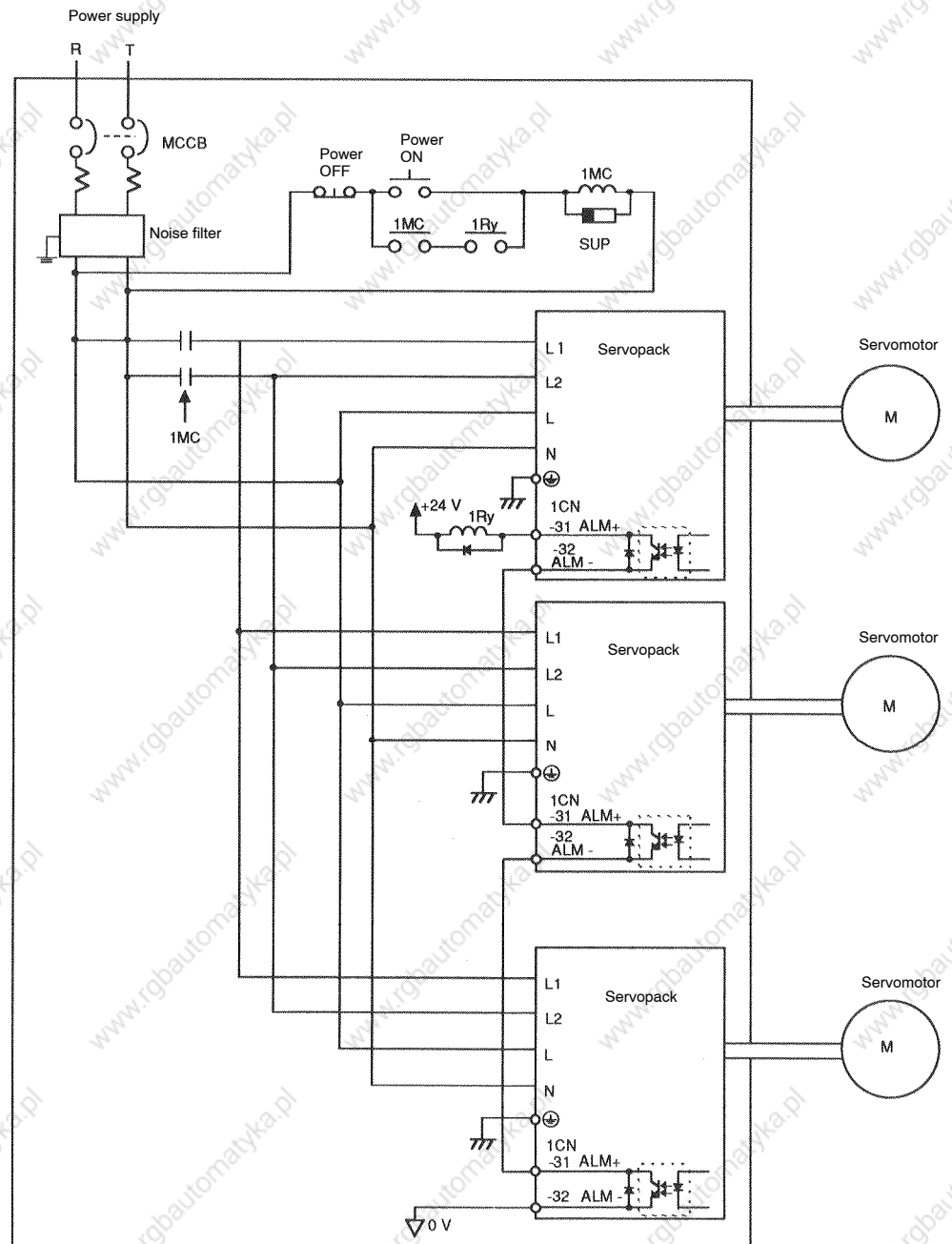

3.8.4 Using Regenerative Units

- 1) Connect the alarm output (ALM) terminals for the three Servopacks in series to enable alarm detection relay 1Ry to operate. This is because ALM is a logical complement output signal, so the output transistor is turned OFF when the system enters an alarm state.
- 2) Multiple servos can share a single MCCB or noise filter. Always select a MCCB or noise filter that has enough capacity for the total power capacity (load conditions) of those servos. For details, refer to page 142.

MCCB

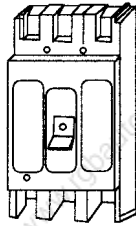

Noise filter

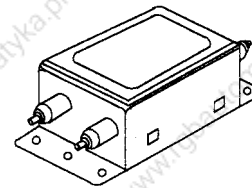

3.8.4 Using Regenerative Units

Note Regenerative unit can be applied only to 200V 30W to 200W (types DR2-A3A, A5A, 01A, 02A). For 200V 400W, 750W and all types of 100V, regenerative unit cannot be used.

1) “What is a Regenerative Unit?”

A regenerative unit is designed to safely consume electric energy that is generated when the servomotor is rotated by the load.

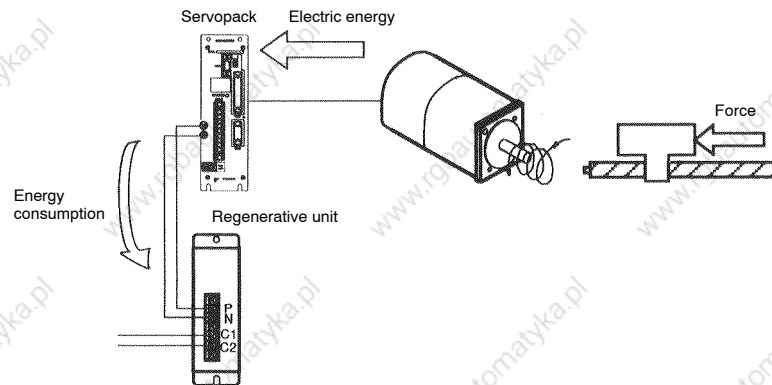

2) “When is a Regenerative Unit Required?”

For general use, a generative unit is not required. In the following cases, however, the user must determine whether a regenerative unit is required or not:

- When the motor is used to control a vertical axis.
- When the motor starts and stops frequently.
- When load inertia exceeds the allowable load inertia on the motor side.
- When the motor rotates at a speed higher than the rated speed (3000 r/min).

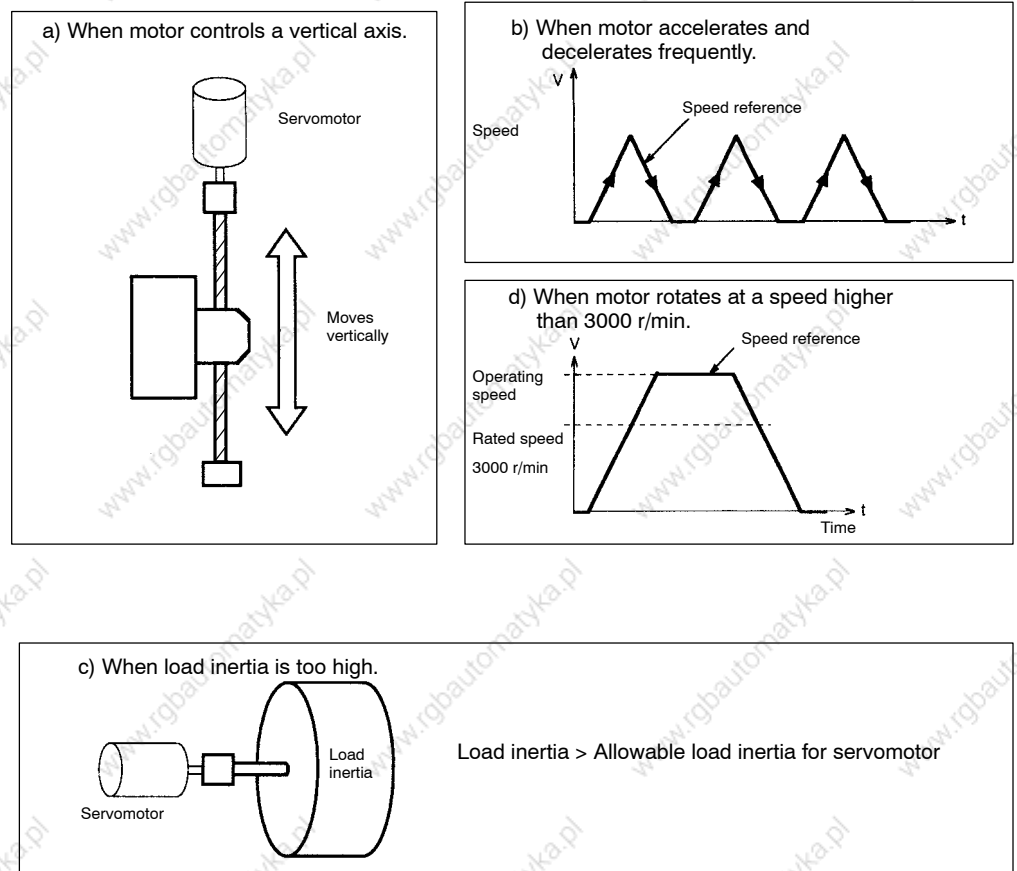

3) “How can we Determine Whether a Regenerative Unit is Required or Not?”

Using software “regenerative capacity check program” enables the user to easily determine whether a regenerative unit is required. This software is included as part of Yaskawa proprietary software “**AC servomotor sizing software**,” which is supplied free of charge. Use this software as necessary.

4) Connecting a Regenerative Unit

The standard connection diagram for a regenerative unit is shown below.

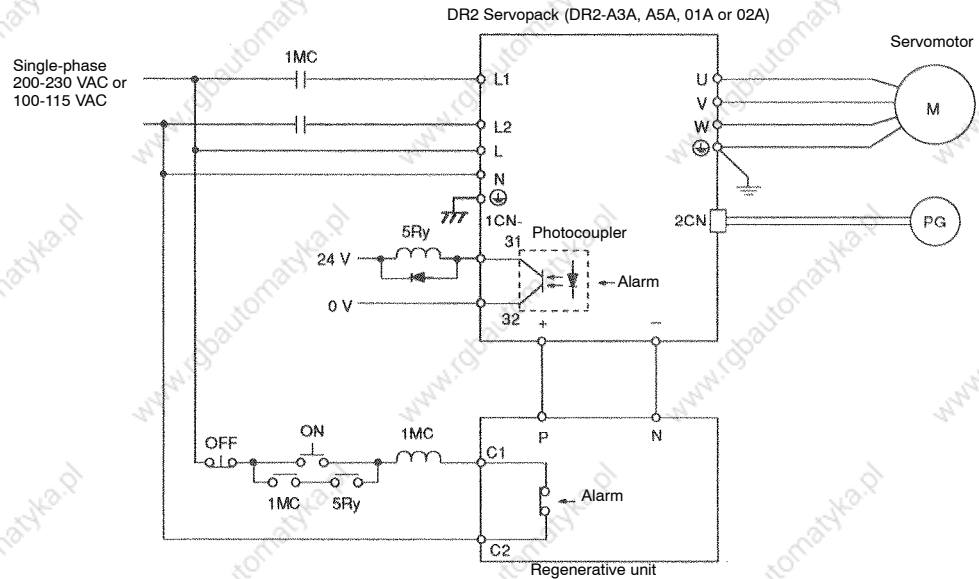

- a) A regenerative unit has the following fault detection functions:
- Detecting broken wiring in a regenerative resistor
 - Detecting faults in a regenerative transistor
 - Detecting overvoltage
- b) When one of these fault detection functions operates, the internal alarm relay is actuated. Then, the circuit between output terminals C1 and C2 is opened.
- c) Form a sequence so that the Servopack main power is turned OFF when the alarm relay is actuated.
- d) Once the alarm relay is actuated, it takes two or three seconds until the system returns to the normal state. This time is required for the main capacitor inside the Servopack to discharge electricity.

3.8.5 Using an Absolute Encoder

1) Outline

An absolute value detection system detects an absolute position of the machine even when the servo system is OFF. If such a system is to be formed in the host controller, use an SGM or SGMP Servomotor with absolute encoder. Consequently, automatic operation can be performed without zero return operation immediately after the power is turned ON.

SGM□□□W1□
(SGMP□□□W1□)

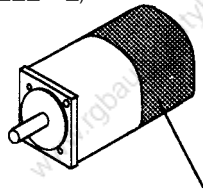

12-bit absolute encoder

Always detects absolute position



~~Zero return operation~~

2) Standard Connection Diagram for a 12-bit Absolute Encoder Mounted on a Servomotor

• Interface Circuit

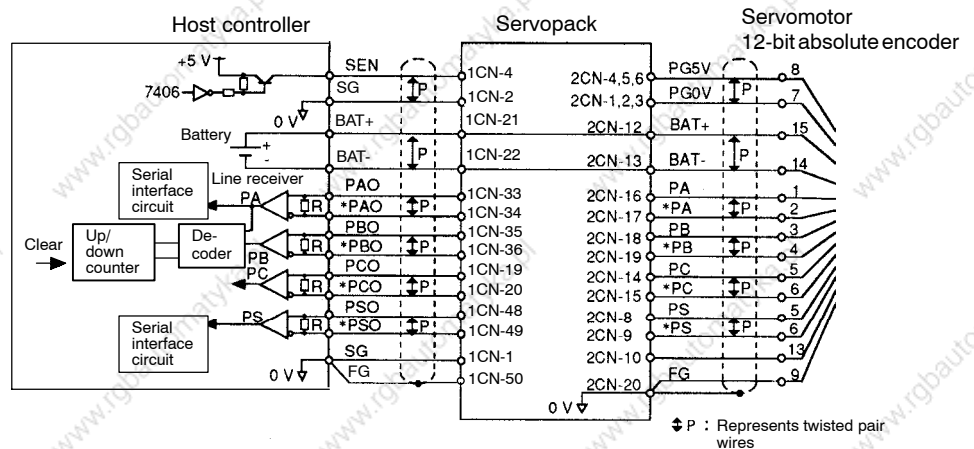

Line Receiver Used: SN75175 or MC3486 manufactured by Texas Instruments Inc.
Termination Resistor R: 220 to 470 Ω

Normally, PAO serial data is used. In this case, PS serial interface is unnecessary.

3.8.5 Using an Absolute Encoder cont.

SEN signal

- The SEN signal must be set at high level after at least three seconds after the power is turned ON.
- When the SEN signal is changed from low level to high level, +5 V is applied to the absolute encoder, and serial data and initial incremental pulses are transmitted.
- The motor is not turned ON until these operations are complete, regardless of the servo ON signal ($\overline{S-ON}$).

Electrical Specifications

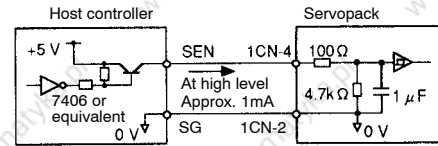

- A PNP transistor is recommended.
- Signal level: High level: Min. 4 V
Low level: Max. 0.7 V

3) Memory Switch to Determine Whether to Use Input Signal SEN

Cn-01 Bit 1	Use of SEN Input Signal	Factory Setting: 0	For Speed/Torque Control and Position Control
--------------------	-------------------------	--------------------	---

This memory switch is used to determine whether to use input signal SEN (1CN-4). This memory switch is available for absolute encoders only (not for incremental encoders).

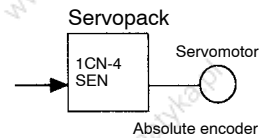

Setting	Meaning
0	Uses SEN signal.
1	Does not use SEN signal.

NOTE If the SEN signal is to be turned OFF, then ON again, it must remain at high level for at least 1.3 seconds before being turned OFF.

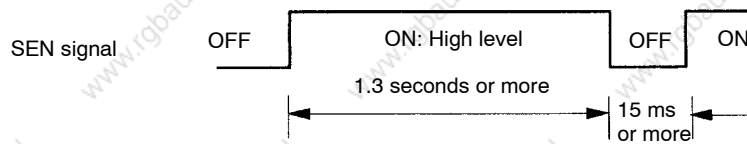

4) Memory Switch to 1 to Select Absolute Encoder

Cn-02 Bit 9	Encoder Type Selection	Factory Setting: 0	For Speed/Torque Control and Position Control
--------------------	------------------------	--------------------	---

Sets the encoder type according to the servomotor type to be used.

After changing the memory switch setting, turn the power OFF, then ON.

Motor Type	Number of Encoder Pulses Per Revolution	Preset Value
SGM-□□□31□ SGMP-□□□31□	Incremental encoder: 2048 pulses per revolution	0
SGM-□□□W1□ SGMP-□□□W1□	Absolute encoder: 1024 pulses per revolution	1

Use the following user constant to set the number of pulses for the absolute encoder to be used:

Cn-11	PULSNO Number of Encoder Pulses	Unit: P/R	Setting Range: Number of Encoder Pulses	Factory Setting: 2048	For Speed/Torque Control and Position Control
--------------	------------------------------------	--------------	--	--------------------------	---

Sets the number of encoder pulses according to the servomotor type to be used. After changing this user constant setting, turn the power OFF, then ON. This makes the new setting valid.

Motor Type	Number of Encoder Pulses Per Revolution	Preset Value
SGM-□□□31□ SGMP-□□□31□	Incremental encoder: 2048 pulses per revolution	2048
SGM-□□□W1□ SGMP-□□□W1□	Absolute encoder: 1024 pulses per revolution	1024

5) Using a Battery

Use the following battery to enable the absolute encoder to store position information even when the power is turned OFF. Load the battery in the host controller and connect it to Servopack input terminals BAT and BAT0.

Recommended battery:	<ul style="list-style-type: none"> Connect the battery securely to prevent contact faults resulting from environmental changes or aging. Battery voltage is not monitored inside the Servopack. Provide a battery voltage monitor circuit as necessary.
Lithium battery Toshiba Battery ER6V C3 Type 3.6 V, 2000 mAH	Minimum voltage: 2.8 V

6) Setting up Absolute Encoder

a) Set up the absolute encoder in the following cases:

- When starting the machine for the first time
- When the absolute encoder is not connected to power supply or backup power supply (battery) for more than two days

NOTE Improper setup may cause malfunctions such as improper encoder operation and/or strain on the battery. Follow the setup procedure on the next page.

3.8.5 Using an Absolute Encoder cont.

b) The setup procedure is as follows:

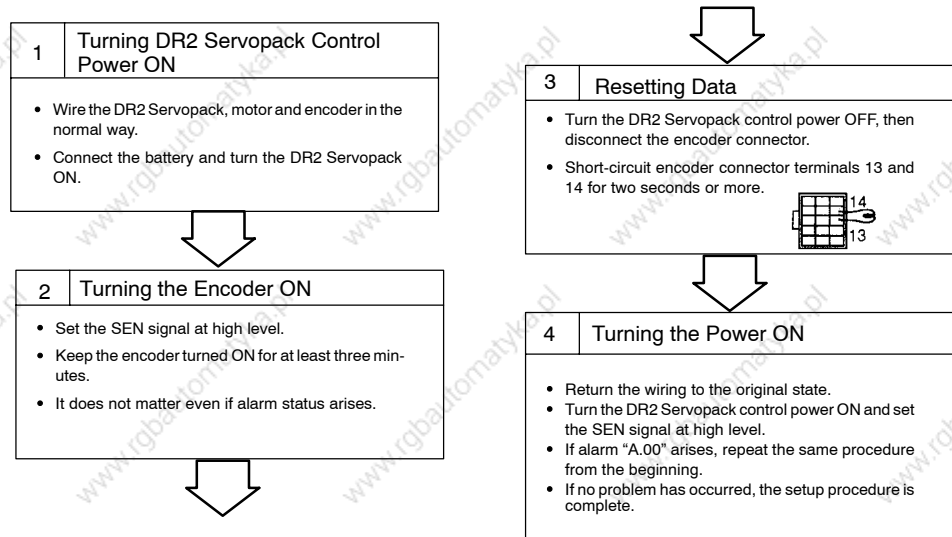

NOTE Setting up the encoder sets the revolution count inside the encoder to 0. After setting up the encoder, always reset the machine home position. Operating the machine without the home position being reset does not only damage the machine but may also cause an accident resulting in injury or death.

7) Absolute Data Exchange Sequence

The Servopack sends absolute data to the host controller when receiving output from a 12-bit absolute encoder. This data exchange sequence is described below.

Use the following detailed information when designing a host controller.

a) Outline of Absolute Signal

The 12-bit absolute encoder outputs PAO, PBO, PCO and PSO as shown on the right.

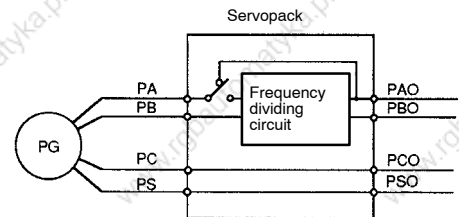

Signal Name	Status	Contents
PAO	Initial state	Serial data Initial incremental pulse
	Normal state	Incremental pulse
PBO	Initial state	Initial incremental pulse
	Normal state	Incremental pulse
PCO	Normal state	Home position pulse
PSO	Normal state	Rotation count serial data

b) Contents of Absolute Data

Serial Data: Indicates how many turns the motor shaft has made from the reference position (position specified at setup).

Initial Incremental Pulse: Outputs pulses at the same pulse rate as when the motor shaft rotates from the home position to the current position at the maximum speed of 4900 r/min.

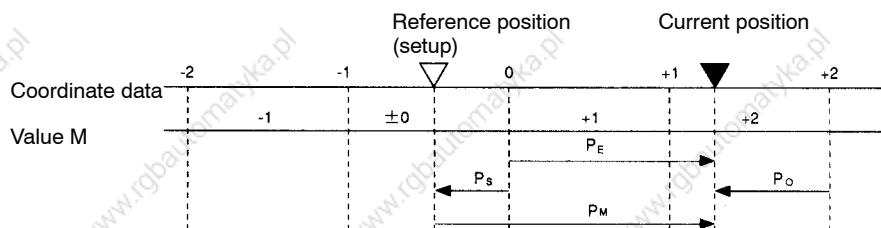

Absolute data P_M can be determined using the following formula.

$$P_E = M \times R + P_o$$

$$P_M = P_E - P_s$$

P_E	Current value read by encoder
M	Serial data (rotation count data)
P_o	Number of initial incremental pulses (Normally, this is a negative value)
P_s	Number of initial incremental pulses read at setup
P_M	Current value required for the customer system
R	Number of pulses per encoder revolution (pulse count after dividing, value of Cn-0A)

c) Absolute Data Transmitting Sequence

- Set the SEN signal at high level.
- After 100 ms, set the system to serial data reception-waiting-state. Clear the incremental pulse up/down counter to zero.
- Receive eight bytes of serial data.
- The system enters a normal incremental operation state approximately 50 ms after the last serial data is received.

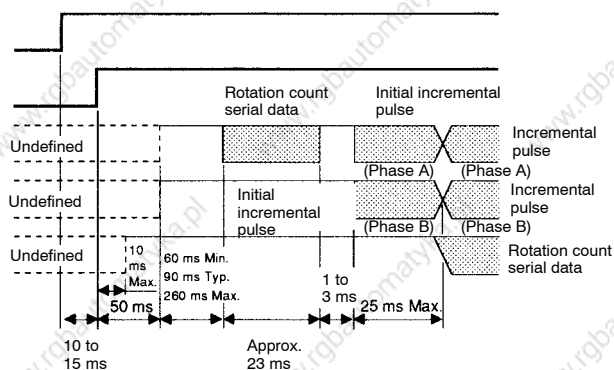

d) Detailed Specifications of Each Signal

• Specifications of PAO Serial Data:

The number of revolutions is output in five digits.

Data transmission method	Start-stop synchronization (ASYNC)
Baud rate	9600
Start bit	1 bit
Stop bit	1 bit
Parity	Even number
Character code	ASCII 7-bit code
Data format	8 characters. As shown on the right.

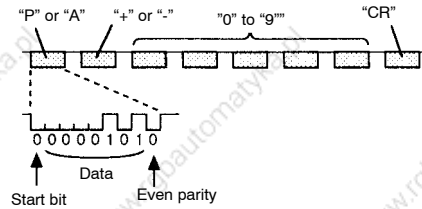

- Data is P+00000 (CR) or P-00000 (CR) when the number of revolutions is zero.
- The maximum number of revolutions is ±99999. If this value is exceeded, it returns to 00000.

• Specifications of PSO Serial Data:

The number of revolutions and the absolute position within one revolution are always output in five and four digits, respectively. The transmission cycle is approximately 40 ms.

Data transmission method	Start-stop synchronization (ASYNC)
Baud rate	9600
Start bit	1 bit
Stop bit	1 bit
Parity	Even number
Character code	ASCII 7-bit code
Data format	13 characters. As shown on the right.

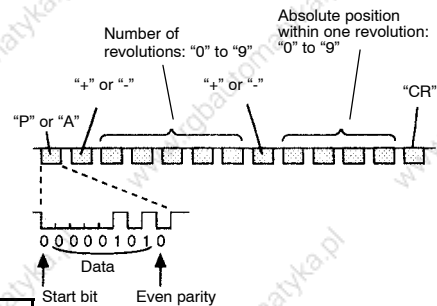

- Absolute position data within one revolution is a value before frequency dividing. (4,096 pulses per revolution)
- Absolute position data increases during forward rotation (standard setting). (Not valid in reverse rotation mode)

• Incremental Pulse and Home Position Pulse:

Initial incremental pulses which provide absolute data are first divided by the frequency divider inside the Servopack and then output in the same way as normal incremental pulses.

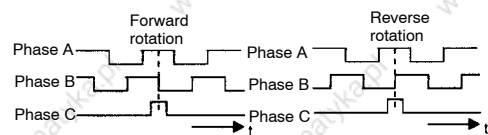

- Note that phase C is not divided so its pulse width is narrower than phase A.

- Use the following user constant to set the pulse dividing ratio.

Cn-0A	PGRAT Dividing Ratio Setting	Unit: P/R	Setting Range: 16 to Number of Encoder Pulses	Factory Setting: 2048	For Speed/Torque Control and Position Control
--------------	------------------------------------	-----------	--	-----------------------------	---

Set the number of output pulses for PG output signals (PAO, *PAO, PBO and *PBO).

Pulses from motor encoder (PG) are divided by the preset number of pulses before being output.

The number of output pulses per revolution is set in this user constant. Set this value according to the reference unit of the machine or controller to be used.

The setting range varies according to the encoder used.

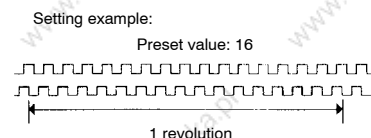
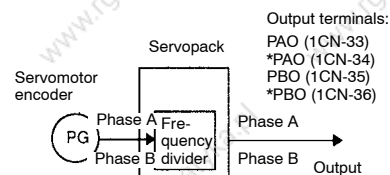

Motor Type	Number of Encoder Pulses Per Revolution	Setting Range
SGM-□□□31□ SGMP-□□□31□	Incremental encoder: 2048 pulses per revolution	16 to 2048
SGM-□□□W1□ SGMP-□□□W1□	Absolute encoder: 1024 pulses per revolution	16 to 1024

8) Alarm Display

When a 12-bit absolute encoder is used, the following alarms are detected and displayed.

List of Alarms

Alarm Type	Meaning	Digital Operator Display	PAO Serial Data	PSO Serial Data
Backup Alarm	Indicates that backup voltage drop was detected. (This alarm helps maintain reliability of rotation count data.)		ALM81. (CR)	ALARMOA BACK (CR)
Battery Alarm	Indicates that backup voltage drop was detected. (This alarm warns of battery replacement and disconnection.)		ALM83. (CR)	ALARMOD BATT (CR)
Checksum Error	Indicates that an error was detected in memory data check.		ALM82. (CR)	ALARMOB CHEC (CR)
Overspeed	Indicates that the motor was running at a speed exceeding 400 r/min when the encoder was turned ON.		ALM85. (CR)	ALARMOP OVER (CR)
Absolute Error	Indicates that an error was detected in sensor check inside the encoder.		ALM84. (CR)	ALARMOH ABSO (CR)
Backup/Battery Combination Alarm			ALM81. (CR)	ALARMOE BACK (BATT) (CR)

The SEN signal can be used to output alarm information from PAO and PSO as serial data. (This function is not available if the Servopack control power is turned OFF by the external circuit when an alarm occurs.)

SEN Signal	"L":			
	"H" Error detection "H"		"H"	"L"
Digital Operator Display		or		
	Absolute encoder alarm (Details unknown)		Absolute encoder alarm (Alarm type identified)	
PAO Serial Data		ALM80. (CR)	ALARMO* (CR)	ALM8*. (CR)
	Incremental pulse			
PSO Serial Data	P±□□□□□, □□□□ (CR)	H±□□□□□, □□□□ (CR)	(Undefined)	ALARMO* **** (CR)
	and so on		(Undefined)	

9) Absolute Encoder Home Position Error Detection

Cn-02 Bit 1	Absolute Encoder Home Position Error Detection	Factory Setting: 0	For Speed/Torque Control and Position Control
--------------------	--	--------------------	---

This memory switch is used to specify whether to use **home position error detection** (alarm A.80) when an absolute encoder is used.

Setting	Meaning
0	Detects a home position error.
1	Does not detect a home position error.

Normally, set this memory switch to "0."

This memory switch has no significance when an incremental encoder is used.

3.8.6 Extending an Encoder Cable

1) Both incremental and absolute encoders have a standard encoder cable (maximum 20 meters (65.6 ft.)). If a longer cable is required, prepare an extension cable as described below. The maximum allowable cable length is 50 meters (164 ft.).

a) 3-meter (19.8 ft.) Cable with Connectors:

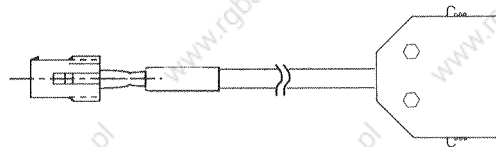

- For incremental encoder: DP9320082-1
- For absolute encoder: DP9320084-1



Home position error detection

This function detects an encoder count error resulting from noise. It checks the number of pulses per motor revolution, and outputs a home position error alarm if that number is incorrect.

If the absolute encoder detects an error, it inverts phase C and notifies the Servopack of the error. In this case, this "home position error detection" function also works.

APPLICATIONS OF Σ -SERIES PRODUCTS

3.8.6 Extending an Encoder Cable cont.

b) 50-meter (164 ft.) Extension Cable:

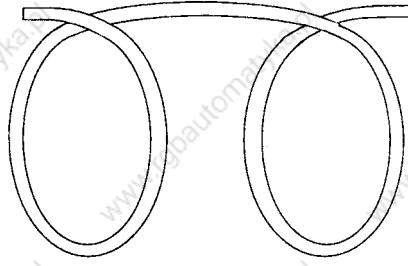

- For both incremental and absolute encoders: DP8409179



Cut this cable 30 cm (0.98 ft.) or less from each end.

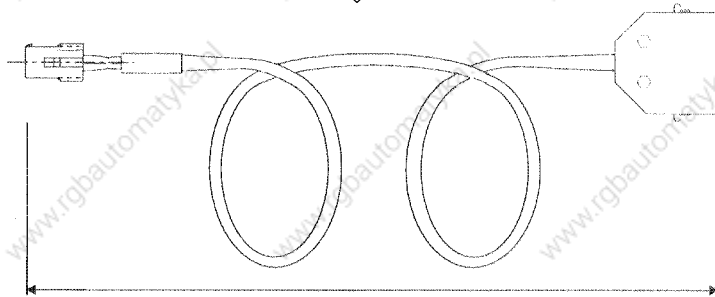
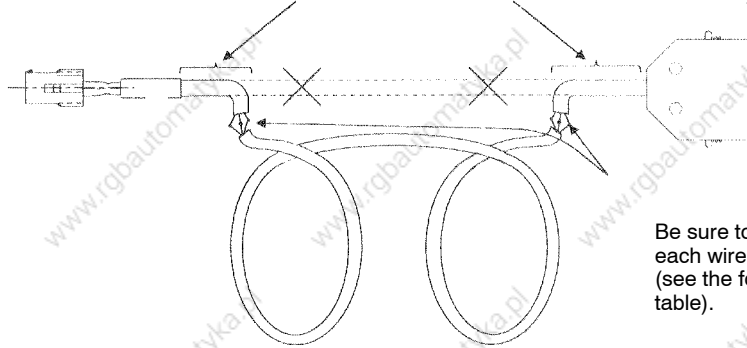

Maximum 50 m (164 ft.)

- 2) Connect cables of the same color to each other as shown in the table below. Note that wiring for incremental and absolute encoders is different.

Signal Name	Color and Wire Size of Cable with Connectors		Color and Wire Size of 50-meter Extension Cable (DP8409179)	
PG5V	Red	AWG22	Red	AWG16
PG0V	Black	AWG22	Black	AWG16
FG	Green/Yellow	AWG22	Green/Yellow	AWG16
PA	Blue	AWG26	Blue	AWG26
*PA	White/Blue	AWG26	White/Blue	AWG26
PB	Yellow	AWG26	Yellow	AWG26
*PB	White/Yellow	AWG26	White/Yellow	AWG26
PC	Green	AWG26	Green	AWG26
*PC	White/Green	AWG26	White/Green	AWG26
PS	Violet	AWG26	Purple	AWG26
*PS	White/Green	AWG26	White/Green	AWG26
RESET	White/Gray	AWG26	White/Gray	AWG26
BAT	Orange	AWG26	Orange	AWG26
BAT0	White/Orange	AWG26	White/Orange	AWG26

Only the absolute encoder can be connected.

3

3.8.7 Using DR2 Servopack with High Voltage Line

- 1) DR2 Servopacks are divided into single-phase 200 V and single-phase 100 V types according to supply voltage.

If, however, three-phase 400 VAC class (400 V, 440 V) power supply must be used, prepare the following power transformer (for single-phase).

<Primary side>

<Secondary side>

1) 400 or 440 VAC

→

200 VAC

2) 400 or 440 VAC

→

100 VAC

APPLICATIONS OF Σ -SERIES PRODUCTS

3.8.7 Using DR2 Servopack with High Voltage Line cont.

- 2) Select appropriate power transformer capacity according to the following table.

Supply Voltage	Servopack Type	Power Supply Capacity Per DR2 Servopack (kVA) (see note)
200 V	DR2-A3A	0.25
	DR2-A5A	0.3
	DR2-01A	0.5
	DR2-02A	0.75
	DR2-04A	1.2
	DR2-08A	2.2
100 V	DR2-A3B	0.25
	DR2-A5B	0.3
	DR2-01B	0.5
	DR2-02B	0.75
	DR2-03B	1.4

Note At rated load.

- 3) When 400V class supply voltage is used:

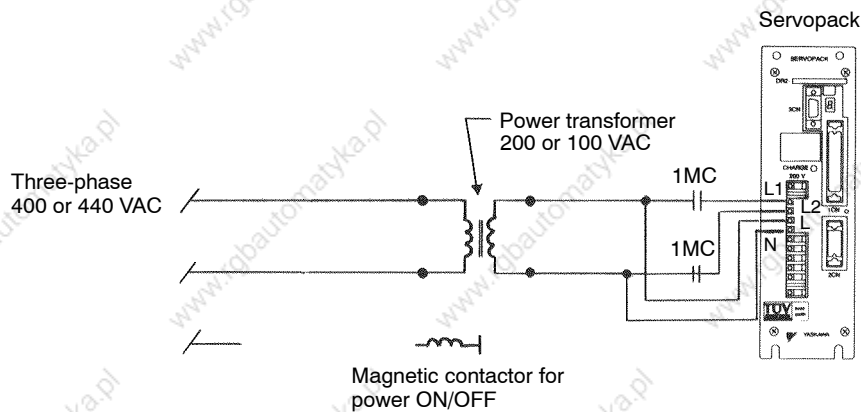

3.8.8 Connector Terminal Layouts

This section describes connector terminal layouts for Servopacks, Servomotors and Digital Operator.

1) Servopack Connectors for Speed/Torque and Position Control

1CN Terminal Layout

50	FG	Frame Ground				18	PL3	Open Collector Reference Power Supply
49	*PSO	Line Driver output Phase-S				17	VTG-M	Speed Monitor
48	PSO		32	ALM-	Servo Alarm Output	16	TRQ-M	Torque Monitor
47	+24V IN	External Input Power Supply	31	ALM+		15	CLR	Error Counter Clear Input
46	$\overline{N-CL}$	Reverse Current Limit ON Input	30	$\overline{S-RDY}$	Servo Ready Output	14	*CLR	
45	$\overline{P-CL}$	Forward Current Limit ON Input	29	$\overline{S-RDY+}$		13	PL2	Open Collector Reference Power Supply
44	$\overline{ALM-RST}$	Alarm Reset Input	28	TGON-	TGON Output Signal	12	*SIGN	Reference Sign Input
43	N-OT	Reverse Running Prohibit Input	27	TGON+		11	SIGN	
42	P-OT	Forward Running Prohibit Input	26	$\overline{CLT} (COIN-)$	Current Limit Detection Output	10	SG	GND
41	$\overline{P-CON}$	P Control Input	25	$\overline{CLT} (COIN+)$		9	T-REF	Torque Reference Input
40	$\overline{S-ON}$	Servo ON Input	24	-15V	Speed/Torque Reference Power Supply	8	*PULS	Reference Pulse Input
39	ALO3	Alarm Code Output, Open Collector Output	23	+15V		7	PULS	
38	ALO2		22	BAT-	Battery -	6	SG	GND
37	ALO1		21	BAT+	Battery +	5	V-REF	Speed Reference Input
36	*PBO	Line Driver Output Phase-B	20	*PCO	Line Driver Output Phase-C	4	SEN	SEN Signal Input
35	PBO		19	PCO		3	PL1	Open Collector Reference Power Supply
34	*PAO	Line Driver Output Phase-A				2	SG	GND
33	PAO					1	SG	

- **Servopack Side** Connector type: MR-50RFA4 (manufactured by Honda Tsushin Kogyo Co., Ltd.)
- **Cable Side** Connector type: MR-50M (Soldering type, manufactured by Honda Tsushin Kogyo Co., Ltd.)
MRP-50M01 (Caulking type, manufactured by Honda Tsushin Kogyo Co., Ltd.)
Connector case type: MR-50L (manufactured by Honda Tsushin Kogyo Co., Ltd.)

APPLICATIONS OF Σ -SERIES PRODUCTS

3.8.8 Connector Terminal Layouts cont.

2CN Terminal Layout

· For Incremental Encoder

14	PC	8		1	PG0V
15	*PC	9		2	PG0V
16	PA	10		3	PG0V
17	*PA	11		4	PG5V
18	PB	12		5	PG5V
19	*PB	13		6	PG5V
20	FG			7	DIR

· For 12-bit Absolute Encoder

14	PC	8	PS	1	PG0V
15	*PC	9	*PS	2	PG0V
16	PA	10	RESET	3	PG0V
17	*PA	11		4	PG5V
18	PB	12	BAT	5	PG5V
19	*PB	13	BAT0	6	PG5V
20	FG			7	DIR

- **Servopack Side** Connector type: MR-20RMA4 (manufactured by Honda Tsushin Kogyo Co., Ltd.)
- **Cable Side** Connector type: MR-20F (Soldering type, manufactured by Honda Tsushin Kogyo Co., Ltd.)
MRP-20F01 (Caulking type, manufactured by Honda Tsushin Kogyo Co., Ltd.)
Connector case type: MR-20L (manufactured by Honda Tsushin Kogyo Co., Ltd.)

2) Connectors for Incremental Encoder

1	Channel A output	Blue
2	Channel \bar{A} output	Blue/Black
3	Channel B output	Yellow
4	Channel \bar{B} output	Yellow/Black
5	Channel C output	Green
6	Channel \bar{C} output	Green/Black
7	0 V (power supply)	Gray
8	+5 V (power supply)	Red
9	Frame ground (FG)	Orange



Items to be Prepared by Customer
 (Manufactured by AMP)
 Cap: 172161-1
 Socket: 170361-1 (chain type) or
 170365-1 (loose type)

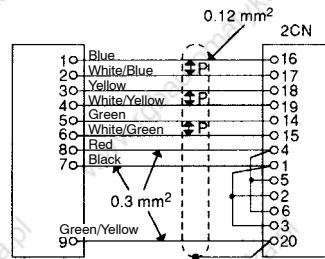
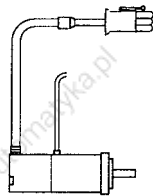
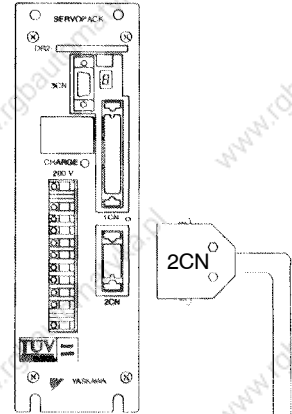

Items to be Prepared by Customer

Case:
 MR-20L
 (manufactured by Honda Tsushin
 Kogyo Co., Ltd.)

Connector:
 soldering type: MR-20F
 Caulking type: MRP-20F01
 (manufactured by Honda Tsushin
 Kogyo Co., Ltd.)

3) Connectors for Absolute Encoder

1	Channel A output	Blue
2	Channel \bar{A} output	White/Blue
3	Channel B output	Yellow
4	Channel \bar{B} output	White/Yellow
5	Channel Z output	Green
6	Channel \bar{Z} output	White/Green
7	0 V (power supply)	Black
8	+5 V (power supply)	Red
9	Frame ground (FG)	Green/Yellow
10	Channel S output	Purple
11	Channel \bar{S} output	White/Purple
12	(Capacitor reset)	(Gray)
13	Reset	White/Gray
14	0 V (battery)	White/Orange
15	3.6 V (battery)	Orange

Do not use this terminal. (It is used to discharge electricity from capacitor before shipment.)



Items to be Prepared by Customer
 (Manufactured by AMP)
 Cap: 172163-1
 Socket: 170361-1 (chain type) or
 170365-1 (loose type)

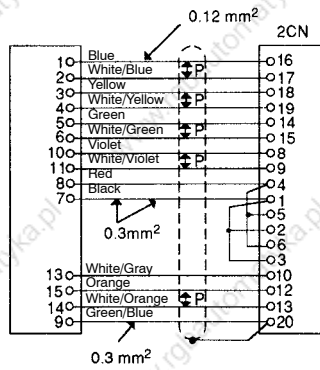
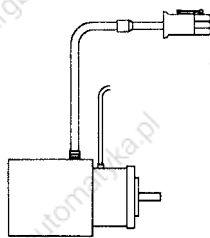
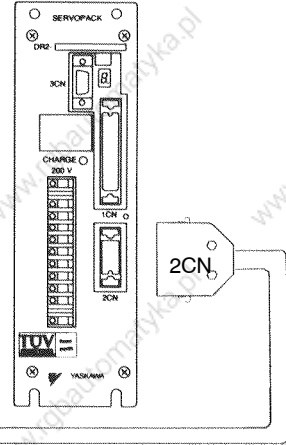

Items to be Prepared by Customer

Case:
 MR-20L
 (manufactured by Honda Tsushin
 Kogyo Co., Ltd.)

Connector:
 soldering type: MR-20F
 Caulking type: MRP-20F01
 (manufactured by Honda Tsushin
 Kogyo Co., Ltd.)

4) Connectors and Terminals for Standard-type Motor without Brake

1	Phase U	Red
2	Phase V	White
3	Phase W	Blue
4	Frame ground (FG)	Green

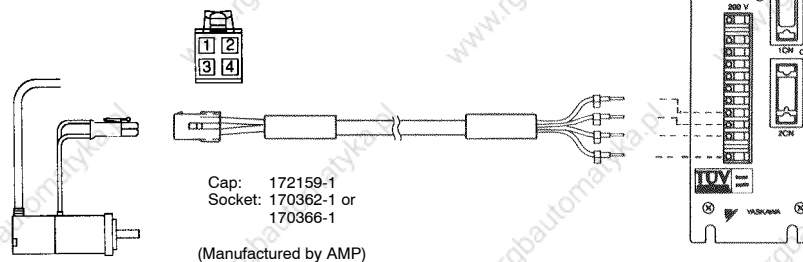

5) Connectors and Terminals for Motor with Brake

1	Phase U	Red
2	Phase V	White
3	Phase W	Blue
4	Frame ground (FG)	Green
5	Brake terminal	Black
6	Brake terminal	Black

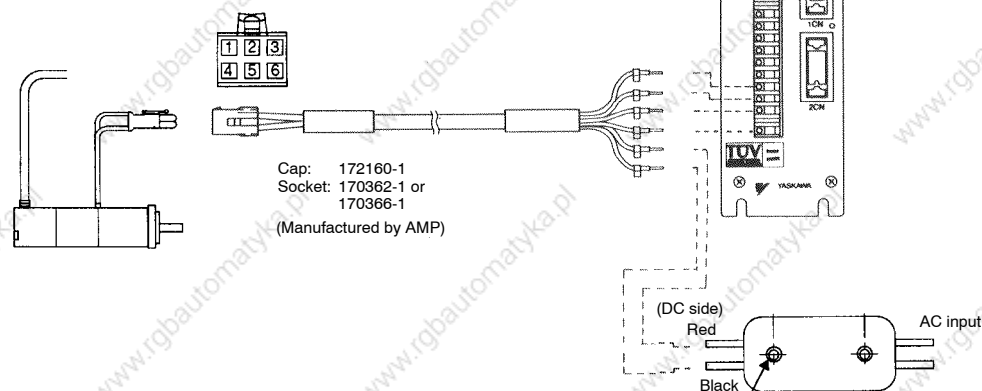

Brake power supply (manufactured by Yaskawa Controls Co., Ltd.)

- 100 VAC input: 90 VDC (LPDE-1H01)
- 200 VAC input: 90 VDC (LPSE-2H01)

6) Connectors for Digital Operator

- JUSP-OP02A-1 (Hand-held Type)

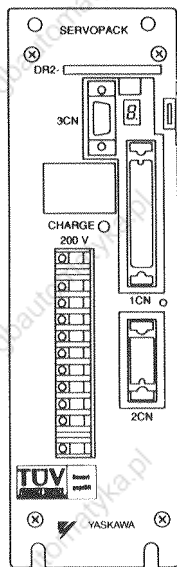
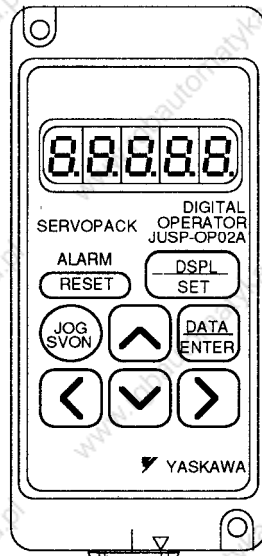

17JE-23090-02
(manufactured by Daiichi
Denshi Kogyo K.K.)

Cable
(Provided)

Pin No.	Signal Name	Signal Circuit Name	Signal Direction
1	TXD	Transmit data (non-inversion side)	P ← S
2	*TXD	Transmit data (inversion side)	P ← S
3	RXD	Receive data (non-inversion side)	P → S
4	*RXD	Receive data (inversion side)	P → S
5	OPH		#
6	*RXD	Shorting pins 6 and 7 produces a terminal resistance of 220 Ω between RXD and *RXD.	
7	RT		
8	5VPP		#
9	GND	Signal ground 0 V	

3

USING THE DIGITAL OPERATOR

4

This chapter describes the basic operation of the digital operator and the convenient features it offers.

All constant settings and motor operations are possible by simple, convenient, operation.

Operate the digital operator as you read through this chapter.

4.1 Basic Operations	170
4.1.1 Connecting the Digital Operator	170
4.1.2 Resetting Servo Alarms	171
4.1.3 Basic Functions and Mode Selection	172
4.1.4 Operation in Status Display Mode	173
4.1.5 Operation in User Constant Setting Mode	176
4.1.6 Operation in Monitor Mode	179
4.2 Using the Functions	183
4.2.1 Operation in Alarm Trace-back Mode	183
4.2.2 Operation Using the Digital Operator	186
4.2.3 Autotuning	188
4.2.4 Reference Offset Automatic Adjustment	195
4.2.5 Speed Reference Offset Manual Adjustment Mode	197
4.2.6 Clearing Alarm Trace-back Data	200
4.2.7 Checking Motor Type	201
4.2.8 Checking Software Version	201

4.1 Basic Operations

This section describes the basic operations using the Digital Operator.

4.1.1	Connecting the Digital Operator	170
4.1.2	Resetting Servo Alarms	171
4.1.3	Basic Functions and Mode Selection	172
4.1.4	Operation in Status Display Mode	173
4.1.5	Operation in User Constant Setting Mode	176
4.1.6	Operation in Monitor Mode	179

4.1.1 Connecting the Digital Operator

The applicable Digital Operator type is JUSP-OP02A-1 (Hand-held Type). Hand-held type is connected to the Servopack as shown below.

JUSP-OP02A-1 (Hand-held Type)

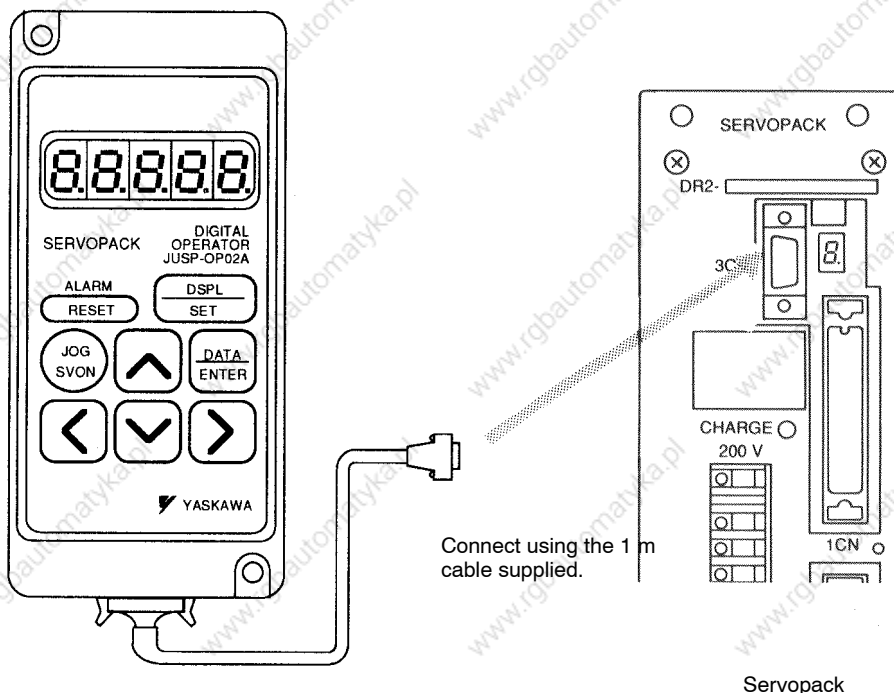

- The Digital Operator connector can be connected or disconnected while the Servopack power is ON.

Note Mount type digital operator (JUSP-OP03A) cannot be used.

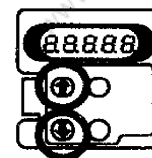

Type: JUSP-OP03A

4.1.2 Resetting Servo Alarms

Servo alarms can be reset using the Digital Operator. (Servo alarms can also be reset by the 1CN-44, ALMRST input signal. Refer to 3.7.1 for details.)

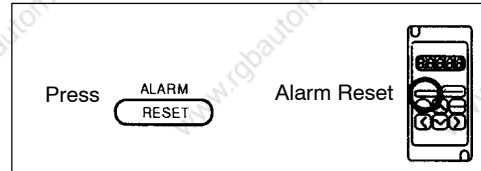

NOTE After an alarm occurs, remove the cause of the alarm before resetting it. Refer to *Section 6.2 Troubleshooting* to determine and remedy the cause of an alarm.

4.1.3 Basic Functions and Mode Selection

Digital Operator operation allows status display, user constant setting, operating reference, and auto-tuning operations.

Basic Mode Selection

The four basic modes are listed below. Each time the mode key is pressed, the next mode in the sequence is selected.

JUSP-OP02A-1



Press the



key to switch the mode.

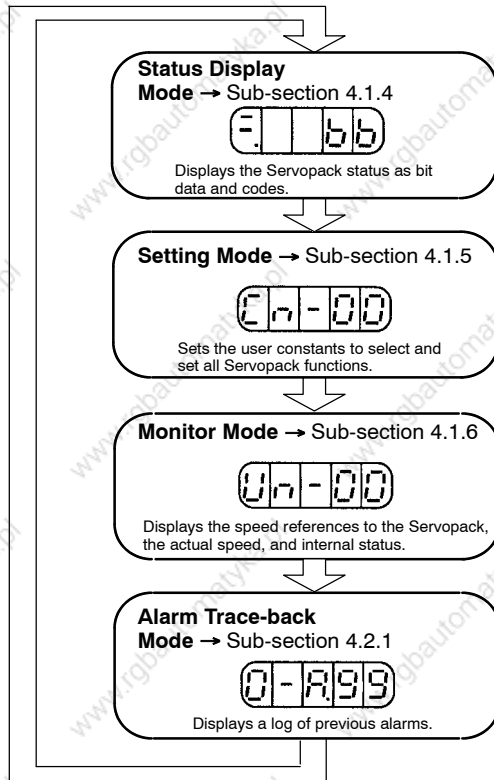

Special Modes

These modes are selected by setting a value for user constant **Cn-00**

Cn-00 Setting	Mode
00-00	Operation mode from Digital Operator → Sub-section 4.2.2
00-01	Reference offset automatic adjustment mode → Sub-section 4.2.4
00-02	Clear alarm trace-back data → Sub-section 4.2.6
00-03	Speed reference offset manual adjustment mode → Sub-section 4.2.5
00-04	Motor-type check mode → Sub-section 4.2.7
00-05	Auto-tuning mode → Sub-section 4.2.3
00-06	Software-version check mode → Sub-section 4.2.8

4

4.1.4 Operation in Status Display Mode

The status display mode displays the Servopack status as bit data and codes.

- Selecting Status Display Mode

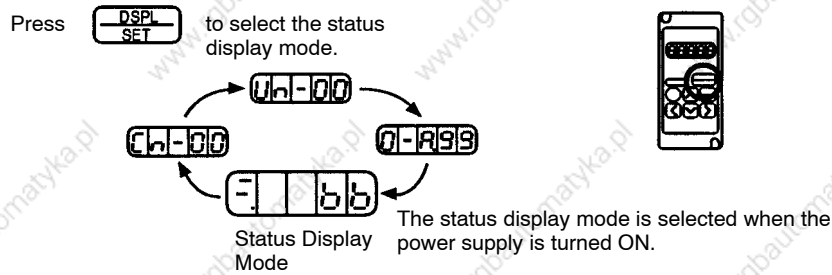





Keys to the status display are shown below. Note that the display differs between the speed/torque control and position control.

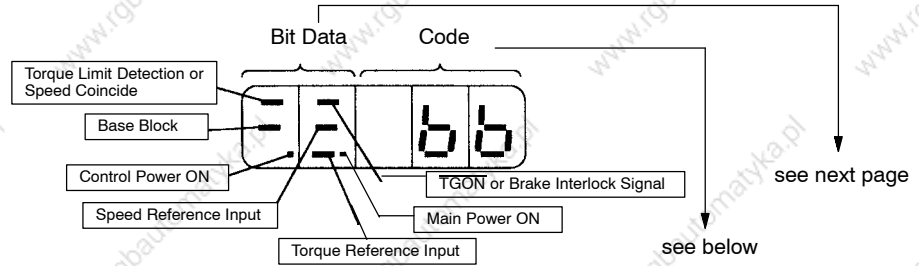

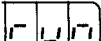
For Speed/Torque Control

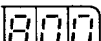

Code	Status
	Base block Servo OFF (motor power OFF)
	Run Servo ON (motor power ON)
	Forward Rotation Prohibited (P-OT) 1CN-42 (P-OT) OFF. See Cn-01 Bit 2 (page 55).
	Reverse Rotation Prohibited (N-OT) 1CN-43 (N-OT) OFF. See Cn-01 Bit 3 (page 55).
	Alarm Status Displays the alarm number. See the table of alarms on page 185.
	
	

USING THE DIGITAL OPERATOR

4.1.4 Operation Status Display Mode cont.

Bit Data	Description
Control Power ON	Lit when Servopack control power ON. Not lit when Servopack control power OFF.
Main Power ON	Lit when Servopack main circuit power ON. Not lit when Servopack main circuit power OFF.
Base Block	Lit for base block. not lit at servo ON.
Torque Limit Detection or Speed Coincide (Selected by Cn-01 bit 4)	Lit if Servopack internal torque reference exceeds preset value. Not lit if Servopack internal torque reference is below preset value. Preset value: Set in Cn-08, -09 (max. torque is standard setting) Cn-18 is preset value during 1CN-45 (P-CL) input. Cn-19 is preset value during 1CN-46 (N-CL) input. (100% of rated torque are standard setting for Cn-18, Cn-19) Not lit during torque control. Lit if motor speed reaches speed reference. Otherwise, not lit.
TGON or Brake Interlock Signal (selected by Cn-01 Bit E)	Lit if motor speed exceeds preset value. Not lit if motor speed is below preset value. Preset value: Set in Cn-0B (20 r/min is factory setting) When brake interlock is ON, between 1CN-27 and -28 is closed and 1CN-27 is Low level, lit when brake is released. When brake interlock is OFF, between 1CN-27 and -28 is open and 1CN-27 is High level, not lit when brake operates.
Speed Reference Input	Lit if input speed reference exceeds preset value. Not lit if input speed reference is below preset value. Specified value: Set in Cn-0B (20 r/min is factory setting)
Torque Reference Input	Lit if input torque reference exceeds preset value. Not lit if input torque reference is below preset value. Preset value: Set in Cn-0B (10% rated torque is standard setting)



For Position Control

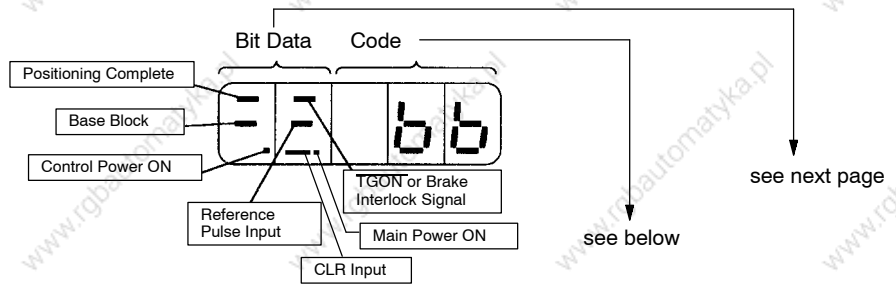

Code	Status
bb	Base block Servo OFF
run	Run Servo ON
Pot	Forward Rotation Prohibited 1CN-42 (P-OT) OFF. See Cn-01 Bit 2 (page 55).
not	Reverse Rotation Prohibited 1CN-43 (N-OT) OFF. See Cn-01 Bit 3 (page 55).
R00	Alarm Status Displays the alarm number. See the table of alarms on page 185.
R02	
~	

4.1.5 Operation in User Constant Setting Mode

Bit Data	Description
Control Power ON	Lit when Servopack control power ON. Not lit when Servopack control power OFF.
Main Power ON	Lit when Servopack main circuit power ON. Not lit when Servopack main circuit power OFF.
Base Block	Lit for base block. Not lit at servo ON.
Positioning Complete	Lit if error between position reference and actual motor position is below preset value. Not lit if error between position reference and actual motor position exceeds preset value. Preset value: Set in Cn-1B (1 pulse is standard setting)
TGON or Brake Interlock Signal (selected by Cn-01 Bit E)	Lit if motor speed exceeds preset value. Not lit if motor speed is below preset value. Preset value: Set in Cn-0B (20 r/min is standard setting) When brake interlock is ON, between 1CN-27 and -28 is closed and 1CN-27 is Low level, lit when brake is released. When brake interlock is OFF, between 1CN-27 and -28 is open and 1CN-27 is High level, not lit when brake operates.
Reference Pulse Input	Lit if reference pulse is input. Not lit if no reference pulse is input.
CLR Input	Lit when clear signal is input. Not lit when clear signal is not input.

4

4.1.5 Operation in User Constant Setting Mode

1) Two types of user constant are used

- a) Constant Settings (Cn-03 to Cn-23)
- b) Memory Switches (Cn-01, Cn-02)

The setting method is different for each type.

The Servopack offers a large number of functions, which are selected and adjusted by the user constant settings.

The constant settings (Cn-03 to Cn-23) allow setting of a constant within a fixed range.

The memory switches (Cn-01, Cn-02) allow the required functions to be selected.





Refer to *Appendix D List of User Constant Settings*.

2) Using the Setting Mode for Constant Settings (Cn-03 to Cn-23)

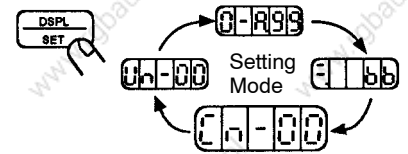
The constant settings (Cn-03 to Cn-23) allow setting of a constant. Check the permitted range of the constant in *Appendix D List of User Constant Settings*, before changing the data. The example below shows how to change user setting Cn-15 from 100 to 85.

- 1) Press  to select the user constant setting mode.





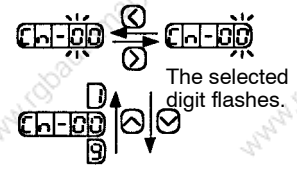

- 2) Select the user constant number to set.
Press the  and  keys to select the digit.
Press the  and  keys to change the value.

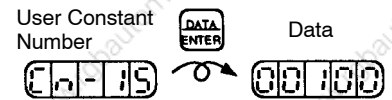

- 3) Press  to display the current data for the user constant selected at step 2.



- 4) Set the required data.
Press the  and  keys to select the digit.
Press the  and  keys to change the value.

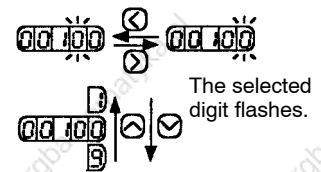

- 5) Press  to store the data.

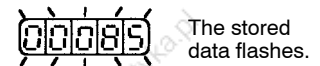

- 6) Press  once more to display the user constant number again.

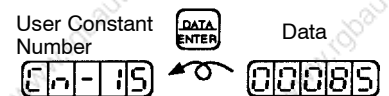

- 7) Repeat steps 2 to 6 as often as required.

- Refer to *Appendix D List of User Constant Settings*.

3) Using the Setting Mode for Memory Switches (Cn-01, Cn-02)

Turn the bits of the memory switches ON and OFF to select the functions required. The example below shows how to turn ON Bit 4 of memory switch Cn-01.

1) Press to select the user constant setting mode.

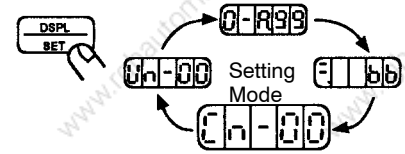

2) Select the user constant number to set.
Press the and keys to select the digit.
Press the and keys to change the value.

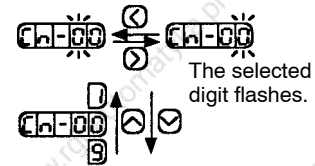

3) Press to display the current data for the memory switch selected at step 2.

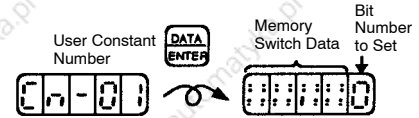

4) Press the and keys to select the bit number to set.

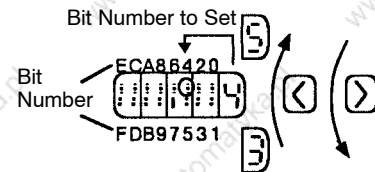

5) Press the and keys to set the memory switch data ON or OFF for the bit number.

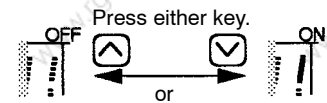

6) Repeat steps 4 and 5 as often as required.

7) Press to store the data.

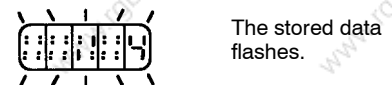

Turning Bits ON and OFF

Memory switches use bits, not numbers, to select functions.

Sixteen bits are available (1 to 9 and A to E). Select the required functions by turning the appropriate bit ON (function ON) or OFF (function OFF).

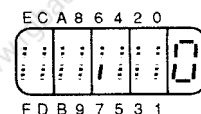

: = OFF
| = ON

- 8) Press  once more to display the user constant number again.

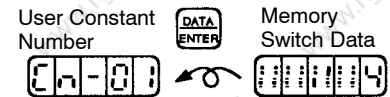

- Refer to *Appendix D List of User Constant Settings*.

4.1.6 Operation in Monitor Mode



- 1) The monitor mode allows the reference values input into the Servopack, I/O signal status, and Servopack internal status to be monitored. The monitor mode can be set during motor operation.

2) Using the Monitor Mode

The example below shows how to display 1500, the contents of monitor number Un-00.

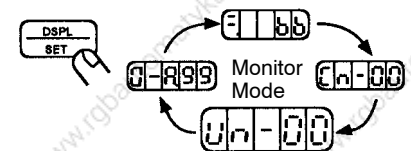
- 1) Press  to select the monitor mode



- 2) Press the  and  keys to select the monitor number to display.

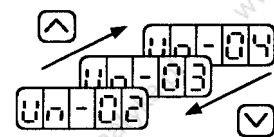

- 3) Press  to display the data for the monitor number selected at step 2.



- 4) Press  once more to display the monitor number again.



USING THE DIGITAL OPERATOR

4.1.6 Operation in Monitor Mode cont.

- 3) Keys to Monitor Mode Display are shown below. Note that the display differs between the speed/torque control and position control types.



For Speed/Torque Control

Monitor Number	Monitor Display
Un-00	Actual motor speed Units: r/min
Un-01	Input speed reference Units: r/min
Un-02	Internal torque reference Units: % (with respect to rated torque)
Un-03	Number of pulses from motor U-phase edge Units: pulses
Un-04	Electrical angle Units: 0.1deg
Un-05	Internal status bit display

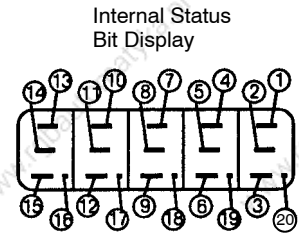

see below

Bit #	Description	Related I/O Signal, User Constant	
1	Servo alarm	1CN-31(ALM)	
2	Dynamic brake ON		
3	Reverse rotation mode	Cn-02 Bit 0, 2CN-7(DIR)	
4	During motor rotation or brake interlock signal	1CN-27 (TG-ON), status display mode	
5	Torque limit or speed coincide	1CN-25 (V-CMP), status display mode	
6	Mode switch ON		
7	During forward torque limit	Or contact input speed control	1CN-45 (P-CL)
8	During reverse torque limit		1CN-46 (N-CL)
9	Motor power ON		
10	A-phase	2CN-33(PA), 2CN-34(*PA)	
11	B-phase	2CN-35(PB), 2CN-36(*PB)	
12	C-phase	2CN-19(PC), 2CN-20(*PC)	
13	U-phase	Only when incremental encoder is used.	
14	V-phase	Only when incremental encoder is used.	
15	W-phase	Only when incremental encoder is used.	
16	Servo ON	1CN-40 (S-ON) , Cn-01 Bit 0	
17	P operation, zero clamp, or rotation direction input	1CN-41 (P-CON) , Cn-01 Bit A, B, Cn-02 Bit 2	
18	Forward overtravel	1CN-42 (P-OT), Cn-01 Bit 2	
19	Reverse overtravel	1CN-43 (N-OT), Cn-01 Bit 3	
20	SEN signal input	1CN-4 (SEN)	



For Position Control

Monitor Number	Monitor Display
Un-00	Actual motor speed Units: r/min
Un-02	Internal torque reference Units: % (with respect to rated torque)
Un-03	Number of pulses from motor U-phase edge Units: pulses
Un-04	Electrical angle Units: 0.1deg
Un-05	Internal status bit display
Un-06	Internal status bit display
Un-08	Positional error Units: x1 reference unit (Cn-02 Bit E = 0) x100 reference unit (Cn-02 Bit E = 1)
Un-09	Reference pulse counter value Units: Reference unit Displays 0 to 65535

Internal Status Bit Display

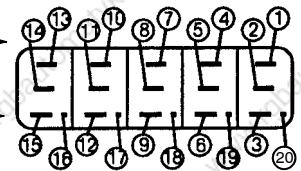

Monitor #	Bit #	Description	Related I/O Signal, User Constant	
Un-05	1	Servo alarm	1CN-31 (ALM)	
	2	Dynamic brake ON		
	3	Reverse rotation mode	Cn-02 Bit 0, 2CN-7 (DIR)	
	4	During motor rotation or brake interlock signal	1CN-27 ($\overline{\text{TG-ON}}$), status display mode	
	5	Positioning complete	1CN-25 ($\overline{\text{COIN}}$), status display mode	
	6	Mode switch ON		
	7	During forward torque limit	Or contact input speed control	1CN-45 (P-CL)
	8	During reverse torque limit		1CN-46 (N-CL)
	9	Motor power ON		
	10	A-phase	2CN-33(PA), 2CN-34(*PA)	
	11	B-phase	2CN-35(PB), 2CN-36(*PB)	
	12	C-phase	2CN-19(PC), 2CN-20(*PC)	
	13	U-phase	Only when incremental encoder is used.	
	14	V-phase	Only when incremental encoder is used.	
	15	W-phase	Only when incremental encoder is used.	
	16	Servo ON	1CN-40 (S-ON), Cn-01 Bit 0	
	17	P operation or rotation direction input	1CN-41 (P-CON)	
	18	Forward overtravel	1CN-42 (P-OT), Cn-01 Bit 2	
	19	Reverse overtravel	1CN-43 (N-OT), Cn-01 Bit 3	
	20	Not used		

USING THE DIGITAL OPERATOR

4.1.6 Operation in Monitor Mode cont.

Monitor #	Bit #	Description	Related I/O Signal, User Constant
Un-06	1	Input reference pulse	1CN-1 (PLUS), 1CN-2(*PULS)
	2	Input pulse sign	1CN-3(SIGN), 1CN-4 (*SIGN)
	3	Error counter clear input	1CN-5 (CLR), 1CN-6(*CLR)
	4 to 12	Not used.	
	13	Full-closed Phase-A	4CN-2 (FA), 4CN-3 (*FA)
	14	Full-closed Phase-B	4CN-4 (FB), 4CN-5 (*FB)
	15	Full-closed Phase-C	4CN-6 (FC), 4CN-7 (*FC)
	16 to 20	Not used.	

4.2 Using the Functions

This section describes how to use the basic operations described in section 1 to operate and adjust the motor.

4.2.1	Operation in Alarm Trace-back Mode	183
4.2.2	Operation Using the Digital Operator	186
4.2.3	Autotuning	188
4.2.4	Reference Offset Automatic Adjustment	195
4.2.5	Speed Reference Offset Manual Adjustment Mode	197
4.2.6	Clearing Alarm Trace-back Data	200
4.2.7	Checking Motor Type	201
4.2.8	Checking Software Version	201

4.2.1 Operation in Alarm Trace-back Mode

- 1) The alarm trace-back mode displays up to ten alarms which occurred previously. By allowing confirmation of what alarm occurred when, it is a useful aid to speed up troubleshooting.

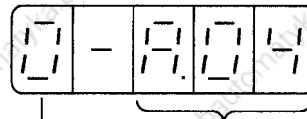

Alarm Sequence Number
The higher the number,
the older the alarm data

Alarm Code

See the table of
alarms on page 185.

NOTE The alarm trace-back data is not cleared on alarm reset or when the Servopack power is turned OFF. This does not adversely affect operation. The data is cleared using the special mode: Clear alarm trace-back data. Refer to sub-section 4.2.6 for details.

USING THE DIGITAL OPERATOR



4.2.1 Operation in Alarm Trace-back Mode cont.

2) Using the Alarm Trace-back Mode

Follow the procedure below to determine which alarms occurred previously.

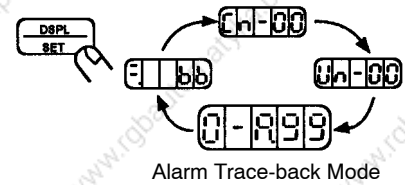
- 1) Press  to select the alarm trace-back mode.



- 2) Press the  and  keys to scroll the alarm sequence numbers up and down and display information on previous alarms. The higher the left-hand digit (alarm sequence number), the older the alarm data.

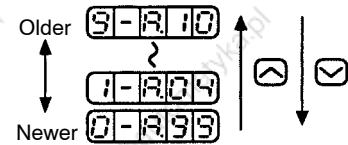

3) The table below lists the alarms displayed in the alarm trace-back mode.

Displayed Alarm Code	Description
R00	Absolute data error
R02	User constant breakdown
R04	User constant setting error
R10	Overcurrent
R20	Blown fuse
R30	Regenerative error
R31	Position error pulse overflow (for position control only)
R40	Overvoltage
R51	Overspeed
R70	Overload
R80	Absolute encoder error
R81	Absolute encoder back-up error
R82	Absolute encoder checksum error
R83	Absolute encoder battery error
R84	Absolute encoder data error
R85	Absolute encoder overspeed
Rb1	Reference input read error
Rc1	Servo overrun detected (This function prevents (or minimizes) overrun.)
Rc2	Encoder output phase error Incremental encoder initial pulse error
Rc3	Encoder A-, B-phase disconnection
Rc4	Encoder C-phase disconnection
Rc6	External PG A-, B-phase disconnection
Rc7	External PG C-phase disconnection
R99	Not an alarm. Reset by alarm reset or Servopack power ON.

4.2.2 Operation Using the Digital Operator

The following are operator-related alarms which are not recorded by alarm trace-back.

CPFD0	Digital Operator transmission error 1
CPFD1	Digital Operator transmission error 2

- Refer to the troubleshooting procedures when an alarm occurs, described in section 6.2.

4.2.2 Operation Using the Digital Operator



Simple Motor Check

Operation from the Digital Operator allows the Servopack to run the motor. This allows rapid checking of basic operations during machine set-up and testing, without the trouble of connecting a host controller.

Used during machine set-up and testing. Forward, reverse, speed settings possible.

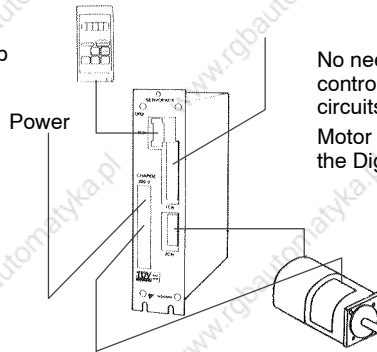

No need to connect to host controller or external circuits.

Motor can be run just from the Digital Operator.

1) Operation Using the Digital Operator

Use the following procedure to operate the motor from the Digital Operator

- 1) Press to select the user constant setting mode.

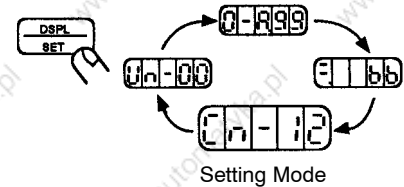

Setting Mode

- 2) Select the user constant number Cn-00.
(User constant Cn-00 is selected when the power is turned ON.)

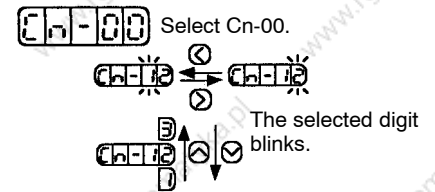

Press the and keys to select the digit.

Press the and keys to change the value.

- 3) Press to display the current data for the user constant Cn-00.



- 4) Press the and keys to change the data to 00.
(This user constant is set to 00 when the power is turned ON.)

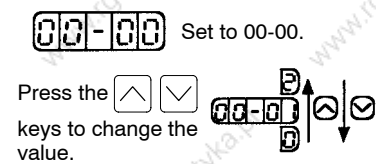

- 5) Press to set the Digital Operator in operation mode. Operation is now possible under Digital Operator control.

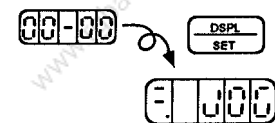

- 6) Press to set the servo ON status (motor power turned ON).

Select Servo ON/Servo OFF

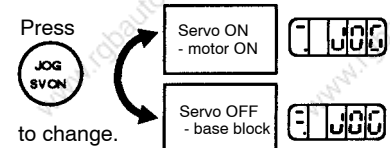

- 7) Press the and keys to operate the motor.

Motor Forward/Reverse Rotation

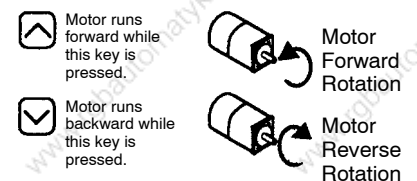

- 8) Press to revert to . This sets the servo OFF status (motor power turned OFF).

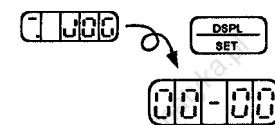

(Alternatively, press to set the servo OFF status.)

- 9) Press to return to the setting mode display. This disables operation under Digital Operator control.

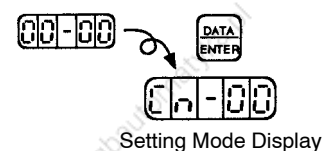

2) Changing Motor Speed

The motor speed for operation under Digital Operator control can be changed with a following user constant.

Cn-10	JOGSPD	Jog Speed	Unit: r/min	Setting Range: 0 to MAX. Speed	Factory Setting: 500	For Speed/Torque Control and Position Control
--------------	--------	-----------	-------------	--------------------------------	----------------------	---

Set the motor speed (JOG speed) in this user constant when motor is operated using the digital operator.

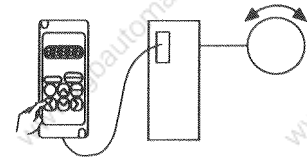

Set the motor speed (JOG speed) in this user constant when motor is operated using the digital operator.

For details about setting the motor speed, refer to 4.1.5 Operation in User Constant Setting Mode and Appendix D List of User Constants.

4.2.3 Autotuning



No experience required to achieve optimum settings.

The Servopack contains a built-in autotuning function to automatically measure the machine characteristics and set the user constants.

Servo drives normally require tuning to match the machine configuration and rigidity. This tuning requires a great deal of experience and is difficult for a person unfamiliar with the tuning procedure.

However, autotuning allows even totally inexperienced people to easily complete the tuning.

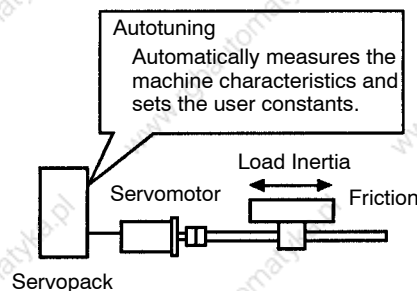

Autotuning is similar to auto-focus for a camera.

3) User Constants Automatically Settable with Autotuning



Speed/torque control

Cn-04	Speed loop gain
Cn-05	Speed loop integration time constant



Position control

Cn-04	Speed loop gain
Cn-05	Speed loop integration time constant
Cn-1A	Position loop gain

Once autotuning has been completed, the autotuning procedure can be omitted for subsequent machines, providing the machine specifications remain unchanged. It is sufficient to directly set the user constants for subsequent machines. The **machine rigidity** can be selected from one of seven levels.

- NOTE**
- Conduct autotuning with the motor attached to the machine. Make sure that the machine is ready for operation and take sufficient safety precautions when operating the machine.
 - Make sure that the $\overline{P-CON}$ signal is OFF (PI control is selected) before starting autotuning.
 - Before conducting autotuning, make sure that setting of user constant Cn-10 is 500 (factory setting).
 - Make sure that the speed control mode is set to PI control before starting autotuning. If the mode switch is used, PI control automatically switches to P control above a set operating level (PI control to P control switching level), even if the $\overline{P-CON}$ signal is OFF. If the mode switch is used, follow operation a) or operation b) below before starting autotuning.
 - a) Set the user constants to disable the mode switch.
Speed control: Set both Cn-01 Bit C and Bit D to 1.
Position control: Set both Cn-01 Bit B to 1.
 - b) Increase the operating level, such that P control is not selected.
In practice, set the operating level as shown in the table below.

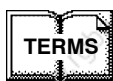
**Machine Rigidity**

The machine rigidity is one of the machine characteristics related to servo control. Set the servo to high response for a machine, such as a machine tool, with high rigidity, and to low response for a machine, such as a robot, with low rigidity.

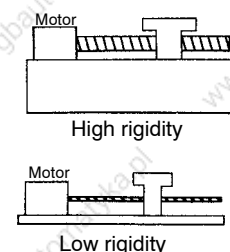

USING THE DIGITAL OPERATOR

4.2.3 Autotuning cont.

Operating Level	User Constant Setting
Torque reference	Cn-0C to maximum torque
Speed reference	Cn-0D to a preset value exceeding Cn-10
Acceleration	Cn-0E to the maximum value: 3000
Error pulse	Cn-0F to the maximum value: 10000

Select the operating level using Bit C and Bit D of Cn-01.

Refer to 3.6.6 *using mode switch* for details of the mode switch function.

4) Using Autotuning

Follow the procedure below to run autotuning.

- 1) Press  to select the user constant setting mode.

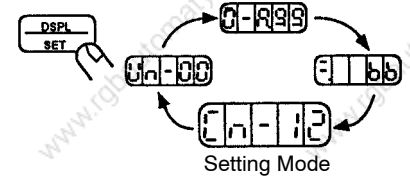

- 2) Select the user constant number Cn-00. (User constant Cn-00 is selected when the power is turned ON.)

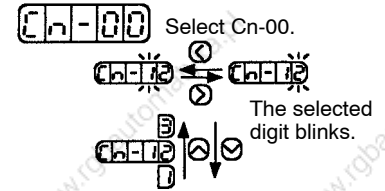

Press the  and  keys to select the digit.

Press the  and  keys to change the value.

- 3) Press  to display the current data for the user constant Cn-00.

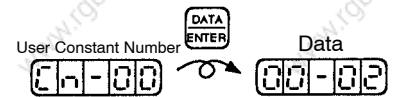

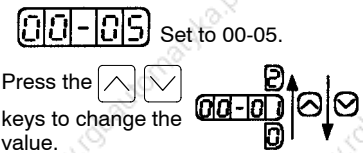

- 4) Press the  and  keys to change the data to 05.

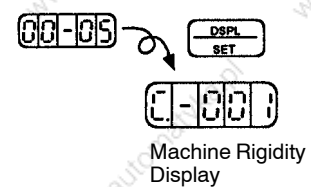

- 5) Press  to display the machine rigidity.



- 6) Press the  and  keys to select the machine rigidity. If the actual rigidity is unknown, select medium rigidity.

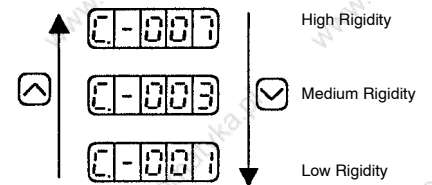

- 7) Press  to select autotuning mode.

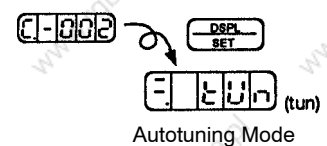

8) Press  to set the servo ON status.

Select Servo ON/Servo OFF

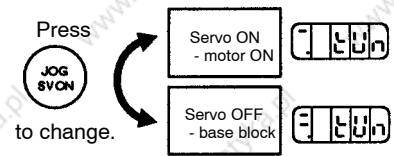

9) Press the  and  keys to operate the motor.

Motor Forward/Reverse Rotation

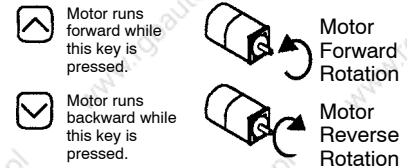

10) When autotuning is complete, the END message is displayed, as shown to the right. Servo OFF status is automatically selected. If Servo ON/Servo OFF is selected by a signal from an external contact, turn this signal OFF.

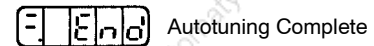

11) Release the  and  keys to revert to the  display.



12) Press  to return to the setting mode display. This ends the autotuning operation.

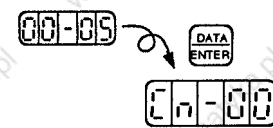



Setting Mode Display

- Refer to sub-section 3) on page 192 for the precautions relating to autotuning.

5) Precautions Relating to Autotuning

a) Speed Setting During Autotuning

The motor speed during autotuning is set by user constant Cn-10. Set to 500 r/min., which is the factory setting. Autotuning may be unsuccessful if this value is set too low.

The motor runs intermittently while the  or  key is held down. The motor does not rotate continuously.

b) Machine Rigidity Selection



Select the machine rigidity as described below. If the actual rigidity is unknown, select medium rigidity.

 High Rigidity

 Medium Rigidity

 Low Rigidity

- If the Machine Resonates

At servo ON when the  key is pressed or when the motor is operated by pressing the  or  key, machine resonance indicates an inappropriate machine rigidity setting. Follow the procedure below to correct the machine rigidity setting, and run autotuning once more.

(1) Press the  key to cancel autotuning.

(2) Press the  key once more to enter the machine rigidity setting mode. Reduce the setting by one.

- If Autotuning Does Not End

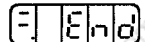
Failure of autotuning to end , is caused by an inappropriate machine rigidity setting. Follow the procedure below to correct the machine rigidity setting, and run autotuning once more.

(1) Press the  key to cancel autotuning.

(2) Press the  key once more to enter the machine rigidity setting mode. Increase the setting by one.

Autotuning may not end for machines with large play or extremely low rigidity. In these cases, use conventional manual adjustment.

4.2.3 Autotuning cont.

c) Input Signals

- The OT signal and SEN signal (absolute encoder only) are enabled during autotuning. Input the OT signal and SEN signal (absolute encoder only) during autotuning. To conduct autotuning without inputting these signals, set user constant Cn-01 Bits 1, 2, and 3 to 1.
- Autotuning is not possible during overtravel (P-OT or N-OT signal OFF).

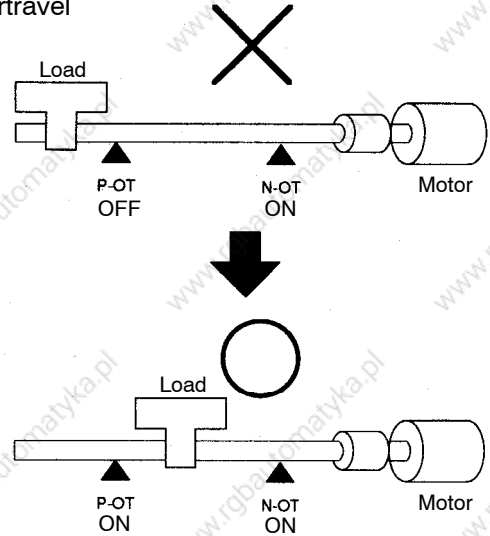

- Conduct autotuning when no overtravel has occurred (both P-OT and N-OT signal ON).

- Set the P-CON signal OFF during autotuning.
- If the mode switch is used, take one of the steps below before running autotuning.
 - (1) Cancel the mode switch.
 - (2) Set the mode switch operating level to a high level.

Refer to page 122 for details about setting the mode switch.

- If using the $\overline{S-ON}$ signal to set the servo ON status, display $\boxed{-} \boxed{E} \boxed{n} \boxed{0}$ before turning ON the $\overline{S-ON}$ signal.

4.2.4 Reference Offset Automatic Adjustment



1) Why Does Reference Offset Occur?

Using a speed/torque control, the motor may rotate slowly when the reference voltage is intended to be 0 V.

This occurs when the host controller or external circuit has a small offset (measured in mV) in the reference voltage.



Automatic Adjustment of Reference Voltage

The reference offset automatic adjustment mode automatically measures the offset and adjusts the reference voltage. It adjusts both speed and torque references.

The following diagram illustrates automatic adjustment of an offset in the reference voltage from the host controller or external circuit.

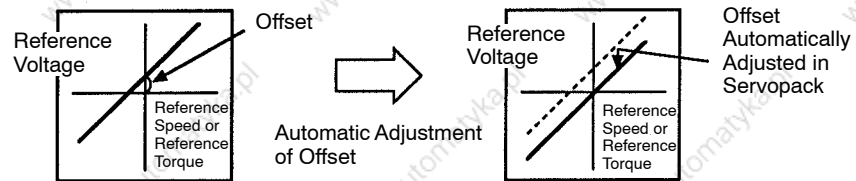

2) After completion of offset automatic adjustment, the amount of offset is stored in the Servopack.

The amount of offset can be checked in the speed reference offset manual adjustment mode. Refer to sub-section 4.2.5 for details.

3) Using the Reference Offset Automatic Adjustment Mode

Follow the procedure below to automatically adjust the reference offset.

- 1) Follow the procedure below to set the motor into operating mode.

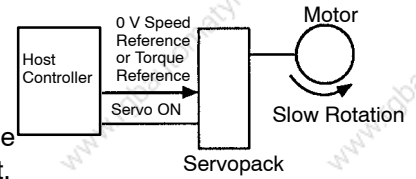

- (1) Input the (intended) 0 V reference voltage from the host controller or external circuit.

- (2) Then, turn ON the servo ON (1CN-40, S-ON) signal.

- 2) Press to select the user constant setting mode.

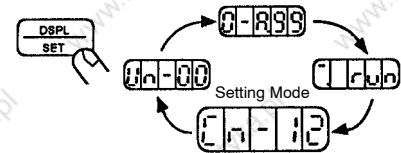

- 3) Select the user constant number Cn-00. (User constant Cn-00 is selected when the power is turned ON.)

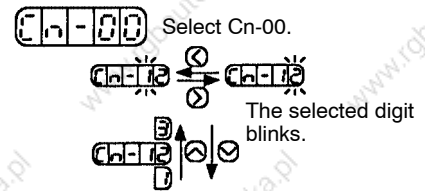

Press the and keys to select the digit.

Press the and keys to change the value.

- 4) Press to display the current data for the user constant Cn-00.

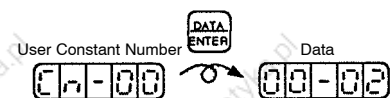

- 5) Press the and keys to change the data to 01.



Press the keys to change the value.

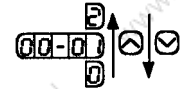

- 6) Press to automatically adjust the reference offset. The motor rotation stops.

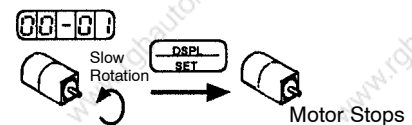

- 7) Press to return to the setting mode display. This ends reference offset automatic adjustment.

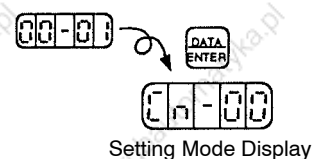

4

- 4) **The reference offset automatic adjustment mode cannot be used** where a position loop is formed with the host controller and the error pulses are zeroed when servo lock is stopped.

In this case, use the speed reference offset manual adjustment mode. Refer to sub-section 4.2.5 for details.

Zero-clamp speed control is available to force the motor to stop during zero speed reference. Refer to sub-section 3.4.3 for details.

4.2.5 Speed Reference Offset Manual Adjustment Mode



- 1) Speed reference offset manual adjustment is available for the speed/torque control. It is very convenient in the following situations:

- If a position loop is formed with the host controller and the error pulses are zeroed when servo lock is stopped.
- To deliberately set the offset to some value.

This mode can also be used to check the data set in the reference offset automatic adjustment mode.

In principle, this mode operates in the same way as the reference offset automatic adjustment mode, except that the amount of offset is directly input during the adjustment. The offset can be set for speed references only.

4.2.5 Speed Reference Offset Manual Adjustment Mode cont.

Offset Adjustment Range and Setting Units are as follows:

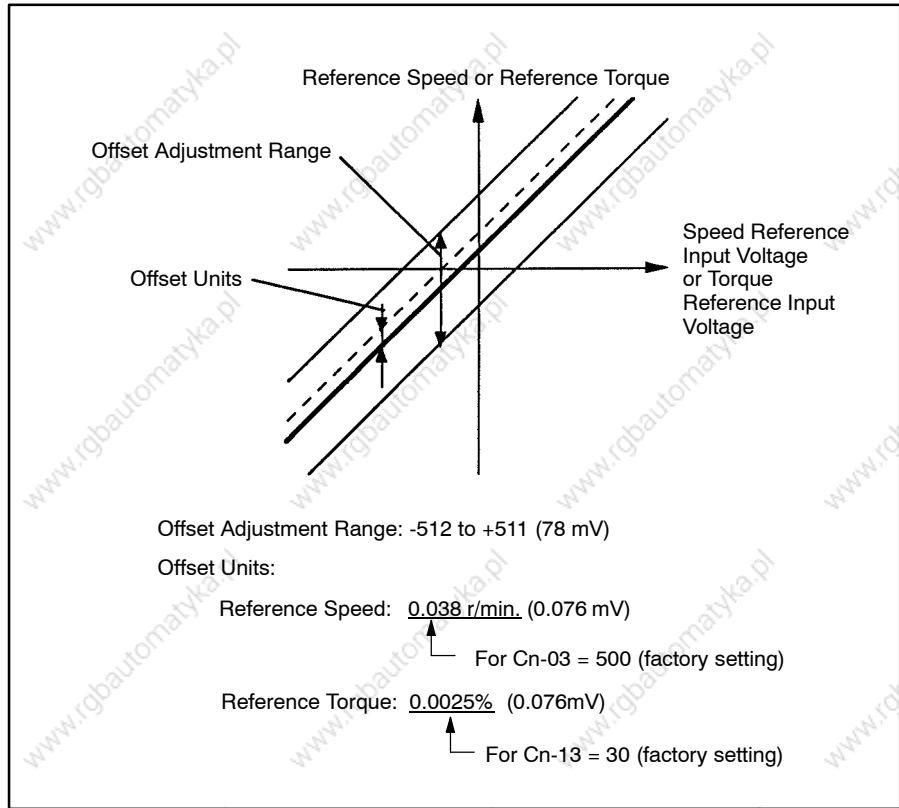

4

2) Follow the procedure below to manually adjust the reference voltage.

1) Press to select the user constant setting mode.

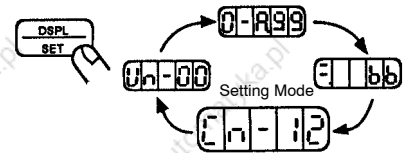

2) Select the user constant number Cn-00. (User constant Cn-00 is selected when the power is turned ON.)

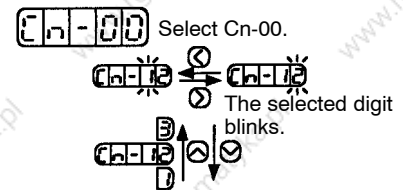

Press the and keys to select the digit.

Press and keys to change the value.

3) Press to display the current data for the user constant Cn-00.





- 4) Press the  and  keys to change the data to 03.



 Set to 00-03.

Press the   keys to change the value. 



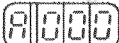



- 5) Press  to select the speed reference offset manual adjustment mode.

(The amount of speed reference offset is displayed.)

 
Speed Reference Offset Manual Adjustment Mode 



- 6) Press the  and  keys to adjust the amount of offset.



(Adjust the speed references.)







- 7) Press  to enter the torque reference offset manual adjustment mode.

(The amount of torque reference offset is displayed.)



 



- 8) Press the  and  keys to adjust the amount of offset.

(Adjust the torque references.)

- 9) Press  to return to the user constant data display.

 

- 10) Press  to return to the setting mode display. This ends the reference offset manual adjustment.



4.2.6 Clearing Alarm Trace-back Data

- 1) This procedure clears the alarm history, which stores the alarms occurring in the Servo-pack. Each alarm in the alarm history is set to A99, which is not an alarm code. Refer to 4.2.1 Operation in Alarm Trace-back Mode for details.
- 2) Follow the procedure below to clear the alarm trace-back data.

- 1) Press  to select the user constant setting mode.

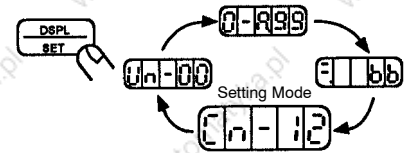

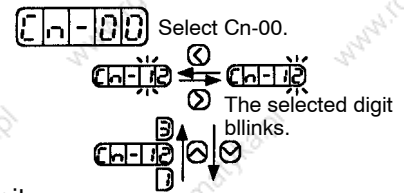
- 2) Select the user constant number Cn-00. (User constant Cn-00 is selected when the power is turned ON.)





Press the  and  keys to select the digit.

Press the  and  keys to change the value.

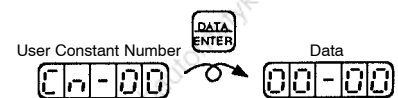
- 3) Press  to display the current data for the user constant Cn-00.



- 4) Press the  and  keys to change the data to 02.

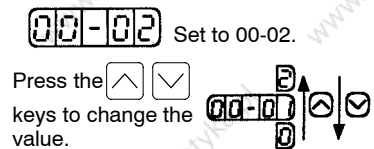

- 5) Press  to clear the alarm trace-back data.



- 6) Press  to return to the user constant data display.

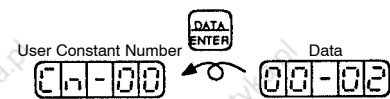

4

4.2.7 Checking Motor Type

- Set Cn-00 to 00-04 to select the motor-type check mode.
This mode is used for maintenance and is not normally used by the customer.

Operation

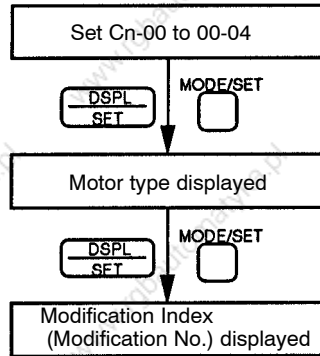

Motor Type Display



Motor Type	Motor Capacity
0: SGM 200V	9E: 30W
1: SGM 100V	b2: 50W
2: SGMP 200V	01: 100W
3: SGMP 100V	02: 200W
	03: 300W
	04: 400W
	08: 750W

Modification Index (Modification No.) Display

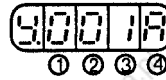

Hexadecimal Display

$$\textcircled{1} \times 16^3 + \textcircled{2} \times 16^2 + \textcircled{3} \times 16 + \textcircled{4} = \text{Modification index (Modification No.)}$$

4.2.8 Checking Software Version

- Set Cn-00 to 00-06 to select the software-version check mode.
This mode is used for maintenance and is not normally used by the customer.

Operation

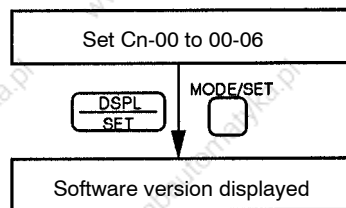

Software Version Display



Software Version

SERVO SELECTION AND DATA SHEETS

This chapter describes how to select Σ -Series servo drives and peripheral devices.

The section also presents the specifications and dimensional drawings required for selection and design.

Choose and carefully read the relevant sections of this chapter.

5.1	Selecting a Σ-Series Servo	205
5.1.1	Selecting a Servomotor	205
5.1.2	Selecting a Servopack	212
5.1.3	Digital Operator	216
5.2	SGM Servomotor	217
5.2.1	Ratings and Specifications	217
5.2.2	Mechanical Characteristics	230
5.3	Servopack Ratings and Specifications	233
5.3.1	Ratings and Specifications	233
5.3.2	Power Consumption	238
5.3.3	Overload Characteristics	239
5.3.4	Starting Time and Stopping Time	240
5.3.5	Load Inertia	241
5.3.6	Overhanging Loads	246
5.4	Σ-Series Dimensional Drawings	247
5.4.1	Servomotor Dimensional Drawings	247
5.4.2	Servomotor Dimensional Drawings (TUV approved, conforming to the machine instructions) ...	289
5.4.3	Servopack Dimensional Drawings	329
5.4.4	Digital Operator Dimensional Drawing	334
5.5	Selecting Peripheral Devices	335
5.5.1	Selecting Peripheral Devices	335
5.5.2	Order List	341

5.6 Specifications and Dimensional Drawings of Peripheral Devices	349
5.6.1 Cable Specifications and Peripheral Devices	349
5.6.2 Motor Cables	355
5.6.3 Connector Kits	358
5.6.4 Brake Power Supply	363
5.6.5 Encoder Cables	365
5.6.6 Battery for Absolute Encoder	371
5.6.7 1CN Connector	371
5.6.8 Circuit Breaker	373
5.6.9 Noise Filter	374
5.6.10 Magnetic Contactor	375
5.6.11 Surge Suppressor	376
5.6.12 Regenerative Unit	376
5.6.13 Variable Resistor for Speed Setting	379
5.6.14 Encoder Signal Converter Unit	379
5.6.15 Cables for Connecting PC and Servopack	381
5.6.16 4CN Connector	385

5.1 Selecting a Σ -Series Servo

This section describes how to select the Σ -Series Servomotor, Servopack, and Digital Operator.

5.1.1	Selecting a Servomotor	205
5.1.2	Selecting a Servopack	212
5.1.3	Digital Operator	216

5.1.1 Selecting a Servomotor

- 1) The selection of an SGM or SGMP Servomotor matched to the servo system in which it is used is based on the servomotor type, that is, the seven alphanumeric characters after "SGM-" or "SGMP-", described below. The numbers (1) to (6) below correspond to the numbers in the flowchart for Servomotor selection on the following pages.

SERVO SELECTION AND DATA SHEETS

5.1.1 Selecting Servomotor cont.

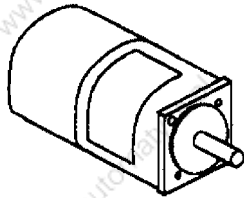

SGM type

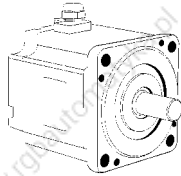

SGMP type

SGM- 01 ^A V 3 1 2 □

Σ-Series

SGM: SGM Servomotor
SGMP: SGMP Servomotor (cube type)

1) Rated output (motor capacity)
(Type SGM only)

A3: 30W (0.04HP) A5: 50W (0.07HP)

(Types SGM and SGMP)

01: 100W (0.13HP) 02: 200W (0.27HP)

03: 300W (0.40HP) 04: 400W (0.53HP)

08: 750W (1.01HP)

2) Supply voltage

A: 200V B: 100V

V: 200V W: 100V

(V and W are EN Standard application)

U: 200V L: 100V

(U and L are UL Standard application)

3) Encoder specification

3: 2048 P/R incremental encoder

W: 12-bit absolute encoder (Available upon special request)

S: 15-bit absolute encoder

4: 2000 P/R incremental encoder

4) Design revision order

5) Shaft specification

2: Straight without key

4: Straight with key

6) Options

B: with brake S: with shaft seal

D: with brake and shaft seal

P: drip-proofed

Flowchart for Servomotor selection

	Selected motor type
Example	SGM- 0 2 B W 1 4 B
Axis 1	SGM- □ □ □ □ □ □
Axis 2	SGM- □ □ □ □ □ □
Axis 3	SGM- □ □ □ □ □ □
Axis 4	SGM- □ □ □ □ □ □
Axis 5	SGM- □ □ □ □ □ □
• • •	• • • • •

- 2) The actual selection of the SGM or SGMP Servomotor is conducted according to the flowchart in the next page.

If an SGMP Servomotor is selected, replace SGM with SGMP. SGMP Servomotors are available from 100W (0.13HP) to 750W (1.01HP). A 1500W (2.01HP) type also exists but the DR2 Servopack can handle up to 750W (1.01HP).

Flowchart for Servomotor Selection

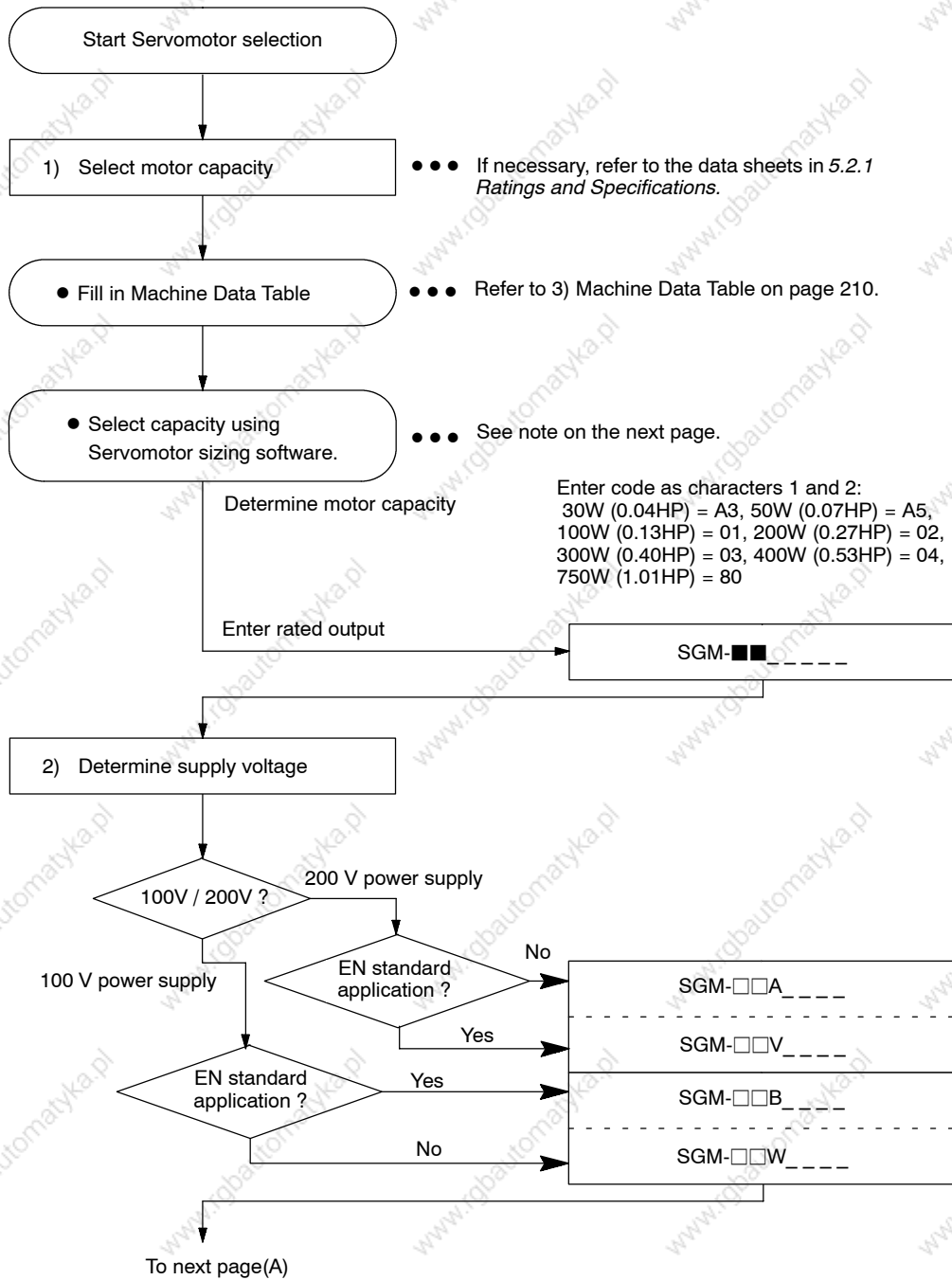

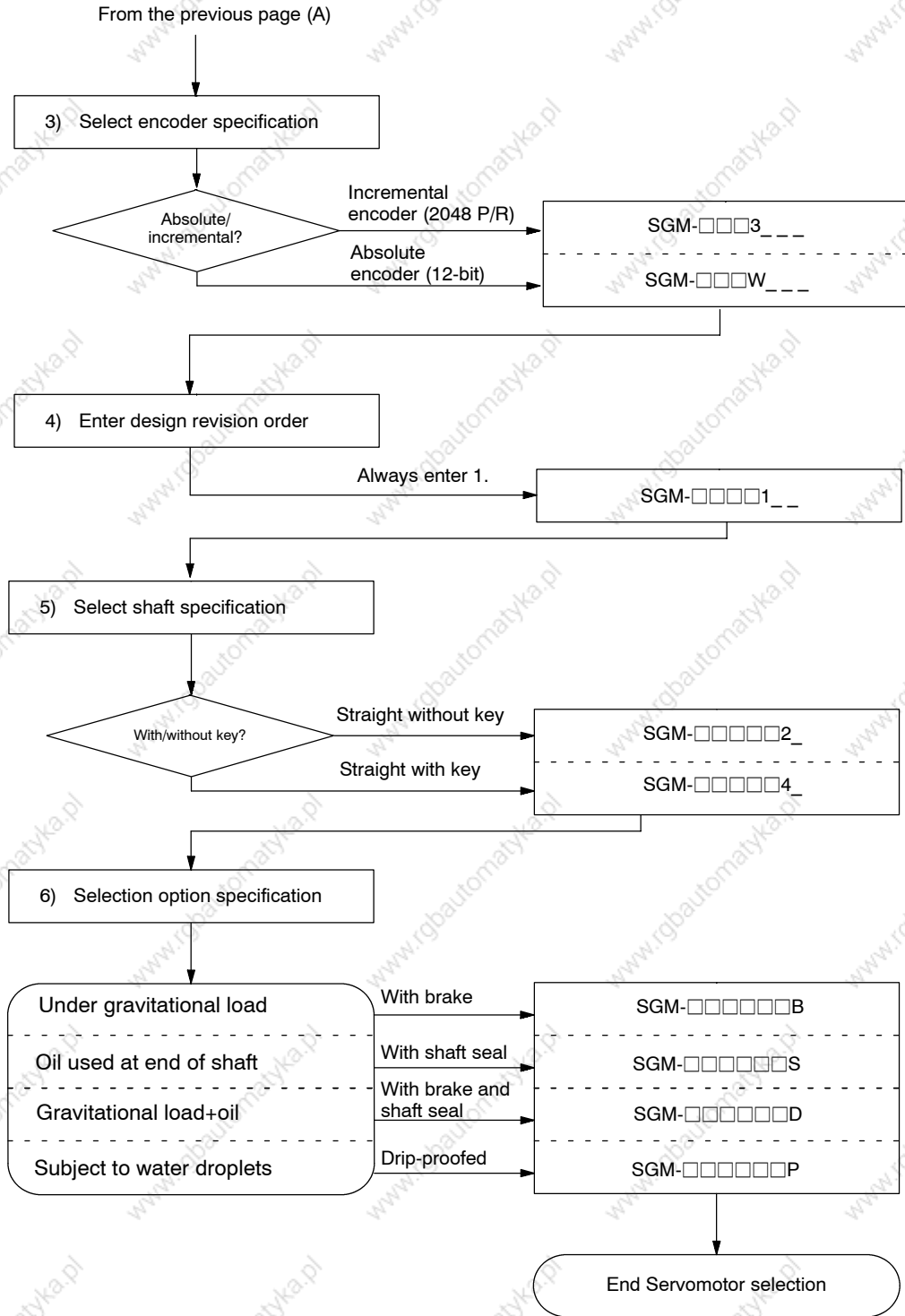

Note Consult Yaskawa sales representative for sizing or sizing software.

5.1.1 Selecting Servomotor cont.

3) Machine Data Table

Fill out the machine data table below as an aid to selecting the drive system. When the machine data table is complete, use the servomotor sizing software to select the motor capacity.

1) Ball Screw Horizontal Axis			
Load mass	W	—kg (lb)	
Thrust	F	—kg (lb)	
Coefficient of friction	μ	—	
Overall efficiency	η	—	
Gear ratio	R (= Nm/NI)	—	
Gear+coupling	GD ² g	—kg·cm ² (lb·in ² .)	
Ball screw pitch	P	—mm (in.)	
Ball screw diameter	D	—mm (in.)	
Ball screw length	L	—mm (in.)	
2) Ball Screw Vertical Axis			
Load mass	W ₁	—kg (lb)	
Counterweight	W ₂	—kg (lb)	
Coefficient of friction	μ	—	
Overall efficiency	η	—	
Gear ratio	R (= Nm/NI)	—	
Gear+coupling	GD ² g	—kg·cm ² (lb·in ² .)	
Ball screw pitch	P	—mm (in.)	
Ball screw diameter	D	—mm (in.)	
Ball screw length	L	—mm (in.)	
3) Timing Belt			
Load mass	W	—kg (lb)	
Thrust	F	—kg (lb)	
Coefficient of friction	μ	—	
Overall efficiency	η	—	
Gear ratio	R (= Nm/NI)	—	
Gear+coupling	GD ² g	—kg·cm ² (lb·in ² .)	
Pulley	GD ² d	—kg·cm ² (lb·in ² .)	
Pulley diameter	D	—mm (in.)	
4) Rack and Pinion			
Load mass	W	—kg (lb)	
Thrust	F	—kg (lb)	
Coefficient of friction	μ	—	
Overall efficiency	η	—	
Gear ratio	R (= Nm/NI)	—	
Gear+coupling	GD ² g	—kg·cm ² (lb·in ² .)	
Pinion diameter	D	—mm (in.)	
Pinion thickness	t	—mm (in.)	

5

5) Roll Feeder			
Load GD^2	$GD^2\ell$	—kg·cm ² (lb·in ² .)	
Tension	F	—kg (lb)	
Press force	P	—kg (lb)	
Roller diameter	D	—mm (in.)	
Coefficient of friction	μ	—	
Overall efficiency	η	—	
Gear ratio	R (= Nm/Nl)	—	
Gear+coupling	GD^2g	—kg·cm ² (lb·in ² .)	
6) Rotor			
Load GD^2	$GD^2\ell$	—kg·cm ² (lb·in ² .)	
Load torque	$T\ell$	—kg·cm ² (lb·in ² .)	
Overall efficiency	η	—	
Gear ratio	R (= Nm/Nl)	—	
Gear+coupling	GD^2g	—kg·cm ² (lb·in ² .)	
7) Others			
Load GD^2	$GD^2\ell$	—kg·cm ² (lb·in ² .)	
Load torque	$T\ell$	—kg·cm ² (lb·in ² .)	
Motor speed	Nm	—r/min	
DUTY	td	—s	
Positioning time	ts	—s	
Accel/decel time	ta	—s	
• Duty cycle			
DUTY	td	—s	
Positioning distance	Ls	—mm (in.)	
Moving member speed	$V\ell$	—m/min	
Positioning time	ts	—s	
Accel/decel time	ta	—s	
Enter either $V\ell$ or t_s . If both are entered, specify priority.			
• Operating environment			
	Operating temperature		
	Other		

5.1.2 Selecting a Servopack

- 1) The selection of a DR2 Servopack matched to the servo system in which it is used is based on the Servopack type, that is, the four to six alphanumeric characters after “DR2-”, described below. The numbers 1) to 5) below correspond to the numbers in the flowchart for Servopack selection on the following pages.

DR2 - 01 A C P - F

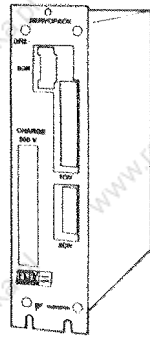

- Σ-Series
DR2: DR2 Servopack
- 1) Rated output
A3: 30W (0.04HP) A5: 50W (0.07HP)
01: 100W (0.13HP) 02: 200W (0.27HP)
03: 300W (0.40HP) 04: 400W (0.53HP)
08: 750W (1.01HP)
 - 2) Supply voltage
A: 200V B: 100V
 - 3) Model
C: Speed/torque/position control
 - 4) Factory setting of applicable motor type*
Blank: SGM Servomotor
P: SGMP Servomotor
 - 5) Option
Blank: Semi-closed loop specifications (standard)
F: Full-closed loop specifications

Flowchart for Servopack selection

	Selected Servopack type
Example	DR2 - {0}{2}{B}{S} - { }
Axis 1	DR2-□□□□□-□
Axis 2	DR2-□□□□□-□
Axis 3	DR2-□□□□□-□
Axis 4	DR2-□□□□□-□
Axis 5	DR2-□□□□□-□
• • •	• • • • •

* The applicable motor type (SGM/SGMP) can be changed by setting the user constants.

2) The actual selection of the DR2 Servopack is conducted according to the following flow-chart.

Flowchart for Servopack Selection

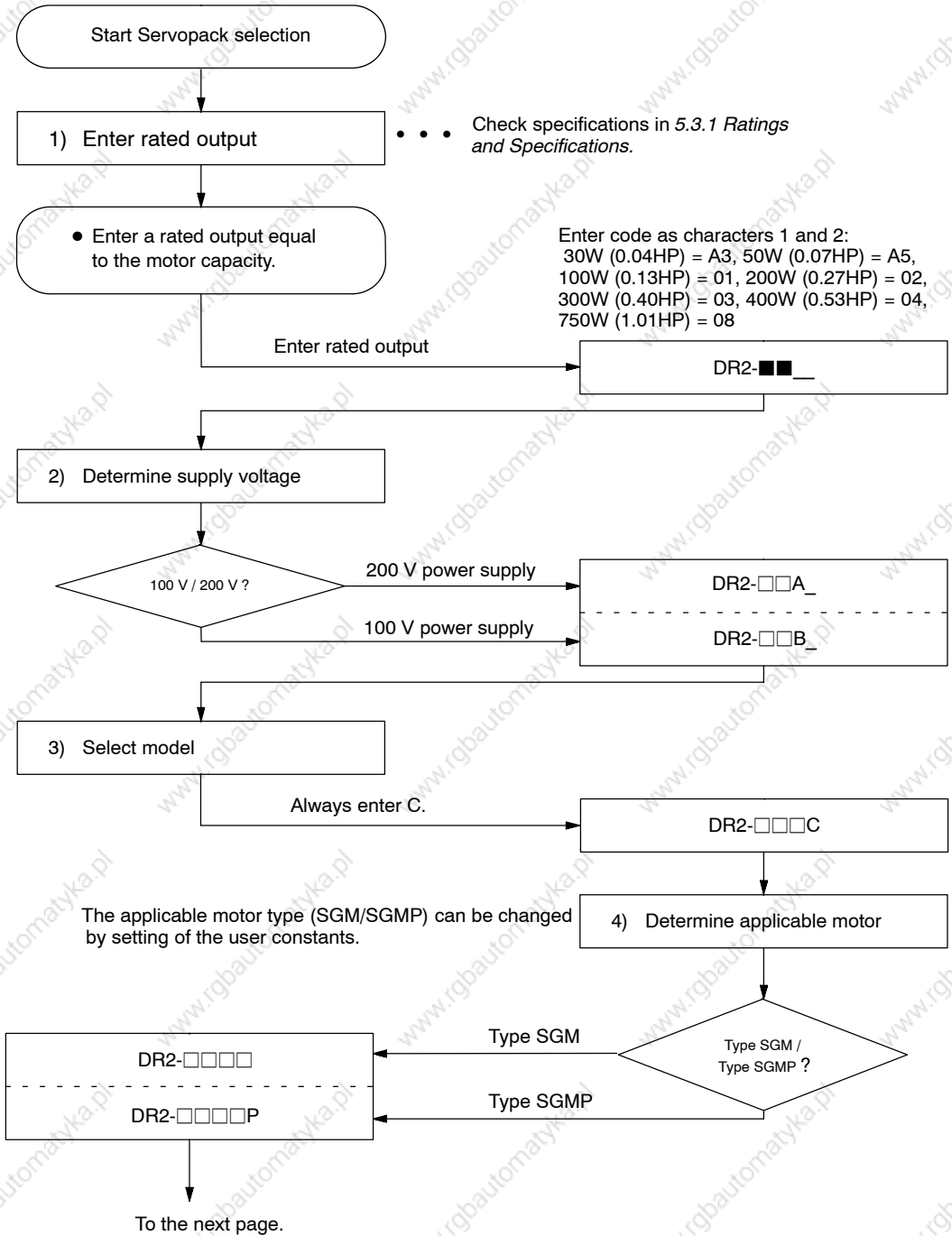

5

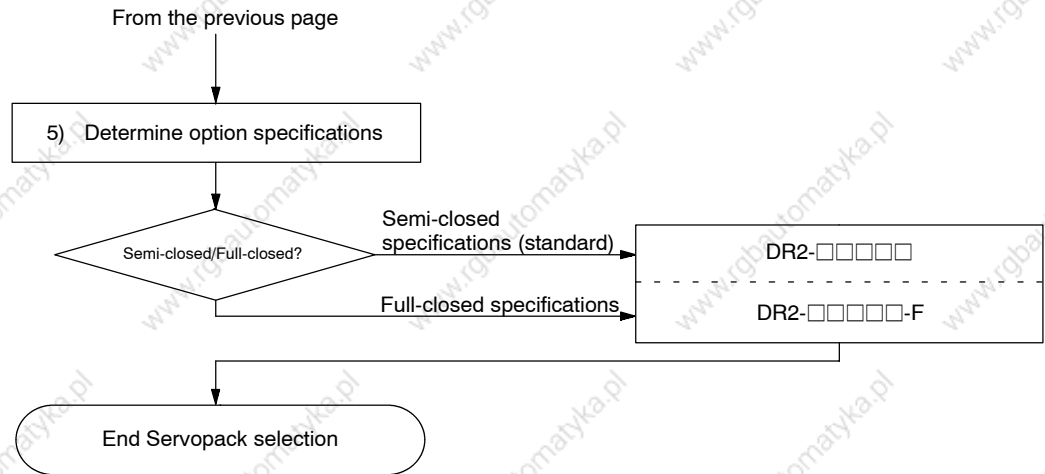

5.1.3 Digital Operator

1) Use the following digital operator (hand-held type) for operation.

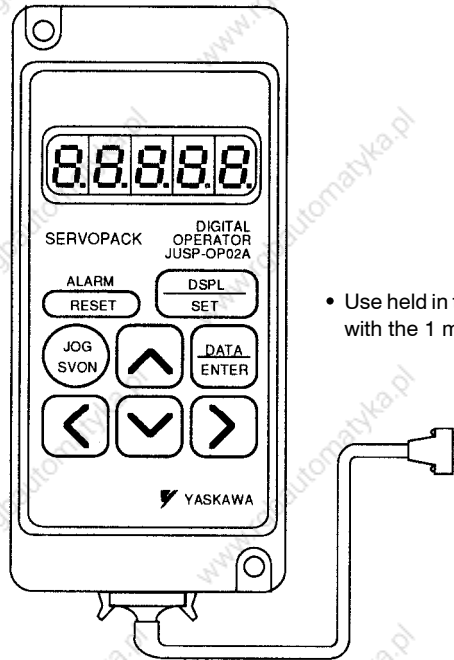

- Use held in the hand while connected with the 1 m cable supplied.

JUSP-OP02A-1 (Hand-held Type)

Note Mount type digital operator (JUSP-OP03A) cannot be used for DR2 Servopack.

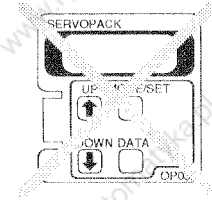

JUSP-OP03A (Mount Type)



Instead of digital operator, also personal computer (IBM PC) can be used to monitor or set the user constants. For details, refer to the manual "Operation Manual for Personal Computer Monitoring Software" (Manual No. SIE-S800-15.5).

5.2 SGM Servomotor

This section presents tables of ratings and specifications for SGM and SGMP Servomotors. Refer to these tables when selecting a Servomotor.

5.2.1	Ratings and Specifications	217
5.2.2	Mechanical Characteristics	230

5.2.1 Ratings and Specifications

- 1) The ratings and specifications of SGM and SGMP Servomotors are shown below. Refer to them as required when selecting a Servomotor.
- 2) Ratings and Specifications of 200-VAC SGM Servomotors

Time rating:	continuous
Heat resistance class:	Class B (Class A for UL spec. type SGM-□U)
Vibration class:	15 μ m or below
Withstand voltage:	1500 VAC
Insulation resistance:	500 VDC 10M Ω min.
Enclosure:	totally enclosed, self-cooled
Ambient temperature:	0 to 40°C
Ambient humidity:	20% to 80% (non-condensing)
Excitation:	permanent magnet
Drive method:	direct drive
Mounting:	flange method

SERVO SELECTION AND DATA SHEETS

5.2.1 Ratings and Specifications cont.

SGM Servomotor		A3A A3V	A5A A5V	01A 01V	02A 02V	04A 04V	08A 08V
Rated Output*1	W (HP)	30 (0.04)	50 (0.07)	100 (0.13)	200 (0.27)	400 (0.53)	750 (1.01)
Rated Torque*1 *2	N·m	0.095	0.159	0.318	0.637	1.27	2.39
	(oz·in)	(13.5)	(22.6)	(45.1)	(90.1)	(181)	(338)
Instantaneous Peak Torque*1	N·m	0.29	0.48	0.96	1.91	3.82	7.1
	(oz·in)	(40.5)	(67.7)	(135)	(270)	(542)	(1010)
Rated Current*1	A (rms)	0.42	0.6	0.87	2.0	2.6	4.4
Instantaneous Max Current*1	A (rms)	1.3	1.9	2.8	6.0	8.0	13.9
Rated Speed*1	r/min	3000					
Instantaneous Max Speed*1	r/min	4500					
Torque Constant*1	N·m/A (rms)	0.255	0.286	0.408	0.355	0.533	0.590
	(oz·in/A) (rms)	(36.2)	(40.5)	(57.8)	(50.2)	(75.5)	(83.5)
Moment of Inertia [J _M]	kg·m ² × 10 ⁻⁴	0.021	0.026	0.040	0.123	0.191	0.671
	(oz·in·s ² × 10 ⁻³)	(0.288)	(0.368)	(0.576)	(1.74)	(2.70)	(9.52)
Rated Power Rate*1	kW/s	4.36	9.63	25.4	32.8	84.6	85.1
Rated Angular Acceleration*1	rad/s ²	45200	61200	79500	51800	666000	35600
Inertia Time Constant	ms	1.5	0.9	0.5	0.4	0.3	0.3
Inductive Time Constant	ms	1.5	1.8	1.9	5.4	6.4	13

*1 These items and torque-motor speed characteristics quoted in combination with a DR2 Servopack at an armature winding temperature of 100°C. Other values quoted at 20°C. All values typical at power voltage 200V.

*2 Rated torques are continuous allowable torque values at 40°C with a 250 x 250 x 6 (mm) (9.84 x 9.84 x 0.24 (in.)) heat sink attached.

NOTE The ratings and specifications above refer to a standard Servomotor.

Add the numerical values below to the moment of inertia values in the table for a motor fitted with **a holding brake** and/or a 12-bit absolute encoder.

Other specifications will also change slightly.



Holding Brake

The holding brake is automatically applied to the motor shaft to prevent the load falling in vertical axis applications when the motor power supply is turned off or fails. It is only to hold the load and cannot be used for stopping motor.

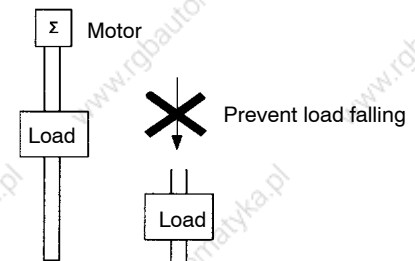

Item	Type	SGM-					
		A3A A3V	A5A A5V	01A 01V	02A 02V	04A 04V	08A 08V
Holding brake	$\text{kg}\cdot\text{m}^2 \times 10^{-4}$	0.0085			0.058		0.14
	$(\text{oz}\cdot\text{in}\cdot\text{s}^2 \times 10^{-3})$	(0.120)			(0.816)		(1.98)
12-bit absolute encoder	$\text{kg}\cdot\text{m}^2 \times 10^{-4}$	0.025					
	$(\text{oz}\cdot\text{in}\cdot\text{s}^2 \times 10^{-3})$	(0.352)					

Electrical Specifications of the Holding Brake

a) SGM Type (Rated Voltage: 90 VDC) . . Standard

Motor Model	Motor Capacity (W)	Holding Brake Specifications			
		Capacity (W)	Holding Torque (kg-cm)	Coil Resistance (Ω at 20°C)	Rated Current (A at 20°C)
SGM-A3□□□□	30	6	2.0	1350	0.067
SGM-A5□□□□	50	6	2.0	1350	0.067
SGM-01□□□□	100	6	3.5	1350	0.067
SGM-02□□□□	200	6.5	15	1246	0.072
SGM-04□□□□	400	6.5	15	1246	0.072
SGM-08□□□□	750	6	25	1350	0.067

b) SGM Type (Rated Voltage: 24 VDC) . . Semi-standard

Motor Model	Motor Capacity (W)	Holding Brake Specifications			
		Capacity (W)	Holding Torque (kg-cm)	Coil Resistance (Ω at 20°C)	Rated Current (A at 20°C)
SGM-A3□□□□	30	6	2.0	96	0.25
SGM-A5□□□□	50	6	2.0	96	0.25
SGM-01□□□□	100	6	3.5	96	0.25
SGM-02□□□□	200	6.5	15	89	0.27
SGM-04□□□□	400	6.5	15	89	0.27
SGM-08□□□□	750	6	25	96	0.25

3) 200-VAC SGM Servomotor Torque-Motor Speed Characteristics

• SGM-A3A (V)

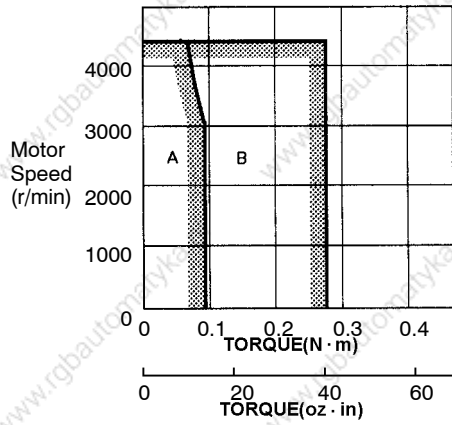

• SGM-A5A (V)

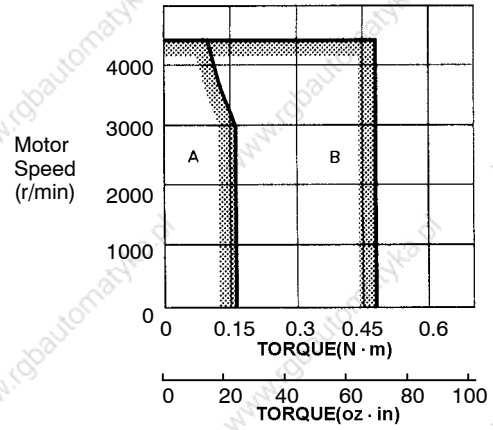

• SGM-01A (V)

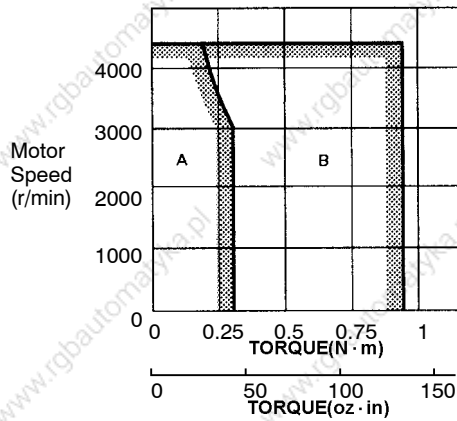

• SGM-02A (V)

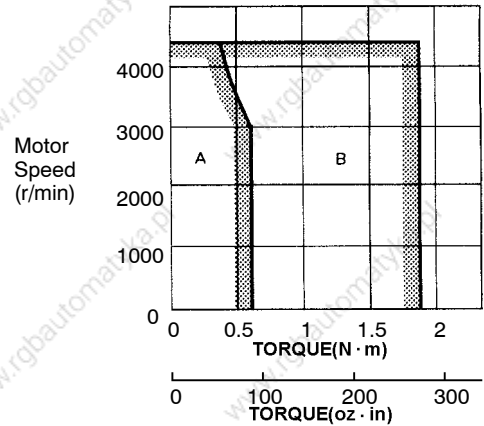

• SGM-04A (V)

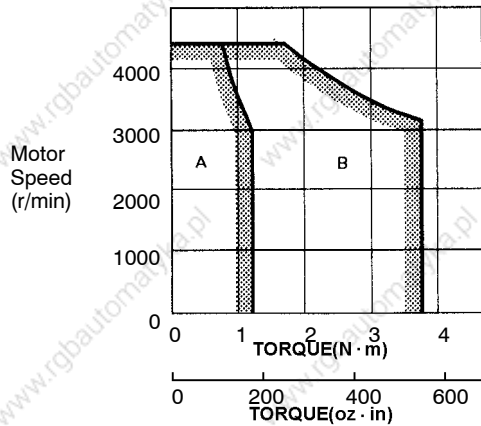

• SGM-08A (V)

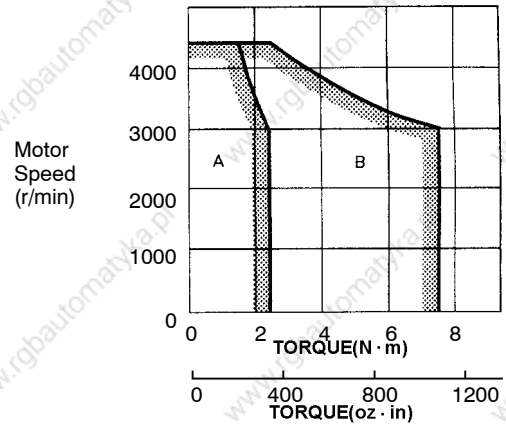

A: Continuous Duty Zone
B: Intermittent Duty Zone

5

4) Ratings and Specifications of 200-VAC SGMP Servomotors

Time rating:	continuous
Heat resistance class:	Class B (Class A for UL spec. type SGMP-□U)
Vibration class:	15 μ m or below
Withstand voltage:	1500 VAC
Insulation resistance:	500 VDC 10M Ω min.
Enclosure:	totally enclosed, self-cooled
Ambient temperature:	0 to 40°C
Ambient humidity:	20% to 80% (non-condensing)
Excitation:	permanent magnet
Drive method:	direct drive
Mounting:	flange method

SGMP Servomotor		01A 01V	02A 02V	04A 04V	08A 08V	
Rated Output *1	W (HP)	100 (0.13)	200 (0.27)	400 (0.54)	750 (1.01)	
Rated Torque *1 *2	N.m	0.318	0.637	1.27	2.39	
	(oz.in)	(45.1)	(90.1)	(181)	(338)	
Instantaneous Peak Torque *1	N.m	0.96	1.91	3.82	7.1	
	(oz.in)	(135)	(270)	(542)	(1010)	
Rated Current *1	A (rms)	0.89	2.0	2.6	4.1	
Instantaneous Peak Current *1	A (rms)	2.8	6.0	8.0	13.9	
Rated Rotation Speed *1	r/min	3000				
Max. Rotation Speed *1	r/min	4500				
Torque Constant *1	N.m/A (rms)	0.392	0.349	0.535	0.641	
	oz.in/A (rms)	55.5	49.4	75.8	91.0	
Moment of Inertia	Incremental encoder, no holding brake	(=GD ² _{M/4}) kg·m ² × 10 ⁻⁴	0.065	0.209	0.347	2.11
		(oz.in·s ² × 10 ⁻³)	(0.917)	(2.96)	(4.92)	(29.9)
	Incremental encoder, with holding brake	(=GD ² _{M/4}) kg·m ² × 10 ⁻⁴	0.103	0.307	0.445	2.52
		(oz.in·s ² × 10 ⁻³)	(1.46)	(4.35)	(6.31)	(35.7)
	Absolute encoder, no holding brake	(=GD ² _{M/4}) kg·m ² × 10 ⁻⁴	0.090	0.234	0.372	2.14
		(oz.in·s ² × 10 ⁻³)	(1.27)	(3.31)	(5.27)	(30.3)
	Absolute encoder, with holding brake	(=GD ² _{M/4}) kg·m ² × 10 ⁻⁴	0.128	0.332	0.470	2.55
		(oz.in·s ² × 10 ⁻³)	(1.81)	(4.70)	(6.66)	(36.1)
Rated Power Rate *1	kW/s	15.7	19.4	46.8	26.9	
Rated Angular Acceleration *1	rad/s ²	49200	30500	36700	11300	
Inertia Time Constant	ms	0.7	0.6	0.4	0.7	
Inductive Time Constant	ms	3.7	7.4	8.5	18	

*1 These items and torque-motor speed characteristics quoted in combination with a DR2 Servopack at an armature winding temperature of 100°C. Other values quoted at 20°C. All values typical at power voltage 200V.

SERVO SELECTION AND DATA SHEETS

5.2.1 Ratings and Specifications cont.

- *2 Rated torques are continuous allowable torque values at 40°C with an attached heat sink as specified below.

Heat sink dimensions 01A, 02A, 04A . 250×250×6(mm), (9.84×9.84×0.24 (in.))
 08A 300×300×12(mm),(11.81×11.81×0.47(in.))

Electrical Specifications of the Holding Brake

- a) SGMP Type (Rated Voltage: 90 VDC) Standard

Motor Model	Motor Capacity (W)	Holding Brake Specifications			
		Capacity (W)	Holding Torque (kg-cm)	Coil Resistance (Ω at 20°C)	Rated Current (A at 20°C)
SGMP-01□□□□	100	6	5.0	1555	0.062
SGMP-02□□□□	200	5	10	1573	0.056
SGMP-04□□□□	400	7.6	20	1062	0.085
SGMP-08□□□□	750	7.5	37	1083	0.083

- b) SGMP Type (Rated Voltage: 24 VDC) Semi-standard

Motor Model	Motor Capacity (W)	Holding Brake Specifications			
		Capacity (W)	Holding Torque (kg-cm)	Coil Resistance (Ω at 20°C)	Rated Current (A at 20°C)
SGMP-01□□□□	100	6	5.0	114	0.23
SGMP-02□□□□	200	5	10	116	0.21
SGMP-04□□□□	400	7.6	20	89	0.29
SGMP-08□□□□	750	7.5	37	77	0.31

5

5) 200-VAC SGM Servomotor Torque-Motor Speed Characteristics

• SGMP-01A (V)

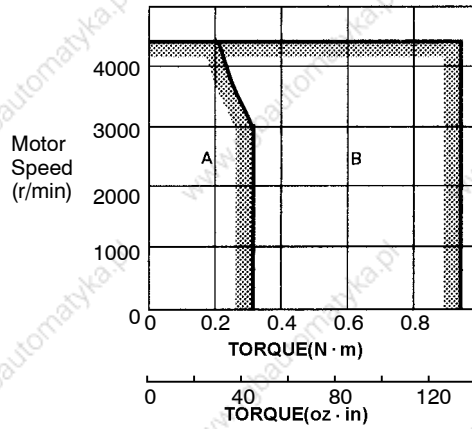

• SGMP-02A (V)

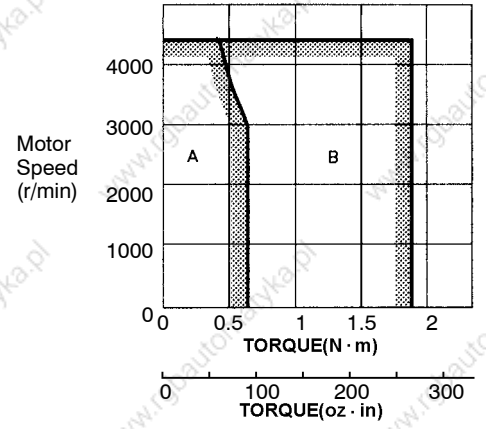

• SGMP-04A (V)

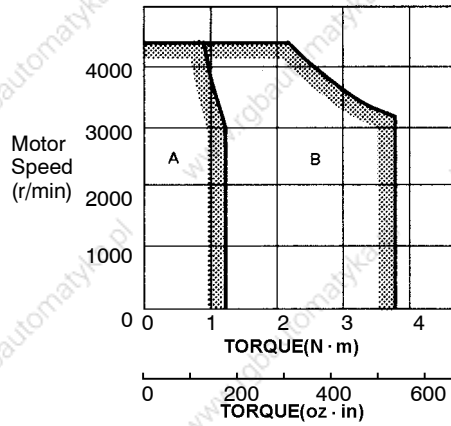

• SGMP-08A (V)

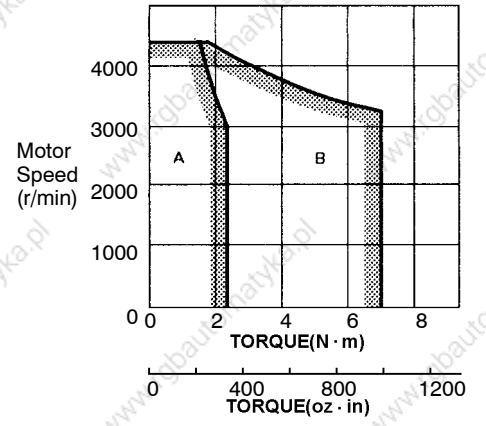

A: Continuous Duty Zone
 B: Intermittent Duty Zone

SERVO SELECTION AND DATA SHEETS

5.2.1 Ratings and Specifications cont.

6) Ratings and Specifications of 100-VAC SGM Servomotors

Time rating:	continuous
Heat resistance class:	Class B (Class A for UL spec. type SGM-□U)
Vibration class:	15 μ m or below
Withstand voltage:	1500 VAC
Insulation resistance:	500 VDC 10M Ω min.
Enclosure:	totally enclosed, self-cooled
Ambient temperature:	0 to 40°C
Ambient humidity:	20% to 80% (non-condensing)
Excitation:	permanent magnet
Drive method:	direct drive
Mounting:	flange method

SGM Servomotor		A3B A3W	A5B A5W	01B 01W	02B 02W	03B 03W
Rated Output *1	W (HP)	30 (0.04)	50 (0.07)	100 (0.13)	200 (0.27)	300 (0.40)
Rated Torque *1 *2	N·m	0.095	0.159	0.318	0.637	0.95
	(oz·in)	(13.5)	(22.6)	(45.1)	(90.1)	(135.0)
Instantaneous Peak Torque *1	N·m	0.29	0.48	0.96	1.91	3.72
	(oz·in)	(40.5)	(67.7)	(135)	(270)	(527.7)
Rated Current *1	A (rms)	0.63	0.9	2.2	2.7	3.7
Instantaneous Peak Current *1	A (rms)	2.0	2.9	7.1	8.4	14.8
Rated Rotation Speed *1	r/min	3000				
Max. Rotation Speed *1	r/min	4500				
Torque Constant *1	N·m/A (rms)	0.168	0.194	0.156	0.255	0.279
	oz·in/A (rms)	(23.8)	(27.5)	(22.1)	(36.1)	(39.6)
Moment of Inertia	(=GD ² _M /4) kg·m ² × 10 ⁻⁴	0.021	0.026	0.040	0.123	0.191
	(oz·in·s ² × 10 ⁻³)	(0.288)	(0.368)	(0.576)	(1.74)	(2.71)
Rated Power Rating *1	kW/s	4.36	9.63	25.4	32.8	47.3
Rated Angular Acceleration *1	rad/s ²	45200	61200	79500	51800	49700
Inertia Time Constant	ms	1.6	0.9	0.6	0.4	0.3
Inductive Time Constant	ms	1.3	1.6	1.6	5.7	5.3

*1 These items and torque-motor speed characteristics quoted in combination with a DR2 Servopack at an armature winding temperature of 100°C. Other values quoted at 20°C. All values typical at power voltage 100V.

*2 Rated torques are continuous allowable torque values at 40°C with a 250 x 250 x 6 (mm) (9.84 x 9.84 x 0.24 (in.)) heat sink attached.

NOTE The ratings and specifications above refer to a standard Servomotor.

Add the numerical values below to the moment of inertia values in the table for a motor fitted with a holding brake and/or a 12-bit absolute encoder.

Other specifications will also change slightly.

Item	Type	SGM-				
		A3B	A5B	01B	02B	03B
Holding brake	$\text{kg}\cdot\text{m}^2 \times 10^{-4}$	0.0085			0.058	
	$(\text{oz}\cdot\text{in}\cdot\text{s}^2 \times 10^{-3})$	0.12			0.82	
12-bit absolute encoder	$\text{kg}\cdot\text{m}^2 \times 10^{-4}$	0.025				
	$(\text{oz}\cdot\text{in}\cdot\text{s}^2 \times 10^{-3})$	0.36				

Electrical Specifications of the Holding Brake

a) SGM Type (Rated Voltage: 90 VDC) . . Standard

Motor Model	Motor Capacity (W)	Holding Brake Specifications			
		Capacity (W)	Holding Torque (kg-cm)	Coil Resistance (Ω at 20°C)	Rated Current (A at 20°C)
SGM-A3□□□□	30	6	2.0	1350	0.067
SGM-A5□□□□	50	6	2.0	1350	0.067
SGM-01□□□□	100	6	3.5	1350	0.067
SGM-02□□□□	200	6.5	15	1246	0.072
SGM-03□□□□	400	6.5	15	1246	0.072

b) SGM Type (Rated Voltage: 24 VDC) . . Semi-standard

Motor Model	Motor Capacity (W)	Holding Brake Specifications			
		Capacity (W)	Holding Torque (kg-cm)	Coil Resistance (Ω at 20°C)	Rated Current (A at 20°C)
SGM-A3□□□□	30	6	2.0	96	0.25
SGM-A5□□□□	50	6	2.0	96	0.25
SGM-01□□□□	100	6	3.5	96	0.25
SGM-02□□□□	200	6.5	15	89	0.27
SGM-03□□□□	400	6.5	15	89	0.27

7) 100-VAC SGM Servomotor Torque-Motor Speed Characteristics

• SGM-A3B (W)

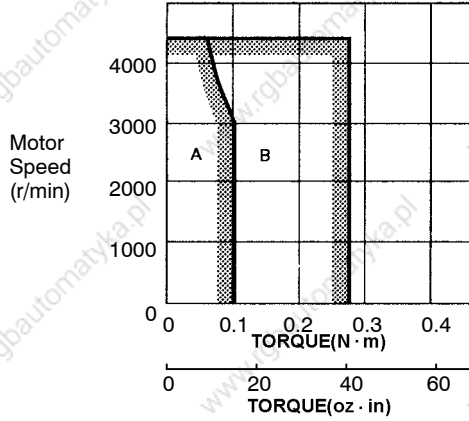

• SGM-A5B (W)

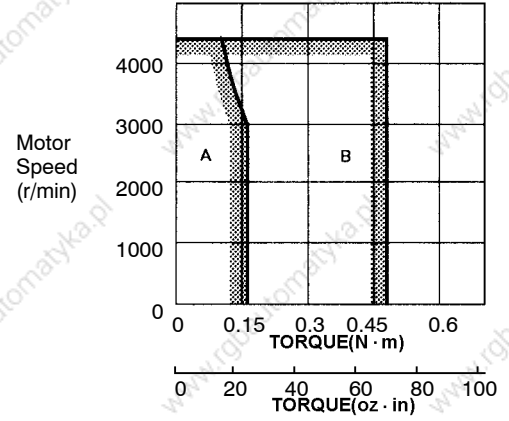

• SGM-01B (W)

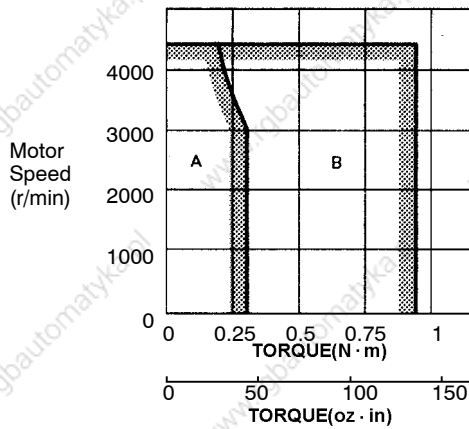

• SGM-02B (W)

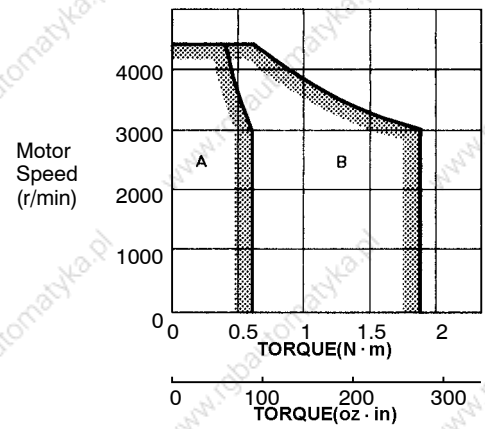

• SGM-03B (W)

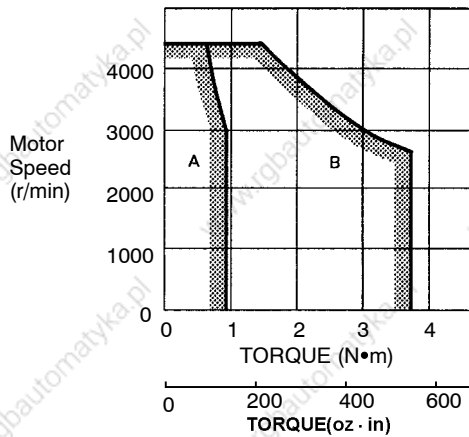

A: Continuous Duty Zone
B: Intermittent Duty Zone

5

8) Ratings and Specifications of 100-VAC SGMP Servomotors

Time rating:	continuous
Heat resistance class:	Class B (Class A for UL spec. type SGMP-□U)
Vibration class:	15 μ m or below
Withstand voltage:	1500 VAC
Insulation resistance:	500 VDC 10M Ω min.
Enclosure:	totally enclosed, self-cooled
Ambient temperature:	0 to 40°C
Ambient humidity:	20% to 80% (non-condensing)
Excitation:	permanent magnet
Drive method:	direct drive
Mounting:	flange method

SGMP Servomotor		01B 01W	02B 02W	03B 03W	
Rated Output* ¹	W (HP)	100 (0.13)	200 (0.27)	300 (0.40)	
Rated Torque* ¹ * ²	N·m	0.318	0.637	0.955	
	(oz·in)	(45.1)	(90.1)	(135)	
Instantaneous Peak Torque* ¹	N·m	0.96	1.91	2.86	
	(oz·in)	(135)	(270)	(406)	
Rated Current* ¹	A (rms)	2.2	2.7	4.3	
Instantaneous Peak Current* ¹	A (rms)	7.1	8.4	13.9	
Rated Rotation Speed* ¹	r/min	3000			
Max. Rotation Speed* ¹	r/min	4500			
Torque Constant* ¹	N·m/A (rms)	0.160	0.258	0.246	
	oz·in/A (rms)	22.8	36.5	34.9	
Moment of Inertia	Incremental encoder, no holding brake	(=GD ² _{M/4}) kg·m ² × 10 ⁻⁴	0.065	0.209	0.347
		(oz·in·s ² × 10 ⁻³)	(0.917)	(2.96)	(4.92)
	Incremental encoder, with holding brake	(=GD ² _{M/4}) kg·m ² × 10 ⁻⁴	0.103	0.307	0.445
		(oz·in·s ² × 10 ⁻³)	(1.46)	(4.35)	(6.31)
	Absolute encoder, no holding brake	(=GD ² _{M/4}) kg·m ² × 10 ⁻⁴	0.090	0.234	0.372
		(oz·in·s ² × 10 ⁻³)	(1.27)	(3.31)	(5.27)
	Absolute encoder, with holding brake	(=GD ² _{M/4}) kg·m ² × 10 ⁻⁴	0.128	0.332	0.470
		(oz·in·s ² × 10 ⁻³)	(1.81)	(4.70)	(6.66)
Rated Power Rate* ¹	kW/s	15.7	19.4	26.3	
Rated Angular Acceleration* ¹	rad/s ²	49200	30500	27500	
Inertia Time Constant	ms	0.8	0.7	0.4	
Inductive Time Constant	ms	3.6	6.3	8.5	

*¹ These items and torque-motor speed characteristics quoted in combination with a DR2 Servopack at an armature winding temperature of 100°C. Other values quoted at 20°C. All values typical at power voltage 100V.

*² Rated torques are continuous allowable torque values at 40°C with a 250 x 250 x 6 (mm) (9.84 x 9.84 x 0.24 (in.)) heat sink attached.

5.2.1 Ratings and Specifications cont.

Electrical Specifications of the Holding Brake

a) SGMP Type (Rated Voltage: 90 VDC) Standard

Motor Model	Motor Capacity (W)	Holding Brake Specifications			
		Capacity (W)	Holding Torque (kg-cm)	Coil Resistance (Ω at 20°C)	Rated Current (A at 20°C)
SGMP-01□□□□	100	6	5.0	1555	0.062
SGMP-02□□□□	200	5	10	1573	0.056
SGMP-04□□□□	400	7.6	20	1062	0.085
SGMP-08□□□□	750	7.5	37	1083	0.083
SGMP-15□□□□	1500	10	73	832	0.11

b) SGMP Type (Rated Voltage: 24 VDC) Semi-standard

Motor Model	Motor Capacity (W)	Holding Brake Specifications			
		Capacity (W)	Holding Torque (kg-cm)	Coil Resistance (Ω at 20°C)	Rated Current (A at 20°C)
SGMP-01□□□□	100	6	5.0	114	0.23
SGMP-02□□□□	200	5	10	116	0.21
SGMP-04□□□□	400	7.6	20	89	0.29
SGMP-08□□□□	750	7.5	37	77	0.31
SGMP-15□□□□	1500	10	73	58	0.42

5

9) 100-VAC SGMP Servomotor Torque-Motor Speed Characteristics

• SGMP-01B (W)

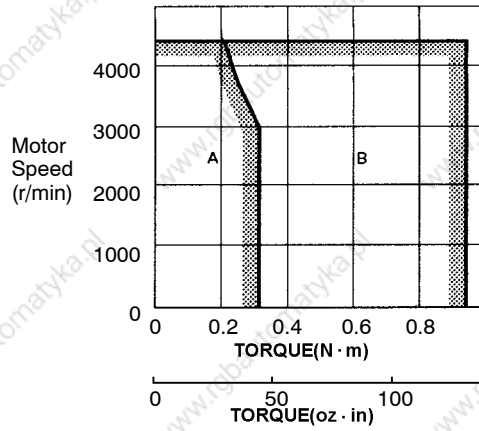

• SGMP-02B (W)

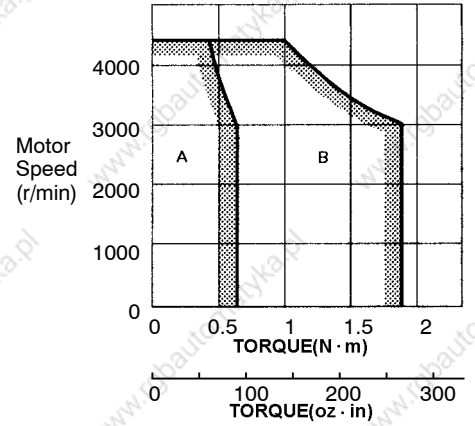

• SGMP-03B (W)

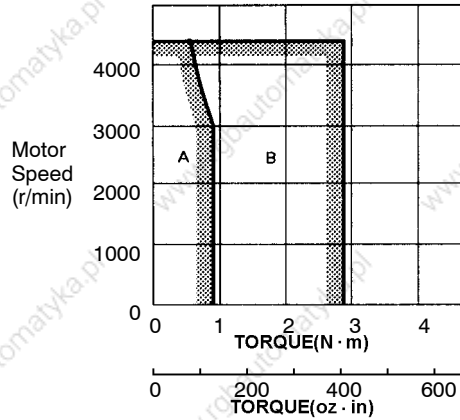

A: Continuous Duty Zone
 B: Intermittent Duty Zone

5.2.2 Mechanical Characteristics

1) Allowable Radial Load, Allowable Thrust Load

The output shaft allowable loads for SGM and SGMP Servomotor are shown below.

Conduct mechanical design such that the thrust loads and radial loads do not exceed the values stated below.

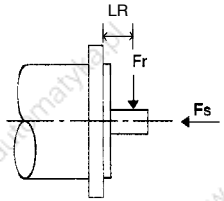
Servomotor Type	Allowable Radial Load Fr [N(lb)]	Allowable Thrust Load Fs [N(lb)]	LR mm (in.)	Reference Diagram
SGM-A3	68 (15)	54 (12)	20 (0.82)	
SGM-A5	68 (15)	54 (12)	20 (0.82)	
SGM-01	78 (17)	54 (12)	20 (0.82)	
SGM-02	245 (55)	74 (16)	25 (1.02)	
SGM-03	245 (55)	74 (16)	25 (1.02)	
SGM-04	245 (55)	74 (16)	25 (1.02)	
SGM-08	392 (88)	147 (33)	35 (1.43)	
SGMP-01	78 (17)	49 (11)	20 (0.82)	
SGMP-02	245 (55)	68 (15)	25 (1.02)	
SGMP-03	245 (55)	68 (15)	25 (1.02)	
SGMP-04	245 (55)	68 (15)	25 (1.02)	
SGMP-08	392 (88)	147 (33)	35 (1.43)	

Note The radial load and thrust load limit values are the sum of the loads generated by the motor torque and the external loads applied to the shaft.

2) Mechanical Tolerance

The tolerances of the SGM and SGMP Servomotor output shaft and installation are shown in the table below.

Tolerance (T.I.R.)		Reference Diagram
Perpendicularity between flange face and output shaft (A)	0.04mm (0.0016in.)	
Mating concentricity of flange O.D. (B)	0.04mm (0.0016in.)	
Run-out at end of shaft (C)	0.02mm (0.00079in.)	

Note T.I.R. = Total Indicator Reading

3) Direction of Motor Rotation

Positive rotation of the servomotor is counter-clockwise, viewing from the load.

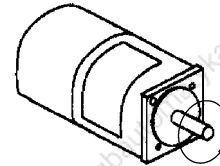

4) Impact Resistance

Mount the servomotor with the axis horizontal. The servomotor must withstand the following vertical impacts.

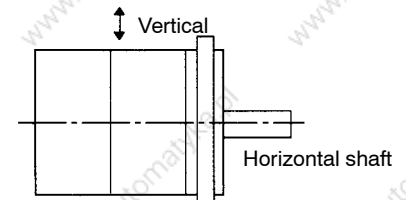

- Impact Acceleration: 98 m/s² (10 G)
- Number of Impacts: 2

NOTE In SGM and SGMP Servomotors, an accurate detector is attached to the shaft at the opposite end from the load.

Avoid applying impacts directly to the shaft as these may damage the detector.

5) Vibration Resistance

Mount the servomotor with the axis horizontal. The servomotor must withstand the following vibration accelerations in three directions: vertical, transverse, and longitudinal.

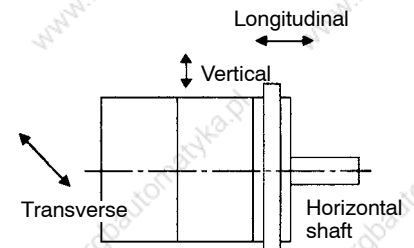

- Vibration Acceleration: 24.5 m/s² (2.5 G)

6) Vibration Class

The SGM and SGMP Servomotors meet the following **vibration class** at rated speed.

- Vibration Class: 15 μ m or below

Vibration Measurement Position

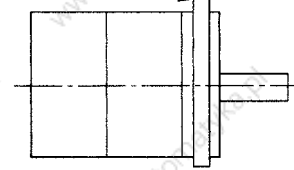

Vibration Class

Vibration class 15 μ m or below indicates that the total amplitude of vibration of the motor alone, running at rated speed, does not exceed 15 μ m.

5.3 Servopack Ratings and Specifications

This section presents tables of DR2 Servopack ratings and specifications separately for speed/torque control and for position control.

5.3.1	Ratings and Specifications	233
5.3.2	Power Consumption	238
5.3.3	Overload Characteristics	239
5.3.4	Starting Time and Stopping Time	240
5.3.5	Load Inertia	241
5.3.6	Overhanging Loads	246

5.3.1 Ratings and Specifications

1) The ratings and specifications of the DR2 Servopack are shown below. Refer to them as required when selecting a Servopack.
Refer to the specifications listed for combination with the appropriate type of Servomotor.

2) Ratings and Specifications of DR2 Servopack **for Speed/Torque Control**

Voltage			200 VAC					100 VAC					
Servopack Type	DR2-		A3AC	A5AC	01AC	02AC	04AC	08AC	A3BC	A5BC	01BC	02BC	03BC
Max. Applicable Motor Capacity W (HP)			30 (0.04)	50 (0.07)	100 (0.13)	200 (0.27)	400 (0.53)	750 (1.01)	30 (0.04)	50 (0.07)	100 (0.13)	200 (0.27)	300 (0.40)
Combined Specifica- tions	Motor	Type	A3A□	A5A□	01A□	02A□	04A□	08A□	A3B□	A5B□	01B□	02B□	03B□
		Motor Capacity W (HP)	30 (0.04)	50 (0.07)	100 (0.13)	200 (0.27)	400 (0.53)	750 (1.01)	30 (0.04)	50 (0.07)	100 (0.13)	200 (0.27)	300 (0.40)
		Rated/Max. Motor Speed	3000/4500 r/min						3000/4500 r/min				
		Applicable encoder	Incremental encoder 2048 P/R, absolute encoder 1024 P/R										
		Allowable Load Inertia*1 J_L $\text{kg}\cdot\text{m}^2 \times 10^{-4}$ $(\text{oz}\cdot\text{in}\cdot\text{s}^2 \times 10^{-3})$	0.63 (8.80)	0.78 (11.0)	1.20 (17.0)	3.69 (52.2)	5.73 (81.1)	20.1 (284.6)	0.63 (8.80)	0.78 (11.0)	1.20 (17.0)	3.69 (52.2)	5.73 (81.1)
		SGM (Upper)/ SGMP (Lower)	-	-	1.95 (27.6)	6.27 (88.8)	10.41 (147.4)	18.5 (262.0)	-	-	1.95 (27.6)	6.27 (88.8)	10.41 (147.4)
	Max. Output Current	1.3	1.9	2.8	6.0	8.0	13.9	2.0	2.9	7.1	8.4	14.8	
	Continuous Output Current A (rms)*9	0.42	0.60	0.87 (0.89)	2.0	2.6	4.4 (4.1)	0.63	0.90	2.2	2.7	3.7 (4.3)	
	Max. Output Current A (rms)	1.3	1.9	2.8	6.0	8.0	13.9	2.0	2.9	7.1	8.4	14.8	

SERVO SELECTION AND DATA SHEETS

5.3.1 Ratings and Specifications cont.

Voltage		200 VAC					100 VAC					
Servopack Type	DR2-	A3AC	A5AC	01AC	02AC	04AC	08AC	A3BC	A5BC	01BC	02BC	03BC
Max. Applicable Motor Capacity W (HP)		30 (0.04)	50 (0.07)	100 (0.13)	200 (0.27)	400 (0.53)	750 (1.01)	30 (0.04)	50 (0.07)	100 (0.13)	200 (0.27)	300 (0.40)
Basic Specifications	Power Supply (Main/control circuit)	Single-phase 200 to 230 VAC+10% to -15%, 50/60Hz					Single-phase 100 to 115 VAC+10% to -15%*2, 50/60Hz					
	Control Method	Single-phase, full-wave rectification IGBT-PWM (sine-wave driven)										
	Feedback	Incremental encoder 2048 P/R, absolute encoder 1024 P/R										
	Location	Ambient Temp.	0 to +55°C*3									
		Storage Temp.	-20 to +85°C									
		Ambient/Storage Humidity	90% or less (non-condensing)									
	Vibration/Shock Resistance	0.5/2G										
Structure	Rack-mounted*7											
Approx. Mass	kg (lb)	2.5 (5.51)				3.7 (8.16)		2.5 (5.51)		3.7 (8.16)		
Performance	Speed Control Range*4	1:5000										
	Speed Regulation*5	Load Regulation	0% to 100%:0.01% max. (at rated speed)									
		Voltage Regulation	+10% to -15%: 0.01% max. (at rated speed)									
		Temperature Regulation	25±25°C: ±0.2% max. (at rated speed)									
	Frequency Characteristics	250 Hz (at J _L =J _M)										
	Torque Control (Repeatability)	±2.0%										
Accel/Decel Time Setting	0 to 10 s											
Input Signal	Speed Reference	Rated Reference Voltage	±6 VDC (positive motor rotation with positive reference) at rated speed (factory setting) Variable setting range: ±2 to ±10 VDC at rated torque									
		Input Impedance	Approx. 30kΩ									
		Circuit Time Constant	Approx. 330μs									
	Torque Reference	Rated Reference Voltage	±3 VDC (positive motor rotation with positive reference) at rated speed (factory setting) Variable setting range: ±1 to ±10 VDC at rated torque									
		Input Impedance	Approx. 30kΩ									
		Circuit Time Constant	Approx. 330μs									
I/O Signals	Position Output	Output Form	A-, B-, C-phase line driver*8									
		Frequency Dividing Ratio	(16 to N) /N (N=2048, 1024)*6									
	Sequence Input	Servo ON, P drive (or motor forward/reverse by torque control, zero-clamp drive reference, or internal setting speed), forward run stop (P-OT), reverse run stop (N-OT), current limit + selection (or internal speed selection), current limit - selection (or internal speed selection), alarm reset										
	Sequence Output	Torque limit detection (or speed coincidence), motor running output (or external brake interlock), servo ready, servo alarm, 3-bit alarm codes										
Dynamic Brake	Operated at main power OFF, servo alarm or overtravel.											
External Regenerative Unit	Required when exceeding the allowable load inertia*1											
Overtravel	Dynamic brake stop at P-OT or N-OT or deceleration stop											
Protective Functions	Overcurrent, overload, overvoltage, overspeed, reference input read error, overrun prevention, origin error, CPU error, encoder error, fuse blown											

Indicators	Power (green LED) and status/alarm (red, 7-segment LEDs)
	Digital operator: status/alarm (red, 7-segment LEDs × 5)
Others	Torque control, zero clamp operation (position loop stop), soft start/stop, speed coincidence, brake interlock signal output, reverse run connection, JOG run, auto-tuning

*1 Allowable load inertia ranges require no optional regenerative unit (applicable to 200V 30W to 200W) or external regenerative resistor (applicable to 100V 200W, 300W or 200V 400W, 750W). Values are when motor speed is 3000r/min max. If load inertias exceed these ranges, restrict the operation or use a regenerative unit (applicable to 200V 30W to 200W) or external regenerative resistor (applicable to 100V 200W, 300W or 200V 400W, 750W).

For details, refer to 5.3.5 Load Inertia.

*2 Supply voltage should not exceed 230 V + 10% (253 V) or 115 V + 10% (127 V). A step-down transformer is required if the voltage should exceed these values.

*3 Use within the ambient temperature range. When enclosed in a box, the internal temperatures must not exceed the ambient temperature range.

*4 The lowest speed of the speed control range is the speed at which the motor does not stop under 100% load.

*5 Speed regulation is defined as follows:

$$\text{Speed regulation} = \frac{\text{No-load-speed} - \text{Full-load-speed}}{\text{Rated speed}} \times 100\%$$

The motor speed may change due to voltage variations or amplifier drift and changes in processing resistance due to temperature variation.

These ratios of the speed changes to the rated speed represent the speed regulation due to voltage and temperature variations.

*6 N is the number of encoder pulses.

*7 Base mount can be available as an option (DR2-□□Y7).

*8 Open collector output can be available as an option (DR2-□□Y1).

*9 Values in parenthesis show SGMP type Servomotor.

SERVO SELECTION AND DATA SHEETS

5.3.1 Ratings and Specifications cont.

3) Ratings and Specifications of DR2 Servopack for Position Control

Voltage			200 VAC					100 VAC						
Servopack Type DR2-			A3AC	A5AC	01AC	02AC	04AC	08AC	A3BC	A5BC	01BC	02BC	03BC	
Max. Applicable Motor Capacity W (HP)			30 (0.04)	50 (0.07)	100 (0.13)	200 (0.27)	400 (0.53)	750 (1.01)	30 (0.04)	50 (0.07)	100 (0.13)	200 (0.27)	300 (0.40)	
Combined Specifications	Motor	Type	A3A□	A5A□	01A□	02A□	04A□	08A□	A3B□	A5B□	01B□	02B□	03B□	
		Motor Capacity W (HP)	30 (0.04)	50 (0.07)	100 (0.13)	200 (0.27)	400 (0.53)	750 (1.01)	30 (0.04)	50 (0.07)	100 (0.13)	200 (0.27)	300 (0.40)	
		Rated/ Max. Motor Speed	3000/4500 r/min						3000/4500 r/min					
		Applicable encoder	Incremental encoder 2048 P/R, absolute encoder 1024 P/R											
		Allowable Load Inertia* ¹ J_L kg·m ² × 10 ⁻⁴ (oz·in·s ² × 10 ⁻³)	0.63 (8.80)	0.78 (11.0)	1.20 (17.0)	3.69 (52.2)	5.73 (81.1)	20.1 (284.6)	0.63 (8.80)	0.78 (11.0)	1.20 (17.0)	3.69 (52.2)	5.73 (81.1)	
SGM (Upper)/ SGMP (Lower)	-	-	1.95 (27.6)	6.27 (88.8)	10.41 (147.4)	18.5 (262.0)	-	-	1.95 (27.6)	6.27 (88.8)	10.41 (147.4)			
Combined Specifications	Continuous Output Current* ⁷		0.42	0.6	0.87 (0.89)	2.0	2.6	4.4 (4.1)	0.63	0.90	2.2	2.7	3.7 (4.3)	
	Max. Output Current		1.3	1.9	2.8	6.0	8.0	13.9	2.0	2.9	7.1	8.4	14.8	
Basic Specifications	Power Supply (Main/control circuit)		Single-phase 200 to 230 VAC, +10% to -15%, 50/60 Hz* ²					Single-phase 100 to 115 VAC* ² , +10% to -15%, 50/60 Hz						
	Control Method		Single-phase, full-wave rectification IGBT-PWM (sine-wave driven)											
	Feedback		Incremental encoder 2048 P/R, absolute encoder 1024 P/R											
	Location	Ambient Temp.		0 to 55°C* ³										
		Storage Temp.		-20°C to +85°C										
		Ambient/Storage Humidity		90% or less (with no condensation)										
		Vibration/Shock Resistance		0.5/2G										
	Structure		Rack-mounted* ⁵											
Approx. Mass kg (lb)		2.5 (5.51)					3.7 (8.16)		2.5 (5.51)		3.7 (8.16)			
Performance	Bias Setting		0 to 450 r/min. (Setting resolution: 1 r/min.)											
	Feed Forward Compensation		0 to 100% (Setting resolution: 1%)											
	Position Complete Width Setting		0 to 250 reference units. Reference unit: minimum unit of position data which moves load											
Input Signal	Reference Pulse	Type	SIGN + PULSE train, 90° phase difference 2-phase pulse, (A-phase+B-phase), CCW pulse+CW pulse											
		Pulse Form	Line driver (+5 V level), open collector (+5 V or +12 V level)											
		Pulse Frequency	0 to 450 kpps											
	Control Signal		CLEAR (input pulse form identical to reference pulse)											
I/O Signals	Position Output	Output Form	A-, B-, C-phase line driver* ⁶											
		Frequency Dividing Ratio	(16 to N) / N (N=2048, 1024)* ⁴											
	Sequence Input		Servo ON, P drive (or motor forward/reverse by internal speed setting), forward run stop (P-OT), reverse run stop (N-OT), alarm reset, current limit + selection (or internal speed selection), current limit - selection (or internal speed selection)											
	Sequence Output		Positioning complete, motor running output (or external brake interlock), servo ready, servo alarm, 3-bit alarm codes											
Dynamic Brake			Operated at main power OFF, servo alarm or overtravel.											
External Regenerative Unit			Required when exceeding the allowable load inertia											

Overtravel	Dynamic brake stop at P-OT or N-OT or deceleration stop
Protective Functions	Overcurrent, overload, overvoltage, overspeed, overrun prevention, origin error, CPU error, encoder error, overflow, fuse blown, undervoltage
Indicators	Power (green LED) and status/alarm (red, 7-segment LEDs)
	Digital operator: status/alarm (red, 7-segment LEDs × 5)
Others	Brake interlock signal output, reverse run connection, JOG run, electronic gear, auto-tuning

- *1 Allowable load inertia ranges require no optional external regenerative unit (applicable to 200V 30W to 200W) or external regenerative resistor (applicable to 100V 200W, 300W or 200V 400W, 750W). Values are when motor speed is 3000r/min max. If load inertias exceed these ranges, restrict the operation or use a regenerative unit (applicable to 200V 30W to 200W) or external regenerative resistor (applicable to 100V 200W, 300W or 200V 400W, 750W).
For details, refer to 5.3.5 Load Inertia.
- *2 Supply voltage should not exceed 230 V + 10% (253 V) or 115 V + 10% (127 V). A step-down transformer is required if the voltage should exceed these values.
- *3 Use within the ambient temperature range. When enclosed in a box, the internal temperatures must not exceed the ambient temperature range.
- *4 N is the number of encoder pulses.
- *5 Base mount can be available as an option (DR2-□□Y7).
- *6 Open collector output can be available as an option (DR2-□□Y1).
- *7 Values in parenthesis show SGMP type Servomotor.

5.3.2 Power Consumption

Servopack Type DR2-		Output Current (Effective Value) A	Power Loss W			<Total> Power Loss W
			Main Circuit	Regenerative Resistor	Control Circuit	
Supply Voltage 200V	A3A□ (30W-0.04HP)	0.42	2.9	-	13	15.9
	A5A□ (50W-0.07HP)	0.6	4.2			17.2
	01A□ (100W-0.13HP)	0.87	6.3			19.3
	02A□ (200W-0.27HP)	2.0	14.5	27.5		
	04A□ (400W-0.53HP)	2.6	22.2	6		41.2
	08A□ (750W-1.01HP)	4.4	36.1			55.1
Supply Voltage 100V	A3B□ (30W-0.04HP)	0.63	2.9	-	6	15.9
	A5B□ (50W-0.07HP)	0.90	4.4			17.4
	01B□ (100W-0.13HP)	2.2	12.0			25.0
	02B□ (200W-0.27HP)	2.7	16.2	35.2		
	03B□ (300W-0.40HP)	3.7	20.1	39.1		

Note Power loss of regenerative resistor shows the allowable loss. If this value is exceeded, remove the built-in regenerative resistor inside the Servopack and install a resistor externally. Before installing an external regenerative resistor, contact your Yaskawa representative.

5

5.3.3 Overload Characteristics

The Servopack has a built-in overload protective function to protect the Servopack and Servomotor from overload. Therefore, the Servopack allowable power is limited by the overload protective function, as shown below.

The overload detection level is quoted under **hot start** conditions at a motor ambient temperature of 40°C.

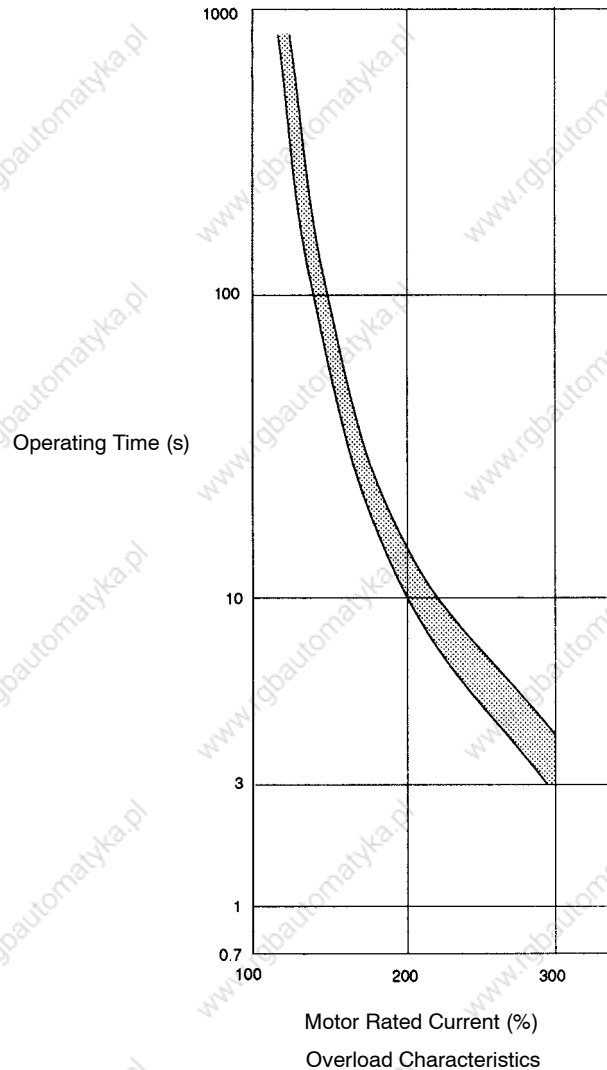

Hot Start

Indicates that both Servopack and Servomotor have run long enough at rated load to be thermally saturated.

5.3.4 Starting Time and Stopping Time

1) The motor starting time (t_r) and stopping time (t_f) under constant load are calculated by the following formulas. The motor viscous torque and friction torque are ignored.

$$\text{Starting Time: } t_r = 104.7 \times \frac{N_R (J_M + J_L)}{K_t I_R (\alpha - \beta)} \quad [\text{ms}]$$

$$\text{Stopping Time: } t_f = 104.7 \times \frac{N_R (J_M + J_L)}{K_t I_R (\alpha + \beta)} \quad [\text{ms}]$$

N_R : Motor rated speed (r/min.)

J_M : Motor moment of inertia ($\text{kg}\cdot\text{m}^2 = \text{lb}\cdot\text{in}\cdot\text{s}^2$) . . . ($\text{GD}^2_M/4$)

J_L : Load converted to shaft moment of inertia ($\text{kg}\cdot\text{m}^2$) . . ($\text{GD}^2_L/4$)

K_t : Motor torque constant ($\text{N}\cdot\text{m}/\text{A} = \text{lb}\cdot\text{in}/\text{A}$)

I_R : Motor rated current (A)

$\alpha = I_P/I_R$: Accel/decel current coefficient

[where I_P is accel/decel current (accel/decel current is α times the motor rated current) (A)]

$\beta = I_L/I_R$: Load current coefficient

[I_L : Load torque equivalent current (load current is β times the motor rated current) (A)]

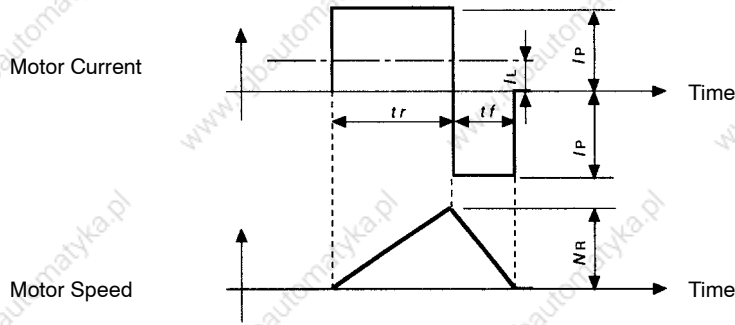

Motor Current (size) - Motor Speed Timing Chart

5.3.5 Load Inertia

- 1) The larger the load inertia becomes, the worse the movement response of the load. The size of the load inertia $[J_L]$ allowable when using a Servomotor depends on the motor capacity, as shown in the diagrams below.

- Small Load Inertia

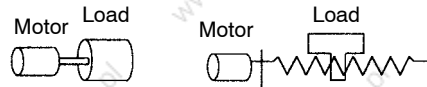

- Large Load Inertia

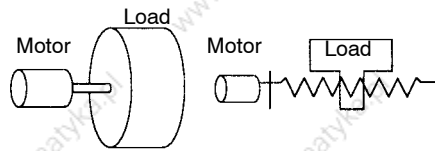

5.3.5 Load Inertia cont.

a) SGM Servomotors
200-VAC Servomotors with incremental encoder

Load Inertia
 $\text{kg}\cdot\text{m}^2 \times 10^{-4}$
 $(\text{oz}\cdot\text{in}\cdot\text{s}^2 \times 10^{-3})$

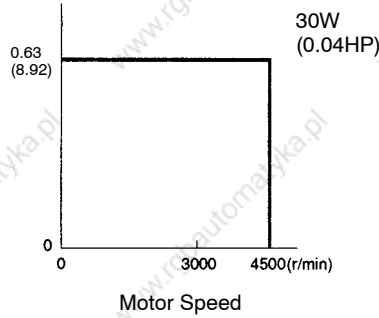

Load Inertia
 $\text{kg}\cdot\text{m}^2 \times 10^{-4}$
 $(\text{oz}\cdot\text{in}\cdot\text{s}^2 \times 10^{-3})$

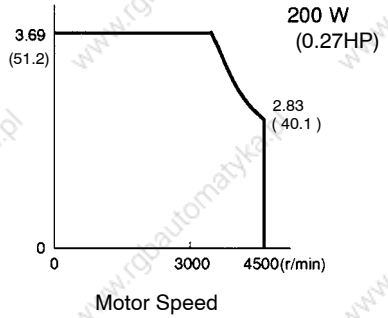

Load Inertia
 $\text{kg}\cdot\text{m}^2 \times 10^{-4}$
 $(\text{oz}\cdot\text{in}\cdot\text{s}^2 \times 10^{-3})$

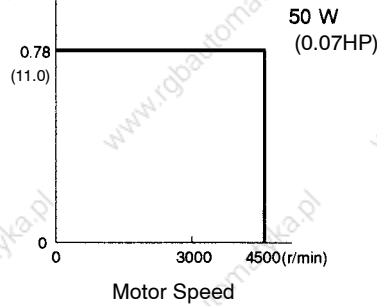

Load Inertia
 $\text{kg}\cdot\text{m}^2 \times 10^{-4}$
 $(\text{oz}\cdot\text{in}\cdot\text{s}^2 \times 10^{-3})$

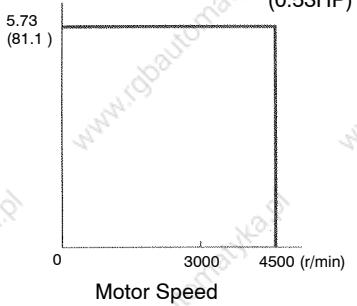

Load Inertia
 $\text{kg}\cdot\text{m}^2 \times 10^{-4}$
 $(\text{oz}\cdot\text{in}\cdot\text{s}^2 \times 10^{-3})$

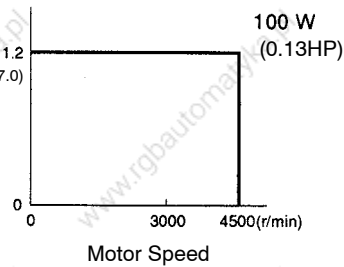

Load Inertia
 $\text{kg}\cdot\text{m}^2 \times 10^{-4}$
 $(\text{oz}\cdot\text{in}\cdot\text{s}^2 \times 10^{-3})$

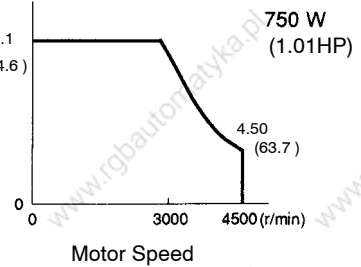

- Note**
- 1 The above diagrams represent deceleration under maximum torque. Applying an acceleration/deceleration curve to the reference allows operation outside the range of the diagrams. (That is, characteristics change according to pattern of operation and load) conditions.
 - 2 As for 400W and 750W types, make sure not to perform frequent accel/decel, since regenerative resistor is incorporated inside the Servopack.

b) SGM Servomotors
100-VAC Servomotors with incremental encoder

Load Inertia
 $\text{kg}\cdot\text{m}^2 \times 10^{-4}$
 $(\text{oz}\cdot\text{in}\cdot\text{s}^2 \times 10^{-3})$

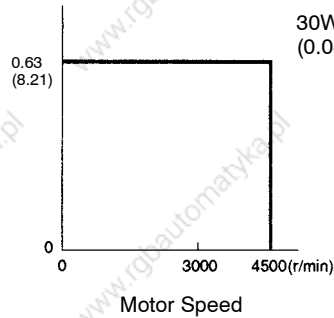

Load Inertia
 $\text{kg}\cdot\text{m}^2 \times 10^{-4}$
 $(\text{oz}\cdot\text{in}\cdot\text{s}^2 \times 10^{-3})$

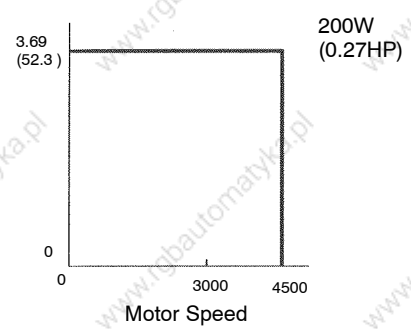

Load Inertia
 $\text{kg}\cdot\text{m}^2 \times 10^{-4}$
 $(\text{oz}\cdot\text{in}\cdot\text{s}^2 \times 10^{-3})$

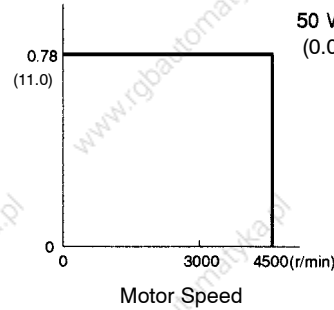

Load Inertia
 $\text{kg}\cdot\text{m}^2 \times 10^{-4}$
 $(\text{oz}\cdot\text{in}\cdot\text{s}^2 \times 10^{-3})$

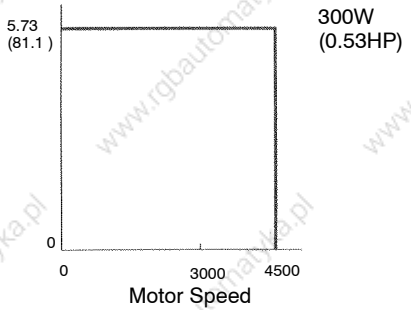

Load Inertia
 $\text{kg}\cdot\text{m}^2 \times 10^{-4}$
 $(\text{oz}\cdot\text{in}\cdot\text{s}^2 \times 10^{-3})$

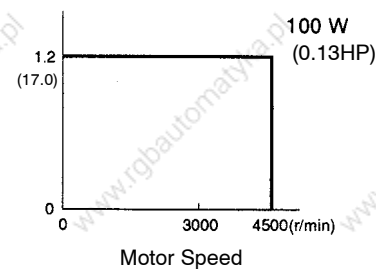

- Note**
- 1 The above diagrams represent deceleration under maximum torque. Applying an acceleration/deceleration curve to the reference allows operation outside the range of the diagrams. (That is, characteristics change according to pattern of operation and load conditions).
 - 2 As for 200W and 300W types, make sure not to perform frequent accel/decel, since regenerative resistor is incorporated inside the Servopack.

5.3.5 Load Inertia cont.

c) SGMP Servomotors
200-VAC Servomotors with incremental encoder

Load Inertia
 $\text{kg}\cdot\text{m}^2 \times 10^{-4}$
 $(\text{oz}\cdot\text{in}\cdot\text{s}^2 \times 10^{-3})$

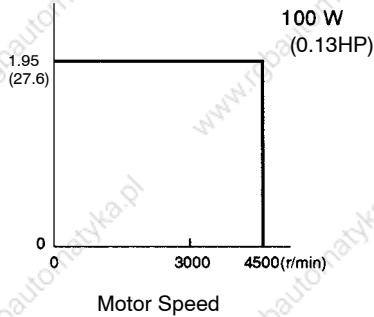

Load Inertia
 $\text{kg}\cdot\text{m}^2 \times 10^{-4}$
 $(\text{oz}\cdot\text{in}\cdot\text{s}^2 \times 10^{-3})$

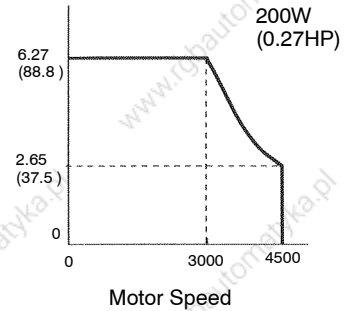

Load Inertia
 $\text{kg}\cdot\text{m}^2 \times 10^{-4}$
 $(\text{oz}\cdot\text{in}\cdot\text{s}^2 \times 10^{-3})$

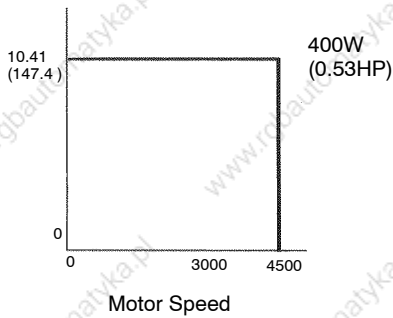

Load Inertia
 $\text{kg}\cdot\text{m}^2 \times 10^{-4}$
 $(\text{oz}\cdot\text{in}\cdot\text{s}^2 \times 10^{-3})$

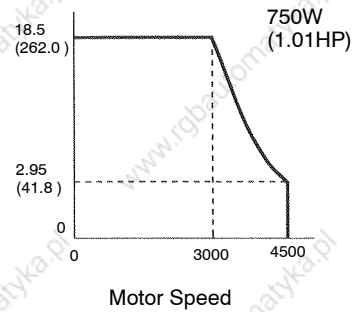

- Note**
- 1 Diagrams above represent deceleration under maximum torque. Applying an acceleration/ deceleration curve to the reference allows operation outside the range of the diagrams. (That is, the characteristics change according to pattern of operation and load conditions).
 - 2 As for 400W and 750W types, make sure not to perform frequent accel/decel, since regenerative resistor is incorporated inside the Servopack.

d) SGMP Servomotors
100-VAC Servomotors with incremental encoder

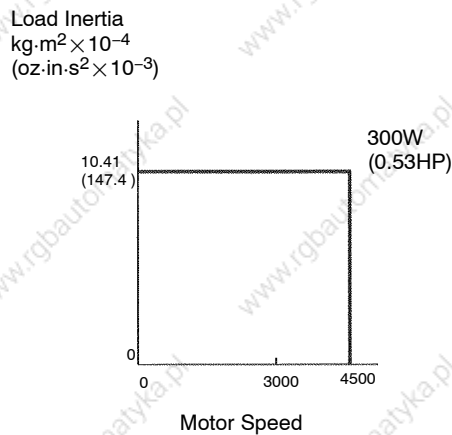
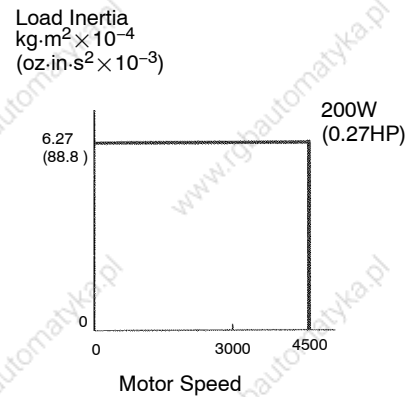
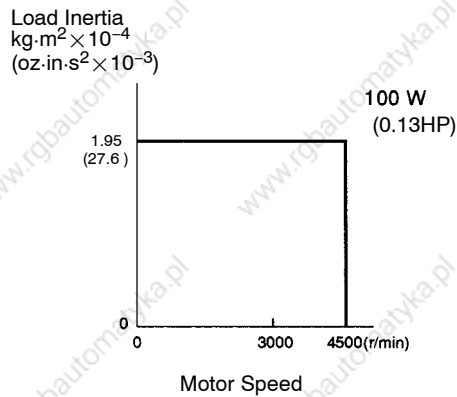

- Note**
- 1 Diagrams above represent deceleration under maximum torque. Applying an acceleration/ deceleration curve to the reference allows operation outside the range of the diagrams. (That is, the characteristics change according to pattern of operation and load conditions).
 - 2 As for 200W and 300W types, make sure not to perform frequent accel/dec, since regenerative resistor is incorporated inside the Servopack.

5.3.6 Overhanging Loads

- 2) An overvoltage alarm is likely during deceleration if the load inertia exceeds the range of the diagrams. Take one of the countermeasures below.
 - a) Reduce the torque limit value.
 - b) Reduce the deceleration rate.
 - c) Reduce the maximum speed used.
 - d) Add a regenerative unit (applicable to 200V 30W to 200W) or external regenerative resistor (applicable to 100V 200W, 300W or 200V 400W, 750W).

5.3.6 Overhanging Loads

- 1) A Servomotor may not be operated under an overhanging load, that is a load which tends to continually rotate the motor. Under an overhanging load (e.g. when the direction of the torque applied by the motor is opposite from the direction of shaft rotation), the Servopack regenerative brake is applied continuously and the regenerative energy of the load may exceed the allowable range and damage the Servopack. The regenerative brake capacity of the DR2 Servopack is rated for short-time operation, approximately equivalent to the deceleration stopping time.

- Overhanging Load Example 1: Motor drive for vertical axis, using no counterweight

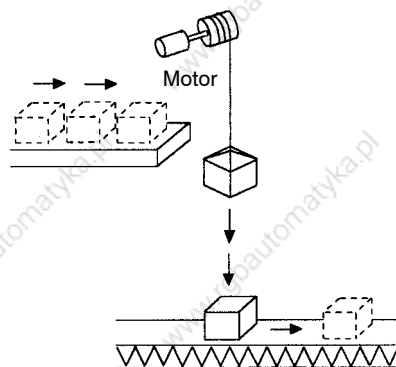

- Overhanging Load Example 2: Tension control drive

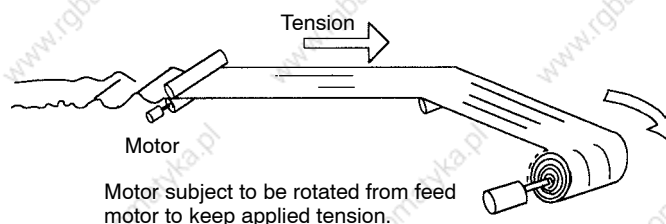

5.4 Σ -Series Dimensional Drawings

This section presents dimensional drawings of the Σ -Series Servomotor, Servopack, and Digital Operator.

5.4.1	Servomotor Dimensional Drawings	247
5.4.2	Servomotor Dimensional Drawings (TÜV approved, conforming to the machine instructions)	289
5.4.3	Servopack Dimensional Drawings	329
5.4.4	Digital Operator Dimensional Drawing	334

5.4.1 Servomotor Dimensional Drawings

1) The dimensional drawings of the SGM Servomotors are broadly grouped into the following four categories.

- a) Incremental encoder, no brake (from page 248)
- b) Incremental encoder, with brake (from page 253)
- c) Absolute encoder, no brake (from page 258)
- d) Absolute encoder, with brake (from page 264)

Motor capacities are available as 30 W (0.04 HP), 50 W (0.07 HP), 100 W (0.13 HP), 200 W (0.27 HP), 300 W (0.40 HP), 400 W (0.53 HP), 750 W (1.01 HP). These are grouped into three categories, as follows:

- 30W (0.04 HP), 50W (0.07 HP), 100W (0.13 HP)
- 200W (0.27 HP), 300W (0.40 HP), 400W (0.53 HP)
- 750W (1.01 HP)
- **As for the dimensional drawings of SGMP servomotors, see from the page 269 on.**
- **As for the dimensional drawings of TÜV approved SGM servomotors, see from the page 289 on.**
- **As for the dimensional drawings of TÜV approved SGMP servomotors, see from the page 309 on.**

SERVO SELECTION AND DATA SHEETS

5.4.1 Servomotor Dimensional Drawings cont.

(1) SGM Servomotor
Incremental encoder, no brake (Type SGM-□□□31□)

- 30W (0.04 HP), 50W (0.07 HP), 100W (0.13 HP)

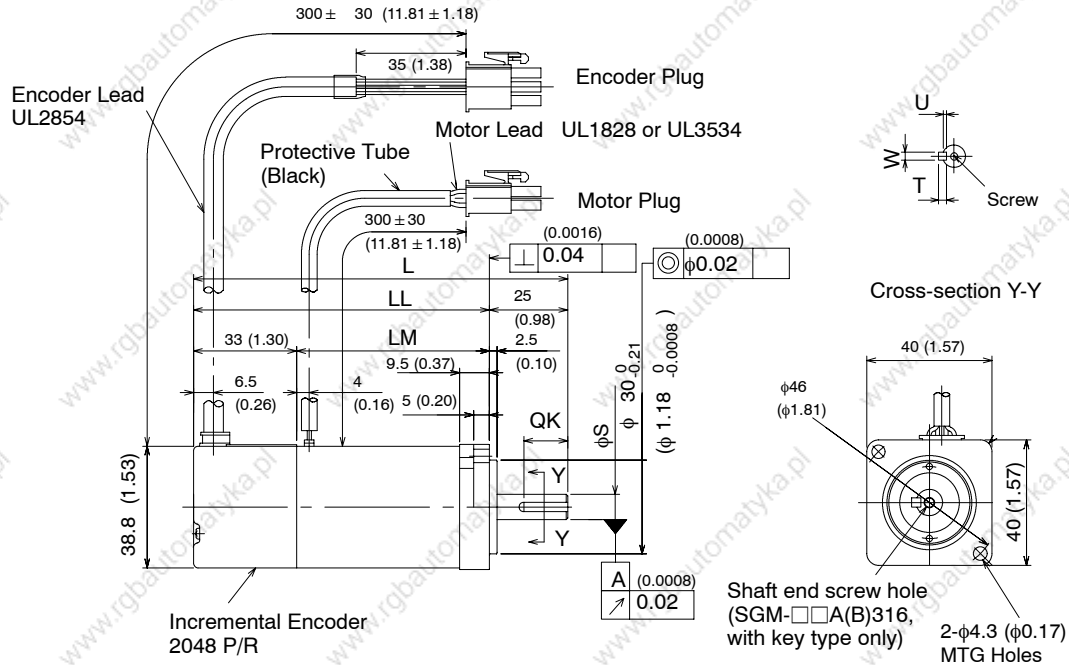

5

Type SGM-	L	LL	LM	S	QK	U	W	T	Screw dimensions	Output W (HP)	Approx. mass kg (lb)	Allowable radial load N (lb)	Allowable thrust load N (lb)
A3A312	94.5 (3.72)	69.5 (2.74)	36.5 (1.44)	6 (0.24)	No key				-	30 (0.04)	0.3 (0.66)	68 (15.3)	54 (12.1)
A3B312													
A3A314					14 (0.55)	1.2 (0.05)	2 (0.08)	2 (0.08)					
A3B314													
A3A316					M2.5 depth 5 (0.20)								
A3B316													
A5A312	102.0 (4.02)	77.0 (3.03)	44.0 (1.73)	6 (0.24)	No key				-	50 (0.07)	0.4 (0.88)	78 (17.5)	
A5B312													
A5A314					14 (0.55)	1.2 (0.05)	2 (0.08)	2 (0.08)					
A5B314													
A5A316					M2.5 depth 5 (0.20)								
A5B316													
01A312	119.5 (4.70)	94.5 (3.72)	61.5 (2.42)	8 (0.31)	No key				-	100 (0.13)	0.5 (1.10)	78 (17.5)	
01B312													
01A314					14 (0.55)	1.8 (0.07)	3 (0.12)	3 (0.12)					
01B314													
01A316					M3 depth 6 (0.24)								
01B316													

- Note**
- 1) The detector uses an incremental encoder 2048 P/R.
 - 2) Type "A" indicates 200 V specification, and type "B" indicates 100 V specification.
 - 3) "A3A(B)314", "A3A(B)316", "A5A(B)314", "A5A(B)316" "01A(B)314" and "01A(B)316" have a keyed shaft. The keyway complies with JIS B 1301-1976 (precision). A straight key is supplied.
 - 4) The quoted allowable radial load is the value at a position 20 mm (0.79 in.) from the motor mounting surface.

• 200 W (0.27 HP), 300 W (0.40 HP), 400 W (0.53 HP)

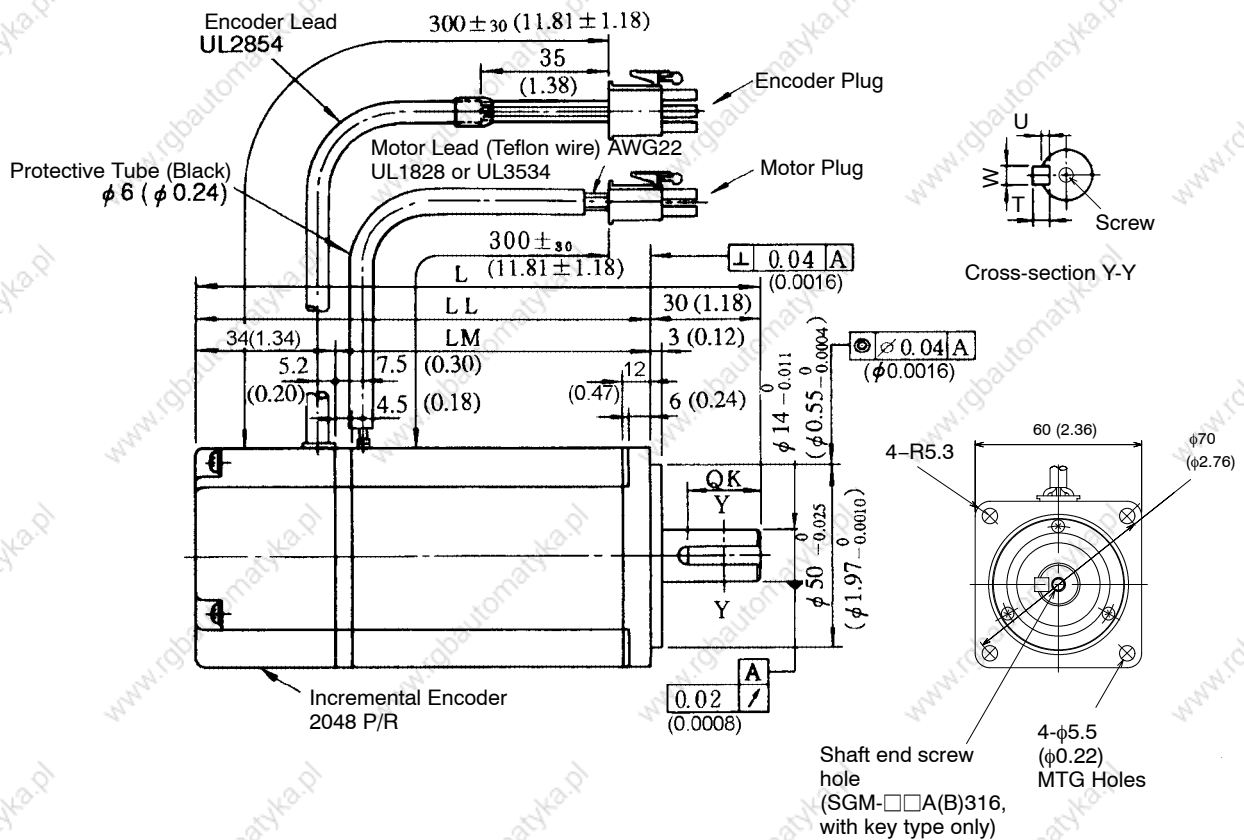

SERVO SELECTION AND DATA SHEETS

5.4.1 Servomotor Dimensional Drawings cont.

Type SGM-	L	LL	LM	QK	U	W	T	Screw dimensions	Output W (HP)	Approx. mass kg (lb)	Allowable radial load N (lb)	Allowable thrust load N (lb)
02A312	126.5 (4.98)	96.5 (3.80)	62.5 (2.46)	No key				-	200 (0.27)	1.1 (2.43)	245 (55.1)	74 (16.6)
02B312												
02A314												
02B314				20 (0.79)	3 (0.12)	5 (0.20)	5 (0.20)					
02A316				M5, depth 8 (0.31)								
02B316												
03B312	154.5 (6.08)	124.5 (4.90)	90.5 (3.56)	No key				-	300 (0.40)	1.7 (3.75)		
03B314												
03B316				20 (0.79)	3 (0.12)	5 (0.20)	5 (0.20)	M5, depth 8 (0.31)				
04A312	154.5 (6.08)	124.5 (4.90)	90.5 (3.56)	No key				-	400 (0.53)	1.7 (3.75)		
04A314												
04A316				20 (0.79)	3 (0.12)	5 (0.20)	5 (0.20)	M5, depth 8 (0.31)				

- Note**
- 1) The detector uses an incremental encoder 2048 P/R.
 - 2) Type "A" indicates 200 V specification, and type "B" indicates 100 V specification.
 - 3) "02A(B)314", "02A(B)316", "03B314", "03B316", "04A314" and "04A316" have a keyed shaft. The keyway complies with JIS B 1301-1976 (precision). A straight key is supplied.
 - 4) The quoted allowable radial load is the value at a position 25 mm (0.98 in.) from the motor mounting surface.

• 750 W (1.01 HP)

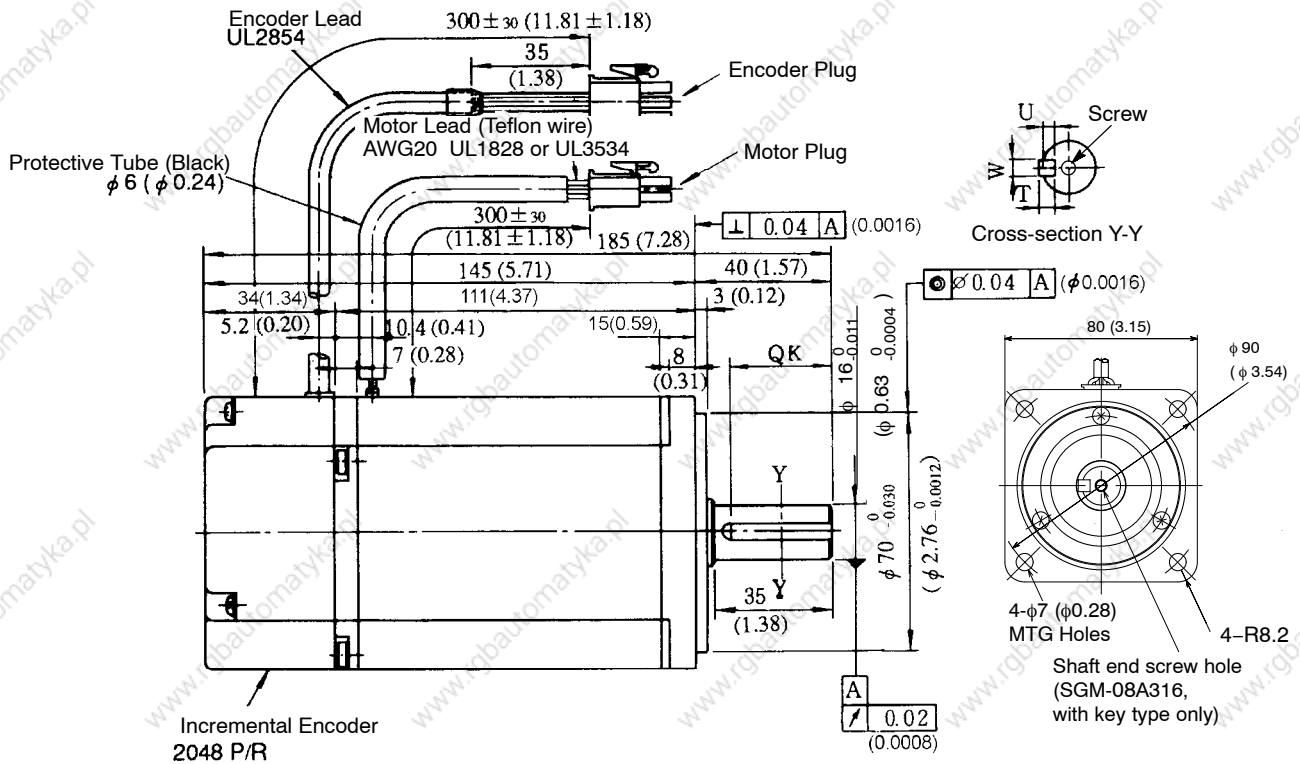

Type SGM-	QK	U	W	T	Screw dimensions	Output W (HP)	Approx. mass kg (lb)	Allowable radial load N (lb)	Allowable thrust load N (lb)
08A312	No key				-	750 (1.01)	3.4 (7.50)	392 (88.1)	147 (33.0)
08A314	30 (1.18)	3 (0.12)	5 (0.20)	5 (0.20)					
08A316					M5, depth 8 (0.31)				

- Note**
- 1) The detector uses an incremental encoder 2048 P/R.
 - 2) Type "A" indicates 200 V specification.
 - 3) "08A314" and "08A316" have a keyed shaft. The keyway complies with JIS B 1301-1976 (precision). A straight key is supplied.
 - 4) The quoted allowable radial load is the value at a position 35 mm (1.38 in.) from the motor mounting surface.

SERVO SELECTION AND DATA SHEETS

5.4.1 Servomotor Dimensional Drawings cont.

- Details of Motor and Encoder Plugs (Common for 30 W (0.04 HP) to 750 W (1.01 HP))

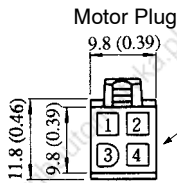

Plug : 172167-1 (AMP)
 Pin: 170360-1 or 170364-1
 (170359-1 or 170363-1: 30, 50, or
 100 W only)
 Connected to
 Cap: 172159-1
 Socket: 170362 -1 or 170366-1

Motor Wiring Specifications

1	U phase	Red
2	V phase	White
3	W phase	Blue
4	FG	Green

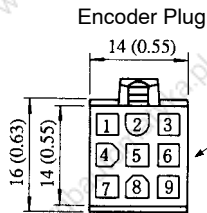

Plug: 172169-1 (Made by AMP)
 Pin: 170359-1 or 170363-1
 Connected to
 Cap : 172161-1
 Socket: 170361-1 or 170365-1

Incremental Encoder Wiring Specifications

1	A channel output	Blue
2	\bar{A} channel output	Blue/Black
3	B channel output	Yellow
4	\bar{B} channel output	Yellow/Black
5	C channel output	Green
6	\bar{C} channel output	Green/Black
7	0V (power supply)	Gray
8	+5V (power supply)	Red
9	FG (Frame Ground)	Orange

(2) SGM Servomotor
Incremental encoder, with brake (Type SGM-□□□31□B)

- 30W (0.04 HP), 50W (0.07 HP), 100W (0.13 HP)

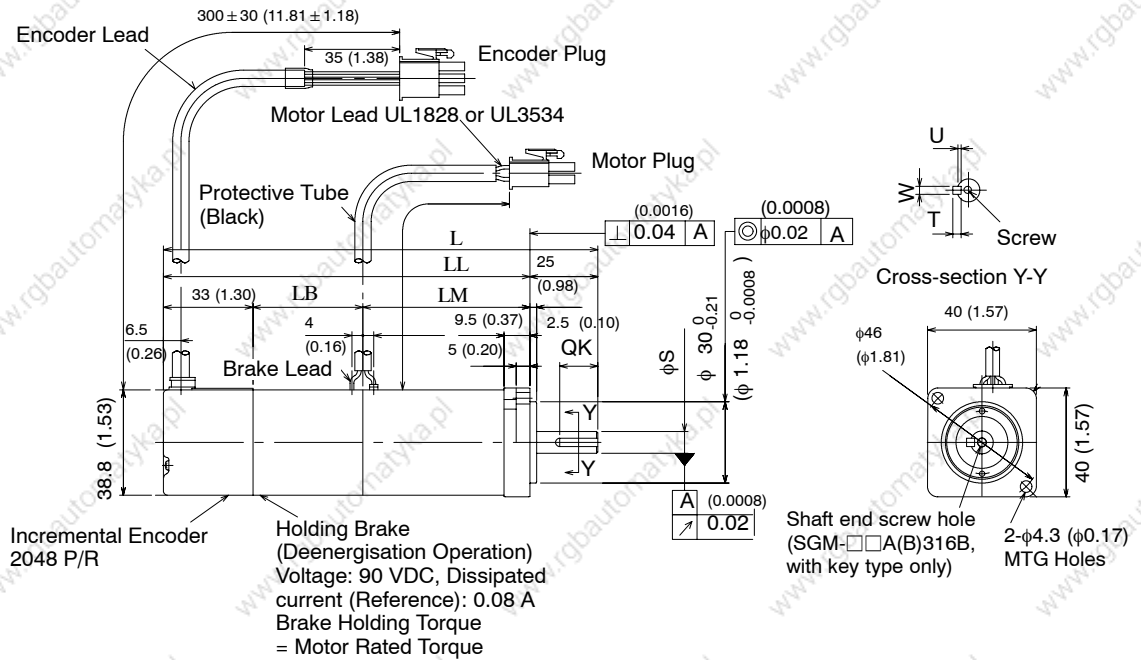

Type SGM-	L	LL	LM	LB	S	QK	U	W	T	Screw dimensions	Output W (HP)	Approx. mass kg (lb)	Allowable radial load N (lb)	Allowable thrust load N (lb)
A3A312B	126.0 (4.96)	101.0 (3.98)	36.5 (1.44)	31.5 (1.24)	6 (0.24)	No key				-	30 (0.04)	0.6 (1.32)	68 (15.3)	54 (12.1)
A3B312B														
A3A314B						14 (0.55)	1.2 (0.05)	2 (0.08)	2 (0.08)					
A3B314B														
A3A316B						M2.5, depth 5 (0.20)								
A3B316B														
A5A312B	133.5 (5.26)	108.5 (4.27)	44.0 (1.73)	31.5 (1.24)	6 (0.24)	No key				-	50 (0.07)	0.7 (1.54)		
A5B312B														
A5A314B						14 (0.55)	1.2 (0.05)	2 (0.08)	2 (0.08)					
A5B314B														
A5A316B						M2.5, depth 5 (0.20)								
A5B316B														
01A312B	160.0 (6.30)	135.0 (5.31)	61.5 (2.42)	40.5 (1.59)	8 (0.31)	No key				-	100 (0.13)	0.8 (1.76)	78 (17.5)	
01B312B														
01A314B						14 (0.55)	1.8 (0.07)	3 (0.12)	3 (0.12)					
01B314B														
01A316B						M3, depth 6 (0.24)								
01B316B														

SERVO MOTOR SELECTION AND DATA SHEETS

5.4.1 Servomotor Dimensional Drawings cont.

- Note**
- 1) The detector uses an incremental encoder 2048 P/R.
 - 2) Type "A" indicates 200 V specification, and type "B" indicates 100 V specification.
 - 3) "A3A(B)314B", "A3A(B)316B", "A5A(B)314B", "A5A(B)316B", "O1A(B)314B" and "O1A(B)316B" have a keyed shaft. The keyway complies with JIS B 1301-1976 (precision). A straight key is supplied.
 - 4) The quoted allowable radial load is the value at a position 20 mm (0.79 in.) from the motor mounting surface.
 - 5) The electromagnetic brake is only to hold the load in position and cannot be used to stop the motor.

- 200 W (0.53 HP), 300 W (0.40 HP), 400 W (0.27 HP)

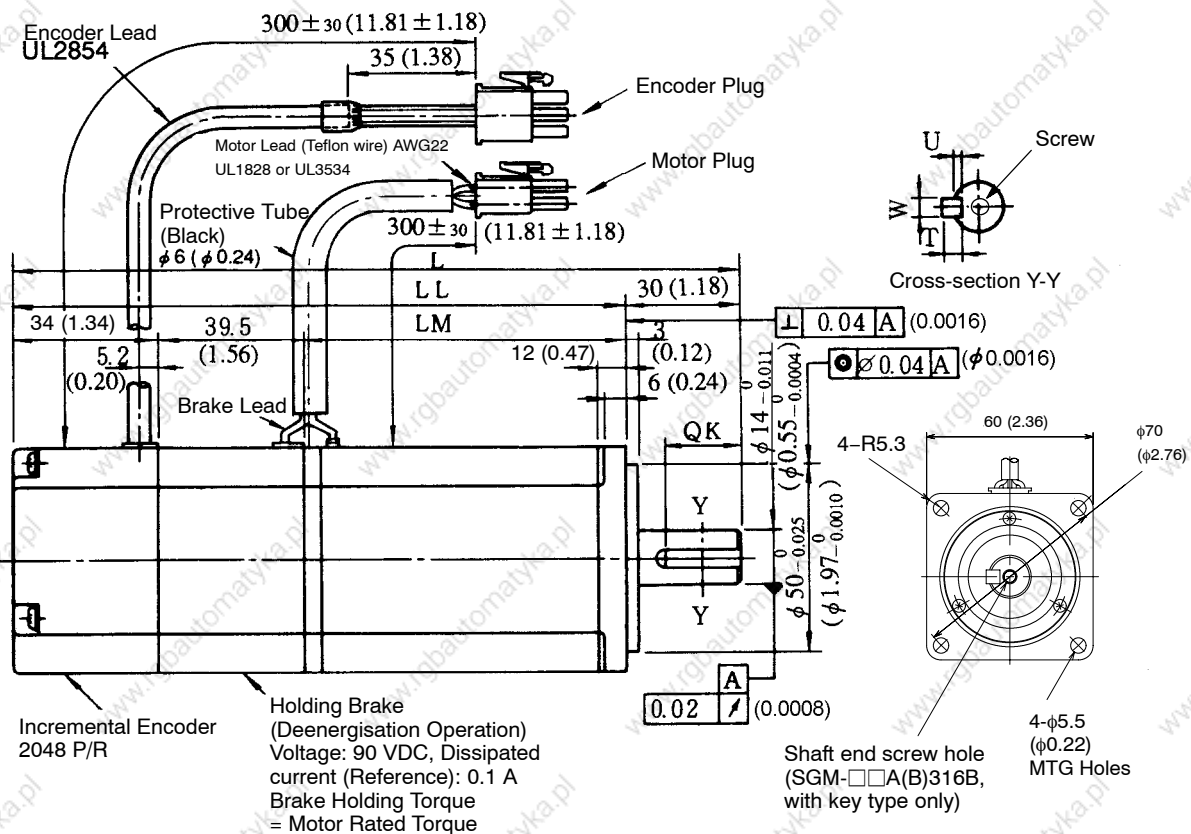

Type SGM-	L	LL	LM	QK	U	W	T	Screw dimensions	Output W (HP)	Approx. mass kg (lb)	Allowable radial load N (lb)	Allowable thrust load N (lb)
02A312B	166.0 (6.54)	136.0 (5.35)	62.5 (2.46)	No key				-	200 (0.27)	1.6 (3.53)	245 (55.1)	74 (16.6)
02B312B				20 (0.79)	3 (0.12)	5 (0.20)	5 (0.20)					
02A314B												
02B314B												
02A316B												
02B316B				M5, depth 8 (0.31)								
03B312B	194.0 (7.64)	164.0 (6.46)	90.5 (3.56)	No key				-	300 (0.40)	2.2 (4.85)		
03B314B				20 (0.79)	3 (0.12)	5 (0.20)	5 (0.20)					
03B316B								M5, depth 8 (0.31)				
04A312B				No key				-	400 (0.53)			
04A314B				20 (0.79)	3 (0.12)	5 (0.20)	5 (0.20)					
04A316B											M5, depth 8 (0.31)	

- Note**
- 1) The detector uses an incremental encoder 2048 P/R.
 - 2) Type "A" indicates 200 V specification, and type "B" indicates 100 V specification.
 - 3) "02A(B)314B", "02A(B)316B", "03B314B", "03B316B", "04A314B" and "04A316B" have a keyed shaft. The keyway complies with JIS B 1301-1976 (precision). A straight key is supplied.
 - 4) The quoted allowable radial load is the value at a position 25 mm (0.98 in.) from the motor mounting surface.
 - 5) The electromagnetic brake is only to hold the load in position and cannot be used to stop the motor.

SERVO SELECTION AND DATA SHEETS

5.4.1 Servomotor Dimensional Drawings cont.

• 750 W (1.01 HP)

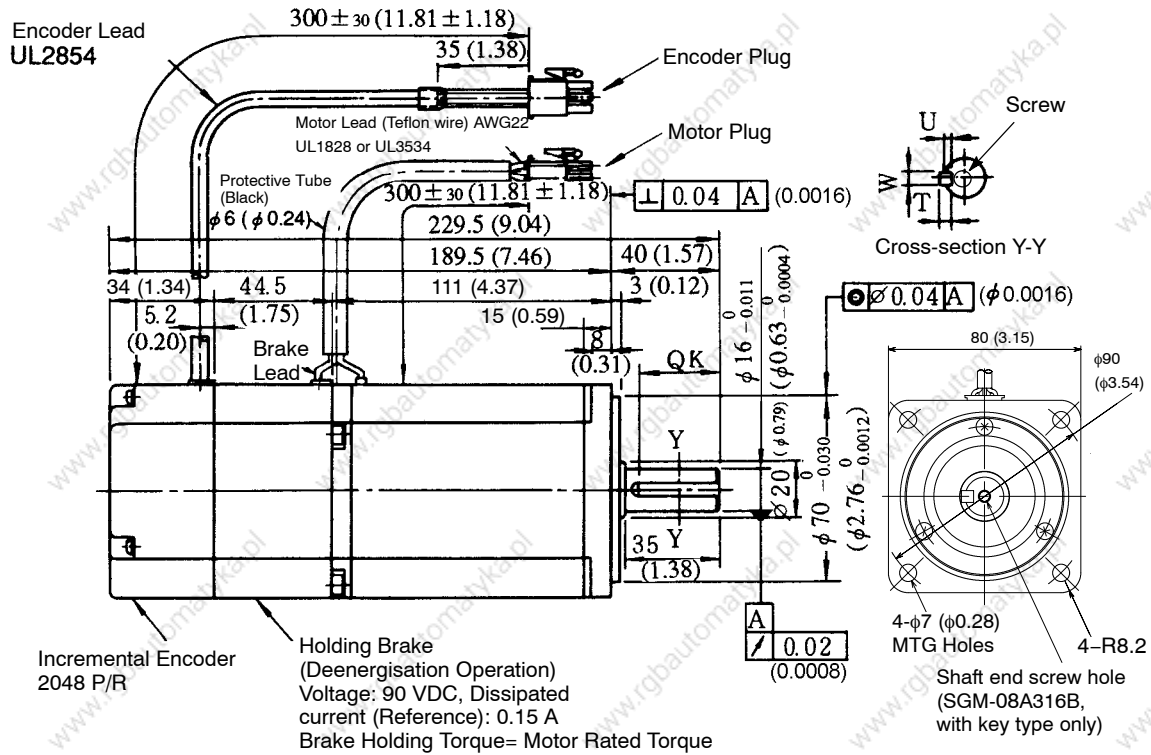

Type SGM-	QK	U	W	T	Screw dimensions	Output W (HP)	Approx. mass kg (lb)	Allowable radial load N (lb)	Allowable thrust load N (lb)
08A312B	No key				M5, depth 8 (0.31)	750 (1.01)	4.3 (9.48)	392 (88.1)	147 (33.0)
08A314B	30 (1.18)	3 (0.12)	5 (0.20)	5 (0.20)					
08A316B									

- Note**
- 1) The detector uses an incremental encoder 2048 P/R.
 - 2) Type "A" indicates 200 V specification.
 - 3) "08A314B" and "08A316B" have a keyed shaft. The keyway complies with JIS B 1301-1976 (precision). A straight key is supplied.
 - 4) The quoted allowable radial load is the value at a position 35 mm (1.38 in.) from the motor mounting surface.
 - 5) The electromagnetic brake is only to hold the load in position and cannot be used to stop the motor.

• Details of Motor and Encoder Plugs (Common for 30 W (0.04 HP) to 750 W (1.01 HP))

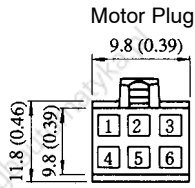

Motor Plug
 Plug : 172168-1 (AMP)
 Pin: 170360-1 or 170364-1
 (17359-1 or 170363-1: 30, 50, or
 100 W only)
 Connected to
 Cap: 172160-1
 Socket: 170362 -1 or 170366-1

Motor Wiring Specifications

1	U phase	Red
2	V phase	White
3	W phase	Blue
4	FG	Green/Yellow
5	Brake terminal	Red
6	Brake terminal	Black

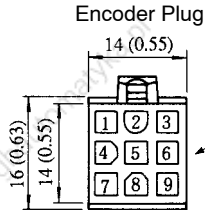

Encoder Plug
 Plug: 172169-1 (AMP)
 Pin: 170359-1 or 170363-1
 Connected to
 Cap :172161-1
 Socket: 170361-1 or 170365-1

Incremental Encoder Wiring Specifications

1	A channel output	Blue
2	\bar{A} channel output	Blue/Black
3	B channel output	Yellow
4	\bar{B} channel output	Yellow/Black
5	C channel output	Green
6	\bar{C} channel output	Green/Black
7	0V (power supply)	Gray
8	+5V (power supply)	Red
9	FG (Frame Ground)	Orange

SERVO SELECTION AND DATA SHEETS

5.4.1 Servomotor Dimensional Drawings cont.

(3) SGM Servomotor
Absolute encoder, no brake (Type SGM-□□□W1□)

- 30 W (0.04 HP), 50 W (0.07 HP), 100 W (0.13 HP)

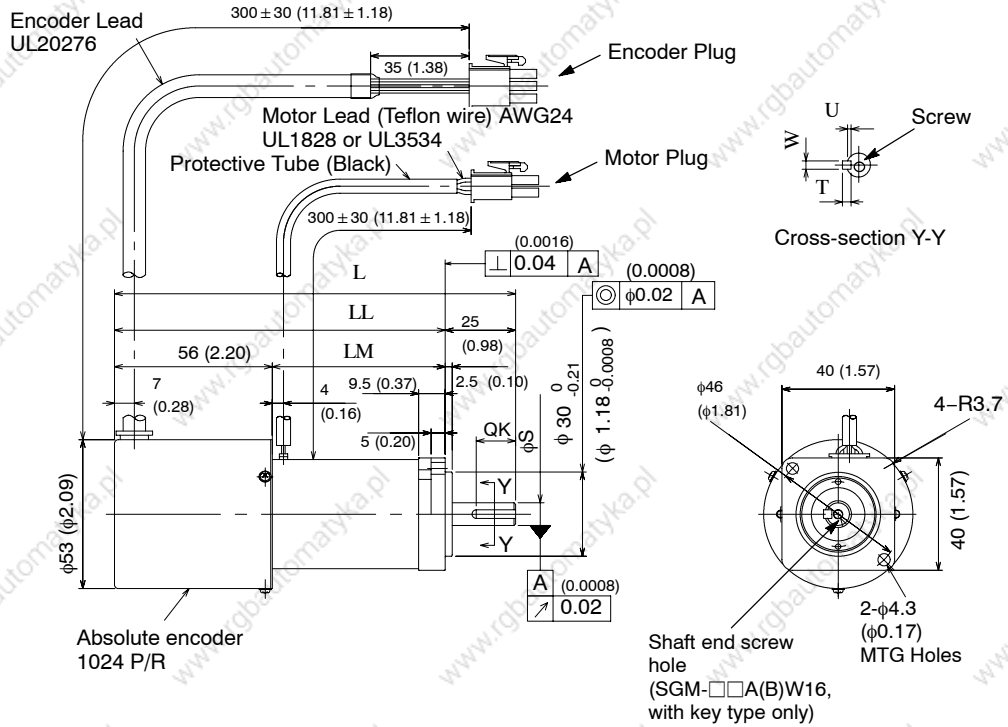

5

Type SGM-	L	LL	LM	S	QK	U	W	T	Screw dimensions	Output W (HP)	Approx. mass kg (lb)	Allowable radial load N (lb)	Allowable thrust load N (lb)
A3AW12	117.5 (4.63)	92.5 (3.64)	36.5 (1.44)	6 (0.24)	No key				---	30 (0.04)	0.45 (0.99)	68 (15.3)	54 (12.1)
A3BW12													
A3AW14					14 (0.55)	1.2 (0.05)	2 (0.08)	2 (0.08)					
A3BW14													
A3AW16					M2.5, depth 5 (0.20)								
A3BW16													
A5AW12	125.0 (4.92)	100.0 (3.94)	44.0 (1.73)	6 (0.24)	No key				---	50 (0.07)	0.55 (1.21)	78 (17.5)	
A5BW12													
A5AW14					14 (0.55)	1.2 (0.05)	2 (0.08)	2 (0.08)					
A5BW14													
A5AW16					M2.5, depth 5 (0.20)								
A5BW16													
01AW12	142.5 (5.61)	117.5 (4.63)	61.5 (2.42)	8 (0.31)	No key				---	100 (0.13)	0.65 (1.43)	78 (17.5)	
01BW12													
01AW14					14 (0.55)	1.8 (0.07)	3 (0.12)	3 (0.12)					
01BW14													
01AW16					M3, depth 6 (0.24)								
01BW16													

- Note**
- 1) The detector uses a 12-bit absolute encoder 1024 P/R.
 - 2) Type “A” indicates 200 V specification, and type “B” indicates 100 V specification.
 - 3) “A3A(B)W14”, “A3A(B)W16”, “A5A(B)W14”, “A5A(B)W16”, “O1A(B)W14” and “O1A(B)W16” have a keyed shaft. The keyway complies with JIS B 1301-1976 (precision). A straight key is supplied.
 - 4) The quoted allowable radial load is the value at a position 20 mm (0.79 in.) from the motor mounting surface.

SERVO SELECTION AND DATA SHEETS

5.4.1 Servomotor Dimensional Drawings cont.

- 200 W (0.27 HP), 300W (0.40 HP), 400 W (0.53 HP)

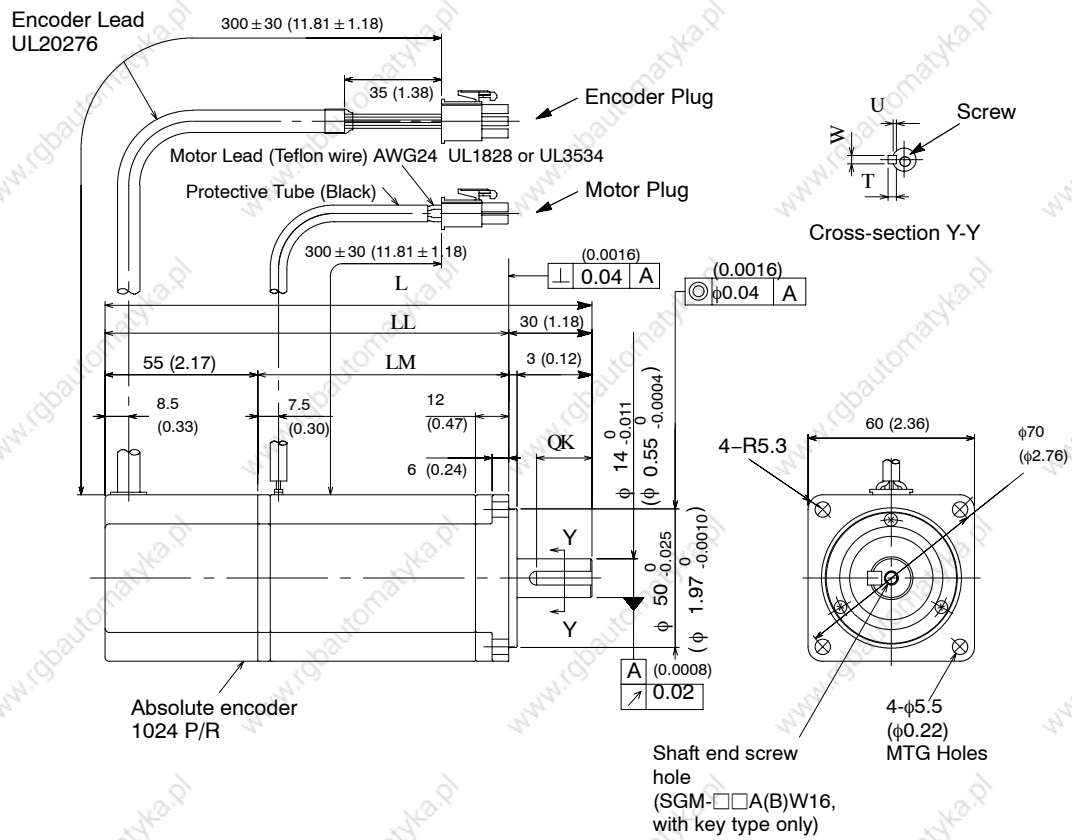

5

Type SGM-	L	LL	LM	QK	U	W	T	Screw dimensions	Output W (HP)	Approx. mass kg (lb)	Allowable radial load N (lb)	Allowable thrust load N (lb)	
02AW12	147.5 (5.81)	117.5 (4.63)	62.5 (2.46)	No key				-	M5, depth 8 (0.31)	200 (0.27)	1.2 (2.65)	245 (55.1)	74 (16.6)
02BW12				20 (0.79)	3 (0.12)	5 (0.20)	5 (0.20)						
02AW14													
02BW14													
02AW16													
02BW16													
03BW12	175.5 (6.91)	145.5 (5.73)	90.5 (3.56)	No key				-	M5, depth 8 (0.31)	300 (0.40)	1.8 (3.97)		
03BW14				20 (0.79)	3 (0.12)	5 (0.20)	5 (0.20)						
03BW16													
04AW12				No key				-	M5, depth 8 (0.31)	400 (0.53)			
04AW14				20 (0.79)	3 (0.12)	5 (0.20)	5 (0.20)						
04AW16													

- Note**
- 1) The detector uses a 12-bit absolute encoder 1024 P/R.
 - 2) Type “A” indicates 200 V specification, and type “B” indicates 100 V specification.
 - 3) “02A(B)W14”, “02A(B)W16”, “03BW14”, “03BW16”, “04AW14” and “04AW16” have a keyed shaft. The keyway complies with JIS B 1301-1976 (precision). A straight key is supplied.
 - 4) The quoted allowable radial load is the value at a position 25 mm (0.98 in.) from the motor mounting surface.

SERVO SELECTION AND DATA SHEETS

5.4.1 Servomotor Dimensional Drawings cont.

• 750 W (1.01 HP)

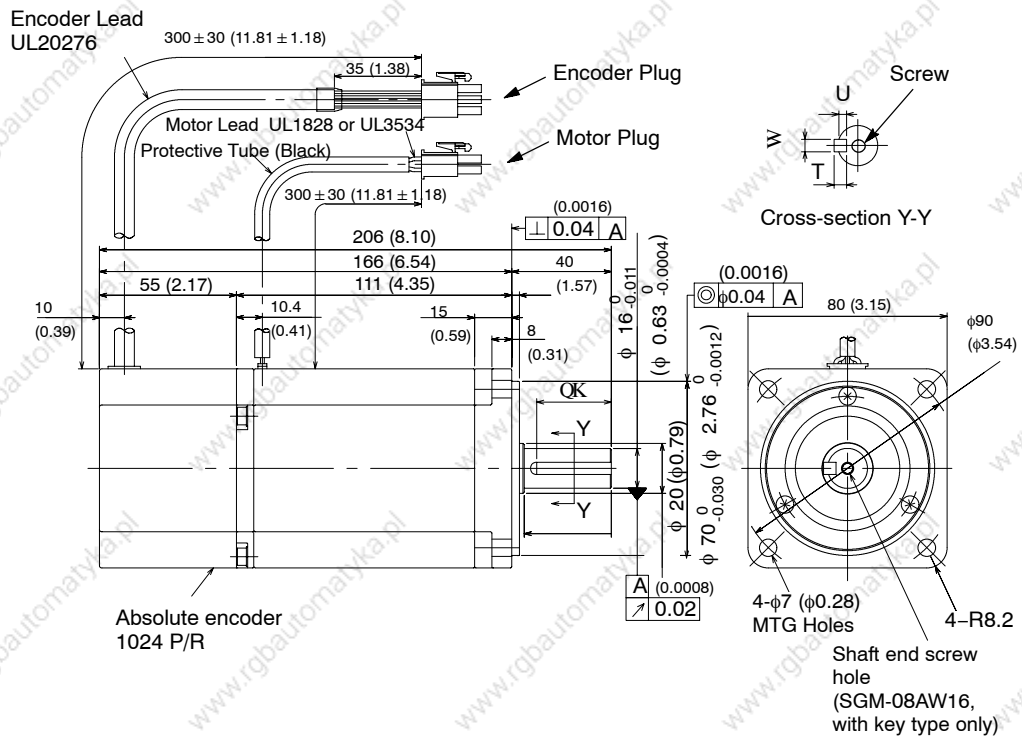

Type SGM-	QK	U	W	T	Screw dimensions	Output W (HP)	Approx. mass kg (lb)	Allowable radial load N (lb)	Allowable thrust load N (lb)
08AW12	No key				-	750 (1.01)	3.5 (7.72)	392 (88.1)	147 (33.0)
08AW14	30 (1.18)	3 (0.12)	5 (0.20)	5 (0.20)	M5, depth 8 (0.31)				
08AW16									

- Note**
- 1) The detector uses a 12-bit absolute encoder 1024 P/R.
 - 2) Type "A" indicates 200 V specification.
 - 3) "08AW14" and "08AW16" have a keyed shaft. The keyway complies with JIS B 1301-1976 (precision). A straight key is supplied.
 - 4) The quoted allowable radial load is the value at a position 35 mm (1.38 in.) from the motor mounting surface.

- Details of Motor and Encoder Plugs (Common for 30 W (0.04 HP) to 750 W (1.01 HP))

Motor Plug



Plug : 172167-1 (AMP)
 Pin: 170360-1 or 170364-1
 (17359-1 or 170363-1: 30, 50, or
 100 W only)
 Connected to
 Cap: 172159-1
 Socket: 170362 -1 or 170366-1

Motor Wiring Specifications

1	U phase	Red
2	V phase	White
3	W phase	Blue
4	FG	Green/Yellow

Encoder Plug

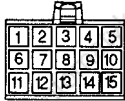

Plug: 172171-1 (AMP)
 Pin: 170359-1 or 170363-1
 Connected to
 Cap :172163-1
 Socket: 170361-1 or 170365-1

Incremental Encoder Wiring Specifications

1	A channel output	Blue
2	\bar{A} channel output	White/Blue
3	B channel output	Yellow
4	\bar{B} channel output	White/Yellow
5	Z channel output	Green
6	\bar{Z} channel output	White/Green
7	0 V (power supply)	Gray
8	+5 V (power supply)	Red
9	FG (Frame Ground)	Orange
10	S channel output	Purple
11	\bar{S} channel output	White/Purple
* (12)	(Capacitor reset)	(Gray)
13	Reset	White/Gray
14	0V(battery)	White/Orange
15	3.6V(battery)	Orange

* Terminal to discharge capacitor for product dispatch. Do not use.

SERVO SELECTION AND DATA SHEETS

5.4.1 Servomotor Dimensional Drawings cont.

(4) SGM Servomotor Absolute encoder, with brake (Type SGM-□□□W1□B)

- 30 W (0.04 HP), 50 W (0.07 HP), 100 W (0.13 HP)

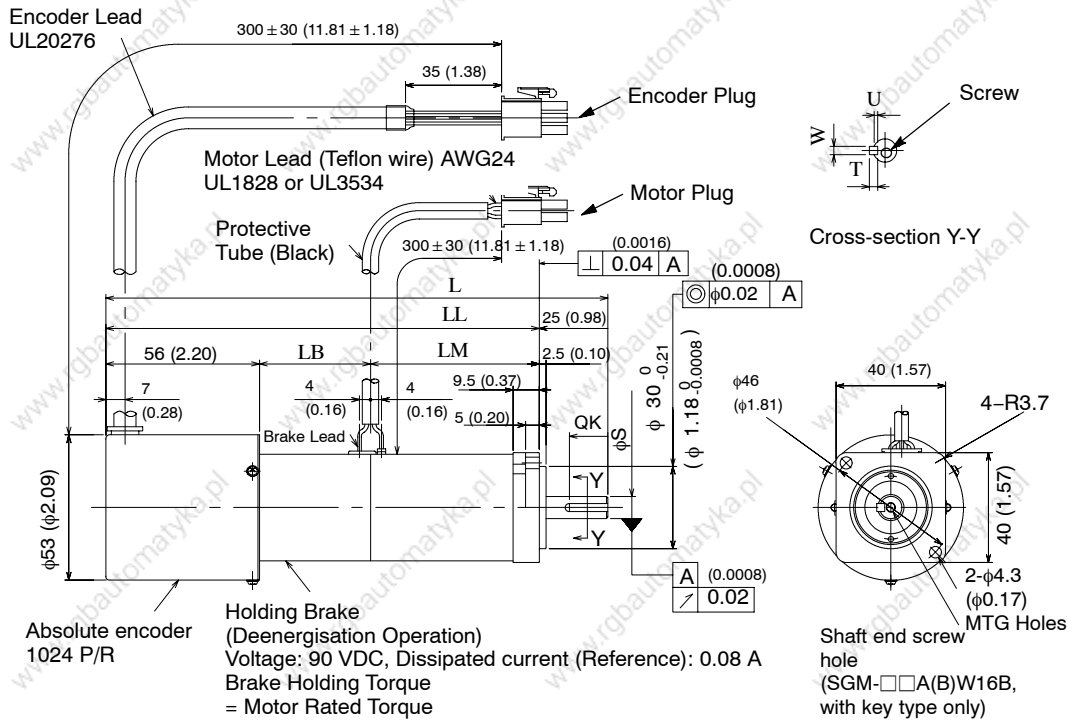

Type SGM-	L	LL	LM	LB	S	QK	U	W	T	Screw dimensions	Output W (HP)	Approx. mass kg (lb)	Allowable radial load N (lb)	Allowable thrust load N (lb)
A3AW12B	149.0 (5.87)	124.0 (4.88)	36.5 (1.44)	31.5 (1.24)	6 (0.24)	No key				M2.5, depth 5 (0.20)	30 (0.04)	0.75 (1.65)	68 (15.3)	54 (12.1)
A3BW12B														
A3AW14B						14 (0.55)	1.2 (0.05)	2 (0.08)	2 (0.08)					
A3BW14B														
A3AW16B														
A3BW16B														
A5AW12B	156.5 (6.16)	131.5 (5.18)	44.0 (1.73)			No key				M2.5, depth 5 (0.20)	50 (0.07)	0.85 (1.87)		
A5BW12B														
A5AW14B						14 (0.55)	1.2 (0.05)	2 (0.08)	2 (0.08)					
A5BW14B														
A5AW16B														
A5BW16B														
01AW12B	183.0 (7.20)	158.0 (6.22)	61.5 (2.42)	40.5 (1.59)	8 (0.31)	No key				M3, depth 6 (0.24)	100 (0.13)	0.95 (2.09)	78 (17.5)	
01BW12B														
01AW14B						14 (0.55)	1.8 (0.07)	3 (0.12)	3 (0.12)					
01BW14B														
01AW16B														
01BW16B														

- Note**
- 1) The detector uses a 12-bit absolute encoder 1024 P/R.
 - 2) Type “A” indicates 200 V specification, and type “B” indicates 100 V specification.
 - 3) “A3A(B)W14B”, “A3A(B)W16B”, “A5A(B)W14B”, “A5A(B)W16B”, “O1A(B)W14B” and “O1A(B)W16B” have a keyed shaft. The keyway complies with JIS B 1301-1976 (precision). A straight key is supplied.
 - 4) The quoted allowable radial load is the value at a position 20 mm (0.79 in.) from the motor mounting surface.
 - 5) The electromagnetic brake is only to hold the load in position and cannot be used to stop the motor.

• 200 W (0.27 HP), 300 W (0.40 HP), 400 W (0.53 HP)

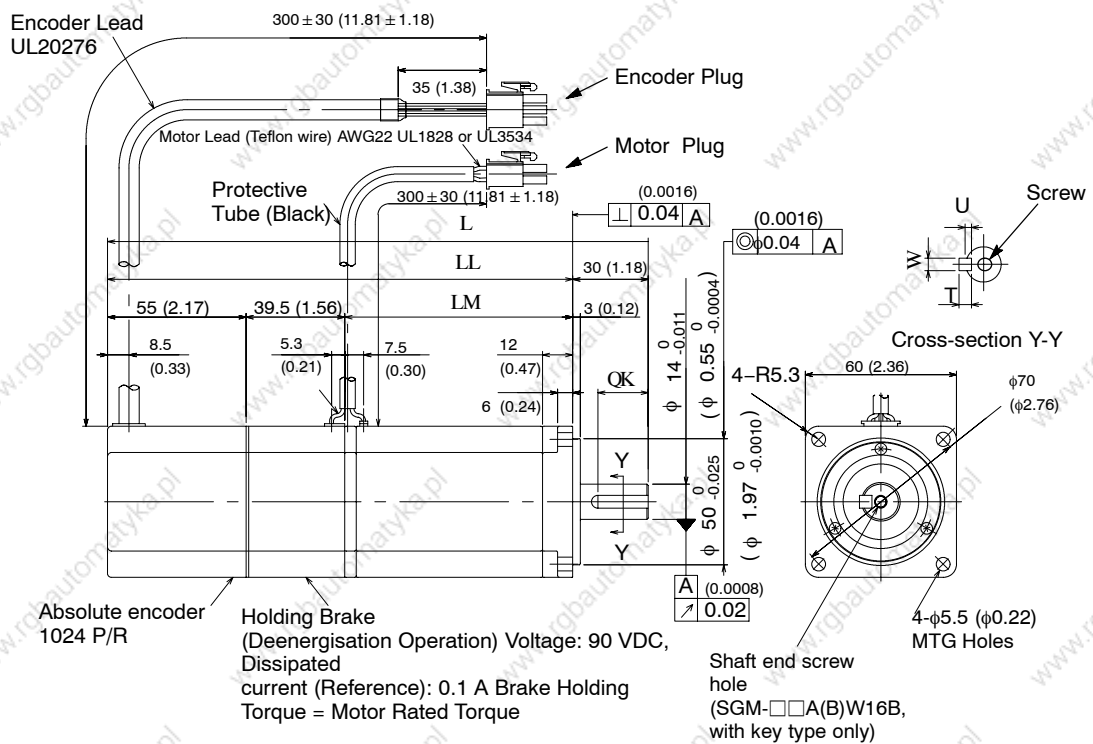

SERVO SELECTION AND DATA SHEETS

5.4.1 Servomotor Dimensional Drawings cont.

Type SGM-	L	LL	LM	QK	U	W	T	Screw dimensions	Output W (HP) (HP)	Approx. mass kg (lb)	Allowable radial load N (lb)	Allowable thrust load N (lb)
02AW12B	187.0 (7.36)	157.0 (6.18)	62.5 (2.46)	No key				-	200 (0.27)	1.7 (3.75)	245 (55.1)	74 (16.6)
02BW12B				20 (0.79)	3 (0.12)	5 (0.20)	5 (0.20)					
02AW14B												
02BW14B												
02AW16B				M5, depth 8 (0.31)								
02BW16B												
03BW12B	215.0 (8.46)	185.0 (7.28)	90.5 (3.56)	No key				-	300 (0.40)	2.3 (5.07)		
03BW14B				20 (0.79)	3 (0.12)	5 (0.20)	5 (0.20)					
03BW16B											M5, depth 8 (0.31)	
04AW12B								No key				-
04AW14B				20 (0.79)	3 (0.12)	5 (0.20)	5 (0.20)					
04AW16B								M5, depth 8 (0.31)				

- Note**
- 1) The detector uses a 12-bit absolute encoder 1024 P/R.
 - 2) Type "A" indicates 200 V specification, and type "B" indicates 100 V specification.
 - 3) "02A(B)W14B", "02A(B)W16B", "03BW14B", "03BW16B", "04AW14B" and "04AW16B" have a keyed shaft. The keyway complies with JIS B 1301-1976 (precision). A straight key is supplied.
 - 4) The quoted allowable radial load is the value at a position 25 mm (0.98 in.) from the motor mounting surface.
 - 5) The electromagnetic brake is only to hold the load in position and cannot be used to stop the motor.

• 750 W (1.01 HP)

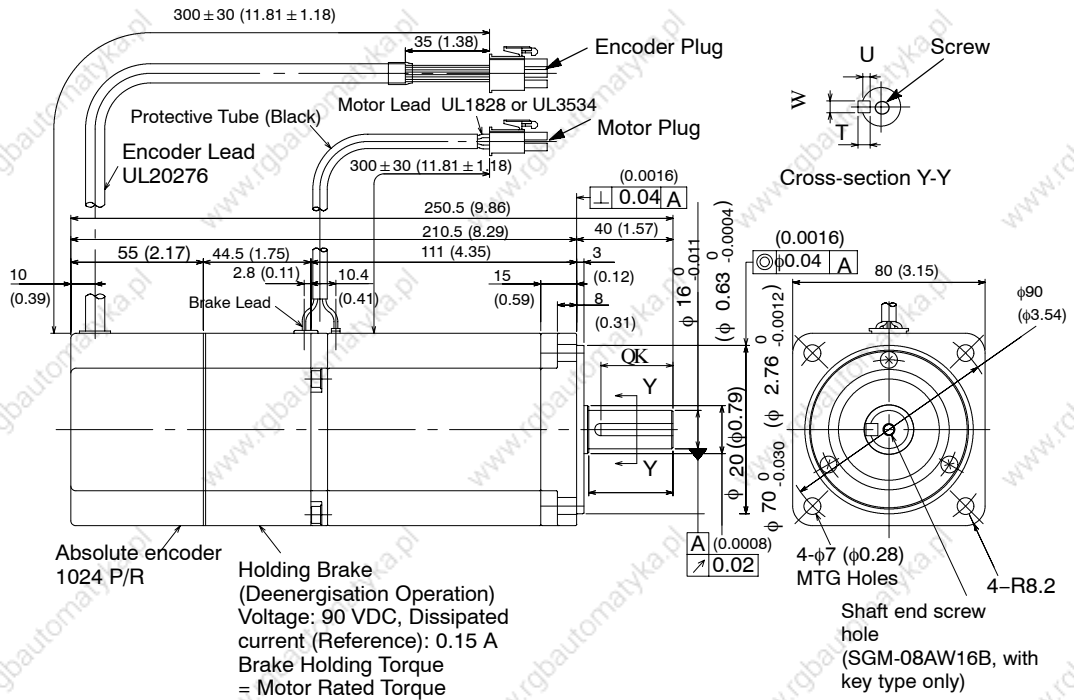

Type SGM-	QK	U	W	T	Screw dimensions (lb)	Output W (HP)	Approx. mass kg (lb)	Allowable radial load (lb)	Allowable thrust load N (lb)
08AW12B	No key				-	750 (1.01)	4.5 (9.92)	392 (88.1)	147 (33.0)
08AW14B	30 (1.18)	3 (0.12)	5 (0.20)	5 (0.20)	M5, depth 8 (0.31)				
08AW16B									

- Note**
- 1) The detector uses a 12-bit absolute encoder 1024 P/R.
 - 2) Type "A" indicates 200 V specification.
 - 3) "08AW14B" and "08AW16B" have a keyed shaft. The keyway complies with JIS B 1301-1976 (precision). A straight key is supplied.
 - 4) The quoted allowable radial load is the value at a position 35 mm (1.38 in.) from the motor mounting surface.
 - 5) The electromagnetic brake is only to hold the load in position and cannot be used to stop the motor.

SERVO SELECTION AND DATA SHEETS

5.4.1 Servomotor Dimensional Drawings cont.

- Details of Motor and Encoder Plugs (Common for 30 W (0.04 HP) to 750 W (1.01 HP))

Motor Plug



Plug : 172168-1 (AMP)
 Pin: 170360-1 or 170364-1
 (17359-1 or 170363-1: 30, 50, or
 100 W only)
 Connected to
 Cap: 172160-1
 Socket: 170362 -1 or 170366-1

Motor Wiring Specifications

1	U phase	Red
2	V phase	White
3	W phase	Blue
4	FG	Green/Yellow
5	Brake terminal	Red
6	Brake terminal	Black

Encoder Plug

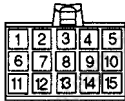

Plug: 172171-1 (AMP)
 Pin: 170359-1 or 170363-1
 Connected to
 Cap :172163-1
 Socket: 170361-1 or 170365-1

Incremental Encoder Wiring Specifications

1	A channel output	Blue
2	\bar{A} channel output	White/Blue
3	B channel output	Yellow
4	\bar{B} channel output	White/Yellow
5	Z channel output	Green
6	\bar{Z} channel output	White/Green
7	0 V (power supply)	Black
8	+5 V (power supply)	Red
9	FG (Frame Ground)	Green/Yellow
10	S channel output	Purple
11	\bar{S} channel output	White/Purple
* (12)	(Capacitor reset)	(Gray)
13	Reset	White/Gray
14	0V(battery)	White/Orange
15	3.6V(battery)	Orange

* Terminal to discharge capacitor for product dispatch. Do not use.

2) The dimensional drawings of the SGMP Servomotors are broadly grouped into the following four categories.

- a) Incremental encoder, no brake (from page 270)
- b) Incremental encoder, with brake (from page 275)
- c) Absolute encoder, no brake (from page 280)
- d) Absolute encoder, with brake (from page 284)

Motor capacities are available as 100 W (0.13 HP), 200 W (0.27 HP), 300 W (0.40 HP), 400 W (0.53 HP), 750 W (1.01 HP). These are grouped into three categories, as follows:

- 100W (0.13 HP)
- 200W (0.27 HP), 300W (0.40 HP), 400W (0.53 HP)
- 750W (1.01 HP)
- **As for the dimensional drawings of SGM servomotors, see from page 247 on.**
- **As for the dimensional drawings of TÜV approved SGM servomotors, see from the page 289 on.**
- **As for the dimensional drawings of TÜV approved SGMP servomotors, see from the page 309 on.**

SERVO SELECTION AND DATA SHEETS

5.4.1 Servomotor Dimensional Drawings cont.

(1) SGMP Servomotor
Incremental encoder, no brake (Type SGM-□□□31□)

• 100 W (0.13 HP)

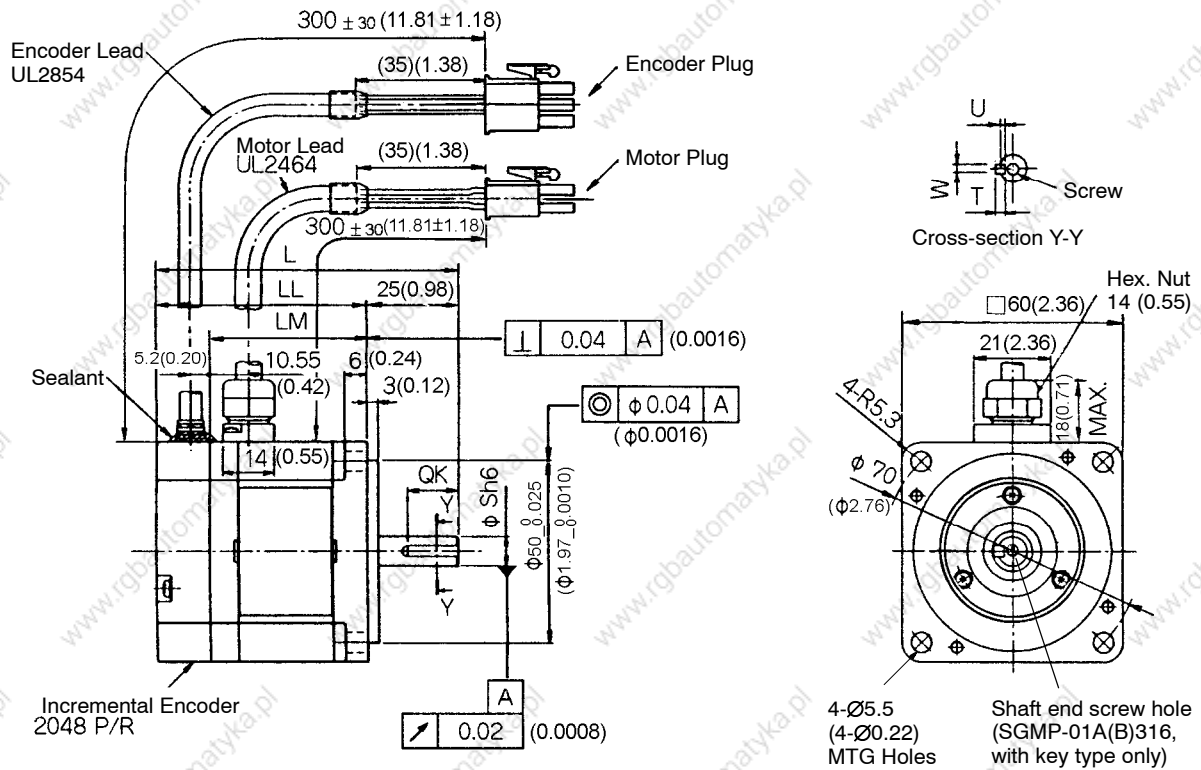

Type SGMP-	L	LL	LM	S	QK	U	W	T	Screw dimensions	Output W (HP)	Approx. mass kg (lb)	Allowable radial load N (lb)	Allowable thrust load N (lb)
01A312	82 (3.23)	57 (2.24)	42.5 (1.67)	8 (0.31)	No key				---	100 (0.13)	0.7 (1.54)	78 (17.5)	49 (11.0)
01B312													
01A314													
01B314					14 (0.55)	1.8 (0.07)	3 (0.12)	3 (0.12)					
01A316									M3, depth 6 (0.24)				
01B316													

- Note**
- 1) The detector uses an incremental encoder 2048 P/R.
 - 2) Type "A" indicates 200 V specification, and type "B" indicates 100 V specification.
 - 3) "01A(B)314" and "01A(B)316" have a keyed shaft. The keyway complies with JIS B 1301-1976 (precision). A straight key is supplied.
 - 4) The quoted allowable radial load is the value at a position 20 mm (0.79 in.) from the motor mounting surface.
 - 5) Conforms to "IP55" protective structure (except connector and output shaft faces).

• 200 W (0.27 HP), 300 W (0.40 HP), 400 W (0.53 HP)

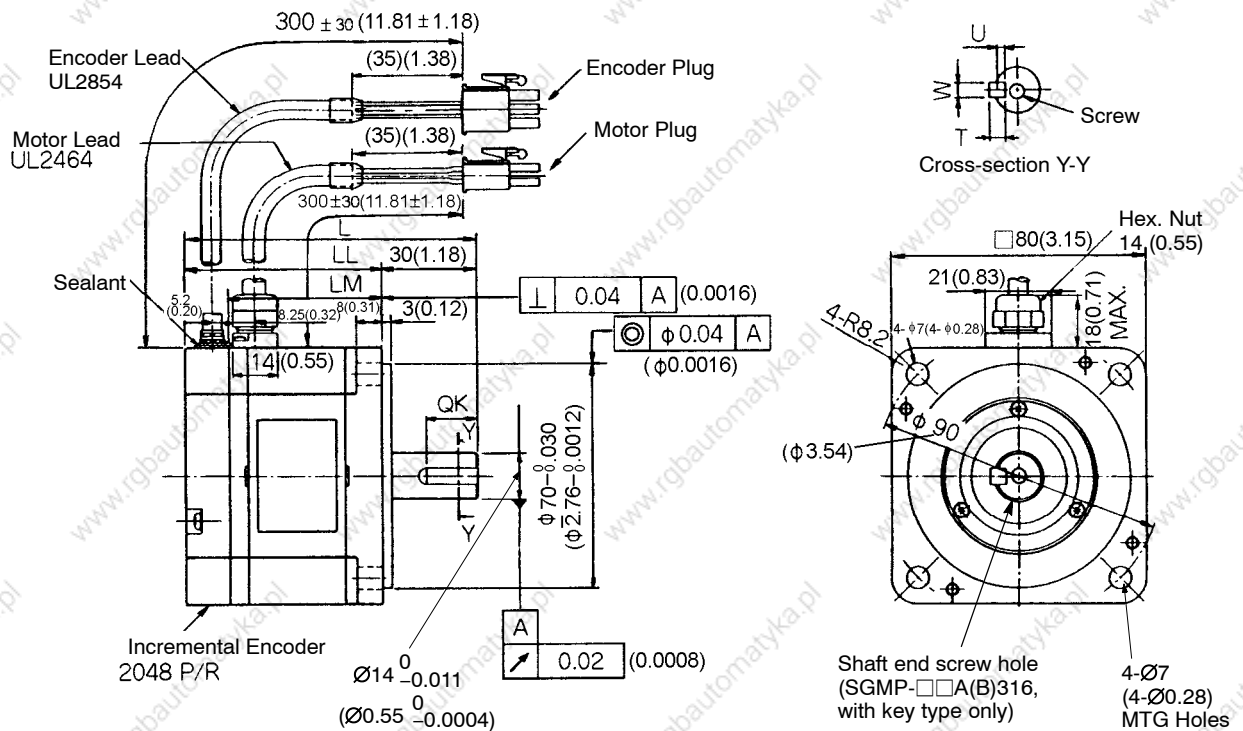

SERVO SELECTION AND DATA SHEETS

5.4.1 Servomotor Dimensional Drawings cont.

Type SGMP-	L	LL	LM	QK	U	W	T	Screw dimensions	Output W (HP)	Approx. mass kg (lb)	Allowable radial load N (lb)	Allowable thrust load N (lb)
02A312	92 (3.62)	62 (2.44)	48.1 (1.89)	No key				---	200 (0.27)	1.4 (3.09)	245 (55.1)	68 (15.3)
02B312												
02A314												
02B314				16 (0.63)	3 (0.12)	5 (0.20)	5 (0.20)					
02A316				No key				M5, depth 8 (0.31)				
02B316												
03B312	112 (4.41)	82 (3.23)	68.1 (2.68)	No key				---	300 (0.40)	2.1 (4.63)		
03B314												
03B316												
				16 (0.63)	3 (0.12)	5 (0.20)	5 (0.20)	M5, depth 8 (0.31)				
04A312				No key								
04A314				16 (0.63)	3 (0.12)	5 (0.20)	5 (0.20)	M5, depth 8 (0.31)				
04A316	No key											

- Note**
- 1) The detector uses an incremental encoder 2048 P/R.
 - 2) Type "A" indicates 200 V specification, and type "B" indicates 100 V specification.
 - 3) "02A(B)314", "02A(B)316", "04A314", "04A316", "03B314", and 03B316 have a keyed shaft. The keyway complies with JIS B 1301-1976 (precision). A straight key is supplied.
 - 4) The quoted allowable radial load is the value at a position 25 mm (0.98 in.) from the motor mounting surface.
 - 5) Conforms to "IP55" protective structure (except connector and output shaft faces).

• 750 W (1.01 HP)

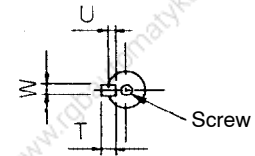
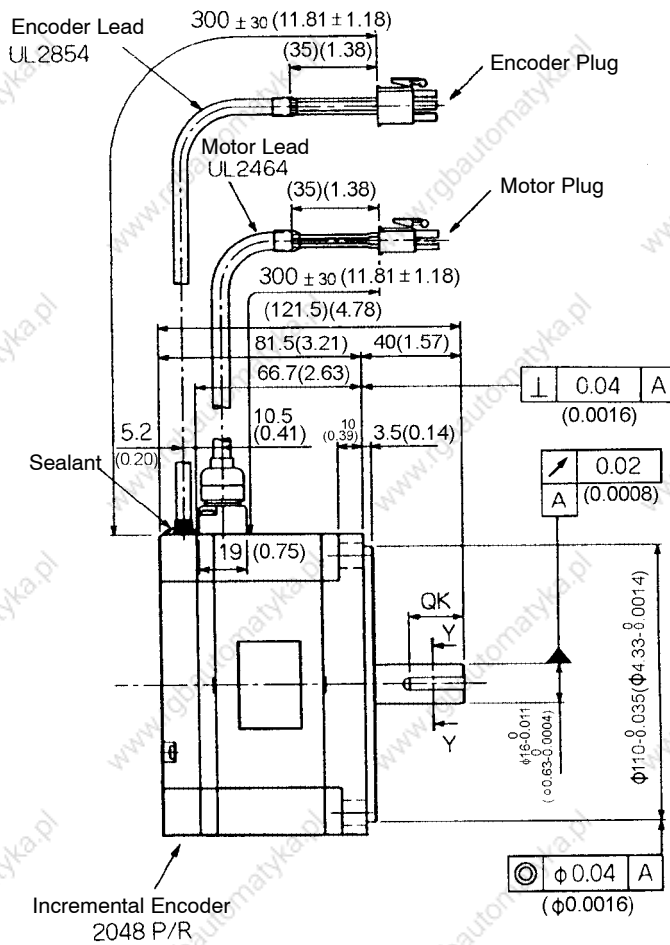

Cross-section Y-Y

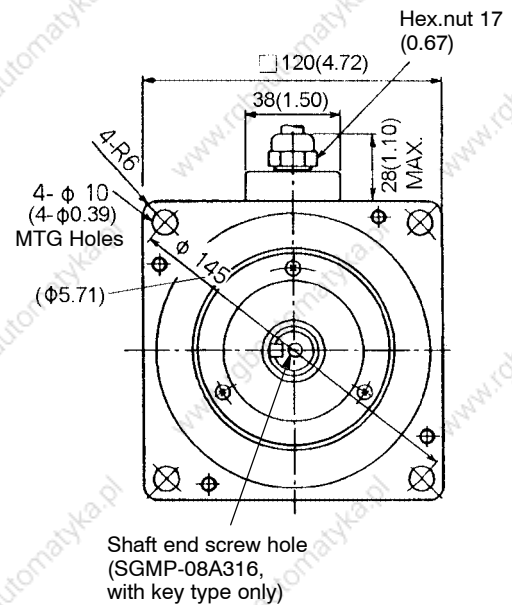

Type SGMP-	QK	U	W	T	Screw dimensions	Output W (HP)	Approx. mass kg (lb)	Allowable radial load N (lb)	Allowable thrust load N (lb)
08A312	No key				---	750 (1.01)	4.2 (9.26)	392 (88.1)	147 (33.0)
08A314	22 (0.87)	3 (0.12)	5 (0.20)	5 (0.20)	M5, depth 8 (0.31)				
08A316									

- Note**
- 1) The detector uses an incremental encoder 2048 P/R.
 - 2) Type "A" indicates 200 V specification.
 - 3) "08A314" and "08A316" have a keyed shaft. The keyway complies with JIS B 1301-1976 (precision). A straight key is supplied.
 - 4) The quoted allowable radial load is the value at a position 35 mm (1.38in.) from the motor mounting surface.
 - 5) Conforms to IP55 protective structure (except connector and output shaft faces).

SERVO SELECTION AND DATA SHEETS

5.4.1 Servomotor Dimensional Drawings cont.

- Details of Motor and Encoder Plugs (Common for 100 W (0.13HP) to 750 W (1.01HP))

Motor Plug



Plug : 172167-1 (AMP)
Pin: 170360-1 or 170364-1

Connected to
Cap 172159-1
Socket 170362-1 or 170366-1

Encoder Plug



Plug: 172169-1 (AMP)
Pin: 170359-1 or 170363-1

Connected to
Cap :172161-1
Socket: 170361-1 or 170365-1

Motor Wiring Specifications

1	U phase	Red
2	V phase	White
3	W phase	Blue
4	FG	Green/Yellow

Incremental Encoder Wiring Specifications

1	A channel output	Blue
2	\bar{A} channel output	Blue/Black
3	B channel output	Yellow
4	\bar{B} channel output	Yellow/Black
5	C channel output	Green
6	\bar{C} channel output	Green/Black
7	0 V (power supply)	Gray
8	+5 V (power supply)	Red
9	FG (Frame Ground)	Orange

(2) SGMP Servomotor
Incremental encoder, with brake (Type SGMP-□□□31□B)

• 100 W (0.13HP)

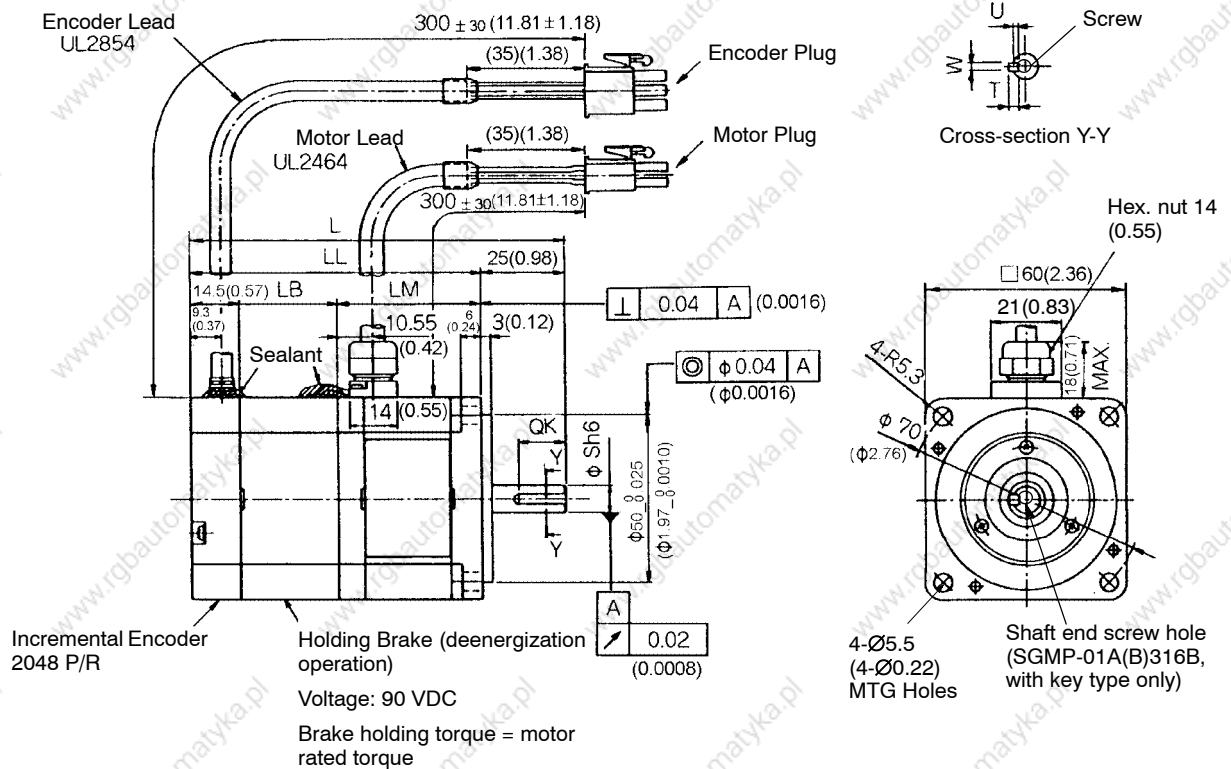

Type SGMP-	L	LL	LM	LB	S	QK	U	W	T	Screw dimensions	Output W (HP)	Approx. mass kg (lb)	Allowable radial load N (lb)	Allowable thrust load N (lb)
01A312B	111	86	42.5	29	8	No key				---	100 (0.13)	0.9 (1.98)	78 (17.5)	49 (11.0)
01B312B	(4.37)	(3.39)	(1.67)	(1.14)	(0.31)									
01A314B						14	1.8	3	3	M3, depth 6 (0.24)				
01B314B						(0.55)	(0.07)	(0.12)	(0.12)					
01A316B														
01B316B														

- Note**
- 1) The detector uses an incremental encoder 2048 P/R.
 - 2) Type "A" indicates 200 V specification, and type "B" indicates 100V specification.
 - 3) "01A(B)314B" and "01A(B)316B" have a keyed shaft. The keyway complies with JIS B 1301-1976 (precision). A straight key is supplied.

SERVO SELECTION AND DATA SHEETS

5.4.1 Servomotor Dimensional Drawings cont.

- 4) The quoted allowable radial load is the value at a position 20 mm (0.79in.) from the motor mounting surface.
- 5) The electromagnetic brake is only to hold the load in position and cannot be used to stop the motor.
- 6) Conforms to IP55 protective structure (except connector and output shaft faces).

• 200 W (0.27HP), 300W (0.40 HP), 400 W (0.53HP)

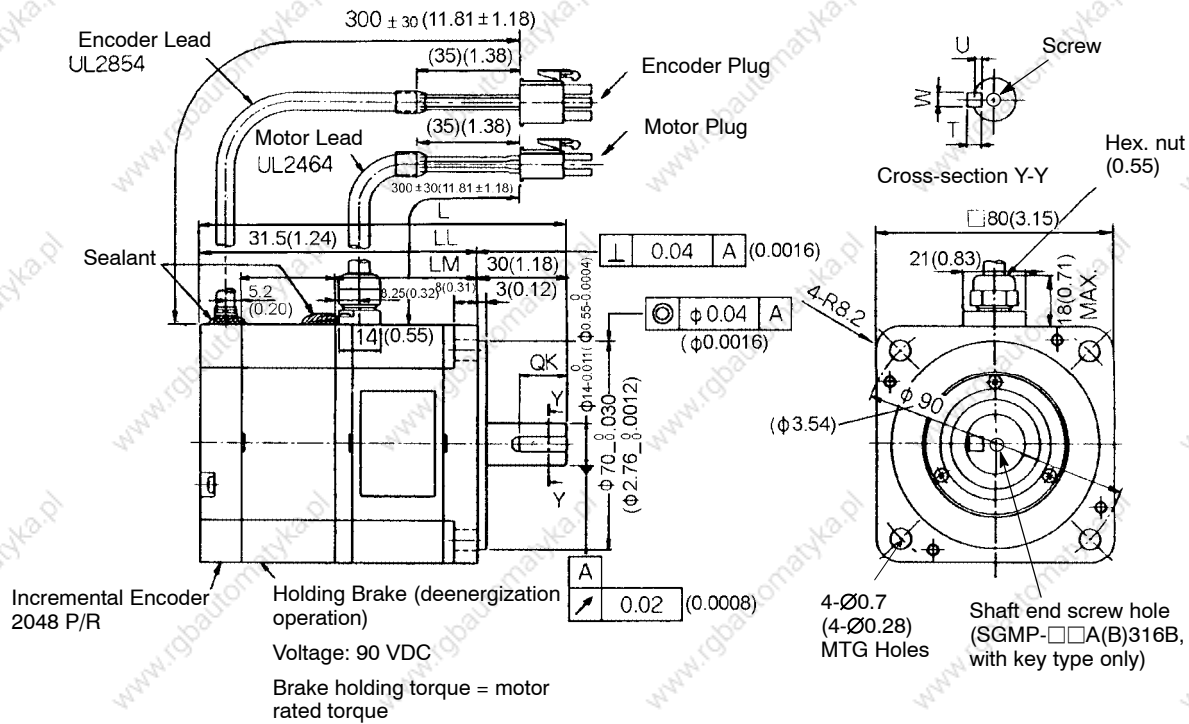

5

Type SGMP-	L	LL	LM	QK	U	W	T	Screw dimensions	Output W (HP)	Approx. mass kg (lb)	Allowable radial load N (lb)	Allowable thrust load N (lb)		
02A312B	123.5 (4.86)	93.5 (3.68)	48.1 (1.89)	No key				---	200 (0.27)	1.9 (4.19)	245 (55.1)	68 (15.3)		
02B312B				16 (0.63)	3 (0.12)	5 (0.20)	5 (0.20)							
02A314B														
02B314B				M5, depth 8 (0.31)										
02A316B														
02B316B														
03B312B	143.5 (5.65)	113.5 (4.47)	68.1 (2.68)	No key				---	300 (0.40)	2.6 (5.73)				
03B314B				16 (0.63)	3 (0.12)	5 (0.20)	5 (0.20)							
03B316B													M5, depth 8 (0.31)	
04A312B				No key				---						400 (0.53)
04A314B				16 (0.63)	3 (0.12)	5 (0.20)	5 (0.20)							
04A316B													M5, depth 8 (0.31)	

- Note**
- 1) The detector uses an incremental encoder 2048 P/R.
 - 2) Type "A" indicates 200 V specification, and type "B" indicates 100V specification.
 - 3) "02A(B)314B", "02A(B)316B", "03B314B", "03B316B", "04A314B" and "04A316B" have a keyed shaft. The keyway complies with JIS B 1301-1976 (precision). A straight key is supplied.
 - 4) The quoted allowable radial load is the value at a position 25 mm (0.98in.) from the motor mounting surface.
 - 5) The electromagnetic brake is only to hold the load in position and cannot be used to stop the motor.
 - 6) Conforms to IP55 protective structure (except connector and output shaft faces).

SERVO SELECTION AND DATA SHEETS

5.4.1 Servomotor Dimensional Drawings cont.

• 750 W (1.01HP)

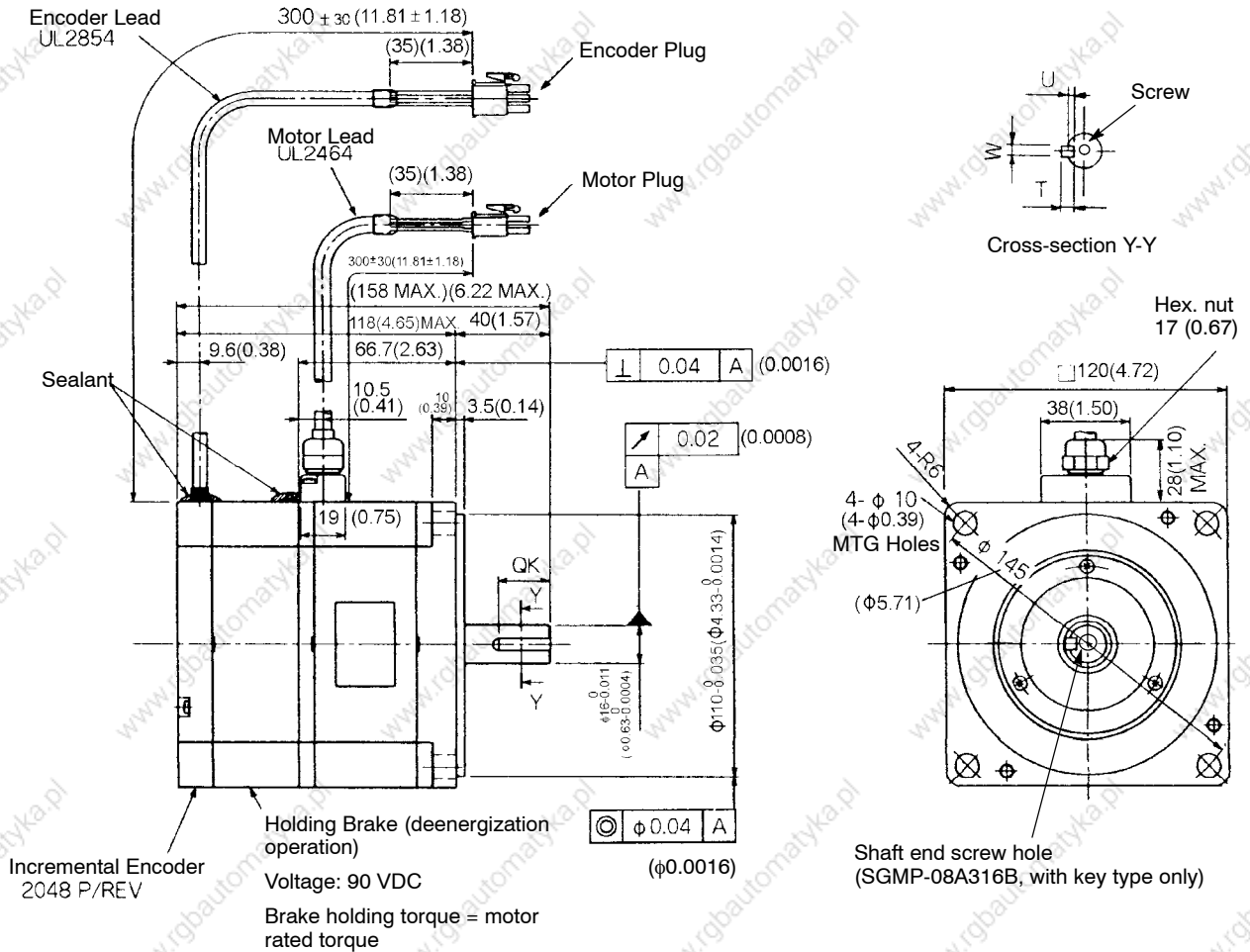

Type SGMP-	QK	U	W	T	Screw dimensions	Output W (HP)	Approx. mass kg (lb)	Allowable radial load N (lb)	Allowable thrust load N (lb)
08A312B	No key				-	750 (1.01)	6.1 (13.45)	392 (88.1)	147 (33.0)
08A314B	22 (0.87)	3 (0.12)	5 (0.20)	5 (0.20)	M5, depth 8 (0.31)				
08A316B									

Note 1) The detector uses an incremental encoder 2048 P/R.

2) Type "A" indicates 200 V specification.

3) "08A314B" and "08A316B" have a keyed shaft. The keyway complies with JIS B 1301-1976 (precision). A straight key is supplied.

- 4) The quoted allowable radial load is the value at a position 35 mm (1.38 in.) from the motor mounting surface.
- 5) The electromagnetic brake is only to hold the load in position and cannot be used to stop the motor.
- 6) Conforms to IP55 protective structure (except connector and output shaft faces).

- Details of Motor and Encoder Plugs (Common for 100 W (0.13 HP) to 750 W (1.01 HP))

Motor Plug



Plug : 172168-1 (AMP)
Pin : 170360-1 or 170364-1
Connected to
Cap 172160-1
Socket 170362-1 or 170366-1

Encoder Plug



Plug: 172169-1 (AMP)
Pin: 170359-1 or 170366-1
Connected to
Cap :172161-1
Socket: 170361-1 or 170365-1

Motor Wiring Specifications

1	U phase	Red
2	V phase	White
3	W phase	Blue
4	FG	Green/Yellow
5	Brake terminal	Black
6	Brake terminal	Black

Incremental Encoder Wiring Specifications

1	A channel output	Blue
2	\bar{A} channel output	Blue/Black
3	B channel output	Yellow
4	\bar{B} channel output	Yellow/Black
5	C channel output	Green
6	\bar{C} channel output	Green/Black
7	0 V (power supply)	Gray
8	+5 V (power supply)	Red
9	FG (Frame Ground)	Orange

SERVO SELECTION AND DATA SHEETS

5.4.1 Servomotor Dimensional Drawings cont.

(3) SGMP Servomotor Absolute encoder, no brake (Type SGMP-□□□W1□)

• 100 W (0.13HP)

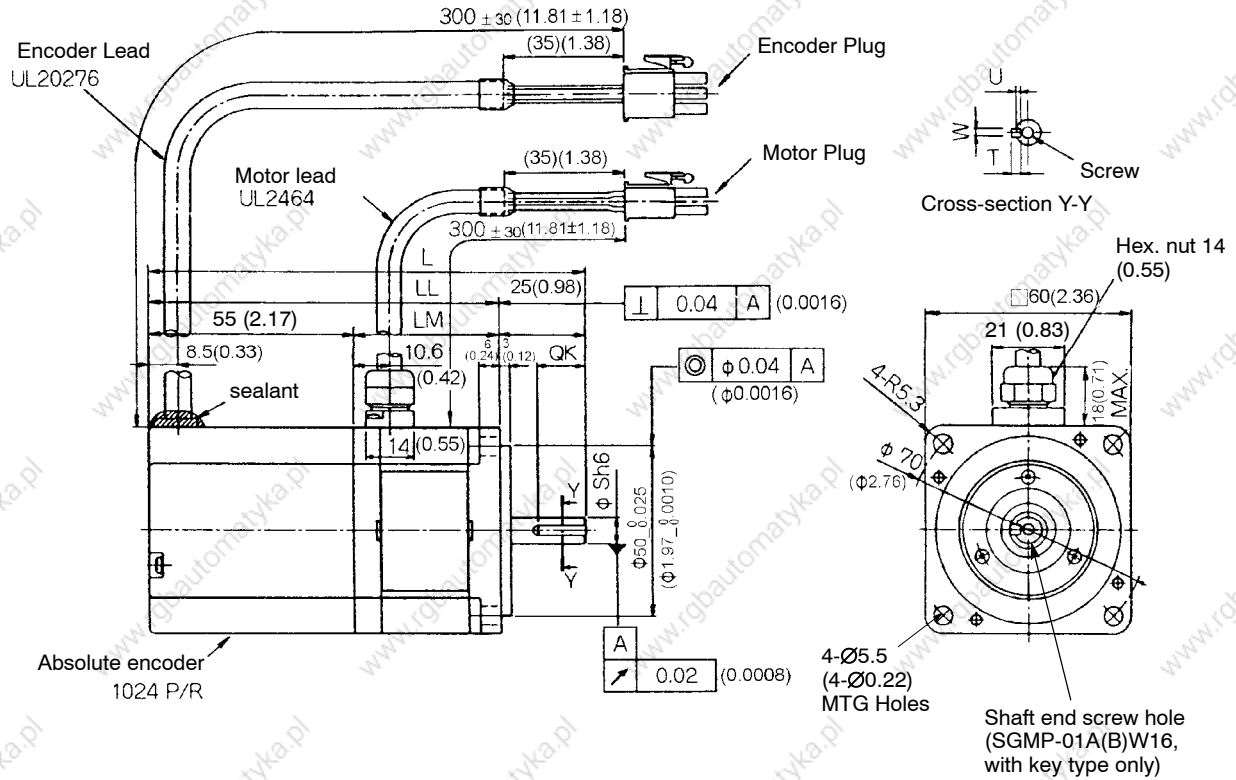

5

Type SGMP-	L	LL	LM	S	QK	U	W	T	Screw dimensions	Output W (HP)	Approx. mass kg (lb)	Allowable radial load N (lb)	Allowable thrust load N (lb)
01AW12	122.5	97.5	42.5	8	No key				---	100 (0.13)	0.9 (1.98)	78 (17.5)	49 (11.0)
01BW12	(4.82)	(3.84)	(1.67)	(0.31)									
01AW14					14	1.8	3	3					
01BW14					(0.55)	(0.07)	(0.12)	(0.12)					
01AW16								M3, depth 6					
01BW16								(0.24)					

- Note**
- 1) The detector uses a 12-bit absolute encoder 1024 P/R.
 - 2) Type "A" indicates 200 V specification, and type "B" indicates 100 V specification.
 - 3) "01A(B)W14" and "01A(B)W16" have a keyed shaft. The keyway complies with JIS B 1301-1976 (precision). A straight key is supplied.
 - 4) The quoted allowable radial load is the value at a position 20 mm (0.79 in.) from the motor mounting surface.
 - 5) Conforms to IP55 protective structure (except connector and output shaft faces).

• 200 W (0.27 HP), 300 W (0.40 HP) (100 V only), 400 W (0.53HP) (200 V only)

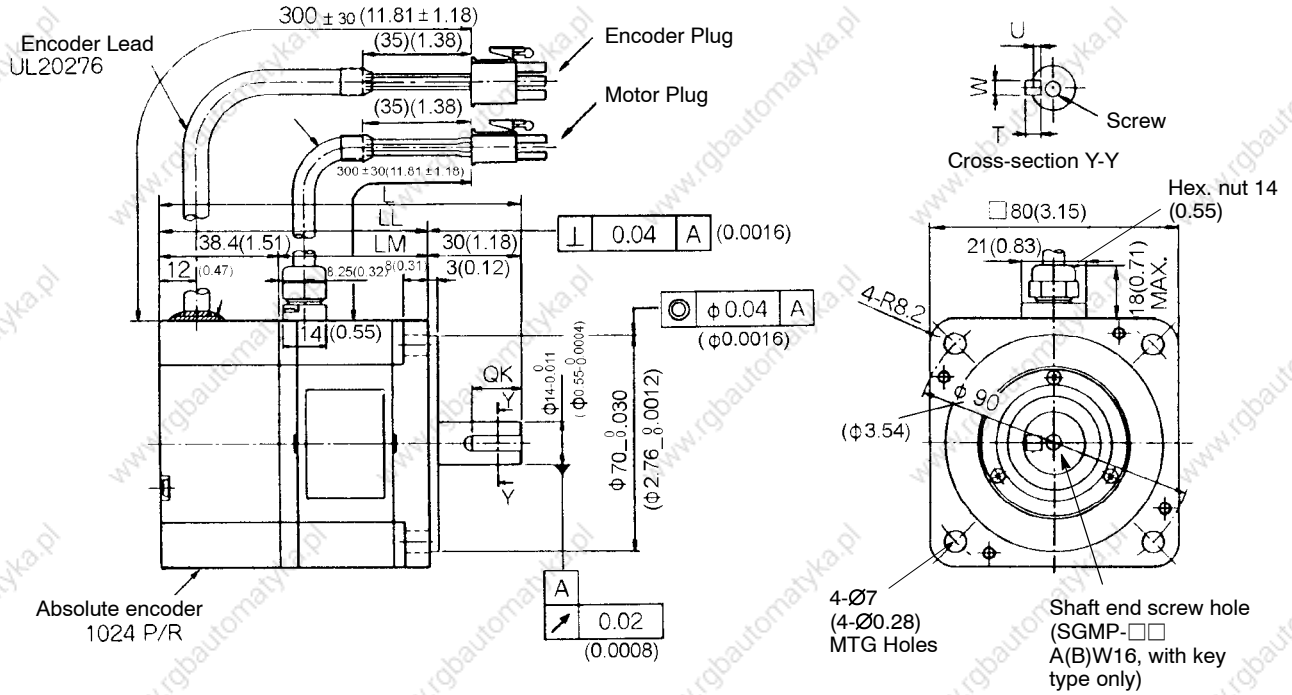

Type SGMP-	L	LL	LM	QK	U	W	T	Screw dimensions	Output W (HP)	Approx. mass kg (lb)	Allowable radial load N (lb)	Allowable thrust load N (lb)	
02AW12	116.5 (4.59)	86.5 (3.41)	48.1 (1.89)	No key				---	M5, depth 8 (0.31)	200 (0.27)	1.6 (3.53)	245 (55.1)	68 (15.3)
02BW12													
02AW14				16 (0.63)	3 (0.12)	5 (0.20)	5 (0.20)						
02BW14													
02AW16													
02BW16													
03BW12	136.5 (5.37)	106.5 (4.19)	68.1 (2.68)	No key				---	M5, depth 8 (0.31)	300 (0.40)	2.3 (5.07)		
03BW14				16 (0.63)	3 (0.12)	5 (0.20)	5 (0.20)						
03BW16													
04AW12				No key				---	M5, depth 8 (0.31)	400 (0.53)			
04AW14				16 (0.63)	3 (0.12)	5 (0.20)	5 (0.20)						
04AW16													

Note 1) The detector uses a 12-bit absolute encoder 1024 P/R.

2) Type "A" indicates 200 V specification, and type "B" indicates 100 V specification.

SERVO SELECTION AND DATA SHEETS

5.4.1 Servomotor Dimensional Drawings cont.

- 3) "02A(B)W14", "02A(B)W16", "03BW14", "03BW16", "04AW14", and "04AW16" have a keyed shaft. The keyway complies with JIS B 1301-1976 (precision). A straight key is supplied.
- 4) The quoted allowable radial load is the value at a position 25 mm (0.98 in.) from the motor mounting surface.
- 5) Conforms to IP55 protective structure (except connector and output shaft faces).

• 750 W (1.01HP)

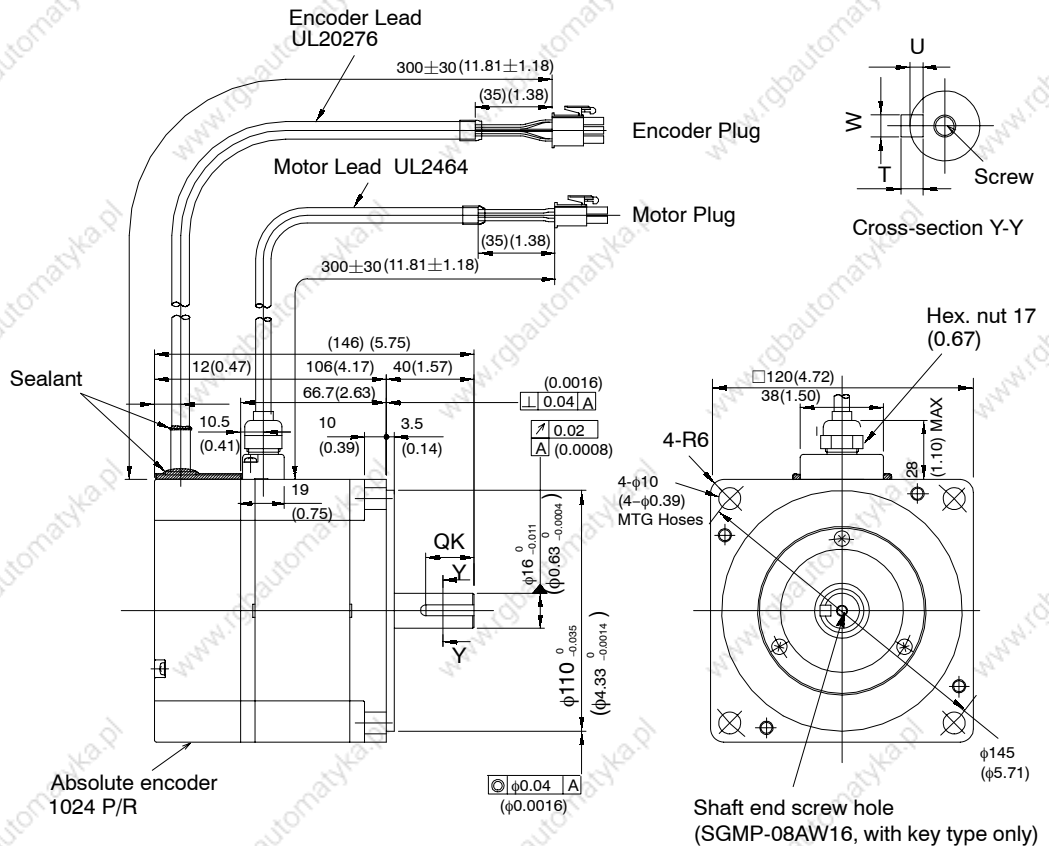

Type SGMP-	QK	U	W	T	Screw dimensions	Output W (HP)	Approx. mass kg (lb)	Allowable radial load N (lb)	Allowable thrust load N (lb)
08AW12	No key				M5, depth 8 (0.31)	750 (1.01)	4.8 (10.58)	392 (88.1)	147 (33.0)
08AW14	22 (0.87)	3 (0.12)	5 (0.20)	5 (0.20)					
08AW16									

- Note**
- 1) The detector uses a 12-bit absolute encoder 1024 P/R.
 - 2) Type “A” indicates 200 V specification.
 - 3) “08AW14” and “08AW16” have a keyed shaft. The keyway complies with JIS B 1301-1976 (precision). A straight key is supplied.
 - 4) The quoted allowable radial load is the value at a position 35 mm (1.38 in.) from the motor mounting surface.
 - 5) Conforms to IP55 protective structure (except connector and output shaft faces).

• Details of Motor and Encoder Plugs (Common for 100 W (0.13 HP) to 750 W (1.01 HP))

Motor Plug



Plug : 172167-1 (AMP)
Pin 170360-1 or 170364-1
Connected to
Cap 172159-1
Socket 170362-1 or 170366-1

Motor Wiring Specifications

1	U phase	Red
2	V phase	White
3	W phase	Blue
4	FG	Green/Yellow

Encoder Plug

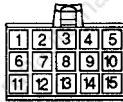

Plug: 172171-1 (AMP)
Pin: 170359-1 or 170363-1
Connected to
Cap :172163-1
Socket: 170361-1 or 170365-1

Absolute Encoder Wiring Specifications

1	A channel output	Blue
2	\bar{A} channel output	White/Blue
3	B channel output	Yellow
4	\bar{B} channel output	White/Yellow
5	Z channel output	Green
6	\bar{Z} channel output	White/Green
7	0 V (power supply)	Black
8	+5 V (power supply)	Red
9	FG (Frame Ground)	Green/Yellow
10	S channel output	Purple
11	\bar{S} channel output	White/Purple
* (12)	(Capacitor reset)	(Gray)
13	Reset	White/Gray
14	0V(battery)	White/Orange
15	3.6V(battery)	Orange

* Terminal to discharge capacitor for product dispatch.
Do not use.

SERVO SELECTION AND DATA SHEETS

5.4.1 Servomotor Dimensional Drawings cont.

(4) SGMP Servomotor

Absolute encoder, with brake (Type SGMP-□□□W1□B)

• 100 W (0.13 HP)

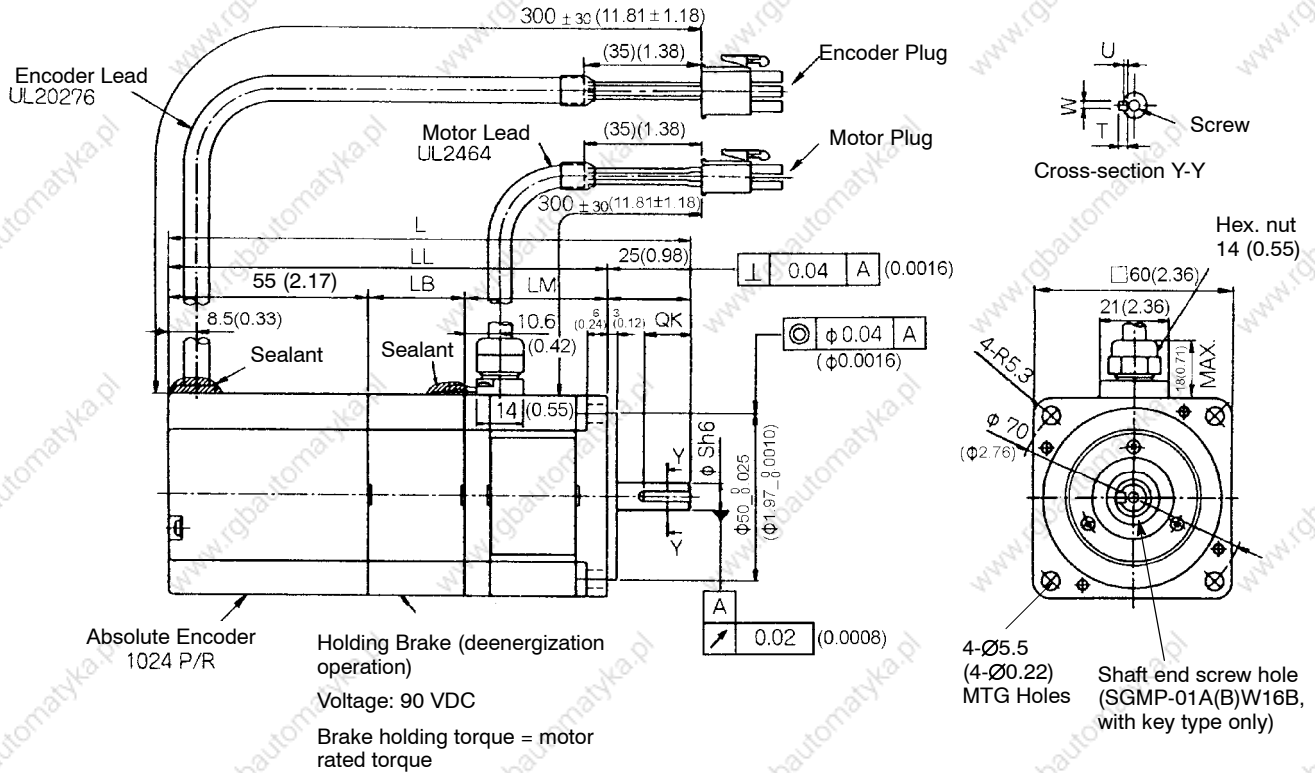

Type SGMP-	L	LL	LM	LB	S	QK	U	W	T	Screw dimensions	Output W (HP)	Approx. mass kg (lb)	Allowable radial load N (lb)	Allowable thrust load N (lb)
01AW12B	151.5 (5.96)	126.5 (4.98)	42.5 (1.67)	29 (1.14)	8 (0.31)	No key				---	100 (0.13)	1.2 (2.65)	78 (17.5)	49 (11.0)
01BW12B														
01AW14B						14 (0.55)	1.8 (0.07)	3 (0.12)	3 (0.12)					
01BW14B														
01AW16B														
01BW16B														

- Note**
- 1) The detector uses a 12-bit absolute encoder 1024 P/R.
 - 2) Type “A” indicates 200 V specification, and type “B” indicates 100 V specification.
 - 3) “01A(B)W14B” and “01A(B)W16B” have a keyed shaft. The keyway complies with JIS B 1301-1976 (precision). A straight key is supplied.
 - 4) The quoted allowable radial load is the value at a position 20 mm (0.79 in.) from the motor mounting surface.
 - 5) The electromagnetic brake is only to hold the load in position and cannot be used to stop the motor.
 - 6) Conforms to IP55 protective structure (except connector and output shaft faces).

SERVO SELECTION AND DATA SHEETS

5.4.1 Servomotor Dimensional Drawings cont.

- 200 W (0.27 HP), 300 W (0.40 HP), 400 W (0.53 HP)

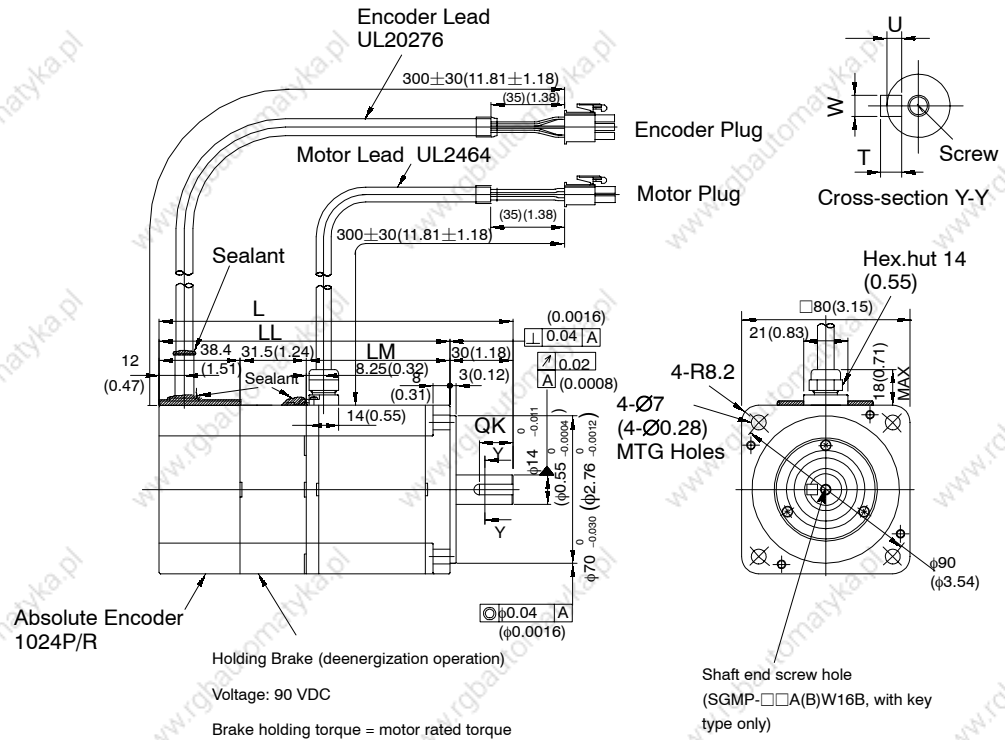

Type SGMP-	L	LL	LM	QK	U	W	T	Screw dimensions	Output W (HP)	Approx. mass kg (lb)	Allowable radial load N (lb)	Allowable thrust load N (lb)
02AW12B	148 (5.83)	118 (4.65)	48.1 (1.89)	No key				M5, depth 8 (0.31)	200 (0.27)	2.3 (5.07)	245 (55.1)	68 (15.3)
02BW12B												
02AW14B				16 (0.63)	3 (0.12)	5 (0.20)	5 (0.20)					
02BW14B												
02AW16B												
02BW16B												
03BW12B	168 (6.61)	138 (5.43)	68.1 (2.68)	No key				M5, depth 8 (0.31)	300 (0.40)	3.0 (6.61)	245 (55.1)	68 (15.3)
03BW14B				16 (0.63)	3 (0.12)	5 (0.20)	5 (0.20)					
03BW16B												
04AW12B	168 (6.61)	138 (5.43)	68.1 (2.68)	No key				M5, depth 8 (0.31)	400 (0.53)	3.0 (6.61)	245 (55.1)	68 (15.3)
04AW14B				16 (0.63)	3 (0.12)	5 (0.20)	5 (0.20)					
04AW16B												

Note 1) The detector uses a 12-bit absolute encoder 1024 P/R.

2) Type "A" indicates 200 V specification, and type "B" indicates 100 V specification.

- 3) "02A(B)W14B", "02A(B)W16B", "03BW14B", "03BW16B", "04AW14B" and "04AW16B" have a keyed shaft. The keyway complies with JIS B 1301-1976 (precision). A straight key is supplied.
- 4) The quoted allowable radial load is the value at a position 25 mm (0.98 in.) from the motor mounting surface.
- 5) The electromagnetic brake is only to hold the load in position and cannot be used to stop the motor.
- 6) Conforms to IP55 protective structure (except connector and output shaft faces).

• 750 W (1.01 HP)

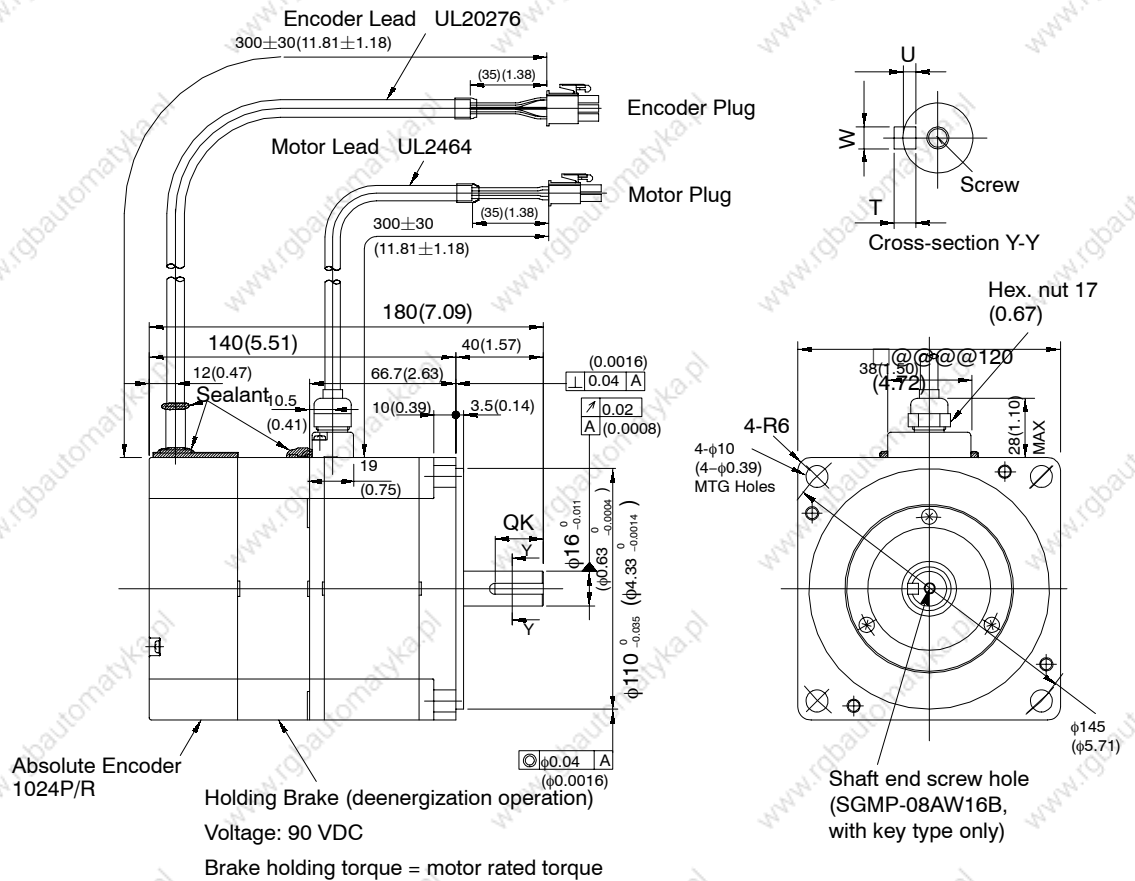

Type SGMP-	QK	U	W	T	Screw dimensions	Output W (HP)	Approx. mass kg (lb)	Allowable radial load N (lb)	Allowable thrust load N (lb)
08AW12B	No key				-	750 (1.01)	6.2 (13.67)	392 (88.1)	147 (33.0)
08AW14B	22 (0.87)	3 (0.12)	5 (0.20)	5 (0.20)	M5, depth 8 (0.31)				
08AW16B									

SERVO SELECTION AND DATA SHEETS

5.4.1 Servomotor Dimensional Drawings cont.

- Note**
- 1) The detector uses a 12-bit absolute encoder 1024 P/R.
 - 2) Type "A" indicates 200 V specification.
 - 3) "08AW14B" and "08AW16B" have a keyed shaft. The keyway complies with JIS B 1301-1976 (precision). A straight key is supplied.
 - 4) The quoted allowable radial load is the value at a position 35 mm (1.38 in) from the motor mounting surface.
 - 5) The electromagnetic brake is only to hold the load in position and cannot be used to stop the motor.
 - 6) Conforms to IP55 protective structure (except connector and output shaft faces).

- Details of Motor and Encoder Plugs (Common for 100W (0.13 HP) to 750 W (1.01 HP))

Motor Plug



Plug : 172168-1 (AMP)
 Pin 170360-1 or 170364-1(1 to 4pin)
 170359-1 or 170363 (5 to 6 pin)
 (17360-1 or 17364-1:only 750W)
 Connected to
 Cap 172160-1
 Socket 170362-1 or 170366-1

Motor Wiring Specifications

1	U phase	Red
2	V phase	White
3	W phase	Blue
4	FG	Green/Yellow
5	Brake terminal	Black
6	Brake terminal	Black

Encoder Plug

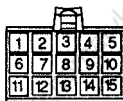

Plug: 172171-1 (AMP)
 Pin: 170359-1 or 170363-1
 Connected to
 Cap :172163-1
 Socket: 170361-1 or 170365-1

Absolute Encoder Wiring Specifications

1	A channel output	Blue
2	\bar{A} channel output	White/Blue
3	B channel output	Yellow
4	\bar{B} channel output	White/Yellow
5	Z channel output	Green
6	\bar{Z} channel output	White/Green
7	0 V (power supply)	Black
8	+5 V (power supply)	Red
9	FG (Frame Ground)	Green/Yellow
10	S channel output	Purple
11	\bar{S} channel output	White/Purple
* (12)	(Capacitor reset)	(Gray)
13	Reset	White/Gray
14	0V(battery)	White/Orange
15	3.6V(battery)	Orange

- * Terminal to discharge capacitor for product dispatch.
 Do not use.

5.4.2 Servomotor Dimensional Drawings (TÜV approved, conforming to the machine instructions)

1) The dimensional drawings of TÜV approved SGM Servomotors (conforming to the machine instructions) are broadly grouped into the following four categories.

- a) Incremental encoder, no brake (from page 290)
- b) Incremental encoder, with brake (from page 294)
- c) Absolute encoder, no brake (from page 299)
- d) Absolute encoder, with brake (from page 304)

Motor capacities are available as 30 W (0.04 HP), 50 W (0.07 HP), 100 W (0.13 HP), 200 W (0.27 HP), 300 W (0.40 HP), 400 W (0.53 HP), 750 W (1.01 HP). These are grouped into three categories, as follows:

- 30W (0.04 HP), 50W (0.07 HP), 100W (0.13 HP)
- 200W (0.27 HP), 300W (0.40 HP), 400W (0.53 HP)
- 750W (1.01 HP)
- **As for the dimensional drawings of SGM servomotors, see from the page 247 on.**
- **As for the dimensional drawings of SGMP servomotors, see from the page 269 on.**
- **As for the dimensional drawings of TÜV approved SGMP servomotors, see from the page 309 on.**

All drawings conform to the machine instructions. As for the motor drawings conforming to the EMC instructions, encoder plug and its accessories are different. For details, contact your Yaskawa representative.

SERVO SELECTION AND DATA SHEETS

5.4.2 Servomotor Dimensional Drawings cont.

(1) TÜV approved (conforming to the machine instructions) SGM Servomotor Incremental encoder, no brake (Type SGM-□□□31□)

- 30W (0.04 HP), 50W (0.07 HP), 100W (0.13 HP)

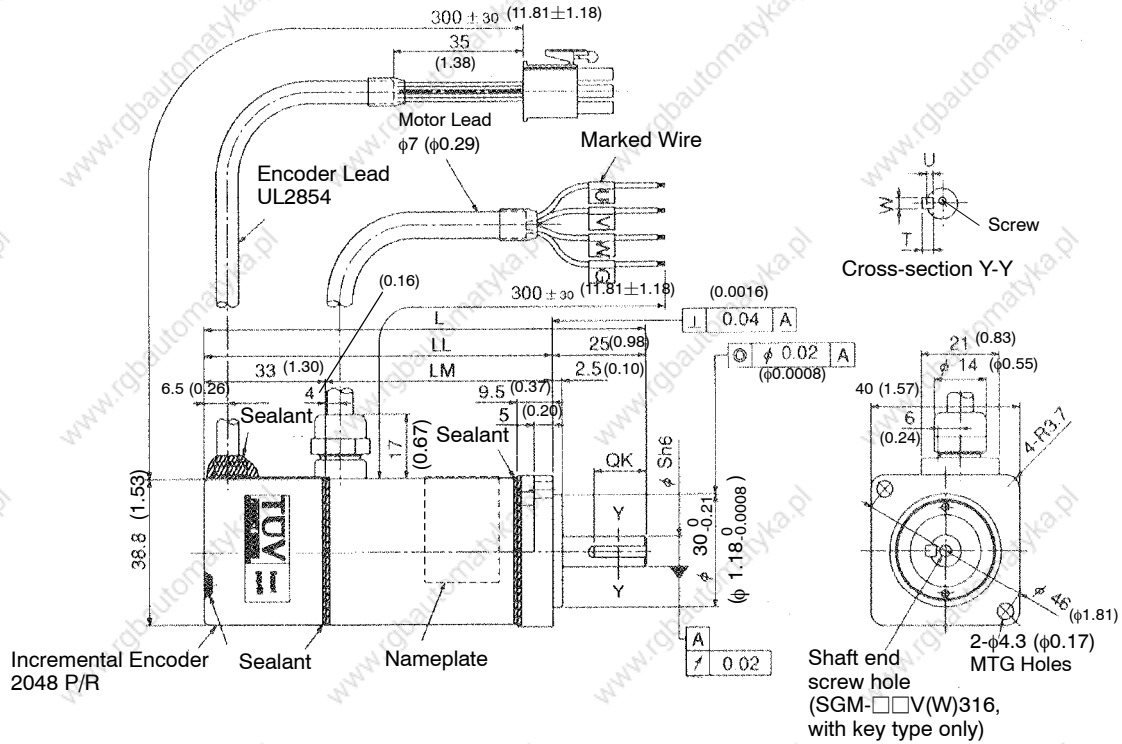

5

Type SGM-	L	LL	LM	S	QK	U	W	T	Screw dimensions	Output W (HP)	Approx. mass kg (lb)	Allowable radial load N (lb)	Allowable thrust load N (lb)
A3V312	94.5 (3.72)	69.5 (2.74)	36.5 (1.44)	6 (0.24)	No key				-	30 (0.04)	0.3 (0.66)	68 (15.3)	54 (12.1)
A3W312													
A3V314					14 (0.55)	1.2 (0.05)	2 (0.08)	2 (0.08)					
A3W314													
A3V316													
A3W316													
A5V312	102.0 (4.02)	77.0 (3.03)	44.0 (1.73)	6 (0.24)	No key				-	50 (0.07)	0.4 (0.88)		
A5W312													
A5V314					14 (0.55)	1.2 (0.05)	2 (0.08)	2 (0.08)					
A5W314													
A5V316													
A5W316													
01V312	119.5 (4.70)	94.5 (3.72)	61.5 (2.42)	8 (0.31)	No key				-	100 (0.13)	0.5 (1.10)	78 (17.5)	
01W312													
01V314					14 (0.55)	1.8 (0.07)	3 (0.12)	3 (0.12)					
01W314													
01V316													
01W316													

- Note**
- 1) The detector uses an incremental encoder 2048 P/R.
 - 2) Type “V” indicates 200 V specification, and type “W” indicates 100 V specification.
 - 3) “A3V(W)314”, “A3V(W)316”, “A5V(W)314”, “A5V(W)316”, “01V(W)314” and “01V(W)316” have a keyed shaft. The keyway complies with JIS B 1301-1976 (precision). A straight key is supplied.
 - 4) The quoted allowable radial load is the value at a position 20 mm (0.79 in.) from the motor mounting surface.

- 200 W (0.27 HP), 300 W (0.40 HP), 400 W (0.53 HP)

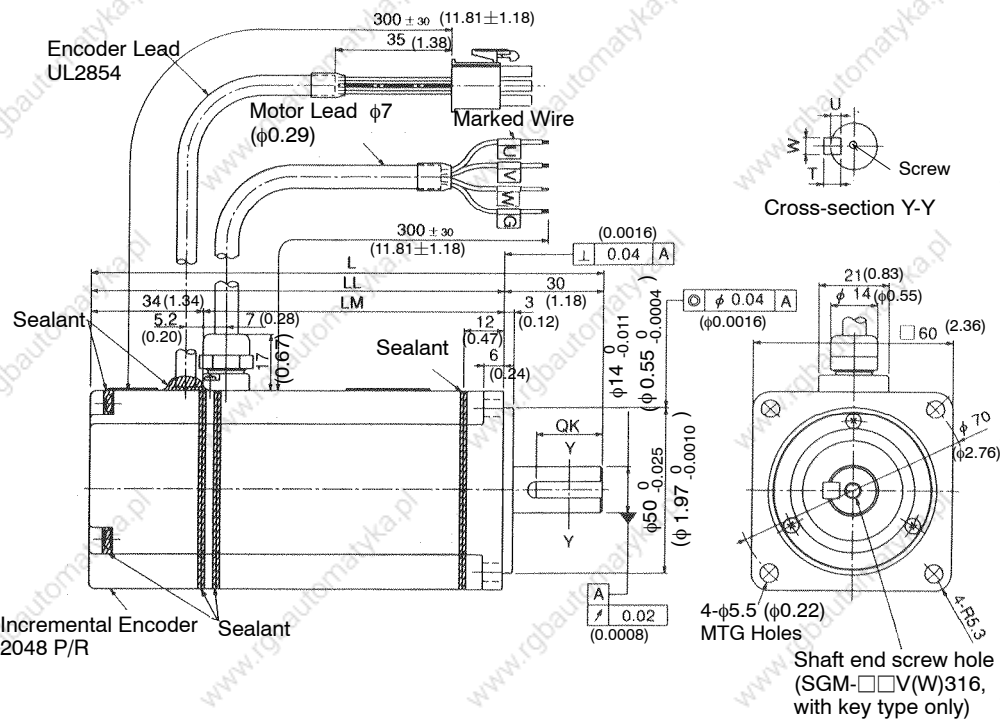

Type SGM-	L	LL	LM	QK	U	W	T	Screw dimensions	Output W (HP)	Approx. mass kg (lb)	Allowable radial load N (lb)	Allowable thrust load N (lb)
02V312	126.5 (4.98)	96.5 (3.80)	62.5 (2.46)	No key				M5, depth 8 (0.31)	200 (0.27)	1.1 (2.43)	245 (55.1)	74 (16.6)
02W312				20 (0.79)	3 (0.12)	5 (0.20)	5 (0.20)					
02V314												
02W314												
02V316												
02W316												
03W312	154.5 (6.08)	124.5 (4.90)	90.5 (3.56)	No key				M5, depth 8 (0.31)	300 (0.40)	1.1 (2.43)		
03W314				20 (0.79)	3 (0.12)	5 (0.20)	5 (0.20)					
03W316												
04V312				No key				M5, depth 8 (0.31)	400 (0.53)			
04V314				20 (0.79)	3 (0.12)	5 (0.20)	5 (0.20)					
04V316												

SERVO SELECTION AND DATA SHEETS

5.4.2 Servomotor Dimensional Drawings cont.

- Note**
- 1) The detector uses an incremental encoder 2048 P/R.
 - 2) Type "V" indicates 200 V specification, and type "W" indicates 100 V specification.
 - 3) "02V(W)314", "02V(W)316", "03W314", "03W316", "04V314" and "04V316" have a keyed shaft. The keyway complies with JIS B 1301-1976 (precision). A straight key is supplied.
 - 4) The quoted allowable radial load is the value at a position 25 mm (0.98 in.) from the motor mounting surface.

• 750 W (1.01 HP)

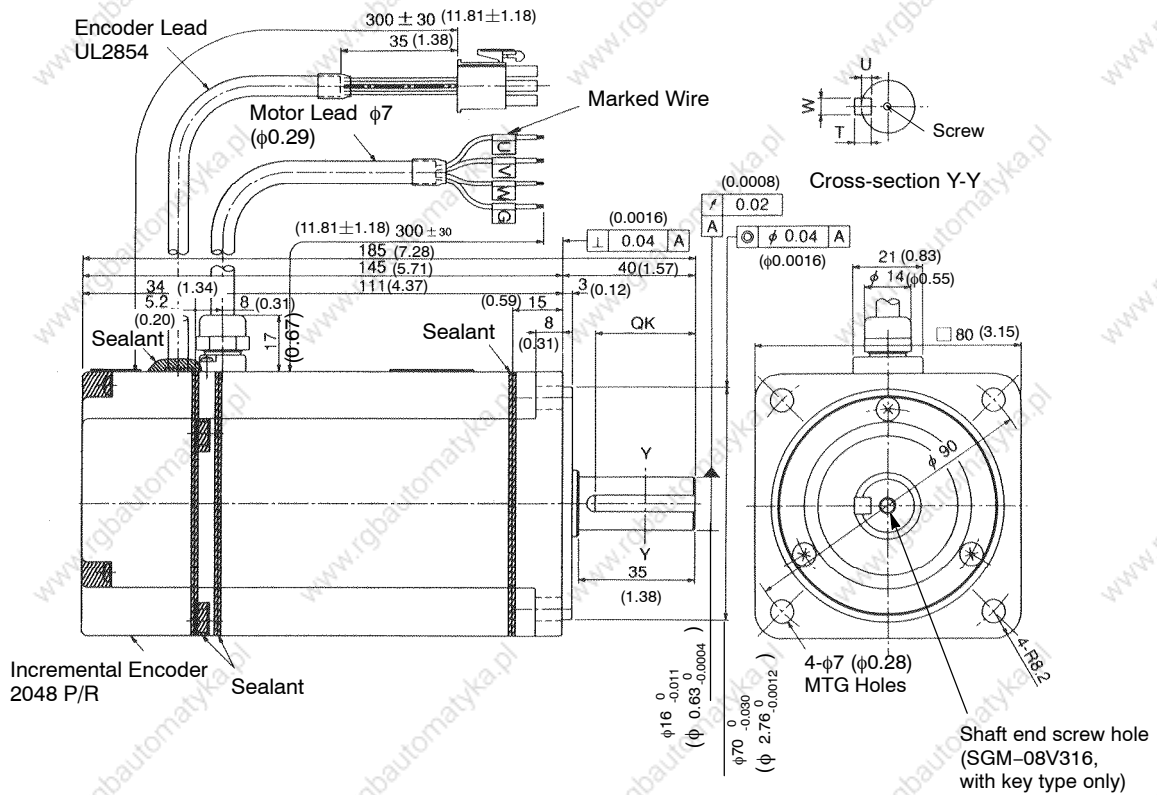

Type SGM-	QK	U	W	T	Screw dimensions	Output W (HP)	Approx. mass kg (lb)	Allowable radial load N (lb)	Allowable thrust load N (lb)
08V312	No key				-	750 (1.01)	3.4 (7.50)	392 (88.1)	147 (33.0)
08V314	30 (1.18)	3 (0.12)	5 (0.20)	5 (0.20)	M5, depth 8 (0.31)				
08V316									

- Note**
- 1) The detector uses an incremental encoder 2048 P/R.
 - 2) Type "V" indicates 200 V specification.

3) "08V314" and "08V316" have a keyed shaft. The keyway complies with JIS B 1301-1976 (precision). A straight key is supplied.

4) The quoted allowable radial load is the value at a position 35 mm (1.38 in.) from the motor mounting surface.

• Details of Motor and Encoder Plugs (Common for 30 W (0.04 HP) to 750 W (1.01 HP))

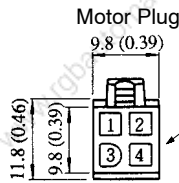

Plug : 172167-1 (AMP)
 Pin: 170360-1 or 170364-1
 (170359-1 or 170363-1: 30, 50, or 100 W only)
 Connected to
 Cap: 172159-1
 Socket: 170362 -1 or 170366-1

Motor Wiring Specifications

1	U phase	Red
2	V phase	White
3	W phase	Blue
4	FG	Green

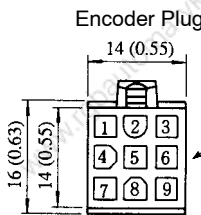

Plug: 172169-1 (Made by AMP)
 Pin: 170359-1 or 170363-1
 Connected to
 Cap :172161-1
 Socket: 170361-1 or 170365-1

Incremental Encoder Wiring Specifications

1	A channel output	Blue
2	\bar{A} channel output	Blue/Black
3	B channel output	Yellow
4	\bar{B} channel output	Yellow/Black
5	C channel output	Green
6	\bar{C} channel output	Green/Black
7	0 V (power supply)	Gray
8	+5 V (power supply)	Red
9	FG (Frame Ground)	Orange

SERVO SELECTION AND DATA SHEETS

5.4.2 Servomotor Dimensional Drawings cont.

(2) TÜV approved (conforming to the machine instructions) SGM Servomotor Incremental encoder, with brake (Type SGM-□□□31□B)

- 30W (0.04 HP), 50W (0.07 HP), 100W (0.13 HP)

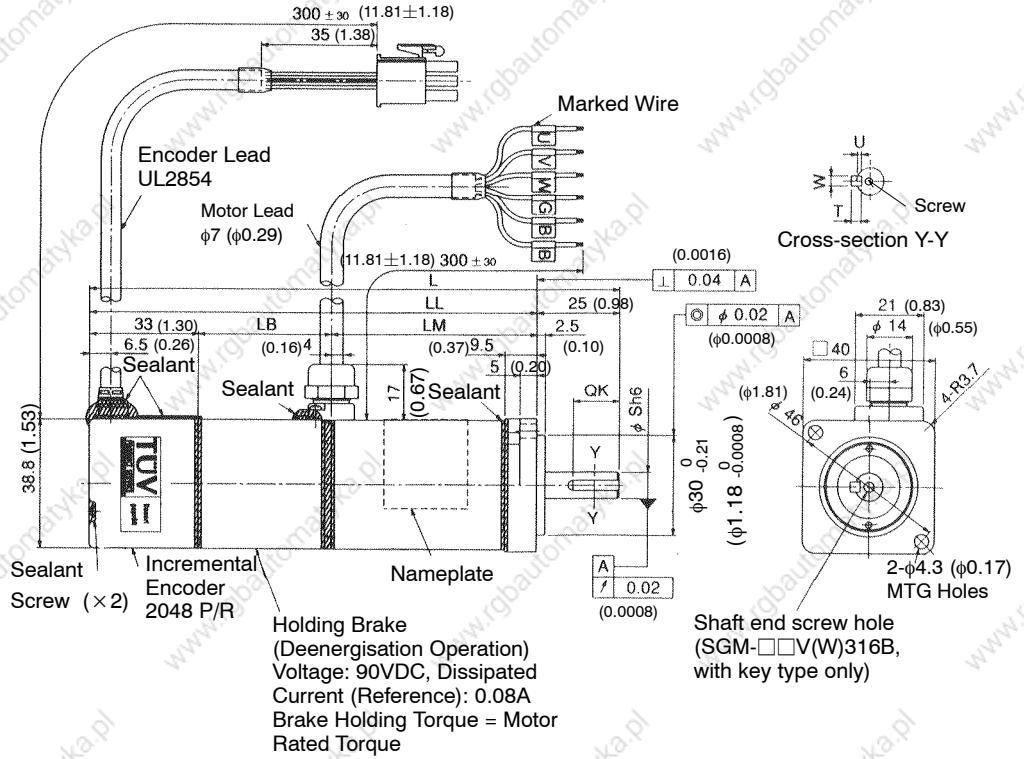

Type SGM-	L	LL	LM	LB	S	QK	U	W	T	Screw dimensions	Output W (HP)	Approx. mass kg (lb)	Allowable radial load N (lb)	Allowable thrust load N (lb)
A3V312B	126.0 (4.96)	101.0 (3.98)	36.5 (1.44)	31.5 (1.24)	6 (0.24)	No key				-	30 (0.04)	0.6 (1.32)	68 (15.3)	54 (12.1)
A3W312B														
A3V314B						14 (0.55)	1.2 (0.05)	2 (0.08)	2 (0.08)					
A3W314B														
A3V316B														
A3W316B									M2.5, depth 5 (0.20)					
A5V312B	133.5 (5.26)	108.5 (4.27)	44.0 (1.73)	31.5 (1.24)	6 (0.24)	No key				-	50 (0.07)	0.7 (1.54)		
A5W312B														
A5V314B						14 (0.55)	1.2 (0.05)	2 (0.08)	2 (0.08)					
A5W314B														
A5V316B														
A5W316B									M2.5, depth 5 (0.20)					
01V312B	160.0 (6.30)	135.0 (5.31)	61.5 (2.42)	40.5 (1.59)	8 (0.31)	No key				-	100 (0.13)	0.8 (1.76)	78 (17.5)	
01W312B														
01V314B						14 (0.55)	1.8 (0.07)	3 (0.12)	3 (0.12)					
01W314B														
01V316B														
01W316B														

- Note**
- 1) The detector uses an incremental encoder 2048 P/R.
 - 2) Type "V" indicates 200 V specification, and type "W" indicates 100 V specification.
 - 3) "A3V(W)314B", "A3V(W)316B", "A5V(W)314B", "A5V(W)316B", "O1V(W)314B" and "O1V(W)316B" have a keyed shaft. The keyway complies with JIS B 1301-1976 (precision). A straight key is supplied.
 - 4) The quoted allowable radial load is the value at a position 20 mm (0.79 in.) from the motor mounting surface.
 - 5) The electromagnetic brake is only to hold the load in position and cannot be used to stop the motor.

• 200 W (0.53 HP), 300 W (0.40 HP), 400 W (0.27 HP)

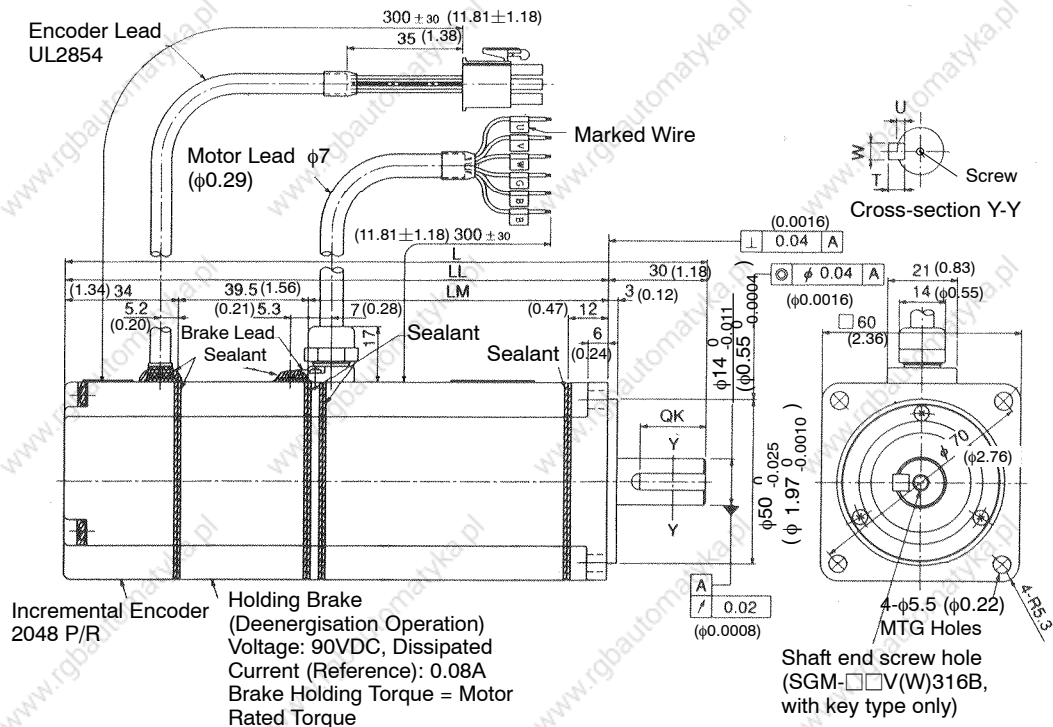

SERVO SELECTION AND DATA SHEETS

5.4.2 Servomotor Dimensional Drawings cont.

Type SGM-	L	LL	LM	QK	U	W	T	Screw dimensions	Output W (HP)	Approx. mass kg (lb)	Allowable radial load N (lb)	Allowable thrust load N (lb)	
02V312B	166.0 (6.54)	136.0 (5.35)	62.5 (2.46)	No key				-	200 (0.27)	1.6 (3.53)	245 (55.1)	74 (16.6)	
02W312B				20 (0.79)	3 (0.12)	5 (0.20)	5 (0.20)						
02V314B													
02W314B				M5, depth 8 (0.31)									
02V316B													
02W316B													
03W312B	194.0 (7.64)	164.0 (6.46)	90.5 (3.56)	No key				-	300 (0.40)	2.2 (4.85)			
03W314B				20 (0.79)	3 (0.12)	5 (0.20)	5 (0.20)						
03W316B													M5, depth 8 (0.31)
04V312B				No key				-					
04V314B				20 (0.79)	3 (0.12)	5 (0.20)	5 (0.20)						
04V316B													M5, depth 8 (0.31)

- Note**
- 1) The detector uses an incremental encoder 2048 P/R.
 - 2) Type "V" indicates 200 V specification, and type "W" indicates 100 V specification.
 - 3) "02V(W)314B", "02V(W)316B", "03W314B", "03W316B", "04V314B" and "04V316B" have a keyed shaft. The keyway complies with JIS B 1301-1976 (precision). A straight key is supplied.
 - 4) The quoted allowable radial load is the value at a position 25 mm (0.98 in.) from the motor mounting surface.
 - 5) The electromagnetic brake is only to hold the load in position and cannot be used to stop the motor.

• 750 W (1.01 HP)

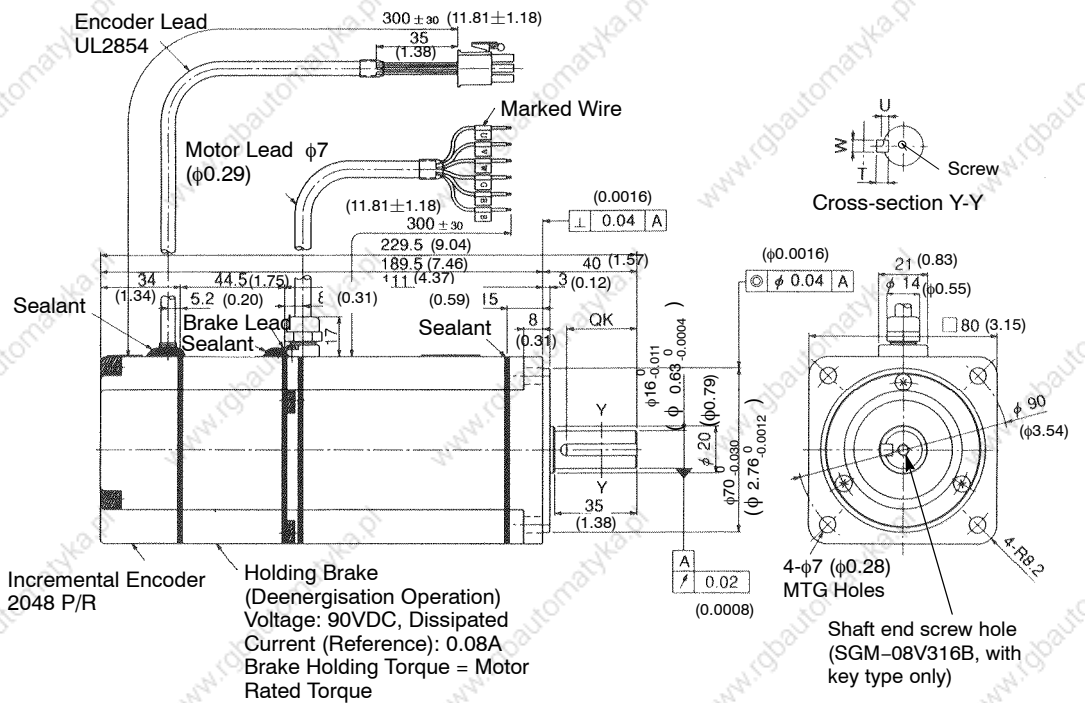

Type SGM-	QK	U	W	T	Screw dimensions	Output W (HP)	Approx. mass kg (lb)	Allowable radial load N (lb)	Allowable thrust load N (lb)
08V312B	No key				-	750 (1.01)	4.3 (9.48)	392 (88.1)	147 (33.0)
08V314B	30 (1.18)	3 (0.12)	5 (0.20)	5 (0.20)	M5, depth 8 (0.31)				
08V316B									

- Note**
- 1) The detector uses an incremental encoder 2048 P/R.
 - 2) Type “V” indicates 200 V specification.
 - 3) “08V314B” and “08V316B” have a keyed shaft. The keyway complies with JIS B 1301-1976 (precision). A straight key is supplied.
 - 4) The quoted allowable radial load is the value at a position 35 mm (1.38 in.) from the motor mounting surface.
 - 5) The electromagnetic brake is only to hold the load in position and cannot be used to stop the motor.

SERVO SELECTION AND DATA SHEETS

5.4.2 Servomotor Dimensional Drawings cont.

- Details of Motor and Encoder Plugs (Common for 30 W (0.04 HP) to 750 W (1.01 HP))

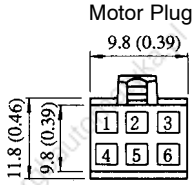

Plug : 172168-1 (AMP)
 Pin: 170360-1 or 170364-1
 (17359-1 or 170363-1: 30, 50, or
 100 W only)
 Connected to
 Cap: 172160-1
 Socket: 170362 -1 or 170366-1

Motor Wiring Specifications

1	U phase	Red
2	V phase	White
3	W phase	Blue
4	FG	Green/Yellow
5	Brake terminal	Red
6	Brake terminal	Black

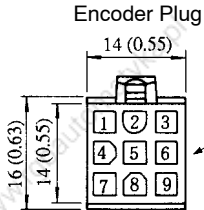

Plug: 172169-1 (AMP)
 Pin: 170359-1 or 170363-1
 Connected to
 Cap :172161-1
 Socket: 170361-1 or 170365-1

Incremental Encoder Wiring Specifications

1	A channel output	Blue
2	\bar{A} channel output	Blue/Black
3	B channel output	Yellow
4	\bar{B} channel output	Yellow/Black
5	C channel output	Green
6	\bar{C} channel output	Green/Black
7	0 V (power supply)	Gray
8	+5 V (power supply)	Red
9	FG (Frame Ground)	Orange

(3) TÜV approved (conforming to the machine instructions) SGM Servomotor
Absolute encoder, no brake (Type SGM-□□□W1□)

- 30 W (0.04 HP), 50 W (0.07 HP), 100 W (0.13 HP)

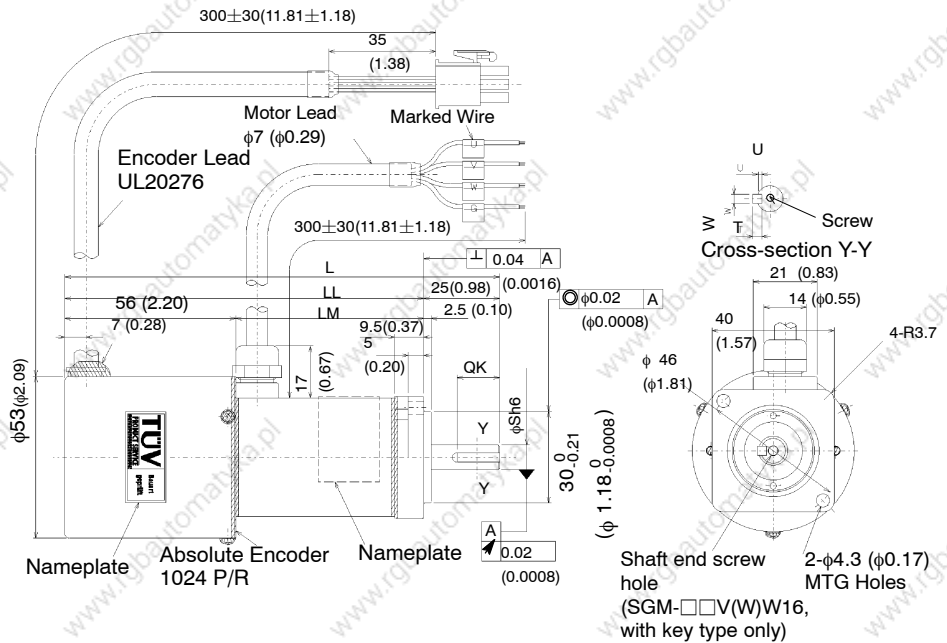

Type SGM-	L	LL	LM	S	QK	U	W	T	Screw dimensions	Output W (HP)	Approx. mass kg (lb)	Allowable radial load N (lb)	Allowable thrust load N (lb)	
A3VW12	117.5 (4.63)	92.5 (3.64)	36.5 (1.44)	6 (0.24)	No key				---	30 (0.04)	0.45 (0.99)	68 (15.3)	54 (12.1)	
A3WW12														
A3VW14					14 (0.55)	1.2 (0.05)	2 (0.08)	2 (0.08)						M2.5, depth 5 (0.20)
A3WW14														
A3VW16														M2.5, depth 5 (0.20)
A3WW16														
A5VW12	125.0 (4.92)	100.0 (3.94)	44.0 (1.73)	8 (0.31)	No key				---	50 (0.07)	0.55 (1.21)	78 (17.5)		
A5WW12														
A5VW14					14 (0.55)	1.2 (0.05)	2 (0.08)	2 (0.08)						M2.5, depth 5 (0.20)
A5WW14														
A5VW16														M2.5, depth 5 (0.20)
A5WW16														
01VW12	142.5 (5.61)	117.5 (4.63)	61.5 (2.42)	8 (0.31)	No key				---	100 (0.13)	0.65 (1.43)	78 (17.5)		
01WW12														
01VW14					14 (0.55)	1.8 (0.07)	3 (0.12)	3 (0.12)						M3, depth 6 (0.24)
01WW14														
01VW16														M3, depth 6 (0.24)
01WW16														

SERVO SELECTION AND DATA SHEETS

5.4.2 Servomotor Dimensional Drawings cont.

- Note**
- 1) The detector uses a 12-bit absolute encoder 1024 P/R.
 - 2) Type "V" indicates 200 V specification, and type "W" indicates 100 V specification.
 - 3) "A3V(W)W14", "A3V(W)W16", "A5V(W)W14", "A5V(W)W16", "01V(W)W14" and "01V(W)W16" have a keyed shaft. The keyway complies with JIS B 1301-1976 (precision). A straight key is supplied.
 - 4) The quoted allowable radial load is the value at a position 20 mm (0.79 in.) from the motor mounting surface.
 - 200 W (0.27 HP), 300W (0.40 HP), 400 W (0.53 HP)

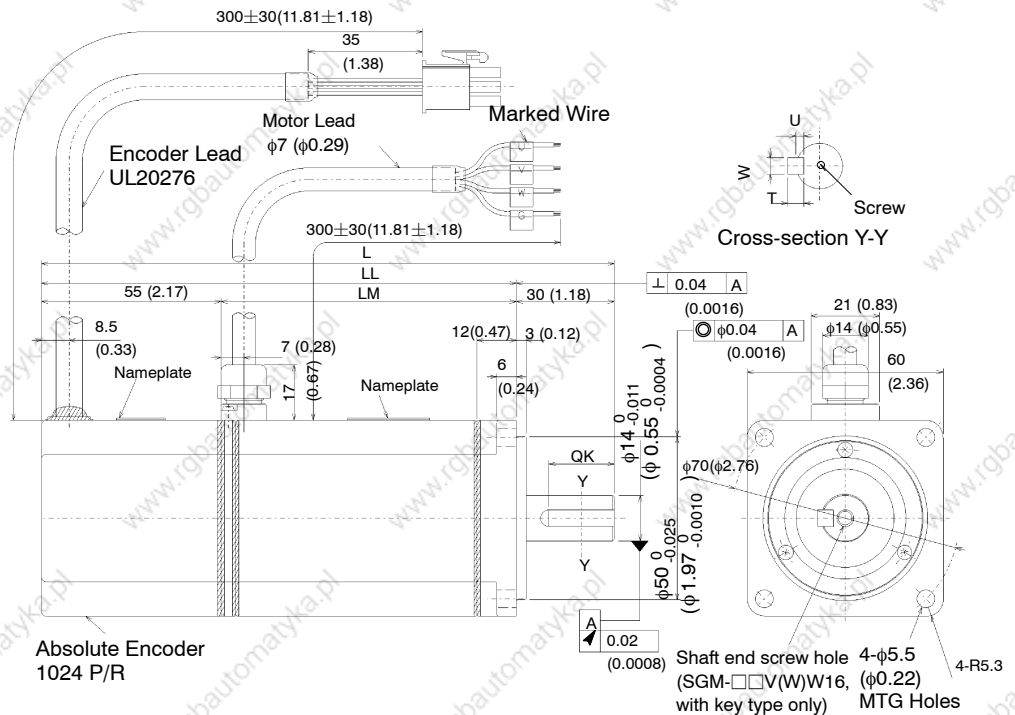

Type SGM-	L	LL	LM	QK	U	W	T	Screw dimensions	Output W (HP)	Approx. mass kg (lb)	Allowable radial load N (lb)	Allowable thrust load N (lb)			
02VW12	147.5 (5.81)	117.5 (4.63)	62.5 (2.46)	No key				-	200 (7.87)	1.2 (2.65)	245 (55.1)	74 (16.6)			
02WW12				20 (0.79)	3 (0.12)	5 (0.20)	5 (0.20)								
02VW14															
02WW14															
02VW16															
02WW16				M5, depth 8 (0.31)											
03WW12	175.5 (6.91)	145.5 (5.73)	90.5 (3.56)	No key				-	300 (0.40)	1.8 (3.97)					
03WW14				20 (0.79)	3 (0.12)	5 (0.20)	5 (0.20)								
03WW16											M5, depth 8 (0.31)				
04VW12								No key				-	400 (15.7)		
04VW14								20 (0.79)			3 (0.12)			5 (0.20)	5 (0.20)
04VW16				M5, depth 8 (0.31)											

- Note**
- 1) The detector uses a 12-bit absolute encoder 1024 P/R.
 - 2) Type "V" indicates 200 V specification, and type "W" indicates 100 V specification.
 - 3) "02V(W)W14", "02V(W)W16", "03WW14", "03WW16", "04VW14" and "04VW16" have a keyed shaft. The keyway complies with JIS B 1301-1976 (precision). A straight key is supplied.
 - 4) The quoted allowable radial load is the value at a position 25 mm (0.98 in.) from the motor mounting surface.

SERVO SELECTION AND DATA SHEETS

5.4.2 Servomotor Dimensional Drawings cont.

• 750 W (1.01 HP)

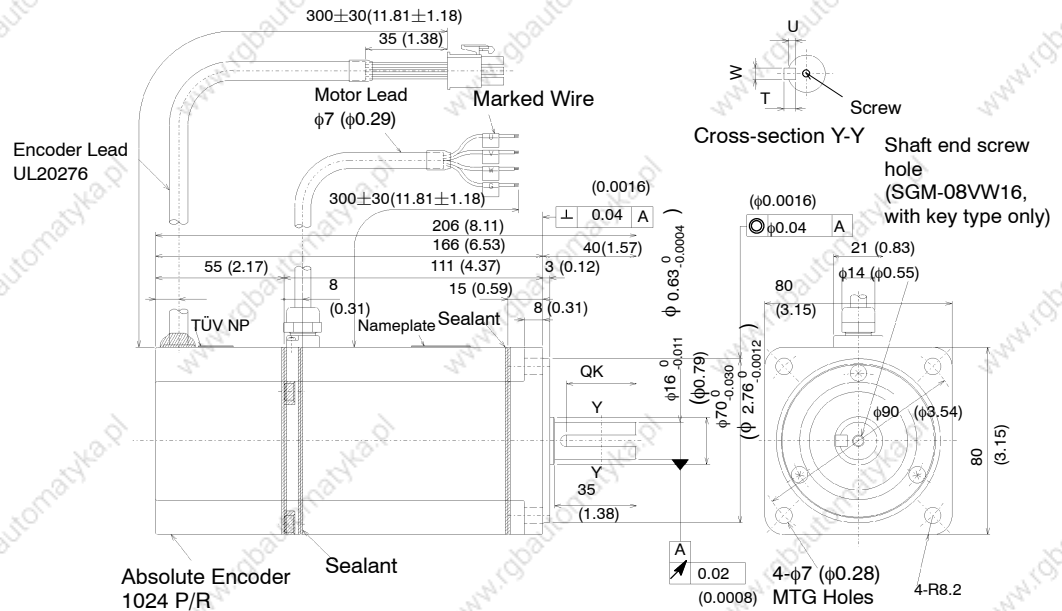

Type SGM-	QK	U	W	T	Screw dimensions	Output W (HP)	Approx. mass kg (lb)	Allowable radial load N (lb)	Allowable thrust load N (lb)
08VW12	No key				---	750 (1.01)	3.5 (7.72)	392 (88.1)	147 (33.0)
08VW14	30 (1.18)	3 (0.12)	5 (0.20)	5 (0.20)	M5, depth 8 (0.31)				
08VW16									

- Note**
- 1) The detector uses a 12-bit absolute encoder 1024 P/R.
 - 2) Type "V" indicates 200 V specification.
 - 3) "08VW14" and "08VW16" have a keyed shaft. The keyway complies with JIS B 1301-1976 (precision). A straight key is supplied.
 - 4) The quoted allowable radial load is the value at a position 35 mm (1.38 in.) from the motor mounting surface.

- Details of Motor and Encoder Plugs (Common for 30 W (0.04 HP) to 750 W (1.01 HP))

Motor Plug



Plug : 172167-1 (AMP)
 Pin: 170360-1 or 170364-1
 (17359-1 or 170363-1: 30, 50, or
 100 W only)
 Connected to
 Cap: 172159-1
 Socket: 170362 -1 or 170366-1

Motor Wiring Specifications

1	U phase	Red
2	V phase	White
3	W phase	Blue
4	FG	Green/Yellow

Encoder Plug

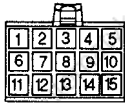

Plug: 172171-1 (AMP)
 Pin: 170359-1 or 170363-1
 Connected to
 Cap :172163-1
 Socket: 170361-1 or 170365-1

Incremental Encoder Wiring Specifications

1	A channel output	Blue
2	\bar{A} channel output	White/Blue
3	B channel output	Yellow
4	\bar{B} channel output	White/Yellow
5	Z channel output	Green
6	\bar{Z} channel output	White/Green
7	0 V (power supply)	Gray
8	+5 V (power supply)	Red
9	FG (Frame Ground)	Orange
10	S channel output	Purple
11	\bar{S} channel output	White/Purple
*	(12) (Capacitor reset)	(Gray)
13	Reset	White/Gray
14	0V(battery)	White/Orange
15	3.6V(battery)	Orange

* Terminal to discharge capacitor for product dispatch.
 Do not use.

SERVO SELECTION AND DATA SHEETS

5.4.2 Servomotor Dimensional Drawings cont.

(4) TÜV approved (conforming to the machine instructions) SGM Servomotor Absolute encoder, with brake (Type SGM-□□□W1□B)

- 30 W (0.04 HP), 50 W (0.07 HP), 100 W (0.13 HP)

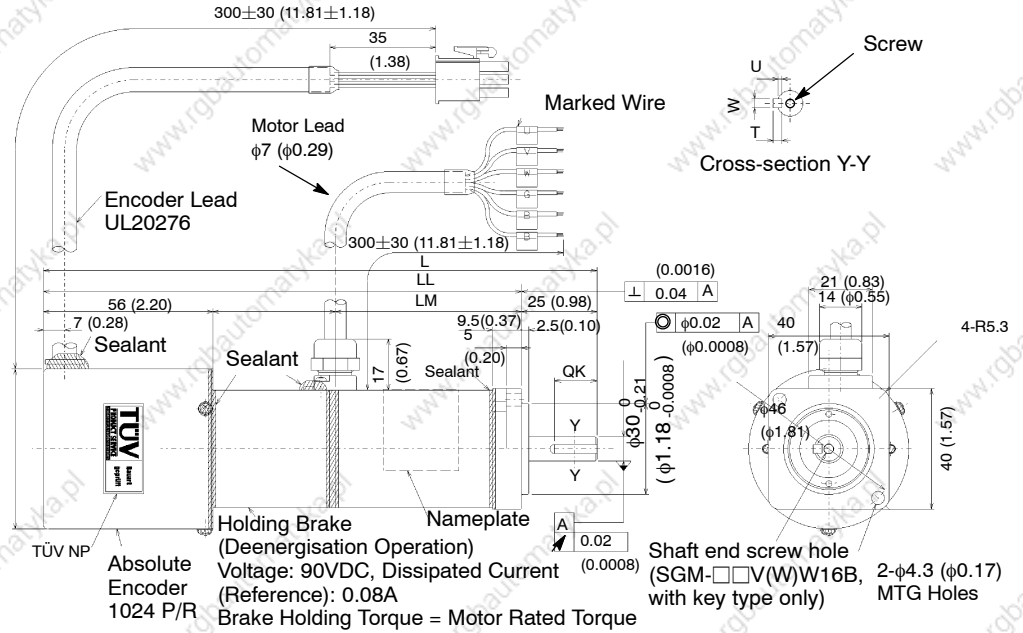

Type SGM-	L	LL	LM	LB	S	QK	U	W	T	Screw dimensions	Output W (HP)	Approx. mass kg (lb)	Allowable radial load N (lb)	Allowable thrust load N (lb)
A3VW12B	149.0 (5.87)	124.0 (4.88)	36.5 (1.44)	31.5 (1.24)	6 (0.24)	No key				---	30 (0.04)	0.75 (1.65)	68 (15.3)	54 (12.1)
A3WW12B						14 (0.55)	1.2 (0.05)	2 (0.08)	2 (0.08)					
A3VW14B														
A3WW14B														
A3VW16B														
A3WW16B						M2.5, depth 5 (0.20)								
A5VW12B	156.5 (6.16)	131.5 (5.18)	44.0 (1.73)	31.5 (1.24)	6 (0.24)	No key				---	50 (0.07)	0.85 (1.87)	78 (17.5)	
A5WW12B						14 (0.55)	1.2 (0.05)	2 (0.08)	2 (0.08)					
A5VW14B														
A5WW14B														
A5VW16B														
A5WW16B						M2.5, depth 5 (0.20)								
O1VW12B	183.0 (7.20)	158.0 (6.22)	61.5 (2.42)	40.5 (1.59)	8 (0.31)	No key				---	100 (0.13)	0.95 (2.09)	78 (17.5)	
O1WW12B						14 (0.55)	1.8 (0.07)	3 (0.12)	3 (0.12)					
O1VW14B														
O1WW14B														
O1VW16B														
O1WW16B						M3, depth 6 (0.24)								

- Note**
- 1) The detector uses a 12-bit absolute encoder 1024 P/R.
 - 2) Type “V” indicates 200 V specification, and type “W” indicates 100 V specification.
 - 3) “A3V(W)W14B”, “A3V(W)W16B”, “A5V(W)W14B”, “A5V(W)W16B”, “01V(W)W14B” and “01V(W)W16B” have a keyed shaft. The keyway complies with JIS B 1301-1976 (precision). A straight key is supplied.
 - 4) The quoted allowable radial load is the value at a position 20 mm (0.79 in.) from the motor mounting surface.
 - 5) The electromagnetic brake is only to hold the load in position and cannot be used to stop the motor.

- 200 W (0.27 HP), 300 W (0.40 HP), 400 W (0.53 HP)

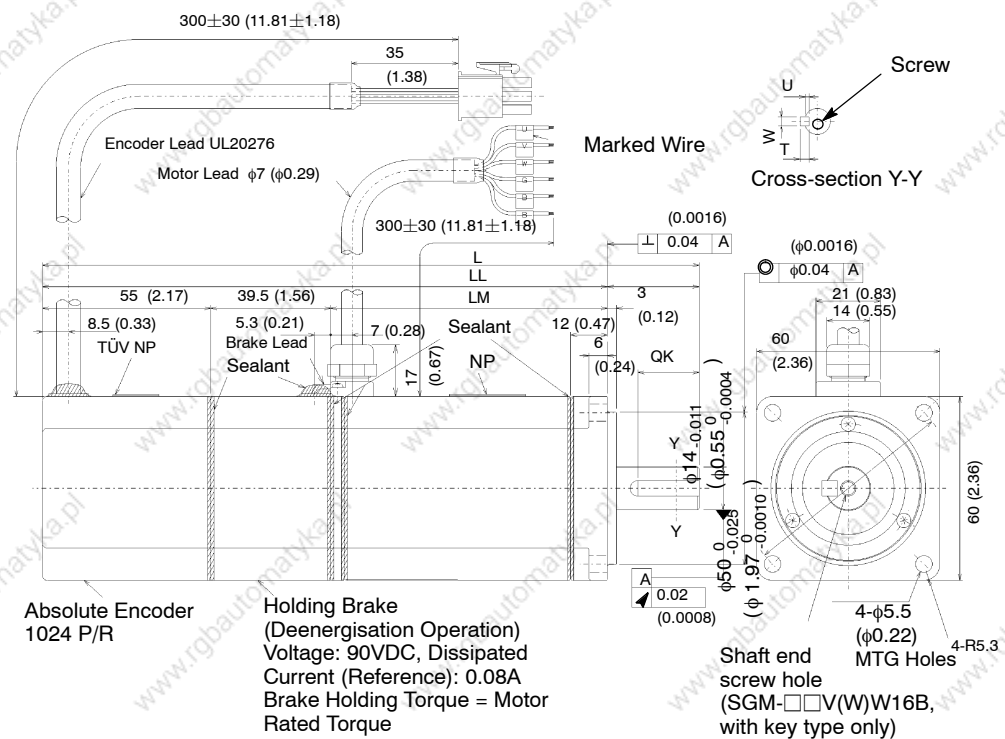

SERVO SELECTION AND DATA SHEETS

5.4.2 Servomotor Dimensional Drawings cont.

Type SGM-	L	LL	LM	QK	U	W	T	Screw dimensions	Output W (HP)	Approx. mass kg (lb)	Allowable radial load N (lb)	Allowable thrust load N (lb)
02VW12B	187.0 (7.36)	157.0 (6.18)	62.5 (2.46)	No key				-	200 (0.27)	1.7 (3.75)	245 (55.1)	74 (16.6)
02WW12B												
02VW14B												
02WW14B				20 (0.79)	3 (0.12)	5 (0.20)	5 (0.20)					
02VW16B				-				M5, depth 8 (0.31)				
02WW16B												
03WW12B	215.0 (8.46)	185.0 (7.28)	90.5 (3.56)	No key				-	300 (0.40)	2.3 (5.07)		
03WW14B												
03WW16B												
04VW12B				-				M5, depth 8 (0.31)				
04VW14B				20 (0.79)	3 (0.12)	5 (0.20)	5 (0.20)					
04VW16B				No key				-			400 (0.53)	
	20 (0.79)	3 (0.12)	5 (0.20)	5 (0.20)								

- Note**
- 1) The detector uses a 12-bit absolute encoder 1024 P/R.
 - 2) Type "V" indicates 200 V specification, and type "W" indicates 100 V specification.
 - 3) "02V(W)W14B", "02V(W)W16B", "03WW14B", "03WW16B", "04VW14B" and "04VW16B" have a keyed shaft. The keyway complies with JIS B 1301-1976 (precision). A straight key is supplied.
 - 4) The quoted allowable radial load is the value at a position 25 mm (0.98 in.) from the motor mounting surface.
 - 5) The electromagnetic brake is only to hold the load in position and cannot be used to stop the motor.

• 750 W (1.01 HP)

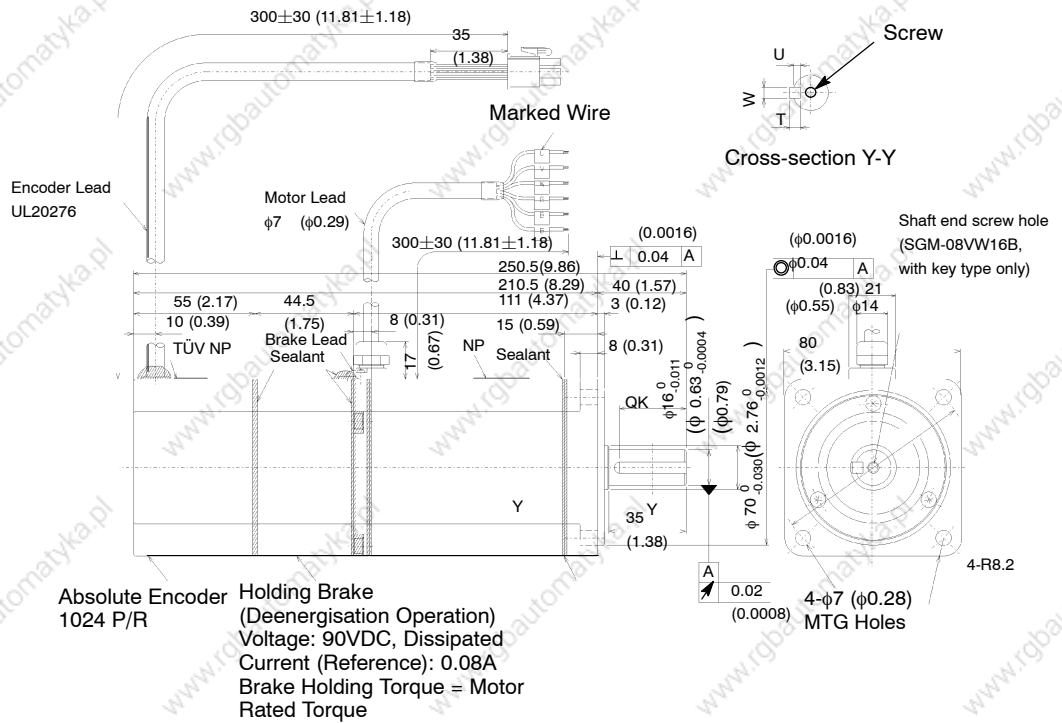

Type SGM-	QK	U	W	T	Screw dimensions (lb)	Output W (HP)	Approx. mass kg (lb)	Allowable radial load N (lb)	Allowable thrust load N (lb)
08VW12B	No key				---	750 (1.01)	4.5 (9.92)	392 (88.1)	147 (33.0)
08VW14B	30 (1.18)	3 (0.12)	5 (0.20)	5 (0.20)	M5, depth 8 (0.31)				
08VW16B									

- Note**
- 1) The detector uses a 12-bit absolute encoder 1024 P/R.
 - 2) Type "V" indicates 200 V specification.
 - 3) "08VW14B" and "08VW16B" have a keyed shaft. The keyway complies with JIS B 1301-1976 (precision). A straight key is supplied.
 - 4) The quoted allowable radial load is the value at a position 35 mm (1.38 in.) from the motor mounting surface.
 - 5) The electromagnetic brake is only to hold the load in position and cannot be used to stop the motor.

SERVO SELECTION AND DATA SHEETS

5.4.2 Servomotor Dimensional Drawings cont.

- Details of Motor and Encoder Plugs (Common for 30 W (0.04 HP) to 750 W (1.01 HP))

Motor Plug



Plug : 172168-1 (AMP)
 Pin: 170360-1 or 170364-1
 (17359-1 or 170363-1: 30, 50, or
 100 W only)
 Connected to
 Cap: 172160-1
 Socket: 170362 -1 or 170366-1

Motor Wiring Specifications

1	U phase	Red
2	V phase	White
3	W phase	Blue
4	FG	Green/Yellow
5	Brake terminal	Red
6	Brake terminal	Black

Encoder Plug

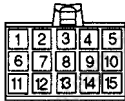

Plug: 172171-1 (AMP)
 Pin: 170359-1 or 170363-1
 Connected to
 Cap :172163-1
 Socket: 170361-1 or 170365-1

Incremental Encoder Wiring Specifications

1	A channel output	Blue
2	\bar{A} channel output	White/Blue
3	B channel output	Yellow
4	\bar{B} channel output	White/Yellow
5	Z channel output	Green
6	\bar{Z} channel output	White/Green
7	0 V (power supply)	Black
8	+5 V (power supply)	Red
9	FG (Frame Ground)	Green/Yellow
10	S channel output	Purple
11	\bar{S} channel output	White/Purple
* (12)	(Capacitor reset)	(Gray)
13	Reset	White/Gray
14	0V(battery)	White/Orange
15	3.6V(battery)	Orange

* Terminal to discharge capacitor for product dispatch.
 Do not use.

2) The dimensional drawings of TÜV approved SGMP Servomotors (conforming to the machine instructions) are broadly grouped into the following four categories.

- a) Incremental encoder, no brake (from page 310)
- b) Incremental encoder, with brake (from page 314)
- c) Absolute encoder, no brake (from page 319)
- d) Absolute encoder, with brake (from page 324)

Motor capacities are available as 100 W (0.13 HP), 200 W (0.27 HP), 300 W (0.40 HP) , 400 W (0.53 HP), 750 W (1.01 HP). These are grouped into three categories, as follows:

- 100W (0.13 HP)
- 200W (0.27 HP), 300W (0.40 HP), 400W (0.53 HP)
- 750W (1.01 HP)
- **As for the dimensional drawings of SGM servomotors, see from the page 247 on.**
- **As for the dimensional drawings of SGMP servomotors, see from the page 269 on.**
- **As for the dimensional drawings of TÜV approved SGM servomotors, see from the page 289 on.**

All drawings conform to the machine instructions. As for the motor drawings conforming to the EMC instructions, encoder plug and its accessories are different. For details, contact your Yaskawa representative.

SERVO SELECTION AND DATA SHEETS

5.4.2 Servomotor Dimensional Drawings cont.

(1) TÜV approved (conforming to the machine instructions) SGMP Servomotor Incremental encoder, no brake (Type SGMP-□□□31□)

• 100 W (0.13 HP)

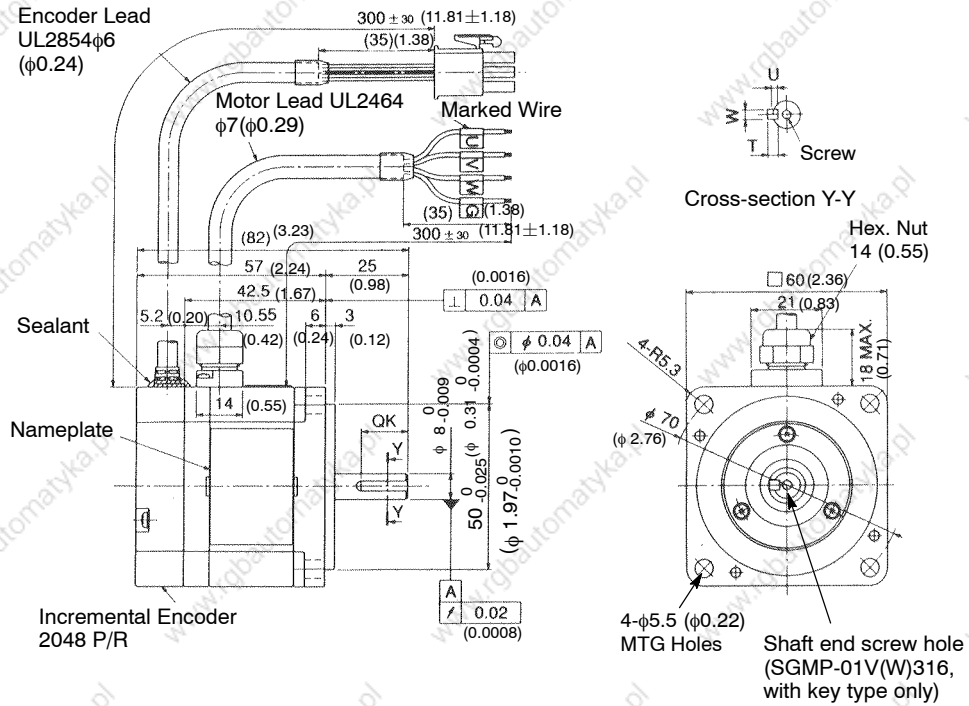

Type SGMP-	QK	U	W	T	Screw dimensions	Output W (HP)	Approx. mass kg (lb)	Allowable radial load N (lb)	Allowable thrust load N (lb)
01V312	No key				---	100 (0.13)	0.7 (1.54)	78 (17.5)	49 (11.0)
01W312									
01V314	14 (0.55)	1.8 (0.07)	3 (0.12)	3 (0.12)					
01W314									
01V316					M3, depth 6 (0.24)				
01W316									

- Note**
- 1) The detector uses an incremental encoder 2048 P/R.
 - 2) Type "V" indicates 200 V specification, and type "W" indicates 100 V specification.
 - 3) "01V(W)314" and "01V(W)316" have a keyed shaft. The keyway complies with JIS B 1301-1976 (precision). A straight key is supplied.
 - 4) The quoted allowable radial load is the value at a position 20 mm (0.79 in.) from the motor mounting surface.
 - 5) Conforms to "IP55" protective structure (except connector and output shaft faces).

- 200 W (0.27 HP), 300 W (0.40 HP), 400 W (0.53 HP)

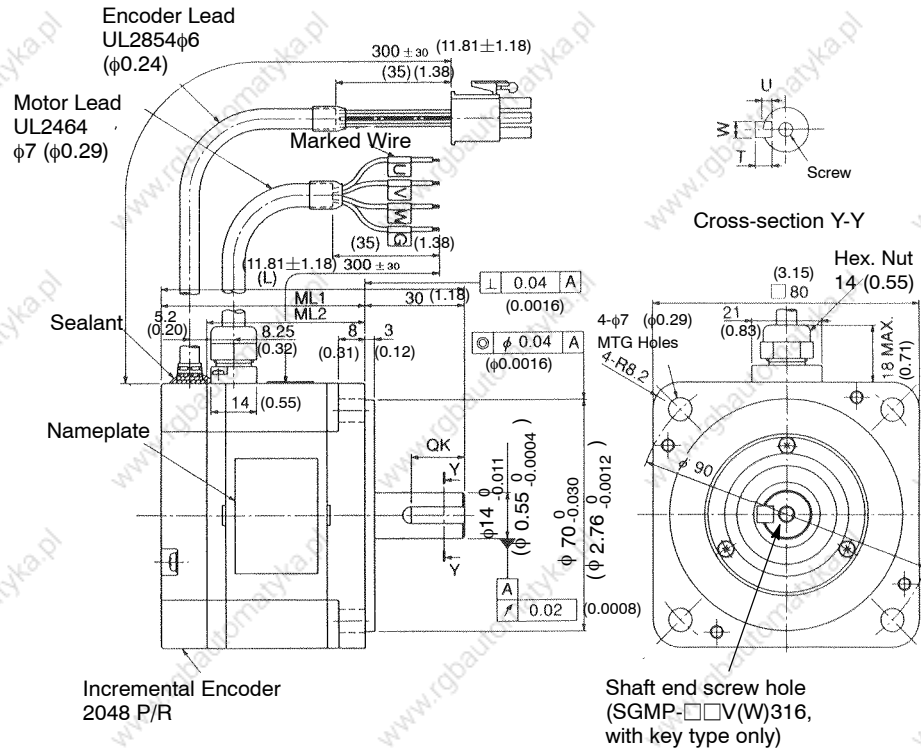

Type SGMP-	L	ML1	ML2	QK	U	W	T	Screw dimensions	Output W (HP)	Approx. mass kg (lb)	Allowable radial load N (lb)	Allowable thrust load N (lb)
02V312	92 (3.62)	62 (2.44)	48.1 (1.89)	No key				M5, depth 8 (0.31)	200 (0.27)	1.4 (3.09)	245 (55.1)	68 (15.3)
02W312				16 (0.63)	3 (0.12)	5 (0.20)	5 (0.20)					
02V314												
02W314												
02V316												
02W316												
03W312	112 (4.41)	82 (3.23)	68.1 (2.68)	No key				M5, depth 8 (0.31)	300 (0.40)	2.1 (4.63)		
03W314				16 (0.63)	3 (0.12)	5 (0.20)	5 (0.20)					
03W316												
04V312				No key				M5, depth 8 (0.31)	400 (0.53)			
04V314				16 (0.63)	3 (0.12)	5 (0.20)	5 (0.20)					
04V316												

- Note**
- 1) The detector uses an incremental encoder 2048 P/R.
 - 2) Type "V" indicates 200 V specification, and type "W" indicates 100 V specification.

SERVO SELECTION AND DATA SHEETS

5.4.2 Servomotor Dimensional Drawings (cont.)

- 3) "02V(W)314", "02V(W)316", "04V314", "04V316", "03W314", and 03W316 have a keyed shaft. The keyway complies with JIS B 1301-1976 (precision). A straight key is supplied.
 - 4) The quoted allowable radial load is the value at a position 25 mm (0.98 in.) from the motor mounting surface.
 - 5) Conforms to "IP55" protective structure (except connector and output shaft faces).
- 750 W (1.01 HP)

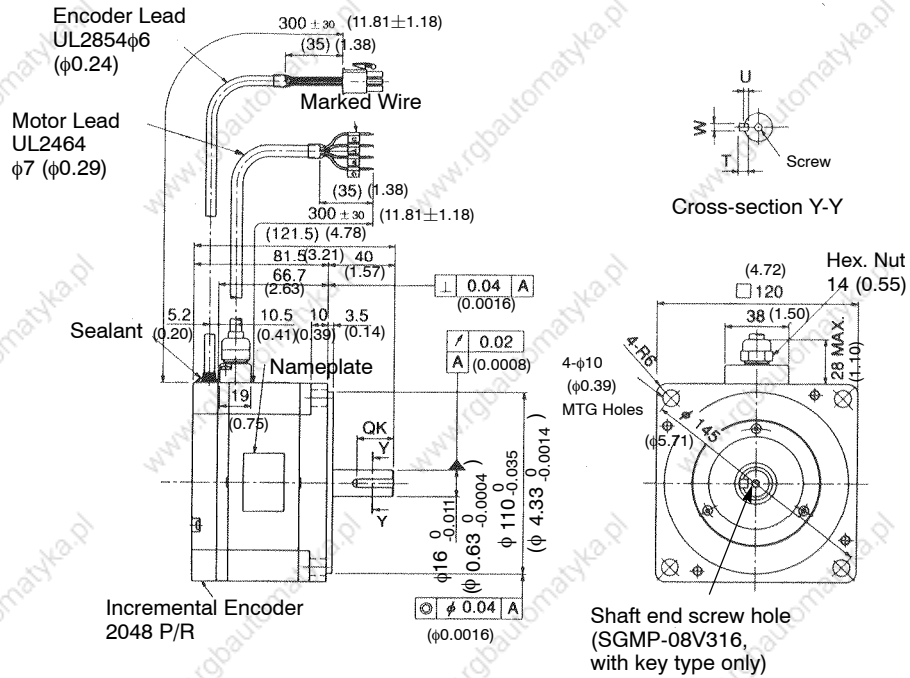

Type SGMP-	QK	U	W	T	Screw dimensions	Output W (HP)	Approx. mass kg (lb)	Allowable radial load N (lb)	Allowable thrust load N (lb)
08V312	No key				---	750 (1.01)	4.6 (10.14)	392 (80.1)	147 (33.0)
08V314	22 (0.87)	3 (0.12)	5 (0.20)	5 (0.20)					
08V316				M5, depth 8 (0.31)					

- Note**
- 1) The detector uses an incremental encoder 2048 P/R.
 - 2) Type "V" indicates 200 V specification.
 - 3) "08V314" and "08V316" have a keyed shaft. The keyway complies with JIS B 1301-1976 (precision). A straight key is supplied.
 - 4) The quoted allowable radial load is the value at a position 35 mm (1.38in.) from the motor mounting surface.
 - 5) Conforms to IP55 protective structure (except connector and output shaft faces).

- Details of Motor and Encoder Plugs (Common for 100 W (0.13HP) to 750 W (1.01HP))

Motor Plug



Plug : 172167-1 (AMP)
Pin: 170360-1 or 170364-1

Connected to
Cap 172159-1
Socket 170362-1 or 170366-1

Motor Wiring Specifications

1	U phase	Red
2	V phase	White
3	W phase	Blue
4	FG	Green/Yellow

Encoder Plug

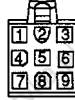

Plug: 172169-1 (AMP)
Pin: 170359-1 or 170363-1

Connected to
Cap :172161-1
Socket: 170361-1 or 170365-1

Incremental Encoder Wiring Specifications

1	A channel output	Blue
2	\bar{A} channel output	Blue/Black
3	B channel output	Yellow
4	\bar{B} channel output	Yellow/Black
5	C channel output	Green
6	\bar{C} channel output	Green/Black
7	0 V (power supply)	Gray
8	+5 V (power supply)	Red
9	FG (Frame Ground)	Orange

SERVO SELECTION AND DATA SHEETS

5.4.2 Servomotor Dimensional Drawings cont.

(2) TÜV approved (conforming to the machine instructions) SGMP Servomotor Incremental encoder, with brake (Type SGMP-□□□31□B)

• 100 W (0.13HP)

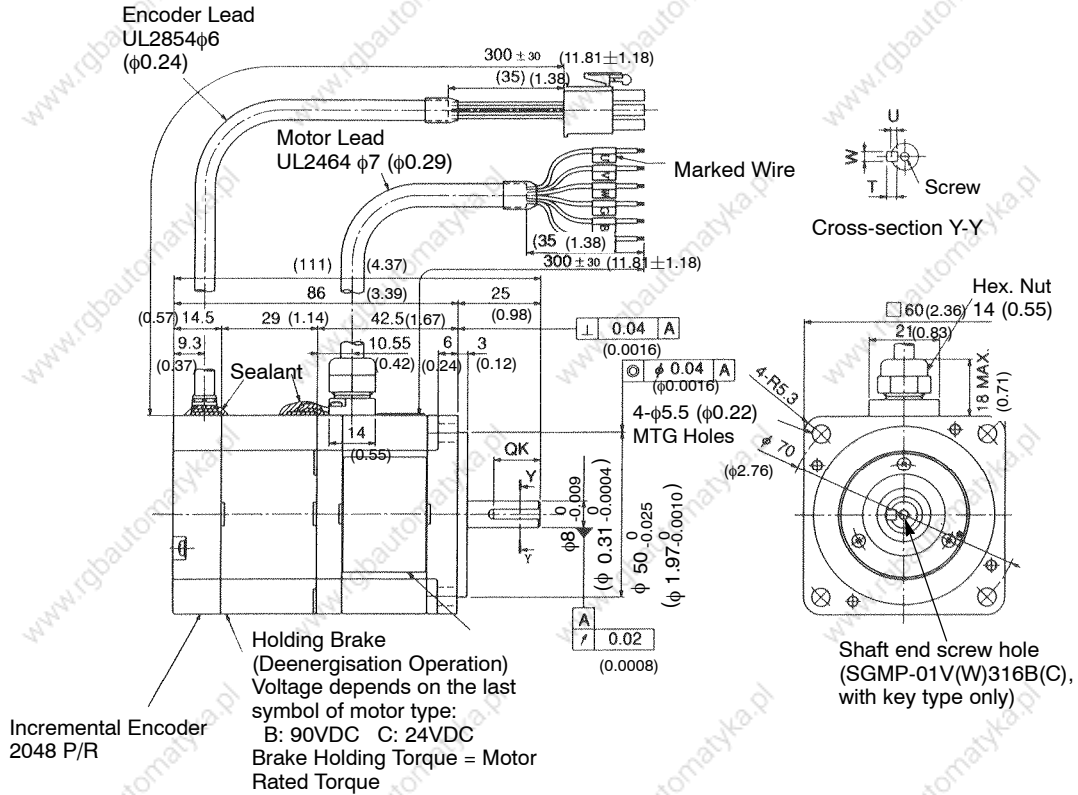

Type SGMP-	QK	U	W	T	Screw dimensions	Output W (HP)	Approx. mass kg (lb)	Allowable radial load N (lb)	Allowable thrust load N (lb)
01V312B(C)	No key				---	100 (0.13)	0.9 (1.98)	78 (17.5)	49 (11.0)
01V314B(C)	14 (0.55)	1.8 (0.07)	3 (0.12)	3 (0.12)	M3, depth 6 (0.24)				
01V316B(C)									
01W312B(C)	No key				---				
01W314B(C)	14 (0.55)	1.8 (0.07)	3 (0.12)	3 (0.12)	M3, depth 6 (0.24)				
01W316B(C)									

- Note**
- 1) The detector uses an incremental encoder 2048 P/R.
 - 2) Type "V" indicates 200 V specification, and "W" indicates 100V specification.
 - 3) "01V314B(C)", "01V316B(C)", "01W314B(C)" and "01W316B(C)" have a keyed shaft. The keyway complies with JIS B 1301-1976 (precision). A straight key is supplied.

- 4) The quoted allowable radial load is the value at a position 20 mm (0.79in.) from the motor mounting surface.
- 5) The electromagnetic brake is only to hold the load in position and cannot be used to stop the motor.
- 6) Conforms to IP55 protective structure (except connector and output shaft faces).

- 200 W (0.27HP), 300W (0.40 HP), 400 W (0.53HP)

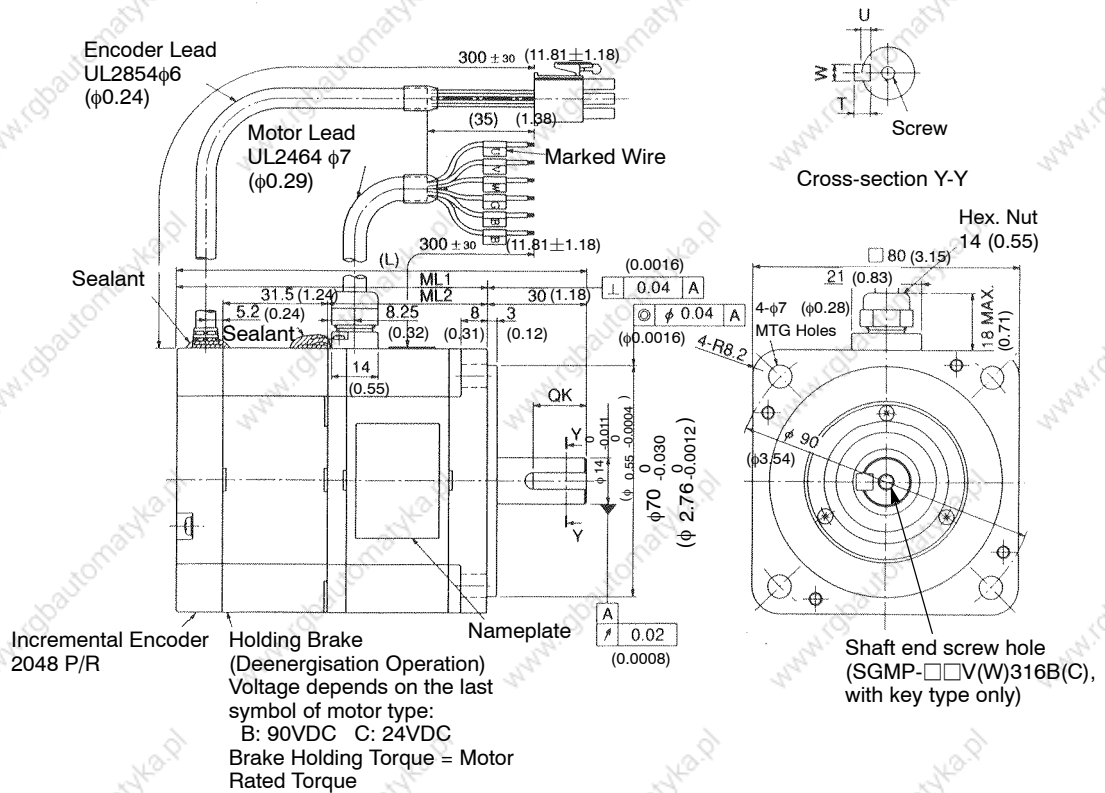

SERVO SELECTION AND DATA SHEETS

5.4.2 Servomotor Dimensional Drawings cont.

Type SGMP-	L	LL	LM	QK	U	W	T	Screw dimensions	Output W (HP)	Approx. mass kg (lb)	Allowable radial load N (lb)	Allowable thrust load N (lb)	
02V312B(C)	123.5 (4.86)	93.5 (3.68)	48.1 (1.89)	No key				-	200 (0.27)	1.9 (4.19)	245 (55.1)	68 (15.3)	
02V314B(C)				16 (0.63)	3 (0.12)	5 (0.20)	5 (0.20)						
02V316B(C)				M5 depth 8									
02W312B(C)				No key				-					
02W314B(C)				16 (0.63)	3 (0.12)	5 (0.20)	5 (0.20)						
02W316B(C)				M5 depth 8									
03W312B(C)	143.5 (5.65)	113.5 (4.47)	68.1 (2.68)	No key				-	300 (0.40)	2.6 (0.10)			
03W314B(C)				16 (0.63)	3 (0.12)	5 (0.20)	5 (0.20)						
03W316B(C)				M5 depth 8									
04V312B(C)				No key				-					400 (0.53)
04V314B(C)				16 (0.63)	3 (0.12)	5 (0.20)	5 (0.20)						
04V316B(C)				M5 depth 8									

- Note**
- 1) The detector uses an incremental encoder 2048 P/R.
 - 2) Type "V" indicates 200 V specification, and "W" indicates 100V specification.
 - 3) "02V314B(C)", "02V316B(C)", "02W314B(C)", "02W316B(C)", "03W314B(C)", "03W316B(C)", "04V314B(C)" and "04V316B(C)" have a keyed shaft. The keyway complies with JIS B 1301-1976 (precision). A straight key is supplied.
 - 4) The quoted allowable radial load is the value at a position 25 mm (0.98in.) from the motor mounting surface.
 - 5) The electromagnetic brake is only to hold the load in position and cannot be used to stop the motor.
 - 6) Conforms to IP55 protective structure (except connector and output shaft faces).

• 750 W (1.01HP)

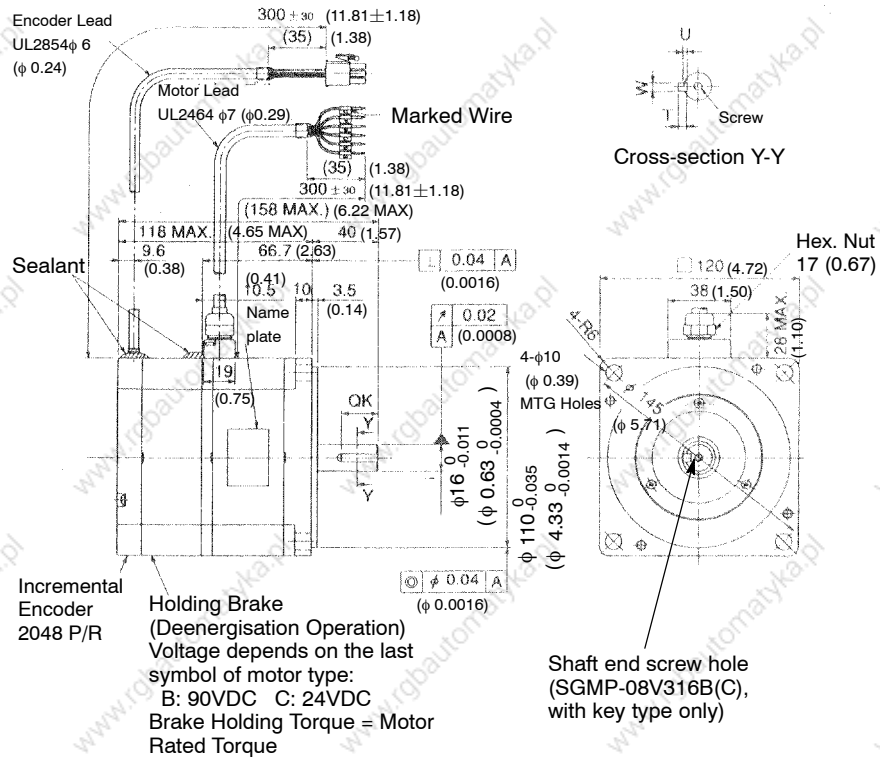

Type SGMP-	QK	U	W	T	Screw dimensions	Output W (HP)	Approx. mass kg (lb)	Allowable radial load N (lb)	Allowable thrust load N (lb)
08V312B(C)	No key				-	750 (1.01)	5.7 (12.57)	392 (88.1)	147 (33.0)
08V314B(C)	22(0.87)	3(0.12)	5(0.20)	5(0.20)	M5				
08V316B(C)					Depth 8				

- Note**
- 1) The detector uses an incremental encoder 2048 P/R.
 - 2) Type "V" indicates 200 V specification.
 - 3) "08V314B(C)" and "08V316B(C)" have a keyed shaft. The keyway complies with JIS B 1301-1976 (precision). A straight key is supplied.
 - 4) The quoted allowable radial load is the value at a position 35 mm (1.38 in.) from the motor mounting surface.
 - 5) The electromagnetic brake is only to hold the load in position and cannot be used to stop the motor.
 - 6) Conforms to IP55 protective structure (except connector and output shaft faces).

SERVO SELECTION AND DATA SHEETS

5.4.2 Servomotor Dimensional Drawings cont.

- Details of Motor and Encoder Plugs (Common for 100 W (0.13 HP) to 750 W (1.01 HP))

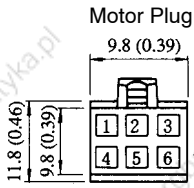

Plug : 172168-1 (AMP)

Pin: 170360-1 or 170364-1
(17359-1 or 170363-1: 30, 50, or 100 W only)

Connected to
Cap: 172160-1
Socket: 170362 -1 or 170366-1

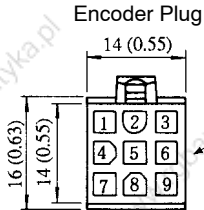

Plug: 172169-1 (AMP)

Pin: 170359-1 or 170363-1

Connected to
Cap :172161-1
Socket: 170361-1 or 170365-1

Motor Wiring Specifications

1	U phase	Red
2	V phase	White
3	W phase	Blue
4	FG	Green/Yellow
5	Brake terminal	Red
6	Brake terminal	Black

Incremental Encoder Wiring Specifications

1	A channel output	Blue
2	\bar{A} channel output	Blue/Black
3	B channel output	Yellow
4	\bar{B} channel output	Yellow/Black
5	C channel output	Green
6	\bar{C} channel output	Green/Black
7	0V (power supply)	Gray
8	+5 V(power supply)	Red
9	FG (Frame Ground)	Orange

(3) TÜV approved (conforming to the machine instructions) SGMP Servomotor
Absolute encoder, no brake (Type SGMP-□□□W1□)

• 100 W (0.13HP)

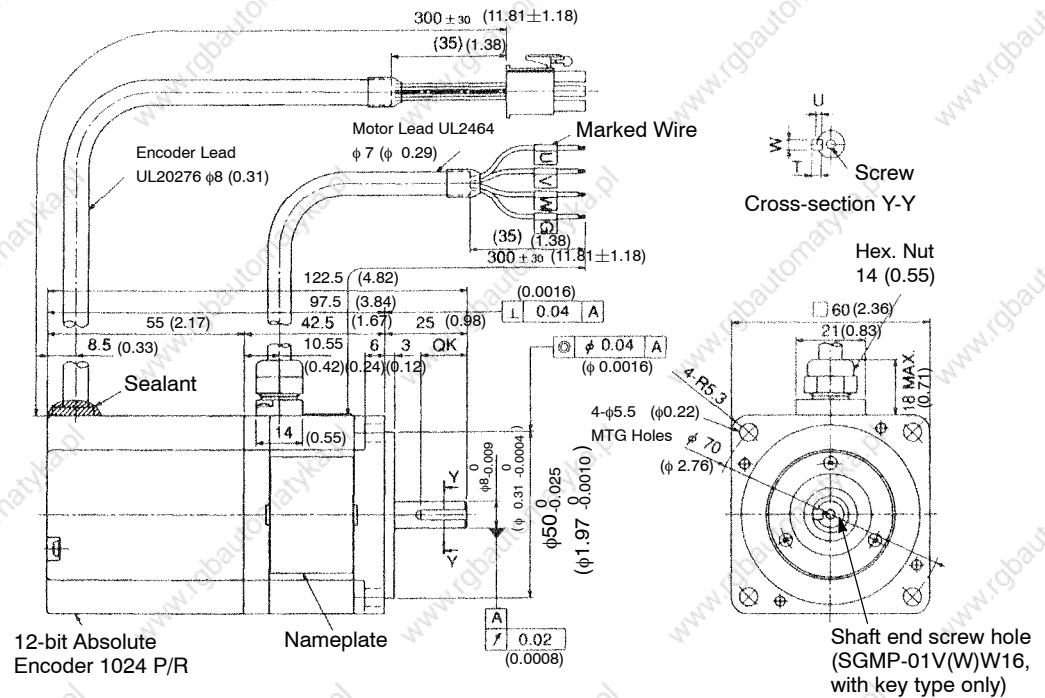

Type SGMP-	QK	U	W	T	Screw dimensions	Output W (HP)	Approx. mass kg (lb)	Allowable radial load N (lb)	Allowable thrust load N (lb)
01VW12	No key				-	100 (0.13)	0.95 (2.09)	78 (17.5)	49 (11.0)
01WW12									
01VW14	14 (0.55)	1.8 (0.07)	3 (0.12)	3 (0.12)	M3, depth 6 (0.24)				
01WW14									
01VW16					M3, depth 6 (0.24)				
01WW16									

- Note**
- 1) The detector uses a 12-bit absolute encoder 1024 P/R.
 - 2) Type "V" indicates 200 V specification, and "W" indicates 100 V specification.
 - 3) "01V(W)W14" and "01V(W)W16" have a keyed shaft. The keyway complies with JIS B 1301-1976 (precision). A straight key is supplied.
 - 4) The quoted allowable radial load is the value at a position 20 mm (0.79 in.) from the motor mounting surface.
 - 5) Conforms to IP55 protective structure (except connector and output shaft faces).

SERVO SELECTION AND DATA SHEETS

5.4.2 Servomotor Dimensional Drawings cont.

- 200 W (0.27 HP), 300 W (0.40 HP) (100 V only), 400 W (0.53HP) (200 V only)

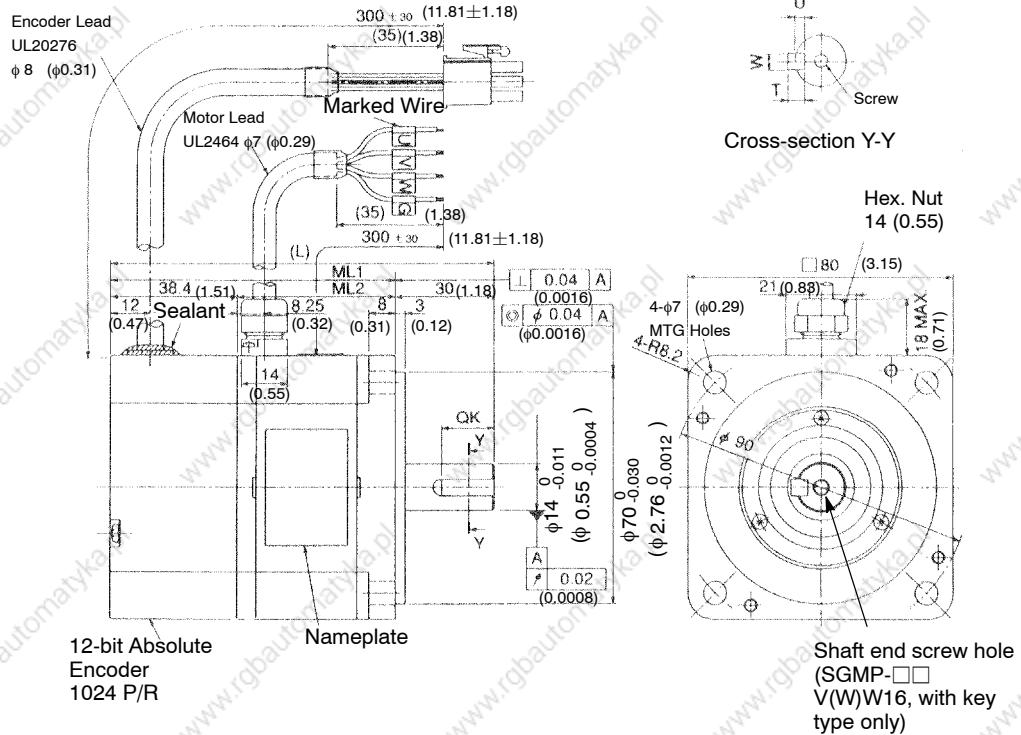

5

Type SGMP-	L	LL	LM	QK	U	W	T	Screw dimensions	Output W (HP)	Approx. mass kg (lb)	Allowable radial load N (lb)	Allowable thrust load N (lb)
02VW12	116.5 (4.59)	86.5 (3.41)	48.1 (1.89)	No key				M5, depth 8 (0.31)	200 (0.27)	1.6 (3.53)	245 (55.1)	68 (15.3)
02WW12				16 (0.63)	3 (0.12)	5 (0.20)	5 (0.20)					
02VW14												
02WW14												
02VW16												
02WW16												
03WW12	136.5 (5.37)	106.5 (4.19)	68.1 (2.68)	No key				M5, depth 8 (0.31)	300 (0.40)	2.3 (5.07)		
03WW14				16 (0.63)	3 (0.12)	5 (0.20)	5 (0.20)					
03WW16												
04VW12				No key				M5, depth 8 (0.31)	400 (0.53)			
04VW14				16 (0.63)	3 (0.12)	5 (0.20)	5 (0.20)					
04VW16												

Note 1) The detector uses a 12-bit absolute encoder 1024 P/R.

2) Type "V" indicates 200 V specification, and "W" indicates 100 V specification.

- 3) "02V(W)W14", "02V(W)W16", "03WW14", "03WW16", "04VW14", and "04VW16" have a keyed shaft. The keyway complies with JIS B 1301-1976 (precision). A straight key is supplied.
- 4) The quoted allowable radial load is the value at a position 25 mm (0.98 in.) from the motor mounting surface.
- 5) Conforms to IP55 protective structure (except connector and output shaft faces).

SERVO SELECTION AND DATA SHEETS

5.4.2 Servomotor Dimensional Drawings (cont.)

• 750 W (1.01HP)

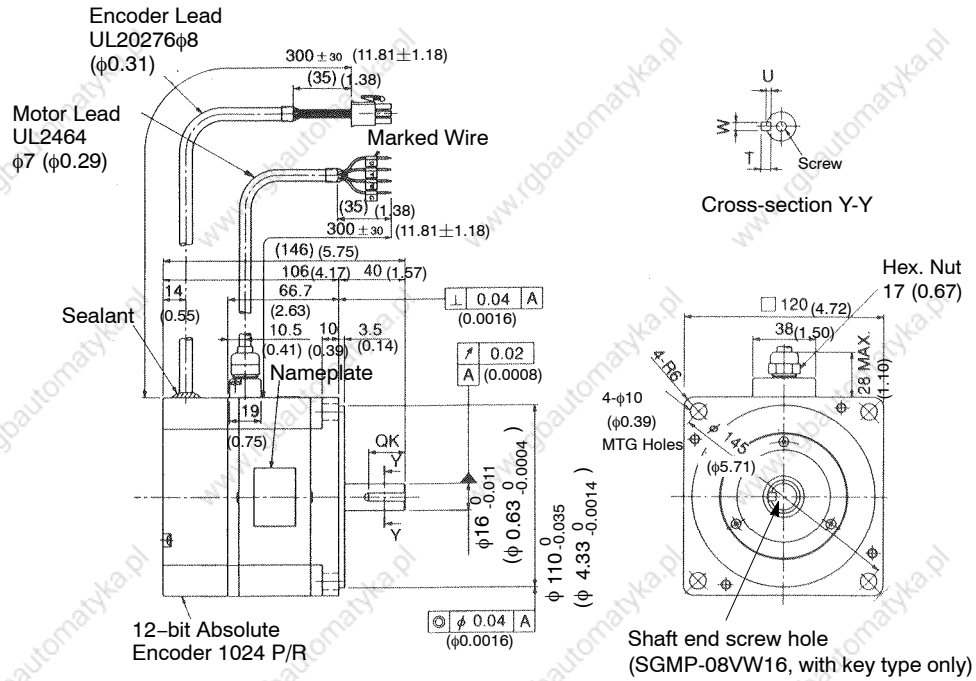

Type SGMP-	QK	U	W	T	Screw dimensions	Output W (HP)	Approx. mass kg (lb)	Allowable radial load N (lb)	Allowable thrust load N (lb)
08VW12	No key				-	750 (1.01)	4.7 (10.36)	392 (88.1)	147 (33.0)
08VW14	22 (0.87)	3 (0.12)	5 (0.20)	5 (0.20)	M5, depth 8 (0.31)				
08VW16									

- Note**
- 1) The detector uses a 12-bit absolute encoder 1024 P/R.
 - 2) Type "V" indicates 200 V specification.
 - 3) "08VW14" and "08VW16" have a keyed shaft. The keyway complies with JIS B 1301-1976 (precision). A straight key is supplied.
 - 4) The quoted allowable radial load is the value at a position 35 mm (1.38 in.) from the motor mounting surface.
 - 5) Conforms to IP55 protective structure (except connector and output shaft faces).

• Details of Motor and Encoder Plugs (Common for 100 W (0.13 HP) to 750 W (1.01 HP))

Motor Plug



Plug : 172167-1 (AMP)
Pin 170360-1 or 170364-1
Connected to
Cap 172159-1
Socket 170362-1 or 170366-1

Encoder Plug

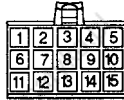

Plug: 172171-1 (AMP)
Pin: 170359-1 or 170363-1
Connected to
Cap :172163-1
Socket: 170361-1 or 170365-1

Motor Wiring Specifications

1	U phase	Red
2	V phase	White
3	W phase	Blue
4	FG	Green/Yellow

Absolute Encoder Wiring Specifications

1	A channel output	Blue
2	\bar{A} channel output	White/Blue
3	B channel output	Yellow
4	\bar{B} channel output	White/Yellow
5	Z channel output	Green
6	\bar{Z} channel output	White/Green
7	0V (power supply)	Black
8	+5 V(power supply)	Red
9	FG (Frame Ground)	Green/Yellow
10	S channel output	Purple
11	\bar{S} channel output	White/Purple
* (12)	(Capacitor reset)	(Gray)
13	Reset	White/Gray
14	0V(battery)	White/Orange
15	3.6V(battery)	Orange

* Terminal to discharge capacitor for product dispatch.
Do not use.

SERVO SELECTION AND DATA SHEETS

5.4.2 Servomotor Dimensional Drawings cont.

(4) TÜV approved (conforming to the machine instructions) SGMP Servomotor

Absolute encoder, with brake (Type SGMP-□□□W1□B)

• 100 W (0.13 HP)

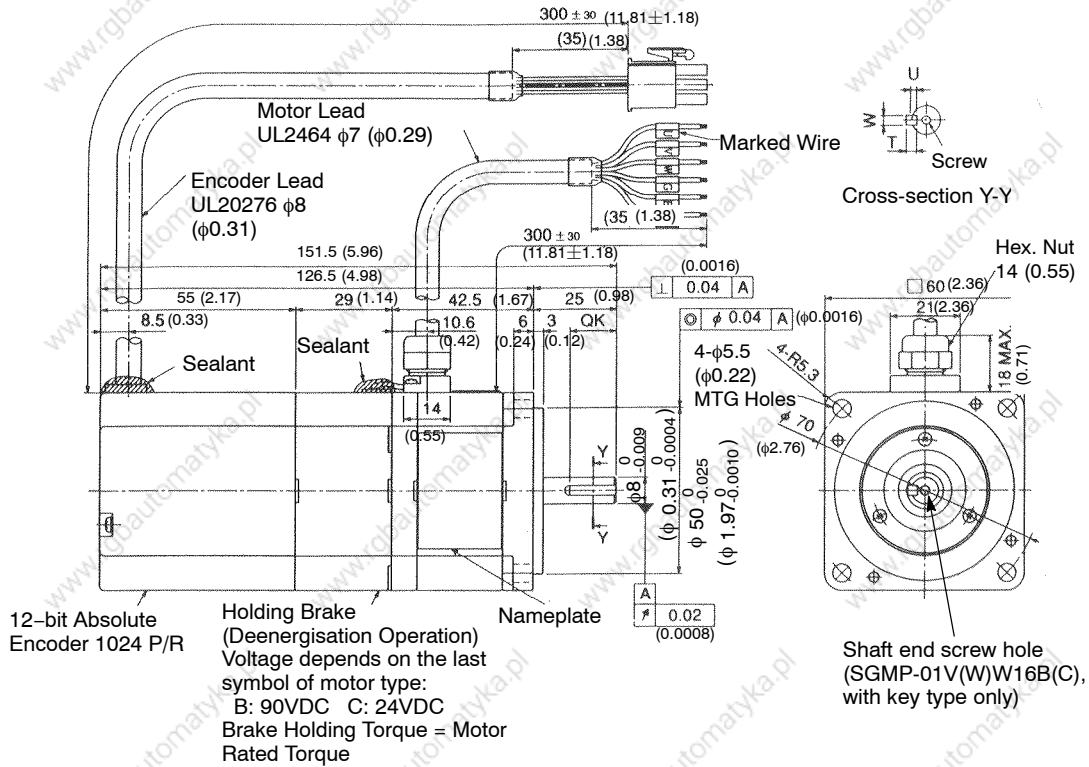

Type SGMP-	QK	U	W	T	Screw dimensions	Output W (HP)	Approx. mass kg (lb)	Allowable radial load N (lb)	Allowable thrust load N (lb)
01VW12B(C)	No key				---	100 (0.13)	1.2 (2.65)	78 (17.5)	49 (11.0)
01WW12B(C)									
01VW14B(C)	14 (0.55)	1.8 (0.07)	3 (0.12)	3 (0.12)	M3, depth 6 (0.24)				
01WW14B(C)									
01VW16B(C)									
01WW16B(C)									

- Note**
- 1) The detector uses a 12-bit absolute encoder 1024 P/R.
 - 2) Type "V" indicates 200 V specification, and "W" indicates 100 V specification.
 - 3) "01VW14B(C)", "01VW16B(C)", "01WW14B(C)" and "01WW16B(C)" have a keyed shaft. The keyway complies with JIS B 1301-1976 (precision). A straight key is supplied.

- 4) The quoted allowable radial load is the value at a position 20 mm (0.79 in.) from the motor mounting surface.
- 5) The electromagnetic brake is only to hold the load in position and cannot be used to stop the motor.
- 6) Conforms to IP55 protective structure (except connector and output shaft faces).

SERVO SELECTION AND DATA SHEETS

5.4.2 Servomotor Dimensional Drawings cont.

- 200 W (0.27 HP), 300 W (0.40 HP), 400 W (0.53 HP)

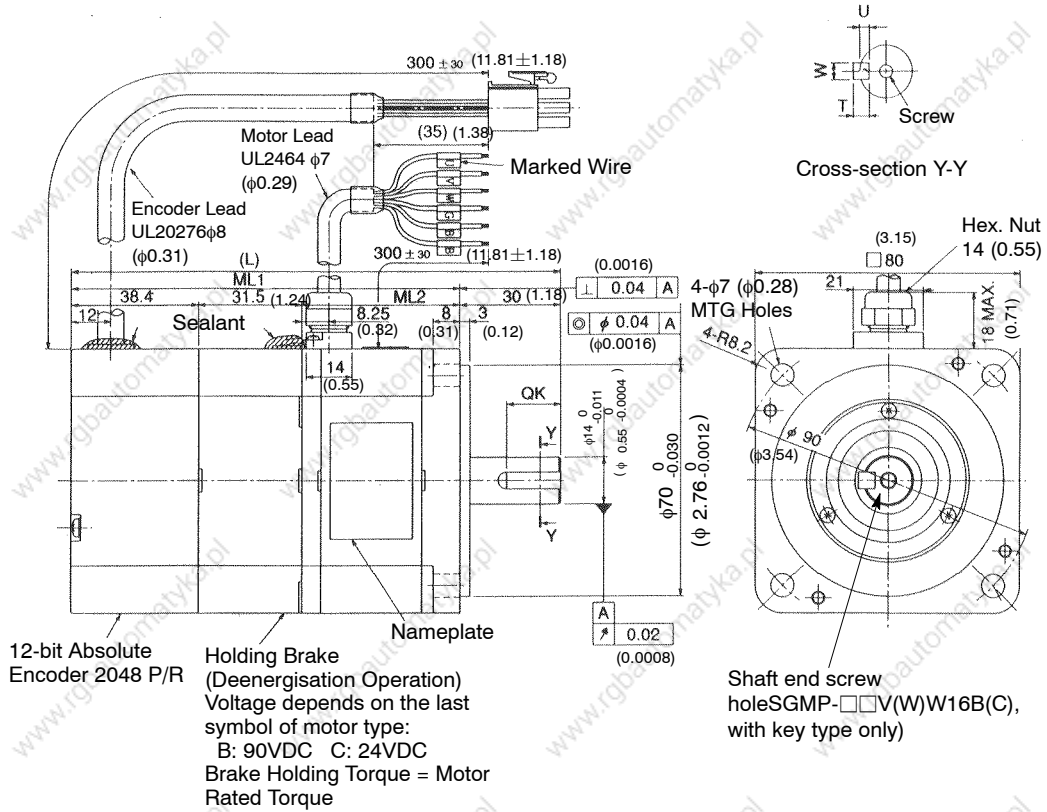

5

Type SGMP-	L	LL	LM	QK	U	W	T	Screw dimensions	Output W (HP)	Approx. mass kg (lb)	Allowable radial load N (lb)	Allowable thrust load N (lb)	
02VW12B(C)	148 (5.83)	118 (4.65)	48.1 (1.89)	No key				---	M5, depth 8 (0.31)	200 (0.27)	2.3 (5.07)	245 (55.1)	68 (15.3)
02WW12B(C)				16 (0.63)	3 (0.12)	5 (0.20)	5 (0.20)						
02VW14B(C)													
02WW14B(C)													
02VW16B(C)													
02WW16B(C)													
03VW12B(C)	168 (6.61)	138 (5.43)	68.1 (2.68)	No key				---	M5, depth 8 (0.31)	300 (0.40)	3.0 (6.61)		
03WW12B(C)				16 (0.63)	3 (0.12)	5 (0.20)	5 (0.20)						
03VW14B(C)													
03WW14B(C)													
03VW16B(C)													
03WW16B(C)													
04VW12B(C)	168 (6.61)	138 (5.43)	68.1 (2.68)	No key				---	M5, depth 8 (0.31)	400 (0.53)			
04VW14B(C)				16 (0.63)	3 (0.12)	5 (0.20)	5 (0.20)						
04VW16B(C)													
04VW12B(C)													
04VW14B(C)													
04VW16B(C)													

Note 1) The detector uses a 12-bit absolute encoder 1024 P/R.

- 2) Type “V” indicates 200 V specification, and “W” indicates 100 V specification.
- 3) “02V(W)W14B”, “02V(W)W16B”, “03WW14B”, “03WW16B”, “04VW14B”, and “04VW16B” have a keyed shaft. The keyway complies with JIS B 1301-1976 (precision). A straight key is supplied.
- 4) The quoted allowable radial load is the value at a position 25 mm (0.98 in.) from the motor mounting surface.
- 5) The electromagnetic brake is only to hold the load in position and cannot be used to stop the motor.
- 6) Conforms to IP55 protective structure (except connector and output shaft faces).

• 750 W (1.01 HP)

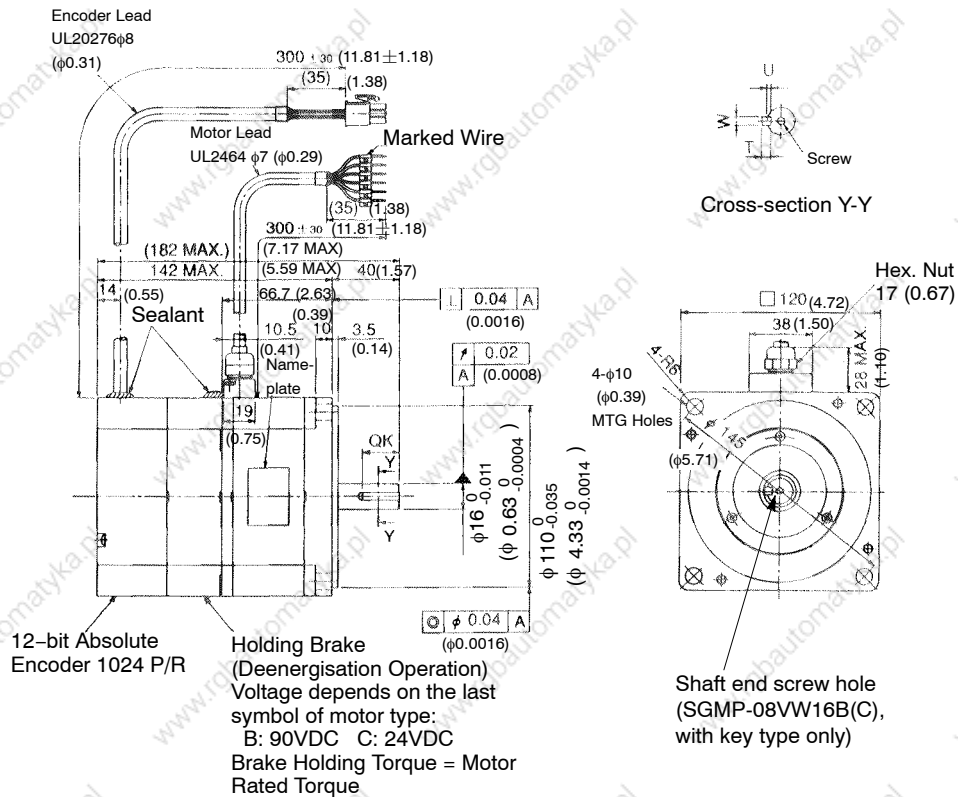

Type SGMP-	QK	U	W	T	Screw dimen- sions	Output W (HP)	Approx. mass kg (lb)	Allowable radial load N (lb)	Allowable thrust load N (lb)
08VW12B(C)	No key				M5 depth 8 (0.31)	750 (1.01)	6.2 (13.67)	392 (88.1)	147 (33.0)
08VW14B(C)	22 (0.87)	3 (0.12)	5 (0.20)	5 (0.20)					
08VW16B(C)									

SERVO SELECTION AND DATA SHEETS

5.4.2 Servomotor Dimensional Drawings cont.

- Note**
- 1) The detector uses a 12-bit absolute encoder 1024 P/R.
 - 2) Type “V” indicates 200 V specification.
 - 3) “08VW14B(C)” and “08VW16B(C)” have a keyed shaft. The keyway complies with JIS B 1301-1976 (precision). A straight key is supplied.
 - 4) The quoted allowable radial load is the value at a position 35 mm (1.38 in) from the motor mounting surface.
 - 5) The electromagnetic brake is only to hold the load in position and cannot be used to stop the motor.
 - 6) Conforms to IP55 protective structure (except connector and output shaft faces).

- Details of Motor and Encoder Plugs (Common for 100W (0.13 HP) to 750 W (1.01 HP))

Motor Plug



Plug : 172168-1 (AMP)
 Pin 170360-1 or 170364-1(1 to 4pin)
 170359-1 or 170363 (5 to 6 pin)
 (17360-1 or 17364-1:only 750W)
 Connected to
 Cap 172160-1
 Socket 170362-1 or 170366-1

Motor Wiring Specifications

1	U phase	Red
2	V phase	White
3	W phase	Blue
4	FG	Green/Yellow
5	Brake terminal	Black
6	Brake terminal	Black

Encoder Plug

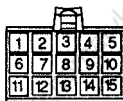

Plug: 172171-1 (AMP)
 Pin: 170359-1 or 170363-1
 Connected to
 Cap :172163-1
 Socket: 170361-1 or 170365-1

Absolute Encoder Wiring Specifications

1	A channel output	Blue
2	\bar{A} channel output	White/Blue
3	B channel output	Yellow
4	\bar{B} channel output	White/Yellow
5	Z channel output	Green
6	\bar{Z} channel output	White/Green
7	0 V (power supply)	Black
8	+5 V (power supply)	Red
9	FG (Frame Ground)	Green/Yellow
10	S channel output	Purple
11	\bar{S} channel output	White/Purple
* (12)	(Capacitor reset)	(Gray)
13	Reset	White/Gray
14	0V(battery)	White/Orange
15	3.6V(battery)	Orange

* Terminal to discharge capacitor for product dispatch. Do not use.

5.4.3 Servopack Dimensional Drawings

- 1) The dimension drawings of the DR2 Servopack are broadly grouped into the following two categories according to capacity and option specifications (semi-closed or full-closed loop).
 - a) Semi-closed loop (standard)
200V, 30W (0.04 HP) to 200 W (0.27HP) (Types: DR2-A3A□ to 02A□)
100V, 30W (0.04 HP) to 100 W (0.13HP) (Types: DR2-A3B□ to 01B□)
 - b) Semi-closed loop (standard)
200V, 400W (0.53 HP), 750W (1.01 HP) (Types: DR2-04A□, 08A□)
100V, 200W (0.27 HP), 300W (0.40 HP) (Types: DR2-02B□, 03B□)
 - c) Full-closed loop (option)
200V, 30W (0.04 HP) to 200W (0.27 HP) (Types: DR2-A3A□-F to 02A□-F)
100V, 30W (0.04 HP) to 100W (0.13 HP) (Types: DR2-A3B□-F to 01B□-F)
 - d) Full-closed loop (option)
200V, 400W (0.53 HP) to 750W (1.01 HP) (Types: DR2-04A□-F to 08A□-F)
100V, 200W (0.27 HP) to 300W (0.40 HP) (Types: DR2-02B□-F to 03B□-F)

SERVO SELECTION AND DATA SHEETS

5.4.3 Servopack Dimensional Drawings cont.

a) Semi-closed loop (standard)

DR2-A3A□ to 02A□ (200V, 30W (0.04 HP) to 200 W (0.27HP))

DR2-A3B□ to 01B□ (100V, 30W (0.04 HP) to 100 W (0.13HP))

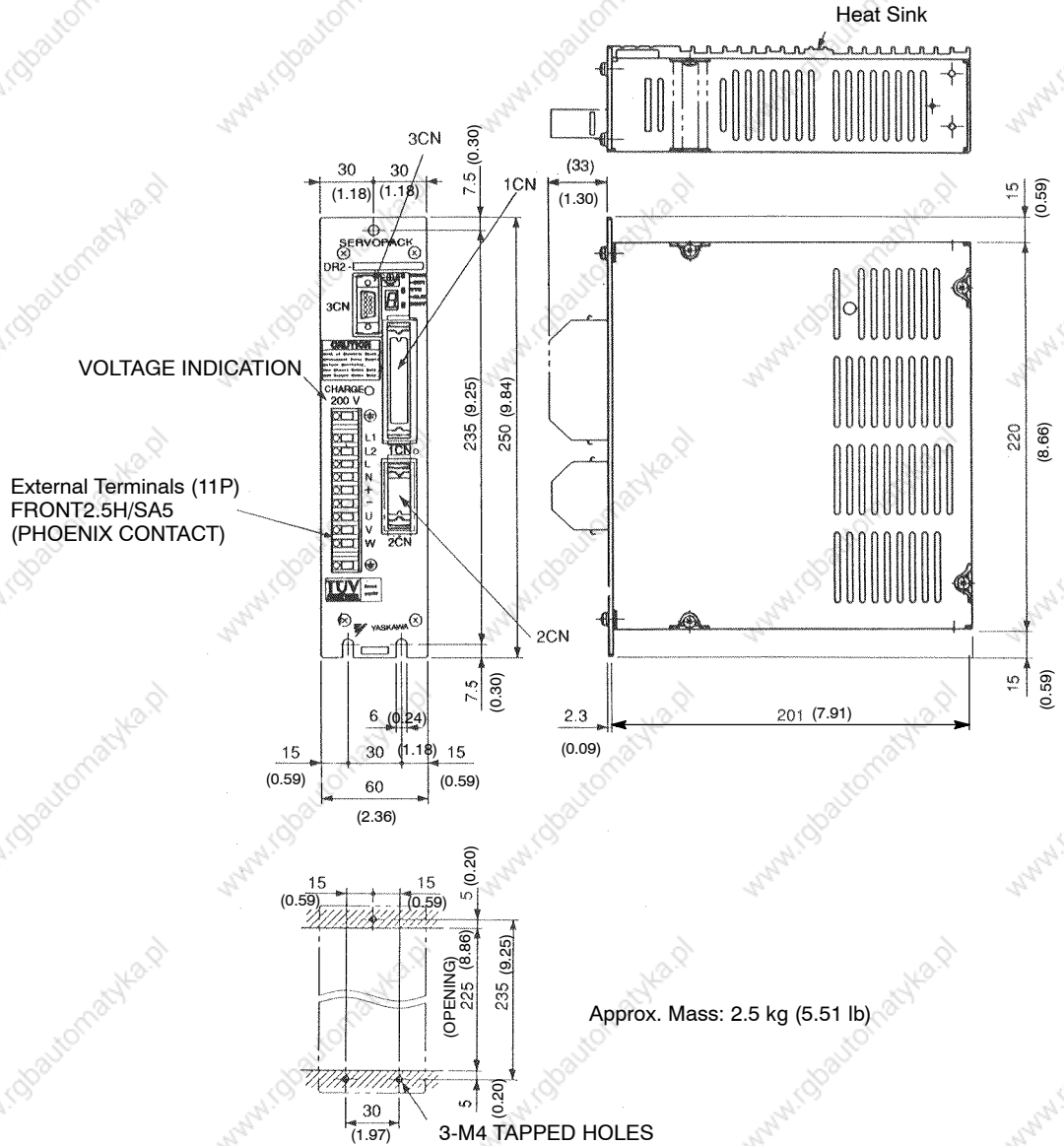

5

b) Semi-closed loop (standard)

- DR2-04A□, 08A□ (200V, 400W (0.53 HP), 750W (1.01 HP))
- DR2-02B□, 03B□ (100V, 200W (0.27 HP), 300W (0.40 HP))

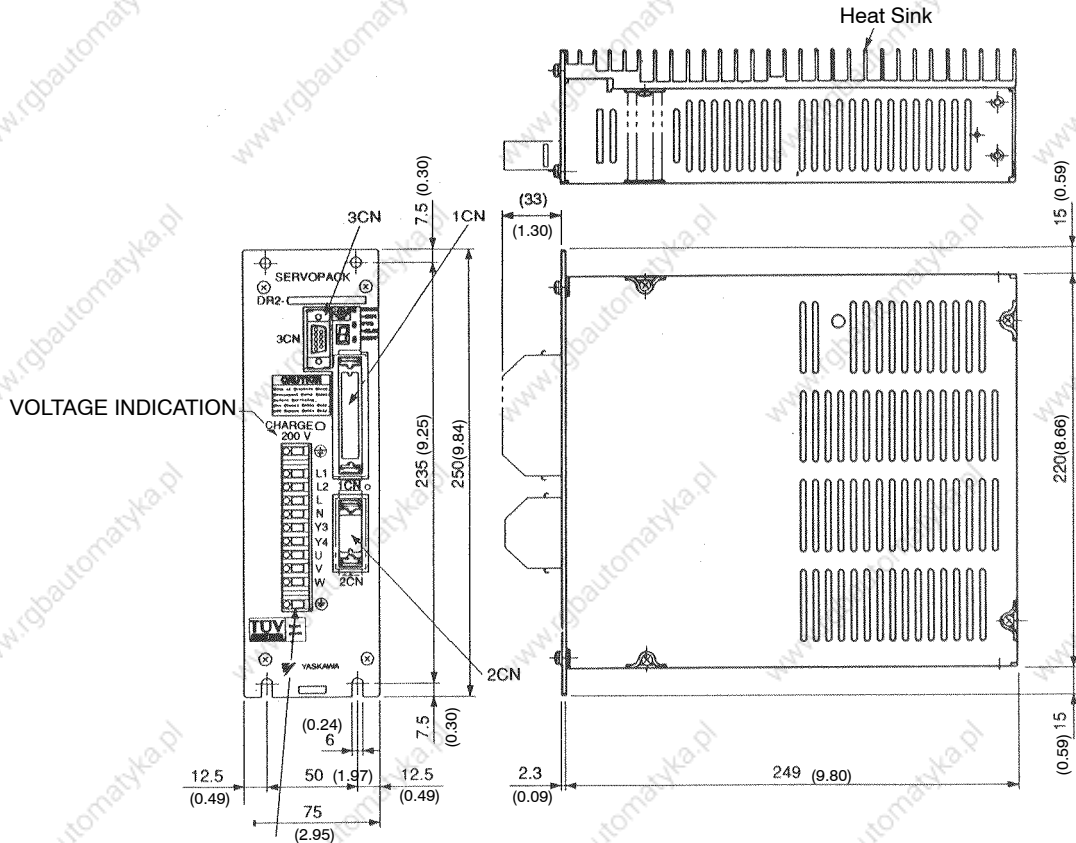

External Terminals (11P)
FRONT2.5H/SA5
(PHOENIX CONTACT)

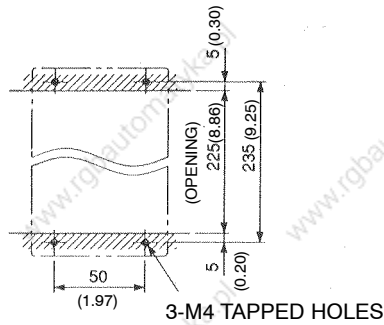

Approx. Mass: 3.7 kg (8.16 lb)

SERVO SELECTION AND DATA SHEETS

5.4.3 Servopack Dimensional Drawings cont.

c) Full-closed loop (option)

200V, 30W (0.04 HP) to 200W (0.27 HP) (Types: DR2-A3A□-F to 02A□-F)

100V, 30W (0.04 HP) to 100W (0.13 HP) (Types: DR2-A3B□-F to 01B□-F)

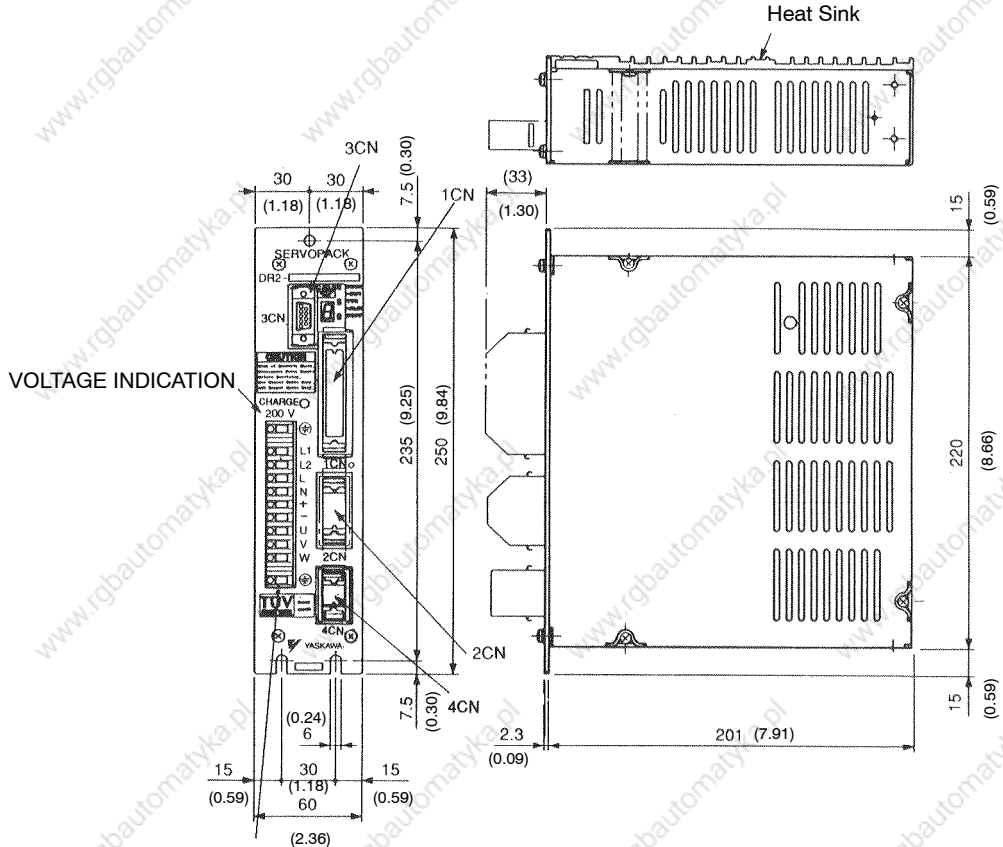

External Terminals (11P)
FRONT 2.5H/SA5 (PHOENIX CONTACT)

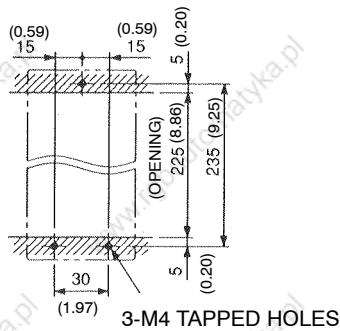

Approx. Mass: 2.5 kg (5.51 lb)

5

- d) Full-closed loop (option)
 200V, 400W (0.53 HP) to 750W (1.01 HP) (Types: DR2-04A□-F to 08A□-F)
 100V, 200W (0.27 HP) to 300W (0.40 HP) (Types: DR2-02B□-F to 03B□-F)

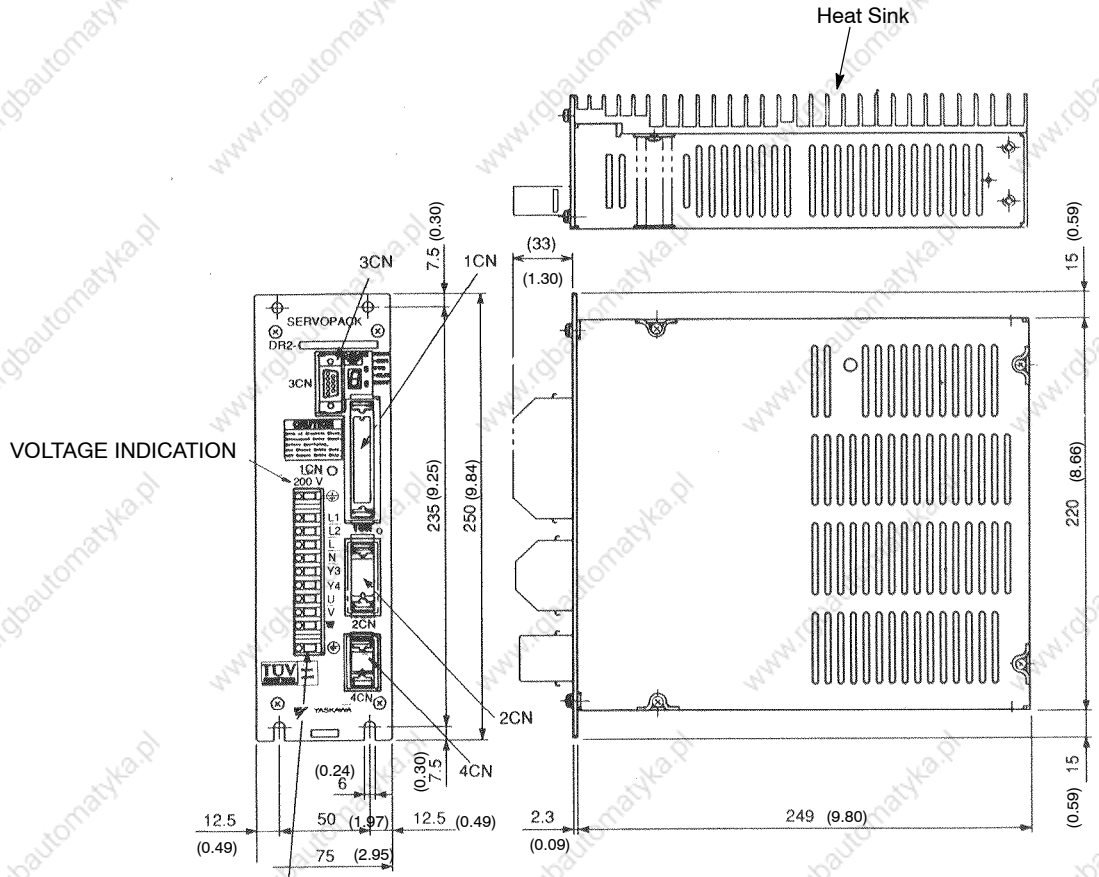

External Terminals (11P)
 FRONT2.5H/SA5
 (PHOENIX CONTACT)

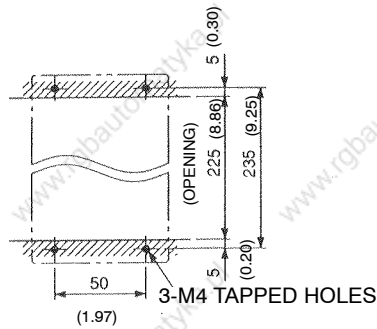

Approx. Mass: 3.7 kg (8.16 lb)

5.4.4 Digital Operator Dimensional Drawing

a) JUSP-OP02A-1 (Hand-held type)

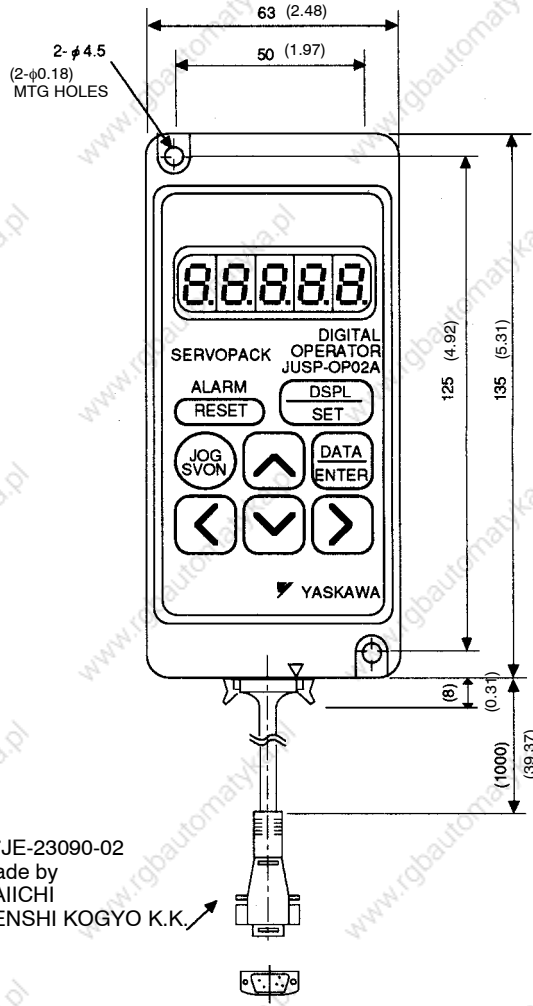

Approx. Mass: 0.18 kg (0.40 lb)

Note Mount type digital operator (type: JUSP-OP03A) cannot be used for DR2 Servopack.

5.5 Selecting Peripheral Devices

This section shows how to select peripheral devices using flowcharts. Order lists for Servomotors, Servopacks, digital operators, and peripheral devices are also included.

5.5.1	Selecting Peripheral Devices	335
5.5.2	Order List	341

5.5.1 Selecting Peripheral Devices

Select the peripheral devices using the flowcharts on the subsequent pages.

The items below are not included in the flowcharts. Refer to *5.6 Specifications and Dimensional Drawings of Peripheral Devices*.

- Variable resistors for speed setting
- Encoder signal converter units
- Cables for connecting PC and Servopack

<Flowchart for peripheral device selection>

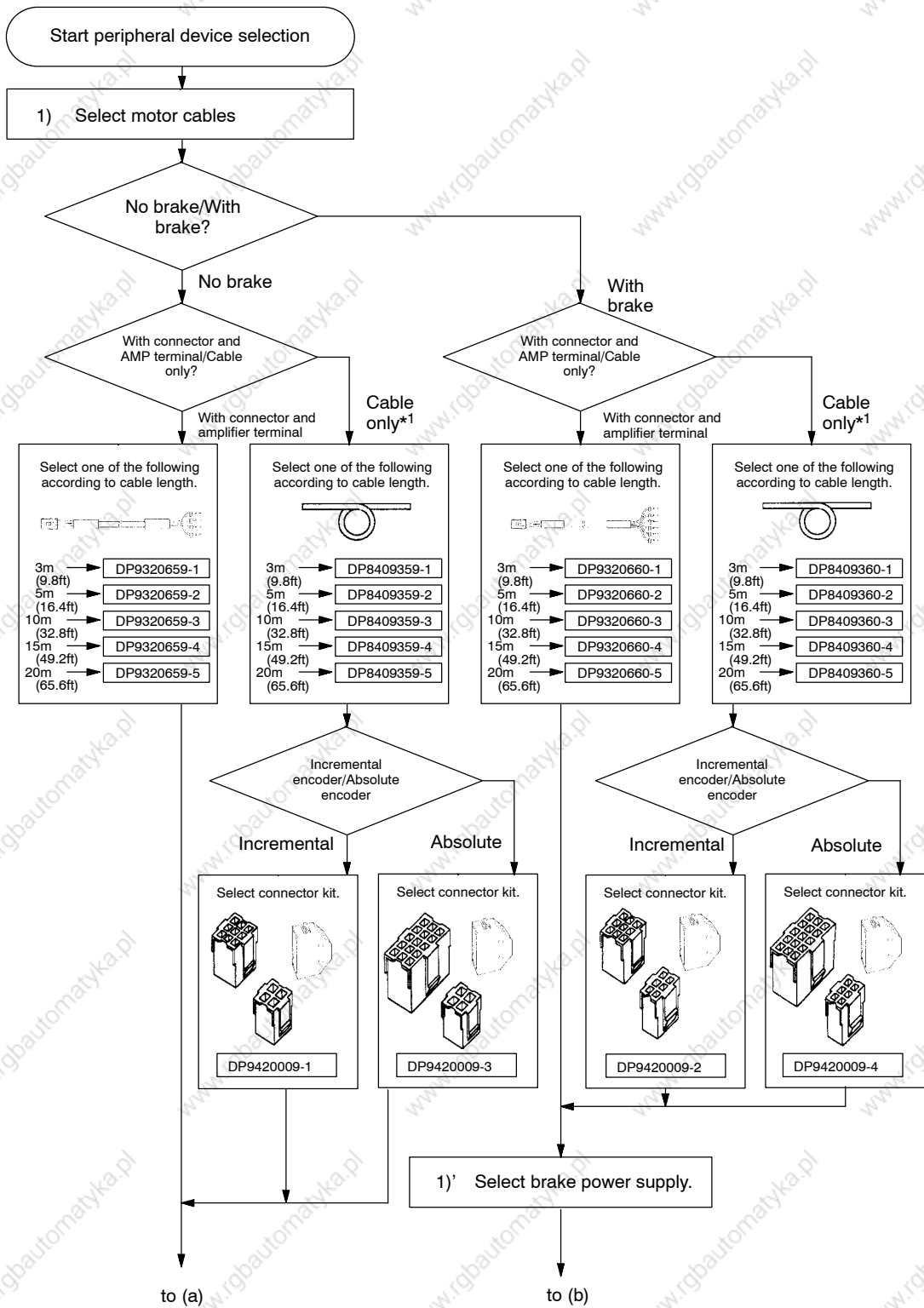

*1 When approved cable is required, use the following cable :
 VDE250 approved, without brake : $4 \times 0.75\text{mm}^2$
 with brake : $7 \times 0.75\text{mm}^2$

5

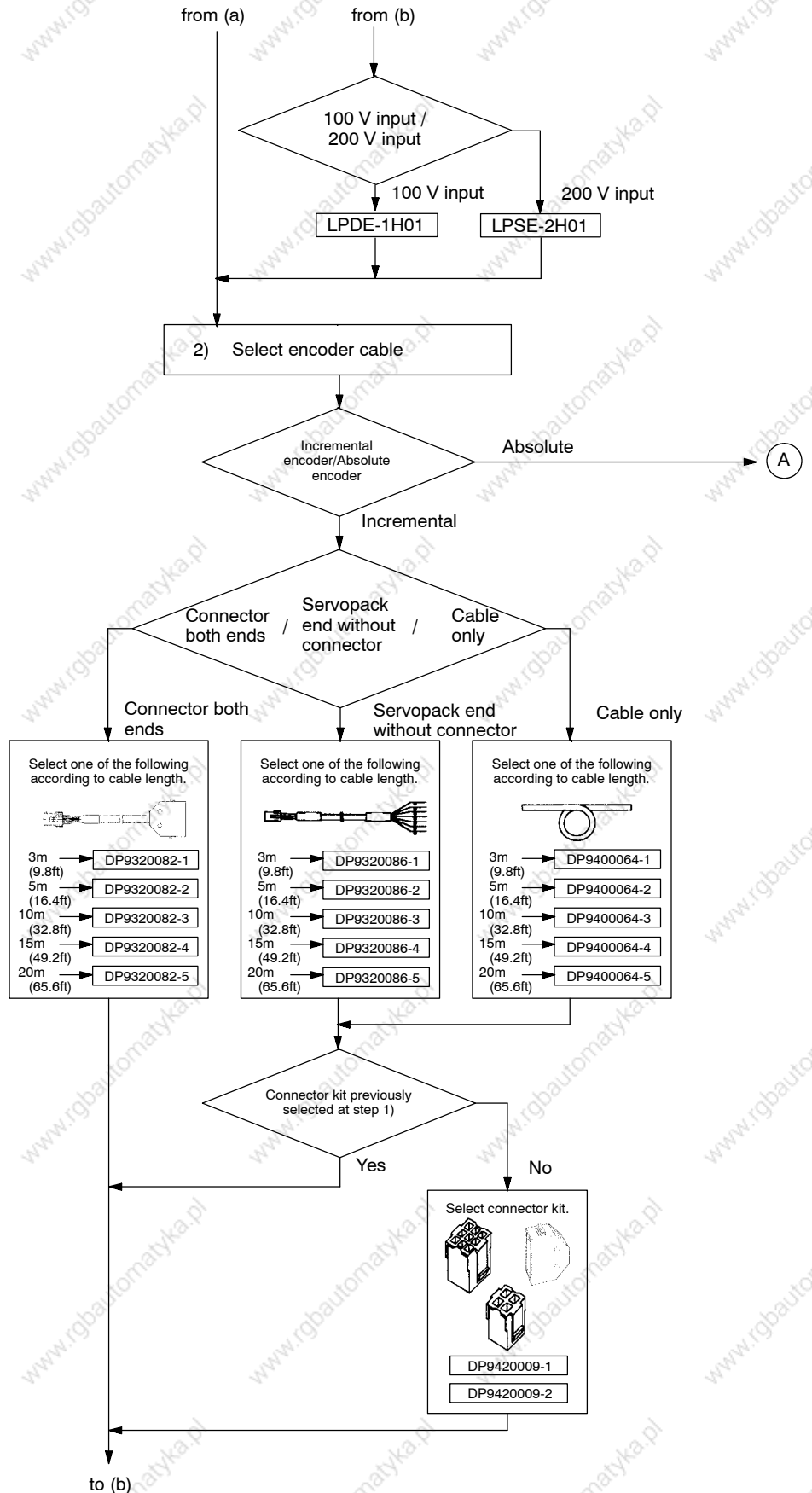

5.5.1 Selecting Peripheral Devices cont.

(A)

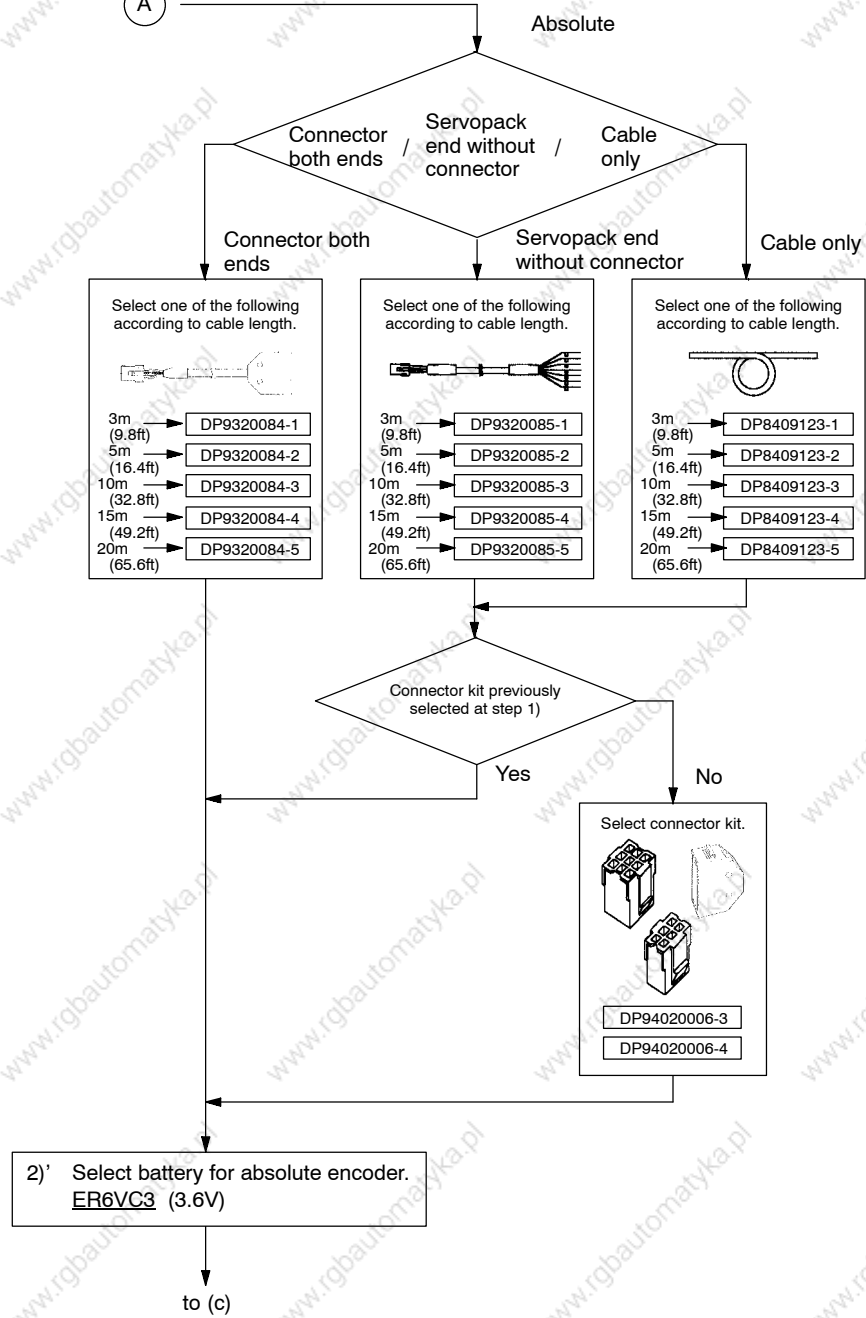

5

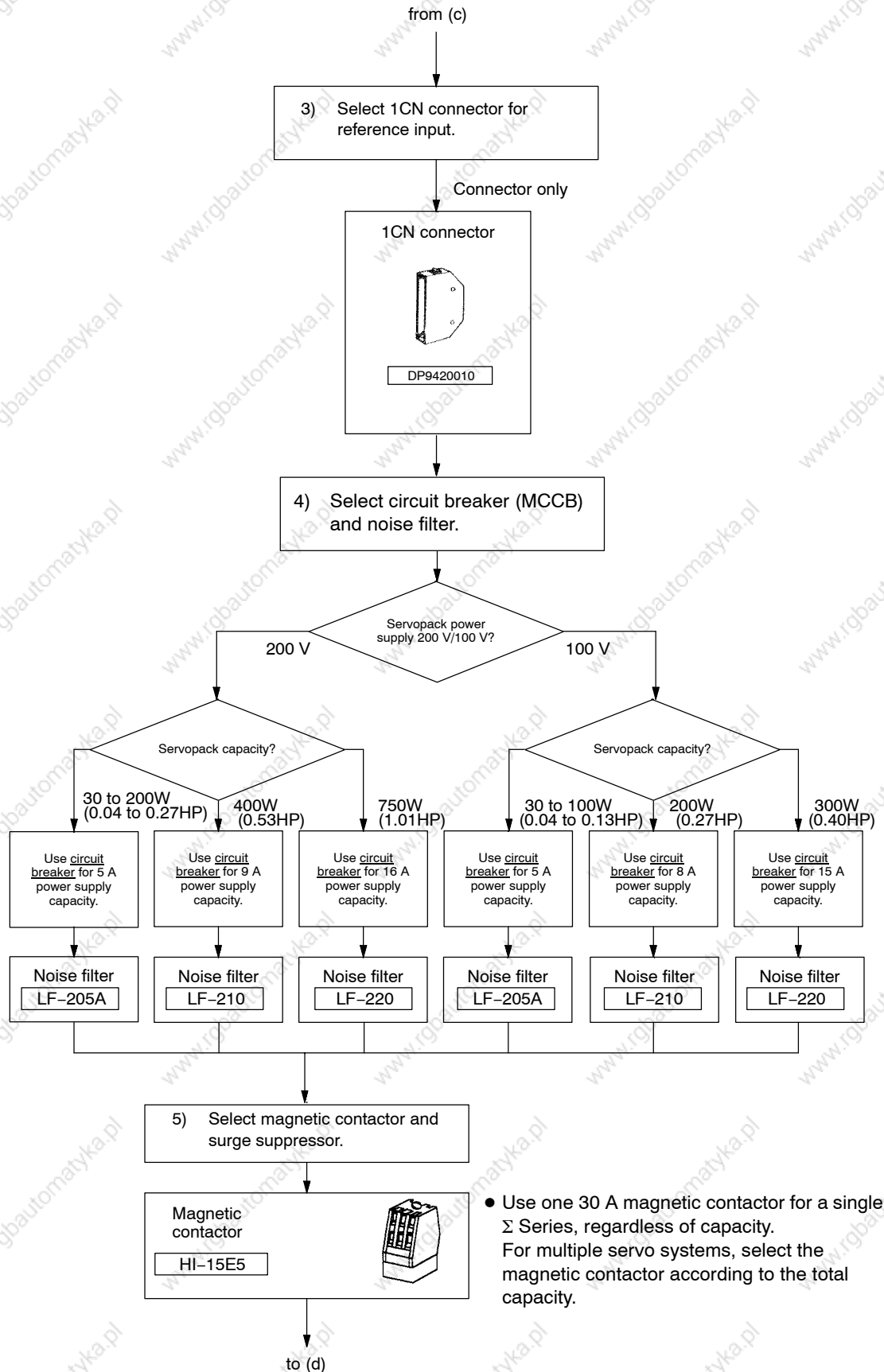

5.5.1 Selecting Peripheral Devices cont.

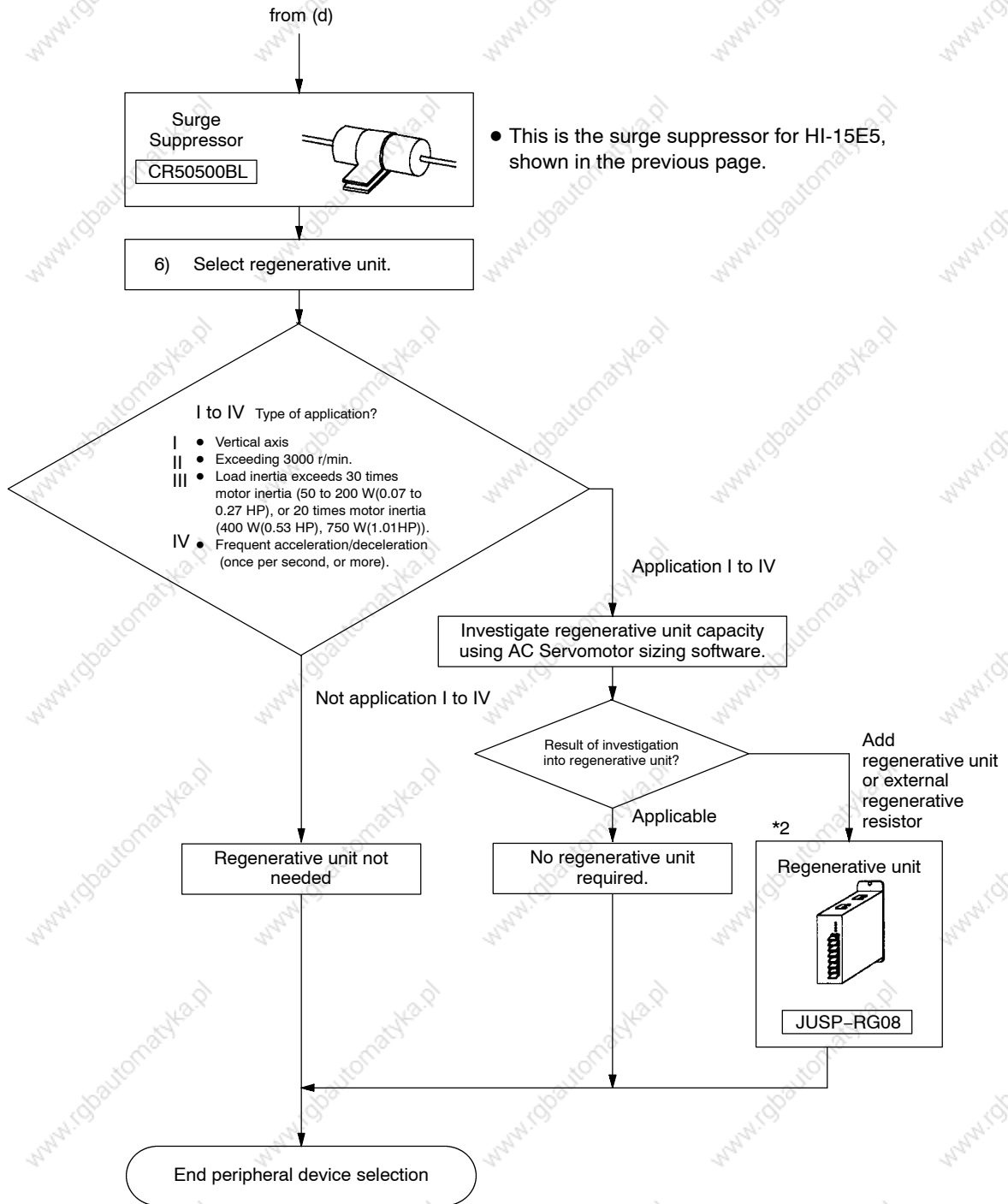

*2 Regenerative unit : applicable to 200V 30W to 200W
 External regenerative resistor : applicable to 100V 200W, 300W or 200V 400W, 750W
 When power supply is 100V, 30W to 100W, review the application using larger capacity Servopack.

5

5.5.2 Order List

- 1) Order lists are given below for the Servomotors, Servopacks, digital operators, and peripheral devices which comprise the AC Servo Σ -Series. These order lists are a convenient aid to selecting peripheral devices.

SGM Servomotor

Servomotor Type	Qty
SGM-□□□□□□□□	
SGM-□□□□□□□□	
SGM-□□□□□□□□	
SGM-□□□□□□□□	
SGM-□□□□□□□□	
SGM-□□□□□□□□	

DR2 Servopack (excluding cables and connectors)

Servopack Type	Qty
DR2-□□□□-□	
DR2-□□□□-□	
DR2-□□□□-□	
DR2-□□□□-□	
DR2-□□□□-□	
DR2-□□□□-□	

SGMP Servomotor

Servomotor Type	Qty
SGMP-□□□□□□□□	
SGMP-□□□□□□□□	
SGMP-□□□□□□□□	
SGMP-□□□□□□□□	
SGMP-□□□□□□□□	
SGMP-□□□□□□□□	

Digital Operator

(Purchase Separately)

Digital Operator Type	Qty
JUSP-OP02A-1	

SERVO SELECTION AND DATA SHEETS

5.5.2 Order List cont.

M1

Cables for Servomotor without Brake

(with connector and amplifier terminals)

(Purchase Separately)

Cable Type	Qty
DP9320659-1	3 m (9.8 ft)
DP9320659-2	5 m (16.4 ft)
DP9320659-3	10 m (32.8 ft)
DP9320659-4	15 m (49.2 ft)
DP9320659-5	20 m (65.6 ft)



M2

Cables for Servomotor without Brake

(Cable Only)*1

(Purchase Separately)

Cable Type	Qty
DP8409359-1	3 m (9.8 ft)
DP8409359-2	5 m (16.4 ft)
DP8409359-3	10 m (32.8 ft)
DP8409359-4	15 m (49.2 ft)
DP8409359-5	20 m (65.6 ft)



*1 Customer to attach connector and amplifier terminals. Requires **K1** connector kit.

M3

Cables for Servomotor with Brake

(with connector and amplifier terminals)

(Purchase Separately)

Cable Type	Qty
DP9320660-1	3 m (9.8 ft)
DP9320660-2	5 m (16.4 ft)
DP9320660-3	10 m (32.8 ft)
DP9320660-4	15 m (49.2 ft)
DP9320660-5	20 m (65.6 ft)

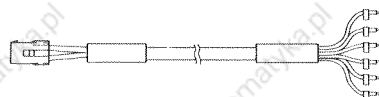

M4

Cables for Servomotor with Brake

(Cable Only)*1

(Purchase Separately)

Cable Type		Qty
DP8409360-1	3 m (9.8 ft)	
DP8409360-2	5 m (16.4 ft)	
DP8409360-3	10 m (32.8 ft)	
DP8409360-4	15 m (49.2 ft)	
DP8409360-5	20 m (65.6 ft)	

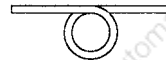

*1 Customer to attach connector and amplifier terminals. Requires **K1** connector kit.

K1

Connector Kits

(Purchase Separately)

Connector Kit Type	Qty
DP9420009-1 (Incremental encoder, no brake)	
DP9420009-2 (Incremental encoder, with brake)	
DP9420009-3 (Absolute encoder, no brake)	
DP9420009-4 (Absolute encoder, with brake)	

- The three products in the diagrams below are supplied as a set.

- Encoder Connector for Motor End of Cable ... one connector for incremental or absolute encoder
- Motor Connector for Motor End of Cable ... one connector for Servomotor with or without brake
- Encoder Connector for Servopack End of Cable ... one 2CN connector

- Encoder Connector for Motor End of Cable

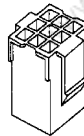

For Incremental Encoder

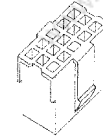

For Absolute Encoder

- Motor Connector for Motor End of Cable

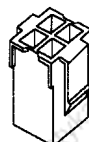

No Brake

- Encoder Connector for Servopack End of Cable

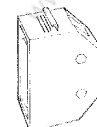

Brake Power Supply (for motor with brake)

(Purchase Separately)

Brake Power Supply Type	Qty
LPSE-2H01 (for 200 V)	
LPDE-1H01 (for 100 V)	

E1

Cables for Incremental Encoder

(Connector Both Ends)

(Purchase Separately)

Cable Type	Qty
DP9320082-1	3m (9.8 ft)
DP9320082-2	5m (16.4 ft)
DP9320082-3	10m (32.8 ft)
DP9320082-4	15m (49.2 ft)
DP9320082-5	20m (65.6 ft)



5

E2

Cables for Incremental Encoder

(Servopack end without connectors)*2

(Purchase Separately)

Cable Type	Qty
DP9320086-1	3m (9.8 ft)
DP9320086-2	5m (16.4 ft)
DP9320086-3	10m (32.8 ft)
DP9320086-4	15m (49.2 ft)
DP9320086-5	20m (65.6 ft)

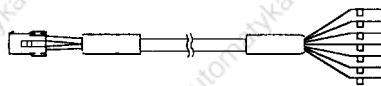

*2 Customer to attach connector to Servopack end of cable. Requires **K1** connector kit.

E3

Cables for Incremental Encoder

(Cable Only)*3

(Purchase Separately)

Cable Type		Qty
B9400064-1	3m (9.8 ft)	
B9400064-2	5m (16.4 ft)	
B9400064-3	10m (32.8 ft)	
B9400064-4	15m (49.2 ft)	
B9400064-5	20m (65.6 ft)	



*3 Customer to attach connector to both ends of cable. Requires **K1** connector kit.

E4

Cables for Absolute Encoder

(Connector Both Ends)

(Purchase Separately)

Cable Type		Qty
DP9320084-1	3m (9.8 ft)	
DP9320084-2	5m (16.4 ft)	
DP9320084-3	10m (32.8 ft)	
DP9320084-4	15m (49.2 ft)	
DP9320084-5	20m (65.6 ft)	



SERVO SELECTION AND DATA SHEETS

5.5.2 Order List cont.

E5

Cables for Absolute Encoder

(Servopack end without connectors)*2

(Purchase Separately)

Cable Type	Qty
DP9320085-1	3m (9.8 ft)
DP9320085-2	5m (16.4 ft)
DP9320085-3	10m (32.8 ft)
DP9320085-4	15m (49.2 ft)
DP9320085-5	20m (65.6 ft)



*2 Customer to attach connector to Servopack end of cable. Requires K1 connector kit.

E6

Cables for Absolute Encoder

(Cable Only)*3

(Purchase Separately)

Cable Type	Qty
DP8409123-1	3m (9.8 ft)
DP8409123-2	5m (16.4 ft)
DP8409123-3	10m (32.8 ft)
DP8409123-4	15m (49.2 ft)
DP8409123-5	20m (65.6 ft)



*3 Customer to attach connector to both ends of cable. Requires K1 connector kit.

Battery for Absolute Encoder

(Purchase Separately)

Battery Type	Qty
ER6VC3 (3.6V)	

C1

1CN Connector

(Purchase Separately)

Connector Type	Qty
DP9420010	

One 1CN Connector

**Noise Filter**

(Purchase Separately)

Noise Filter Type	Qty
LF-205A (5A)	
LF-210 (10A)	
LF-220 (20A)	

Magnetic Contactor

(Purchase Separately)

Magnetic Contactor Type	Qty
HI-15E5 (30A)	

Surge Suppressor

(Purchase Separately)

Surge Suppressor Type	Qty
CR50500BL	

Regenerative Unit *4

(Purchase Separately)

Regenerative Unit Type	Qty
JUSP-RG08	

*4 Applicable only to 200V, 30W to 200W specification.

SERVO SELECTION AND DATA SHEETS

5.5.2 Order List cont.

Variable Resistor for Speed Setting

(Purchase Separately)

Variable Resistor Type	Qty
25HP-10B	

Cables for Connecting PC and Servopack

(Purchase Separately)

Cable Type	Qty
DE9405258	2m (6.6 ft)

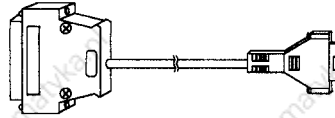

Encoder Signal Converter Unit

(Purchase Separately)

Unit Type	Qty
LRX-01/A1	
LRX-01/A2	
LRX-01/A3	
LRX-01/A4	

5

5.6 Specifications and Dimensional Drawings of Peripheral Devices

This section shows the specifications and dimensional drawings of the peripheral devices required for the Σ -Series servo system. The sequence of peripheral devices is given by the Flowchart for Peripheral Device Selection in *5.5 Selecting Peripheral Devices*.

5.6.1	Cable Specifications and Peripheral Devices	349
5.6.2	Motor Cables	355
5.6.3	Connector Kits	358
5.6.4	Brake Power Supply	363
5.6.5	Encoder Cables	365
5.6.6	Battery for Absolute Encoder	371
5.6.7	1CN Connector	371
5.6.8	Circuit Breaker	373
5.6.9	Noise Filter	374
5.6.10	Magnetic Contactor	375
5.6.11	Surge Suppressor	376
5.6.12	Regenerative Unit	376
5.6.13	Variable Resistor for Speed Setting	379
5.6.14	Encoder Signal Converter Unit	379
5.6.15	Cables for Connecting PC and Servopack	381
5.6.16	4CN Connector	385

5.6.1 Cable Specifications and Peripheral Devices



- 1) The rated current of the DR2 Servopack external terminals, cable size, and peripheral devices are listed in the next table.

For wiring, refer to 2.3.1.

SERVO SELECTION AND DATA SHEETS

5.6.1 Cable Specifications and Peripheral Devices cont.

•For 200VAC Class

Servopack Type DR2-		Applicable Servomotor	Power supply capacity per Servopack* ¹ kVA	MCCB or fuse capacity* ² A	Noise filter type (reference diagram)	Recommended noise filter* ³		Power ON/OFF Switch
						Type	Spec.	
30 W (0.04HP)	A3AC	SGM-A3A <input type="checkbox"/> SGM-A3V <input type="checkbox"/>	0.25	5	Applicable 	LF-205A	Single-phase 200 VAC Class, 5 A	Contactor 35A or above
	50 W (0.07HP)	A5AC						
100 W (0.13HP)	01AC	SGM-01A <input type="checkbox"/> SGM-01V <input type="checkbox"/>	0.5					
	01ACP	SGMP-01A <input type="checkbox"/> SGMP-01V <input type="checkbox"/>						
200 W (0.27HP)	02AC	SGM-02A <input type="checkbox"/> SGM-02V <input type="checkbox"/>	0.75					
	02ACP	SGMP-02A <input type="checkbox"/> SGMP-02V <input type="checkbox"/>						
400 W (0.53HP)	04AC	SGM-04A <input type="checkbox"/> SGM-04V <input type="checkbox"/>	1.2	9				
	04ACP	SGMP-04A <input type="checkbox"/> SGMP-04V <input type="checkbox"/>						
750 W (1.01HP)	08AC	SGM-08A <input type="checkbox"/> SGM-08V <input type="checkbox"/>	2.2	16	Not applicable 	LF- 220	Single-phase 200 VAC Class, 20 A	
	08ACP	SGMP-08A <input type="checkbox"/> SGMP-08V <input type="checkbox"/>						





Note For power ON/OFF switch, use contactor 30A or above.

*1 Value at rated load.

*2 Braking characteristics (at 25° C): 200% for 2s min., 700% for 0.01s min.

*3 Yaskawa recommends noise filters manufactured by Tokin Corp.
Yaskawa Controls Co., Ltd. can supply these noise filters.

•For 100VAC Class

Servopack Type DR2-		Applicable Servomotor	Power supply capacity per Servopack*1 kVA	MCCB or fuse capacity*2 A	Noise filter type (reference diagram)	Recommended noise filter*3		Power ON/OFF switch
						Type	Spec.	
30 W (0.04HP)	A3BC	SGM-A3B <input type="checkbox"/> SGM-A3W <input type="checkbox"/>	0.25	5	Applicable 	LF- 205A	Single-phase 200 VAC Class, 5 A	Contactor 35A or above
	50 W (0.07HP)	A5BC						
100 W (0.13HP)	01BC	SGM-01B <input type="checkbox"/> SGM-01W <input type="checkbox"/>	0.5	8	Not applicable 	LF- 205A	Single-phase 200 VAC Class, 5 A	Contactor 35A or above
	01BCP	SGMP-01B <input type="checkbox"/> SGMP-01W <input type="checkbox"/>						
200 W (0.27HP)	02BC	SGM-02B <input type="checkbox"/> SGM-02W <input type="checkbox"/>	0.75	8	Not applicable 	LF- 210	Single-phase 200 VAC Class, 10 A	Contactor 35A or above
	02BCP	SGMP-02B <input type="checkbox"/> SGMP-02W <input type="checkbox"/>						
300 W (0.40HP)	03BC	SGM-03B <input type="checkbox"/> SGM-03W <input type="checkbox"/>	1.4	15	Not applicable 	LF- 220	Single-phase 200 VAC Class, 20 A	Contactor 35A or above
	03BCP	SGMP-03B <input type="checkbox"/> SGMP-03W <input type="checkbox"/>						

Note For power ON/OFF switch, use contactor 30A or above.

*1 Value at rated load.

*2 Braking characteristics (at 25°C): 200% for 2s min., 700% for 0.01s min.

*3 Yaskawa recommends noise filters manufactured by Tokin Corp.
Yaskawa Controls Co., Ltd. can supply these noise filters.

The types of cable are shown in the table below. Use it in combination with the table above.

Cable Type		Conductor Allowable Temperature °C
Symbol	Name	
PVC	Normal vinyl cable	---
IV	600 V vinyl cable	60
HIV	Temperature-resistant vinyl cable	75

Note 1) Use cable with 600 V min. withstand voltage for main circuits.

2) Consider allowable current reduction ratio if cables are bundled in PVC or metal ducts.

3) Use temperature-resistant cable under high ambient or panel temperature where normal vinyl cables rapidly deteriorate.

2) Cable Specifications

Cable Specifications for Main Circuit Power Input Terminals

Applied Voltage	Servopack Type DR2-	Main Circuit Power Input Terminal*1 L1, L2, ⊕		
		Rated Input Current A (rms)	Cable Spec.*2	Tightening Torque (N·m)
200VAC Class	A3A □	1.3	AWG16 (HIV 1.25) Min.	0.5
	A5A □	1.5		
	01A □	2.5		
	02A □	4.0	AWG14 (HIV 2.0) Min.	
	04A □	6.0		
	08A □	11.0		
100VAC Class	A3B □	2.0	AWG16 (HIV 1.25) Min.	
	A5B □	2.6		
	01B □	4.5		
	02B □	8.0	AWG14 (HIV 2.0) Min.	
	03B □	14.0		

*1 When P, N (Y3, Y4) terminals are used, use the same size cable as those of L1, L2. Tightening torque is the same as those of L1, L2 (0.5N·m).

*2 The cable specifications were selected under conditions of three cables per bundle at 40°C ambient temperature, with the rated current flowing. Max. connectable cable size is 2.5mm².

Cable Specifications for Control Circuit Power Input Terminals

Applied Voltage	Servopack Type DR2-	Control Circuit Power Input Terminal L, N		
		Rated Input Current*2 A (rms)	Cable Spec.*1	Tightening Torque (N·m)
200VAC Class	All Models	0.2	AWG16 (HIV 1.25) Min.	0.5
100VAC Class	All Models	0.4		

*1 Max. connectable cable size is 2.5mm².

*2 When control circuit breaker and main circuit breaker are used separately, be aware of in-rush current (30 to 40 A, for 5 ms or less) flows at control power ON.

5

Cable Specifications for Motor Connecting Terminals

Applied Voltage	Servopack Type DR2-	Main Circuit Power Input Terminal*1 U, V, W, ⊕		
		Rated Input Current A (rms)	Cable Spec.*1	Tightening Torque (N·m)
200VAC Class	A3A□	0.42	Refer to the "Cable Specifications" shown below.	0.5
	A5A□	0.6		
	01A□	0.87 (0.89)*2		
	02A□	2.0		
	04A□	2.6		
	08A□	4.4 (4.1)*2		
100VAC Class	A3B□	0.63		
	A5B□	0.9		
	01B□	2.2		
	02B□	2.7		
	03B□	3.7 (4.3)*2		

*1 Max.connectable cable size is 2.5mm².

*2 Values in parentheses are applied only when SGMP motor is used.

- Cable Specifications

(When motor conforms to Japanese Standard)

When Yaskawa cables are used, contact your Yaskawa representative for details. When selecting non-Yaskawa cables, check the cable current rating and consider the operating environment. In this case, use cable sizes AWG 22 to AWG 18 (0.3 to 0.89mm²) since motor-side connector has some restriction. As for connectors on motor side, contact your Yaskawa representative.

(When motor conforms to EN Standard)

Connector is not supplied with motor power cable. Check the cable current rating and consider the operating environment to select the cable and connector conforming to the EN Standard.

<Motor Power Cable Color>

Red
White
Blue
Green/Yellow

<Phase>

Phase-U
Phase-V
Phase-W
FG

SERVO SELECTION AND DATA SHEETS

5.6.1 Cable Specifications and Peripheral Devices cont.

- 3) The appropriate cables for Servopack connectors 1CN and 2CN are shown in the table below. As for the cables conforming to the EMC instructions, refer to 7.2.4 and 7.2.5.

Control I/O Signal Connector	1CN	Cable	Use twisted-pair cable or twisted-pair shielded cable. Max. wiring length is 3m (9.8ft.).
		Finished Cable Dimensions	φ16.0 mm (φ 0.63 in.)MAX.
PG Signal Connector	2CN	Cable	Use Yaskawa cable. Use twisted-pair shielded cable if Yaskawa cable is not used. If using cable other than Yaskawa's, use AWG22 for encoder power supply and FG line. Use AWG26 for other signals. These connections permit wiring distances up to 20 m (65.6 ft).
		Finished Cable Dimensions	φ11.0mm (φ0.43 in.) MAX.

5.6.2 Motor Cables

1) The dimensions and appearance of the motor cables are shown below. Specify the cable type when ordering.

a) Cables For Motor Without Brake (with connector and AMP terminals)

Type	L in mm (feet)	
DP9320659-1	3000 ⁺¹⁰⁰ ₀	(10 ^{+0.33} ₀)
DP9320659-2	5000 ⁺¹⁰⁰ ₀	(16.7 ^{+0.33} ₀)
DP9320659-3	10000 ⁺⁵⁰⁰ ₀	(33.3 ^{+1.67} ₀)
DP9320659-4	15000 ⁺⁵⁰⁰ ₀	(50 ^{+1.67} ₀)
DP9320659-5	20000 ⁺⁵⁰⁰ ₀	(66.7 ^{+1.67} ₀)

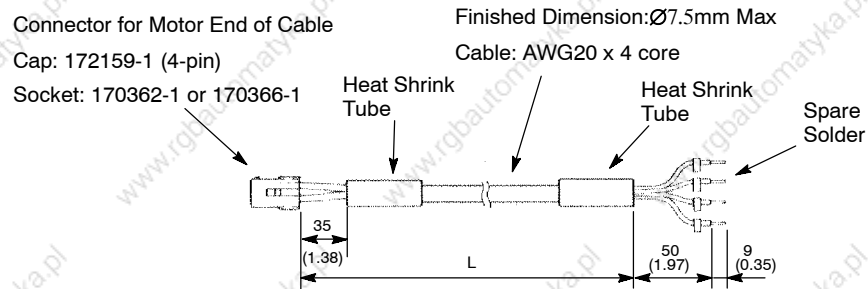

b) Cables For Motor With Brake (with connector and AMP terminals)

Type	L in mm (feet)	
DP9320660-1	3000 ⁺¹⁰⁰ ₀	(10 ^{+0.33} ₀)
DP9320660-2	5000 ⁺¹⁰⁰ ₀	(16.7 ^{+0.33} ₀)
DP9320660-3	10000 ⁺⁵⁰⁰ ₀	(33.3 ^{+1.67} ₀)
DP9320660-4	15000 ⁺⁵⁰⁰ ₀	(50 ^{+1.67} ₀)
DP9320660-5	20000 ⁺⁵⁰⁰ ₀	(66.7 ^{+1.67} ₀)

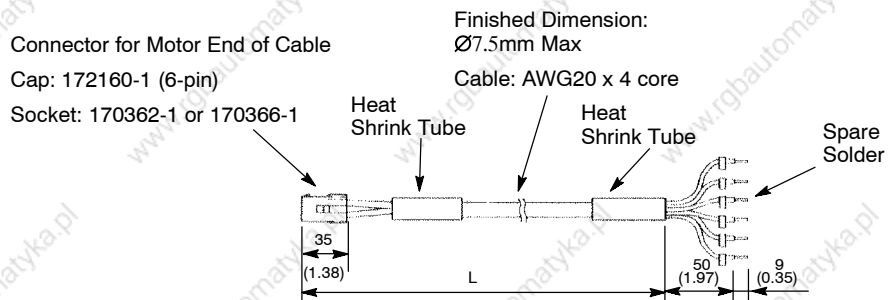

SERVO SELECTION AND DATA SHEETS

5.6.2 Motor Cables cont.

c) Cables For Motor Without Brake (Cable Only)

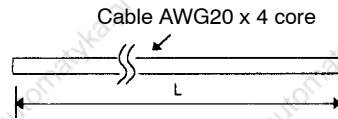

Type	L in mm (feet)
DP8409359-1	3000^{+100}_0 (10 $^{+0.33}_0$)
DP8409359-2	5000^{+100}_0 (16.7 $^{+0.33}_0$)
DP8409359-3	10000^{+500}_0 (33.3 $^{+1.67}_0$)
DP8409359-4	15000^{+500}_0 (50 $^{+1.67}_0$)
DP8409359-5	20000^{+500}_0 (66.7 $^{+1.67}_0$)

AMP Connector

Cap: 172159-1

Socket: 170362-1 or 170366-1 (Manufactured by AMP.)

*

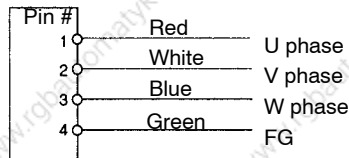

d) Cables For Motor With Brake
(Cable Only)

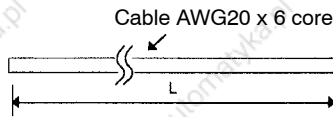

Type	L in mm (feet)
DP8409360-1	3000 ⁺¹⁰⁰ ₀ (10 ^{+0.33} ₀)
DP8409360-2	5000 ⁺¹⁰⁰ ₀ (16.7 ^{+0.33} ₀)
DP8409360-3	10000 ⁺⁵⁰⁰ ₀ (33.3 ^{+1.67} ₀)
DP8409360-4	15000 ⁺⁵⁰⁰ ₀ (50 ^{+1.67} ₀)
DP8409360-5	20000 ⁺⁵⁰⁰ ₀ (66.7 ^{+1.67} ₀)

AMP Connector
Cap: 172160-1
Socket: 170362-1 or 170366-1 (Manufactured by AMP.) *

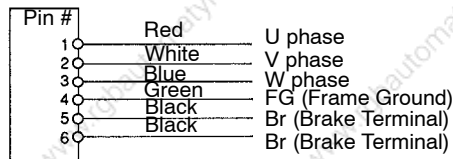

* If cable only is ordered, purchase the AMP connector separately. Refer to 5.6.3 Connector Kits for details about caps and sockets.

5.6.3 Connector Kits

1) A connector kit comprises three connectors as shown in the diagram below: one encoder connector at both the motor and Servopack ends of the cable and a motor connector for the motor end of the cable.

Encoder Connector for Motor End of Cable

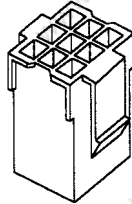

Encoder Connector for Servopack End of Cable

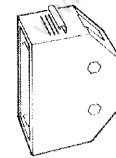

Motor Connector for Motor End of Cable

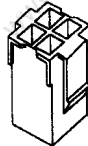

Four types of connector kit are available according to the following information:

- Is the encoder incremental or absolute?
- Is the motor with or without a brake?

A connector kit is required in the following cases:

- a) If motor cable only is purchased (whether or not motor has a brake).
 - b) If the encoder cable with a motor connector only and Servopack end without connector, or encoder cable only is purchased (for either incremental or absolute encoder).
- 2) Select one of the following two types of encoder cable connector.

a) For Incremental Encoder

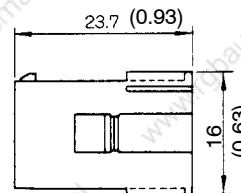
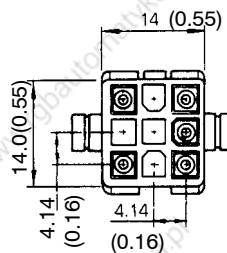

Cap: 172161-1
Socket: 170365-1

b) For Absolute Encoder

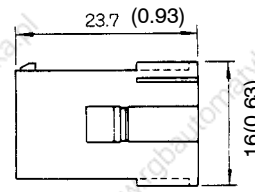
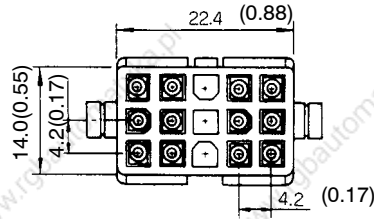

Cap: 172163-1

Socket: 170361-1 or 170365-1

3) Select one of the following two types of motor cable connector.

a) Motor Without Brake

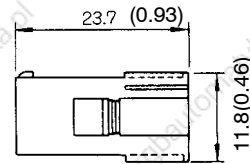
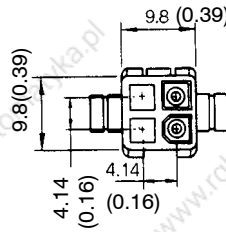

Cap: 172159-1

Socket: 170362-1 or 170366-1

b) Motor With Brake

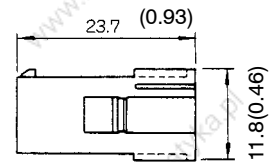
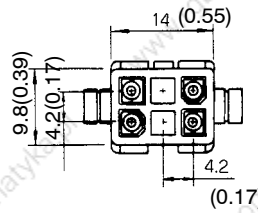

Cap: 172160-1

Socket: 170362-1 or 170366-1

SERVO SELECTION AND DATA SHEETS

5.6.3 Connector Kits cont.

- 4) The following shows the encoder connector for the Servopack end of the cable.
Caulking type is not provided as the connector kits. When using the caulking type, order separately and use MRP-F□ type contact.

- Connector (Soldering type)

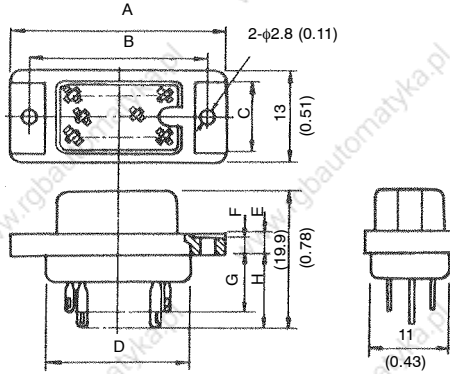

Units: mm (inches)

Connector Type	A	B	C	D	E	F	G	H
MR-20F	32.8 (1.29)	27.8 (1.09)	10 (0.39)	22.3 (0.88)	3 (0.12)	2.4 (0.09)	8.4 (0.33)	10.9 (0.43)

- Connector (Caulking type)

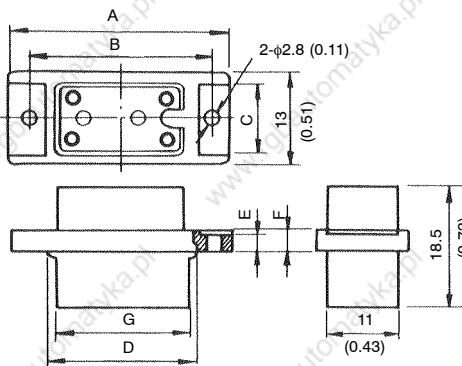

Units: mm (inches)

Connector Type	A	B	C	D	E	F	G
MRP-20F01	32.8 (1.29)	27.8 (1.09)	10 (0.39)	22.3 (0.88)	2.4 (0.09)	3 (0.12)	21.3 (0.84)

Female Contact

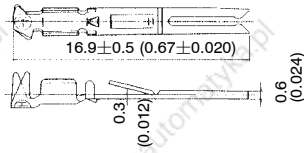

Type Designation

MRP - F 102

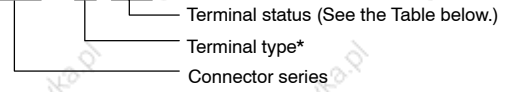

* M: Male F: Female

Terminal Status	Type	Processing	Applicable Female Insulation
Chain	MRP-F102	Silver plated	MRP-8F01 to MRP-50F01
	MRP-F103	Gold plated	
Loose	MRP-F112	Silver plated	
	MRP-F113	Gold plated	

Tool



Type Designation

MRP - MF

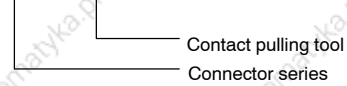

• Case

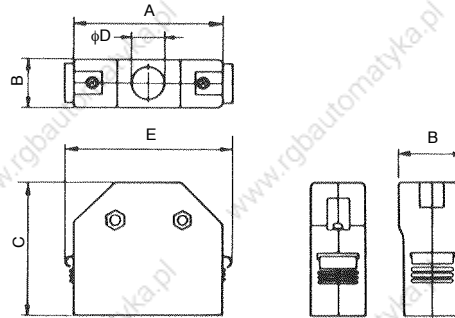

Units: mm (inches)

Case Type	A	B*	C	φD	E*
MR-20L	39.3 (1.55)	18 (0.71)	39.8 (1.57)	11 (0.43)	(47.9) (1.89)

* Maximum dimensions

SERVO SELECTION AND DATA SHEETS

5.6.3 Connector Kits cont.

5) The types of connector kit are shown below. Select the type of connector kit according to the connectors selected in (2), (3), and (4) above.

Connector Kit Type	Application		Connector Kit Part List											
	Encoder/Motor Cable		For Encoder Cable								For Motor Cable			
	Encoder Type	Motor Brake With/Without	Encoder End				Servopack End				Cap		Socket	
			Cap		Socket		Connector		Case		Type	Qty	Type	Qty
Type	Qty	Type	Qty	Type	Qty	Type	Qty	Type	Qty	Type	Qty	Type	Qty	
DP9420009-1	Incremental	Without	*1	1	*1	*3	*2	1	*2	1	*1	1	*1	*3
			172161		170365	10	MR-20F		MR-20L		172159		170366	5
			-1		-1						-1		-1	
DP9420009-2	Incremental	With									*1	1		*3
											172160			7
											-1			
DP9420009-3	Absolute	Without	*1	1		*3					*1	1		*3
			172163			16					172159			5
			-1								-1			
DP9420009-4	Absolute	With									*1	1		*3
											172160			7
											-1			

*1 Manufactured by AMP.

*2 Manufactured by 3M.

*3 Including one spare.

5.6.4 Brake Power Supply

1) Brake power supplies are available for 200 V and 100 V input.

200 VAC Input: LPSE-2H01

100 VAC Input: LPDE-1H01

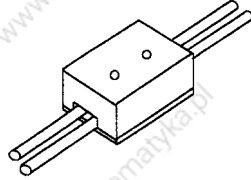

Use for Servomotor with brake.

• Dimensional Drawings

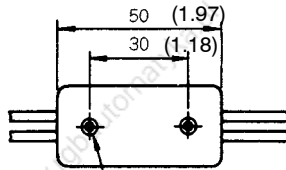

Manufactured by Yaskawa Controls Co., Ltd.

2- \varnothing 3 (2- \varnothing 0.12) MTG HOLES
(SPOT FACING \varnothing 5.5
(\varnothing 0.22), 4 (0.16) LONG)

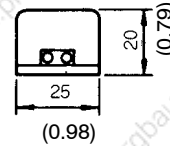
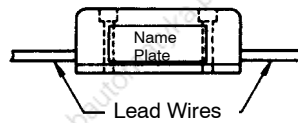

- Lead Wire Length: 500 mm each (19.69 in.)
- Max. Ambient Temperature: 60°C
- Lead Wires: Color Coded

AC Input		Brake
100V	200V	
Blue/White	Yellow/White	Red/Black

5.6.4 Brake Power Supply cont.

2) The internal circuits are shown below. While it is possible to switch either the AC or DC side of the brake power supply, it is normally safer to switch the AC side. If the DC side is to be switched, install a surge suppressor near the brake coil to prevent the surge voltages due to switching the DC side damaging the brake coil.

- Internal Circuit for 200 VAC Input (LPSE-2H01)

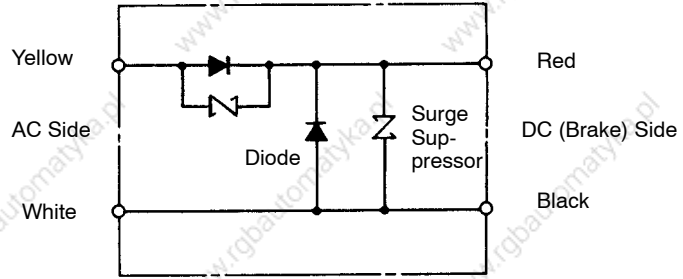

- Internal Circuit for 100 VAC Input (LPDE-1H01)

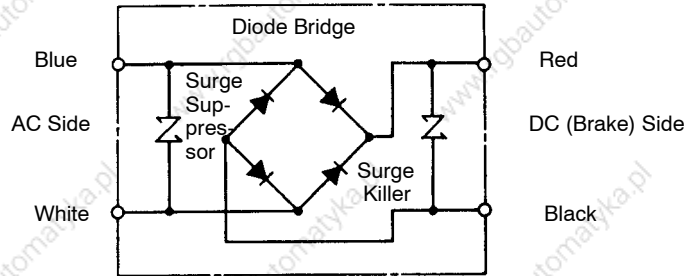

5.6.5 Encoder Cables

- 1) The dimensions and appearance of the encoder cables are shown below. Specify the cable type when ordering.
As for the cables conforming to the EMC instructions, refer to 7.2.4.

a) Cables for Incremental Encoder (Connector Both Ends)

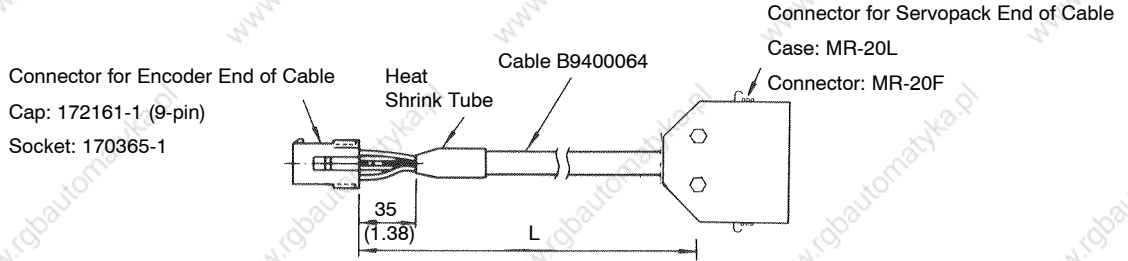

Type	L in mm (feet)
DP9320082-1	3000 ⁺¹⁰⁰ ₀ (10 ^{+0.33} ₀)
DP9320082-2	5000 ⁺¹⁰⁰ ₀ (16.7 ^{+0.33} ₀)
DP9320082-3	10000 ⁺⁵⁰⁰ ₀ (33.3 ^{+1.67} ₀)
DP9320082-4	15000 ⁺⁵⁰⁰ ₀ (50 ^{+1.67} ₀)
DP9320082-5	20000 ⁺⁵⁰⁰ ₀ (66.7 ^{+1.67} ₀)

b) Cables for Absolute Encoder (Connector Both Ends)

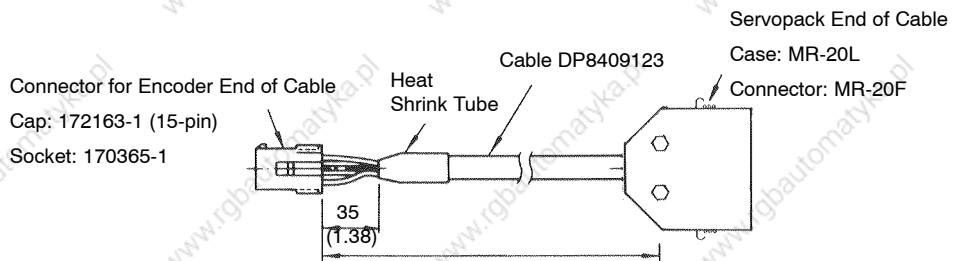

Type	L in mm (feet)
DP9320084-1	3000 ⁺¹⁰⁰ ₀ (10 ^{+0.33} ₀)
DP9320084-2	5000 ⁺¹⁰⁰ ₀ (16.7 ^{+0.33} ₀)
DP9320084-3	10000 ⁺⁵⁰⁰ ₀ (33.3 ^{+1.67} ₀)
DP9320084-4	15000 ⁺⁵⁰⁰ ₀ (50 ^{+1.67} ₀)
DP9320084-5	20000 ⁺⁵⁰⁰ ₀ (66.7 ^{+1.67} ₀)

SERVO SELECTION AND DATA SHEETS

5.6.5 Encoder Cables cont.

c) Cables for Incremental Encoder (Servopack End without Connector)

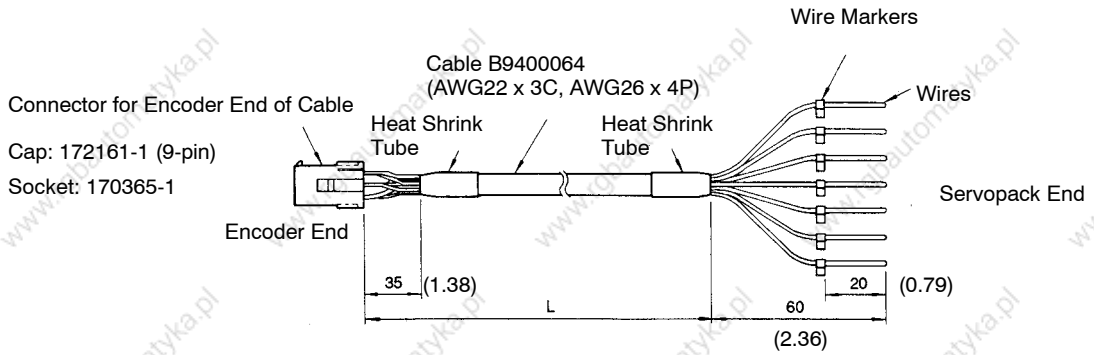

Type	L in mm (feet)	
DP9320086-1	3000 ⁺¹⁰⁰ ₀	(10.0 ^{+0.33} ₀)
DP9320086-2	5000 ⁺¹⁰⁰ ₀	(16.7 ^{+0.33} ₀)
DP9320086-3	10000 ⁺⁵⁰⁰ ₀	(33.3 ^{+1.67} ₀)
DP9320086-4	15000 ⁺⁵⁰⁰ ₀	(50.0 ^{+1.67} ₀)
DP9320086-5	20000 ⁺⁵⁰⁰ ₀	(66.7 ^{+1.67} ₀)

5

Case: MR-20L (Manufactured by Honda Tsushin Kogyo Co., Ltd.)
 Connector: MR-20F (Manufactured by Honda Tsushin Kogyo Co., Ltd.)
 Cap: 172161-1
 Socket: 170365-1

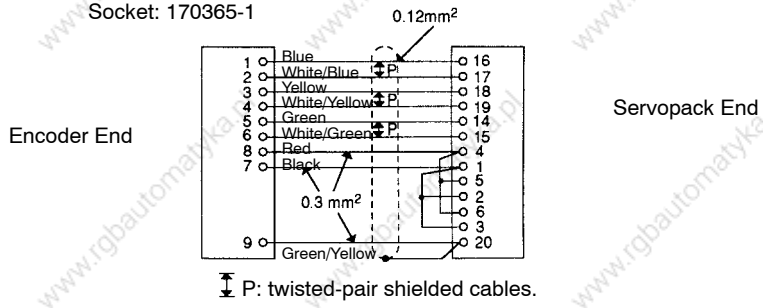

*Purchase cases and connectors separately. Refer to 5.6.3 Connector Kits for details.

d) Cables for Absolute Encoder (Servopack End without Connector)

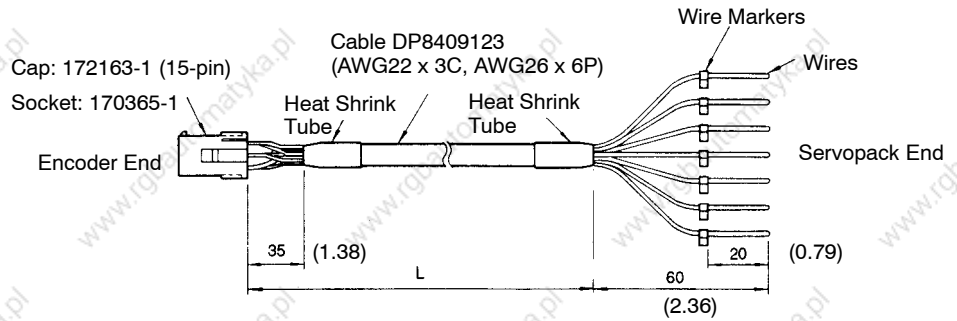

Type	L in mm (feet)
DP9320085-1	3000 ⁺¹⁰⁰ ₀ (10 ^{+0.33} ₀)
DP9320085-2	5000 ⁺¹⁰⁰ ₀ (16.7 ^{+0.33} ₀)
DP9320085-3	10000 ⁺⁵⁰⁰ ₀ (33.3 ^{+1.67} ₀)
DP9320085-4	15000 ⁺⁵⁰⁰ ₀ (50 ^{+1.67} ₀)
DP9320085-5	20000 ⁺⁵⁰⁰ ₀ (66.7 ^{+1.67} ₀)

Case: MR-20L (Manufactured by Honda Tsushin Kogyo Co., Ltd.)
 Connector: MR-20F (Manufactured by Honda Tsushin Kogyo Co., Ltd.)

5

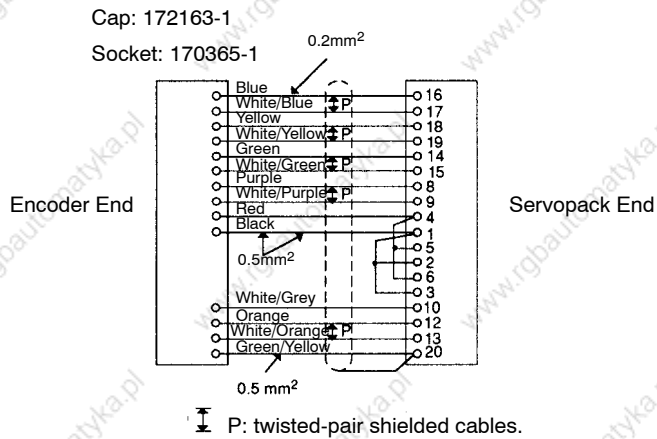

*Purchase cases and connectors separately. Refer to 5.6.3 Connector Kits for details.

SERVO SELECTION AND DATA SHEETS

5.6.5 Encoder Cables cont.

e) Cables for Incremental Encoder (Cable Only)

Cable AWG22 x 3C, AWG26 x 4P

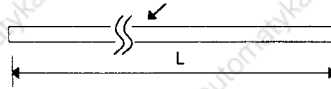

Type	L in mm (feet)
B9400064-1	3000 ⁺¹⁰⁰ ₀ (10 ^{+0.33} ₀)
B9400064-2	5000 ⁺¹⁰⁰ ₀ (16.7 ^{+0.33} ₀)
B9400064-3	10000 ⁺⁵⁰⁰ ₀ (33.3 ^{+1.67} ₀)
B9400064-4	15000 ⁺⁵⁰⁰ ₀ (50 ^{+1.67} ₀)
B9400064-5	20000 ⁺⁵⁰⁰ ₀ (66.7 ^{+1.67} ₀)

Cap: 172161-1 (Manufactured by AMP.)

Socket: 170365-1
(Manufactured by AMP.)

Case: MR-20L (Manufactured by Honda Tsushin Kogyo Co., Ltd.)

Connector: MR-20F (Manufactured by Honda Tsushin Kogyo Co., Ltd.)

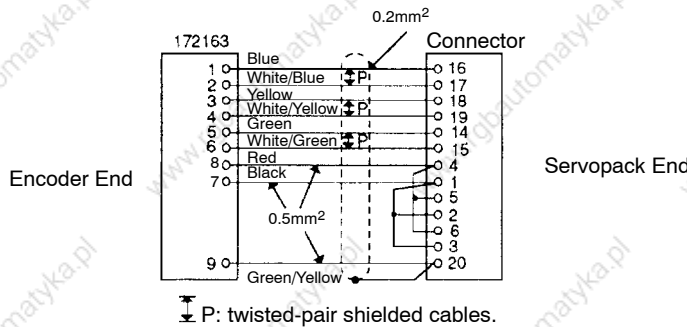

* Purchase caps, sockets, cases, and connectors separately. Refer to 5.6.3. Connector Kits for details.

f) Cables for Absolute Encoder (Cable Only)

Cable AWG22 x 3C, AWG26 x 6P

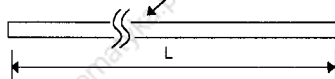

Type	L in mm (feet)
DP8409123-1	3000 ⁺¹⁰⁰ ₀ (10 ^{+0.33} ₀)
DP8409123-2	5000 ⁺¹⁰⁰ ₀ (16.7 ^{+0.33} ₀)
DP8409123-3	10000 ⁺⁵⁰⁰ ₀ (33.3 ^{+1.67} ₀)
DP8409123-4	15000 ⁺⁵⁰⁰ ₀ (50 ^{+1.67} ₀)
DP8409123-5	20000 ⁺⁵⁰⁰ ₀ (66.7 ^{+1.67} ₀)

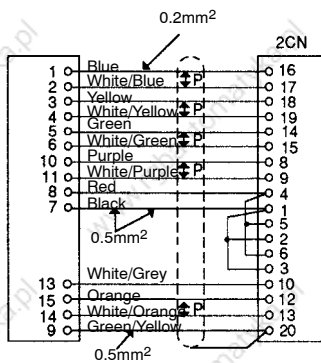
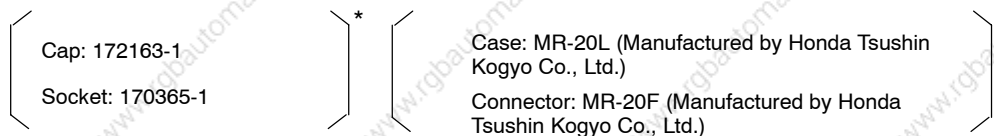

* Purchase caps, sockets, cases, and connectors separately. Refer to 5.6.3. Connector Kits for details.

SERVO SELECTION AND DATA SHEETS

5.6.5 Encoder Cables cont.

- 2) Details of the encoder cables are summarized in the table below.
 These cables are not supplied as accessories with a Servopack or Servomotor.
 Purchase in standard specified lengths as required.

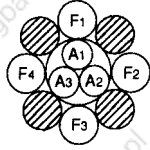
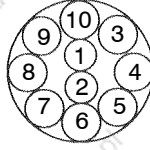
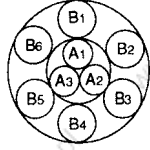
Cable Specification	Incremental Encoder		Absolute Encoder
	Yaskawa Drg. #B9400064 (Soldering type)	Yaskawa Drg. #DE8400093 (Caulking type)	Yaskawa Drg. #DP8409123 (Soldering type)
Basic Specifications	Compound KQVV-SW AWG22 x 3C, AWG26 x 4P	KQVV-SB AWG26 x 10P	Compound KQVV-SW AWG22 x 3C, AWG26 x 6P
Finished Dimension	φ7.5 mm (φ0.30in.)	φ10.0 mm (φ0.39in.)	φ8.0 mm (φ0.31in.)
Internal Structure and Lead Colors	 <p>A₁ Red A₂ Black A₃ Green/Yellow F₁ Blue - White/Blue (Twisted pair) F₂ Yellow - White/Yellow (Twisted Pair) F₃ Green - White/Green (Twisted Pair) F₄ Orange - White/Orang (Twisted Pair)</p>	 <p>1 Blue - White (Twisted pair) 2 Yellow - White (Twisted pair) 3 Green - White (Twisted pair) 4 Red - White (Twisted pair) 5 Purple - White (Twisted Pair) 6 Blue - Brown (Twisted Pair) 7 Yellow - Brown (Twisted Pair) 8 Green - Brown (Twisted pair) 9 Red - Brown (Twisted pair) 10 Purple - Brown (Twisted pair)</p>	 <p>A₁ Red A₂ Black A₃ Green/Yellow B₁ Blue - White/Blue (Twisted pair) B₂ Yellow - White/Yellow (Twisted Pair) B₃ Green - White/Green (Twisted Pair) B₄ Orange - White/Orang (Twisted Pair) B₅ Purple - White/Purple (Twisted Pair) B₆ Grey - White/Grey (Twisted Pair)</p>
Yaskawa standard specifications	Standard lengths: 3 m (9.8ft.) , 5 m (16.4ft.) , 10 m (32.8ft.), 15 m (49.2ft.), 20 m (65.6ft.) *		

*When appropriate cable is used, the allowable wiring distance between Servopack and Servomotor (PG) is 20 m (65.6ft.) max.

Note 1 See items a) to d) in this section for details about cables with connectors.

2 When wiring distance between Servopack and servomotor (PG) exceeds 20m (65.6ft.), max. 50m (164ft.) cable can be available (AWG16, Yaskawa Drg. #DP8409179).
 For details, contact your Yaskawa representative.

5.6.6 Battery for Absolute Encoder

- 1) Purchase the following battery if using an absolute encoder. (Manufactured by Toshiba Battery Co., Ltd.)

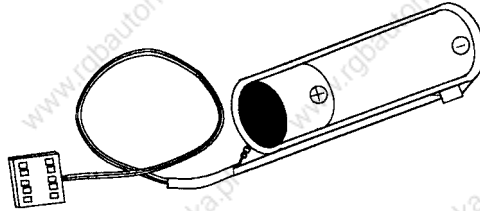

- Lithium Battery: ER 6 V C3
- Nominal Voltage: 3.6 V
- Standard Capacity: 2000 mAh

5.6.7 1CN Connector

- 1) This connector is required to connect the host controller to 1CN on the Servopack.

As for the connector conforming to the EMC instructions, refer to 7.2.5.

As for the caulking type contact tool, see 5.6.3 Connector Kits for details, and use MRP-M□ type contact.

- Connector (Soldering type)

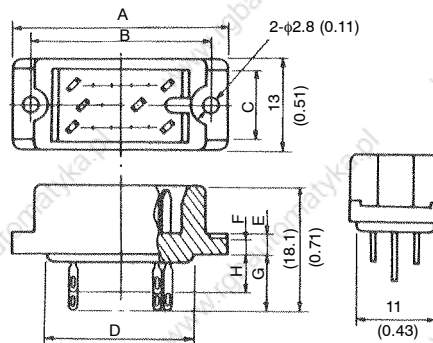

Units: mm (inches)

Connector Type	A	B	C	D	E	F	G	H
MR-50M	61.4 (2.42)	56.4 (2.22)	10 (0.39)	50.9 (2.00)	3 (0.12)	2.4 (0.09)	8.5 (0.33)	6 (0.24)

SERVO SELECTION AND DATA SHEETS

5.6.7 ICN Connector cont.

- Connector (Caulking type)

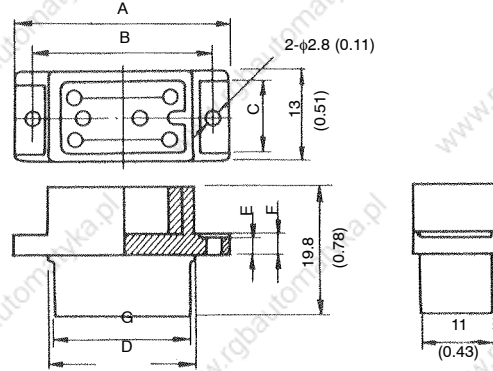

Units: mm (inches)

Connector Type	A	B	C	D	E	F
MRP-20M01	61.4 (2.42)	56.4 (2.22)	10 (0.39)	50.9 (2.00)	2.4 (0.09)	3 (0.12)

Male Contact

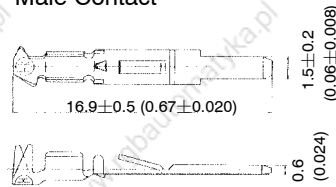

Type Designation

MRP - M 102

- Terminal status (See the Table below.)
- Terminal type*
- Connector series

* M: Male F: Female

Terminal Status	Type	Processing	Applicable Male Insulation
Chain	MRP-M102	Silver plated	MRP-8M01 to MRP-50M01
	MRP-M103	Gold plated	
Loose	MRP-M112	Silver plated	
	MRP-M113	Gold plated	

• Case

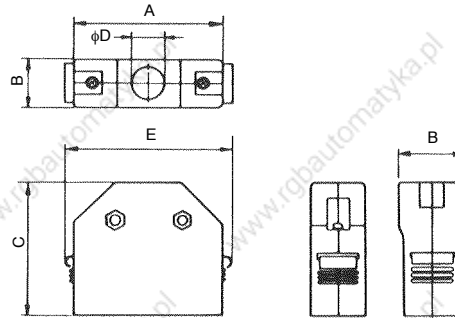

Units: mm (inches)

Case Type	A	B*	C	φD	E*
MR-50L	67.9 (2.67)	18 (0.71)	44.8 (1.76)	16 (0.63)	(76.5) (3.01)

* Maximum dimensions

2) The 1CN connector type is shown below.

Connector Type	Application	Connector Part List			
		Connector		Case	
		Type	Qty	Type	Qty
DP9420010	I/O connector for 1CN (Soldering type)	MR-50M*	1	MR-50L*	1
-	I/O connector for 1CN (Caulking type)	MRP-50M01*	1	MR-50L*	1

* Manufactured by Honda Tsushin Kogyo Co., Ltd.

5.6.8 Circuit Breaker

1) The customer should purchase a circuit breaker (MCCB) of appropriate capacity.

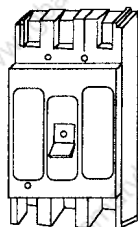

• Recommended Product

Ground fault detector for motor protection manufactured by Mitsubishi Electric Co. Ltd.
Type: MN50-CF
Rated Current: 7.1 A, 10 A, 16 A, 25 A, 32 A, 45A

Use to protect the power lines.

5.6.9 Noise Filter

1) Select the noise filter from the following three types according to the Servopack capacity.

As for the noise filter conforming to the EMC instructions, refer to 7.2.2.

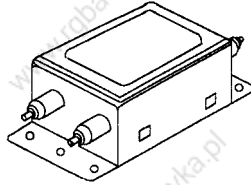

Install to eliminate external noise from the power lines.

Servopack Capacity	Noise Filter Type
30W(0.04 HP),50W(0.07HP),100W(0.13HP),200W(0.27HP)	LF-205A
200W(0.27HP)(100V),400W(0.53HP)	LF-210
300W(0.40HP)(100V),750W(1.01HP)	LF-220

• Dimensional Diagrams

- LF-205A (Single-phase 200 VAC Class, 5 A)

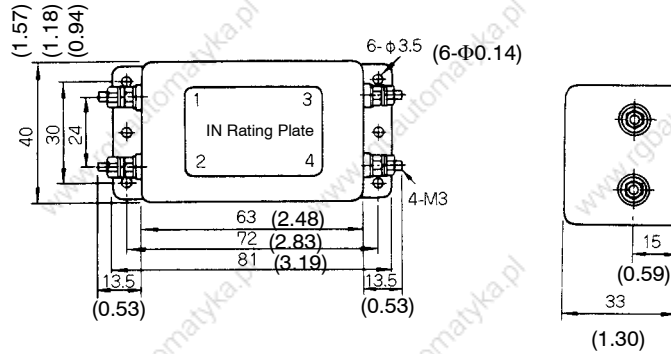

- LF-210 (Single-phase 200 VAC Class, 10 A)

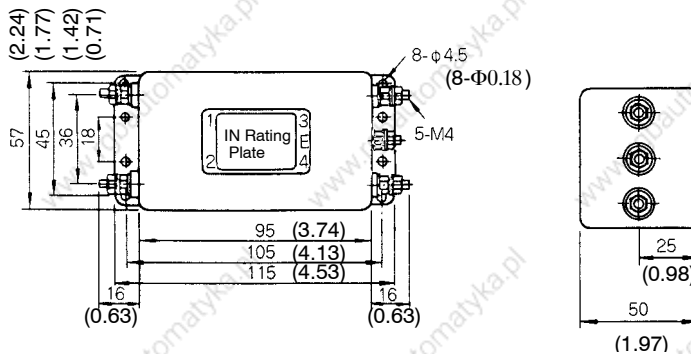

- LF-220 (Single-phase 200 VAC Class, 20 A)

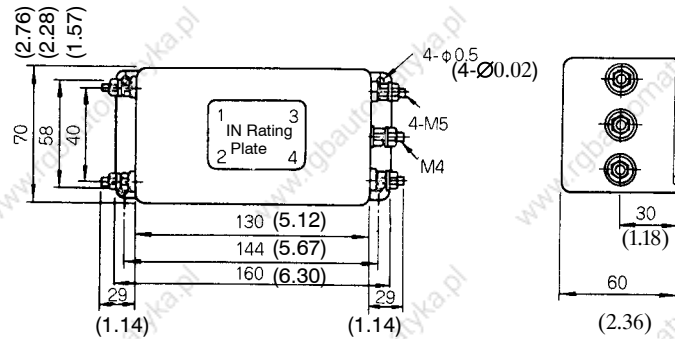

5.6.10 Magnetic Contactor

- 1) Use one 30 A magnetic contactor of the type shown below for a single Σ Series, regardless of capacity. For multiple servo systems, select the magnetic contactor according to the total capacity.

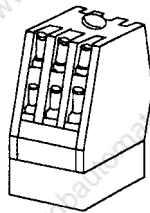

Type: HI-15E5 (30 A)

Turns servo ON and OFF.

(Note) Attach an appropriate surge suppressor to the magnetic contactor.

- Internal Connection Diagram

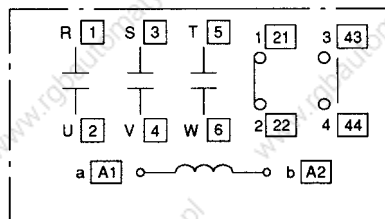

5.6.11 Surge Suppressor

- Dimensional Diagram

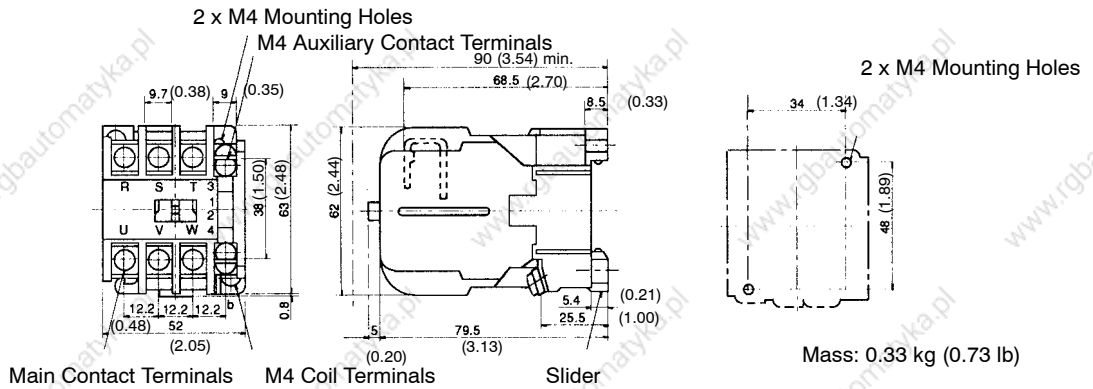

5.6.11 Surge Suppressor

- 1) Attach a surge suppressor to the magnetic contactor to prevent power supply noise and protect contacts.

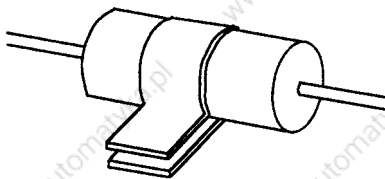

- Recommended Product

Spark Killer manufactured by Okaya Electric Industries Co., Ltd.

Type: CR50500 (250 VAC)

Static Electricity Capacity: 0.5 μ F \pm 20%

Resistance: 50 Ω (1/2 W) \pm 30%

5.6.12 Regenerative Unit

- 1) Dimensional drawings of the regenerative unit are shown below.

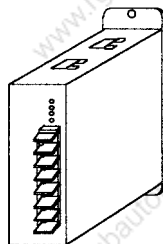

Type: JUSP-RG08

- Dimensional Drawings

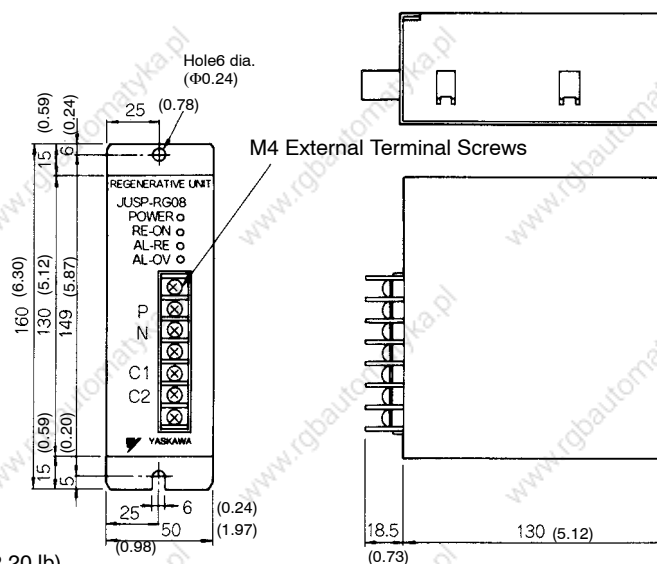

Mass: 1 kg (2.20 lb)

- Regenerative Unit Specifications

Type	JUSP-RG08	Comments
Applicable Servopack	Only for 200V, 30 to 200W specifications	
Regenerative Working Voltage	380Vdc	
Regenerative Process Current	8Adc	Built-in regenerative resistance: 50 Ω, 60 W
Error Detection Functions	Regenerative resistance failure, regenerative transistor failure, overvoltage	
Alarm Output	Normally closed contact (open when protective function operates)	200 V operation OK
Dimensions	in mm (inches)	55W × 160H × 130D (2.17W × 6.30H × 5.31D)

2) JUSP-RG08C type

JUSP-RG08C type is an exterior type regenerative unit. When regenerative ability of the built-in resistor is insufficient, install this regenerative unit to enhance the regenerative ability. When regenerative resistor is installed externally, disconnect the jumper cable between terminals Y4 and Y5. Connect exterior type regenerative unit between terminals P/Y3 and Y4.

• Dimensional Drawings

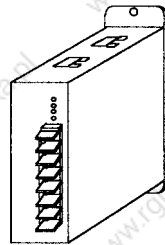

Approx. Mass: 1 kg (2.20 lb)

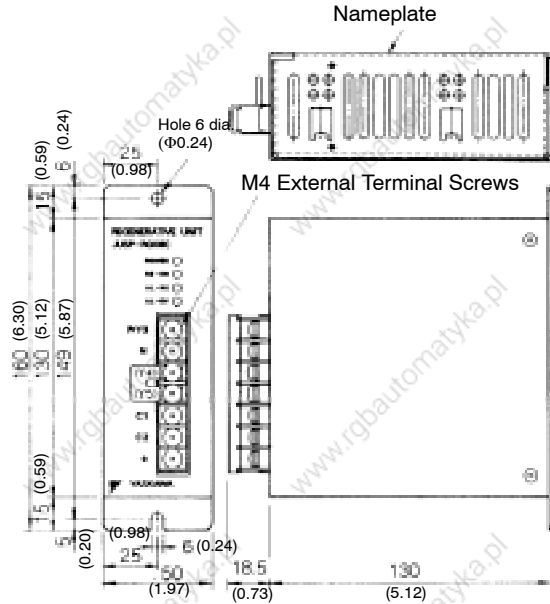

• Regenerative Unit Specifications

Type	JUSP-RG08C	Remarks
Applicable Servopack	Only for 200 V, 30 to 200 W specifications	
Regenerative Working Voltage	380Vdc	
Regenerative Processing Current	8Adc	Regenerative Resistance: 50 Ω, 60 W
Error Detection Function	Regenerative resistance disconnection, regenerative transistor fault, overvoltage	
Minimum Exterior Resistance	50 Ω	
Alarm Output	Normally closed contact (open when protective function operates)	200 V operation OK
Dimensions in mm (inches)	55W × 160H × 130D (2.17W × 6.30H × 5.31D)	

5.6.13 Variable Resistor for Speed Setting

1) This variable resistor is used to give speed references by applying the speed reference voltage from the external power supply across 1CN pins #3 and #4.

• Dimensional Drawings

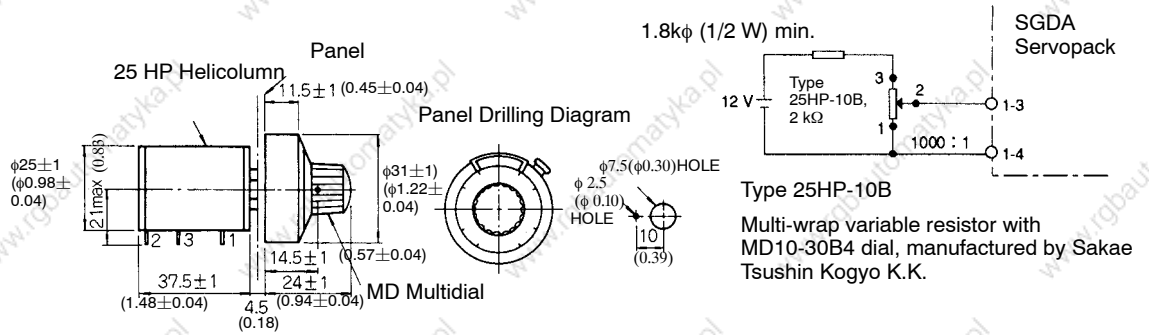

5.6.14 Encoder Signal Converter Unit

1) Unit to convert the encoder signal output from the line driver to an open collector output or voltage pulse output.

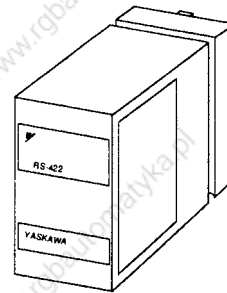

Line Receiver Unit

• Terminal Numbers

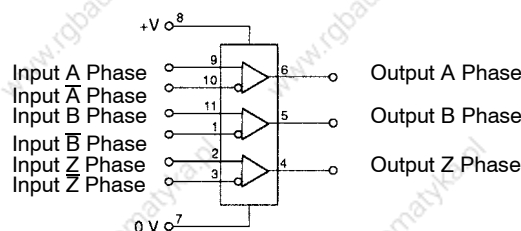

SERVO SELECTION AND DATA SHEETS

5.6.14 Encoder Signal Converter Unit cont.

- Dimensional Drawings

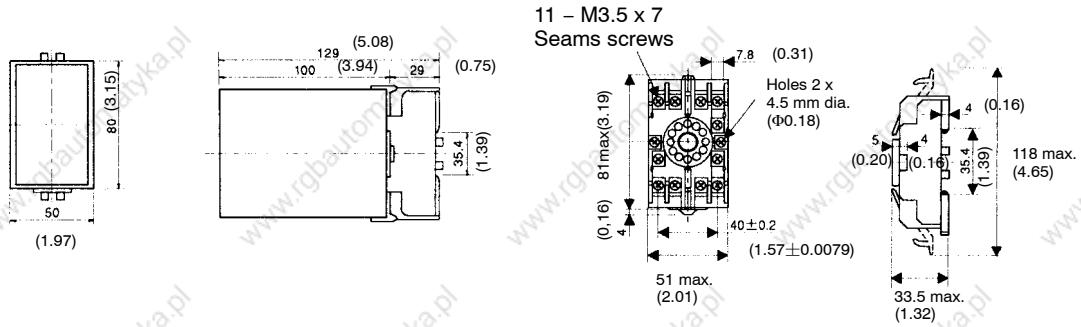

2) The encoder signal converter unit specifications are as follows:

Type Spec.	Receiver Unit			
	LRX-01/A1	LRX-01/A2	LRX-01/A3	LRX-01/A4
Power Supply	12 VDC \pm 10%, 100 mA		5 VDC \pm 10%, 100 mA	
Input Signals	Balanced line driver input (RS-422)			
Output Signals	Voltage pulse output	Open collector output	Voltage pulse output	Open collector output
Input Signal Level	Voltage differential \geq 0.3 V, internal termination resistance 100 Ω			
Output Signal Level	H: 10 V min. (1 mA) L: 0.5 V max. (30 mA)	L: 0.5 V max. (30 mA) Withstand voltage: 50 V	H: 3 V min. (1 mA) L: 0.5 V max. (30 mA)	L: 0.5 V max. (30 mA) Withstand voltage: 50 V
Operating Ambient Temperature Range	0 to +60°C			
IC Used	AM26LS32C Receiver IC, or equivalent			

5.6.15 Cables for Connecting PC and Servopack

- Special cables for connecting a PC to a Servopack. Using these cables allows monitoring and setting of user constants with a PC.
PC software is available for these communications. Ask your Yaskawa representative for details. Operate the software as described in the manual supplied.

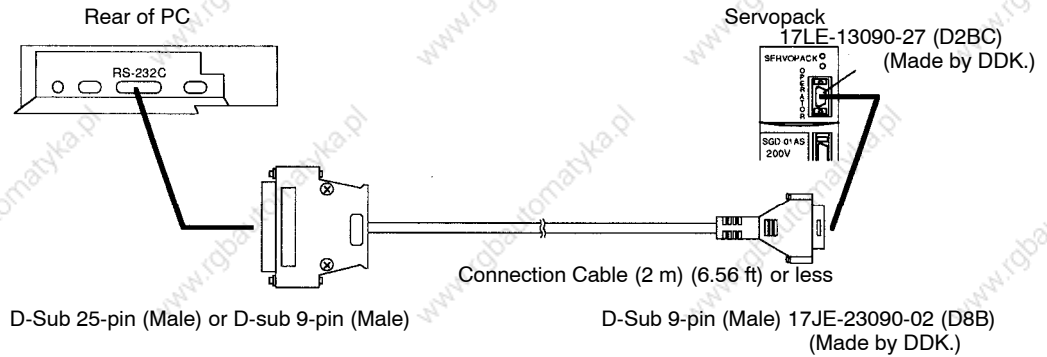

- Dimensional Drawings for Type DE9405258 (for NEC PC)

D-Sub connector 25-pin (Male) 17JE-23250-02 (D8A)

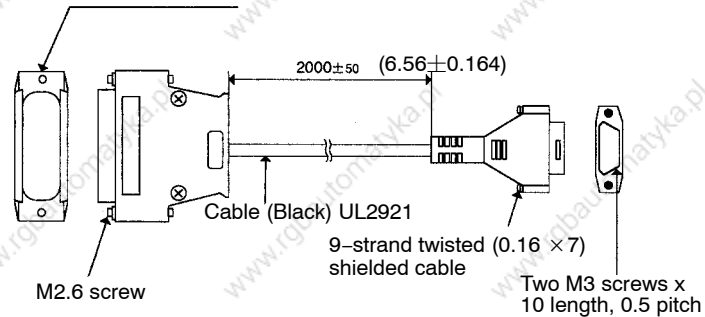

Note: Fold back the cable shielding at each end of the cable and secure it with clamps.

- The communications specifications and connecting-circuit specifications are listed below.

- Baud Rate: 9600 bps
- Number of Bits Start: 1 bit
Data: 7 bits
Stop: 1 bit
Parity: 1 bit (even)
- Synchronization Start-Stop
- XON/XOFF Control None

SERVO SELECTION AND DATA SHEETS

5.6.15 Cables for Connecting PC and Servopack cont.

- Shift Control: None
- Communications Method: Semi-duplex

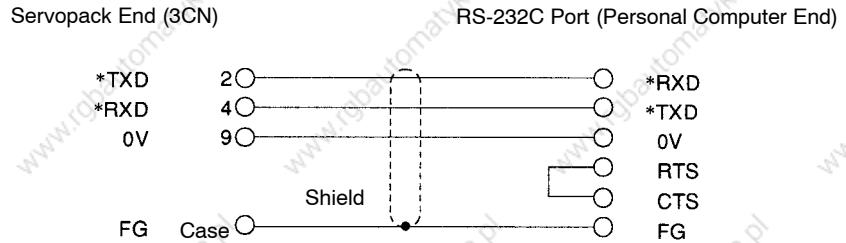

Note: Maximum cable length is 2 m (6.56 ft).

3) Connection is also possible to the RS-422A port. In this case, the connection circuit is as follows:

- Transmission Distance: 30 m (98.4 ft) max.
- Transmission System: RS-422A

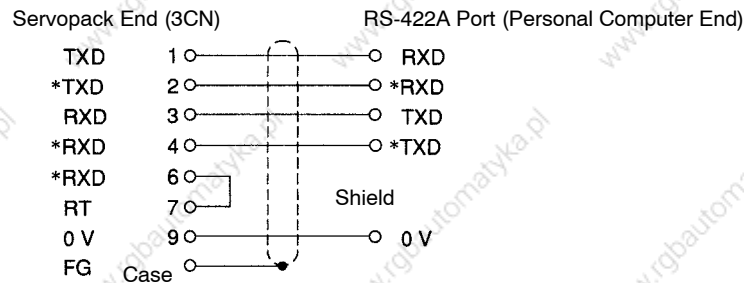

• Terminal Arrangement at Servopack End

Pin #	Signal Name	Signal Circuit Name	Signal Direction
1	TXD	Transmit data (not inverted)	P←S
2	*TXD	Transmit data (inverted)	P←S
3	RXD	Receive data (not inverted)	P→S
4	*RXD	Receive data (inverted)	P→S
5	OPH		#
6	*RXD	Shorting pins 6 and 7 inserts 220 Ω termination resistance between RXD and *RXD.	
7	RT		
8	5VPP		#
9	GND	Signal ground 0 V	

P: Personal computer
S: Servopack
#: Terminal not used, leave open.

4) Cable for connecting Servopack and IBM PC (IBM compatible PC)

Use Yaskawa DE9408565 type cable.

- Dimensional Drawings: Type DE9408565

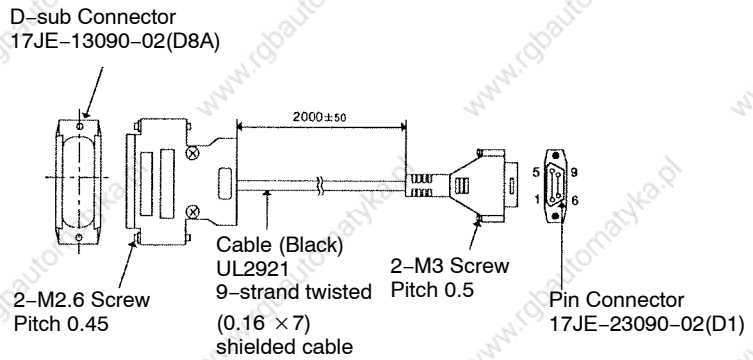

Note: Fold back the cable shielding at each end of the cable and secure it with clamp.

- Connection

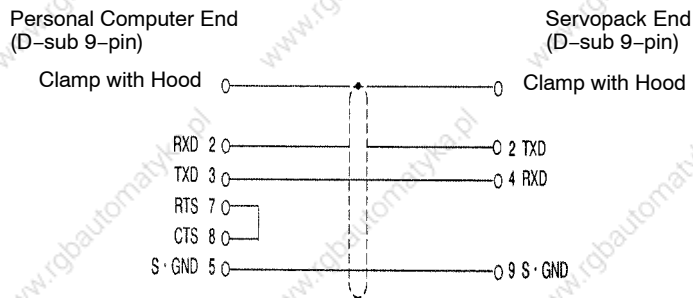

5) Cable for connecting Servopack and NEC PC-98 half-pitch connector

Use Yaskawa DE9408564 type cable.

- Dimensional Drawings: Type DE9408564

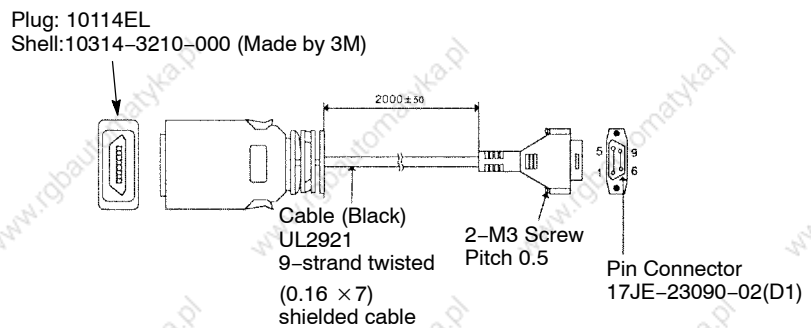

Note: Fold back the cable shielding at each end of the cable and secure it with clamp.

SERVO SELECTION AND DATA SHEETS

5.6.15 Cables for Connecting PC and Servopack cont.

- Connection

Personal Computer End

Servopack End
(3CN)

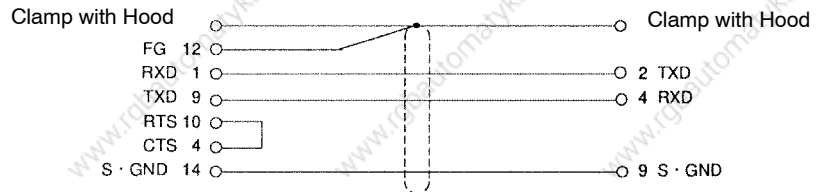

5.6.16 4CN Connector

1) This 4CN connector is used for full-closed loop specification to connect external PG to 4CN. As for caulking type contacts and tool, refer to 5.6.3 Connector Kits. Use MRP-F□ type contact.

- Connector (Soldering type)

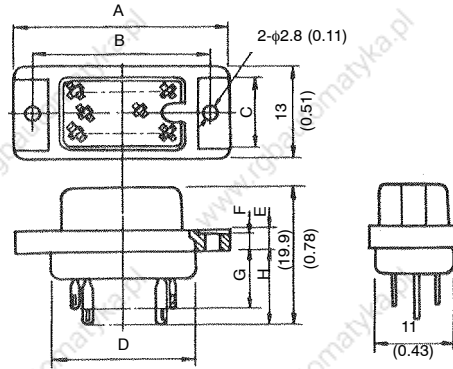

Units: mm (inches)

Connector Type	A	B	C	D	E	F	G	H
MR-8F	22.4 (0.88)	17.4 (0.69)	10 (0.39)	11.9 (0.47)	3.4 (0.13)	2.8 (0.11)	8 (0.31)	10.5 (0.41)

- Connector (Caulking type)

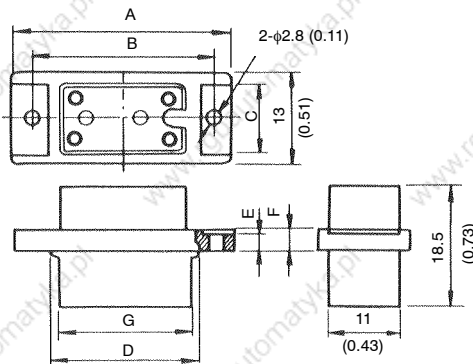

Units: mm (inches)

Connector Type	A	B	C	D	E	F
MRP-8F01	22.4 (0.88)	17.4 (0.69)	5 (0.20)	11.9 (0.47)	1.9 (0.07)	3.4 (0.13)

SERVO SELECTION AND DATA SHEETS

5.6.16 4CN Connector cont.

- Case

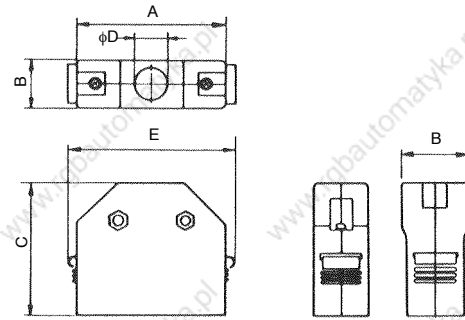

Units: mm (inches)

Case Type	A	B*	C	φD	E*
MR-8L	31 (1.22)	19 (0.75)	39.8 (1.57)	11 (0.43)	(36.6) (1.44)

* Maximum dimensions

INSPECTION, MAINTENANCE, AND TROUBLESHOOTING

6

This chapter describes the basic inspections and maintenance to be carried out by the customer.

In addition, troubleshooting procedures are described for problems which cause an alarm display and for problems which result in no alarm display.

6.1	Inspection and Maintenance	388
6.1.1	Servomotor	388
6.1.2	Servopack	389
6.1.3	Replacing Battery for Absolute Encoder	390
6.2	Troubleshooting	391
6.2.1	Troubleshooting Problems with Alarm Display	391
6.2.2	Troubleshooting Problems With No Alarm Display	409
6.2.3	Internal Connection Diagram and Instrument Connection Examples	411

6.1 Inspection and Maintenance

This section describes the basic inspections and maintenance for Σ -Series servo drives.

6.1.1	Servomotor	388
6.1.2	Servopack	389
6.1.3	Replacing Battery for Absolute Encoder	390

6.1.1 Servomotor

For inspection and maintenance of servomotors, follow the simple, daily inspection procedures in the table below.

The AC servomotors are brushless. Simple, daily inspection is sufficient. The inspection and maintenance frequencies in the table are only guidelines. Increase or decrease the frequency to suit the operating conditions and environment.

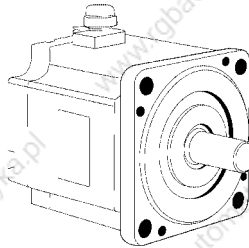

6

Item	Frequency	Procedure	Comments
Vibration and noise	Daily	Touch and listen.	Levels higher than normal?
Appearance	According to degree of contamination	Clean with cloth or compressed air.	
Insulation resistance measurement	Yearly	Disconnect Servopack and test insulation resistance at 500 V. Must exceed 10 M Ω . (See note below)	Contact your Yaskawa representative if the insulation resistance is below 10 M Ω .
Replace oil seal	Every 5,000 hours	Remove servomotor from machine and replace oil seal.	Applies only to motors with oil seal.
Overhaul	Every 20,000 hours or 5 years	Contact your Yaskawa representative.	The customer should not disassemble and clean the servomotor.

Note Measure across the servomotor FG (green/yellow) and the U-phase (red), V-phase (white), or W-phase (blue) power lead.

During inspection and maintenance, do not disassemble the servomotor. If disassembly of the servomotor is required, contact your Yaskawa representative.

6.1.2 Servopack

For inspection and maintenance of the Servopack, follow the inspection procedures in the table below at least once every year.

The Servopack contains highly reliable parts and daily inspection is not required. Carry out the inspections and maintenance in the table below once every year.

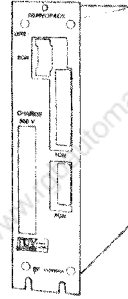

Item	Frequency	Procedure	Remedy
Clean unit interior and circuit boards	Yearly	Check for dust, dirt, and oil on the surfaces.	Clean with compressed air.
Loose screws	Yearly	Check for loose terminal block and connector screws.	Tighten any loose screws.
Defective parts in unit or on circuit boards.	Yearly	Check for discoloration, damage or discontinuities due to heating.	Contact your Yaskawa representative.

Part Replacement Schedule

The following parts are subject to mechanical wear or deterioration over time. To avoid failure, replace these parts at the frequency indicated.

Part	Standard Replacement Period	Replacement Method
Smoothing Capacitor	7 to 8 years	Replace with new part.
Relays	---	Replace with new parts.
Fuse	10 years	Replace with new part.
Aluminum Electrolytic Capacitor on Circuit Board	5 years	Replace with new circuit board.

Note Operating Conditions:

- Ambient Temperature: annual average 30°C
- Load Factor: 80% max.
- Operation Rate: 20 hours/day max.

6.1.3 Replacing Battery for Absolute Encoder

Battery replacement is only required for servo systems using an absolute encoder.

The battery type recommended below (purchased by the customer) is installed in the host controller to allow the absolute encoder to store position data when the power is turned OFF.

Recommended Battery:

- Lithium Battery
ER 6 V C3, manufactured by Toshiba Battery Co., Ltd. 3.6 V, 2000 mAh
Estimated Life: Approximately 10 years

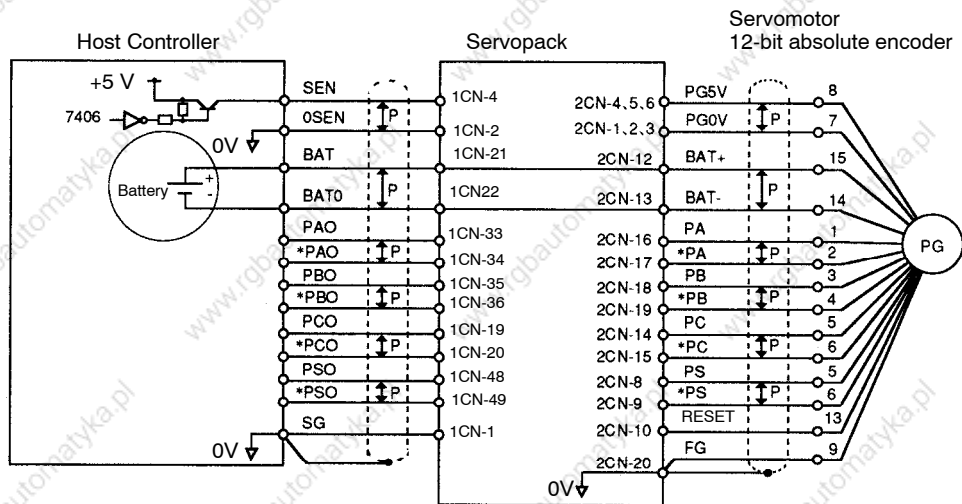
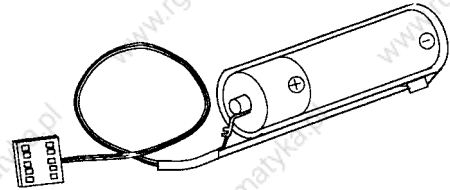

The battery voltage is not internally monitored in the Servopack. Therefore, detect low battery voltage at the host controller.

Minimum required battery voltage is 2.8 V.

Replace the battery according to the following procedure if the battery voltage drops to the minimum required battery voltage. The battery maintains absolute position data stored in the encoder.

Battery Replacement Procedure:

- 1) Turn ON the Servopack and wait at least 3 minutes. The absolute encoder capacitors are charged.
- 2) Replace the battery in the host controller. The Servopack power supply can be ON or OFF during battery replacement.

Note After completing step 1 above, the absolute encoder will function normally for up to 2 days with no battery.

6.2 Troubleshooting

This section describes causes and remedies for problems which cause an alarm display and for problems which result in no alarm display.

6.2.1	Troubleshooting Problems with Alarm Display	391
6.2.2	Troubleshooting Problems with No Alarm Display	409
6.2.3	Internal Connection Diagram and Instrument Connection Examples	411

6.2.1 Troubleshooting Problems with Alarm Display

Refer to the tables below to identify the cause of a problem which causes an alarm display and take the remedy described.

Note that A.99 does not indicate an alarm.

Contact your Yaskawa representative if the problem cannot be solved by the described procedures.

1. Alarm Display and Troubleshooting Table

• Display and Outputs

Digital Operator Display and Alarm Name	Alarm Output			
	Alarm Code Output			Alarm Output
	ALO1	ALO2	ALO3	
A.00 Absolute data error	OFF	OFF	OFF	OFF

OFF: Output transistor is OFF
ON: Output transistor is ON

Status When Alarm Occurred

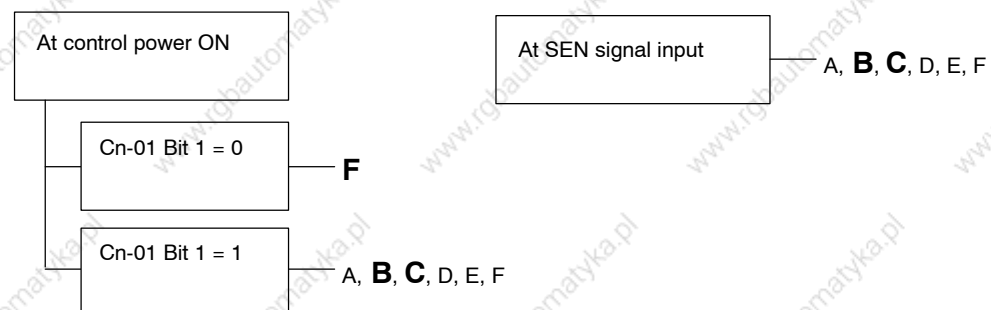

INSPECTION, MAINTENANCE, AND TROUBLESHOOTING

6.2.1 Troubleshooting Problems with Alarm Display cont.

	Cause	Remedy
A	Absolute encoder power not supplied from Servopack.	Use the Servopack power supply for the absolute encoder.
B	Incorrect absolute encoder wiring (PA, PB, RESET, SEN signal (for speed control), etc.)	Check and correct the absolute encoder wiring.
C	Absolute encoder malfunctioned	<ul style="list-style-type: none"> When Cn-01 Bit 1 = 0, turn SEN signal OFF and back ON. (See note) When Cn-01 Bit 1 = 1, turn Servopack control power OFF and back ON.
D	Incorrect user constant setting. Incremental encoder used with Cn-01 Bit E set to 1.	Set Cn-01 Bit E to 0.
E	Absolute encoder defective	Replace servomotor.
F	Circuit board (1PWB) defective	Replace Servopack.

NOTE Resetting SEN Signal

When resetting the SEN signal (i.e., turning it OFF and then back ON) for any reason, keep the SEN signal at the high level for more than 1.3 s before turning it OFF.

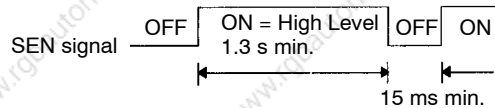

• Display and Outputs

Digital Operator Display and Alarm Name	Alarm Output			
	Alarm Code Output			Alarm Output
	ALO1	ALO2	ALO3	
A.02 User constants breakdown	OFF	OFF	OFF	OFF

OFF: Output transistor is OFF
ON: Output transistor is ON

Status When Alarm Occurred



	Cause	Remedy
A	Power turned OFF during parameter write. Alarm occurred next power ON.	Replace Servopack.
B	Circuit board (1PWB) defective	Replace Servopack.

• Display and Outputs

Digital Operator Display and Alarm Name	Alarm Output			
	Alarm Code Output			Alarm Output
	ALO1	ALO2	ALO3	
A.04 User constant setting error	OFF	OFF	OFF	OFF

OFF: Output transistor is OFF
ON: Output transistor is ON

Status When Alarm Occurred

At control power ON

A, B

	Cause	Remedy
A	An out-of-range user constant was previously set or loaded.	Reset all user constants in range. Otherwise, re-load correct user constants.
B	Circuit board (1PWB) defective	Replace Servopack.

• Display and Outputs

Digital Operator Display and Alarm Name	Alarm Output			
	Alarm Code Output			Alarm Output
	ALO1	ALO2	ALO3	
A.10 Overcurrent	ON	OFF	OFF	OFF

OFF: Output transistor is OFF
ON: Output transistor is ON

Note Alarm A10 is reset when the power is turned OFF and back ON. It is not reset by the normal alarm reset.

Status When Alarm Occurred

During servomotor operation

A, B, C, D, E

When servo ON (S-ON) signal turned ON

D, E

At main circuit power ON

D

INSPECTION, MAINTENANCE, AND TROUBLESHOOTING

6.2.1 Troubleshooting Problems with Alarm Display cont.

	Cause	Remedy
A	Wiring grounded between Servopack and servomotor.	Check and correct wiring.
B	Servopack ambient temperature exceeds 55°C	Bring Servopack ambient temperature to 55°C Note Alarm cannot be reset while power transistor module temperature exceeds 90°C.
C	Servomotor U, V, or W phase grounded.	Replace servomotor.
D	<ul style="list-style-type: none"> • Circuit board (1PWB) defective • Power transistor defective 	Replace Servopack.
E	Current feedback circuit, power transistor, DB relay, or circuit board defective.	Replace Servopack.

• Display and Outputs

Digital Operator Display and Alarm Name	Alarm Output			
	Alarm Code Output			Alarm Output
	ALO1	ALO2	ALO3	
A.20 Fuse blown	OFF	ON	OFF	OFF

OFF: Output transistor is OFF
ON: Output transistor is ON

Status When Alarm Occurred



	Cause	Remedy
A	Circuit board (1PWB) defective	Replace Servopack.
B	Fuse is blown.	Replace Servopack.
C	Main circuit diode module defective	Replace Servopack.

• Display and Outputs

Digital Operator Display and Alarm Name	Alarm Output			
	Alarm Code Output			Alarm Output
	ALO1	ALO2	ALO3	
A.31 Position error pulse overflow (position control only)	ON	ON	OFF	OFF

OFF: Output transistor is OFF
ON: Output transistor is ON

Status When Alarm Occurred

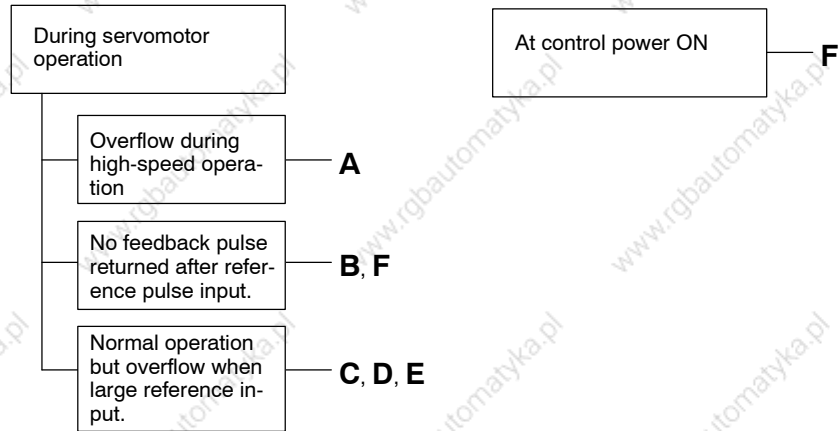

	Cause	Remedy
A	Servomotor wiring incorrect.	Check and correct wiring. (Check A-, B-, C-phase pulses correct at 2CN.)
B	Encoder wiring incorrect (disconnection, short, power supply, etc.)	
C	Servopack adjustment incorrect	Increase speed loop gain (Cn-04) and/or position loop gain (Cn-1A).
D	Servomotor overloaded	Reduce load torque and inertia. Otherwise, replace with larger capacity servomotor.
E	Position reference pulse frequency too high	<ul style="list-style-type: none"> • Decrease reference pulse frequency. • Use smoothing function. • Change electronic gear ratio.
F	Circuit board (1PWB) defective.	Replace Servopack.

• **Display and Outputs**

Digital Operator Display and Alarm Name	Alarm Output			
	Alarm Code Output			Alarm Output
	ALO1	ALO2	ALO3	
A.40 Overvoltage	OFF	OFF	ON	OFF

OFF: Output transistor is OFF
ON: Output transistor is ON

Status When Alarm Occurred

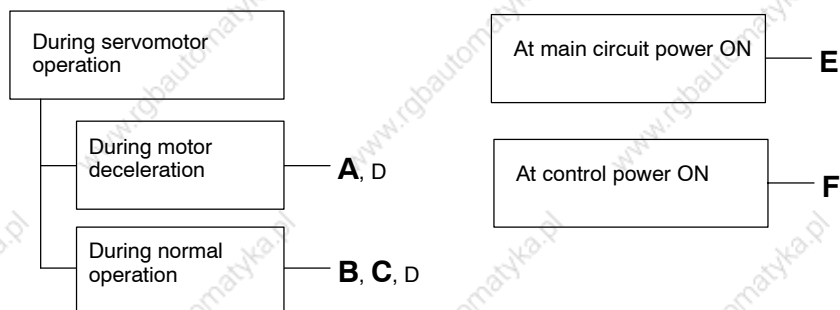

INSPECTION, MAINTENANCE, AND TROUBLESHOOTING

6.2.1 Troubleshooting Problems with Alarm Display cont.

	Cause	Remedy
A	Load inertia high and motor speed too high	<ul style="list-style-type: none"> Change operating conditions. Use external regenerative resistor or regenerative unit. (Refer to 3.8.4.)
B	Load exceeds capacity of regenerative unit	Change operating conditions.
C	Servomotor speed too high	Reduce motor speed.
D	Servopack defective	Replace Servopack.
E	Input voltage too high	Change input voltage to normal value.
F	Circuit board (1PWB) defective.	Replace Servopack.

• Display and Outputs

Digital Operator Display and Alarm Name	Alarm Output			
	Alarm Code Output			Alarm Output
	ALO1	ALO2	ALO3	
A.51 Overspeed	ON	OFF	ON	OFF

OFF: Output transistor is OFF
ON: Output transistor is ON

Status When Alarm Occurred

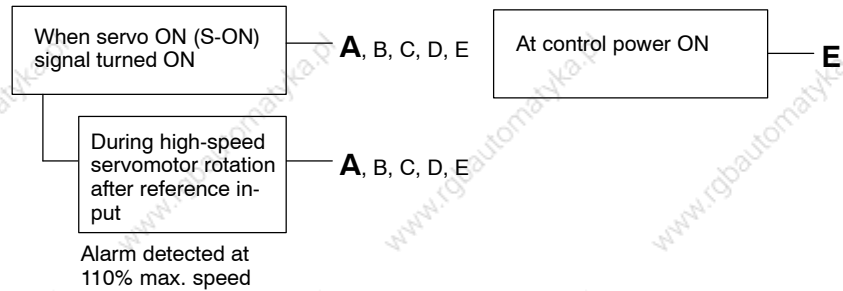

	Cause	Remedy
A	<ul style="list-style-type: none"> Servomotor wiring incorrect. Encoder wiring incorrect (disconnection, short, power supply, etc.) 	Check and correct wiring. (Check A-, B-, C-phase pulses correct at 2CN.)
B	Incremental encoder power not supplied from Servopack.	Use the Servopack power supply for the encoder.
C	Noise in encoder wiring.	Separate encoder wiring from main wiring circuits.
D	Incorrect user constant (number of encoder pulses) setting.	Set user constant Cn-11 to the correct number of pulses.
E	Circuit board (1PWB) defective	Replace Servopack.

• Display and Outputs

Digital Operator Display and Alarm Name	Alarm Output			
	Alarm Code Output			Alarm Output
	ALO1	ALO2	ALO3	
A.70 Overload	ON	ON	ON	OFF

OFF: Output transistor is OFF
ON: Output transistor is ON

Status When Alarm Occurred

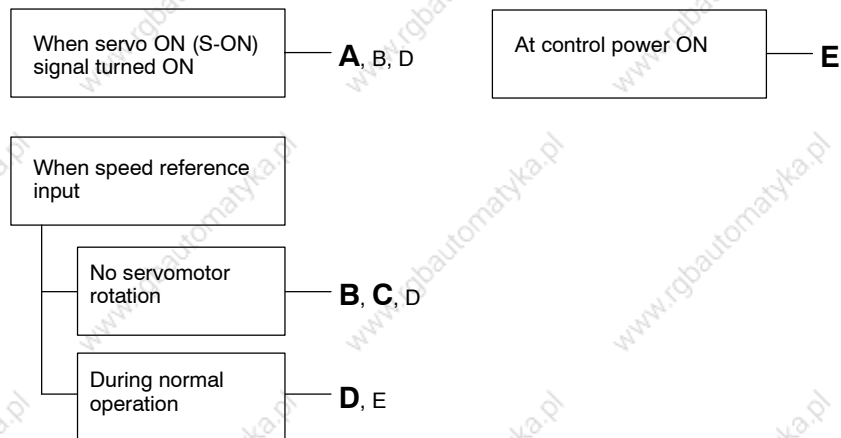

	Cause	Remedy
A	Servomotor wiring incorrect or disconnected	Check wiring and connectors at servomotor.
B	Encoder wiring incorrect or disconnected	Check wiring and connectors at encoder.
C	Load greatly exceeds rated torque	Reduce load torque and inertia. Otherwise, replace with larger capacity servomotor.
D	Incremental encoder power not supplied from Servopack.	Use the Servopack power supply for the encoder.
E	Circuit board (1PWB) defective	Replace Servopack.

• Display and Outputs

Digital Operator Display and Alarm Name	Alarm Output			
	Alarm Code Output			Alarm Output
	ALO1	ALO2	ALO3	
A.80 Absolute encoder error (only if absolute encoder is used)	OFF	OFF	OFF	OFF

OFF: Output transistor is OFF
ON: Output transistor is ON

6.2.1 Troubleshooting Problems with Alarm Display cont.

Status When Alarm Occurred

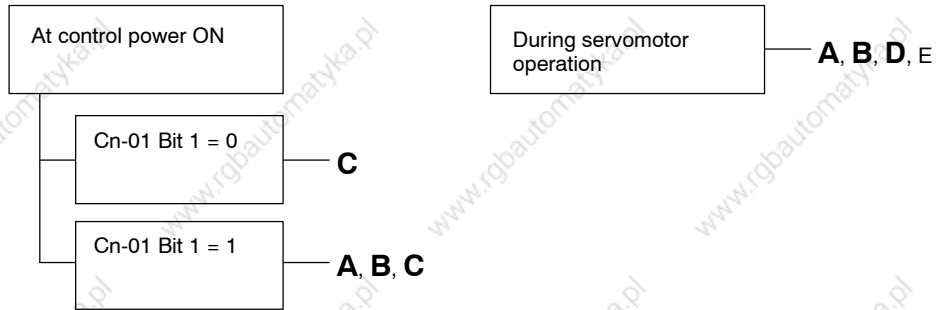

	Cause	Remedy
A	Incorrect absolute encoder wiring (PA, PB, RESET, SEN signal (for speed control), etc.)	Check and correct the absolute encoder wiring.
B	Absolute encoder malfunctioned	<ul style="list-style-type: none"> When Cn-01 Bit 1 = 0, turn SEN signal OFF and back ON. When Cn-01 Bit 1 = 1, turn Servopack control power OFF and back ON.
C	Circuit board (1PWB) defective	Replace Servopack.
D	Error occurred in absolute encoder. Another encoder alarm displayed when SEN signal or power supply turned back ON.	<ul style="list-style-type: none"> When Cn-01 Bit 1 = 0, turn SEN signal OFF and back ON (if servomotor is rotating, first turn servo OFF). When Cn-01 Bit 1 = 1, turn Servopack control power OFF and back ON.
E	Servopack miscounted pulses (positional displacement) or malfunctioned due to noise.	<ul style="list-style-type: none"> Separate encoder wiring from main wiring circuits. When Cn-01 Bit 1 = 0, turn SEN signal OFF and back ON (if servomotor is rotating, first turn servo OFF). When Cn-01 Bit 1 = 1, turn Servopack control power OFF and back ON.

• Display and Outputs

Digital Operator Display and Alarm Name	Alarm Output			
	Alarm Code Output			Alarm Output
	ALO1	ALO2	ALO3	
A.81 Absolute encoder back-up error (only if absolute encoder is used)	OFF	OFF	OFF	OFF

OFF: Output transistor is OFF
ON: Output transistor is ON

Status When Alarm Occurred

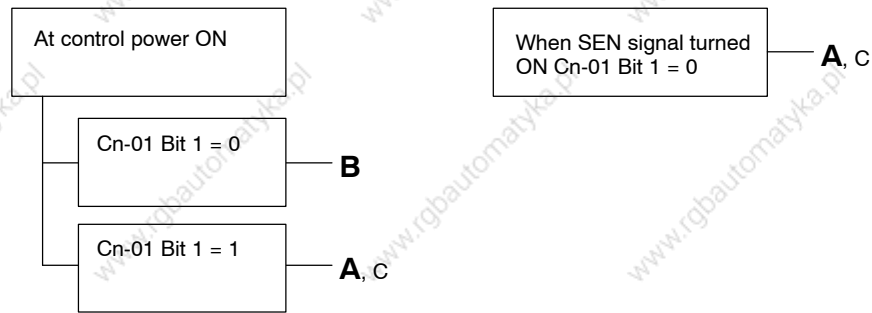

	Cause	Remedy
A	The following power supplied to the absolute encoder all failed: <ul style="list-style-type: none"> • +5 V supply • Battery (ER6V C3) • Internal capacitor 	Follow absolute encoder set-up procedures.
B	Circuit board (1PWB) defective	Replace Servopack.
C	Absolute encoder malfunctioned	Replace servomotor.

• Display and Outputs

Digital Operator Display and Alarm Name	Alarm Output			
	Alarm Code Output			Alarm Output
	ALO1	ALO2	ALO3	
A.82 Absolute encoder sum-check error (only if absolute encoder is used)	OFF	OFF	OFF	OFF

OFF: Output transistor is OFF
ON: Output transistor is ON

6

Status When Alarm Occurred

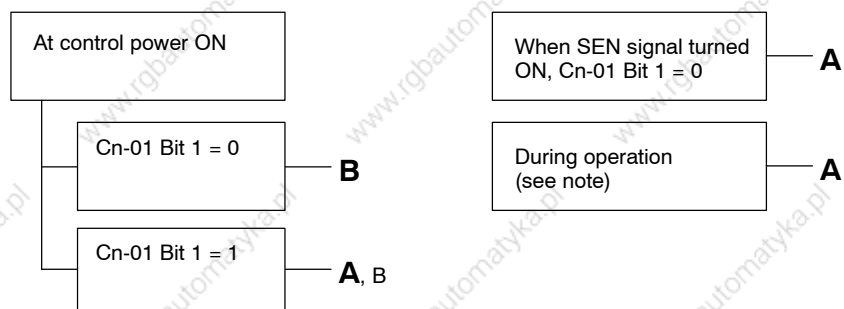

	Cause	Remedy
A	Abnormality during absolute encoder memory check	<ul style="list-style-type: none"> • Follow absolute encoder set-up procedures. • Replace servomotor if error occurs frequently.
B	Circuit board (1PWB) defective	Replace Servopack.

6.2.1 Troubleshooting Problems with Alarm Display cont.

Note An absolute encoder error (**A.80**) is given initially if a sum-check error (**A.82**) is generated during operation.
 The sum-check error (**A.82**) occurs after turning the SEN signal (or Servopack power supply) OFF and back ON.
 However, the sum-check error (**A.82**) does occur during operation if the host controller is receiving the S-phase signal (serial data).

• Display and Outputs

Digital Operator Display and Alarm Name	Alarm Output			
	Alarm Code Output			Alarm Output
	ALO1	ALO2	ALO3	
A.83 Absolute encoder sum-check error (only if absolute encoder is used)	OFF	OFF	OFF	OFF

OFF: Output transistor is OFF
 ON: Output transistor is ON

Status When Alarm Occurred

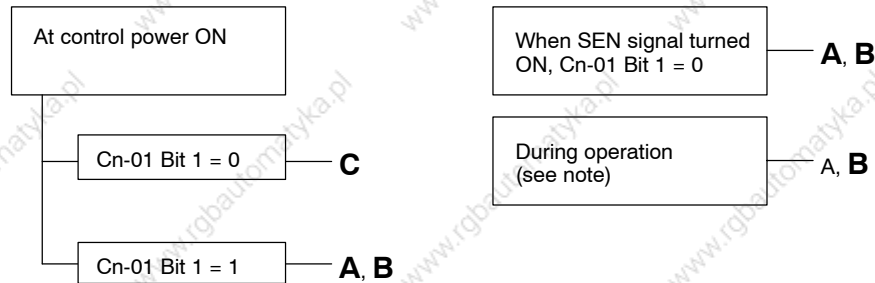

	Cause	Remedy
A	<ul style="list-style-type: none"> Battery not connected Battery connection defective 	Check and correct battery connection.
B	Battery voltage below specified value. Specified value: 2.8 V.	Install new battery and turn SEN signal (or Servopack control power) ON.
C	Circuit board (1PWB) defective	Replace Servopack.

Note No alarm occurs at the Servopack when a battery error (**A.83**) is generated. The battery error (**A.83**) occurs the next time the SEN signal (or Servopack) turns ON.
 However, the battery error (**A.83**) can be read during operation if the host controller is receiving the S-phase signal (serial data).

• Display and Outputs

Digital Operator Display and Alarm Name	Alarm Output			
	Alarm Code Output			Alarm Output
	ALO1	ALO2	ALO3	
A.84 Absolute encoder data error (only if absolute encoder is used)	OFF	OFF	OFF	OFF

OFF: Output transistor is OFF
ON: Output transistor is ON

Status When Alarm Occurred

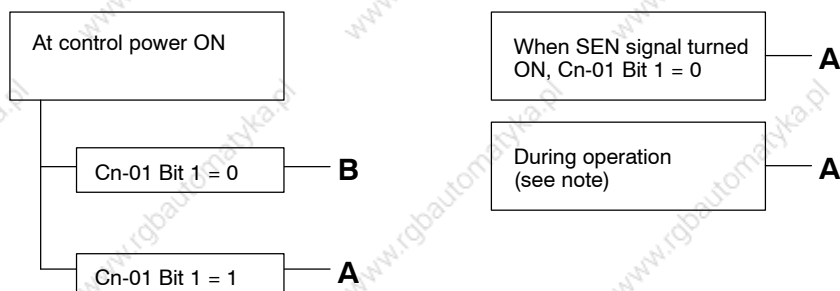

	Cause	Remedy
A	Absolute encoder malfunctioned	<ul style="list-style-type: none"> • When Cn-01 Bit 1 = 0, turn SEN signal OFF and back ON. • When Cn-01 Bit 1 = 1, turn Servopack control power OFF and back ON. • Replace servomotor if error occurs frequently.
B	Circuit board (1PWB) defective	Replace Servopack.

Note No alarm occurs at the Servopack when a data error (**A.84**) is generated. The data error (**A.84**) occurs the next time the SEN signal (or Servopack) turns ON. However, the data error (**A.84**) can be read during operation if the host controller is receiving the S-phase signal (serial data).

6.2.1 Troubleshooting Problems with Alarm Display cont.

• Display and Outputs

Digital Operator Display and Alarm Name	Alarm Output			
	Alarm Code Output			Alarm Output
	ALO1	ALO2	ALO3	
A.85 Absolute encoder overspeed (only if absolute encoder is used)	OFF	OFF	OFF	OFF

OFF: Output transistor is OFF
ON: Output transistor is ON

Status When Alarm Occurred

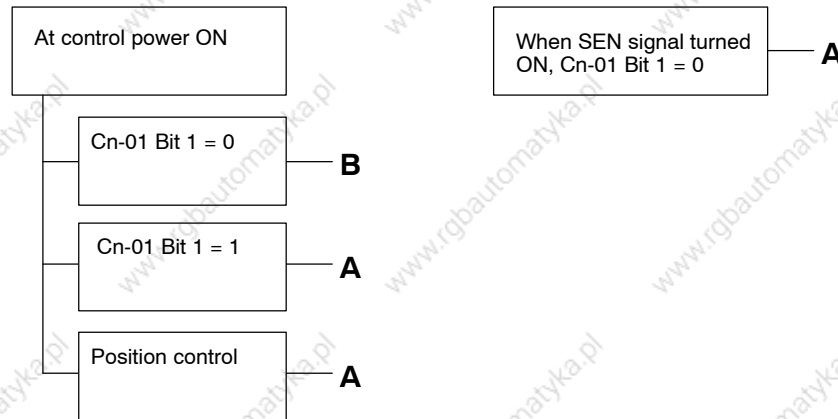

	Cause	Remedy
A	Absolute encoder turned ON at a speed exceeding 400 r/min.	Turn ON encoder power supply (or SEN signal or Servopack control power supply) at a speed not exceeding 400 r/min.
B	Circuit board (1PWB) defective	Replace Servopack.

• Display and Outputs

Digital Operator Display and Alarm Name	Alarm Output			
	Alarm Code Output			Alarm Output
	ALO1	ALO2	ALO3	
A.b1 Reference input read error (for speed/torque control only)	OFF	OFF	OFF	OFF

OFF: Output transistor is OFF
ON: Output transistor is ON

Status When Alarm Occurred



	Cause	Remedy
A	Part malfunctioned in reference read-in unit (A/D converter, etc.).	Reset alarm and restart operation.
B	Part defective in reference read-in unit (A/D converter, etc.).	Replace Servopack.
C	Circuit board (1PWB) defective	Replace Servopack.

• Display and Outputs

Digital Operator Display and Alarm Name	Alarm Output			
	Alarm Code Output			Alarm Output
	ALO1	ALO2	ALO3	
A.C1 Servo overrun	ON	OFF	ON	OFF

OFF: Output transistor is OFF
ON: Output transistor is ON

Status When Alarm Occurred

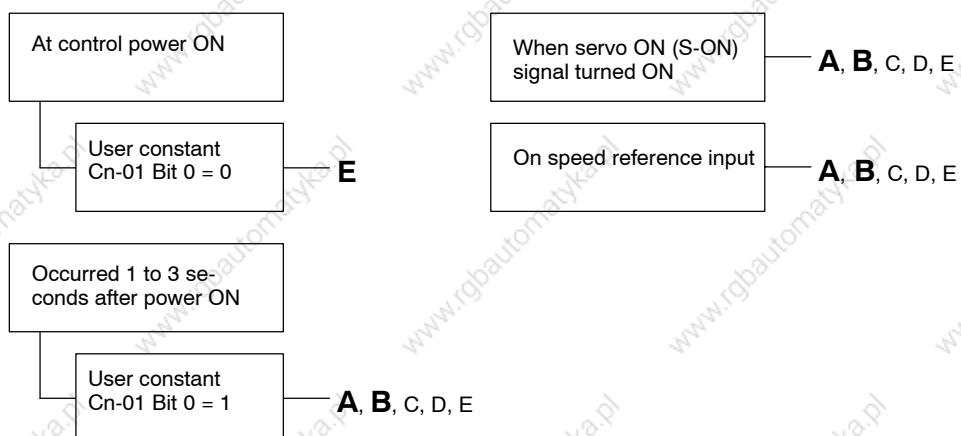

	Cause	Remedy
A	Servomotor wiring incorrect or disconnected	Check wiring and connectors at servomotor.
B	Encoder wiring incorrect or disconnected	Check wiring and connectors at encoder.
C	Incremental encoder power not supplied from Servopack.	Use the Servopack power supply for the encoder.
D	Encoder defective	Replace servomotor.
E	Circuit board (1PWB) defective	Replace Servopack.

6.2.1 Troubleshooting Problems with Alarm Display cont.

• Display and Outputs

Digital Operator Display and Alarm Name	Alarm Output			
	Alarm Code Output			Alarm Output
	ALO1	ALO2	ALO3	
A.C2 Encoder phase detection error Incremental encoder initial pulse error	ON	OFF	ON	OFF

OFF: Output transistor is OFF
ON: Output transistor is ON

Status When Alarm Occurred

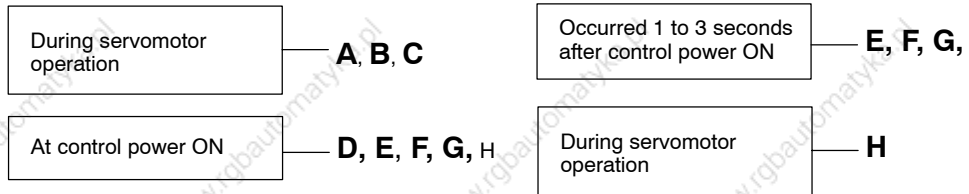

	Cause	Remedy
A	Noise in encoder wiring.	Separate encoder wiring from main wiring circuits.
B	Encoder wiring incorrect or poor connection	Check wiring and connectors at encoder.
C	Encoder defective	Replace servomotor.
D	Noise in encoder wiring.	Separate encoder wiring from main wiring circuits.
E	Encoder wiring incorrect or poor connection	Check wiring and connectors at encoder.
F	Encoder defective	Replace servomotor.
G	Absolute encoder is used.	Set the following user constants as follows: •Cn-02 bit 9 = 1 •Cn-11 (number of encoder pulses)

• Display and Outputs

Digital Operator Display and Alarm Name	Alarm Output			
	Alarm Code Output			Alarm Output
	ALO1	ALO2	ALO3	
A.C3 Encoder A-, B-phase disconnection	ON	OFF	ON	OFF
A.C6 External PG A-, B-phase disconnection (only for full-closed loop specification)				

OFF: Output transistor is OFF
ON: Output transistor is ON

Status When Alarm Occurred

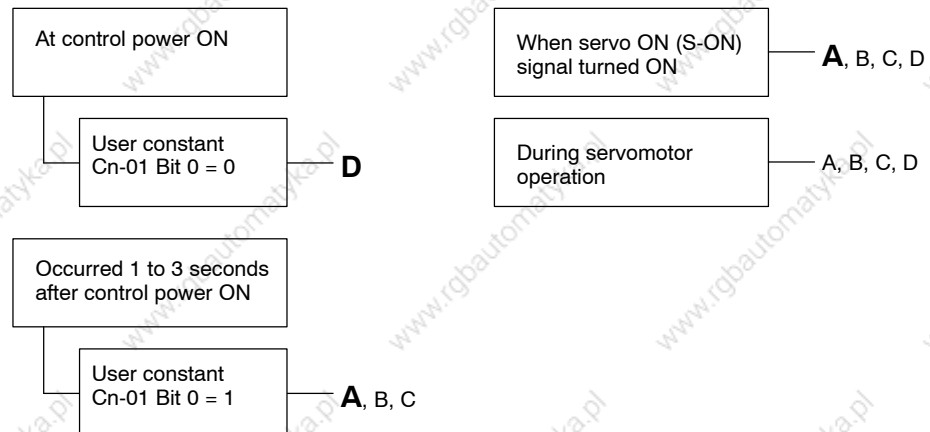

	Cause	Remedy
A	Encoder wiring incorrect or poor connection	Check wiring and connectors at encoder.
B	Noise in encoder wiring.	Separate encoder wiring from main wiring circuits.
C	Encoder defective	Replace servomotor.
D	Circuit board (1PWB) defective	Replace Servopack.

6.2.1 Troubleshooting Problems with Alarm Display cont.

• Display and Outputs

Digital Operator Display and Alarm Name	Alarm Output			
	Alarm Code Output			Alarm Output
	ALO1	ALO2	ALO3	
A.C4 Encoder C-phase disconnection	ON	OFF	ON	OFF
A.C7 External PG C-phase disconnection (only for full-closed loop specification)				

OFF: Output transistor is OFF
ON: Output transistor is ON

Status When Alarm Occurred

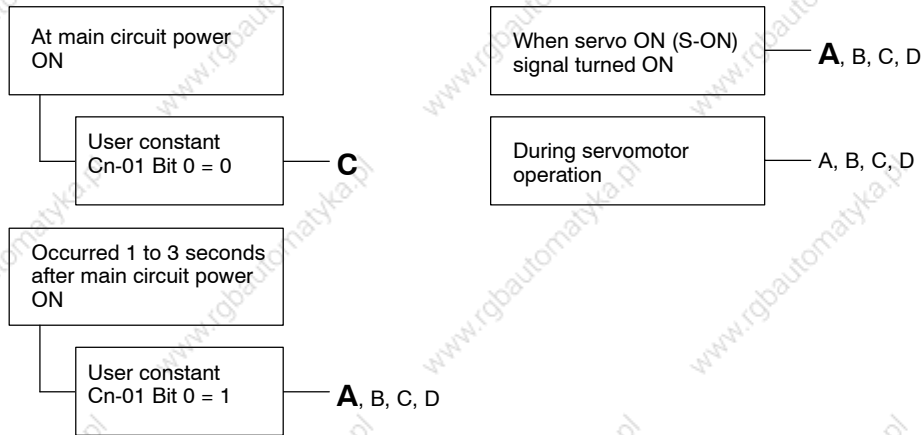

	Cause	Remedy
A	Encoder wiring incorrect or poor connection	Check wiring and connectors at encoder.
B	Noise in encoder wiring.	Separate encoder wiring from main wiring circuits.
C	Encoder defective	Replace servomotor.
D	Circuit board (1PWB) defective	Replace Servopack.

6

• Display and Outputs

Digital Operator Display and Alarm Name	Alarm Output			
	Alarm Code Output			Alarm Output
	ALO1	ALO2	ALO3	
CPF00 Digital operator transmission error 1	Not specified			

Note This alarm is not stored in alarm trace-back function memory.

Status When Alarm Occurred

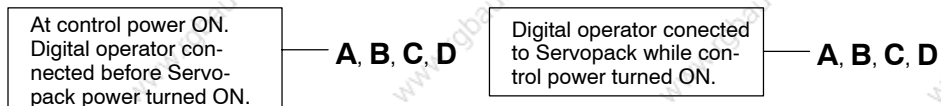

	Cause	Remedy
A	Cable defective or poor contact between digital operator and Servopack.	<ul style="list-style-type: none"> • Check connector connections. • Replace cable.
B	Malfunction due to external noise	Separate digital operator and cable from noise source.
C	Digital operator defective	Replace digital operator.
D	Servopack defective	Replace Servopack.

• Display and Outputs

Digital Operator Display and Alarm Name	Alarm Output			
	Alarm Code Output			Alarm Output
	ALO1	ALO2	ALO3	
CPF01 Digital operator transmission error 2	Not specified			

Note This alarm is not stored in alarm trace-back function memory.

Status When Alarm Occurred

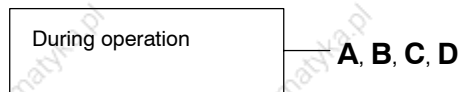

	Cause	Remedy
A	Cable defective or poor contact between digital operator and Servopack.	<ul style="list-style-type: none"> • Check connector connections. • Replace cable.
B	Malfunction due to external noise	Separate digital operator and cable from noise source.
C	Digital operator defective	Replace digital operator.
D	Servopack defective	Replace Servopack.

6.2.1 Troubleshooting Problems with Alarm Display cont.

• Display and Outputs

Digital Operator Display and Alarm Name	Alarm Output			
	Alarm Code Output			Alarm Output
	ALO1	ALO2	ALO3	
A.99	OFF	OFF	OFF	ON

OFF: Output transistor is OFF
 ON: Output transistor is ON

Status When Alarm Occurred

Indicates normal operation. Not an alarm.

6.2.2 Troubleshooting Problems with No Alarm Display

Refer to the tables below to identify the cause of a problem which causes no alarm display and take the remedy described.

Turn OFF the servo system power supply before commencing the shaded procedures.

Contact your Yaskawa representative if the problem cannot be solved by the described procedures.

Troubleshooting Table No Alarm Display

Symptom	Cause	Inspection	Remedy
Servomotor does not start	Power not connected	Check voltage across L1 and L2, L and N.	Correct the power circuit.
	Loose connection	Check terminals of connectors (1CN, 2CN).	Tighten any loose parts.
	Connector (1CN) external wiring incorrect	Check connector (1CN) external wiring	Refer to connection diagram and correct wiring.
	Servomotor or encoder wiring disconnected.		Reconnect wiring
	Overloaded	Run under no load.	Reduce load or replace with larger capacity servomotor.
	Speed/position references not input	Check input pins of connector 1CN.	Correctly input speed/position references.
	S-ON is turned OFF	Cn-01 Bit 0 is 0.	Turn S-ON input ON.
	P-CON input function setting incorrect	Refer to Subsection 3.2.1.	Refer to Subsection 3.2.1 and set user constants to match application.
	Reference pulse mode selection incorrect.	Refer to Subsection 3.2.2.	Select correct user constants Cn-02 Bits 3, 4, 5.
	Encoder type differs from user constant setting.	Incremental or absolute encoder?	Set user constants Cn-01 Bit E to the encoder type used.
	P-OT and N-OT inputs are turned OFF.	(If Cn-01 Bits 2, 3 are 0)	Turn P-OT and N-OT input signals ON.
	CLR input is turned ON	Check status of error counter clear input.	Turn CLR input OFF.
	SEN input is turned OFF.	Absolute encoder used with Cn-01 Bit 1 set to 0.	Turn SEN input ON.
Servomotor moves instantaneously, then stops	Number of encoder pulses differs from user constant setting.	2048 pulses/revolution or 1024 pulses/revolution	Set the user constant (Cn-11) to match the number of encoder pulses.
	Servomotor or encoder wiring incorrect.		Refer to Subsection 3.8.8 and correct wiring.
Suddenly stops during operation and will not restart	Alarm reset signal (ALM-RST) is turned ON because an alarm occurred.		Remove cause of alarm. Turn alarm reset signal (ALM-RST) from ON to OFF.
Servomotor speed unstable	Wiring connection to motor defective	Check connection of power lead (U, V, and W phase) and encoder connectors.	Tighten any loose terminals or connectors.

INSPECTION, MAINTENANCE, AND TROUBLESHOOTING

6.2.2 Troubleshooting Problems with No Alarm Display cont.

Symptom	Cause	Inspection	Remedy
Servomotor vibrates at approximately 200 to 400 Hz.	Speed loop gain value too high.		Reduce speed loop gain (Cn-04) preset value.
	Speed/position reference input lead too long.		Minimize length of speed/position reference input lead, with impedance not exceeding several hundred ohms
	Speed/position reference input lead is bundled with power cables.		Separate reference input lead at least 30 cm from power cables.
High rotation speed overshoot on starting and stopping.	Speed loop gain value too high.		Reduce speed loop gain (Cn-04) preset value.
Servomotor overheated	Ambient temperature too high	Measure servomotor ambient temperature.	Reduce ambient temperature to 40°C max.
	Servomotor surface dirty	Visual check	Clean dust and oil from motor surface.
	Overloaded	Run under no load.	Reduce load or replace with larger capacity servomotor.
Abnormal noise	Mechanical mounting incorrect	Servomotor mounting screws loose?	Tighten mounting screws.
		Coupling not centered?	Center coupling.
		Coupling unbalanced?	Balance coupling.
	Bearing defective	Check noise and vibration near bearing.	Consult your Yaskawa representative if defective.
Machine causing vibrations	Foreign object intrusion, damage or deformation of sliding parts of machine.	Consult with machine manufacturer.	
Speed reference 0 V but servomotor rotates.	Speed reference voltage offset applied	---	Refer to Subsections 4.2.4 and 4.2.5 and adjust reference offset.

6.2.3 Internal Connection Diagram and Instrument Connection Examples

The DR2 Servopack internal connection diagram and instrument connection examples are given below.

Refer to these diagrams during inspection and maintenance.

1) Internal Connection Diagram

- 200VAC: 30W to 200W (0.04 HP to 0.53 HP)
- 100VAV: 30W to 100W (0.04 HP to 0.13HP)

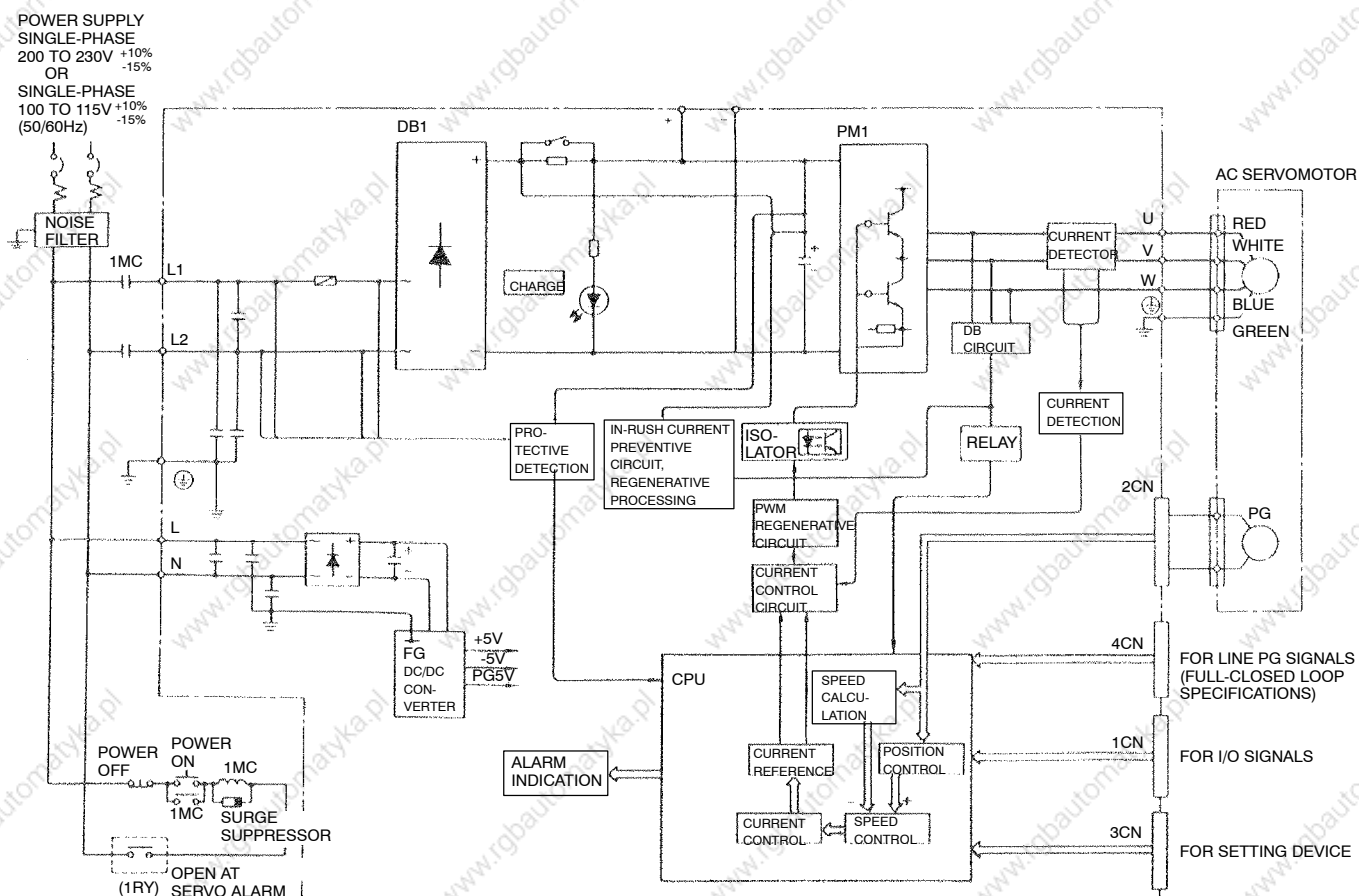

INSPECTION, MAINTENANCE, AND TROUBLESHOOTING

6.2.3 Internal Connection Diagram and Instrument Connection Examples cont.

- 200VAC: 400W, 750W (0.27 HP, 1.01 HP)
- 100VAV: 200W, 300W (0.53 HP, 0.40HP)

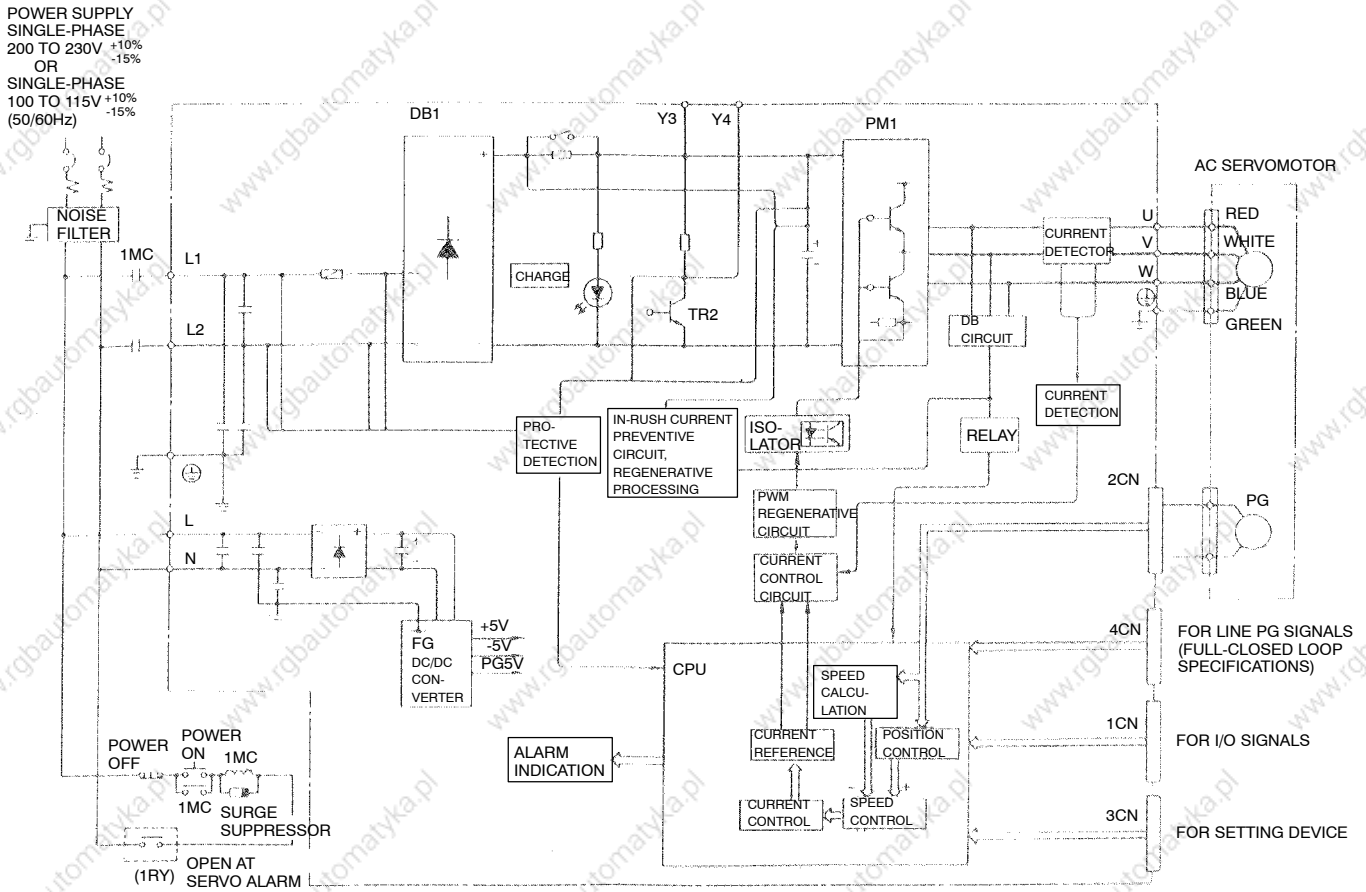

2) Instrument Connection Examples – Speed/Torque Control

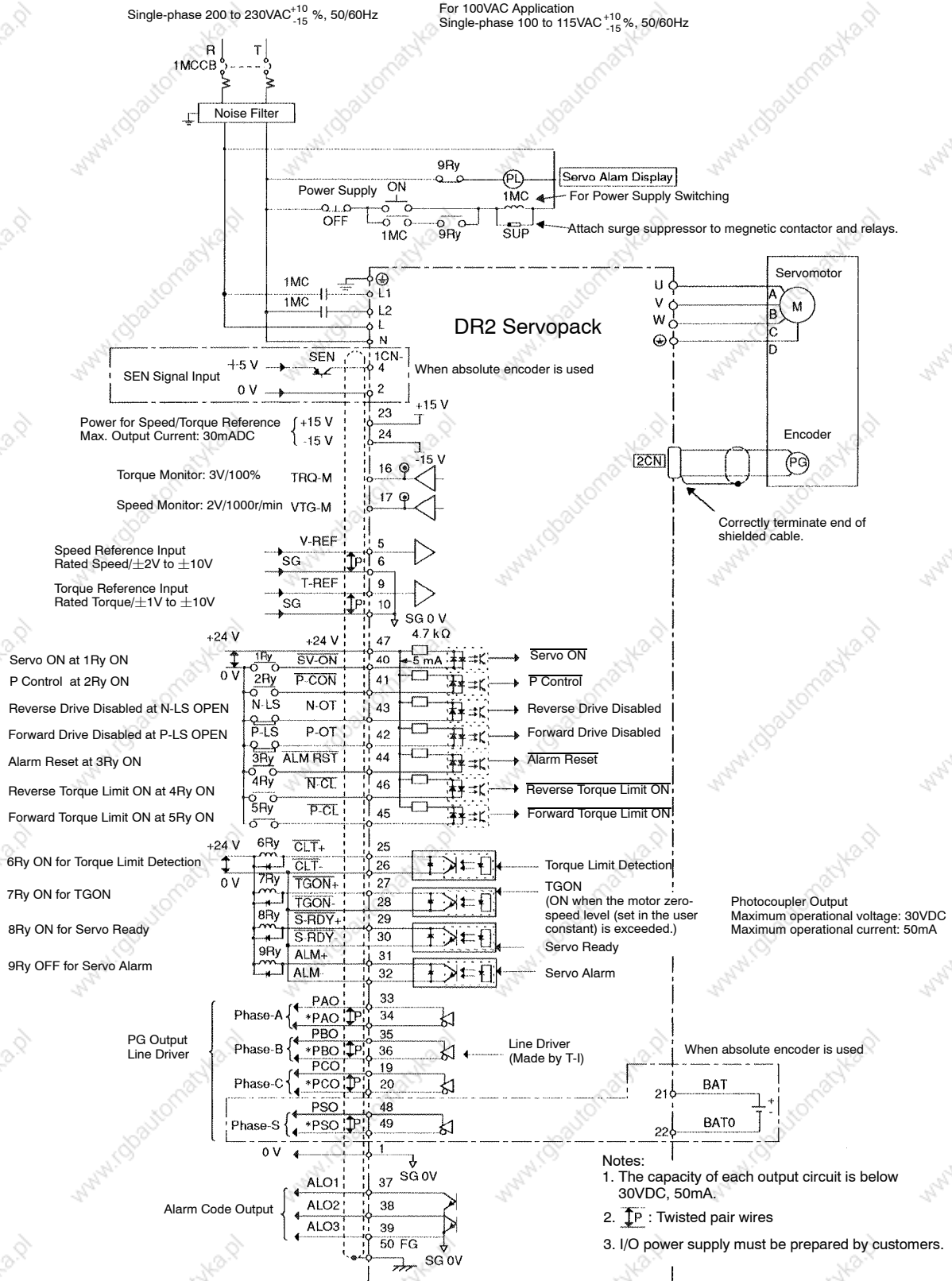

6.2.3 Internal Connection Diagram and Instrument Connection Examples cont.

3) Instrument Connection Examples – Position Control

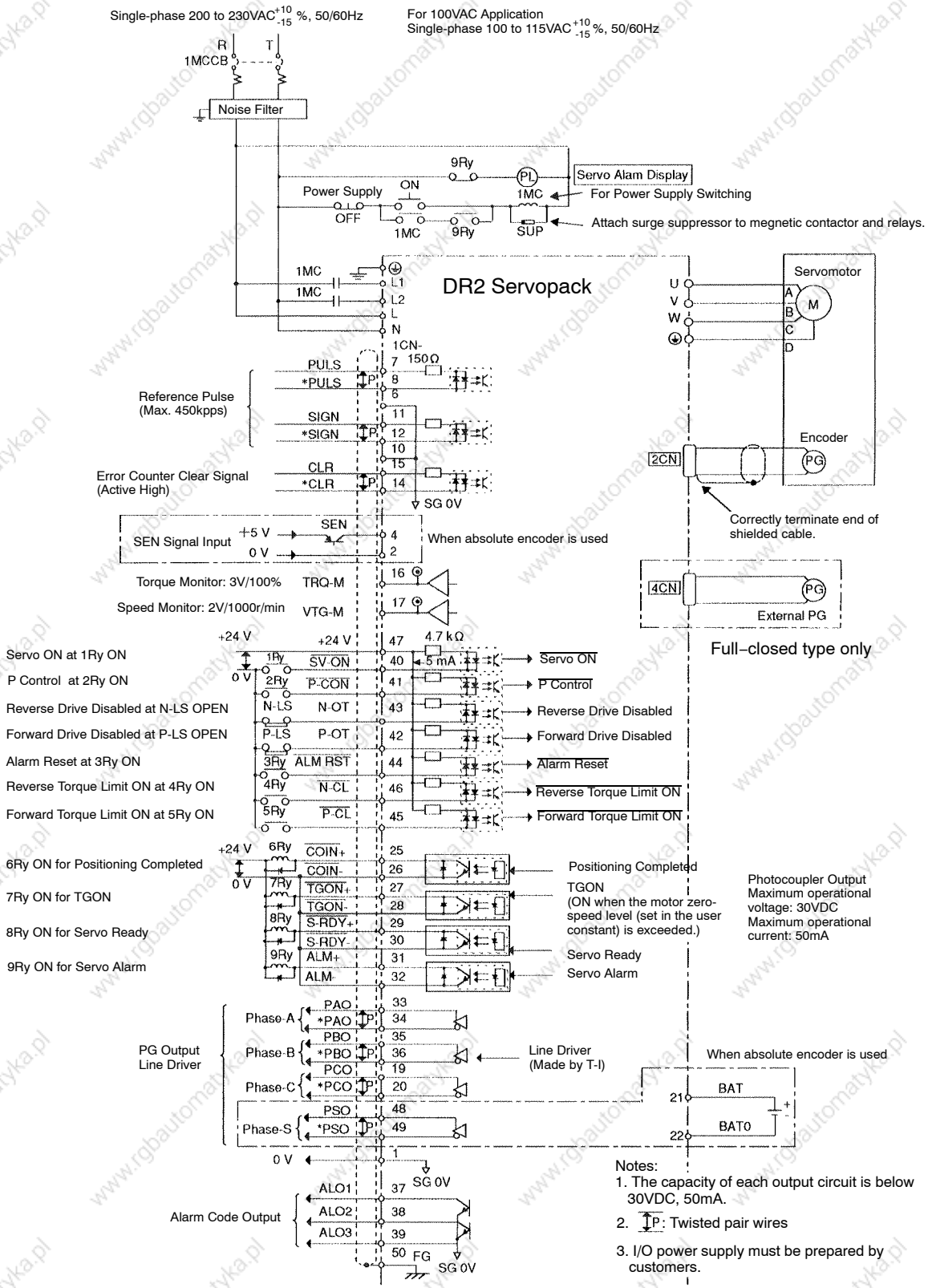

6

MEASURES TO SATISFY THE REQUIREMENTS OF EMC DIRECTIVE

This chapter outlines EMC directive of European Safe Standard especially to DR2 Servopack.

In addition, section 2 describes concrete measures for DR2 Servopack to conform to EN standard.

7.1	What is European Safe Standard?	416
7.1.1	What is EN Standard?	416
7.1.2	What is CE Marking?	416
7.1.3	EMC Directive	417
7.1.4	Certification Body TÜV Authorized by EU	417
7.2	Measures to Satisfy the Requirements of EMC Directive	418
7.2.1	Applicable Servomotor	418
7.2.2	Applicable Noise Filter	418
7.2.3	Motor Cables	419
7.2.4	Encoder Cables	419
7.2.5	Control I/O	420
7.2.6	Digital Operator and Monitoring by Personal Computer	420
7.2.7	The Core on the Cable	421
7.2.8	Wiring	421

7.1 What is European Safe Standard?

■ This section outlines the contents of EN standard, CE marking and EMC directive.

7.1.1	What is EN Standard?	416
7.1.2	What is CE Marking?	416
7.1.3	EMC Directive	417
7.1.4	Certification Body TÜV Authorized by EU	417

7.1.1 What is EN Standard?

- 1) Board of directors, which consisted of EC cabinet members, provided “EC directive” in 1985 when the European Union was still called EC, with the purpose of management of products from each area of Europe under one standard over applicable standards of member countries.
- 2) Concrete standard to satisfy “EC directive” is “EN standard (European standard)”. At the present time, they have instructions for 12 items such as machine directive, low-voltage directive, etc. in addition to EMC directive specified for each of dozens of standards.

7.1.2 What is CE Marking?

- 1) “CE marking” is a mark to indicate that a product is a safe product conforming to the protection level specified by EC directive.
Attaching this mark to a machine indicates that the machine is a product conforming to EN standards based on EC directive.
In Europe, every industrial machine has been obliged to have CE marking by machine directive since the 1st of January, 1995.
- 2) “CE” is an abbreviation of Communauté Européenne in French, which means European Communities (EC).
After an increase of members, the name has been changed to EU (European Union), but EC is still used for the name of the directive.

7.1.3 EMC Directive

- 1) This is one of EC directives related to safe requirements for industrial products. EMC directive is concerned with electro-magnetic interference (magnetic noise) mainly from electronic devices, and specify two measures; whether a product controls generating electro-magnetic interference down to a level where it does not affect other devices (generating side) and whether any measures are provided to prevent an electronic device receiving electro-magnetic interference from malfunctioning (receiving side). If a product is considered in the above two aspects of the generating side and the receiving side of electro-magnetic interference and provided with proper measures, the product can be said to “coexist with electro-magnetic environment”, which means that the product satisfies EMC requirements.
- 2) EMC is an abbreviation of Electro-Magnetic Compatibility, indicating electro-magnetic compatibility of a product.
The following diagram outlines the contents explained in 1).

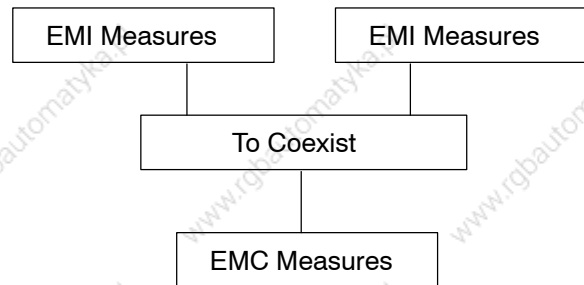

In the above diagram:

EMI: Electro-Magnetic Interference (generating side)
EMS: Electro-Magnetic Susceptibility (receiving side)

Machines are to be tested according to their operating status.

7.1.4 Certification Body TÜV Authorized by EU

- 1) TÜV is one of the certification bodies authorized by European Union (EU) specified organization, which is a German “technical inspection association”.
TÜV has an office (TÜV Product Service, etc.) in Japan, through which Yaskawa obtains approvals.
DR2 Servopack has been approved by this TÜV.

7.2 Measures to Satisfy the Requirements of EMC Directive

This section describes the required measures to adapt DR2 Servopack to EMC directive (EN50081-2, EN50082-2).

7.2.1	Applicable Servomotor	418
7.2.2	Applicable Noise Filter	418
7.2.3	Motor Cables	419
7.2.4	Encoder Cables	419
7.2.5	Control I/O	420
7.2.6	Digital Operator and Monitoring by Personal Computer	420
7.2.7	The Core on the Cable	421
7.2.8	Wiring	421

7.2.1 Applicable Servomotor

- 1) Use Yaskawa Servomotor conforming to EN standard.
For details, refer to 5.4.2 *Servomotor Dimensional Drawings (TÜV approved)*.

Servomotor Type Example: SGM-01V312 (200VAC, 100W)
SGM-01W312 (100VAC, 100W)

7.2.2 Applicable Noise Filter

- 1) Use the following noise filter.
Make sure to ground the noise filter securely.

Applied Voltage	Servopack Type DR2-	Servopack Rated Input Current A (rms)	Noise Filter Type and Specifications (Input Line)	Noise Filter Type and Specifications (Power Supply for Brake)
200VAC Class	A3A□	1.3	SUP-P5H-EPR 250V, 5A	SUP-P5H-EPR 250V, 5A
	A5A□	1.5		
	01A□	2.5		
	02A□	4.0		
	04A□	6.0	SUP-P8H-EPR 250V, 8A	
	08A□	11.0	SUP-P10H-EPR 250V, 10A	
100VAC Class	A3B□	2.0	SUP-P5H-EPR 250V, 5A	
	A5B□	2.6		
	01B□	4.5		
	02B□	8.0	SUP-P8H-EPR 250V, 8A	
	03B□	14.0	SUP-P10H-EPR 250V, 10A	

7.2.3 Motor Cables

- 1) Max. cable length is 20m.

7.2.4 Encoder Cables

- 1) For PG input (2CN), use the following connectors and cables.
 Max. cable length is 20m.
 Connectors on Servopack and Servomotor are plated.
 Make sure to ground between PG cable shield and connector case.

Encoder Type		Incremental	Absolute
Cable only		B9400064*1	DP8409123*1
Connector on Servopack Side	Case	MR-20L4*2	
	Connector	MR-20F*2	
Connector on Motor Side		17JE13090-02D8A*3	17JE13150-02D8A*3
Stud for Connector on Motor Side		17L-002A*3	

*1 Contact your Yaskawa representative for details.

*2 Made by Honda Tsushin Kogyo Co., Ltd.

*3 Made by DDK Ltd.

Connect the motor side connectors as shown below using studs.

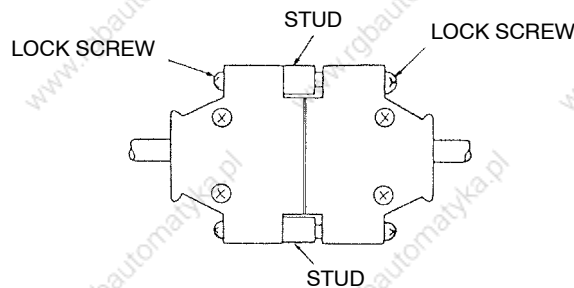

MEASURES TO SATISFY THE REQUIREMENTS OF EMC DIRECTIVE

7.2.6 Digital Operator and Monitoring by Personal Computer

2) Connect the PG cable as follows:

•Incremental Encoder

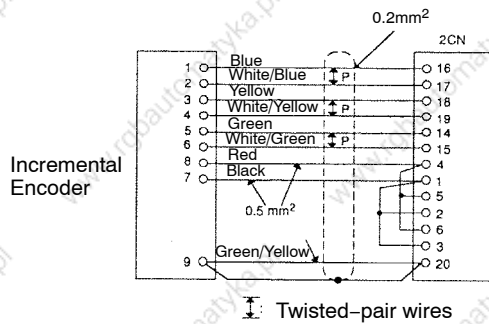

•Absolute Encoder

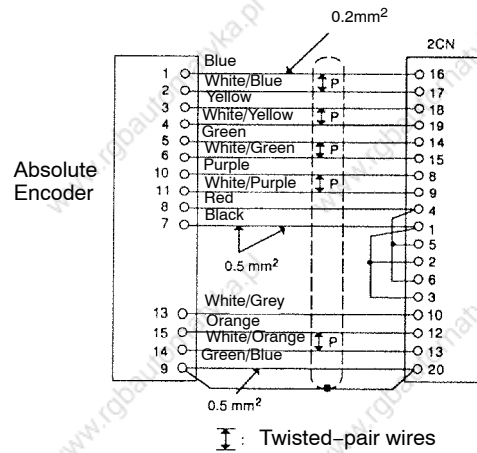

7.2.5 Control I/O

- 1) For control I/O (1CN) connector, use the following connector. Connector case shown below is plated.
For 1CN cable, use the shielded cable and make sure to ground between cable shield and connector case.
Also, perform shield processing on host controller side securely.

Connector: MR-50M

Connector Case: MR-50L4

7.2.6 Digital Operator and Monitoring by Personal Computer

- 1) Use digital operator or personal computer (for monitoring) only at test run.
Disconnect them during normal operation.

7.2.7 The Core on the Cable

1) Attach the core on the cable as shown below:

- Core specifications

Note: 1.5 turn is as shown below:

Core Model	ESD-SR-25
Quantity	1
Turn	1.5
Manufacturer	Tokin Corp.

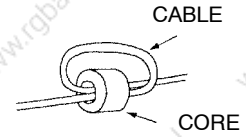

- Cable line and the line position where the core is attached:

Cable Line	PG Line	I/O Signal Input Line
Line Position	Near the Servopack side	Near the host controller and Servopack

7.2.8 Wiring

1) The following diagram shows the wiring example for motor with brake. The noise filter and the core are shown in the same figure.

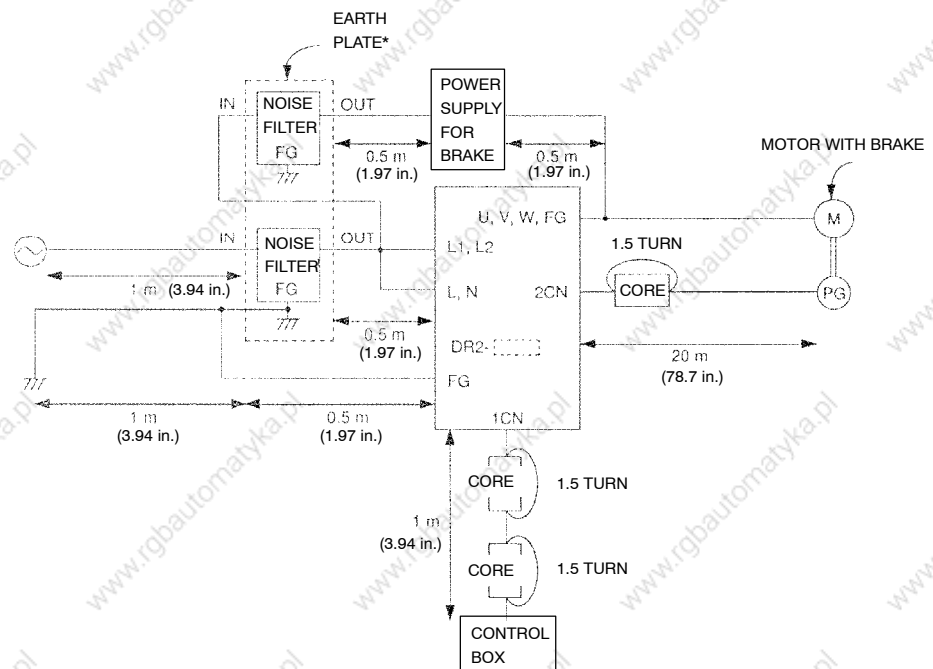

* When earth plate is not used, polish the mounted noise filter part with sand paper to expose the metal. Then, ground the noise filter securely on the panel.

Appendix A

Differences Between DR2 and DR1, SGDA and SGD Servopacks

A

The functions and performance of Servopacks DR2, DR1, SGDA and SGD are listed and compared in the Tables.

Comparison of the DR2 Servopack with the DR1 Servopack (1)

Item	DR2 Servopack		DR1 Servopack
Speed Loop Frequency Characteristics	250 Hz		100 Hz
Servo Gain Compensation (See note 1)	Yes		No
Auto Tuning	7-stage settings		No
Serial Communications Features	User constant setting/editing Reference to all monitored values Auto-tuning Alarm trace-back confirmation		No
Multi-axis Communications	Yes (However, use rotary switch when axis is set.)		No
100 V, 300 W Version	Yes (External dimensions identical to 200 V, 750 W version)		No
Applicable Servomotors	Both SGM and SGMP servomotors Either servomotor type can be used by changing user constant (memory switch) setting. No Servopack change required.		SGM servomotors. Not applicable to SGMP Servomotors.
Torque Feed Forward (See note 2)	Yes	Torque feed forward and torque restriction with analog references cannot be used simultaneously. Settings identical for forward and reverse.	No
Torque Restriction with Analog References (See note 2)	Yes		No
Reference Pulse Input Unit Filter Selection (See note 3)	Yes	Select according to output form of the customer's controller (line driver or open collector).	Yes
External Reference Receive During Contact Input Speed Control	Selectable (Software version: 0003 or later. See Par. 4.2.8.)		Always receivable
Reference Pulse Inhibit	Yes	Switch the P-CON signal with the user constant settings.	No
Reference Pulse Value Display (See note 3)	Possible (Monitor mode Un-09)		Not possible
Analog Speed Monitor	2V/1000r/min		0.5V/1000r/min
Analog Torque Monitor	3V/100%		0.5V/100%
PG Dividing Open Collector Output	Can be available as an option		Available only to Phase-C
Full-closed Loop	Possible		Not possible
Electronic Gear Function	Yes		No
Soft Stop Function	Yes		The same as that of soft start
Smoothing Function	Yes		No
Regenerative Processing Circuit	None However, only 200V, 30W to 200W can be connectable to regenerative unit. (200V, 30W to 200W 100V, 30W to 100W)		None Regenerative unit cannot be connected. (200V, 30W to 100W 100V, 30W and 50W)
	Incorporated (200V, 400W and 750W 100V, 200W and 300W)		Incorporated (200V, 200W to 750W 100V, 100W and 200W)
Power Supply	Main circuit and control circuit are separated.		

- Note**
- 1) Material is being prepared on speed loop servo gain compensation.
 - 2) Speed control type only.
 - 3) Position control type only.

Item	DR2 Servopack	DR1 Servopack
Digital Operator	Hand-held type: JUSP-OP02A-1	Hand-held type: JUSP-OP02A
Motor Cable	3, 5, 10, 15, 20m are available. (Not the same types as those of SGD, SGDA)	3, 5, 10, 15, 20m are available. (The same types as those of SGD, SGDA)
Encoder Cable	3,5,10,15,20m are available (Not the same types as those of SGD, SGDA)	
Conformable Overseas Standard	TÜV approved (Conforming to EN61010)	No
Control Type	Speed, torque and position are controlled by the same Servopack.	
User Constant Cn-05 Setting Unit	0.01ms	1ms

A

Comparison of the DR2 Servopack with the DR1 Servopack (2)

Item		DR2 Servopack	DR1 Servopack	Remarks
Type		DR2-□□AC (Semi-closed type) DR2-□□AC-F (Full-closed type)	DR1-□□AC (Incremental type) DR1-□□AA (Absolute type)	As for DR2, factory setting of applicable motor is SGM Servomotor.
		DR2-□□ACP (Semi-closed type) DR2-□□ACP-F (Full-closed type)	-	Factory setting of applicable motor is SGMP Servomotor.
Outside Dimensions		60W × 250H × 204D (200V: 30W to 200W) (100V: 30W to 100W)	60W × 250H × 250D (200V: 30W to 200W) (100V: 30W to 100W)	Mounting hole position is in common with DR2 and DR1.
		75W × 250H × 252D (200V: 400W and 750W) (100V: 200W and 300W)	75W × 250H × 250D (200V: 400W and 750W) (100V: 200W)	
Base-mount type		Option	No	
Motor Terminals		External terminals in conformance with Standard (PHOENIX CONTACT)	External terminal (M4 screw)	
Encoder Connector 2CN		MR-20RMA	MR-20RMA	Common with DR2 and DR1. (Different from SGD type)
Connector 4CN for Full-closed Type		MR-8RMA	-	
External I/O Signals (1CN)	Used Connector	MR-50RFA	MR-50RFA	Common with DR2 and DR1.
	3-pin	PL1: PULS pull-up	SG: Signal ground	PL1, 2 and 3 are used for pull-up of open collector input.
	5-pin	V-REF: Exclusive for speed reference input	IN-A: Main input	
	9-pin	T-REF: Exclusive for torque reference input	IN-B: Auxiliary input	Signals other than described here are used in common with DR2 and DR1.
	13-pin	PL2: SIGN pull-up	SG: Signal ground	
	18-pin	PL3: CLR pull-up	SG: Signal ground	
	23-pin	+15V: Reference power supply 30mA	PHC: Phase-C open collector	
	24-pin	-15V: Reference power supply 30mA	SG: Signal ground	

Comparison of the SGDA Servopack with the SGD Servopack

Item	SGDA Servopack		SGD Servopack										
Speed Loop Frequency Characteristics	250 Hz		150 Hz										
Servo Gain Compensation (See note 1)	Yes		No										
Auto Tuning	7-stage settings		3-stage settings										
Serial Communications Features	User constant setting/editing Reference to all monitored values Auto-tuning Alarm trace-back confirmation		User constant setting/editing										
Multi-axis Communications	Yes (However, 1:1 communications when axis address is set.)		No										
100 V, 300 W Version	Yes (External dimensions identical to 200 V, 750 W version)		No										
Applicable Servomotors	Both SGM and SGMP servomotors Either servomotor type can be used by changing user constant (memory switch) setting. No Servopack change required.		SGM servomotors. <div style="border: 1px solid black; padding: 5px;"> Servopack must be changed to use SGMP servomotor. SGMP-compatible Servopack Types SGD-<table style="display: inline-table; border: none;"> <tr> <td style="border: none;">Capacity</td> <td style="border: none;">P</td> </tr> <tr> <td style="border: none;">01 : 100W</td> <td style="border: none;">S : Speed control</td> </tr> <tr> <td style="border: none;">02 : 200W</td> <td style="border: none;">P : Position control</td> </tr> <tr> <td style="border: none;">04 : 400W</td> <td style="border: none;">A : 200 V</td> </tr> <tr> <td style="border: none;">08 : 750W</td> <td style="border: none;">B : 100 V</td> </tr> </table> SGMP-compatible </div>	Capacity	P	01 : 100W	S : Speed control	02 : 200W	P : Position control	04 : 400W	A : 200 V	08 : 750W	B : 100 V
Capacity	P												
01 : 100W	S : Speed control												
02 : 200W	P : Position control												
04 : 400W	A : 200 V												
08 : 750W	B : 100 V												
Torque Feed Forward (See note 2)	Yes	Torque feed forward and torque restriction with analog references cannot be used simultaneously.	No										
Torque Restriction with Analog References (See note 2)	Yes	Settings identical for forward and reverse.	No										
Reference Pulse Input Unit Filter Selection (See note 3)	Yes	Select according to output form of the customer's controller (line driver or open collector).	None										
External Reference Receive During Contact Input Speed Control	Possible		Not possible										
Reference Pulse Inhibit	Yes	Switch the P-CON signal with the user constant settings.	No										
Reference Pulse Value Display (See note 3)	Possible (Monitor mode Un-09)		Not possible										
Analog Speed Monitor	No		No										
Analog Torque Monitor	No		No										
PG Dividing Open Collector Output	Can be available as an option		Not possible										
Full-closed Loop	Not possible		Not possible										
Electronic Gear Function	Yes		Yes										
Soft Stop Function	Yes		Yes										
Smoothing Function	Yes		Yes										
Regenerative Processing Circuit	None (Regenerative unit can be connectable.)												
Power Supply	Main circuit and control circuit are separated.												
Digital Operator	Hand-held type : JUSP-OP02A-1 Mount type : JUSP-OP03												
Motor Cable	3,5,10,15,20m are available												

DIFFERENCES BETWEEN DR2 AND DR1, SGDA AND SGD SERVOPACKS

Item	SGDA Servopack	SGD Servopack
Encoder Cable	3,5,10,15,20m are available	
Conformable Overseas Standard	No	
Control Type	Speed/torque and position are controlled by the different type Servopack.	
User Constant Cn-05 Setting Unit	1ms	

- Note**
- 1) Material is being prepared on speed loop servo gain compensation.
 - 2) Speed control type only.
 - 3) Position control type only.

Appendix B

Servo Adjustment

B

This appendix presents the basic rules for Σ -Series AC Servopack gain adjustment, describes various adjustment techniques, and gives some preset values as guidelines.

B.1	Σ-Series AC Servopack Gain Adjustment	430
B.1.1	Σ -Series AC Servopacks and Gain Adjustment Methods	430
B.1.2	Basic Rules for Gain Adjustment	431
B.2	Adjusting a Servopack for Speed Control	432
B.2.1	Adjusting Using Auto-tuning	432
B.2.2	Manual Adjustment	433
B.3	Adjusting a Servopack for Position Control . .	436
B.3.1	Adjusting Using Auto-tuning	436
B.3.2	Manual Adjustment	437
B.4	Gain Setting References	441
B.4.1	Guidelines for Gain Settings According to Load Inertia Ratio	441

B.1 Σ -Series AC Servopack Gain Adjustment

This section gives some basic information required to adjust the servo system.

B.1.1	Σ -Series AC Servopacks and Gain Adjustment Methods	430
B.1.2	Basic Rules for Gain Adjustment	431

B.1.1 Σ -Series AC Servopacks and Gain Adjustment Methods

1) Five types of Σ -Series AC Servopack are available: DR1, SGDA, SGDB, SGD and the current DR2.

The adjustment method is basically identical for each Servopack type, except that auto-tuning is not available for some types.

The DR2, SGDA, SGDB and SGD Servopacks allow both manual adjustment by the conventional method of observing the machine response and automatic adjustment using the internal auto-tuning function. The DR1 Servopack does not offer auto-tuning.

2) The main user constants changed by the customer to adjust the servo system include the following:

- Cn-04 (Speed Loop Gain)
- Cn-05 (Speed Loop Integration Time Constant)
- Cn-17 (Torque Reference Filter Time Constant)
- Cn-1A (Position Loop Gain)

In a speed-control Servopack (where speed references are applied as analog voltages), the position loop is controlled by the host controller, so the position loop gain is normally adjusted at the host controller.

If adjustment is not possible at the host controller, the same adjustment can be achieved using Cn-03 (Speed Reference Gain), but the servomotor may not reach maximum speed for some preset values of this user constant.

A simple block diagram of the servo system is shown below.

Servo System Block Diagram

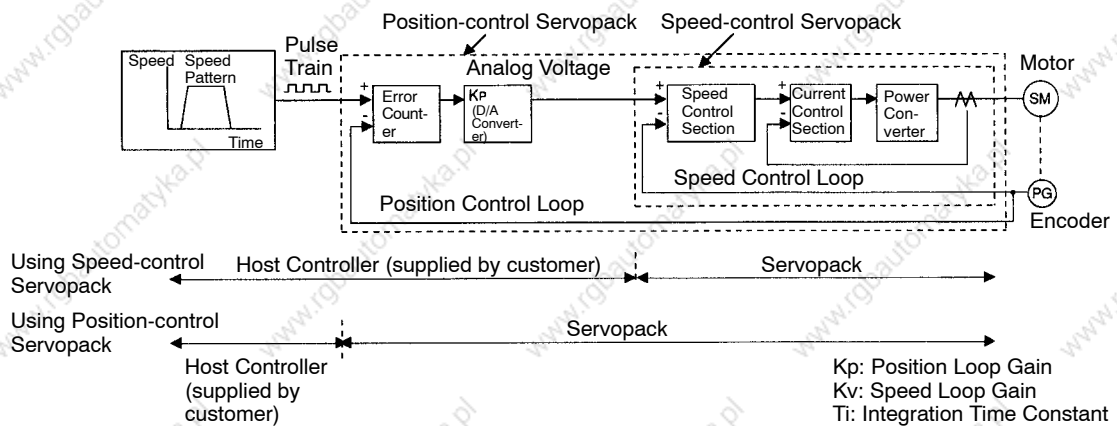

Note: A position-control Servopack has no D/A converter for speed reference output. This conversion is handled by internal calculations.

B.1.2 Basic Rules for Gain Adjustment

- 1) The servo system comprises three feedback systems: position loop, speed loop, and current loop. The response must increase from outer loop to inner loop (see Servo System Block Diagram, above). The response deteriorates and oscillates if this principle is not obeyed.
The customer cannot adjust the current loop. Sufficient response is assured for the current loop.
The customer can adjust the position loop gain and speed loop gain, as well as the speed loop integration time constant and torque reference filter.
- 2) The position loop and speed loop must be adjusted to provide a balanced response. In particular, if the position loop gain only is increased (adjustment with Cn-03 at the Servopack if position loop gain adjustment is not possible at the host controller), the speed references oscillate and the result is increased, oscillating position control times.
If the position loop gain (or Cn-03) is increased, the speed loop gain (Cn-04) must be similarly increased.
If the mechanical system starts to oscillate after the position loop gain and speed loop gain are increased, do not increase the gains further.
- 3) The position loop gain should not normally be increased above the characteristic frequency of the mechanical system.
For example, the harmonic gears used in an articulated robot form a structure with extremely poor rigidity and a characteristic frequency of approximately 10 to 20 Hz. This type of machine allows a position loop gain of only 10 to 20 (1/sec).
Conversely, the characteristic frequency of a precision machine tool such as a chip moulder or IC bonder exceeds 70 Hz, allowing a position loop gain exceeding 70 (1/sec) for some machines.
Therefore, although the response of the servo system (controller, servo driver, motor, detectors, etc.) is an important factor where good response is required, it is also important to improve the rigidity of the mechanical system.
- 4) In cases where the position loop response is greater than or equal to the speed loop response and linear acceleration or deceleration is attempted, the poor speed loop response and follow-up cause an accumulation of position loop errors and result in increased output of speed references from the position loop.
The motor moves faster and overshoots as a result of increased speed references, and the position loop tends to decrease the speed references. However, the poor motor follow-up due to the poor speed loop response results in oscillating speed references, as shown in the diagram below.
If this problem occurs, reduce the position loop gain or increase the speed loop gain to eliminate the speed reference oscillations.

Speed Reference Output with Unbalanced Position Loop Gain and Speed Loop Gain

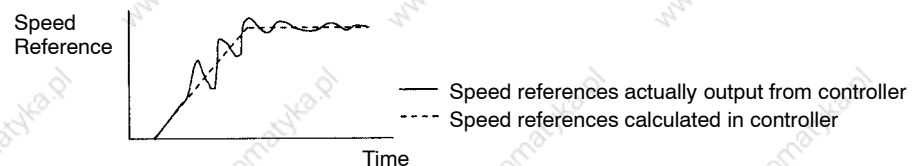

B.2 Adjusting a Servopack for Speed Control

This section gives examples of adjusting the gains of a Servopack for speed control manually and using auto-tuning.

B.2.1	Adjusting Using Auto-tuning	432
B.2.2	Manual Adjustment	433

B.2.1 Adjusting Using Auto-tuning

The DR1 Servopack does not offer auto-tuning.

1) Important Points About Auto-tuning

a) Speed During Auto-tuning

Auto-tuning may not function correctly if the speed is too low. Set the speed to approximately 500 r/min.

Set the speed with the user constant Cn-10 (Jog speed).

b) Selecting Machine Rigidity

If the machine rigidity is unknown, select the rigidity according to the following standards.

Drive Method	Machine Rigidity	
	DR2, SGDA, SGDB	SGD
Ball screw, direct	3 (C-003) to 7 (C-007)	High/medium response
Ball screw, with reduction gears	2 (C-002) to 3 (C-003)	Medium response
Timing belt	1 (C-001) to 3 (C-003)	Low/medium response
Chain	1 (C-001) to 2 (C-002)	Low response
Wave reduction gears*	1 (C-001) to 2 (C-002)	Low response

* Product name: Harmonic Drive

Select the machine rigidity level for DR2, SGDA and SGDB and according to the table.

Level	Rigidity
7 (C-007)	High
6 (C-006)	:
5 (C-005)	:
4 (C-004)	:
3 (C-003)	Medium
2 (C-002)	:
1 (C-001)	Low

Auto-tuning may not end if high response is selected for a low-rigidity machine or low response is selected for a high-rigidity machine.

If this occurs, halt the auto-tuning and change the machine rigidity selection.

2) If Auto-tuning is Unsuccessful

Auto-tuning may be unsuccessful (the end of auto-tuning not displayed) for machines with large play or extremely low rigidity.

Similarly, auto-tuning may be unsuccessful for a machine with high load inertia (exceeding 15 to 30 times the motor moment of inertia).

In these cases, use conventional manual adjustment.

Even if auto-tuning is successful for a machine with large fluctuations in load inertia or load torque, vibrations or noise may still occur in some positions.

3) Response During Operation is Unsatisfactory after Auto-tuning

Auto-tuning sets the gain and integration time constant with some safety margin (to avoid oscillations). This can result in positioning times.

In particular, the target position may not be reached if low response is selected, because the machine does not move in response to the final minute references. An excessively high setting of the integration time constant (Cn-05) during auto-tuning is one cause of this problem.

If response is slow after auto-tuning, the speed loop gain cannot be manually increased very much before oscillation starts.

In this case, manually reduce the integration time constant while observing the machine behavior to ensure oscillation does not occur.

Auto-tuning does not set the torque reference filter (Cn-17) or speed reference gain (Cn-03).

B.2.2 Manual Adjustment

1) The role of each user constant is briefly described below.

a) Speed Loop Gain (Cn-04)

This user constant sets the speed loop response.

The response is improved by setting this user constant to the maximum value in the range which does not cause vibrations in the mechanical system.

The following formula relates the speed loop gain to the load inertia.

$$\text{Speed Loop Gain } K_v \text{ [Hz]} = \frac{2}{\frac{GD_L^2}{GD_M^2} + 1} \times (\text{Cn-04 Preset value})$$

GD_L^2 : Motor Axis Converted Load Inertia

GD_M^2 : Motor Moment of Inertia

b) Speed Loop Integration Time Constant (Cn-05)

The speed loop has an integration element to allow response to micro-inputs. This integration element can produce a delay in the servo system, and the positioning setting time increases and response becomes slower as the time constant increases. However, the integration time constant must be increased to prevent machine vibration if the load inertia is large or the mechanical system includes a element that is prone to vibration.

The following formula calculates a guideline value.

$$T_i \geq 2.3 \times \frac{1}{2\pi \times K_v}$$

Ti: Integration Time Constant (sec)

Kv: Speed Loop Gain (Hz) (calculated above)

c) Torque Reference Filter Time Constant (Cn-17)

When a ball screw is used, torsional resonance may occur which increases the pitch of the vibration noise.

This vibration can sometimes be overcome by increasing the torque reference filter time constant.

However, this filter will produce a delay in the servo system, just like the integration time constant, and its value should not be increased more than necessary.

d) Speed Reference Gain (Cn-03)

Changing the speed reference gain (Cn-03) changes the position loop gain an equivalent amount. That is, reducing the speed reference gain is equivalent to reducing the position loop gain and increasing it is equivalent to increasing the position loop gain. Use this user constant (Cn-03) in the following circumstances:

- No position loop gain adjustment at host controller (including cases where fine adjustment not possible by changing number of D/A converter bits)
- Clamping the speed reference output range to specific speeds

Normally leave at the factory setting.

NOTE For a speed-control SGD or SGDA Servopack or SGDB or DR2 Servopack used for speed control, the position loop gain (Cn-1A) is valid in zero-clamp mode only. The position loop gain (Cn-1A) user constant is always invalid for a DR1 Servopack. For normal control, change the position loop gain at the host controller or adjust the speed reference gain (Cn-03) in the Servopack. Changing Cn-1A does not change the position loop gain.

2) Adjustment Procedure

- a) Set the position loop gain at the host controller to a low value and increase the speed loop gain (Cn-04) within the range that no abnormal noise or vibration occurs. If adjustment of the position loop gain is not possible at the host controller, reduce the speed reference gain (Cn-03).
- b) Slightly reduce the speed loop gain from the value at step 1, and increase the position loop gain at the host controller in the range that no overshooting or vibration occurs. If adjustment of the position loop gain is not possible at the host controller, increase the speed reference gain (Cn-03).
- c) Determine the speed loop integration time constant (Cn-05), by observing the positioning setting time and vibrations in the mechanical system. The positioning setting time may become excessive if the speed loop integration time constant (Cn-05) is too large.
- d) It is not necessary to change the torque reference filter time constant (Cn-17) unless torsional resonance occurs in the machine shafts. Torsional resonance may be indicated by a high vibration noise. Adjust the torque reference filter time constant (Cn-17) to reduce the vibration noise.
- e) Finally, fine adjustment of the position gain, speed gain, and integration time constant is required to determine the optimum point for step response.

B.3 Adjusting a Servopack for Position Control

This section gives examples of adjusting the gains of a Servopack for position control manually and using auto-tuning.

B.3.1	Adjusting Using Auto-tuning	436
B.3.2	Manual Adjustment	437

B.3.1 Adjusting Using Auto-tuning

The DR1 Servopack does not offer auto-tuning.

1) Important Points About Auto-tuning

a) Speed During Auto-tuning

Auto-tuning may not function correctly if the speed is too low. Set the speed to approximately 500 r/min.

Set the speed with the user constant Cn-10 (Jog speed).

b) Selecting Machine Rigidity

If the machine rigidity is unknown, select the rigidity according to the following standards.

Drive Method	Machine Rigidity	
	DR2, SGDA, SGDB	SGD
Ball screw, direct	3 (C-003) to 7 (C-007)	High/medium response
Ball screw, with reduction gears	2 (C-002) to 3 (C-003)	Medium response
Timing belt	1 (C-001) to 3 (C-003)	Low/medium response
Chain	1 (C-001) to 2 (C-002)	Low response
Wave reductiongears*	1 (C-001) to 2 (C-002)	Low response

* Product name: Harmonic Drive

Select the machine rigidity level for DR2, SGDA and SGDB according to the table.

Level	Rigidity
7 (C-007)	High
6 (C-006)	:
5 (C-005)	:
4 (C-004)	:
3 (C-003)	Medium
2 (C-002)	:
1 (C-001)	Low

Auto-tuning may not end if high response is selected for a low-rigidity machine or low response is selected for a high-rigidity machine.

If this occurs, halt the auto-tuning and change the machine rigidity selection.

2) If Auto-tuning is Unsuccessful

Auto-tuning may be unsuccessful (the end of auto-tuning not displayed) for machines with large play or extremely low rigidity.

Similarly, auto-tuning may be unsuccessful for a machine with high load inertia (exceeding 15 to 30 times the motor moment of inertia).

In these cases, use conventional manual adjustment.

Even if auto-tuning is successful for a machine with large fluctuations in load inertia or load torque, vibrations or noise may still occur in some positions.

3) Response During Operation is Unsatisfactory after Auto-tuning

Auto-tuning sets the gain and integration time constant with some safety margin (to avoid oscillations). This can result in positioning times.

In particular, the target position may not be reached if low response is selected, because the machine does not move in response to the final minute references. An excessively high setting of the integration time constant (Cn-05) during auto-tuning is one cause of this problem.

If response is slow after auto-tuning, the speed loop gain cannot be manually increased very much before vibration starts.

In this case, manually reduce the integration time constant while observing the machine behavior to ensure oscillation does not occur.

Auto-tuning does not set the torque reference filter (Cn-17).

B.3.2 Manual Adjustment

1) The role of each user constant is briefly described below.

a) Speed Loop Gain (Cn-04)

This user constant sets the speed loop response.

The response is improved by setting this user constant to the maximum value in the range which does not cause vibrations in the mechanical system.

The following formula relates the speed loop gain to the load inertia.

$$\text{Speed Loop Gain } K_v \text{ [Hz]} = \frac{2}{\frac{GD_L^2}{GD_M^2} + 1} \times (\text{Cn-04 Preset value})$$

GD_L^2 : Motor Axis Converted Load Inertia

GD_M^2 : Motor Moment of Inertia

b) Speed Loop Integration Time Constant (Cn-05)

The speed loop has an integration element to allow response to micro-inputs.

This integration element can produce a delay in the servo system, and the positioning setting time increases and response becomes slower as the time constant increases. However, the integration time constant must be increased to prevent machine vibration if the load inertia is large or the mechanical system includes a vibration elements. The following formula calculates a guideline value.

$$T_i \geq 2.3 \times \frac{1}{2\pi \times K_v}$$

T_i: Integration Time Constant (sec)

K_v: Speed Loop Gain (Hz) (calculated above)

c) Torque Reference Filter Time Constant (Cn-17)

When a ball screw is used, torsional resonance may occur which increases the pitch of the vibration noise.

These vibrations can sometimes be overcome by increasing the torque reference filter time constant.

However, this filter can produce a delay in the servo system, as is the integration time constant, and its value should not be increased more than necessary.

d) Position Loop Gain

The position loop gain user constant sets the servo system response.

The higher the position loop gain is set, the better the response and shorter the positioning times.

To enable a high setting of the position loop gain, increase the machine rigidity and raise the machine characteristic frequency.

Increasing the position loop gain only to improve the response can result in oscillating response of the overall servo system, that is, the speed references output from the position loop oscillate. Therefore, also increase the speed loop gain while observing the response.

2) Adjustment Procedure

a) Set the position loop gain to a low value and increase the speed loop gain (Cn-04) within the range that no abnormal noise or oscillation occurs.

b) Slightly reduce the speed loop gain from the value at step 1, and increase the position loop gain in the range that no overshooting or vibration occurs.

c) Determine the speed loop integration time constant (Cn-05), by observing the positioning set time and vibrations in the mechanical system.

The positioning set time may become excessive if the speed loop integration time constant (Cn-05) is too large.

d) It is not necessary to change the torque reference time constant (Cn-17) unless torsional resonance occurs in the machine shafts.

Torsional resonance may be indicated by a high vibration noise. Adjust the torque reference filter time constant to reduce the vibration noise.

e) Finally, fine adjustment of the position gain, speed gain, and integration time constant is required to determine the optimum point for step response, etc.

3) Functions to Improve Response

The mode switch, feed-forward, and bias functions improve response.

However, they are not certain to improve response and may even worsen it in some cases. Follow the points outlined below and observe the actual response while making adjustments.

a) Mode Switch

The mode switch improves the transition characteristics when the torque references become saturated during acceleration or deceleration.

Above the set level, the speed loop control switches from PI (proportional/integral) control to P (proportional) control.

b) Feed-forward Function

Use feed-forward to improve the response speed. However, feed-forward may be ineffective in systems where a sufficiently high value of position loop gain is not possible.

Follow the procedure below to adjust the feed-forward amount (Cn-1D).

(1) Adjust the speed loop and position loop, as described above.

(2) Gradually increase the feed-forward amount (Cn-1D), such that the positioning complete (COIN) signal is output early.

At this point, ensure that the positioning complete (COIN) signal breaks up (alternately turns ON/OFF) and that the speed does not overshoot. These problems can arise if the feed-forward is set too high.

For all types of Servopack except DR1, a primary delay filter can be applied to feed-forward. This filter can be used to correct breakup (alternatingly turning ON/OFF) of the positioning complete (COIN) signal or speed overshoot arising when feed-forward is activated.

c) Bias Function

When the lag pulses in the error counter exceeds the positioning complete width (Cn-1B), the bias amount (Cn-1C) is added to the error counter output (speed reference). If the lag pulses in the error counter lies within the positioning complete width (Cn-1B), the bias amount (Cn-1C) is no longer added.

This reduces the number of pulses in the error counter and shortens the positioning time.

The motor speed becomes unstable if the bias amount is too large.

Observe the response during adjustment as the optimum value depends on the load, gain, and positioning complete width.

Set Cn-0C to zero (0) when the bias is not used.

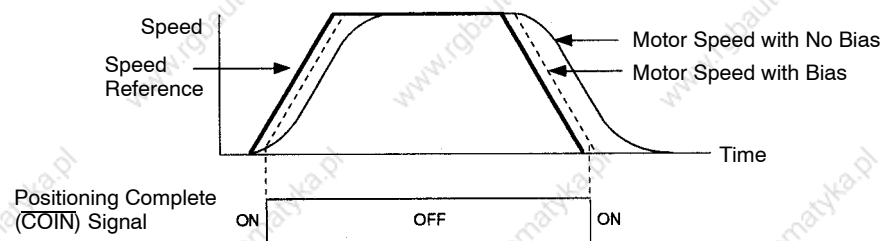
Bias Function

SERVO ADJUSTMENT

B.3.2 Manual Adjustment cont.

The adjustment procedures described above are common for all Yaskawa digital AC Servopacks. However, not all functions are available on each Servopack. Consult the technical specifications of your Servopack for details.

The adjustment procedures are also identical for conventional analog servos. However, in this case, the adjustments are made using potentiometers instead of the user constants.

B.4 Gain Setting References

This section presents tables of load inertia values for reference when adjusting the gain.

B.4.1 Guidelines for Gain Settings According to Load Inertia Ratio 441

B.4.1 Guidelines for Gain Settings According to Load Inertia Ratio

- 1) Adjustment guidelines are given below according to the rigidity of the mechanical system and load inertia. Use these values as guidelines when adjusting according to the procedures described above.

These values are given as guidelines only. Oscillations and poor response may occur inside the specified value ranges. Observe the response (waveform) when optimizing the adjustment.

Higher gains are possible for machines with high rigidity.

- a) Machines with High Rigidity

Ball Screw, Direct Drive Machines

Example: Chip moulder, IC bonder, precision machine tools

Load/Inertia Ratio (GD_L^2/GD_M^2)	Position Loop Gain (Cn-1A) [1/s]	Speed Loop Gain (Cn-04) [Hz]	Speed Loop Integration Time Constant (Cn-05) [0.01ms]
1 x	50 to 70	50 to 70	500 to 2000 Slightly increase for inertia ratio of 20 x, or greater.
3 x		100 to 140	
5 x		150 to 200	
10 x		270 to 380	
15 x		400 to 560	
20 x		500 to 730	
30 x		700 to 1100	

For an inertia ratio of 10 x, or greater, slightly reduce the position loop gain and speed loop gain below the values shown and set the integration time constant to a higher value before starting the adjustment.

As the inertia ratio increases, set the position loop gain and speed loop gain to the lower limit of the range of values specified. Conversely, increase the speed loop integration time constant.

- b) Machines with Medium Rigidity

Machines driven by ball screw through reduction gears, or machines directly driven by long ball screws.

Example: General machine tools, orthogonal robots, conveyors

SERVO ADJUSTMENT

B.4.1 Guidelines for Gain Settings According to Load Inertia Ratio cont.

Load/Inertia Ratio (GD_L^2/GD_M^2)	Position Loop Gain (Cn-1A) [1/s]	Speed Loop Gain (Cn-04) [Hz]	Speed Loop Integration Time Constant (Cn-05) [0.01ms]
1 x	30 to 50	30 to 50	1000 to 4000 Slightly increase for inertia ratio of 20 x, or greater.
3 x		60 to 100	
5 x		90 to 150	
10 x		160 to 270	
15 x		240 to 400	
20 x		310 to 520	
30 x		450 to 770	

For an inertia ratio of 10 x, or greater, slightly reduce the position loop gain and speed loop gain below the values shown and set the integration time constant to a higher value before starting the adjustment.

As the inertia ratio increases, set the position loop gain and speed loop gain to the lower limit of the range of values specified. Conversely, increase the speed loop integration time constant.

c) Machines with Low Rigidity

Machines driven by timing belts, chains or wave reduction gears (product name: Harmonic Drive).

Example: Conveyors, articulated robots

Load/Inertia Ratio (GD_L^2/GD_M^2)	Position Loop Gain (Cn-1A) [1/s]	Speed Loop Gain (Cn-04) [Hz]	Speed Loop Integration Time Constant (Cn-05) [0.01ms]
1 x	10 to 20	10 to 20	5000 to 10000 Slightly increase for inertia ratio of 20 x, or greater.
3 x		20 to 40	
5 x		30 to 60	
10 x		50 to 110	
15 x		80 to 160	
20 x		100 to 210	
30 x		150 to 310	

For an inertia ratio of 10 x, or greater, slightly reduce the position loop gain and speed loop gain below the values shown and set the integration time constant to a higher value before starting the adjustment.

As the inertia ratio increases, set the position loop gain and speed loop gain to the lower limit of the range of values specified. Conversely, increase the speed loop integration time constant.

- 2) When a speed-control Servopack is used, set the position loop gain at the host controller. If the position loop gain cannot be set at the host controller, adjust the Servopack speed reference gain (Cn-03). The position loop gain (Cn-1A) of a speed-control Servopack is valid in zero-clamp mode only. The position loop gain is determined from the following relationship.

$$K_p = \frac{VS}{\epsilon}$$

K_p [1/s]: Position loop gain

VS [PPS]: Steady speed reference

ϵ : (pulse): Steady error

(The number of pulses in the error counter at steady speed.)

Appendix C

List of I/O Signals

This appendix lists I/O signal terminals (connector 1CN) on Servopacks which connect to a host controller or external circuit.

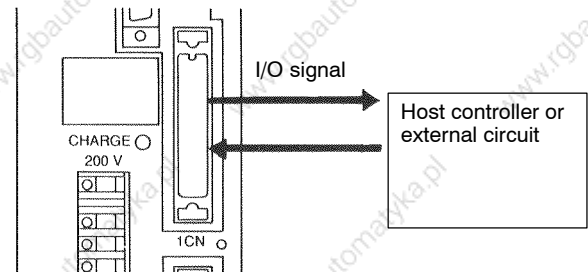

- Note**
- 1) The meanings of some signals for speed/torque control and position control are different. Always refer to the correct list for the Servopack type.
 - 2) Refer to *Chapter 3* for details of how to use I/O signals.
 - 3) Note that the functions of I/O signal terminals differ according to the memory switch (Cn-01, Cn-02) settings.

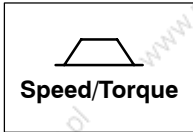

List of Input Signals in Speed/Torque Mode (1)
(1CN Terminal No.)

Specifications	Standard Specifications	Absolute Encoder	Speed Coincide Output	Zero-clamp	Speed Control with Torque Feed Forward	Torque Control I
Memory Switch Setting	Standard Setting (Cn-02 BitB = 0)	Cn-01 Bit 9 = 1	Cn-01 Bit 4 = 1	Cn-01 Bit A = 1 Bit B = 0	Cn-01 Bit F = 1	Cn-01 Bit A = 0 Bit B = 1
1	SG GND					
2	SG GND					
3	– (Unused)					
4	– (Unused)	SEN Sensor ON 3.8.5				
5	V-REF Speed reference input 3.2.1				V-REF Speed reference 3.2.8	– (Unused) 3.2.7
6	SG GND				SG GND 3.2.8	SG GND 3.2.7
7	– (Unused)					
8	– (Unused)					
9	T-REF Torque reference input 3.2.7				T-REF Torque feed forward reference 3.2.8	T-REF Torque reference 3.2.7
10	SG GND				SG GND 3.2.8	SG GND 3.2.7
11	– (Unused)					
12	– (Unused)					
13	– (Unused)					
14	– (Unused)					
15	– (Unused)					
16	TRQ-M Torque monitor 3.2.12					
17	VTG-M Speed monitor 3.2.12					

Specifications	Standard Specifications		Absolute Encoder	Speed Coincide Output	Zero-clamp	Speed Control with Torque Feed Forward	Torque Control I
Memory Switch Setting	Standard Setting (Cn-02 BitB = 0)		Cn-01 Bit 9 = 1	Cn-01 Bit 4 = 1	Cn-01 Bit A = 1 Bit B = 0	Cn-01 Bit F = 1	Cn-01 Bit A = 0 Bit B = 1
18	– (Unused)						
19	PCO	PG signal output phase-C 3.2.3					
20	*PCO						
21	– (Unused)		BAT+ Backup battery +input 3.8.5				
22	– (Unused)		BAT- Backup battery -input 3.8.5				
23	+15V	Power for speed/ torque reference 3.2.1					
24	-15V						
25	CLT+	Torque limit detection output 3.1.3		CLT+ Speed coincide output 3.7.4			
26	CLT-			CLT- Speed coincide output 3.7.4			
27	TGON+	TGON output signal 3.7.5					
28	TGON-						
29	S-RDY+	Servo ready output 3.7.6					
30	S-RDY-						
31	ALM+	Servo alarm output 3.7.1					
32	ALM-						



LIST OF I/O SIGNALS

Specifications	Standard Specifications		Absolute Encoder	Speed Coincide Output	Zero-clamp	Speed Control with Torque Feed Forward	Torque Control I	
Memory Switch Setting	Standard Setting (Cn-02 BitB = 0)		Cn-01 Bit 9 = 1	Cn-01 Bit 4 = 1	Cn-01 Bit A = 1 Bit B = 0	Cn-01 Bit F = 1	Cn-01 Bit A = 0 Bit B = 1	
33	PAO	PG signal output phase-A						
34	*PAO	3.2.3						
35	PBO	PG signal output phase-B						
36	*PBO	3.2.3						
37	ALO1 Alarm code output (Open collector) 3.7.1							
38	ALO2 Alarm code output (Open collector) 3.7.1							
39	ALO3 Alarm code output (Open collector) 3.7.1							
40	S-ON Servo ON input 3.7.2							
41	P-CON P control input 3.6.4							P-CON Zero-clamp operation reference 3.4.3
42	P-OT Forward rotation prohibited 3.1.2							
43	N-OT Reverse rotation prohibited 3.1.2							
44	ALM-RST Alarm reset input 3.7.1							
45	P-CL Forward torque limit ON input 3.1.3							

Specifications	Standard Specifications	Absolute Encoder	Speed Coincide Output	Zero-clamp	Speed Control with Torque Feed Forward	Torque Control I
Memory Switch Setting	Standard Setting (Cn-02 BitB = 0)	Cn-01 Bit 9 = 1	Cn-01 Bit 4 = 1	Cn-01 Bit A = 1 Bit B = 0	Cn-01 Bit F = 1	Cn-01 Bit A = 0 Bit B = 1
46	N-CL Reverse torque limit ON input 3.1.3					
47	+24VIN I/O power supply 3.2.4					
48	- (Unused)	PSO Phase-S signal output 3.8.5				
49	- (Unused)	*PSO Phase-S signal output 3.8.5				
50	FG Frame ground 3.2.3					

Note Information described in the “Standard Specifications” column is also applicable to blank columns.
Number “**x.x.x**” represents a section number corresponding to each signal name. For example, **3.2.3** represents Section 3.2.3.

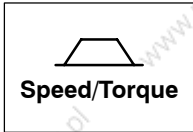

List of Input Signals in Speed/Torque Mode (2)
(1CN Terminal No.)

Specifications	Standard Specifications	Brake Interlock Output	Contact Input Speed Control		Speed Control with Torque Limit by Analog Voltage Reference		
Memory Switch Setting	Standard Setting (Cn-02 bitB = 0)	Cn-01 Bit E	Cn-02 Bit 2 = 1		Cn-02 Bit F = 1		
			Cn-01 Bit B = 0	Cn-01 Bit B = 1			
1	SG GND						
2	SG GND						
3	- (Unused)						
4	- (Unused)						
5	V-REF Speed reference input 3.2.1		(Unused) 3.2.6	V-REF Speed reference 3.2.6	V-REF Speed reference 3.2.9		
6	SG GND		SG GND 3.2.6	SG GND 3.2.6	SG GND 3.2.9		
7	- (Unused)						
8	- (Unused)						
9	T-REF Torque reference input 3.2.7						T-REF Torque limit input 3.2.9
10	SG GND						SG GND 3.2.9
11	- (Unused)						
12	- (Unused)						
13	- (Unused)						
14	- (Unused)						
15	- (Unused)						

Specifications	Standard Specifications		Brake Interlock Output	Contact Input Speed Control		Speed Control with Torque Limit by Analog Voltage Reference	
Memory Switch Setting	Standard Setting (Cn-02 bitB = 0)		Cn-01 Bit E	Cn-02 Bit 2 = 1		Cn-02 Bit F = 1	
				Cn-01 Bit B = 0	Cn-01 Bit B = 1		
16	TRQ-M Torque monitor 3.2.12						
17	VTG-M Speed monitor 3.2.12						
18	– (Unused)						
19	PCO	PG signal output phase-C 3.2.3					
20	*PCO						
21	– (Unused)						
22	– (Unused)						
23	+15V	Power for speed/torque reference 3.2.1					
24	-15V						
25	CLT+	Torque limit detection output 3.1.3					
26	CLT-						
27	TGON+	TGON output signal					TGON+ Brake interlock signal 3.4.4
28	TGON-	3.7.5					TGON+ Brake interlock signal 3.4.4
29	S-RDY+	Servo ready output 3.7.6					
30	S-RDY-						
31	ALM+	Servo alarm output 3.7.1					
32	ALM-						
33	PAO	PG signal output phase-A 3.2.3					
34	*PAO						



LIST OF I/O SIGNALS

Specifications	Standard Specifications		Brake Interlock Output	Contact Input Speed Control		Speed Control with Torque Limit by Analog Voltage Reference
	Memory Switch Setting	Standard Setting (Cn-02 bitB = 0)		Cn-01 Bit E	Cn-02 Bit 2 = 1	
Cn-01 Bit B = 0			Cn-01 Bit B = 1		Cn-02 Bit F = 1	
35	PBO	PG signal output phase-B 3.2.3				
36	*PBO					
37	ALO1 Alarm code output (Open collector) 3.7.1					
38	ALO2 Alarm code output (Open collector) 3.7.1					
39	ALO3 Alarm code output (Open collector) 3.7.1					
40	S-ON Servo on input 3.7.2					
41	P-CON P control input 3.6.4					
42	P-OT Forward rotation prohibited 3.1.2					
43	N-OT Reverse rotation prohibited 3.1.2					
44	ALM-RST Alarm reset input 3.7.1					
45	P-CL Forward torque limit ON input 3.1.3	P-CL Contact input speed control 1 3.2.6				
46	N-CL Reverse torque limit ON input 3.1.3	N-CL Contact input speed control 2 3.2.6				
47	+24VIN I/O power supply 3.2.4					
48	- (Unused)					
49	- (Unused)					



Specifications	Standard Specifications	Brake Interlock Output	Contact Input Speed Control		Speed Control with Torque Limit by Analog Voltage Reference
Memory Switch Setting	Standard Setting (Cn-02 bitB = 0)	Cn-01 Bit E	Cn-02 Bit 2 = 1		Cn-02 Bit F = 1
			Cn-01 Bit B = 0	Cn-01 Bit B = 1	
50	FG Frame ground 3.2.3				

Note Information described in the “Standard Specifications” column is also applicable to blank columns.
 Number “**x.x.x**” represents a section number corresponding to each signal name. For example, **3.2.3** represents Section 3.2.3.

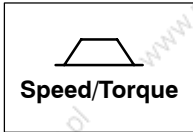

List of Input Signals in Speed/Torque Mode (3)
(1CN Terminal No.)

Specifications	Standard Specifications	Torque Control II			
		Cn-01 Bit A = 1, B = 1			
		P-CON = OFF	P-CON = ON		
Memory Switch Setting	Standard Setting (Cn-02 bitB = 0)	-	Cn-01 Bit F = 0 Cn-02 Bit F = 0	Cn-01 Bit F = 0 Cn-02 Bit F = 1	Cn-01 Bit F = 1 Cn-02 Bit F = 1 or 0
1	SG GND				
2	SG GND				
3	- (Unused)				
4	- (Unused)				
5	V-REF Speed reference input 3.2.1	V-REF Speed limit value 3.2.7	V-REF Speed reference 3.2.7	V-REF Speed reference 3.2.7	V-REF Speed reference 3.2.7
6	SG GND	SG GND 3.2.7	SG GND 3.2.7	SG GND 3.2.7	SG GND 3.2.7
7	- (Unused)				
8	- (Unused)				
9	T-REF Torque reference input 3.2.7	T-REF Torque reference 3.2.7	- (Unused) 3.2.7	T-REF Torque limit value 3.2.7	T-REF Torque feed forward reference 3.2.7
10	SG GND	SG GND 3.2.7	SG GND 3.2.7	SG GND 3.2.7	SG GND 3.2.7
11	- (Unused)				
12	- (Unused)				
13	- (Unused)				
14	- (Unused)				
15	- (Unused)				
16	TRQ-M Torque monitor 3.2.12				

Specifications	Standard Specifications		Torque Control II			
	Standard Setting (Cn-02 bitB = 0)		Cn-01 Bit A = 1, B = 1			
			P-CON = OFF	P-CON = ON		
Memory Switch Setting			-	Cn-01 Bit F = 0 Cn-02 Bit F = 0	Cn-01 Bit F = 0 Cn-02 Bit F = 1	Cn-01 Bit F = 1 Cn-02 Bit F = 1 or 0
17	VTG-M Speed monitor 3.2.12					
18	- (Unused)					
19	PCO	PG signal output phase-C 3.2.3				
20	*PCO					
21	- (Unused)					
22	- (Unused)					
23	+15V	Power for speed/ torque reference 3.2.1				
24	-15V					
25	CLT+	Torque limit detection output 3.1.3				
26	CLT-					
27	TGON+	TGON output signal 3.7.5				
28	TGON-					
29	S-RDY+	Servo ready output 3.7.6				
30	S-RDY-					
31	ALM+	Servo alarm output 3.7.1				
32	ALM-					
33	PAO	PG signal output phase-A 3.2.3				
34	*PAO					
35	PBO	PG signal output phase-B 3.2.3				
36	*PBO					
37	ALO1 Alarm code output (Open collector) 3.7.1					

LIST OF I/O SIGNALS

Specifications	Standard Specifications	Torque Control II			
		Cn-01 Bit A = 1, B = 1			
		P-CON = OFF	P-CON = ON		
Memory Switch Setting	Standard Setting (Cn-02 bitB = 0)	-	Cn-01 Bit F = 0 Cn-02 Bit F = 0	Cn-01 Bit F = 0 Cn-02 Bit F = 1	Cn-01 Bit F = 1 Cn-02 Bit F = 1 or 0
38	ALO2 Alarm code output (Open collector) 3.7.1				
39	ALO3 Alarm code output (Open collector) 3.7.1				
40	S-ON Servo on input 3.7.2				
41	P-CON P control input 3.6.4	P-CON Torque/speed control switch 3.2.7	P-CON Torque/speed control switch 3.2.7	P-CON Torque/speed control switch 3.2.7	P-CON Torque/speed control switch 3.2.7
42	P-OT Forward rotation prohibited 3.1.2				
43	N-OT Reverse rotation prohibited 3.1.2				
44	ALM-RST Alarm reset input 3.7.1				
45	P-CL Forward torque limit ON input 3.1.3				
46	N-CL Reverse torque limit ON input 3.1.3				
47	+24VIN I/O power supply 3.2.4				
48	- (Unused)				
49	- (Unused)				
50	FG Frame ground 3.2.3				

Note Information described in the “Standard Specifications” column is also applicable to blank columns.
Number “x.x.x” in box represents a section number corresponding to each signal name. For example, **3.2.3** represents Section 3.2.3.



**List of I/O Signals IN Position Control Mode (1)
(1CN Terminal No.)**

Specifications	Standard Specifications		Absolute Encoder	Brake Interlock Output	INHIBIT Input	Contact Input Speed Control	
Memory Switch Setting	Standard Setting (Cn-02 Bit B = 1)		Cn-02 Bit 9 = 1	Cn-01 Bit E = 1	Cn-01 Bit F = 1 Cn-02 Bit 2 = 0	Cn-01 Bit F = 0 Cn-02 Bit 2 = 1	Cn-01 Bit F = 1 Cn-02 Bit 2 = 1
1	SG GND						
2	SG GND						
3	PL1 Power for open collector reference 3.2.2						
4	– (Unused)		SEN Sensor ON signal 3.8.5				
5	– (Unused)						
6	SG GND						
7	PULS	Reference pulse input 3.2.2				– (Unused) 3.2.6	PULS Reference pulse input 3.2.2
8	*PULS					– (Unused) 3.2.6	*PULS Reference pulse input 3.2.2
9	– (Unused)						
10	SG GND						
11	SIGN	Reference sign input 3.2.2				– (Unused) 3.2.6	PULS Reference pulse input 3.2.2
12	*SIGN					– (Unused) 3.2.6	*PULS Reference pulse input 3.2.2
13	PL2 Power for open collector reference 3.2.2						



LIST OF I/O SIGNALS

Specifications	Standard Specifications		Absolute Encoder	Brake Interlock Output	INHIBIT Input	Contact Input Speed Control	
	Memory Switch Setting	Standard Setting (Cn-02 Bit B = 1)				Cn-02 Bit 9 = 1	Cn-01 Bit E = 1
14	*CLR	Clear input 3.2.2				- (Unused)	CLR Clear input 3.2.2
15	CLR					- (Unused)	*CLR Clear input 3.2.2
16	TRQ-M Torque monitor	3.2.12					
17	VTG-M Speed monitor	3.2.12					
18	PL3 Power for open collector reference	3.2.2					
19	PCO	PG signal output phase-C 3.2.3					
20	*PCO						
21	- (Unused)	BAT+ Backup battery + input 3.8.5					
22	- (Unused)	BAT- Backup battery - input 3.8.5					
23	- (Unused)						
24	- (Unused)						
25	COIN+	Positioning complete signal 3.7.3					
26	COIN-						
27	TGON+	3.7.5	TGON+ Brake interlock signal 3.4.4				
28	TGON-		TGON- Brake interlock signal 3.4.4				



Specifications	Standard Specifications		Absolute Encoder	Brake Interlock Output	INHIBIT Input	Contact Input Speed Control				
Memory Switch Setting	Standard Setting (Cn-02 Bit B = 1)		Cn-02 Bit 9 = 1	Cn-01 Bit E = 1	Cn-01 Bit F = 1 Cn-02 Bit 2 = 0	Cn-01 Bit F = 0 Cn-02 Bit 2 = 1	Cn-01 Bit F = 1 Cn-02 Bit 2 = 1			
29	S-RDY+	Servo ready output 3.7.6								
30	S-RDY-									
31	ALM+	Servo alarm output 3.7.1								
32	ALM-									
33	PAO	PG signal output phase-A 3.2.3								
34	*PAO									
35	PBO	PG signal output phase-B 3.2.3								
36	*PBO									
37	ALO1	Alarm code output (Open collector) 3.7.1								
38	ALO2									
39	ALO3									
40	S-ON Servo ON input	3.7.2								
41	P-CON P control input	3.6.4						P-CON INHIBIT input 3.2.10	P-CON Rotation direction reference at contact input speed control 3.2.6	P-CON Rotation direction reference at contact input speed control 3.2.6
42	P-OT Forward rotation prohibited	3.1.2								
43	N-OT Reverse rotation prohibited	3.1.2								
44	ALM-RST Alarm reset input	3.7.1								
45	P-CL Forward torque limit ON input	3.1.3			P-CL Contact input speed control 1 3.2.6	P-CL Contact input speed control 1 3.2.6				



LIST OF I/O SIGNALS

Specifications	Standard Specifications	Absolute Encoder	Brake Interlock Output	INHIBIT Input	Contact Input Speed Control	
					Cn-01 Bit F = 0 Cn-02 Bit 2 = 1	Cn-01 Bit F = 1 Cn-02 Bit 2 = 1
Memory Switch Setting	Standard Setting (Cn-02 Bit B = 1)	Cn-02 Bit 9 = 1	Cn-01 Bit E = 1	Cn-01 Bit F = 1 Cn-02 Bit 2 = 0	Cn-01 Bit F = 0 Cn-02 Bit 2 = 1	Cn-01 Bit F = 1 Cn-02 Bit 2 = 1
46	N-CL Reverse torque limit ON input 3.1.3				N-CL Contact input speed control 2 3.2.6	N-CL Contact input speed control 2 3.2.6
47	+24VfIN I/O power supply 3.2.4					
48	- (Unused)	PSO Phase-S signal output 3.8.5				
49	- (Unused)	*PSO Phase-S signal output 3.8.5				
50	FG Frame ground 3.2.3					

Note Information described in the “Standard Specifications” column is also applicable to blank columns.

Number “x.x.x” represents a section number corresponding to each signal name. For example, **3.2.3** represents Section 3.2.3.



List of I/O Signals IN Position Control Mode (2)
(1CN Terminal No.)

Specifications	Standard Specifications		CCW Pulse + CW Pulse	90° Dirrerence Two-phase Pulse Reference
Memory Switch Setting	Standard Setting (Cn-02 Bit B = 1)		Cn-02 Bit 5, 4, 3 = 0, 0, 1	Cn-02 Bit 5, 4, 3 = 0, 1, 0 (× 1 multiplication) = 0, 1, 1 (× 2 multiplication) = 1, 0, 0 (× 4 multiplication)
1	SG GND			
2	SG GND			
3	PL1 Power for open collector reference			
4	– (Unused)			
5	– (Unused)			
6	SG GND			
7	PULS	Reference pulse input	PULS Forward reference pulse input (CCW) 3.2.2	PULS Phase-A reference pulse input 3.2.2
8	*PULS	3.2.2	*PULS Forward reference pulse input (CCW) 3.2.2	*PULS Phase-A reference pulse input 3.2.2
9	– (Unused)			
10	SG GND			
11	SIGN	Reference sign input	SIGN Reverse reference pulse input (CW) 3.2.2	SIGN Phase-B reference pulse input 3.2.2
12	*SIGN	3.2.2	*SIGN Reverse reference pulse input (CW) 3.2.2	*SIGN Phase-B reference pulse input 3.2.2
13	PL2 Power for open collector reference			
		3.2.2		
14	*CLR	Clear input		
15	CLR	3.2.2		



LIST OF I/O SIGNALS

Specifications	Standard Specifications		CCW Pulse + CW Pulse	90° Dirrerence Two-phase Pulse Reference
Memory Switch Setting	Standard Setting (Cn-02 Bit B = 1)		Cn-02 Bit 5, 4, 3 = 0, 0, 1	Cn-02 Bit 5, 4, 3 = 0, 1, 0 (× 1 multiplication) = 0, 1, 1 (× 2 multiplication) = 1, 0, 0 (× 4 multiplication)
16	TRQ-M Torque monitor	3.2.12		
17	VTG-M Speed monitor	3.2.12		
18	PL3 Power for open collector reference	3.2.2		
19	PCO	PG signal output phase-C 3.2.3		
20	*PCO			
21	- (Unused)			
22	- (Unused)			
23	- (Unused)			
24	- (Unused)			
25	COIN+	Positioning complete signal 3.7.3		
26	COIN-			
27	TGON+	TGON output signal 3.7.5		
28	TGON-			
29	S-RDY+	Servo ready output 3.7.6		
30	S-RDY-			
31	ALM+	Servo alarm output 3.7.1		
32	ALM-			
33	PAO	PG signal output phase-A 3.2.3		
34	*PAO			
35	PBO	PG signal output phase-B 3.2.3		
36	*PBO			
37	ALO1	Alarm code output (Open collector) 3.7.1		
38	ALO2			
39	ALO3			
40	S-ON Servo ON input	3.7.2		
41	P-CON P control input	3.6.4		



Specifications	Standard Specifications	CCW Pulse + CW Pulse	90° Dirrence Two-phase Pulse Reference
Memory Switch Setting	Standard Setting (Cn-02 Bit B = 1)	Cn-02 Bit 5, 4, 3 = 0, 0, 1	Cn-02 Bit 5, 4, 3 = 0, 1, 0 (× 1 multiplication) = 0, 1, 1 (× 2 multiplication) = 1, 0, 0 (× 4 multiplication)
42	P-OT Forward rotation prohibited 3.1.2		
43	N-OT Reverse rotation prohibited 3.1.2		
44	ALM-RST Alarm reset input 3.7.1		
45	P-CL Forward torque limit ON input 3.1.3		
46	N-CL Reverse torque limit ON input 3.1.3		
47	+24VIN I/O power supply 3.2.4		
48	– (Unused)		
49	– (Unused)		
50	FG Frame ground 3.2.3		

Note Information described in the “Standard Specifications” column is also applicable to blank columns.

Number “**x.x.x**” represents a section number corresponding to each signal name. For example, **3.2.3** represents Section 3.2.3.



Appendix D

List of User Constants

- Σ -Series Servopacks provide many functions, and have parameters called “user constants” to allow the user to select each function and perform fine adjustment. This appendix lists these user constants.
- User constants are divided into the following two types:

1) Memory switch Cn-01, Cn-02	Each bit of this switch is turned ON or OFF to select a function.
2) User constant setting Cn-03 and later	A numerical value such as a torque limit value or speed loop gain is set in this constant.

D

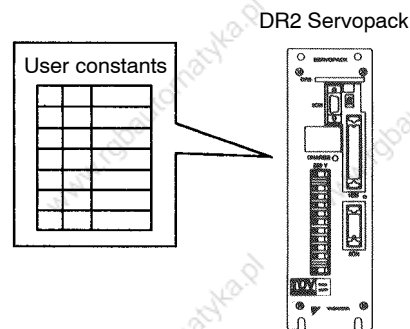

- Note**
- 1) Some user constants for speed/torque control and position control are different. Always refer to the correct list of user constants for the Servopack type.
 - 2) Refer to *Chapter 3* for details of how to use user constants.
 - 3) For details of how to set user constants, refer to *Section 4.1.5 Operation in User Constant Setting Mode*.



For Speed/Torque Control

List of User Constants (User Constant Setting)

Category	User Constant No.	Code	Name	Unit	Lower Limit	Upper Limit	Factory Setting	Remarks	
	Cn-00	Not a user constant. (Cn-00 is used to select special mode for digital operator.)							
	Cn-01	Memory switch (see on page 468.)							See note 1
	Cn-02	Memory switch (see on page 469.)							See note 1
Gain Related Constants	Cn-03	VREFGN	Speed reference gain	(r/min)/V	10	2162	500	See 3.2.1, 3.2.7.	
	Cn-04	LOOPHZ	Speed loop gain	Hz	1	2000	80	See note 2 See 3.5.2, 3.6.1, 3.6.2.	
	Cn-05	PITIME	Speed loop integration time constant	0.01ms	2	10000	2000	See note 2 See 3.5.2, 3.6.1, 3.6.2.	
	Cn-1A	POSGN	Position loop gain	1/s	1	500	40	See note 2 and 3 See 3.5.2, 3.6.1, 3.6.2.	
Torque Related Constants	Cn-13	TCRFGN	Torque reference gain	(0.1 V/rated torque)	10	100	30	See 3.2.7, 3.2.8, 3.2.9.	
	Cn-06	EMGTRQ	Emergency stop torque	%	0	Max. torque	Max. torque	See 3.1.2.	
	Cn-08	TLMTF	Forward rotation torque limit	%	0	Max. torque	Max. torque	See 3.1.3.	
	Cn-09	TLMTR	Reverse rotation torque limit	%	0	Max. torque	Max. torque	See 3.1.3.	
	Cn-14	TCRLMT	Speed limit for torque control I	r/min	0	4500	4500	See 3.2.7.	
	Cn-17	TRQFIL	Torque reference filter time constant	100 μs	0	250	4	See 3.5.5.	
	Cn-18	CLMIF	Forward external torque limit	%	0	Max. torque	100	See 3.1.3.	
	Cn-19	CLMIR	Reverse external torque limit	%	0	Max. torque	100	See 3.1.3.	
Sequence Related Constants	Cn-07	SFSACC	Soft start time (acceleration)	ms	0	10000	0	See note 4 See 3.2.6, 3.5.1.	
	Cn-23	SFSDEC	Soft start time (deceleration)	ms	0	10000	0	See note 4 See 3.2.6, 3.5.1.	
	Cn-0B	TGONLV	Zero-speed level	r/min	1	4500	20	See 3.7.5.	
	Cn-12	BRKTIM	Time delay from brake reference until servo OFF	10 ms	0	50	0	See 3.4.4.	
	Cn-15	BRKSPD	Speed level for brake reference output during motor operation	r/min	0	4500	100	See 3.4.4.	

Category	User Constant No.	Code	Name	Unit	Lower Limit	Upper Limit	Factory Setting	Remarks
Sequence Related Constants	Cn-16	BRKWAI	Output timing of brake reference during motor operation	10 ms	10	100	50	See 3.4.4.
	Cn-22	VCMLV	Speed coincidence signal output range	r/min	0	100	10	See 3.7.4.
	Cn-29	ZCLVL	Zero-clamp level	r/min	0	4500	10	See 3.4.3.
Pulse Related Constants	Cn-0A	PGRAT	Dividing ratio setting	P/R	16	32768	2048	See note 1 See 3.2.3.
	Cn-11	PULSNO	Number of encoder pulses	P/R	513	32768	2048	See note 1 See 3.3.3, 3.8.5.
Other Constants	Cn-0C	TRQMSW	Mode switch (torque reference)	%	0	800	200	See 3.6.6.
	Cn-0D	REFMSW	Mode switch (speed reference)	r/min	0	4500	0	See 3.6.6.
	Cn-0E	ACCMSW	Mode switch (acceleration reference)	10 (r/min)/s	0	3000	0	See 3.6.6.
	Cn-10	JOGSPD	Jog speed	r/min	0	4500	500	See 3.3.2.
	Cn-1F	SPEED1	1st speed (contact input speed control)	r/min	0	4500	100	See 3.2.6.
	Cn-20	SPEED2	2nd speed (contact input speed control)	r/min	0	4500	200	See 3.2.6.
	Cn-21	SPEED3	3rd speed (contact input speed control)	r/min	0	4500	300	See 3.2.6.
	Cn-28	NFBCC	Speed loop compensation constant	---	0	100	0	

: User constants that must be always set

- Note**
- 1) After changing the setting, always turn the power OFF, then ON. This makes the new setting valid.
 - 2) Automatically set by autotuning function
 - 3) Valid only when zero-clamp function is used
 - 4) To use soft start function, always set both Cn-07 and Cn-23.

LIST OF USER CONSTANTS

List of User Constants (Memory Switch Setting)

	User Constant No.	Bit No.	Setting		Factory Setting
Input signal enable/disable	Cn-01	0	0	1	0
			Uses servo ON input (S-ON).	Does not use servo ON input (S-ON). Servo is always ON.	
		1	0	1	0
			Uses SEN signal input (SEN) when absolute encoder is used.	Does not use SEN signal input (SEN) when absolute encoder is used. Servopack automatically treats signal voltage as high level.	
		2	0	1	0
Uses forward rotation prohibited input (P-OT).	Does not use forward rotation prohibited input (P-OT). Forward rotation is always possible.				
3	0	1	0		
	Uses reverse rotation prohibited input (N-OT).	Does not use reverse rotation prohibited input (N-OT). Reverse rotation is always possible.			
CLT signal switching	4	0	1	0	
		Uses CLT signal (CLT) as torque limit detection output.	Uses CLT signal (CLT) as speed coincide output.		
–	5	Not used.	Not used	0	
Sequence selection at alarm condition	6	0	1	0	
		Stops the motor by applying dynamic brake when an alarm arises.	Causes the motor to coast to a stop when an alarm arises.		
		7	0	1	1
		When an alarm arises, stops the motor by applying dynamic brake and then releases dynamic brake.	When an alarm arises, stops the motor by applying dynamic brake but does not release dynamic brake.		
		8	0	1	0
Stops the motor according to bit 6 setting when overtravel is detected (P-OT, N-OT).	Decelerates the motor to a stop by applying the torque specified in Cn-06 when overtravel is detected (P-OT, N-OT).				
9	0	1	0		
	When overtravel is detected (P-OT, N-OT), decelerates the motor to a stop by applying the torque specified in Cn-06 and then turns the servo OFF.	When overtravel is detected (P-OT, N-OT), decelerates the motor to a stop by applying the torque specified in Cn-06 and then performs zero-clamp.			
Control mode selection	B•A	0•0	0•1	1•0	0•0
		Speed control	Speed control with zero-clamp function	Torque control I	

	User Constant No.	Bit No.	Setting				Factory Setting
			0•0	0•1	1•0	1•1	
Mode switch selection	Cn-01	D•C	0•0	0•1	1•0	1•1	0•0
			Uses internal torque reference as a condition. (Level setting: Cn-0C)	Uses speed reference as a condition. (Level setting: Cn-0D)	Uses acceleration as a condition. (Level setting: Cn-0E)	Does not use mode switch function.	
TGON signal function switch		E	0	1	0		
			Uses TGON signal as the motor running detection signal.	Uses TGON signal as the brake interlock signal.			
Torque feed-forward function	F	0	1	0			
		Does not use torque feed-forward function.	Uses torque feed-forward function.				
Rotation direction selection	Cn-02	0	0	1	0		
			Defines counterclockwise (CCW) rotation as forward rotation.	Defines clockwise (CW) rotation as forward rotation (reverse rotation mode).			
Home position error processing selection		1	0	1	0		
			Detects home position error (when absolute encoder is used).	Does not detect home position error.			
Contact input speed control		2	0	1	0		
			Does not use contact input speed control.	Uses contact input speed control.			
Reserved		3•4 5	Reserved (not to be set)				0
Reserved			6	0	1	0	
		Uses 1CN #16 pin as the torque reference monitor.		Uses 1CN #16 pin as the speed reference monitor.			
Reserved		7	Reserved (not to be set)				0
Motor selection		8	0	1	*		
			SGM motor	SGMP motor			
Encoder selection	9	0	1	0			
		Incremental encoder	Absolute encoder	0			
Reserved	A	Reserved (not to be set)				0	
Selection of speed/torque or position control mode	B	0	1	0			
		Speed/torque control mode selection	Not used.				
Torque reference filter type	C	0	1	0			
		Primary	Secondary				

* The factory setting depends on the Servopack type as shown below.

Servopack Type	Factory Setting
DR2-□	0
DR2-□P	1

D

LIST OF USER CONSTANTS

	User Constant No.	Bit No.	Setting		Factory Setting
Reserved	Cn-02	E•D	Reserved (not to be set)		0
Torque reference input selection		F	0	1	0
			Uses torque reference or torque feed-forward reference.	Uses analog voltage reference as torque limit input.	

NOTE For the Cn-01 and Cn-02 memory switches, always turn the power OFF and then ON after changing the setting. This makes the new setting valid.

D



For Position Control

List of User Constants (User Constant Setting)

Category	User Constant No.	Code	Name	Unit	Lower Limit	Upper Limit	Factory Setting	Remarks
	Cn-00	Not a user constant. (Cn-00 is used to select special mode for digital operator.)						See 4.1.3.
	Cn-01	Memory switch (see on page 474.)						See note 1
	Cn-02	Memory switch (see on page 476.)						See note 1
Gain Related Constants	Cn-04	LOOPHS	Speed loop gain	Hz	1	2000	80	See note 2 See 3.6.1, 3.6.2.
	Cn-05	PITIME	Speed loop integration time constant	0.01ms	2	10000	2000	See note 2 See 3.6.1, 3.6.2.
	Cn-1A	POSGN	Position loop gain	1/s	1	500	40	See note 2 See 3.6.1, 3.6.2.
	Cn-1C	BIASLV	Bias	r/min	0	450	0	See 3.6.5.
	Cn-1D	FFGN	Feed-forward	%	0	100	0	See 3.6.3.
	Cn-26	ACCTME	Position reference acceleration/deceleration time constant	100 μ s	0	640	0	See 3.5.2.
	Cn-27	FFFILT	Feed-forward reference filter	100 μ s	0	640	0	See 3.6.3.
Torque Related Constants	Cn-06	EMGTRQ	Emergency stop torque	%	0	Max. torque	Max. torque	See 3.1.2.
	Cn-08	TLMTF	Forward rotation torque limit	%	0	Max. torque	Max. torque	See 3.1.3.
	Cn-09	TLMTR	Reverse rotation torque limit	%	0	Max. torque	Max. torque	See 3.1.3.
	Cn-17	TRQFIL	Torque reference filter time constant	100 μ s	0	250	4	See 3.5.5.
	Cn-18	CLMIF	Forward external torque limit	%	0	Max. torque	100	See 3.1.3.
	Cn-19	CLMIR	Reverse external torque limit	%	0	Max. torque	100	See 3.1.3.
Sequence Related Constants	Cn-0B	TGONLV	Zero-speed level	r/min	1	4500	20	See 3.7.5.
	Cn-12	BRKTIM	Time delay from brake reference until servo OFF	10 ms	0	50	0	See 3.4.4.
	Cn-15	BRKSPD	Speed level for brake reference output during motor operation	r/min	0	4500	100	See 3.4.4.

LIST OF USER CONSTANTS

Category	User Constant No.	Code	Name	Unit	Lower Limit	Upper Limit	Factory Setting	Remarks
Sequence Related Constants	Cn-16	BRKWAI	Output timing of brake reference during motor operation	10 ms	10	100	50	See 3.4.4.
	Cn-1B	COINLV	Positioning complete range	Reference unit	0	250	7	See 3.7.3.
Pulse Related Constants	Cn-0A	PGRAT	Dividing ratio setting	P/R	16	32768	2048	See note 1 See 3.2.3.
	Cn-11	PULSNO	Number of encoder pulses	P/R	513	32768	2048	See note 1 See 3.3.3, 3.8.5.
	Cn-24	RATB	Electronic gear ratio (numerator)		4	65535	4	See note 3 See 3.2.3, 3.2.5.
	Cn-25	RATA	Electronic gear ratio (denominator)		1	65535	1	See note 3 See 3.2.3, 3.2.5.
	Cn-2A	PULSNO2	External PG number of pulses	P/R	513	32768	2048	
Other Constants	Cn-0C	TRQMSW	Mode switch (torque reference)	%	0	Max. torque	200	See 3.6.6.
	Cn-0D	REFMSW	Mode switch (speed reference)	r/min	0	4500	0	See 3.6.6.
	Cn-0E	ACCMSW	Mode switch (acceleration reference)	10 (r/min)/s	0	3000	0	See 3.6.6.
	Cn-0F	ERPMSW	Mode switch (error pulse)	Reference unit	0	10000	0	See 3.6.6.
	Cn-10	JOGSPD	Jog speed	r/min	0	4500	500	See 3.3.2.
	Cn-1E	OVERLV	Overflow	× 256 reference unit	1	32767	1024	See note 4 See 3.5.2, 3.6.2.
	Cn-1F	SPEED1	1st speed (contact input speed control)	r/min	0	4500	100	See 3.2.6.
	Cn-20	SPEED2	2nd speed (contact input speed control)	r/min	0	4500	200	See 3.2.6.
	Cn-21	SPEED3	3rd speed (contact input speed control)	r/min	0	4500	300	See 3.2.6.
	Cn-28	NFBCC	Speed loop compensation constant	---	0	100	0	

 : User constants that must be always set

Note 1) After changing the setting, always turn the power OFF, then ON. This makes the new setting valid.

2) Automatically set by autotuning function

3) The following restriction applies to electronic gear ratio (Cn-24 and Cn-25):

$$0.01 \leq \frac{B(Cn-24)}{A(Cn-25)} \leq 100$$

4) For user constant Cn-1E, when full-closed loop specification, factory setting is 1.



For Position Control

List of User Constants (Memory Switch Setting)

	User Constant No.	Bit No.	Setting		Factory Setting
Input signal enable/dis-able	Cn-01	0	0	1	0
			Uses servo ON input (S-ON).	Does not use servo ON input (S-ON). Servo is always ON.	
	1	0	0	1	0
			When absolute encoder is used, uses the SEN input signal (SEN).	When absolute encoder is used, masks the SEN signal. Automatically regarded as High level inside the Servopack.	
Input signal enable/dis-able	2	0	0	1	0
			Uses forward rotation prohibited input (P-OT).	Does not use forward rotation prohibited input (P-OT). Forward rotation is always possible.	
			3	0	
Uses reverse rotation prohibited input (N-OT).	Does not use reverse rotation prohibited input (N-OT). Reverse rotation is always possible.				
-	4	Not used.	Not used.	0	See note 3
-	5	Not used.	Not used.	0	
Sequence selection at alarm condition	6	0	0	1	0
			Stops the motor by applying dynamic brake when an alarm arises.	Causes the motor to coast to a stop when an alarm arises.	
	7	0	0	1	1
			When an alarm arises, stops the motor by applying dynamic brake and then releases dynamic brake.	When an alarm arises, stops the motor by applying dynamic brake but does not release dynamic brake.	
	8	0	0	1	0
Stops the motor according to bit 6 setting when overtravel is detected (P-OT, N-OT).			Decelerates the motor to a stop by applying the torque specified in Cn-06 when overtravel is detected (P-OT, N-OT).		
9	0	0	1	0	
			When overtravel is detected (P-OT, N-OT), decelerates the motor to a stop by applying the torque specified in Cn-06 and then turns the servo OFF.	When overtravel is detected (P-OT, N-OT), decelerates the motor to a stop by applying the torque specified in Cn-06 and then performs zero-clamp.	

D

	User Constant No.	Bit No.	Setting				Factory Setting	
Operation performed at servo OFF	Cn-01	A	0		1		0	
			Clears error pulse when servo is turned OFF.		Does not clear error pulse when servo is turned OFF.			
Mode switch selection	Cn-01	B	0		1		0	
			Uses mode switch function as set in bits D and C of Cn-01.		Does not use mode switch function.			
		D•C	0•0	0•1	1•0	1•1	0•0	
			Uses internal torque reference as a condition. (Level setting: Cn-0C)	Uses speed reference as a condition. (Level setting: Cn-0D)	Uses acceleration as a condition. (Level setting: Cn-0E)	Uses error pulse as a condition. (Level setting: Cn-0F)		
TGON signal function switch	Cn-01	E	0		1		0	
			Uses TGON signal as the motor running detection signal.		Uses TGON signal as the brake interlock signal.			
Contact input speed selection	Cn-01	F	0		1		0 See note 1	
			Stops the motor when both contact signals P-CL and N-CL are OFF.		Receives pulse reference when both contact signals P-CL and N-CL are OFF.			
INHIBIT function	Cn-01	F	0		1		0	
			Always receives pulse reference.		Enables INHIBIT function.			
Rotation direction selection	Cn-02	0	0		1		0	
			Defines counterclockwise (CCW) rotation as forward rotation.		Defines clockwise (CW) rotation as forward rotation (reverse rotation mode).			
Home position error processing selection	Cn-02	1	0		1		0	
			Detects home position error (when absolute encoder is used).		Does not detect home position error.			
Contact input speed control	Cn-02	2	0		1		0	
			Does not use contact input speed control.		Uses contact input speed control.			
Reference pulse form selection	Cn-02	5•4•3	0•0•0	0•0•1	0•1•0	0•1•1	1•0•0	0•0•0
			Sign + Pulse	CW + CCW	Phase A + Phase B (x 1 multiplication)	Phase A + Phase B (x 2 multiplication)	Phase A + Phase B (x 4 multiplication)	
Reserved	Cn-02	7•6	Reserved (not to be used)				0	
Motor selection	Cn-02	8	0		1		See note 2	
			SGM motor		SGMP motor			
Encoder selection	Cn-02	9	0		1		0	
			Incremental encoder		Absolute encoder			

D

LIST OF USER CONSTANTS

	User Constant No.	Bit No.	Setting		Factory Setting
Error counter clear signal	Cn-02	A	0	1	0
			Clears the error counter when an error counter clear signal is at high level.	Clears the error counter when the leading edge of an error counter clear signal rises.	
Selection of speed/torque or position control mode		B	0	1	0 See note 4
			Not used.	Position control mode	
Torque reference filter		C	0	1	0
			Primary	Secondary	
Reference pulse logic		D	0	1	0
			Does not invert reference pulse logic.	Inverts reference pulse logic.	
Position error monitor level		E	0	1	0
			Displays position error Un-08 in x 1 reference units while in monitor mode.	Displays position error Un-08 in x 100 reference units while in monitor mode.	
Reference pulse filter		F	0	1	0
			Line driver (Maximum reference pulse frequency: 450 kpps)	Open collector (Maximum reference pulse frequency: 200 kpps)	

: User constants that must be always set

- Note**
- 1) Internal speed selection is valid only when bit 2 of Cn-02 is set to "1."
 - 2) The factory setting depends on the Servopack type as shown below.

Servopack Type	Factory Setting
DR2- <input type="checkbox"/>	0
DR2- <input type="checkbox"/> P	1

- 3) At full-closed loop specification, when Cn-01 bit 4 is set to 1, external PG phase-C disconnection error is not detected.
- 4) At full-closed loop specification, factory setting of Cn-02 bit B is 1.

NOTE For the Cn-01 and Cn-02 memory switches, always turn the power OFF and then ON after changing the setting. This makes the new setting valid.

Appendix E

List of Alarm Displays

- SGDA Servopack allows up to 10 last alarms to be displayed at a digital operator. This function is called a traceback function.

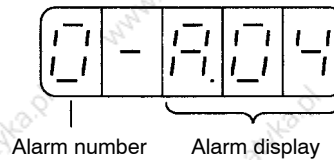

- This appendix provides the name and meaning of each alarm display.
- For details of how to display an alarm, refer to the following section:
4.2.1 Operation in Alarm Trace-back Mode
- For the cause of each alarm and the action to be taken, refer to the following section:
6.2.1 Troubleshooting Problems with Alarm Display

Alarm Display

Alarm Display on Digital Operator	7-segment LED	Alarm Output				Alarm Name	Meaning	Remarks
		Alarm Code Output			ALM Output			
		AL01	AL02	AL03				
A.00	0.	OFF	OFF	OFF	OFF	Absolute data error	Absolute data fails to be received, or received absolute data is abnormal.	For absolute encoder only
A.02	0.	OFF	OFF	OFF	OFF	User constant breakdown	Checksum results of user constants are abnormal.	
A.04	0.	OFF	OFF	OFF	OFF	User constant setting error	The user constant setting is outside the allowable setting range.	
A.10	1.	ON	OFF	OFF	OFF	Overcurrent	An overcurrent flowed through the power transistor.	
A.20	2.	OFF	ON	OFF	OFF	Blown fuse	Fuse is blown.	
A.30	3.	ON	ON	OFF	OFF	Regenerative error	Defective regenerative resistor Regenerative resistor disconnection	
A.31	3.	ON	ON	OFF	OFF	Position error pulse overflow	Position error pulse has exceeded the value set in user constant Cn-1E (overflow).	For position control only
A.40	4.	OFF	OFF	ON	OFF	Overvoltage or undervoltage	The main circuit voltage for motor operation has become too high or too low.	
A.51	5.	ON	OFF	ON	OFF	Overspeed	Motor speed has exceeded 4950 r/min.	
A.70	7.	ON	ON	ON	OFF	Overload	Rated torque was exceeded during continuous operation.	
A.80	8.	OFF	OFF	OFF	OFF	Absolute encoder error	The number of pulses per absolute encoder revolution is abnormal.	For absolute encoder only

OFF: Output transistor is OFF

ON: Output transistor is ON



Checksum

An automatic check function for a set of data such as user constants. It stores the sum of user constant data, recalculates the sum at specific timing, and then checks whether the stored value matches the recalculated value. This function is a simple method of checking whether a set of data is correct.

Alarm Display on Digital Operator	7-Segment LED	Alarm Output				ALM Output	Alarm Name	Meaning	Remarks
		Alarm Code Output							
		ALO1	AL02	AL03					
A.B 1	B.	OFF	OFF	OFF	OFF	Absolute encoder backup error	All three power supplies for the absolute encoder (+5 V, battery and internal capacitor) have failed.	For absolute encoder only	
A.B 2	B.	OFF	OFF	OFF	OFF	Absolute encoder checksum error	The checksum results of absolute encoder memory is abnormal.	For absolute encoder only	
A.B 3	B.	OFF	OFF	OFF	OFF	Absolute encoder battery error	Battery voltage for the absolute encoder is abnormal.	For absolute encoder only	
A.B 4	B.	OFF	OFF	OFF	OFF	Absolute encoder data error	The checksum results of absolute encoder memory is abnormal.	For absolute encoder only	
A.B 5	B.	OFF	OFF	OFF	OFF	Absolute encoder overspeed	The motor was running at a speed exceeding 400 r/min when the absolute encoder was turned ON.	For absolute encoder only	
A.b 1	b.	OFF	OFF	OFF	OFF	Reference input read error	Servopack CPU failed to detect reference input.		
A.C 1	C.	ON	OFF	ON	OFF	Servo overrun detected	The servomotor (encoder) ran out of control.		
A.C 2	C.	ON	OFF	ON	OFF	Encoder output phase error Incremental encoder initial pulse error	Phases A, B and C output by the encoder are abnormal. Wiring of encoder phase A or B is disconnected.		
A.C 3	C.	ON	OFF	ON	OFF	Encoder A-, B-phase disconnection	Phases A, B and C output by the encoder are abnormal.		
A.C 4	C.	ON	OFF	ON	OFF	Encoder C-phase disconnection	Wiring of encoder phases C is disconnected.		
A.C 6	C.	ON	OFF	ON	OFF	Full-closed loop A-, B-phase disconnection	A-, B-phase of external PG is disconnected.	Only for full-closed specification	
A.C 7	C.	ON	OFF	ON	OFF	Full-closed loop C-phase disconnection	C-phase of external PG is disconnected.	Only for full-closed specification	

OFF: Output transistor is OFF
ON: Output transistor is ON

LIST OF ALARM DISPLAYS

Alarm Display on Digital Operator	7-Segment LED	Alarm Output				ALM Output	Alarm Name	Meaning	Remarks
		Alarm Code Output							
		ALO1	AL02	AL03					
CPF00	-	Undefined					Digital operator transmission error 1	Digital operator fails to communicate with Servopack even five seconds after power is turned ON.	These alarms are not stored in alarm traceback memory.
CPF01	-	Undefined					Digital operator transmission error 2	Transmission error has occurred five consecutive times.	
A.99		OFF	OFF	OFF	ON		Not an error	Normal operation status	

OFF: Output transistor is OFF

ON: Output transistor is ON

E

Appendix F

Relationship between Reference Forms and User Constants

This appendix lists the relationship between reference forms and user constants.

<Remarks>

○: Related to or possibly related to

×: Not related at all

Relationship between Reference Forms and User Constants (1)

○ : Related to or possibly related to

× : Not related at all

User Constant No.	User Constant Name	Speed/Torque Control Mode (Cn-02 Bit B = 0)			
		Speed Control		Torque Control	
		Cn-02 Bit 2 = 0			
		Speed Control (Standard) Cn-01 Bit A = 0 Bit B = 0	Speed Control with Zero-clamp Function Bit A = 1 Bit B = 0	Torque Control I Bit A = 0 Bit B = 1	Torque Control II Bit A = 1 Bit B = 1
Cn-03	Speed reference gain	○	○	×	○
Cn-04	Speed loop gain	○	○	○	○
Cn-05	Speed loop integration time constant	○	○	×	×
Cn-06	Emergency stop torque	○	○	×	○
Cn-07	Soft start time (acceleration)	○	○	×	○
Cn-08	Forward torque limit	○	○	○	○
Cn-09	Reverse torque limit	○	○	○	○
Cn-0A	Encoder pulse dividing ratio	○	○	○	○
Cn-0B	Zero-speed level	○	○	○	○
Cn-0C	Mode switch (torque reference)	○	○	×	×
Cn-0D	Mode switch (speed reference)	○	○	×	×
Cn-0E	Mode switch (acceleration)	○	○	×	×
Cn-0F	Mode switch (error pulse)	×	×	×	×
Cn-10	JOG speed	○	○	○	○
Cn-11	Number of encoder pulses	○	○	○	○
Cn-12	Time delay from brake reference until servo OFF	○	○	○	○
Cn-13	Torque reference gain	○	○	○	○
Cn-14	Speed limit for torque control I	○	○	○	×
Cn-15	Speed level for brake reference output during motor operation	○	○	○	○
Cn-16	Output timing of brake reference during motor operation	○	○	○	○
Cn-17	Torque reference filter time constant	○	○	○	○
Cn-18	Forward external torque limit	○	○	○	○
Cn-19	Reverse external torque limit	○	○	○	○
Cn-1A	Position loop gain	×	○	×	×
Cn-1B	Position complete range	×	×	×	×
Cn-1C	Bias	×	×	×	×
Cn-1D	Feed forward	×	×	×	×
Cn-1E	Overflow	×	×	×	×

User Constant No.	User Constant Name	Speed/Torque Control Mode (Cn-02 Bit B = 0)			
		Speed Control		Torque Control	
		Cn-02 Bit 2 = 0			
		Speed Control (Standard) Cn-01 Bit A = 0 Bit B = 0	Speed Control with Zero-clamp Function Bit A = 1 Bit B = 0	Torque Control I Bit A = 0 Bit B = 1	Torque Control II Bit A = 1 Bit B = 1
Cn-1F	Contact input speed control (1st speed)	×	×	×	×
Cn-20	Contact input speed control (2nd speed)	×	×	×	×
Cn-21	Contact input speed control (3rd speed)	×	×	×	×
Cn-22	Speed coincide signal output range	○	○	×	○
Cn-23	Soft start time (deceleration)	○	○	×	○
Cn-24	Electronic gear (numerator)	×	×	×	×
Cn-25	Electronic gear (denominator)	×	×	×	×
Cn-26	Position reference accel/decel time constant	×	×	×	×
Cn-27	Feed forward reference filter	×	×	×	×
Cn-28	Speed loop compensation constant	○	○	×	○
Cn-29	Zero-clamp level	×	○	×	○
Cn-2A	Full-closed number of pulses	×	×	×	×

Relationship between Reference Forms and User Constants (2)

○: Related to or possibly related to
 ×: Not related at all

User Constant No.	User Constant Name	Speed/Torque Control Mode (Cn-02 Bit B = 0)			
		Contact Input Speed Control			
		Cn-02 Bit 2 = 1			
		Stops at Speed Reference is 0	Stops at Zero-clamp	Analog Speed Reference (V-REF) Input	Analog Speed Reference (V-REF) Input with Zero-clamp Function
		Cn-01 Bit A = 0 Bit B = 0	Cn-01 Bit A = 1 Bit B = 0	Cn-01 Bit A = 0 Bit B = 1	Cn-01 Bit A = 1 Bit B = 1
Cn-03	Speed reference gain	×	×	○	○
Cn-04	Speed loop gain	○	○	○	○
Cn-05	Speed loop integration time constant	○	○	○	○
Cn-06	Emergency stop torque	○	○	○	○
Cn-07	Soft start time (acceleration)	○	○	○	○
Cn-08	Forward torque limit	○	○	○	○
Cn-09	Reverse torque limit	○	○	○	○
Cn-0A	Encoder pulse dividing ratio	○	○	○	○
Cn-0B	Zero-speed level	○	○	○	○
Cn-0C	Mode switch (torque reference)	○	○	○	○
Cn-0D	Mode switch (speed reference)	○	○	○	○
Cn-0E	Mode switch (acceleration)	○	○	○	○
Cn-0F	Mode switch (error pulse)	×	×	×	×
Cn-10	JOG speed	○	○	○	○
Cn-11	Number of encoder pulses	○	○	○	○
Cn-12	Time delay from brake reference until servo OFF	○	○	○	○
Cn-13	Torque reference gain	○	○	○	○
Cn-14	Speed limit for torque control I	○	○	○	○
Cn-15	Speed level for brake reference output during motor operation	○	○	○	○
Cn-16	Output timing of brake reference during motor operation	○	○	○	○
Cn-17	Torque reference filter time constant	○	○	○	○
Cn-18	Forward external torque limit	○	○	○	○
Cn-19	Reverse external torque limit	○	○	○	○
Cn-1A	Position loop gain	○	○	○	○
Cn-1B	Position complete range	×	×	×	×

User Constant No.	User Constant Name	Speed/Torque Control Mode (Cn-02 Bit B = 0)			
		Contact Input Speed Control			
		Cn-02 Bit 2 = 1			
		Stops at Speed Reference is 0 Cn-01 Bit A = 0 Bit B = 0	Stops at Zero-clamp Cn-01 Bit A = 1 Bit B = 0	Analog Speed Reference (V-REF) Input Cn-01 Bit A = 0 Bit B = 1	Analog Speed Reference (V-REF) Input with Zero-clamp Function Cn-01 Bit A = 1 Bit B = 1
Cn-1C	Bias	×	×	×	×
Cn-1D	Feed forward	×	×	×	×
Cn-1E	Overflow	×	×	×	×
Cn-1F	Contact input speed control (1st speed)	○	○	○	○
Cn-20	Contact input speed control (2nd speed)	○	○	○	○
Cn-21	Contact input speed control (3rd speed)	○	○	○	○
Cn-22	Speed coincide signal output range	○	○	○	○
Cn-23	Soft start time (deceleration)	○	○	○	○
Cn-24	Electronic gear (numerator)	×	×	×	×
Cn-25	Electronic gear (denominator)	×	×	×	×
Cn-26	Position reference accel/decel time constant	×	×	×	×
Cn-27	Feed forward reference filter	×	×	×	×
Cn-28	Speed loop compensation constant	○	○	○	○
Cn-29	Zero-clamp level	×	○	×	○
Cn-2A	Full-closed number of pulses	×	×	×	×

Relationship between Reference Forms and User Constants (3)

○: Related to or possibly related to
 ×: Not related at all

User Constant No.	User Constant Name	Position Control Mode (Cn-02 Bit B = 1)		
		Position Control	Contact Speed	
		Cn-02 Bit 2 = 0	Cn-02 Bit 2 = 1	
		Position Control (Standard)	Stops at Speed Reference is 0 Cn-01 Bit F = 0	Pulse Reference Input Cn-01 Bit F = 1
Cn-03	Speed reference gain	×	×	×
Cn-04	Speed loop gain	○	○	○
Cn-05	Speed loop integration time constant	○	○	○
Cn-06	Emergency stop torque	○	○	○
Cn-07	Soft start time (acceleration)	×	○	○
Cn-08	Forward torque limit	○	○	○
Cn-09	Reverse torque limit	○	○	○
Cn-0A	Encoder pulse dividing ratio	○	○	○
Cn-0B	Zero-speed level	○	○	○
Cn-0C	Mode switch (torque reference)	○	○	○
Cn-0D	Mode switch (speed reference)	○	○	○
Cn-0E	Mode switch (acceleration)	○	○	○
Cn-0F	Mode switch (error pulse)	○	○	○
Cn-10	JOG speed	○	○	○
Cn-11	Number of encoder pulses	○	○	○
Cn-12	Time delay from brake reference until servo OFF	○	○	○
Cn-13	Torque reference gain	×	×	×
Cn-14	Speed limit for torque control I	×	×	×
Cn-15	Speed level for brake reference output during motor operation	○	○	○
Cn-16	Output timing of brake reference during motor operation	○	○	○
Cn-17	Torque reference filter time constant	○	○	○
Cn-18	Forward external torque limit	○	○	○
Cn-19	Reverse external torque limit	○	○	○
Cn-1A	Position loop gain	○	×	○
Cn-1B	Position complete range	○	×	○
Cn-1C	Bias	○	×	○

F

User Constant No.	User Constant Name	Position Control Mode (Cn-02 Bit B = 1)		
		Position Control	Contact Speed	
		Cn-02 Bit 2 = 0	Cn-02 Bit 2 = 1	
		Position Control (Standard)	Stops at Speed Reference is 0 Cn-01 Bit F = 0	Pulse Reference Input Cn-01 Bit F = 1
Cn-1D	Feed forward	○	×	○
Cn-1E	Overflow	○	×	○
Cn-1F	Contact input speed control (1st speed)	×	○	○
Cn-20	Contact input speed control (2nd speed)	×	○	○
Cn-21	Contact input speed control (3rd speed)	×	○	○
Cn-22	Speed coincide signal output range	×	○	○
Cn-23	Soft start time (deceleration)	×	○	○
Cn-24	Electronic gear (numerator)	○	×	○
Cn-25	Electronic gear (denominator)	○	×	○
Cn-26	Position reference accel/decel time constant	○	×	○
Cn-27	Feed forward reference filter	○	×	○
Cn-28	Speed loop compensation constant	○	○	○
Cn-29	Zero-clamp level	×	×	×
Cn-2A	Full-closed number of pulses	×	×	×

F

Appendix G

Reviewing the Full-closed Loop Specifications

This appendix outlines the checking methods for combination of mechanical specifications, linear scale (linear scale + waveform shaping circuit) and Servopack at full-closed loop specifications.

1 Grasping the Mechanical Specifications

1.1 Full-closed Loop System Configuration

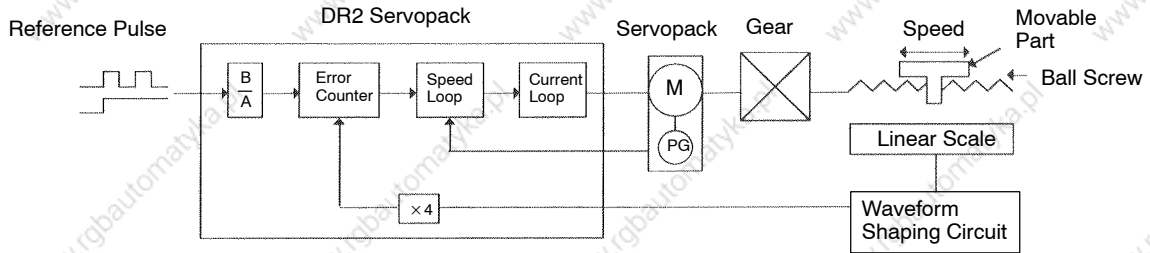

1.2 Checking the Mechanical Specifications

1) Mechanical Specifications

- Load Speed : $V =$ m/min
- Load Weight : $W =$ kg
- Ball Screw Spec. : Pitch $P =$ mm/rev
- Gear : Gear Ratio = /
- Detection Unit : mm/ PULSE
- Duty Cycle :

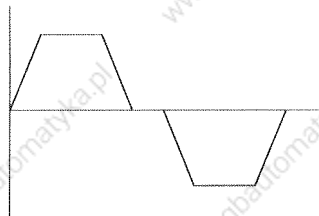

G

2) Applicable Servomotor and Servopack

- Servomotor : (with incremental encoder)
- Servopack : DR2-□-F •••• Full-closed feedback input conditions:
 - ① Line driver output from linear scale
 - ② Max. frequency : 675kPPS
($\frac{4500 \times 1.1}{60} \times 8192 \approx 675\text{kPPS}$)
 - ③ Linear scale evaluation magnification : 4

3) Applicable Linear Scale

- Manufacturer :
- Type : , Scale Interval : mm
- Waveform Shaping Circuit : Type =
(Detector EXE, interpolation digital circuit unit)
 - Max. operation speed = m/min
 - Max. input frequency = kHz
 - Output signal form =
 - Interpolation magnification = •••• (Conditions under the combination with linear scale)
 - Evaluation magnification =
 - Measuring pitch = μm
 - Min. edge interval = μs
 - Min. pulse width = μs •••• (Combination with Max. input frequency)

2 Application Example

2.1 Configuration

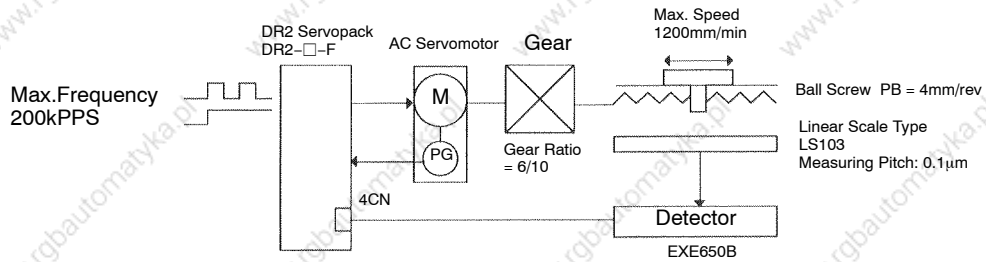

2.2 Linear Scale Specifications and Application Review at Full-closed System

1) Linear Scale Specifications

- Manufacturer : HEIDENHAIN
- Type : LS103, Scale Interval = $10\mu\text{m} = 0.01\text{mm}$
- Detector Type : EXE650B
- Max. Input Frequency : 60kHz (Interpolation magnification : 25)
- Interpolation Magnification = 25
- Evaluation Magnification = 4
- Output Signal : 5V line driver output, phase-A leading
(Conforming to DIN66259, EIA standard RS422)
- Measuring Pitch : $0.1\mu\text{m}$
- Min. Edge Interval and Pulse Width

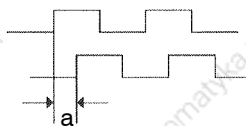

- When detector EXE650B (interpolation magnification: 25) is used:

8MHz Clock			10MHz Clock			Switching	
Max. Input Frequency fE max	Min. Edge Interval a min	Min. Pulse Width b min	Max. Input Frequency fE max	Min. Edge Interval a min	Min. Pulse Width b min	S3	S4
Approx. 60kHz	0.125µs	0.125µs	Approx. 60kHz	0.1µs	0.1µs	×	×
40kHz	0.25µs	0.25µs	50kHz	0.2µs	0.2µs	–	×
20kHz	0.5µs	0.5µs	25kHz	0.4µs	0.4µs	×	–
10kHz	1.0µs	1.0µs	12.5kHz	0.8µs	0.8s	–	–

(× : Switch is closed)

2) Application Review

a) Linear Scale :

$$\begin{aligned} \text{Input Frequency} &= \frac{\text{Operation Speed}}{\text{Scale Interval}} = \frac{1200/60}{0.01} \\ &= 2000\text{PPS} < \text{EXE650B Max.InputFrequency} \end{aligned}$$

b) Min. Edge Interval and Pulse Width

DR2 receivable max. frequency : 675kHz

$$\frac{10^6}{675000 \times 4} = 0.3704 \mu\text{s} < \text{Min. Edge Interval}$$

- With the above a) and b), switching S₃ and S₄ at 8MHz clock can be performed under both of the following conditions:

Max. Input Frequency	S ₃	S ₄
20kHz	×	–
10kHz	–	–

c) Feedback Frequency to Detector Output Frequency and Error Counter

$$\begin{aligned} \text{Detector Output Frequency} &= 2000 \times 25 = 50000\text{PPS} \rightarrow 50\text{kPPS} \\ \text{Feedback Frequency} &= 50 \times 4 = 200\text{kPPS} \end{aligned}$$

d) DR2 User Constant (Cn-24, -25)

$$* \text{ Electronic Gear} = \frac{B}{A} = \frac{Cn-24}{Cn-25} = \frac{Cn-2A \times 4}{4 \times 6} = \frac{6000 \times 4}{24000} = \frac{1}{1}$$

REVIEWING THE FULL-CLOSED LOOP SPECIFICATIONS

$$\begin{aligned} * \text{ Number of Full-closed Pulses} &= Cn-2A = \frac{4}{\frac{0.01 \times 10}{25 \times 6}} \\ &= \frac{4 \times 25 \times 6}{0.01 \times 10} = 6000P/rev \end{aligned}$$

* Memory switch Cn-02 Bit B =1

Conditions except above are the same as those of position control at full-closed specifications.

- Reviewing the above data, full-closed loop can be applicable under the above conditions.

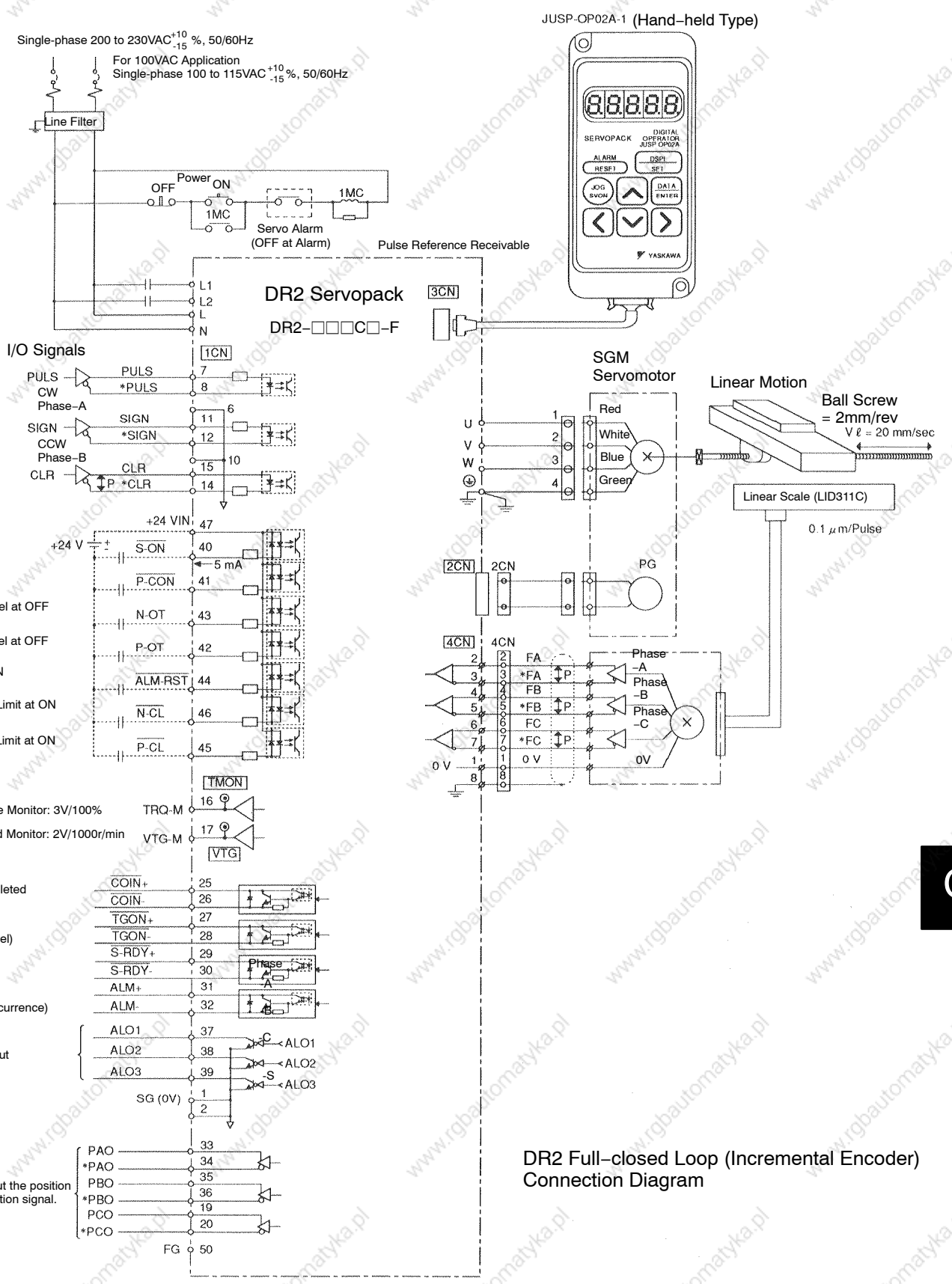

DR2 Full-closed Loop (Incremental Encoder) Connection Diagram



REVIEWING THE FULL-CLOSED LOOP SPECIFICATIONS

e) Output Phase Form: Refer to the following phase relation for the feedback pulse to Servopack

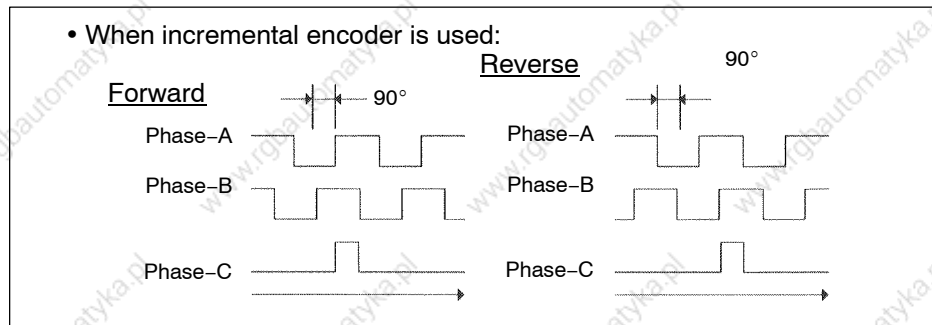

Forward: CCW when viewed from the drive end

$$\text{Reference pulse frequency} = \frac{20\text{mm/s}}{0.1\mu\text{m/pulse}} = 200\text{kPPS}$$

$$\text{Motor Speed} = \frac{20\text{mm/s}}{2\text{mm/rev}} \times 60\text{s/min} = 600\text{r/min}$$

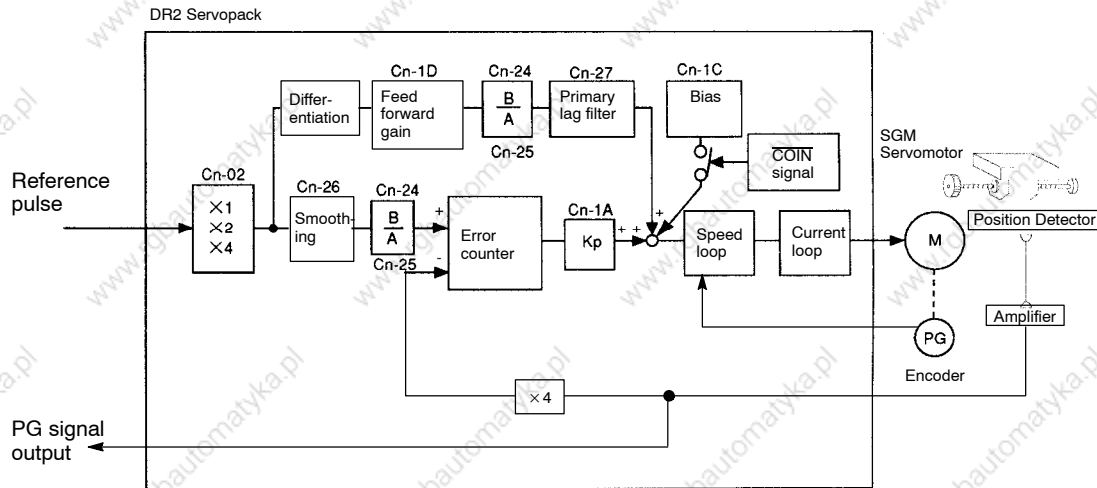

Note: Semi-closed and full-closed cannot be changed by internal setting.
(DR2-□□□□-E is the full-closed loop type Servopack.)

INDEX

Numbers

- 1CN connector
 - dimensional drawings, 371
 - specifications, 371
- 1CN connector kit, 27
- 4CN connector, 385

A

- absolute data
 - exchange sequence, 154
 - transmitting sequence, 155
- absolute value detection system, 151
- AC servomotor sizing software, 149
- alarm code output, 128
- alarm output signals, wiring, 128
- alarm signal circuit, test run, 39
- alarm traceback data, clearing, 200
- alarm traceback mode, 183
- alarms
 - display, 158
 - troubleshooting, 391
 - Servo, resetting using Digital Operator, 171
 - servo, reset, 171
- alignment, Servomotors, 20
- analog monitor, 102
- autotuning, 191
 - precautions, 192
- autotuning function, 118
 - Digital Operator, 188

B

- battery, 153
 - absolute encoder, 371
 - replacement, absolute encoder, 390
- bits, turning ON and OFF, 178
- brake power supply, 26
 - dimensional drawings, 363
 - internal circuit, 364

- specifications, 363

C

- Cable for motor, 27
- Cable for PG, 27
- cables, 140
 - encoders
 - dimensional drawings, 365
 - specifications, 365
 - for connecting PC and Servopack, 381
 - motor
 - connectors, 359
 - dimensional drawings, 355
 - specifications, 355
 - tension, 140
- CE Marking, 416
- CLT+, 58
- CLT-, 58
- comparators, 9
- connections
 - contact input signal terminals, 80
 - contact output signal terminals, 81
 - I/O signal terminals, Servopack, 30
- Connector kit for motor, 27
- Connector kit for PG, 27
- connector kits, 358
 - dimension drawings, 358
 - specifications, 358
- connectors
 - 1CN, test run, 39
 - 2CN, reverse rotation mode, 53
 - absolute encoder, 166
 - Digital Operator, 168
 - encoder cables, 358
 - incremental encoder, 165
 - motor cables, 359
 - standard-type motor
 - with brake, 167
 - without brake, 167
 - terminal layouts, 163
 - Servopack for speed/torque and position control, 163
- contact input signal terminals, connections, 80

contact input speed control function, 86
 motor speeds, 87
 prohibiting, 62
 soft start time, 87

Contact Input Speed Control Selection, 62

contact output signal terminals, connections, 81

controlled systems
 components, 6
 meaning, 5

D

deceleration stop mode, 56

detectors
 encoders, 8
 meaning, 5

Digital Operator, 14, 26

 alarm traceback mode, 183
 autotuning, 188
 connection, 170
 dimensional drawings, 334
 mode selection, 172
 monitor mode, 179
 status display mode, 173
 user constant setting mode, 176
 motor operation, 186
 selection, 216
 servo alarm reset, 171
 simple motor check, 186
 test run, 40

dimensional diagrams, noise filter, 374

dimensional drawings

 1CN connector, 371
 brake power supply, 363
 cables, encoders, 365
 connector kits, 358
 Digital Operator, 334
 Encoder Signal Converter Unit, 379
 magnetic contactor, 375
 motor cables, 355
 regenerative unit, 376
 Servomotors, 247–281, 289–323
 Servopacks, 329
 variable resistors, 379

dividing, 76

Dividing ratio setting, 77

drive systems, 6

dynamic brake, 108
 stop mode, 57

E

electronic gear function, 82
 setting, 82

electronic gear ratio, 82

 for different load mechanisms, 85

 load travel distance per revolution of load shaft in
 reference units, 83

 machine specifications, 82

 number of encoder pulses for the SGM Servomotor,
 82

 reference unit, 83

EMC Instructions, 417

EMC instructions, measures, 418

EN Standard, 416

encoder output, 76

 signals, divided, 76

encoder pulses, number per revolution, 105

Encoder Signal Converter Unit

 dimensional drawings, 379

 specifications, 379

encoders

 absolute, 8, 151

 battery, 371

 battery replacement, 390

 home position error detection, 159

 cables

 connectors, 358

 dimensional drawings, 365

 specifications, 365

 extending cables, 159

 incremental, 8

 specification, 78

error counter

 clear input, 74

 clear signal (CLR), 75

 clearing, 74

European Safe Standard, 416

Exterior type regenerative resistor, 26

external torque limit, 60

 forward, 61

 reverse, 61

external torque limit input, 61

 forward, 61

reverse, 61

F

feed-forward control, 120
 feedback control, meaning, 3
 Forward Run Reference, 52
 fuse, 142

G

gain
 adjustment, 115, 118
 speed reference, 68
 GL-Series Positioning Module B2813, connection example, 32
 GL-Series Positioning Module B2833, connection example, 31
 ground fault detector, 17
 ground wire, 140
 grounding, 17
 wiring, 143

H

high-voltage lines, Servopacks, 161
 holding brake, 110
 electrical specifications
 100VAC SGM Servomotors, 225
 100VAC SGMP Servomotors, 228
 200VAC SGM Servomotors, 218
 200VAC SGMP Servomotors, 222
 home position error detection, 159
 host controllers, 5, 10, 27
 hot start, 239

I

I/O Signal Generation Timing, 73
 impact resistance, 231
 INHIBIT function
 See , reference pulse inhibit function
 input pulse multiply function, 73

input signal terminals
 alarm reset, 131
 battery, 78
 error counter clear input, 74
 forward external torque limit input, 61
 forward rotation prohibited, 54
 I/O power supply, 80
 motor rotation direction, 89
 proportional/integral control, 68
 reference pulse input, 71
 reference sign input, 71
 reverse external torque limit input, 61
 reverse rotation prohibited, 54
 SEN signal input, 78
 servo ON, 132
 signal ground for speed reference input, 64, 94
 signal ground for torque reference input, 94
 speed reference input, 64, 94
 speed selection, 88
 torque reference input, 94
 torque/speed changeover, 95
 zero-clamp speed control, 109
 inspection, 388, 389
 Servomotors, 388
 Servopacks, 389
 installation, 18
 Servomotors, 19
 Servopacks, 22
 Installation sites
 Servomotors, 20
 Servopacks, 22
 internal torque limit, 57

J

jog speed, 104

L

limit switch, 54
 overtravel limit function, 54
 load inertia, 241
 loads
 allowable radial load, 230
 allowable thrust load, 230
 logic setting
 negative, 72
 positive, 72

M

machine data table, 210

machine rigidity, 189
 selection, 192

magnetic contactor, 26
 dimensional drawings, 375
 internal connection diagram, 375
 specifications, 375

maintenance, 388, 389
 Servomotors, 388
 Servopacks, 389

MCCB, 26, 141, 142, 373

mechanical tolerance, 231

memory switches
 See , user constants

MITSUBISHI Positioning Unit AD71 (B Type), connection example, 36

MITSUBISHI Positioning Unit AD72, connection example, 35

mode selection, Digital Operators, 172

mode switch, 122
 detection points
 error pulse, 125
 motor acceleration, 124
 speed reference, 124
 torque reference, 123

molded-case circuit breaker
 See , MCCB

monitor mode, 179

motor
 checking, Digital Operator, 186
 operation, Digital Operator, 186
 type check, 201

N

N-OT input signal, 55

Nameplate
 Servomotor, 18
 Servopacks, 19

noise control, 17
 filter, 26, 141
 dimensional diagrams, 374
 installation, 144
 specifications, 374
 wiring, 142

O

OMRON Position Control Unit C500-NC112, connection example, 34

OMRON Position Control Unit C500-NC222, connection example, 33

order lists, 341

output phase, form, 77
 absolute encoder, 77
 incremental encoder, 77

output signal terminals
 alarm code output, 129
 brake interlock output, 111
 encoder output, 77, 78
 frame ground, 78
 output signal ground common, 81
 positioning complete output, 133
 running output, 136
 servo alarm output, 129
 signal ground for alarm code output, 129
 signal ground for encoder output, 78
 signal ground for servo alarm output, 129
 speed coincide output, 134
 torque limit output, 58

overhanging load
 precautions, 17
 Servomotors, 246

overload, characteristics, Servopacks, 239

overtravel
 forward, 54
 reverse, 54

overtravel limit function, 54
 limit switch, 54

P

P-CON Signal, meaning, 68

P-OT input signal, 55

peripheral devices
 selection, 335
 flowchart, 336
 specifications, 349
 wiring, 25

personal computer, 27

Position Control, illustration, 14

Position Control Mode, 11

position references, inputs, 69
 line driver output, 69

open collector output, 70, 71
 positioning complete signal, 133
 positioning time, minimizing, 118
 power amplifiers, 9
 Power Consumption, 238
 Power for Open Collector Reference, 70
 power ON sequence, 29
 power ratings, 11
 precautions, 16
 pressure control, 91
 PROGIC-8, 10
 connection example, 30
 proportional control, 120
 proportional/integral control, 9, 120
 signal, 68
 protective sequence, 128
 pulse dividing ratio, 79
 pulse trains, 14

R

radial load, 20
 ratings
 100VAC SGM Servomotors, 224
 100VAC SGMP Servomotors, 227
 200VAC SGM Servomotors, 217
 200VAC SGMP Servomotors, 221
 DR2 Servopacks, 233
 reference offset, 195
 automatic adjustment, 107, 116, 195
 manual adjustment, 107, 116
 reference pulse
 form, 71
 input
 allowable voltage level, 74
 timing, 74
 Reference Pulse Form, 74
 Selection, 71
 reference pulse inhibit function, 100
 Reference Pulse Input, 71
 reference pulse input filter selection function, 101

regenerative unit, 26, 148
 connection, 150
 dimensional drawings, 376
 specifications, 376
 residual voltage, precautions, 16
 reverse rotation mode, 52, 53
 2CN connector, 53
 user constant, 53
 Reverse Run Reference, 52
 rotation
 forward, prohibiting, 55
 reverse, prohibiting, 55
 running output signal, 136

S

SEN signal, 152
 Servo amplifier, components, 9
 servo amplifiers, 9
 meaning, 5
 servo drive, meaning, 4
 servo mechanisms
 illustration, 5
 meaning, 2
 servo OFF, 56
 servo ON input signal, 132
 servo ready output signal, 138
 servo system
 configuration, 5
 illustration, 4
 meaning, 3, 4
 Servomotors
 100VAC SGM ratings, 224
 100VAC SGM specifications, 224
 100VAC SGM torque—motor speed characteristics, 226
 100VAC SGMP ratings, 227
 100VAC SGMP specifications, 227
 100VAC SGMP torque—motor speed characteristics, 229
 200VAC SGM ratings, 217
 200VAC SGM torque—motor speed characteristics, 220
 200VAC SGMP ratings, 221
 200VAC SGMP specifications, 221
 200VAC SGMP torque—motor speed characteristics, 223

- AC, 7
 - induction, 7
 - synchronous, 7
 - alignment, 20
 - components, 7
 - DC, 7
 - dimensional drawings, 247–281, 289–323
 - features, 11
 - inspection, 388
 - installation, 19
 - installation sites, 20
 - maintenance, 388
 - meaning, 4, 5
 - nameplate, 18
 - overhanging load, 246
 - selection, 205
 - flowchart, 208
 - machine data table, 210
 - setting the type, 106
 - storage, 19
 - test run, 39
 - type designation, 18
- Servopacks**
- dimensional drawings, 329
 - features, 11
 - high-voltage lines, 161
 - inspection, 389
 - installation, 22
 - installation sites, 22
 - instrument connection examples, 411
 - internal connection diagram, 411
 - maintenance, 389
 - meaning, 4
 - nameplate, 19
 - overload characteristics, 239
 - ratings, 233
 - selection, 212
 - flowchart, 214
 - specifications, 233
 - storage, 22
 - test run, 41
 - type designation, 19
- servos**
- alarm output, 128
 - alarm reset, 171
 - control systems, meaning, 4
 - gain adjustment, 115, 118
 - meaning, 3
 - smoothing function, 115
 - position reference acceleration/deceleration time constant, 115
 - soft start function, 90, 114
 - software, version check, 201
 - specifications
 - 100VAC SGM Servomotors, 224
 - 100VAC SGMP Servomotors, 227
 - 1CN connector, 371
 - 200VAC SGM Servomotors, 217
 - 200VAC SGMP Servomotors, 221
 - brake power supply, 363
 - cables, 349
 - encoders, 365
 - connector kits, 358
 - DR2 Servopacks, 233
 - home position pulse, 156
 - incremental pulse, 156
 - magnetic contactor, 375
 - noise filter, 374
 - peripheral devices, 349
 - regenerative unit, 376
 - serial data, 156
 - speed bias, 121
 - speed coincide output signal, 134
 - speed control, 67
 - illustration, 12
 - Speed monitor, 102
 - speed reference
 - gain, 68
 - input, 64
 - Speed Reference Input, 65
 - speed reference offset, manual adjustment mode, 197
 - speed references, 64
 - Speed/Torque Control Mode, 11
 - starting time, 240
 - status display mode, 173
 - stop mode, setting, 107
 - stop torque, 56
 - stopping time, 240
 - Storage
 - Servomotors, 19
 - Servopacks, 22
 - supply voltages, precautions, 16

surge suppressor, 376

T

tension control, 91

terminal layout, 2CN, 164

terminal name

control power supply input, 28

ground terminal, 28

main circuit AC input, 28

motor connection, 28

regenerative resistor, 28

regenerative unit connection, 28

terminals, standard—type motor

with brake, 167

without brake, 167

Test Run, 37

test run

minimum user constants, 47

motor connected to the machine, 43

motor without load, 39

position control from the host controller, 46

servomotor with brake, 45

step 1, description, 38

step 1, procedures, 39

step 2, description, 38

step 2, procedures, 43

thrust load, 20

Torque Control, illustration, 13

torque control, 57, 91

Torque control I, definition, 13

Torque control II, definition, 13

torque feed—forward function, 97

torque limit

forward rotation, 57

input signals, 62

output signal, 58

reverse rotation, 57

value, 99

Torque monitor, 102

Torque Reference Filter Degree, 117

torque reference filter time constant, 116

torque restriction, 57

torque restriction function, 60

by analog voltage reference, 99

torque limit value, 61

troubleshooting

alarm display, 391

without alarm display, 409

TRQ-M Specifications, 102

TÜV, 417

type designation

Servomotor, 18

Servopack, 19

U

user constant setting mode, 176

user constants, 55, 62

bias, 121

brake signal output timing during motor operation, 113

brake signal speed level output during motor operation, 113

contact input speed control function, 62

contact input speed control selection, 86

control mode selection, 66

dividing ratio setting, 79, 157

electronic gear ratio, 84

emergency stop torque, 56

encoder type selection, 78, 105, 152

error counter clear signal selection, 64, 75

feed-forward gain, 120

jog speed, 104

mode switch ON/OFF, 125

mode switch selection, 126

motor selection, 106

motor speeds, 87

number of encoder pulses, 105, 153

operation at recovery from power loss, 138

operation when motor stops after overtravel, 55

operation when motor stops after servo OFF, 56

overflow, 119

PI/P changeover, 120

position loop gain, 119

positioning complete range, 133

reference pulse inhibit function, 100

reference pulse input filter selection function, 101

reverse rotation mode, 53

rotation direction selection, 53

SEN input signal, 152

servo ON input signal, 132

soft start time, 87, 114

speed coincidence signal output width, 135

speed limit for torque control I, 96

speed loop gain, 119
speed loop integration time constant, 119
speed reference gain, 68, 96
stopping motor at servo OFF, 56, 108
stopping the motor at overtravel, 55
TGON output signal selection, 59, 136, 137
time delay from brake signal output to servo OFF, 112
torque control, 91
torque feed–forward function selection, 97
torque reference filter time constant, 116
torque reference gain, 96, 98, 99
torque restriction by analog voltage reference, 99
zero-clamp speed control, 109
zero-speed level, 138
zero-clamp level, 110

V

variable resistor, dimensional drawings, 379
vibration class, 232

vibration resistance, 231
voltage resistance test, 17

W

wiring, 25, 53, 140
grounding, 143
main circuit, 28
more than one servo drive, 147
noise control, 142
peripheral devices, 25
precautions, 16, 140
shorting, 2CN connector, 53

Z

zero–clamp function, 109
zero-clamp function, meaning, 68
Zero-clamp Speed Control, 67

Σ Series SGM/SGMP/DR2 USER'S MANUAL

TOKYO OFFICE

New Pier Takeshiba South Tower, 1-16-1, Kaigan, Minatoku, Tokyo 105-6891 Japan
Phone 81-3-5402-4511 Fax 81-3-5402-4580

YASKAWA ELECTRIC AMERICA, INC.

2121 Norman Drive South, Waukegan, IL 60085, U.S.A.
Phone 1-847-887-7000 Fax 1-847-887-7370

MOTOMAN INC. HEADQUARTERS

805 Liberty Lane West Carrollton, OH 45449, U.S.A.
Phone 1-937-847-6200 Fax 1-937-847-6277

YASKAWA ELÉTRICO DO BRASIL COMÉRCIO LTDA.

Avenida Fagundes Filho, 620 Bairro Saude-Sao Paulo-SP, Brazil CEP: 04304-000
Phone 55-11-5071-2552 Fax 55-11-5581-8795

YASKAWA ELECTRIC EUROPE GmbH

Am Kronberger Hang 2, 65824 Schwalbach, Germany
Phone 49-6196-569-300 Fax 49-6196-888-301

Motoman Robotics Europe AB

Box 504 S38525 Torsås, Sweden
Phone 46-486-48800 Fax 46-486-41410

Motoman Robotec GmbH

Kammerfeldstraße 1, 85391 Allershausen, Germany
Phone 49-8166-900 Fax 49-8166-9039

YASKAWA ELECTRIC UK LTD.

1 Hunt Hill Orchardton Woods Cumbernauld, G68 9LF, United Kingdom
Phone 44-1236-735000 Fax 44-1236-458182

YASKAWA ELECTRIC KOREA CORPORATION

Kfpa Bldg #1201, 35-4 Youido-dong, Yeongdungpo-Ku, Seoul 150-010, Korea
Phone 82-2-784-7844 Fax 82-2-784-8495

YASKAWA ELECTRIC (SINGAPORE) PTE. LTD.

151 Lorong Chuan, #04-01, New Tech Park Singapore 556741, Singapore
Phone 65-282-3003 Fax 65-289-3003

YASKAWA ELECTRIC (SHANGHAI) CO., LTD.

4F No.18 Aona Road, Waigaoqiao Free Trade Zone, Pudong New Area, Shanghai 200131, China
Phone 86-21-5866-3470 Fax 86-21-5866-3869

YATEC ENGINEERING CORPORATION

Shen Hsiang Tang Sung Chiang Building 10F 146 Sung Chiang Road, Taipei, Taiwan
Phone 886-2-2563-0010 Fax 886-2-2567-4677

YASKAWA ELECTRIC (HK) COMPANY LIMITED

Rm. 2909-10, Hong Kong Plaza, 186-191 Connaught Road West, Hong Kong
Phone 852-2803-2385 Fax 852-2547-5773

BEIJING OFFICE

Room No. 301 Office Building of Beijing International Club, 21
Jianguomenwai Avenue, Beijing 100020, China
Phone 86-10-6532-1850 Fax 86-10-6532-1851

TAIPEI OFFICE

Shen Hsiang Tang Sung Chiang Building 10F 146 Sung Chiang Road, Taipei, Taiwan
Phone 886-2-2563-0010 Fax 886-2-2567-4677

SHANGHAI YASKAWA-TONGJI M & E CO., LTD.

27 Hui He Road Shanghai China 200437
Phone 86-21-6531-4242 Fax 86-21-6553-6060

BEIJING YASKAWA BEIKE AUTOMATION ENGINEERING CO., LTD.

30 Xue Yuan Road, Haidian, Beijing P.R. China Post Code: 100083
Phone 86-10-6233-2782 Fax 86-10-6232-1536

SHOUGANG MOTOMAN ROBOT CO., LTD.

7, Yongchang-North Street, Beijing Economic Technological Investment & Development Area,
Beijing 100076, P.R. China
Phone 86-10-6788-0551 Fax 86-10-6788-2878



YASKAWA

YASKAWA ELECTRIC CORPORATION