



DYNASYN
High torque-Servomotors DT
Dynamic. Compact.
Powerful.

AMK



Top-class dynamic response: DT compact high-torque motors

The DYNASYN DT series of high-torque motors meets the highest requirements made by modern drive technology in terms of high dynamic response and precision, while boasting extremely compact dimensions.

All these motors have been developed and manufactured in-house. AMK is able to draw on decades of experience in the servo motor business and this, together with its extensive expertise and inventiveness, enables the company to create efficient, flexible and innovative drive solutions.

The DT series of motors stands out from the crowd thanks to the following performance data:

- Continuous power range of 280 W to 25 kW
- Continuous standstill torques of 0.5 to 220 Nm
- Maximum torques of up to 450 Nm
- Convection-cooled or liquid-cooled
- With resolver or optical absolute encoders

These figures combine to produce an integrated drive concept, from the auxiliary axis right through to the main drive. The motors have a high overload capacity for peak loads thanks to the use of an optimized winding and magnet technology.

The maximum torque can be utilized over a wide speed range, thus facilitating extremely fast motor acceleration and deceleration. This makes DT motors ideal for use in dynamic positioning applications. The innovative concept also benefits from being largely maintenance-free and from a long service life.

DT compact synchronous servo motors are available in convection-cooled and liquid-cooled versions. The parts of the motors that carry liquids are made from stainless steel to ensure that they do not have to be maintained and that they can offer high system availability.

A variety of encoder systems supports rapid and accurate motor positioning. Simple drive tasks and those requiring an average degree of accuracy can be performed using a resolver. Motor encoders with EnDAT® interfaces are available for applications calling for greater precision.

No matter what sector of industry you are working in, AMK can provide you with the right motor for every application. Whether used as direct drives or with gear reduction, their excellent features mean that DT motors are ideally suited to meet the requirements of a wide variety of sectors.

These include:

- Injection molding machines
- Printing presses
- Paper processing machines
- Packaging machines
- Handling and assembly systems
- Materials handling and RSU technology systems
- Automation systems
- Presses
- Machine tools
- Special machines

The motors can be fitted with a holding brake and/or a gearbox as an option. Special models, integrated motors or designs featuring hollow shafts or flange outputs are also possible.

In conjunction with digital servo converters from the AMKASYN KE/KW series, these motors form the basis of an intelligent drive system that can be used in a positive, efficient way for all drive tasks such as torque, speed and position control, positioning and synchronous control wherever space is at a premium. On motors with EnDAT® encoders, inverters detect motor-specific parameters automatically. System-specific data can be stored in the motor encoder.

Features

- High dynamic performance due to a good torque-inertia ratio
- High power density due to a high number of poles and optimized plate geometry
- High overload capacity for peak loads
- Largely maintenance-free, very reliable, long service life
- Motor well protected against dust and water due to the high degree of protection
- Winding temperature monitoring further improves safety and reliability
- Low risk of contamination due to smooth surface
- Flexible mounting options in all positions due to compact housing dimensions and rotatable connectors
- Lifetime lubrication for all mounting positions
- Simple, straightforward commissioning thanks to AMK motor data found in the encoder (electronic nameplate)

Options

- Single/multi-turn absolute encoder
- Shaft with feather key
- Holding brake



Overview

Type key

D T 3 - x - 10 - R x x - xxxx

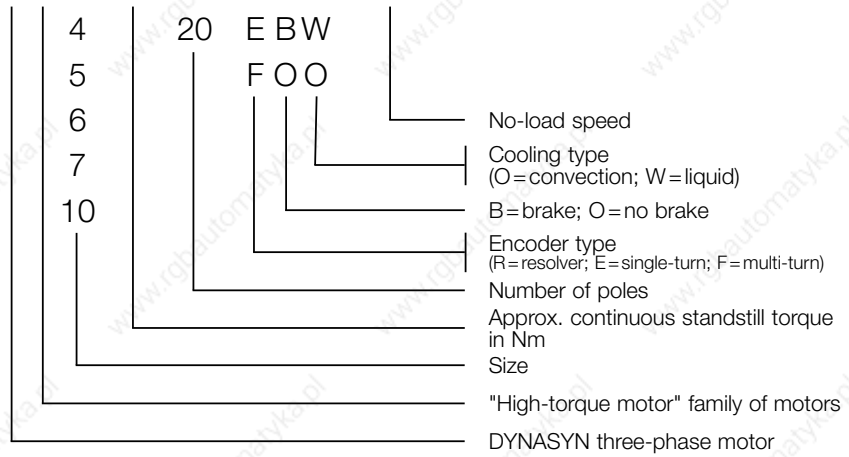

Convection-cooled motors

Motor type	Square flange	Standstill data		Rating					Maximum data		Electr. data		Mechanical data				
	mm	M ₀ [Nm]	I ₀ [A]	M _N [Nm]	P _N [kW]	I _N [A]	n _N [1/min]	k _T [Nm/A]	M _{max} [Nm]	I _{max} [A]	L _{tt} [mH]	R _{tt} [Ω]	n _{max} [1/min]	J [kgcm ²]	L [mm]	L _{BR} [mm]	m [kg]
DT3-0.5-10-RxO-9000	55	0.5	0.8	0.45	0.28	0.73	6000	0.62	1.6	3.1	42	22	10000	0.1	110	140	0.8
DT3-1-10-RxO-9000		1.2	1.9	1	0.5	1.6	6000	0.62	4.8	10	14	4.4		0.3	170	200	1.9
DT4-1-10-RxO-5000	70	1.1	1.2	0.9	0.4	1	4000	0.9	3.6	4	44	21.4	8000	0.36	135	145	2.3
DT4-2-10-RxO-5000		1.8	2.0	1.4	0.6	1.6	4000	0.9	6.1	6.6	19	8.5		0.68	165	175	2.7
DT4-4-10-RxO-5000	100	3	3.3	1.9	0.8	2.1	4000	0.9	15	17	9.1	3.7	5000	1.44	225	254	3.5
DT5-3-10-RxO-5000		2.4	2.1	1.7	0.8	1.5	4500	1.14	10	10	35	6.8		1.72	200	235	4.4
DT5-5-10-RxO-5000	140	4.5	3.8	3.3	1.2	2.8	3500	1.16	20	20	15	2.7	4000	3.05	230	265	4.9
DT5-9-10-RxO-4000		8.4	5.7	6	1.9	4.1	3000	1.47	41	33	11	1.8		7.4	290	325	7.4
DT6-13-10-RxO-3500	142	11	9.0	7.9	2.5	6.5	3000	1.22	47	46	7.5	0.98	4000	11.3	285	315	12.2
DT6-20-10-RxO-3500		17	13.6	11	3.4	8.7	3000	1.25	72	67	4.5	0.51		21.4	345	375	17
DT7-11-20-RxO-3500	190	10	6.6	6.6	1.9	4.4	2800	1.51	30	20	8.4	2.48	4000	16.9	204	233	9.3
DT7-17-20-RxO-3500		17	11.3	11	2.8	7.2	2500	1.50	60	50	4.1	0.97		33.0	234	263	14.2
DT7-28-20-RxO-2000		28	10.4	19	3	7.2	1500	2.68	120	46	6	1.2		57.0	294	323	18.9
DT7-40-20-RxO-2000		42	15.2	29	3	10.5	1000	2.76	170	100	3.1	0.68		3500	85.0	354	383
DT10-54-20-RxO-1400	190	66	17	45	4.7	11.6	800	3.9	150	60	6.4	0.6	2000	175	300	360	42
DT10-95-20-RxO-700		95	12.8	54	3.4	7.3	600	7.4	310	33	11.4	1.1		310	420	420	61
DT10-125-20-RxO-650		125	13.3	60	3.1	6.3	500	9.4	430	67	12.8	1.1		1000	440	540	600

Liquid-cooled motors

Motor type	Square flange	Standstill data		Rating					Maximum data		Electr. data		Mechanical data				
	mm	M ₀ [Nm]	I ₀ [A]	M _N [Nm]	P _N [kW]	I _N [A]	n _N [1/min]	k _T [Nm/A]	M _{max} [Nm]	I _{max} [A]	L _{tt} [mH]	R _{tt} [Ω]	n _{max} [1/min]	J [kgcm ²]	L [mm]	L _{BR} [mm]	m [kg]
DT5-15-10-RxW-6000	100	15	14.5	13	5.8	12	4500	1.03	40	45	5.6	0.93	6300	7.4	235	295	14
DT5-23-10-RxW-6500		23	25.6	13.5	7.1	15	5000	0.9	47	67	2.9	0.45		10.6	295	355	17
DT7-55-20-RxW-5200	153	60	60	38	14	38	3500	1.0	110	132	0.99	0.16	5000	57	290	335	21
DT7-72-20-RxW-5000		88	55	57	18	42	3000	1.6	170	135	0.83	0.2		85	350	395	25
DT10-100-20-RxW-3000	200	95	54.2	66	11	38	1500	1.75	160	132	1.53	0.165	6000	175	300	360	43
DT10-145-20-RxW-2000		160	66.6	120	18	50	1500	2.4	310	200	1.16	0.11		380	420	480	64
DT10-200-20-RxW-2500		220	95.5	150	23.5	65	1500	2.3	520	330	0.67	0.07		3000	440	540	600

DT3 convection-cooled servo motors

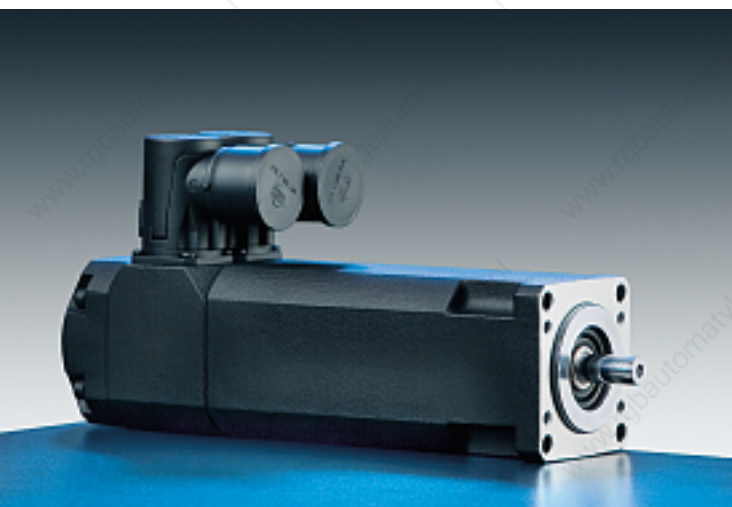

Features

- Very high standstill torques in relation to the shaft height
- High torque and power density
- High overload capacity
- Maximum dynamic response with acceleration values of up to 160,000 rad/s²
- High degree of protection

Applications

- Positioning and actuating drive for drive tasks with or without gearbox
- For intermittent operation
- Variable-speed drive for continuous running

Equipment

	Standard	Option
Brake	–	1.1 Nm
Encoder	Resolver	E, F encoder
Shaft	smooth	Shaft key DIN6885 A3x3x12

Connection cable: Copper conductor rated cross-section 1.5 mm², power connector size 1

Characteristics

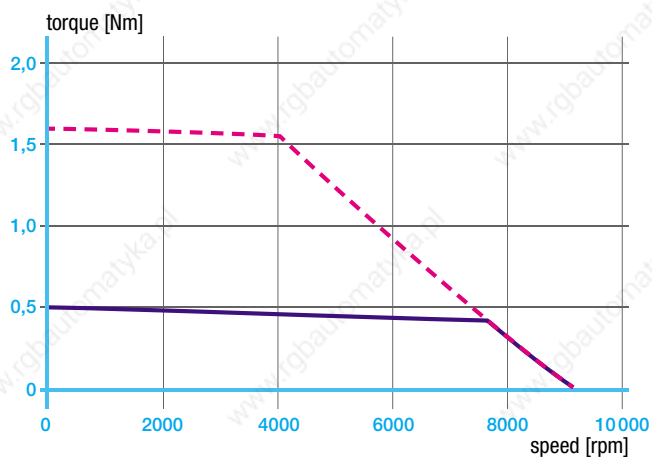

DT3-0,5-10-xxO-9000-B5

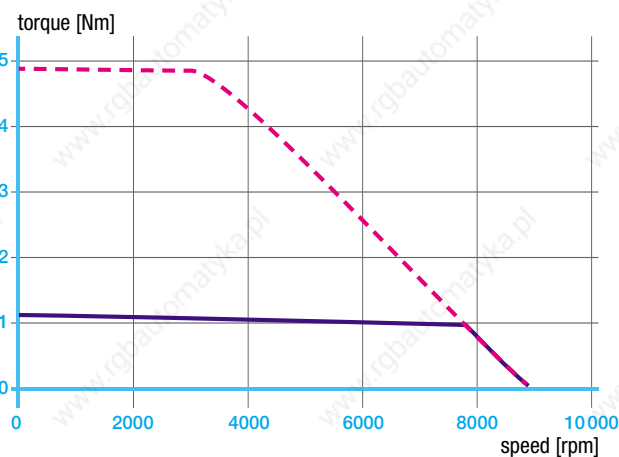

DT3-1-10-xxO-9000-B5

Technical data

Motor type	Standstill data		Rating					Maximum data		Electr. data		Mechanical data				
	M_o [Nm]	I_o [A]	M_N [Nm]	P_N [kW]	I_N [A]	n_N [1/min]	k_T [Nm/A]	M_{max} [Nm]	I_{max} [A]	L_{tt} [mH]	R_{tt} [Ω]	n_{max} [1/min]	J [kgcm ²]	L [mm]	LBR [mm]	m [kg]
DT3-0.5-10-RxO-9000	0.5	0.8	0.45	0.28	0.73	6000	0.62	1.6	3.1	42	22	10000	0.1	110	140	0.8
DT3-1-10-RxO-9000	1.2	1.9	1	0.5	1.6	6000	0.62	4.8	10	14	4.4	10000	0.3	170	200	1.9

Dimensions

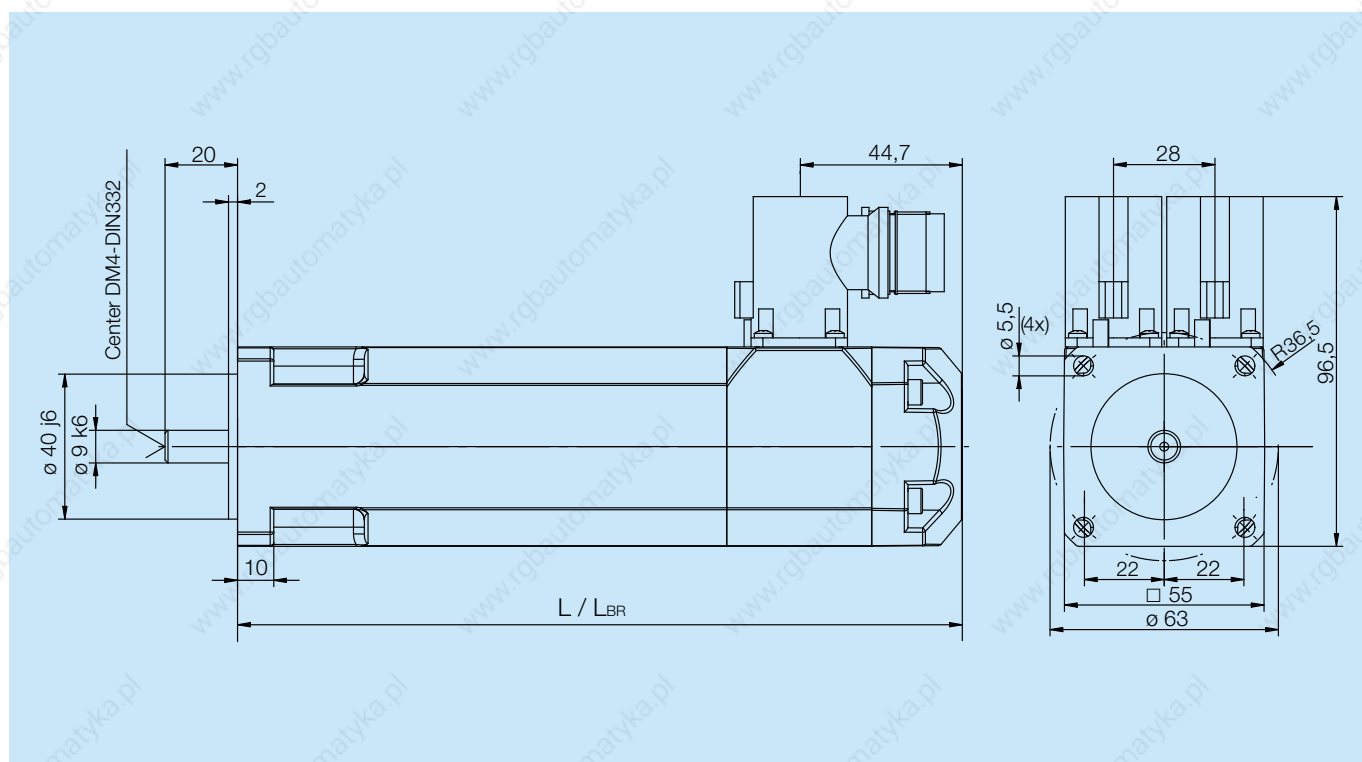

Bearing service life (L10h)

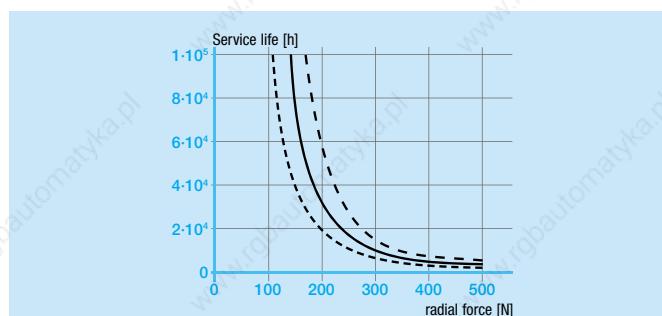

DT3-0,5-10-xxO-9000-B5 · DT3-1-10-xxO-9000-B5

DT4 convection-cooled servo motors

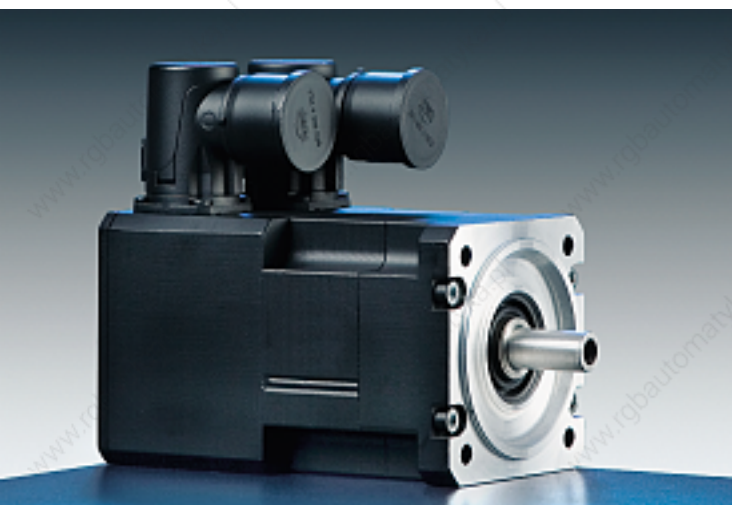

Features

- Very high standstill torques in relation to the shaft height
- High torque and power density
- Maximum dynamic response with acceleration values of up to 100,000 rad/s²

Applications

- Positioning and actuating drive for drive tasks with or without gearbox
- For intermittent operation
- Variable-speed drive for continuous running

Equipment

	Standard	Option
Brake	–	4.5 Nm
Encoder	Resolver	E, F encoder
Shaft	Smooth	Shaft key For shaft diameter 11mm the size of the shaft key is A4x4x16mm according to DIN 6885 For shaft diameter 14 mm the size of the shaft key is 5x5x20mm according to DIN 6885.

Connection cable: Copper conductor rated cross-section 1.5 mm², power connector size 1

Characteristics

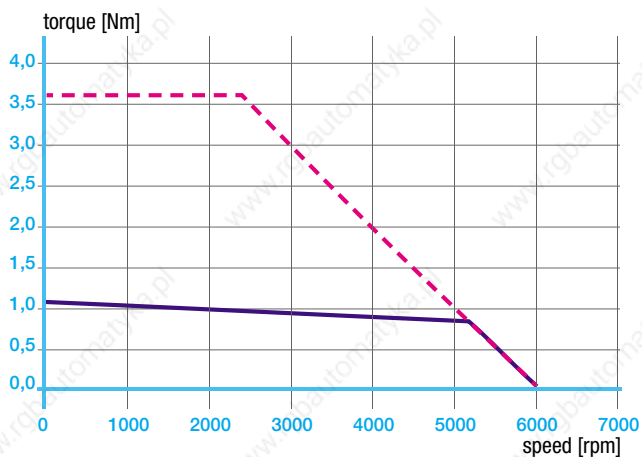

DT4-1-10-xxO-5000

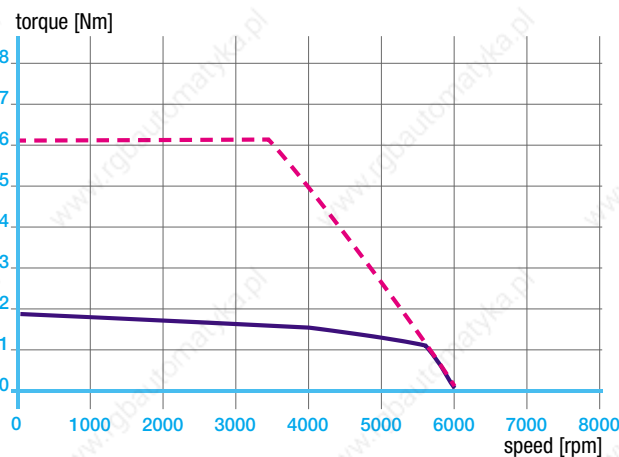

DT4-2-10-xxO-5000

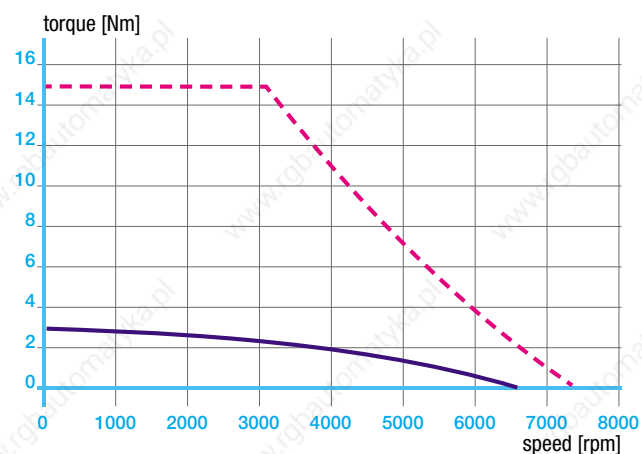

DT4-4-10-xxO-5000

Technical data

Motor type	Standstill data		Rating					Maximum data		Electr. data		Mechanical data									
	M ₀ [Nm]	I ₀ [A]	M _N [Nm]	P _N [kW]	I _N [A]	n _N [1/min]	k _T [Nm/A]	M _{max} [Nm]	I _{max} [A]	L _{tt} [mH]	R _{tt} [Ω]	n _{max} [1/min]	J [kgcm ²]	D _w [mm]	L [mm]	L ₁ [mm]	L ₂ [mm]	L _{BR} [mm]	L _{1BR} [mm]	L _{2BR} [mm]	m [kg]
DT4-1-10-RxO-5000	1.1	1.2	0.9	0.4	1	4000	0.9	3.6	4	44	21.4	8000	0.36	11	116	30	18	145	59	47	2.3
DT4-1-10-ExO-5000															145	59	47	170	84	72	
DT4-1-10-FxO-5000															145	59	47	170	84	72	
DT4-2-10-RxO-5000	1.8	2.0	1.4	0.6	1.6	4000	0.9	6.1	6.6	19	8.5	8000	0.68	11	146	30	18	175	59	47	2.7
DT4-2-10-ExO-5000															175	59	47	200	84	72	
DT4-2-10-FxO-5000															175	59	47	200	84	72	
DT4-4-10-RxO-5000	3	3.3	1.9	0.8	2.1	4000	0.9	15	17	9.1	3.7	8000	1.44	14	225	30	18	254	59	47	3.5
DT4-4-10-ExO-5000															254	59	47	279	84	72	
DT4-4-10-FxO-5000															254	59	47	279	84	72	

Dimensions

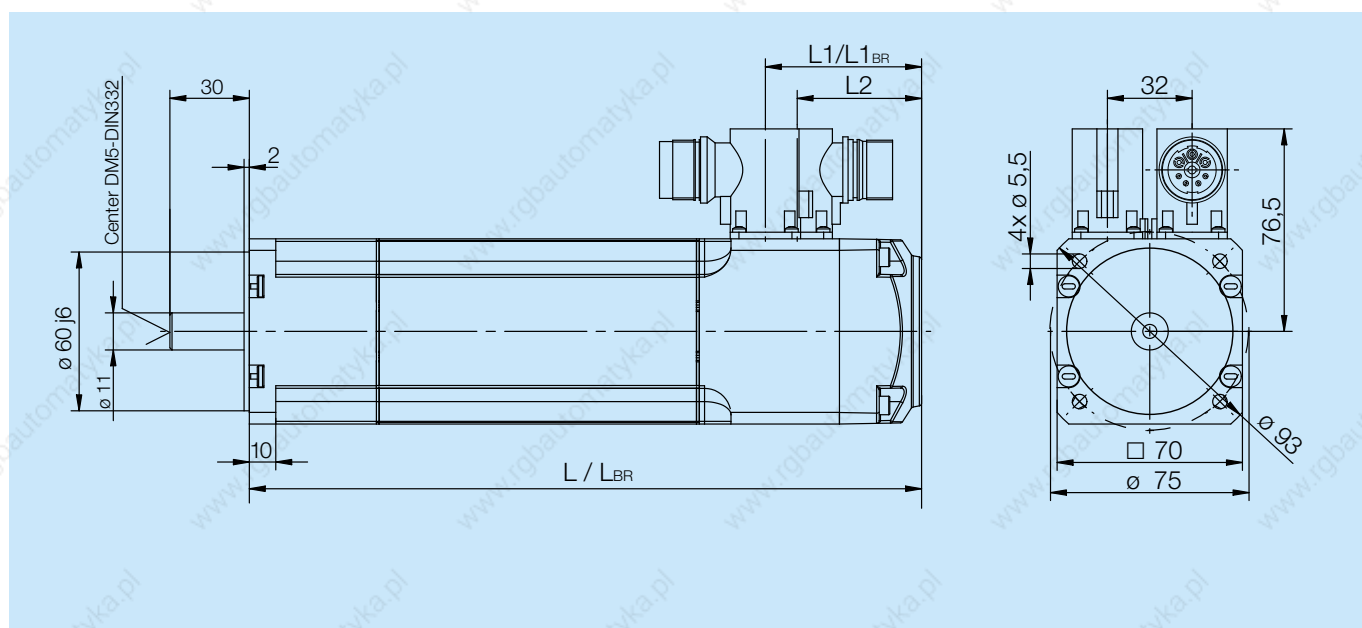

Bearing service life (L10h)

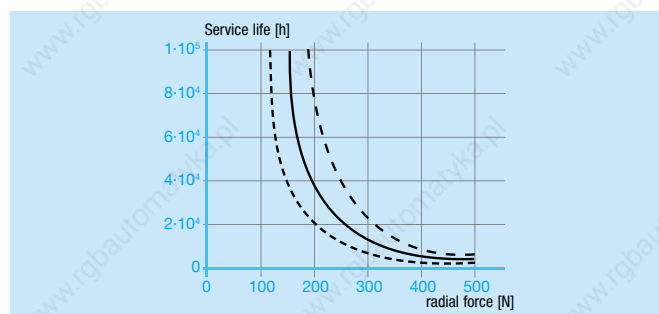
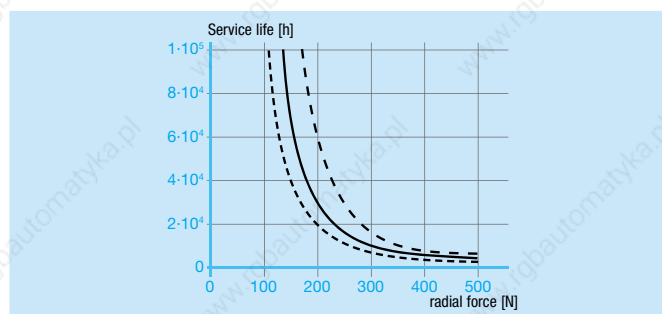

DT4-1-10-xxO-5000 · DT4-2-10-xxO-5000

DT4-4-10-xxO-5000

See the fold-out section on the back page for a key. All dimensions are given in mm.

DT5 convection-cooled servo motors

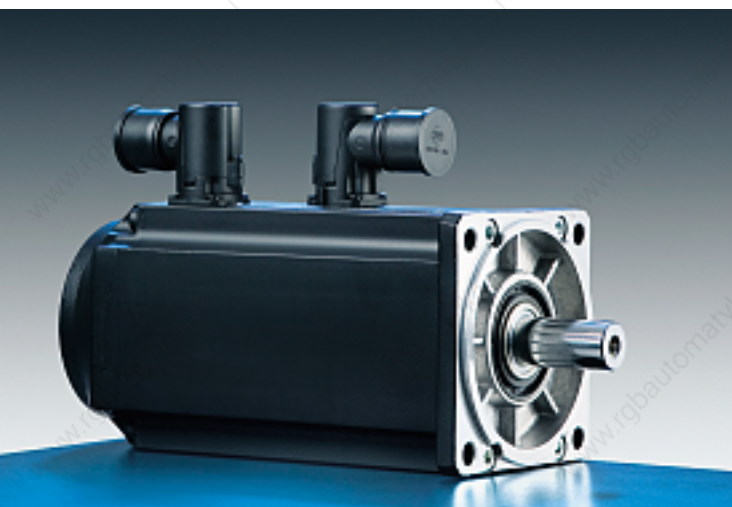

Features

- High standstill torques
- High torque and power density
- Maximum dynamic response with acceleration values of up to 65,000 rad/s²

Applications

- Positioning and actuating drive for drive tasks with or without gearbox
- For intermittent operation
- Variable-speed drive for continuous running

Equipment

	Standard	Option
Brake	–	12 Nm
Encoder	Resolver	E, F encoder
Shaft	Smooth	Shaft key DIN6885 A6x6x30

Connection cable: Copper conductor rated cross-section 1.5 mm², power connector size 1

Characteristics

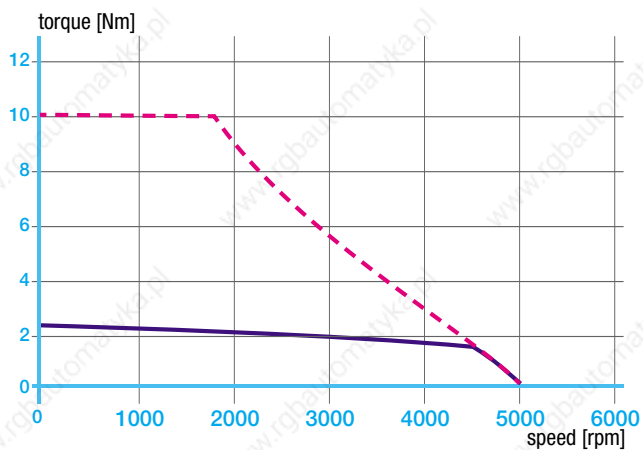

DT5-3-10-xxO-5000-B5

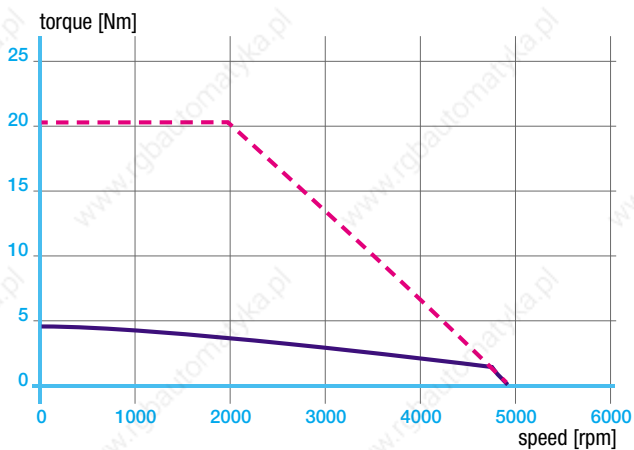

DT5-5-10-xxO-5000-B5

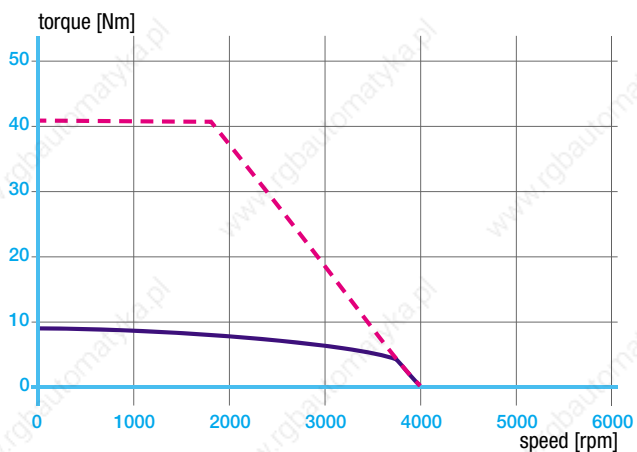

DT5-9-10-xxO-4000-B5

Technical data

Motor type	Standstill data		Rating					Maximum data		Electr. data			Mechanical data					
	M ₀ [Nm]	I ₀ [A]	M _N [Nm]	P _N [kW]	I _N [A]	n _N [1/min]	k _T [Nm/A]	M _{max} [Nm]	I _{max} [A]	L _{tt} [mH]	R _{tt} [Ω]	n _{max} [1/min]	J [kgcm ²]	L [mm]	L1 [mm]	L2 [mm]	L _{BR} [mm]	m [kg]
DT5-3-10-RxO-5000	2.4	2.1	1.7	0.8	1.5	4500	1.14	10	10	35	6.8	5000	1.72	157	69	16	192	4.4
DT5-3-10-ExO-5000														200	102	59	235	4.8
DT5-3-10-FxO-5000														200	102	59	235	4.8
DT5-5-10-RxO-5000	4.5	3.8	3.3	1.2	2.8	3500	1.16	20	20	15	2.7	5000	3.05	187	69	16	222	4.9
DT5-5-10-ExO-5000														230	102	59	265	5.4
DT5-5-10-FxO-5000														230	102	59	265	5.4
DT5-9-10-RxO-4000	8.4	5.7	6	1.9	4.1	3000	1.47	41	33	11	1.8	4000	7.4	247	69	16	282	7.4
DT5-9-10-ExO-4000														290	102	59	325	7.9
DT5-9-10-FxO-4000														290	102	59	325	7.9

Dimensions

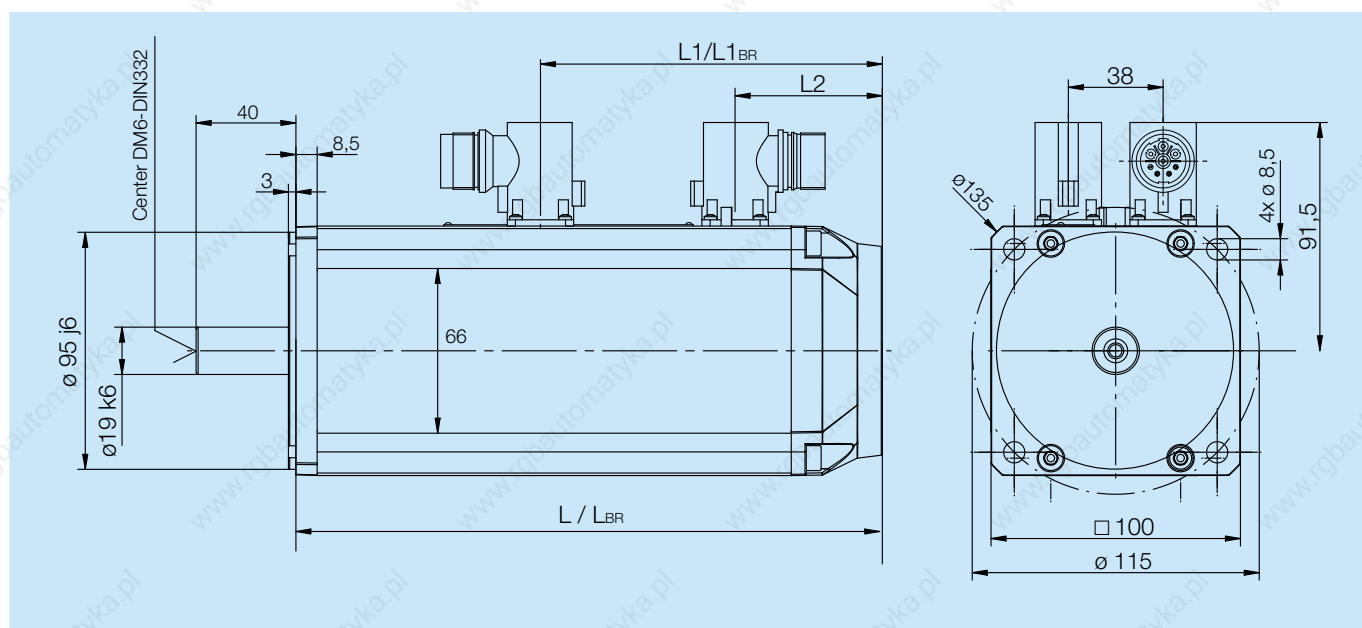

Bearing service life (L10h)

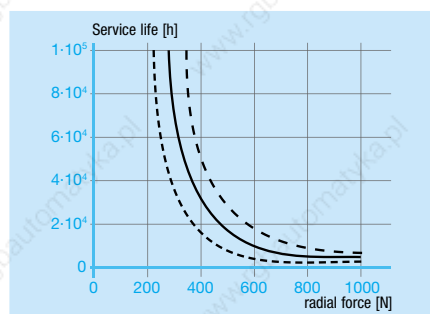

DT5-3-10-xxO-5000-B5

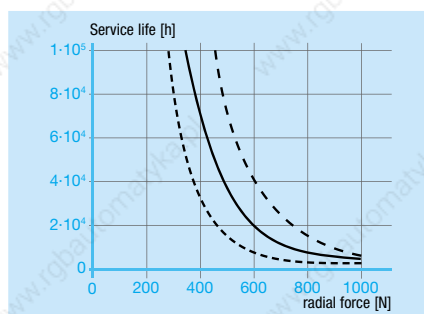

DT5-5-10-xxO-5000-B5

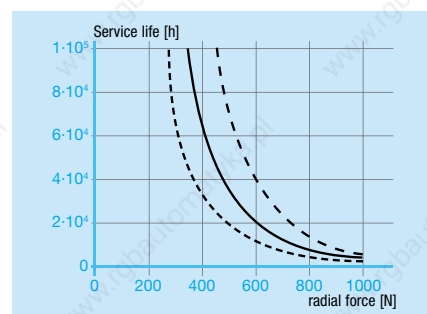

DT5-9-10-xxO-5000-B5

See the fold-out section on the back page for a key. All dimensions are given in mm.

DT6 convection-cooled servo motors

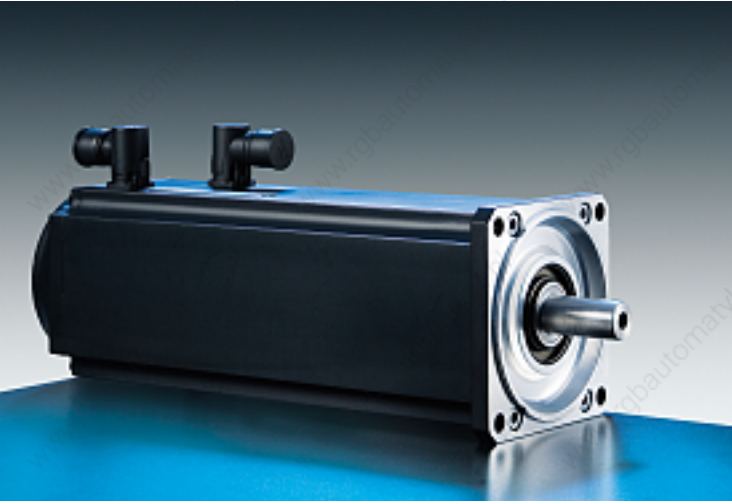

Features

- High power density
- Maximum dynamic response with acceleration values of up to 42,000 rad/s²

Applications

- Positioning and actuating drive for drive tasks with or without gearbox
- Variable-speed drive for continuous running

Equipment

	Standard	Option
Brake	–	12 Nm
Encoder	Resolver	E, F encoder
Shaft	Smooth	Shaft key DIN6885 A8x7x36

Connection cable: Copper conductor rated cross-section 1.5 mm², power connector size 1

Characteristics

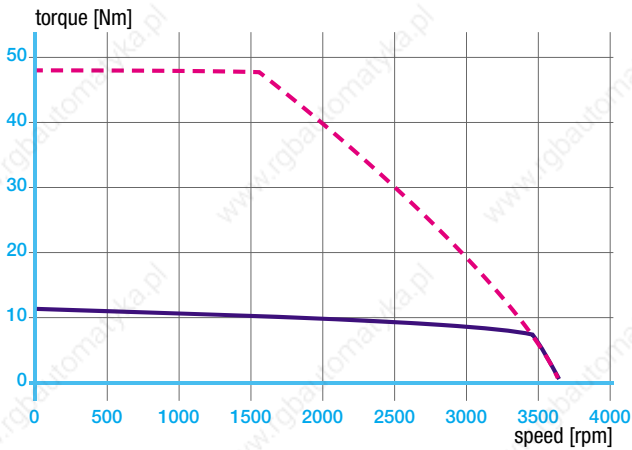

DT6-13-10-xxO-3500-B5

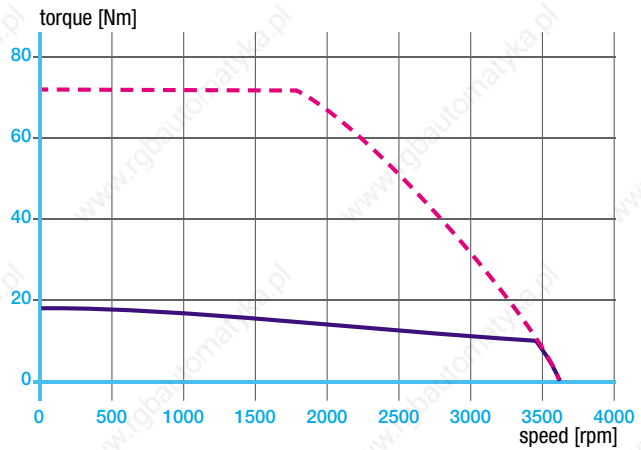

DT6-20-10-xxO-3500-B5

Technical data

Motor type	Standstill data		Rating					Maximum data		Electr. data		Mechanical data				
	M ₀ [Nm]	I ₀ [A]	M _N [Nm]	P _N [kW]	I _N [A]	n _N [1/min]	k _T [Nm/A]	M _{max} [Nm]	I _{max} [A]	L _{tt} [mH]	R _{tt} [Ω]	n _{max} [1/min]	J [kgcm ²]	L [mm]	LBR [mm]	m [kg]
DT6-13-10-RxO-3500	11	9.0	7.9	2.5	6.5	3000	1.22	47	46	7.5	0.98	4000	11.3	285	315	12.2
DT6-20-10-RxO-3500	17	13.6	11	3.4	8.7	3000	1.25	72	67	4.5	0.51	4000	21.4	345	375	17

Dimensions

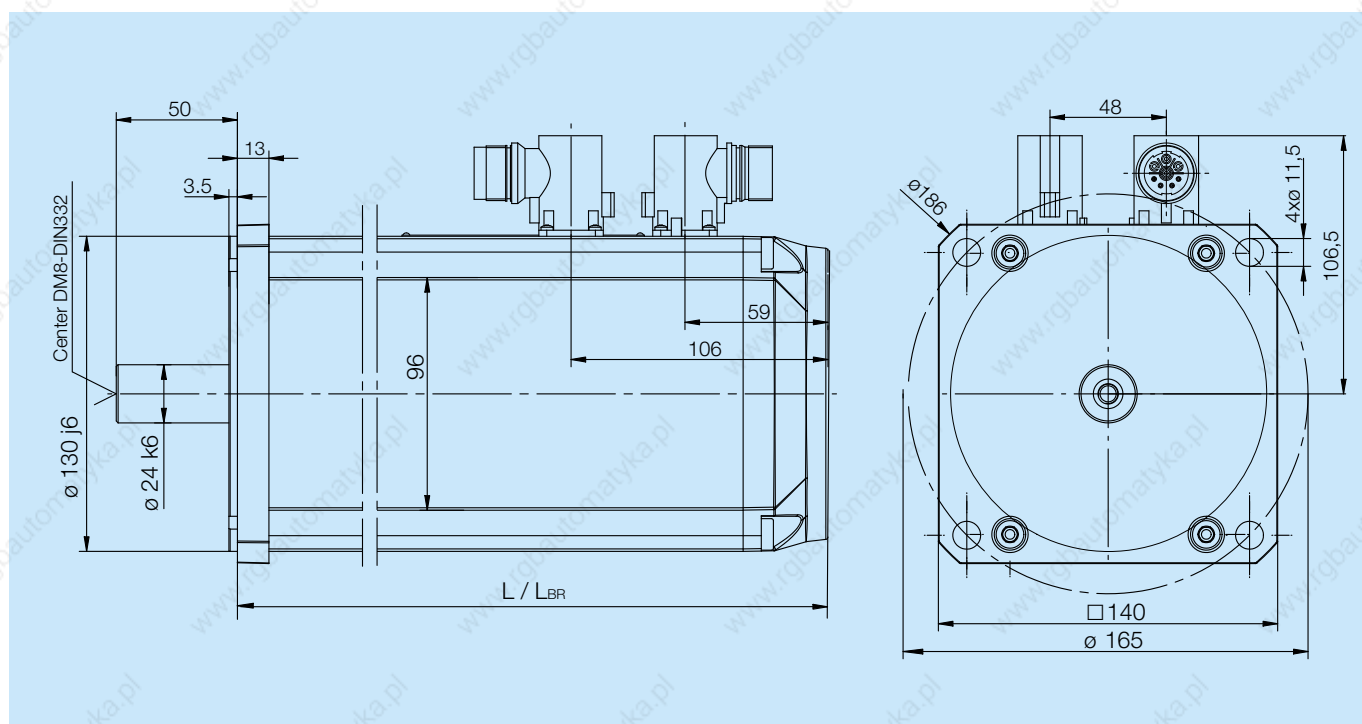

Bearing service life (L10h)

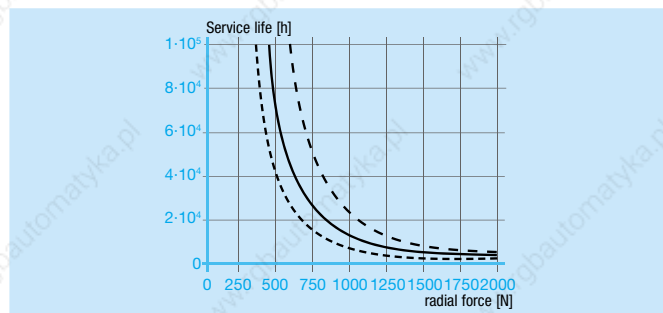

DT6-13-10-xxO-3500-B5

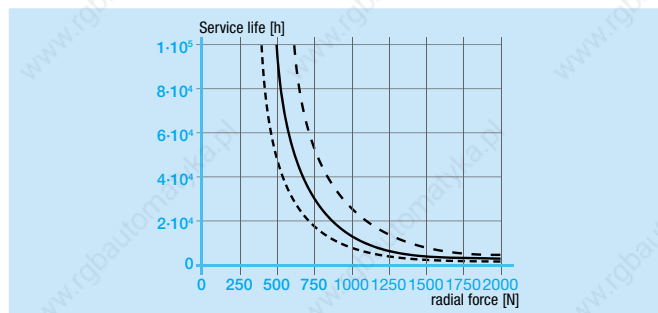

DT6-20-10-xxO-3500-B5

DT7 convection-cooled servo motors

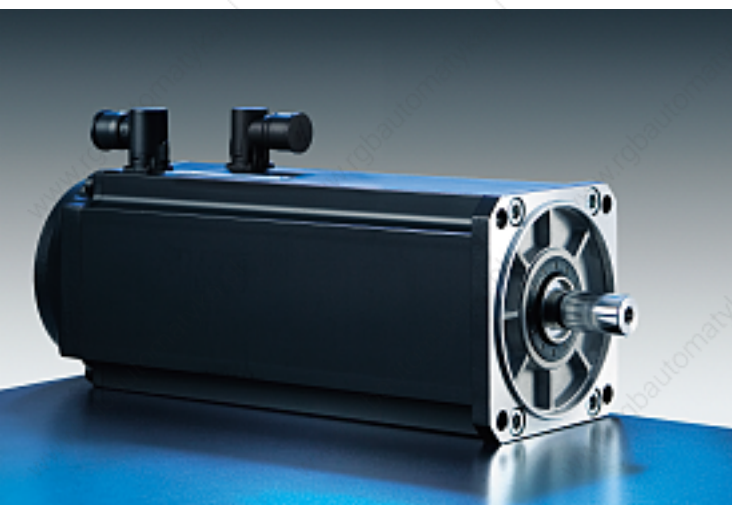

Features

- High standstill torques
- High overload capacity with no real saturation effect
- Extremely rigid mechanical construction

Applications

- Direct drive for positioning and actuating tasks without gearbox or with low reduction ratio for intermittent operation
- Drive suitable for large load inertias
- Variable-speed drive for continuous running at low and medium speeds

Equipment

	Standard	Option
Brake	–	18 Nm
Encoder	Resolver	E, F encoder
Shaft	Smooth	Shaft key DIN6885 A8x7x36

Connection cable: Copper conductor rated cross-section 1.5 mm², power connector size 1

Characteristics

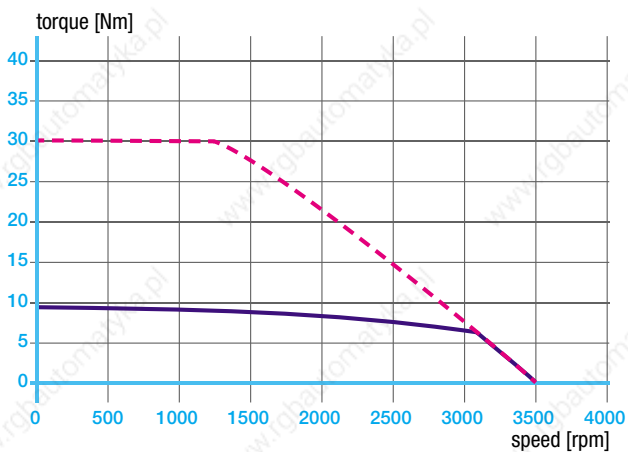

DT7-11-20-xxO-3500-B5

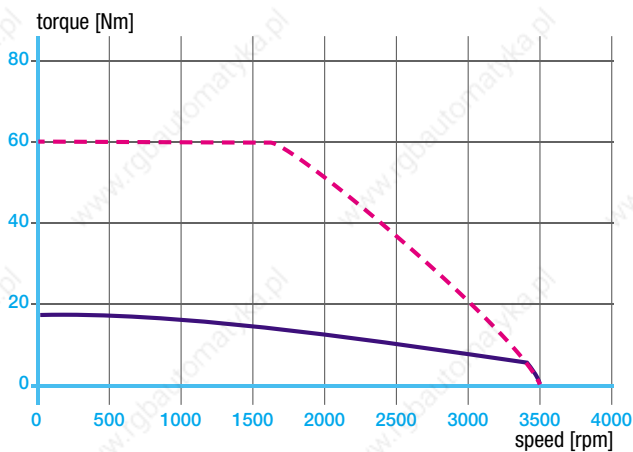

DT7-17-20-xxO-3500-B5

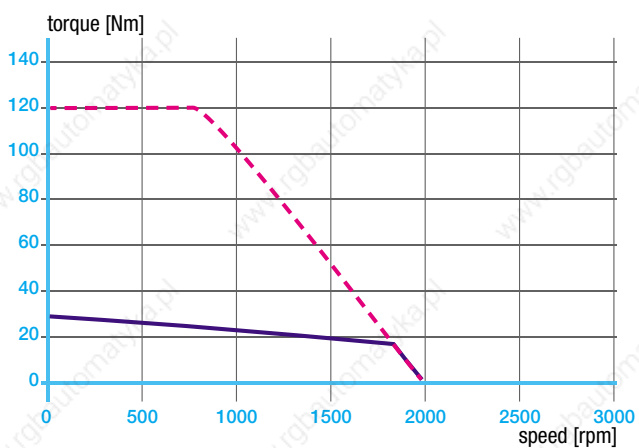

DT7-28-20-xxO-2000-B5

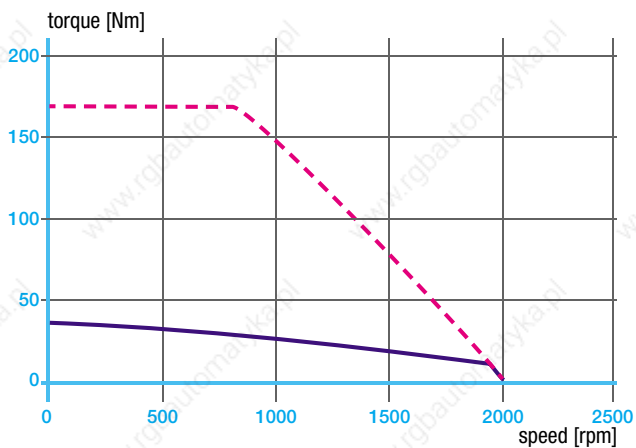

DT7-40-20-xxO-2000-B5

Technical data

Motor type	Standstill data		Rating					Maximum data		Electr. data		Mechanical data				
	M_o [Nm]	I_o [A]	M_N [Nm]	P_N [kW]	I_N [A]	n_N [1/min]	k_T [Nm/A]	M_{max} [Nm]	I_{max} [A]	L_{tt} [mH]	R_{tt} [Ω]	n_{max} [1/min]	J [kgcm ²]	L [mm]	L_{BR} [mm]	m [kg]
DT7-11-20-RxO-3500	10	6.6	6.6	1.9	4.4	2800	1.51	30	20	8.4	2.48	4000	16.9	204	233	9.3
DT7-17-20-RxO-3500	17	11.3	11	2.8	7.2	2500	1.50	60	50	4.1	0.97	4000	33.0	234	263	14.2
DT7-28-20-RxO-2000	28	10.4	19	3	7.2	1500	2.68	120	46	6	1.2	4000	57.0	294	323	18.9
DT7-40-20-RxO-2000	42	15.2	29	3	10.5	1000	2.76	170	100	3.1	0.68	3500	85.0	354	383	25.4

Dimensions

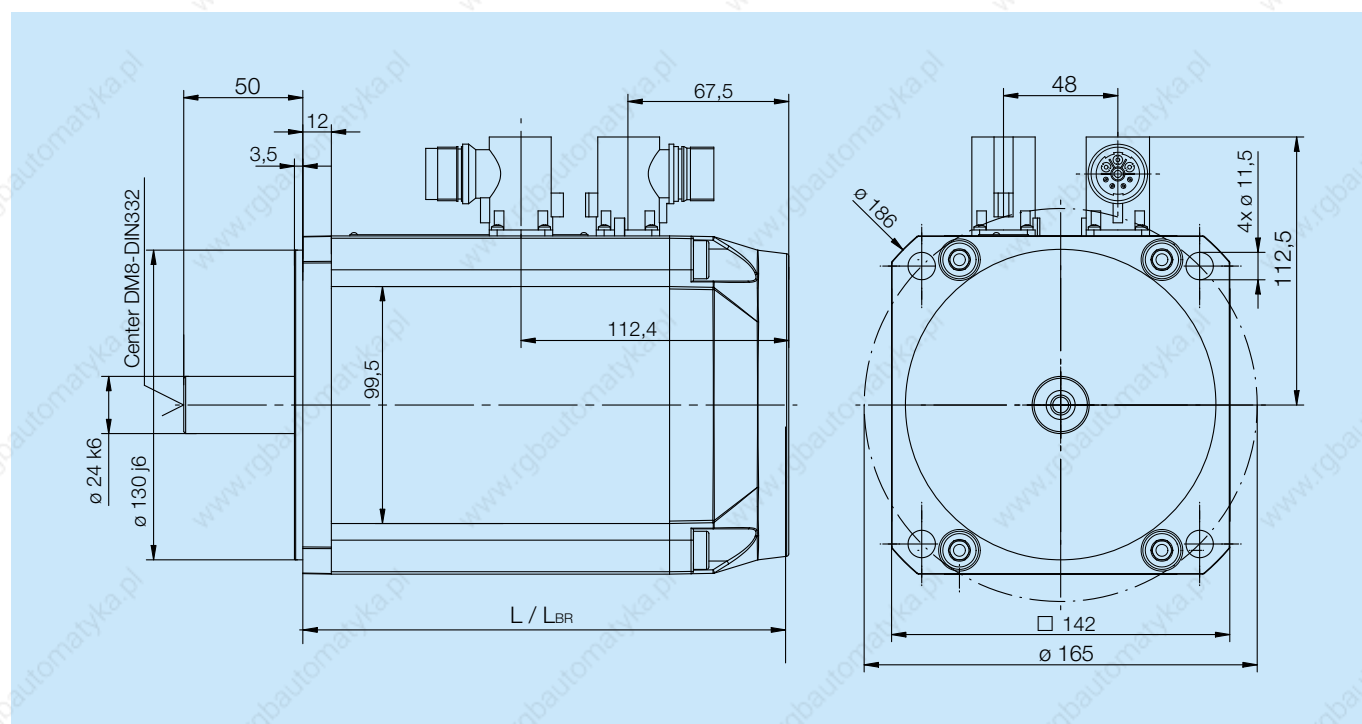

Bearing service life (L10h)

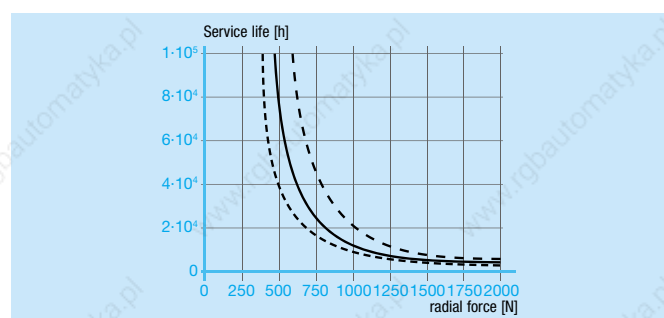

DT7-11-20-xxO-3500-B5 · DT7-17-20-xxO-3500-B5

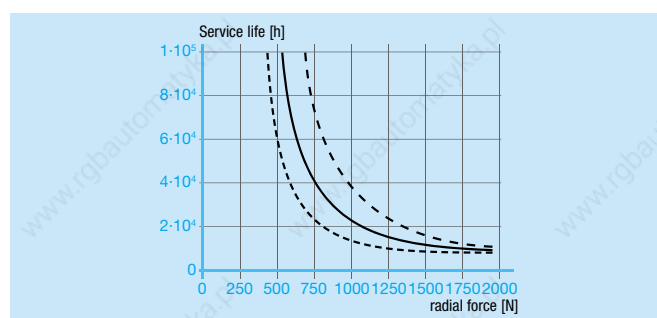

DT7-28-20-xxO-2000-B5 · DT7-40-20-xxO-2000-B5

DT10 convection-cooled servo motors



Features

- High standstill torques
- High overload capacity with no real saturation effect
- Extremely rigid mechanical construction

Applications

- Direct drive for positioning and actuating tasks without gearbox or with low reduction ratio for intermittent operation
- Drive suitable for large load inertias
- Variable-speed drive for continuous running

Equipment

	Standard	Option
Brake	–	120 Nm
Encoder	Resolver	E, F encoder
Shaft	Smooth	Shaft key DIN6885 A10x8x60

Connection cable: Copper conductor rated cross-section 6 mm², power connector size 1.5

Characteristics

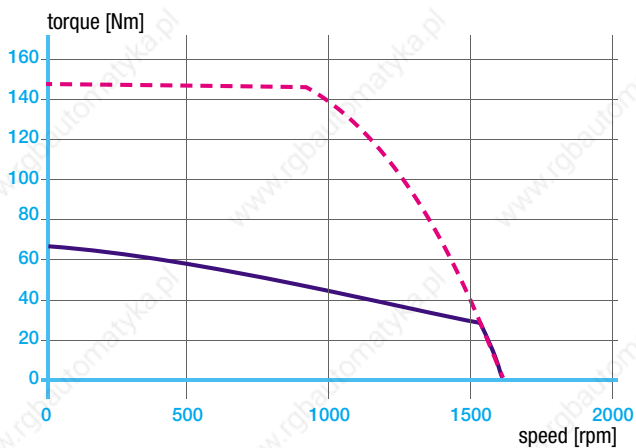

DT10-54-20-xxO-1500-B5

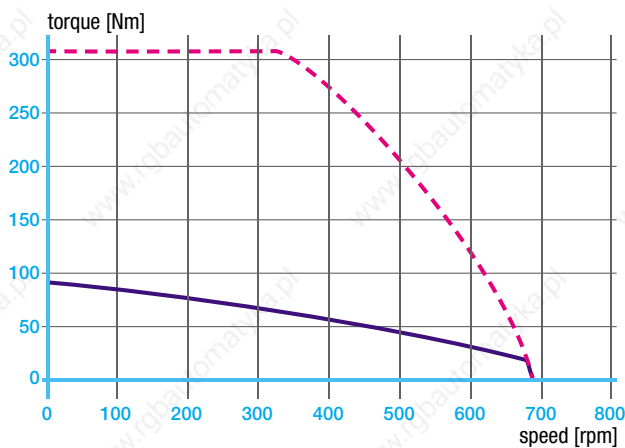

DT10-95-20-xxO-700-B5

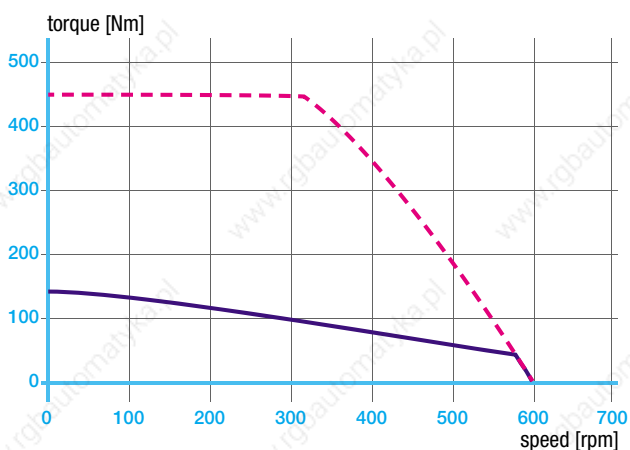

DT10-125-20-xxO-650-B5

Technical data

Motor type	Standstill data		Rating					Maximum data		Electr. data		Mechanical data				
	M_o [Nm]	I_o [A]	M_N [Nm]	P_N [kW]	I_N [A]	n_N [1/min]	k_T [Nm/A]	M_{max} [Nm]	I_{max} [A]	L_{tt} [mH]	R_{tt} [Ω]	n_{max} [1/min]	J [kgcm ²]	L [mm]	LBR [mm]	m [kg]
DT10-54-20-RxO-1500	66	17	45	4.7	11.6	800	3.9	150	60	6.4	0.6	2000	175	300	360	42
DT10-95-20-RxO-700	95	12.8	54	3.4	7.3	600	7.4	310	33	11.4	1.1	2000	310	420	420	61
DT10-125-20-RxO-600	125	13.3	60	3.1	6.3	500	9.4	430	67	12.8	1.1	1000	440	540	600	75

Dimensions

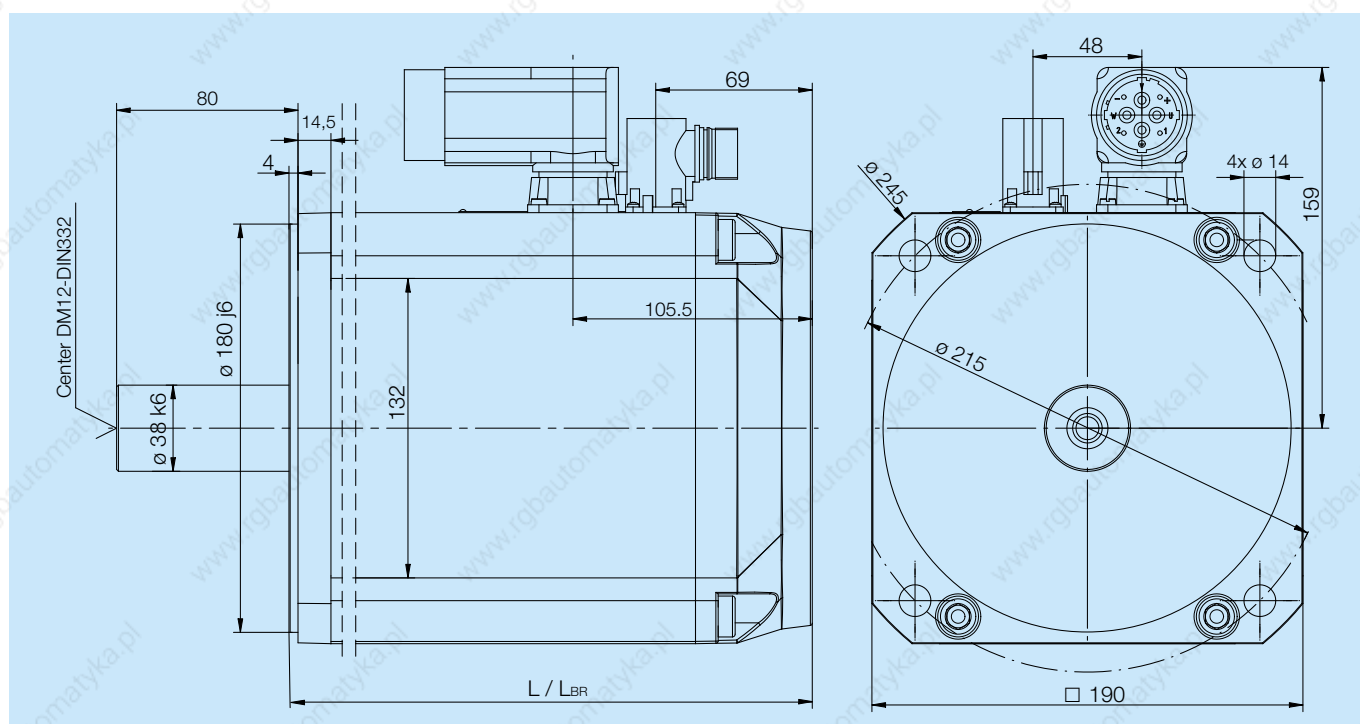

Bearing service life (L10h)

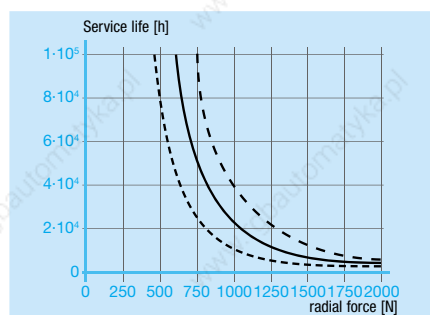

DT10-54-20-xxO-1500-B5

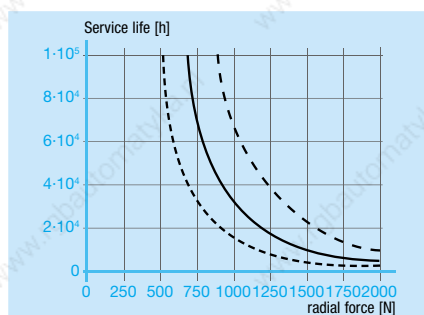

DT10-95-20-xxO-700-B5

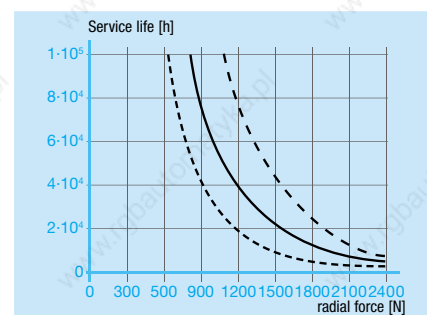

DT10-125-20-xxO-600-B5

DT5 liquid-cooled servo motors

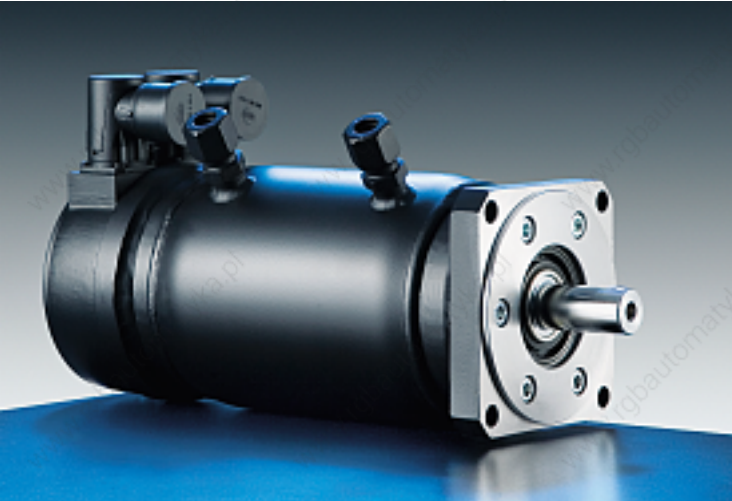

Features

- High standstill torques
- Maximum torque and power density
- Maximum dynamic response even at very short repetitive cycles

Applications

- Positioning and actuating drive for drive tasks with extremely high dynamic response and power density requirements
- Variable-speed drive for continuous running
- For applications running under difficult cooling conditions due to a high integration density, contamination or ambient temperature conditions

Equipment

	Standard	Option
Brake	-	12 Nm
Encoder	Resolver	E, F encoder
Shaft	Smooth	Shaft key DIN6885 A6x6x30

Connection cable: DT 5-15 = 2,5mm² · DT 5-23 = 4mm²
power connector size 1

Characteristics

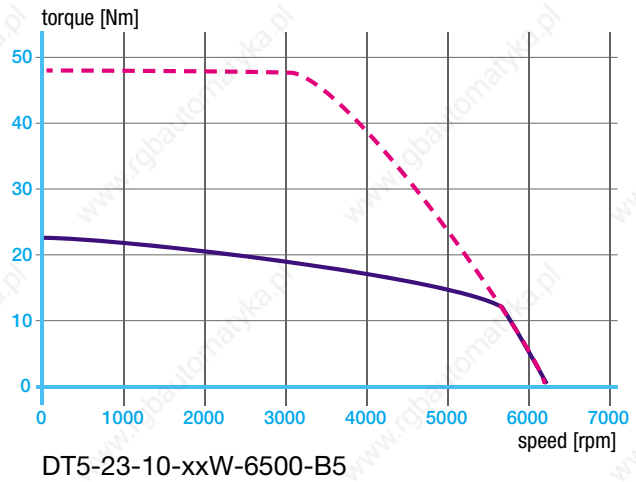
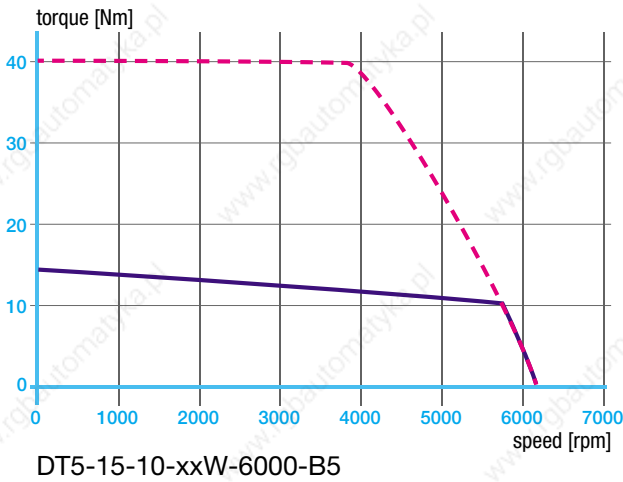

Technical data

Motor type	Standstill data		Rating					Maximum data		Electr. data		Mechanical data							
	M ₀ [Nm]	I ₀ [A]	M _N [Nm]	P _N [kW]	I _N [A]	n _N [1/min]	k _T [Nm/A]	M _{max} [Nm]	I _{max} [A]	L _{tt} [mH]	R _{tt} [Ω]	n _{max} [1/min]	J [kgcm ²]	L [mm]	L1 [mm]	L3 [mm]	L _{BR} [mm]	L1 _{BR} [mm]	m [kg]
DT5-15-10-RxW-6000	15	14.5	13	5.8	12	4500	1.03	40	45	5.6	0.93	6300	7.4	235	20	29	295	50	14
DT5-23-10-RxW-6500	23	25.6	13.5	7.1	15	5000	0.9	47	67	2.9	0.45	6300	10.6	295	20	89	355	50	17

Dimensions

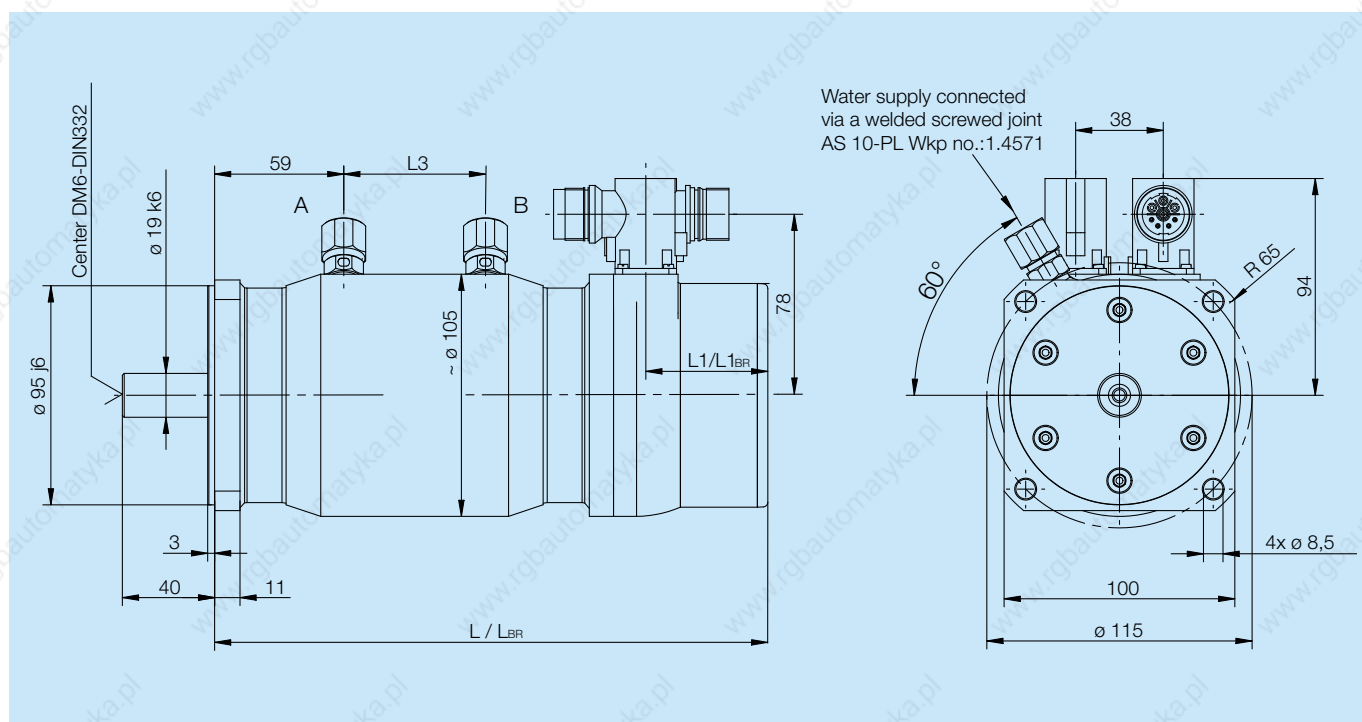

Cooling

- Ermeto-Water connection AS10-PL, 10 mm pipe connection
- Cooling liquid minimum 2,0 l/min; max. inlet temperature 40°C
- Cooling inlet temperature should not go below room temperature

Bearing service life (L10h)

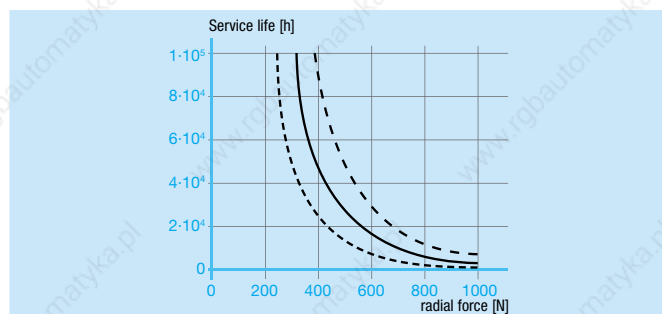

DT5-15-10-xxW-5000-B5

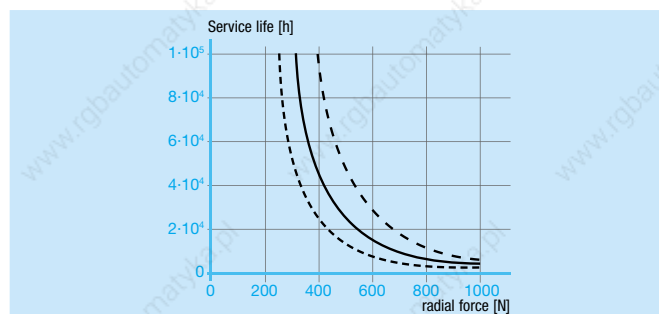

DT5-23-10-xxW-4500-B5

DT7 liquid-cooled servo motors

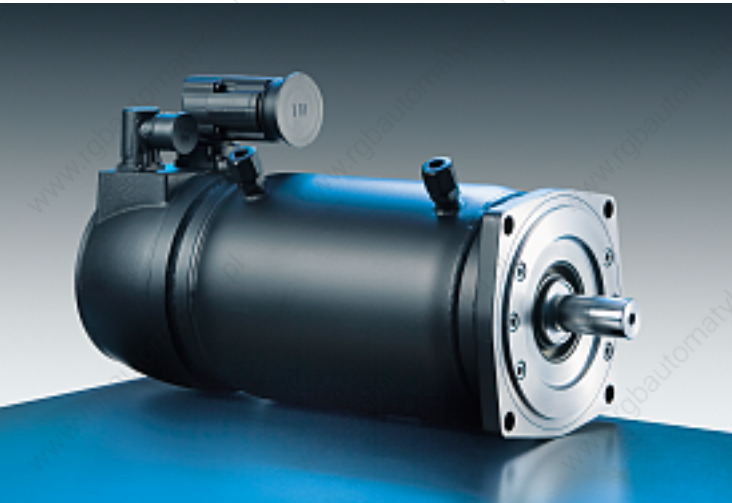

Features

- Excellent standstill torques
- Excellent torque and power density
- High power at low speeds

Applications

- Positioning and actuating drive for drive tasks with extremely high dynamic response and power density requirements
- Variable-speed drive for continuous running
- For applications running under difficult cooling conditions due to a high integration density, contamination or ambient temperature conditions

Equipment

	Standard	Option
Brake	–	18 Nm
Encoder	Resolver	E, F encoder
Shaft	Smooth	Shaft key DIN6885 A10x8x36

Connection cable: Copper conductor rated cross-section 10 mm², power connector size 1.5

Characteristics

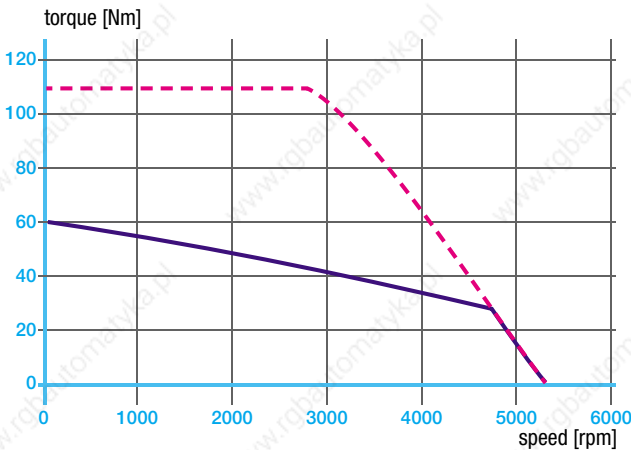

DT7-55-20-xxW-5200-B5

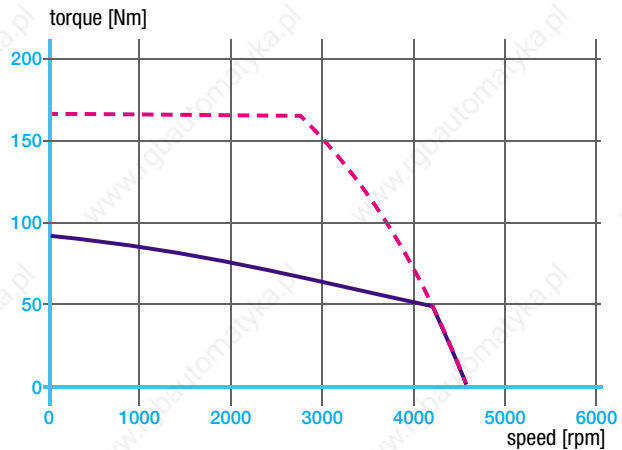

DT7-72-20-xxW-5000-B5

Technical data

Motor type	Standstill data		Rating					Maximum data		Electr. data		Mechanical data							
	M_o [Nm]	I_o [A]	M_N [Nm]	P_N [kW]	I_N [A]	n_N [1/min]	k_T [Nm/A]	M_{max} [Nm]	I_{max} [A]	L_{tt} [mH]	R_{tt} [Ω]	n_{max} [1/min]	J [kgcm ²]	L [mm]	L_1 [mm]	L_3 [mm]	L_{BR} [mm]	L'_{BR} [mm]	m [kg]
DT7-55-20-RxW-5200	60	60	38	14	38	3500	1.0	110	132	0.99	0.16	5000	57	290	50	108	335	94	21
DT7-72-20-RxW-5000	88	55	57	18	42	3000	1.6	170	135	0.83	0.2	5000	85	350	50	152	395	94	25

Dimensions

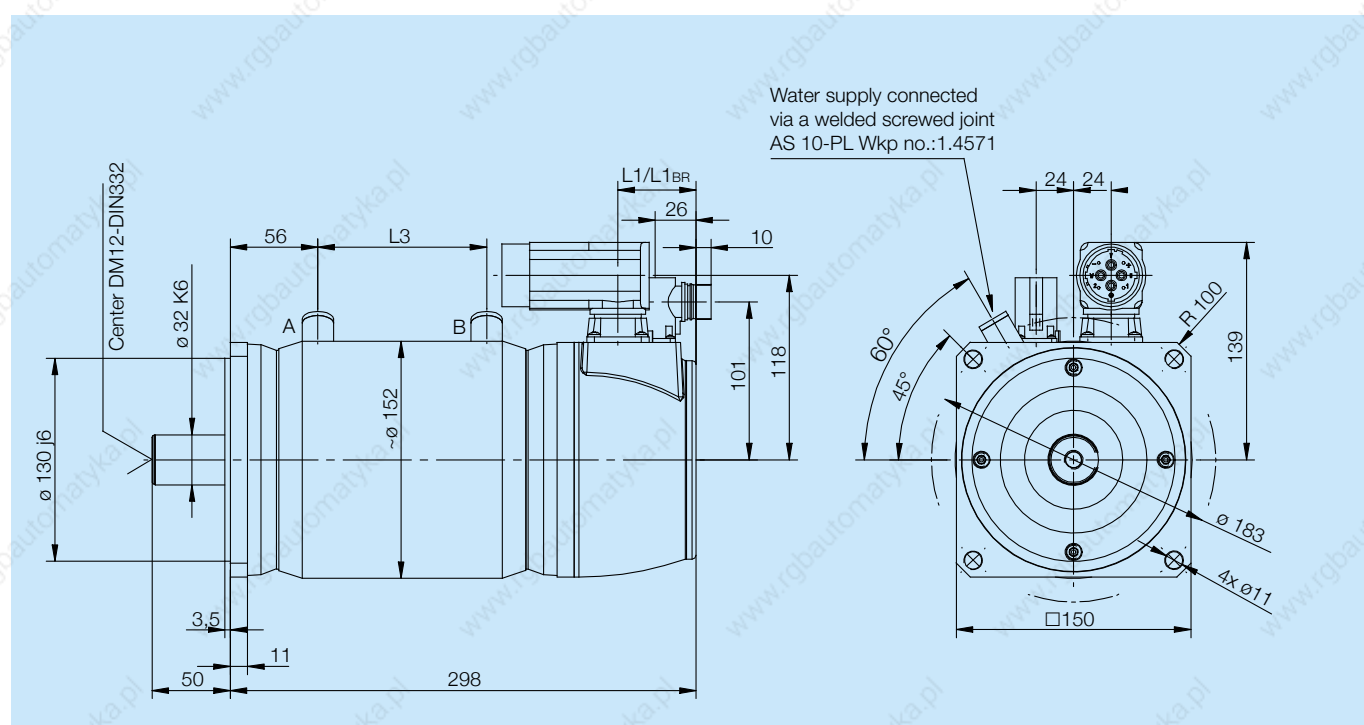

Cooling

- Ermeto-Water connection AS10-PL, 10 mm pipe connection
- Cooling liquid minimum 2,0 l/min; max. inlet temperature 40°C
- Cooling inlet temperature should not go below room temperature

Bearing service life (L10h)

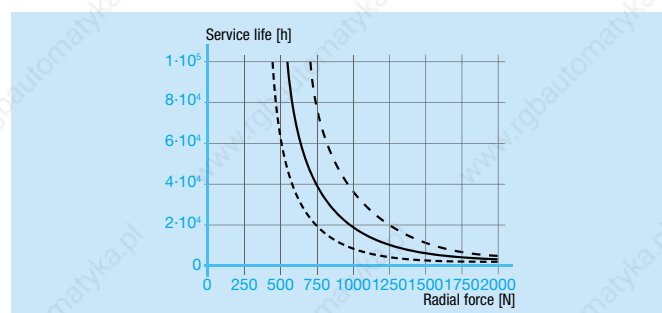

DT7-55-20-xxW-5200-B5

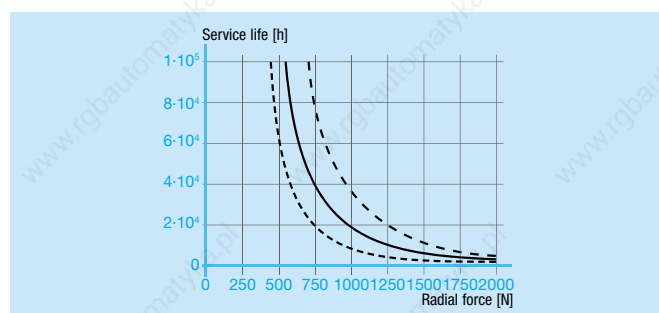

DT7-72-20-xxW-5000-B5

DT10 liquid-cooled servo motors



Features

- Excellent standstill torques
- Excellent torque and power density
- High power at low speeds

Applications

- Positioning and actuating drive for drive tasks with extremely high dynamic response and power density requirements
- Variable-speed drive for continuous running at low and medium speeds
- For applications running under difficult cooling conditions due to a high integration density, contamination or ambient temperature conditions

Equipment

	Standard	Option
Brake	–	120 Nm
Encoder	Resolver	E, F encoder
Shaft	Smooth	Shaft key DIN6885 A10x8x60

Connection cable: Copper conductor rated cross-section 16 mm², power connector size 1.5

Characteristics

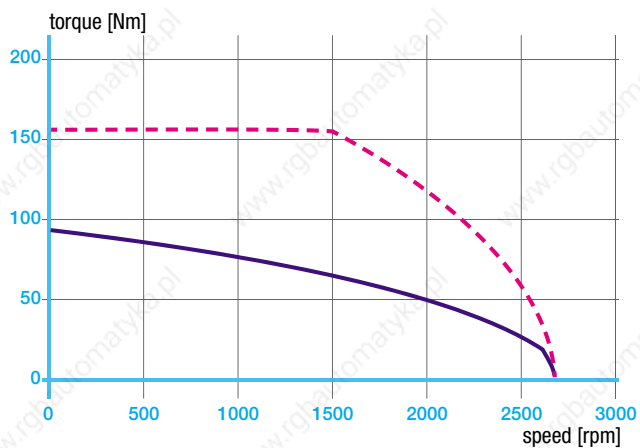

DT10-100-20-xxW-3000-B5

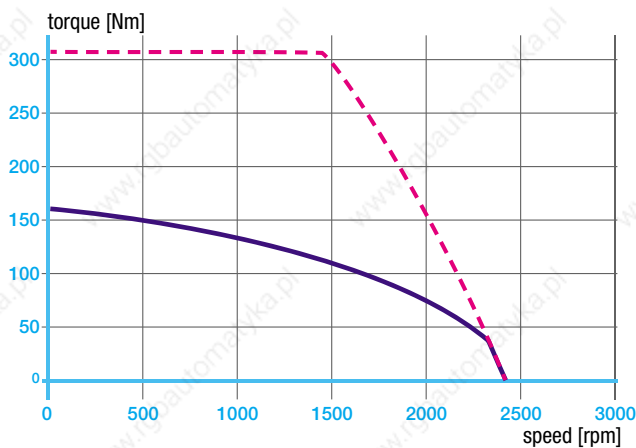

DT10-145-20-xxW-2000-B5

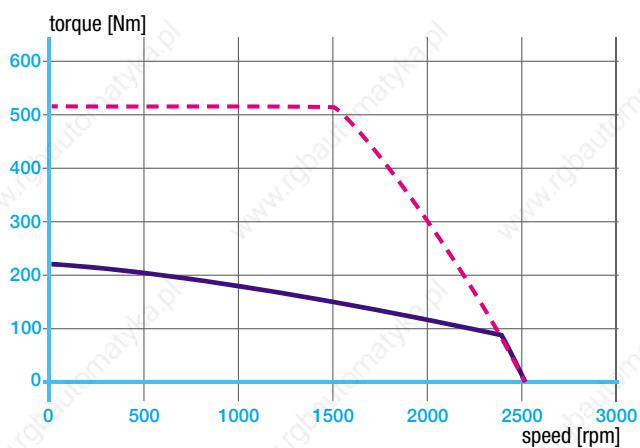

DT10-200-20-xxW-2500-B5

Technical data

Motor type	Standstill data		Rating					Maximum data		Electr. data		Mechanical data							
	M ₀ [Nm]	I ₀ [A]	M _N [Nm]	P _N [kW]	I _N [A]	n _N [1/min]	k _T [Nm/A]	M _{max} [Nm]	I _{max} [A]	L _{tt} [mH]	R _{tt} [Ω]	n _{max} [1/min]	J [kgcm ²]	L [mm]	L1 [mm]	L3 [mm]	LBR [mm]	L1BR [mm]	m [kg]
DT10-100-20-RxW-3000	95	54.2	66	11	38	1500	1.75	160	132	1.53	0.165	6000	175	300	56.5	103	360	117.5	43
DT10-145-20-RxW-2000	160	66.6	120	18	50	1500	2.4	310	200	1.16	0.11	6000	380	420	56.5	223	480	117.5	64
DT10-200-20-RxW-2500	220	95.5	150	23.5	65	1500	2.3	520	330	0.67	0.07	3000	440	540	56.5	343	600	117.5	83

Dimensions

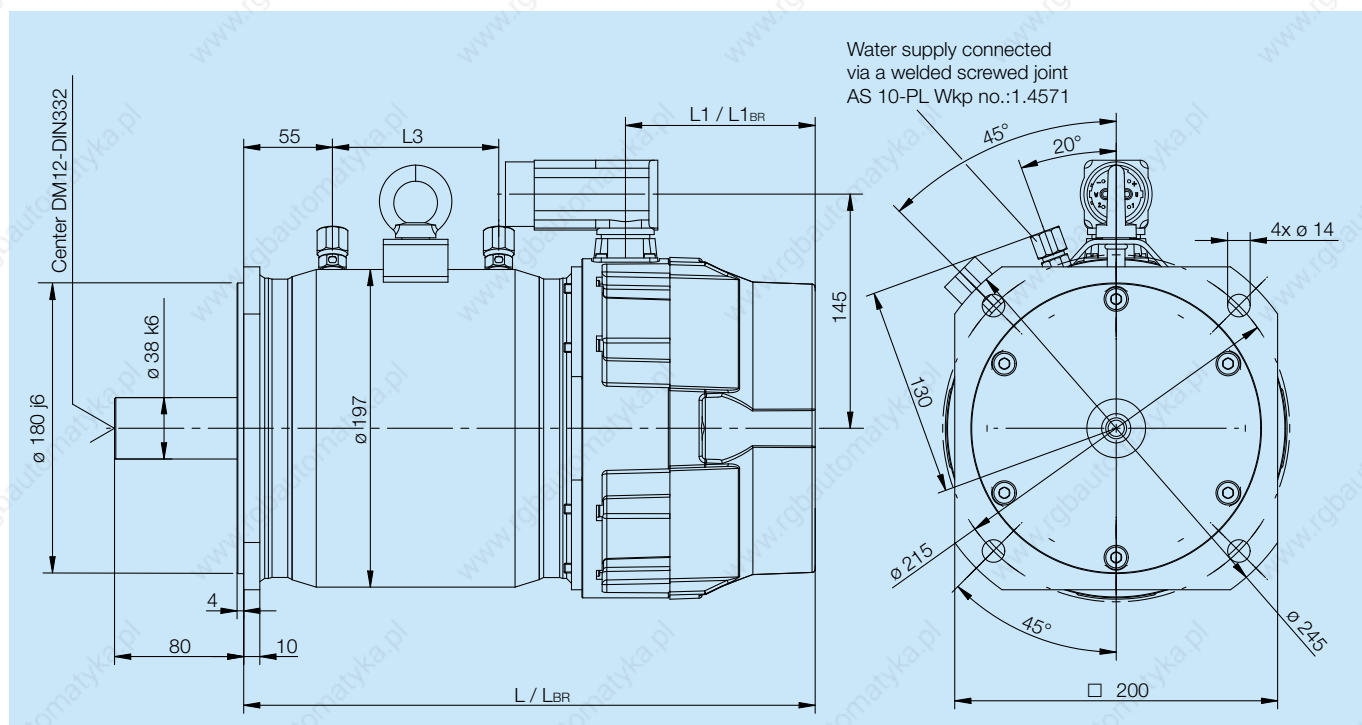

Cooling

- Ermeto-Water connection AS10-PL, 10 mm pipe connection
- Cooling liquid minimum 2,0 l/min; max. inlet temperature 40°C
- Cooling inlet temperature should not go below room temperature

Bearing service life (L10h)

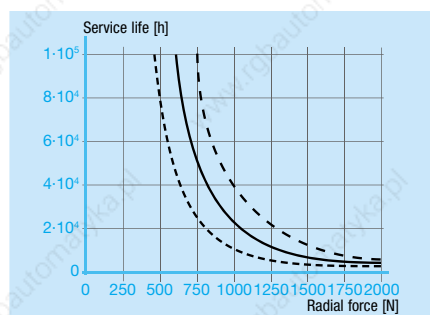

DT10-100-20-xxW-3000-B5

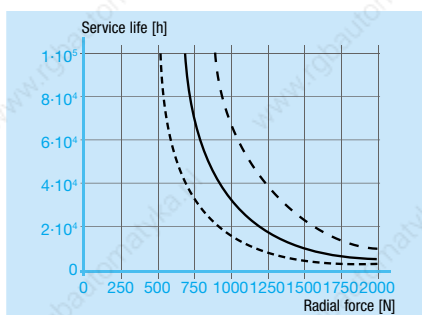

DT10-145-20-xxW-2000-B5

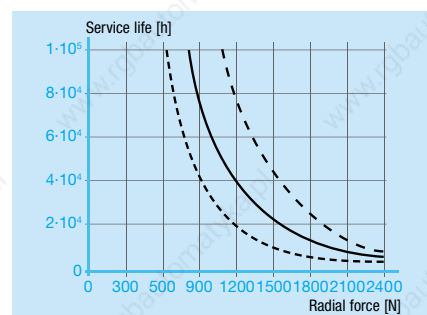

DT10-200-20-xxW-2500-B5

Position encoder

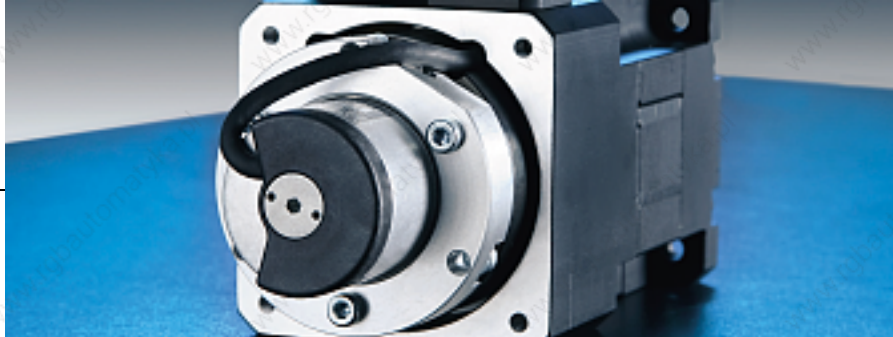

Encoder overview

The motors can be fitted with various position encoders.

Type	Design	Max. speed [rpm]
R	Resolver	15000
E, F	Optical absolute encoder 512 cycles/revolution EnDAT interface, version 2.1 E = single-turn; F = multi-turn 4096 revolutions max.	12000

Connector pin assignment on motor side

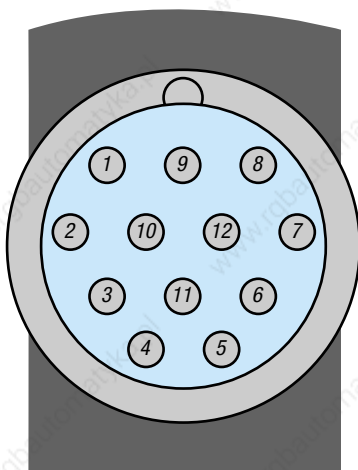

View from outside on pins of motor connector

PIN Motor connector	Resolver	E/F encoder	
	Signal	Signal	Meaning
1	+ sin	G2N	Channel 2 not inverted
2	- sin	G2I	Channel 2 inverted
3	+cos	G1N	Channel 1 not inverted
4	- cos	G1I	Channel 1 inverted
5	-	05P	Supply 5 V DC, max. 250 mA
6	-	GND	Reference for supply
7	-	CLK+	EnDat encoder interface
8	-	CLK-	EnDat encoder interface
9	+ Uref	DAT+	EnDat encoder interface
10	- Uref	DAT-	EnDat encoder interface
11	-	05P	Supply 5 V DC, max. 250 mA
12	-	GND	Reference for supply
Shield	Connector housing		



Encoder cable

Pre-fabricated cables are available for connecting the position encoder to the KE/KW or KU series servo controllers. The shielded pair cables are available in any length in complete meters up to a maximum of 100 m.

Properties

Sheath: Polyurethane, TPE core

Trailing cable properties:

- Min. bending radius 100 mm
- Max. speed 1m/s
- Max. acceleration 4m/s²
- 5 million bending cycles

Motor side

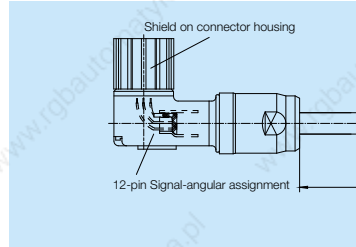

Device side

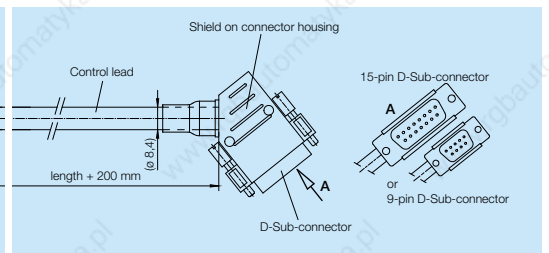
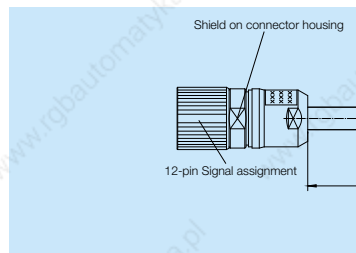
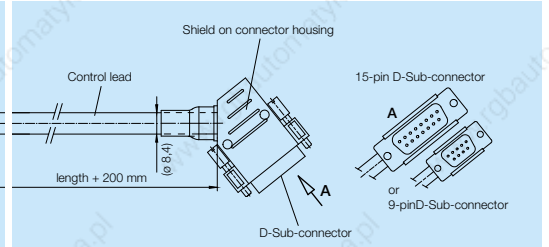

Connector pin assignment on encoder side

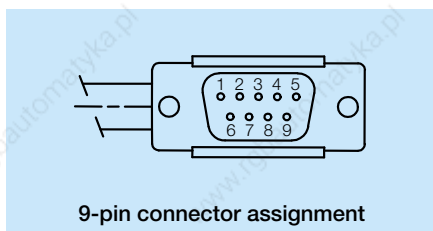
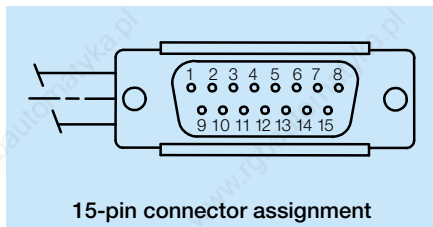

View on pins from outside on cable connector

Connector pin assignment Motor side	Connector pin assignment on device side			
	Resolver		E/F encoder	
	9-pin D-sub		15-pin D-sub	
	Signal	PIN	Signal	PIN
1	+ sin	3	G2N	6
2	- sin	4	G2I	5
3	+ cos	5	G1N	4
4	- cos	6	G1I	3
5	-	-	O5P	13
6	-	-	GND	8
7	-	-	CLK+	12
8	-	-	CLK-	11
9	+ Uref (R1)	7	DAT+	10
10	- Uref (R2)	8	DAT-	9
11	-	-	O5P	7
12	-	-	GND	14
Shield	Connector housing			

Encoder cable order designation

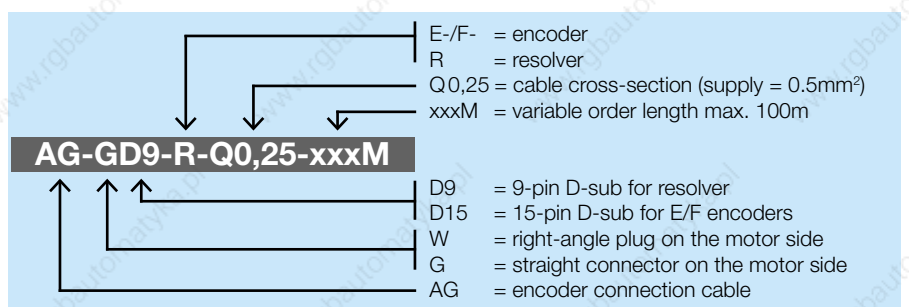

Holding brake

The motors can be fitted with a holding brake as an option. This is **not** suitable for use as an operational brake. The brakes are released with 24 V of unfiltered DC voltage.

Note: The maximum brake speed must also be taken into account when considering the maximum motor speed.



Series	Holding brake						
	MBR [Nm]	UBR [V]	IBR [A]	JBR [kgcm ²]	n _{maxBR} [1/min]	T _{ein} [ms]	T _{aus} [ms]
DT3	1.1	24	0.2	0.01	10000	35	55
DT4	4.5	24	0.4	0.064	7000	35	55
DT5	12	24	0.7	0.313	6000	30	60
DT6	12	24	0.7	0.313	6000	30	60
DT7	18	24	0.8	0.376	6000	30	70
DT10	120	24	0.8	0.376	6000	30	70

Power cable

Pre-fabricated cables with power connectors and various cable cross-sections are available for the power supply, temperature sensor and brake. The cable sheathing is removed from the ends of the wires on the device side. The cables are available in any length measured in complete meters.

Properties:

Sheath: Polyurethane, TPE core

Trailing cable properties:

- Min. bending radius: 12 x external cable diameter



Connector pin assignment and power cable size 1

PIN	Terminal
A	Temperature sensor
B	Temperature sensor
C	Brake +
D	Brake 0 V
1	Motor phase u
3	Motor phase w
4	Motor phase v
⊥	Protective conductor

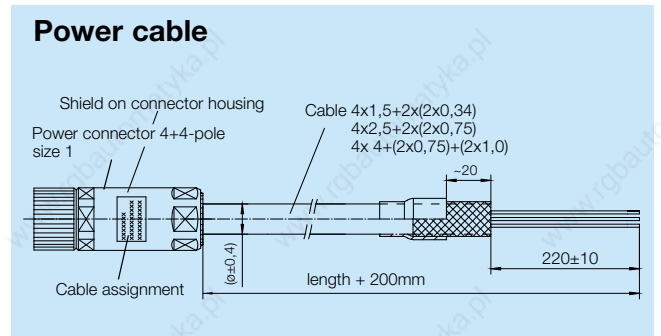
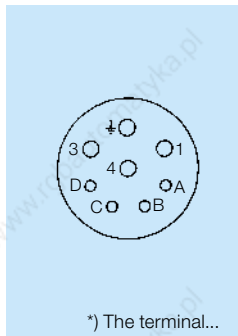

Connector pin assignment and power cable size 1.5

PIN	Terminal
u	Motor phase u
v	Motor phase v
w	Motor phase w
1	Temperature sensor
2	Temperature sensor
+	Brake + 24 V
-	Brake 0 V
⊥	Protective conductor

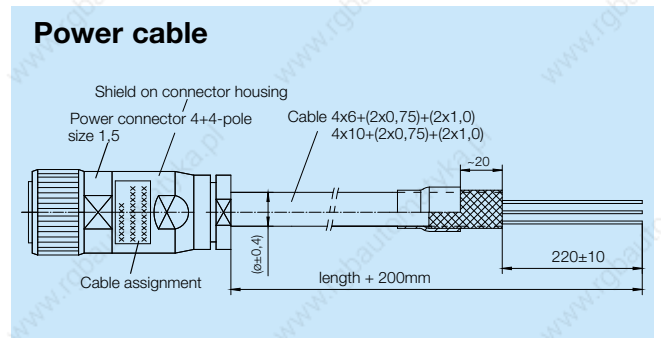
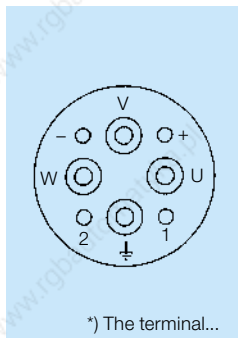

Power cable order designation

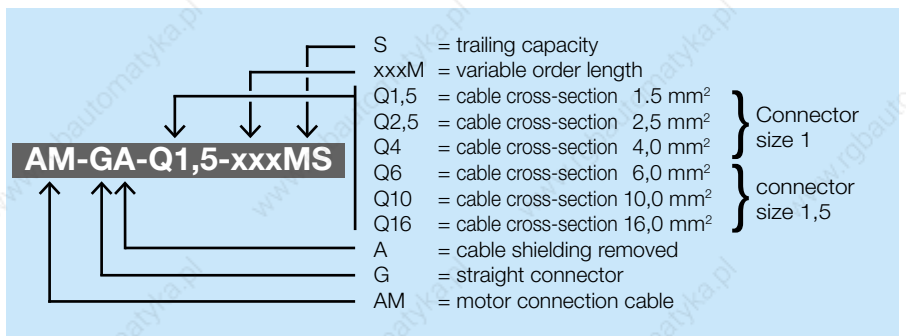

*) Pinout is as shown from outside on motor connector.

The terminal assignment is as shown on the motor mounting box. All dimensions are given in mm.

Control your Motion.



AMK

AMK Arnold Müller GmbH & Co. KG

Drives and Controls

Postfach 13 55

D-73221 Kirchheim/Teck

Gaußstraße 37-39

D-73230 Kirchheim/Teck

Phone: +49 (0) 70 21/50 05-0

Fax: +49 (0) 70 21/50 05-199

info@amk-antriebe.de

www.amk-antriebe.de

Abbreviation

Symbol	Unit	Meaning
M_o	Nm	Continuous standstill torque
I_o	A	Continuous standstill current
M_N	Nm	Rated torque
P_N	kW	Rated power
I_N	A	Rated current
n_N	1/min	Rated speed
k_T	Nm/A	Torque constant ($M=I \cdot k_T$)
M_{max}	Nm	Maximum torque
I_{max}	A	Maximum current
L_{tt}	mH	Terminal inductance
R_{tt}	Ω	Terminal resistance
n_{max}	1/min	Maximum speed
J	kgcm ²	Motor moment of inertia
D_w	mm	Shaft diameter
L	mm	Motor length
$L1$	mm	Distance between power connector and end of motor
$L2$	mm	Distance between encoder connector and end of motor
$L3$	mm	Distance between water supplies
L_{BR}	mm	Length of motor with brake
$L1_{BR}$	mm	Distance between power connector and end of motor with brake
$L2_{BR}$	mm	Distance between encoder connector and end of motor with brake
m	kg	Motor mass
M_{BR}	Nm	Min. static braking torque
U_{BR}	V	Braking voltage
I_{BR}	A	Braking current
J_{BR}	kgcm ²	Perm. brake inertia
n_{maxBR}	1/min	Brake maximum speed
T_{app}	ms	Brake application time
T_{rel}	ms	Brake release time

Legends:

Characteristics:

- - - - - maximum torque
- thermal continuous torque

Bearing service life

- - - - - $0.5 \times n_N$
- n_N
- - - - - $2 \times n_N$

Ambient conditions

Degree of protection in compliance with EN 60529:

IP54 (IP 65 available as an option)

Ambient operating temperature:

0 °C to + 40 °C

Storage/transport temperature:

-25 °C to + 55 °C

Relative humidity:

5% to 80%, without condensation

Installation altitude:

Up to 1000 m a.m.s.l. In the case of altitudes over 1000 m up to max. 2000 m, the ratings must be reduced by 1% per 100 m. (Not for water cooled motors)

General technical data

Ambient temperature:

+5 ... +40 °C. In the case of higher ambient temperatures up to max. 60 °C, the rating must be reduced by 1% per increase in temperature of 1 °K.

Rating:

The rating refers to a winding overtemperature of 80 °K. The motor is checked by means of a thermally insulating flange.

Insulation class:

F in accordance with DIN VDE 0530.

Thermal protection:

PTC thermistor, cold resistance approx. 150 – 800 Ω .

Motor bearings:

Ball bearings lubricated for life

Axial runout, shaft runout:

N in accordance with DIN 42955.

Balance quality:

G 2.5 in accordance with VDI 2056.

Vibrational quality:

N in accordance with DIN ISO 2373.

Paint:

RAL 9005, black matt finish.

Important notes

- During operation, the motors can reach surface temperatures of over 100°C. Therefore, in order to avoid the risk of injury, the surface temperature must be checked before touching the motor.
- On motors with shaft keys, if there is a free-rotating shaft end the key must either be removed or secured to prevent dangerous ejection.
- Before opening the terminal box or removing/inserting a connector from/into the motors, you must make sure that the terminals are not live. Even if the motor is at a standstill, the terminals may still be live. Non-compliance may pose a risk to life and limb.
- There must be a low-resistance connection between the motor and the earthing bar in the control cabinet to ensure finger-safe and fail-safe motor operation.
- The bearings and shaft may sustain damage if the motor shaft is subjected to impact or uncontrolled forces during transport, storage or installation of the motor in the machine.
- Impermissible axial and radial loads will reduce bearing service life. The bearing load diagrams must be observed.
- If couplings are used, their components must be assembled correctly. Bearing and coupling service life may be reduced if the coupling is misaligned or misplaced.
- None of the motors listed here may be directly connected to the mains. The motors are only intended for operation in an inverter system. The data and characteristics given have been verified with AMKASYN KE/KW type inverters.