

Contents	5
Selector Guide	9
Index of Types	17

General Technical Information	19
--------------------------------------	-----------

Data Sheets	41
--------------------	-----------

Mounting Instructions	175
Quality	185
Environmental Protection, Climatic Conditions	191, 193

Taping and Packing	195
Symbols and Terms	201
Subject Index	203



Siemens Matsushita Components

Quality without compromises

top with TQM

We're not satisfied until you are. So our quality demands are quite tough. And they don't start in production, they span the whole field from development to despatch. To watch over it all we implemented Total Quality Management, a system aimed at continuous improvement – in everything. That includes true-to-schedule delivery and service readiness, ISO 9000 for all plants, modern QA, commitment to the environment in manufacturing, materials and packing plus constant training of employees. All embedded in *top*, the worldwide quality campaign of the Siemens organization.



More about "top with TQM" in this brochure!

SCS – dependable, fast and competent

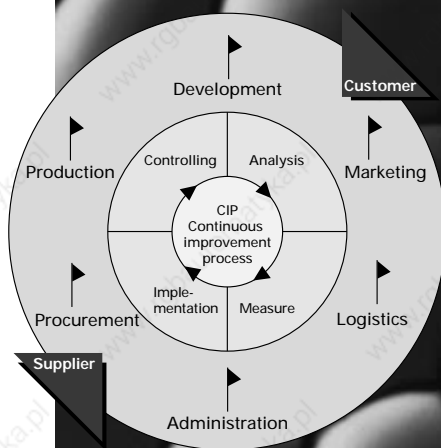
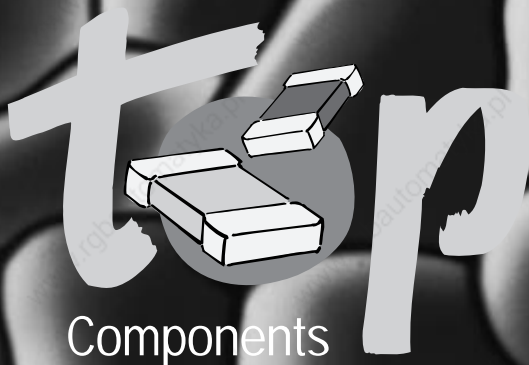

PTC Thermistors



Siemens Matsushita Components

Now twice as many

2,000 PTC thermistors at once

A hot tip in PTCs for overload protection: our new maximum order level of 2,000 pieces. And with more than 50 different models, we've got a lot more to offer too. Maximum operating voltages from 12 to 550 V, rated currents up to 2.5 A, maximum switching currents of 15 A, plus a broad selection of leaded versions and SMDs.



SCS – dependable, fast and competent

Contents

Selector guide	9
Index of types	17
General technical information	19
1 Definition	19
2 Structure and function	19
3 Manufacture	19
4 Characteristics	20
4.1 Unloaded PTC thermistors	20
4.1.1 Temperature dependence of resistance	20
4.1.2 Rated resistance R_N	21
4.1.3 Minimum resistance R_{\min}	21
4.1.4 Reference resistance R_{Ref} at reference temperature T_{Ref}	21
4.1.5 Resistance R_{PTC} at temperature T_{PTC}	22
4.1.6 Temperature coefficient α	22
4.1.7 Nominal threshold temperature T_{NAT}	22
4.2 Electrically loaded PTC thermistors	22
4.2.1 Surface temperature T_{surf}	23
4.2.2 Current/voltage characteristic	23
4.2.3 Trip current I_K	23
4.2.4 Rated current I_N and switching current I_S	24
4.2.5 Residual current I_r	24
4.3 Electrical maximum ratings I_{max} , I_{Smax}	24
4.3.1 Maximum operating voltage V_{max} , rated voltage V_N , maximum measuring voltage $V_{\text{Meas,max}}$ and breakdown voltage V_D	24
4.3.2 Switching time t_S	24
4.3.3 Insulation test voltage V_{is}	25
4.3.4 Pulse strength V_P	25
4.4 Thermal characteristics	25
4.4.1 Thermal cooling time constant τ_c	25
4.4.2 Thermal threshold time t_a	25
4.4.3 Response time t_R	25
4.4.4 Settling time t_E	26
5 Notes on operating mode	26
5.1 Voltage dependence of resistance	26
5.2 Frequency dependence of resistance	27
5.3 Influence of heat dissipation on PTC temperature	28
5.4 Influence of ambient temperature on the I/V characteristic	28
6 Application notes	29
6.1 PTC thermistors for overload protection	29
6.1.1 Operating states of a PTC thermistor for overload protection	30
6.1.2 Considerations on trip current	30
6.1.3 Switching time versus switching current	32
6.1.4 Selection criteria	33
6.1.5 Circuit configuration	34

Contents

6.2	PTC thermistors for time delay	35
6.3	PTC thermistors for motor starting	37
6.4	PTC thermistors for picture tube degaussing	37
6.5	PTC thermistors as level sensors	38
6.6	PTC thermistors for measurement and control, temperature sensors	39
6.7	PTC thermistors as heating elements	40
Data sheets		41
Overload protection		41
	Disks	41
	Rods	84
	Telecom disks	86
	Telecom SMDs	88
	SMDs	92
Degaussing		100
Switching		109
Motor starting		118
Motor and machine protection		120
Level sensors		144
Measurement and control		150
	Disks	150
	Probe assemblies	156
	SMDs	162
Heating elements and thermostats		164
Mounting instructions		175
1	Soldering	175
1.1	Leaded PTC thermistors	175
1.2	Leadless PTC disk thermistors	175
1.3	SMD PTC thermistors	175
1.3.1	Chrome/nickel/tin terminations	175
1.3.2	Geometry of solder pads	176
1.3.3	Wave soldering (only for Pxxx types)	177
1.3.4	Infrared-reflow soldering	178
1.3.5	Wettability test in accordance with IEC 60068-2-58	179
1.3.6	Leaching resistance in accordance with IEC 60068-2-58	179
1.3.7	Placement and orientation of SMD on PCB	180
1.3.8	Storage of SMD PTC thermistors	181

2	Conductive adhesion	181
3	Clamp contacting	181
4	Robustness of terminations	181
5	Sealing and potting	182
6	Cleaning	182
7	Precautions for PTC thermistor use	183
Quality		185
1	Manufacturing process and quality assurance	185
2	Introduction	186
3	Quality assurance procedure	186
3.1	Incoming goods inspection	186
3.2	Process assurance	186
3.3	Product assurance	186
3.4	Final inspection	186
4	Delivery quality	186
5	Classification of defects	187
6	Incoming goods inspection by the customer	187
7	Reliability	188
8	Identification and traceability	188
9	Corrective and preventive measures	189
10	Supplementary information	189
Environmental protection measures		191
Climatic conditions		193
1	Reliability data	193
2	Operating temperature range	193
Taping and packing		195
1	Taping of SMD thermistors (in accordance with IEC 60286-3)	195
2	Taping of radial-lead PTC thermistors	197
3	Packing codes	199
Symbols and terms		201
Subject index		203
Addresses worldwide		205



Siemens Matsushita Components

NTC thermistor chips for temperature compensation

Keep cool

No matter what the temperature, that's the promise behind our NTC chips in 0805 and 1206 sizes, available direct from SCS stock. These chips do valuable service in handies, ensuring clear contrast in the display and optimum reception in the crystal oscillator, besides proper charging of the battery. In hybrid and SMT circuits, NTC chips cover a temperature range of -55°C through $+125^{\circ}\text{C}$.



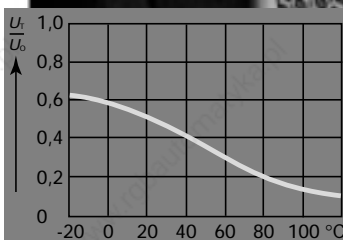

SCS - dependable, fast and competent



Selector Guide

PTC thermistors for overload protection







Type	V_{\max} V	I_N mA	I_S mA	T_{Ref} °C	R_N Ω	Page	
 <p>PTC C945 9824</p>	B59165 (C 1165)	20	800	1300	150	1	41
	B599*5 (C 9*5)	20	150 ... 2900	300 ... 5700	160	0,2 ... 13	43
	B599*5 (C 9*5)	30	120 ... 2500	240 ... 5000	120	0,2 ... 13	46
	B599*0 (C 9*0)	54	55 ... 1150	120 ... 2370	160	0,9 ... 55	49
	B599*0 (C 9*0)	80	30 ... 530	60 ... 1100	80	0,9 ... 55	52
	B599*0 (C 9*0)	80	50 ... 1000	100 ... 2000	120	0,9 ... 55	55
	B599*0 (C 9*0)	80	86 ... 1000	130 ... 1500	130	0,8 ... 40,9	58
 <p>PTC C830 9509</p>	B598*0 (C 8*0)	160	35 ... 800	70 ... 1600	160	2,6 ... 150	61
	B598*0 (C 8*0)	265	15 ... 350	40 ... 710	80	2,6 ... 150	64
	B598** (C 8*0)	265	55 ... 650	90 ... 980	130	3,5 ... 160	67
	B598*1 (C 8*1)	265	30 ... 730	65 ... 1450	135	2,6 ... 150	70
	B598** (C 8**)	265 ... 550	12 ... 650	24 ... 1300	120	2,6 ... 1500	73
 <p>PTC B750 9852</p>	B597** (B 7**)	420 ... 1000	8 ... 123	17 ... 245	110 ... 120	25 ... 7500	79

Selector Guide

PTC thermistors for overload protection

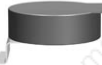
Type	V_{\max} V	I_N mA	I_S mA	T_{Ref} °C	R_N Ω	Page
 B5940* (B 40*)	500 ... 550	2,5 ... 4	6,5 ... 12	60	3500 ... 5500	84

Telecom PTC thermistors

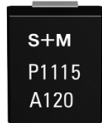
 PTC S 1022	B5902* (S 102* B1084)	245	55 ... 250	110 ... 400	120	10 ... 70	86
 SMD B5903* (9103*)	B5903* (9103*)	245	90 ... 180	200 ... 360	120	9 ... 50	88
 SMD B5908* (9103*)	B5908* (9103*)	245	90 ... 180	200 ... 360	120	9 ... 50	90
 SMD B59707 (A 707)	B59707 (A 707)	80	45	90	120	125	92
 SMD B59607 (A 607)	B59607 (A 607)	80	65	130	120	55	92
 S+M P1115 A120 B59*01 (P 1*01)	B59*01 (P 1*01)	30	90 ... 310	185 ... 640	85; 130	3,1 ... 13	94
 S+M P1115 A120 B59*15 (P 1*15)	B59*15 (P 1*15)	80	40 ... 150	85 ... 310	80; 120	16 ... 55	97

PTC thermistors for picture tube degaussing



Type	V_{\max} V	I_{in} A _{pp}	I_r mA _{pp}	R_N Ω	R_{coil} Ω	Page	
	B59*** (C 1650 S 1481)	140	≥ 24 ... ≥ 25	≤ 40	5 ... 8	3,5 ... 8,5	100
	B59*** (*14**)	265	≥ 11 ... ≥ 20	≤ 22,5 ≤ 40	18 ... 25	12 ... 25	100
	B59*** (J**)	265	≥ 18 ... ≥ 25	≤ 20	9 ... 18	10 ... 20	101
	B59*** (T**)	265	≥ 10 ... ≥ 25	≤ 3 ≤ 5	9 ... 30	10 ... 25	102
	B59*** (T**)	265	≥ 20 ... ≥ 32	≤ 10 ≤ 25	4,5 ... 9	... 12	104
	B59250 (C 1250)	265	≥ 11	≤ 20	25	25	100
	B59450 (C 1450)	265	≥ 20	≤ 25	18	12	100
	B59250 (T250)	265	≥ 10	≤ 3	28 (typ.)	25	102
	B59170 (T170)	265	≥ 16	≤ 3	18 (typ.)	17	102
	B59100 (T100)	265	≥ 20	≤ 3	22,5 (typ.)	10	102

Switching PTC thermistors

Type	V_{\max} V	I_N mA	I_S mA	T_{Ref} °C	R_N Ω	Page	
	B5911* (C 111*)	265	15 ... 55	40 ... 110	80; 120	70; 150	109
	B59xx0 (J 150) (J 200) (J 320)	265	24 ... 35	50 ... 70	120	150 ... 320	111
	B59339 (J 2**)	80 ... 265	8 ... 77	16 ... 150	115 ... 130	32 ... 1500	112
	B593** (J 29)	265	7 ... 14	15 ... 30	115 ... 190	5000	116

Selector Guide

PTC thermistors for motor starting

Type	V_{\max} V	I_{\max} mA	T_{Ref} °C	R_N Ω	Page
  B5919*; B5921* (A 1**, A 5**, J 5**)	180 ... 400	4 ... 10	120; 135	4,7 ... 47	118

PTC thermistors for motor and machine protection

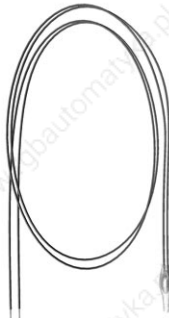
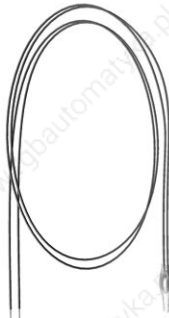
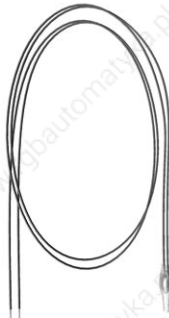
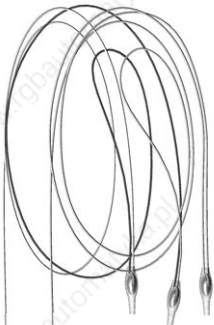
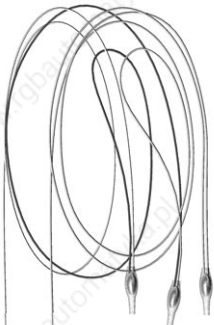
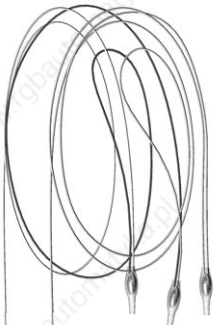

Type	V_{\max} V	T_{NAT} °C	R_N Ω	Page
 B59100 (M 1100)	30	60 ... 190	≤ 100	120
 B59135 (M 135)	30	60 ... 180	≤ 250	128
 B59155 (M 155)	30	60 ... 180	≤ 100	136
 B59300 (M 1300)	30	60 ... 190	≤ 300	124
 B59335 (M 335)	30	60 ... 180	≤ 750	132
 B59355 (M 355)	30	60 ... 180	≤ 300	140

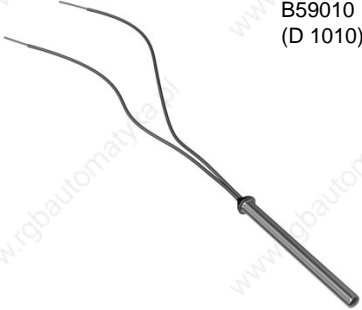
PTC thermistors as level sensors

Type	V_{\max} V	$I_{r, \text{oil}}$ mA	$I_{r, \text{air}}$ mA	t_s s	R_N Ω	Page
	Q63100 (E 11)	24	≥ 45	$\leq 35,5$	2	140 144
	B59020 (E 1020)	24	$\geq 41,7$	$\leq 26,7$	2	135 146
	B59010 (D 1010)	24	≥ 45	$\leq 33,5$	2	100 ... 200 148



Selector Guide

PTC thermistors for measurement and control

Type	V_{\max} V	T_{NAT} °C	R_{N} Ω	Page
 B59008 (C 8)	30	60 ... 180	≤ 250	150
 B59100 (C 100)	30	- 20 ... 180	≤ 100	152



Type	V_{\max} V	I_{\max} mA	T_{Ref} °C	R_{N} Ω	Page
 B59401 (D 401)	20	175 ... 270	40 ... 120	80 ... 130	156

PTC thermistors for measurement and control

Type	V_{\max} V	T_{NAT} °C	R_{N} Ω	Page	
	B59801 (D 801)	30	60 ... 160	≤ 100	158
	B59901 (D 901)	30	60 ... 140	≤ 100	160
	B59701 (A 701)	25	70 ... 130	≤ 1000	162

Selector Guide

PTC thermistors as heating elements and thermostats

Type		V_N V	T_{Ref} °C	R_N Ω	Page
	B59060 (A 60)	12	0 ... 280	9 ... ≥ 320	164
	B59053 (A 53)	230	50 ... 270	4200 ... 6000	168
	B59066 (A 66)	230	50 ... 270	1200; 1700	170
	B59042 (R 42)	12	40 ... 280	3,2 ... 12,8	166
	B59102 (R 102)	230	50 ... 290	700 ... 1300	172

Index of Types

Type	Page	Type	Page
A		C 861	70
A 53	168	C 870	61, 64, 67, 74
A 60	164	C 871	70
A 66	170	C 872	74
A 192	118	C 873	74
A 196	118	C 874	74
A 501	118	C 875	74
A 502	118	C 880	61, 64, 67, 74
A 508	118	C 881	70
A 544	118	C 883	74
A 607	92	C 884	74
A 701	162	C 885	74
A 707	92	C 886	74
B		C 890	61, 64, 74
B 404	84	C 891	70
B 406	84	C 910	49, 52, 55, 58
B 750	79	C 915	43, 46
B 751	79	C 930	49, 52, 55, 58
B 752	79	C 935	43, 46
B 753	79	C 940	49, 52, 55, 58
B 754	79	C 945	43, 46
B 755	79	C 950	49, 52, 55, 58
B 758	79	C 955	43, 46
B 770	79	C 960	49, 52, 55, 58
B 771	79	C 965	43, 46
B 772	79	C 970	49, 52, 55, 58
B 773	79	C 975	43, 46
B 774	79	C 980	49, 52, 55, 58
B 1084	86	C 985	43, 46
C		C 990	49, 52, 55
C 8	150	C 995	43, 46
C 100	152	C 1118	109
C 810	61, 64, 67, 74	C 1119	109
C 811	70	C 1165	41
C 830	61, 64, 67, 74	C 1250	100
C 831	70	C 1450	100
C 840	61, 64, 67, 74	C 1650	100
C 841	70	D	
C 850	61, 64, 67, 74	D 401	156
C 851	70	D 801	158
C 860	61, 64, 67, 74	D 901	160
		D 1010	148

Index of Types

Type	Page
E	
E 11	144
E 1020	146
G	
G 1030	88
G 1031	88
G 1033	88
G 1034	88
G 1081	90
G 1082	90
G 1083	90
G 1084	90
J	
J 29	116
J 104	101
J 108	101
J 120	101
J 150	111
J 200	111
J 209	101
J 280	112
J 281	112
J 282	112
J 283	112
J 284	112
J 285	112
J 286	112
J 287	112
J 288	112
J 289	112
J 290	112
J 320	111
J 501	118
J 502	118
M	
M 135	128
M 155	136
M 335	132
M 355	140
M 1100	120
M 1300	124

Type	Page
P	
P 1101	94
P 1115	97
P 1201	94
P 1215	97
P 1301	94
P 1315	97
R	
R 42-A40	166
R 42-A60	166
R 42-A80	166
R 42-A120	166
R 42-A160	166
R 42-A180	166
R 42-A220	166
R 42-A280	166
R 102	172
S	
S 1022	86
S 1023	86
S 1024	86
S 1025	86
S 1451	100
S 1461	100
S 1481	100
T	
T 100	103
T 104	103
T 108	103
T 109	104
T 120	103
T 126	104
T 170	103
T 205	104
T 209	103
T 250	103
T 251	103

General Technical Information

1 Definition

A PTC thermistor is a thermally sensitive semiconductor resistor. Its resistance value rises sharply with increasing temperature after a defined temperature (reference temperature) has been exceeded.

The very high positive temperature coefficient (PTC) has given the PTC thermistor its name.

Applicable standards are EN 144 000, EN 60738-1, IEC 60738-1 and DIN 44 080.

2 Structure and function

PTC thermistors are made of doped polycrystalline ceramic on the basis of barium titanate. Generally, ceramic is known as a good insulating material with a high resistance. Semiconduction and thus a low resistance are achieved by doping the ceramic with materials of a higher valency than that of the crystal lattice. Part of the barium and titanate ions in the crystal lattice is replaced with ions of higher valencies to obtain a specified number of free electrons which make the ceramic conductive.

The material structure is composed of many individual crystallites (figure 1) which are responsible for the PTC thermistor effect, i.e. the abrupt rise in resistance. At the edge of these monocrystallites, the so-called grain boundaries, potential barriers are formed. They prevent free electrons from diffusing into adjacent areas. Thus a high resistance results. However, this effect is neutralized at low temperatures. High dielectric constants and sudden polarization at the grain boundaries prevent the formation of potential barriers at low temperatures enabling a smooth flow of free electrons.

Above the Curie temperature dielectric constant and polarization decline so far that there is a strong growth of the potential barriers and hence of resistance. Beyond the range of the positive temperature coefficient α the number of free charge carriers is increased by thermal activation. The resistance then decreases and exhibits a negative temperature characteristic (NTC) typical of semiconductors.

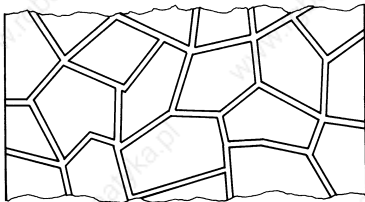

$$\leftarrow R_{PTC} = R_{\text{grain}} + R_{\text{grain boundary}}$$

$$R_{\text{grain boundary}} = f(T)$$

TPT 0315-9

Figure 1

Schematic representation of the polycrystalline structure of a PTC thermistor.

The PTC resistance R_{PTC} is composed of individual crystal and grain boundary resistances. The grain boundary resistance is strongly temperature-dependent.

3 Manufacture

Mixtures of barium carbonate, titanium oxide and other materials whose composition produces the desired electrical and thermal characteristics are ground, mixed and compressed into disks, washers, rods, slabs or tubular shapes depending on the application.

General Technical Information

These blank bodies are then sintered, preferably at temperatures below 1400 °C. Afterwards, they are carefully contacted, provided with connection elements depending on the version and finally coated or encased.

A flow chart in the quality section of this book (see page 185) shows the individual processing steps in detail. The chart also illustrates the extensive quality assurance measures taken during manufacture to guarantee the constantly high quality level of our thermistors.

4 Characteristics

A current flowing through a thermistor may cause sufficient heating to raise the thermistor's temperature above the ambient. As the effects of self-heating are not always negligible, a distinction has to be made between the characteristics of an electrically loaded thermistor and those of an unloaded thermistor. The properties of an unloaded thermistor are also termed "zero-power characteristics".

4.1 Unloaded PTC thermistors

4.1.1 Temperature dependence of resistance

The zero-power resistance value R_T is the resistance value measured at a given temperature T with the electrical load kept so small that there is no noticeable change in the resistance value if the load is further reduced.

For test voltages, please refer to the individual types (mostly $\leq 1,5$ V).

Figure 2 shows the typical dependence of the zero-power resistance on temperature. Because of the abrupt rise in resistance (the resistance value increases by several powers of ten), the resistance value is plotted on a logarithmic scale (ordinate) against a linear temperature scale (abscissa).

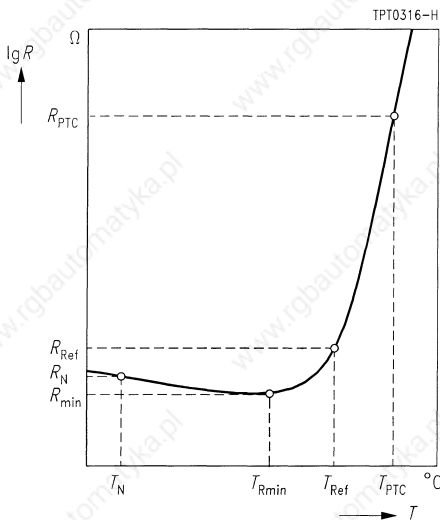

Figure 2

Typical resistance/temperature characteristic

$$R_{PTC} = f(T_{PTC})$$

R_N Rated PTC resistance
(resistance value at $T_N \triangleq 25$ °C)

R_{min} Minimum resistance
(resistance value at T_{Rmin})

T_{Rmin} Temperature at R_{min}
(α becomes positive)

R_{Ref} Reference resistance
(resistance value at T_{Ref})

T_{Ref} Reference temperature
(resistance rises sharply)

R_{PTC} Resistance in the steep region

T_{PTC} Temperature for which R_{PTC}
is guaranteed

The tolerances in figure 3 are provided for PTC thermistors which must have an exactly defined zero-power resistance curve.

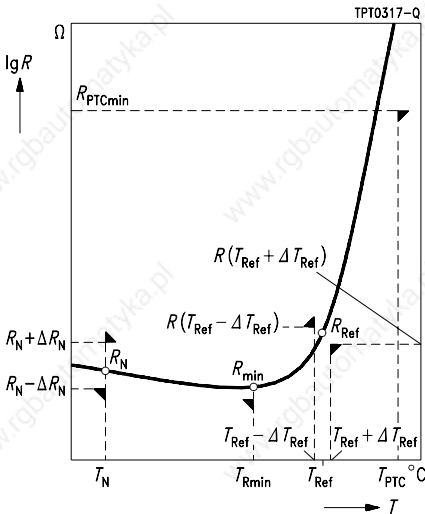

Figure 3

Variation of PTC resistance

$R_{PTC} = f(T_{PTC})$ (tolerance diagram)

R_N Rated resistance
Resistance value at T_N with specified tolerance $\pm \Delta R_N$

R_{min} Minimum resistance value
at T_{Rmin}

R_{Ref} Resistance value at T_{Ref}

$R(T_{Ref} - \Delta T_{Ref})$ Resistance value at $T_{Ref} - \Delta T_{Ref}$

$R(T_{Ref} + \Delta T_{Ref})$ Resistance value at $T_{Ref} + \Delta T_{Ref}$

$T_{Ref} \pm \Delta T_{Ref}$ Reference temperature
with \pm tolerances

R_{PTCmin} Minimum resistance value
at T_{PTC}

4.1.2 Rated resistance R_N

The rated resistance R_N is the resistance value at temperature T_N . PTC thermistors are classified according to this resistance value. The temperature T_N is 25 °C, unless otherwise specified.

4.1.3 Minimum resistance R_{min}

The beginning of the temperature range with a positive temperature coefficient is specified by the temperature T_{Rmin} . The value of the PTC resistance at this temperature is designated as R_{min} . This is the lowest zero-power resistance value which the PTC thermistor is able to assume. R_{min} is often given as a calculable magnitude without stating the corresponding temperature. The R_{min} values specified in this data book allow for the R tolerance range of the individual types and represent the lower limit.

4.1.4 Reference resistance R_{Ref} at reference temperature T_{Ref}

The start of the steep rise in resistance, marked by the reference temperature T_{Ref} , which corresponds approximately to the ferroelectric Curie point, is significant for the application. For the individual types of PTC thermistors it is defined as the temperature at which the zero-power resistance is equal to the value $R_{Ref} = 2 \cdot R_{min}$.

General Technical Information

4.1.5 Resistance R_{PTC} at temperature T_{PTC}

This point on the $R_{PTC} = f(T_{PTC})$ characteristic is typical of a resistance in the steep region of the curve. The resistance value R_{PTC} is the zero-power resistance value at the temperature T_{PTC} . For the individual types R_{PTC} is specified as a minimum value.

4.1.6 Temperature coefficient α

The temperature coefficient of resistance α is defined as the relative change in resistance referred to the change in temperature and can be calculated for each point on the R/T curve by:

$$\alpha = \frac{1}{R} \cdot \frac{dR}{dT} = \frac{d \ln R}{dT} = \ln 10 \cdot \frac{d \lg R}{dT}$$

In the range of the steep rise in resistance between R_{Ref} and R_{PTC} , α may be regarded as being approximately constant. The following relation then applies:

$$R_{PTC} \leq R_1, R_2 \leq R_{PTC} \rightarrow \alpha = \frac{\ln\left(\frac{R_2}{R_1}\right)}{T_2 - T_1}$$

Within this temperature range, the reverse relation can be equally applied:

$$R_2 = R_1 \cdot e^{\alpha \cdot (T_2 - T_1)}$$

The values of α for the individual types relate only to the temperature range in the steep region of the resistance curve, which is of primary interest for applications.

4.1.7 Nominal threshold temperature T_{NAT}

For certain PTC types the pair of values T_{NAT} , R_{NAT} is specified instead of T_{Ref} , R_{Ref} . The temperature relating to a defined resistance value in the steep region of the curve is given as the **nominal threshold temperature** T_{NAT} .

4.2 Electrically loaded PTC thermistors

When a current flows through the thermistor, the device will heat up more or less by power dissipation. This self-heating effect depends not only on the load applied, but also on the thermal dissipation factor δ and the geometry of the thermistor itself. Self-heating of a PTC thermistor resulting from an electrical load can be calculated as follows:

$$P = V \cdot I = \frac{dH}{dt} = \delta \cdot (T - T_A) + C_{th} \cdot \frac{dT}{dt}$$

P Power applied to PTC

V Instantaneous value of PTC voltage

I Instantaneous value of PTC current

dH/dt Change of stored heating energy over time

- δ Dissipation factor of PTC
- T Instantaneous temperature of PTC
- T_A Ambient temperature
- C_{th} Heat capacity of PTC
- dT/dt Change of temperature over time

4.2.1 Surface temperature T_{surf}

T_{surf} is the temperature reached on the thermistor's surface when it has been operated at specified rated voltage and in a state of thermal equilibrium with the ambient for a prolonged period of time. The specifications in the data sheet section refer to an ambient temperature of 25 °C.

4.2.2 Current/voltage characteristic

The properties of electrically loaded PTC thermistors (in self-heated mode) are better described by the I/V characteristic than by the R/T curve. It illustrates the relationship between voltage and current in a thermally steady state in still air at 25 °C, unless another temperature is specified.

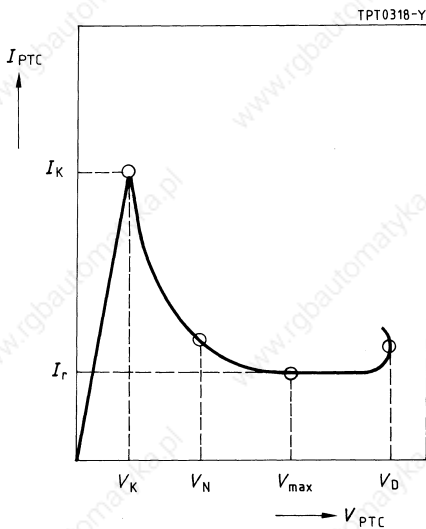

Figure 4

I/V characteristic of a PTC thermistor

- I_K Trip current at applied voltage V_K
(start of current limitation)
- I_r Residual current at applied voltage V_{max}
(current is balanced)
- V_{max} Maximum operating voltage
- V_N Rated voltage ($V_N < V_{max}$)
- V_D Breakdown voltage ($V_D > V_{max}$)

4.2.3 Trip current I_K

The trip current I_K is the current flowing through the thermistor at an applied voltage V_K . It is the current at which the electrical power consumed is high enough to raise the temperature of the device above the reference temperature T_{Ref} .

4.2.4 Rated current I_N and switching current I_S

The tolerance range of the trip current depends on the mechanical and electrical component tolerances. Knowing the tolerance limits is decisive in selecting the most suitable PTC thermistor. In practical use it is important to know at which current the PTC thermistor is *guaranteed* not to trip and at which currents the thermistor will *reliably* go into high-resistance mode. For this reason we do not specify the trip current in general, but its lower limit I_N and its upper limit I_S .

Rated current I_N : At currents $\leq I_N$ the PTC thermistor reliably remains in low-resistance mode.

Switching current I_S : At currents $\geq I_S$ the PTC thermistor reliably goes into high-resistance mode.

The currents specified in the data sheets refer to $T_A = 25^\circ\text{C}$.

4.2.5 Residual current I_r

The residual current I_r is the current developed at applied maximum operating voltage V_{\max} and at thermal equilibrium (steady-state operation).

4.3 Electrical maximum ratings I_{\max} , $I_{S\max}$

In electrically loaded PTC thermistors electrical power is converted into heat. The high loads generated for a short period of time during the heating phase (the PTC thermistor is in low-resistance mode when the operating voltage is applied) are limited by the specification of maximum permissible currents I_{\max} , $I_{S\max}$ and voltages V_{\max} in the data sheet section.

The number of heating processes is also an important criterion. The permissible number of switching cycles not affecting function or service life is given in the data sheets and applies to operation at specified maximum loads.

4.3.1 Maximum operating voltage V_{\max} , rated voltage V_N , maximum measuring voltage $V_{\text{Meas,max}}$ and breakdown voltage V_D

The **maximum operating voltage** V_{\max} is the highest voltage which may be continuously applied to the thermistor at the ambient temperatures specified in the data sheets (still air, steady-state, high-resistance mode). For types without V_{\max} specification (e. g. heating elements) the permissible maximum voltage is $V_N + 15\%$.

The **rated voltage** V_N is the supply voltage lying below V_{\max} .

The **maximum measuring voltage** $V_{\text{Meas,max}}$ is the highest voltage that may be applied to the thermistor for measuring purposes.

The **breakdown voltage** V_D is a measure for the thermistor's maximum voltage handling capability. Beyond V_D the PTC thermistor no longer exhibits its characteristic properties.

Switching current, operating current or minimum series resistances are specified to ensure that the PTC thermistor will not be overloaded.

4.3.2 Switching time t_S

If V_{\max} and I_{\max} are known, it is possible to describe the PTC thermistor's switch-off behavior in terms of switching time t_S . This is the time it takes at applied voltage for the current passing through the PTC to be reduced to half of its initial value. The t_S values apply to $T_A = 25^\circ\text{C}$.

4.3.3 Insulation test voltage V_{is}

The insulation test voltage V_{is} is applied between the body of the thermistor and its encapsulation for a test period of 5 seconds.

4.3.4 Pulse strength V_p

The pulse strength is specified on the basis of the standardized voltage pulses shown in figure 5. Voltage transients within the stated number of cycles and amplitude will not damage the component.

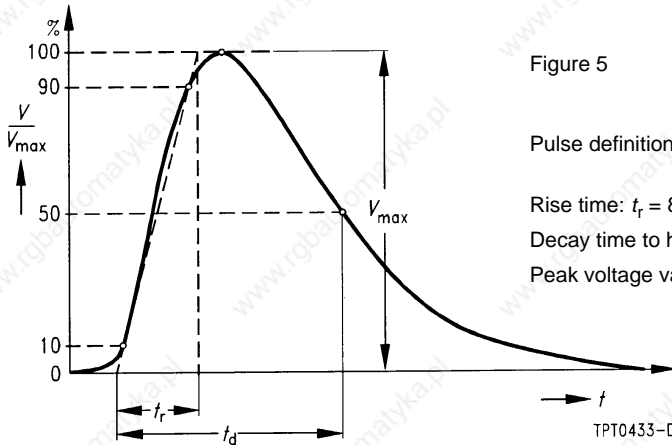

Figure 5

Pulse definition as per IEC 60-2
 VDE 0433
 Rise time: $t_r = 8 \mu s$
 Decay time to half value: $t_d = 20 \mu s$
 Peak voltage value: refer to individual type

4.4 Thermal characteristics

4.4.1 Thermal cooling time constant τ_c

The thermal cooling time constant refers to the time necessary for an unloaded thermistor to vary its temperature by 63,2 % of the difference between its mean temperature and the ambient temperature.

Equation for temperature change: $T(t_2) = T(t_1) \pm 0,0632 (T(t_1) - T_A)$ with $t_2 - t_1 = \tau_{th}$

4.4.2 Thermal threshold time t_a

The thermal threshold time t_a is the time an unloaded PTC thermistor needs to increase its temperature from starting temperature (25 °C) to reference temperature T_{Ref} or nominal threshold temperature T_{NAT} (resistance 1330 Ω) by external heating.

4.4.3 Response time t_R

The response time t_R is the time a PTC thermistor requires to recognize the change of power dissipation resulting from a change of the surrounding medium at applied voltage. After this period of time the residual currents assigned to the individual media become effective in the device.

General Technical Information

4.4.4 Settling time t_E

The settling time t_E refers to the time the PTC thermistor needs to reach operating condition after the operating voltage has been applied (only for level sensors).

5 Notes on operating mode

5.1 Voltage dependence of resistance

The R/T characteristic shows the relationship between resistance and temperature at zero power, i.e. when self-heating of the PTC thermistor is negligible.

The resistance of the PTC thermistor is composed of the grain resistance and the grain boundary transition resistance. Particularly in the hot state, the strong potential barriers are determining resistance. Higher voltages applied to the PTC thermistor therefore drop primarily at the grain boundaries with the result that the high field strengths dominating here produce a break-up of the potential barriers and thus a lower resistance. The stronger the potential barriers are, the greater is the influence of this "varistor effect" on resistance. Below the reference temperature, where the junctions are not so marked, most of the applied voltage is absorbed by the grain resistance. Thus the field strength at the grain boundaries decreases and the varistor effect is quite weak.

Figure 6 shows the typical dependence of resistance on field strength. It can be seen that the difference in resistance is largest between $R(E_1)$, $R(E_2)$ and $R(E_3)$ at temperature T_{max} and thus in the region of maximum resistance. (Note: R_{PTC} is plotted on a logarithmic scale.)

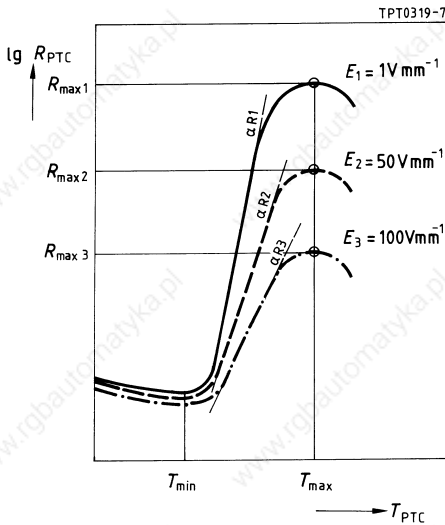

Figure 6

Influence of field strength E on the R/T characteristic (varistor effect)

$$\alpha_{R1} > \alpha_{R2} > \alpha_{R3}$$

Due to this dependence on the positive temperature coefficient of the field strength, operation on high supply voltages is only possible with PTC thermistors that have been designed for this purpose by means of appropriate technological (grain size) and constructional (device thickness) measures.

The R/T curves in the data sheet section are zero-power characteristics.

5.2 Frequency dependence of resistance

Due to the structure of the PTC thermistor material the PTC thermistor on ac voltage is not a purely ohmic resistor. It also acts as a capacitive resistor because of the grain boundary junctions (see equivalent circuit diagram, figure 7).

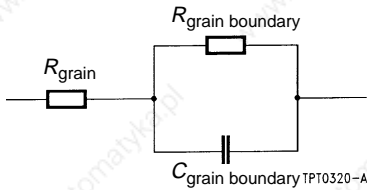

Figure 7

Equivalent circuit diagram of a PTC thermistor on ac voltage

The impedance measured at ac voltage decreases with increasing frequency. The dependence of the PTC resistance on temperature at different frequencies is shown in figure 8. So the use of the PTC thermistor in the AF and RF ranges is not possible, meaning that applications are restricted to dc and line frequency operation.

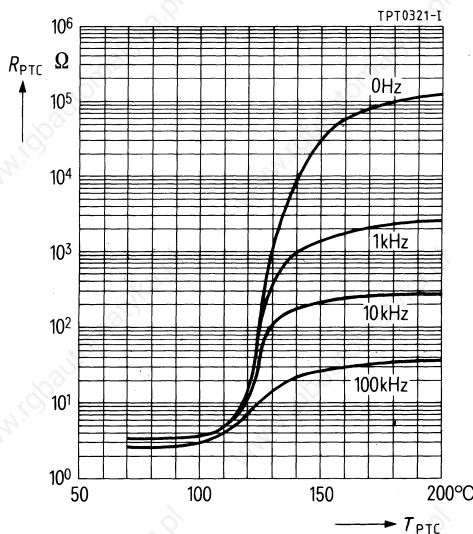

Figure 8

Influence of frequency on the R/T characteristic

5.3 Influence of heat dissipation on PTC temperature

Figure 9a shows the electrical power P_{el} converted in a PTC thermistor as a function of its temperature. At a given operating voltage an operating point is established in the PTC depending on the ambient temperature and thermal conduction from the thermistor to the environment.

The PTC thermistor heats up to an operating temperature above the reference temperature, for example (operating point A_1 in Figure 9a). If the ambient temperature rises or the heat transfer to the environment decreases, the heat generated in the PTC thermistor can no longer be dissipated so that the PTC will increase its temperature. Its operating point moves down the curve, e.g. to A_2 , causing a considerable reduction in current.

This limiting effect is maintained as long as T_{max} is not exceeded. An increase in temperature beyond T_{max} would lead to the destruction of the PTC thermistor at a given operating voltage.

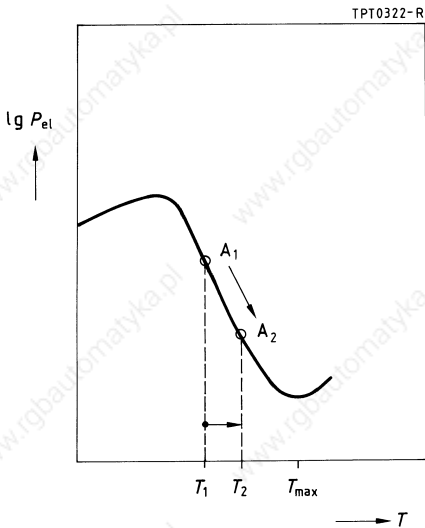

Figure 9a

Electrical power P_{el} in a PTC thermistor versus PTC temperature

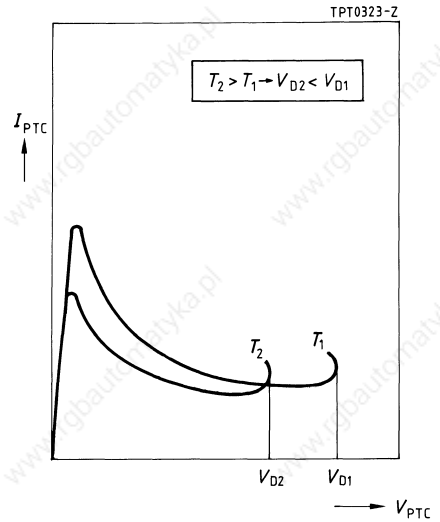

Figure 9b

Influence of the ambient temperature on the I/V characteristic

5.4 Influence of ambient temperature on the I/V characteristic

Figure 9b shows two I/V characteristics of one and the same PTC thermistor for two different ambient temperatures T_1 and T_2 , with $T_1 < T_2$. At the higher temperature the PTC thermistor has a higher resistance value although the conditions are otherwise the same. Therefore, it carries less current. The curve for T_2 is thus below that for T_1 . The breakdown voltage, too, depends on the ambient temperature. If the latter is higher, the thermistor reaches the critical temperature where breakdown occurs on lower power or operating voltage. V_{D2} is therefore lower than V_{D1} .

6 Application notes

As to their possibilities of application, PTC thermistors can be divided in the following manner:

a) by function

Directly heated PTC thermistor

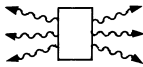

Heat is generated in the PTC thermistor



Power PTC thermistors

Applications where the electrical resistance is primarily determined by the current passing through the thermistor.

Indirectly heated PTC thermistor

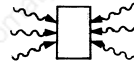

Heat is supplied from outside



Temperature sensors

TPT 0324-8

Applications where the electrical resistance is primarily determined by the temperature of the medium surrounding the thermistor.

b) by application

Power PTC thermistors		Sensors	
Fuse	Short-circuit and overload protection	Temperature	Overtemperature protection Measurement and control
Switch	Motor start Degaussing Time delay	Limit temperature	Motor protection Overtemperature protection
Heater	Small heaters Thermostats		
Level sensor	Limit indicators		

6.1 PTC thermistors for overload protection

Ceramic PTC thermistors are used instead of conventional fuses to protect loads such as motors, transformers, etc. or electronic circuits (line card) against overload. They not only respond to inadmissibly high currents, but also if a preset temperature limit is exceeded. Thermistor fuses limit the power dissipation of the overall circuit by increasing their resistance and thus reducing the current to a harmless residual value. In contrast to conventional fuses, they do not have to be replaced after elimination of the fault, but resume their protective function immediately after a short cooling-down time.

As opposed to PTC thermistors made of plastic materials, ceramic PTCs always return to their initial resistance value, even after frequent heating/cooling cycles.

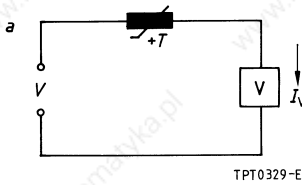

Figure 10

PTC thermistor fuse connected in series with the load

6.1.1 Operating states of a PTC thermistor for overload protection

Figure 11 illustrates the two operating states of a PTC fuse. In rated operation of the load the PTC resistance remains low (operating point A_1). Upon overloading or shorting the load, however, the power consumption in the PTC thermistor increases so much that it heats up and reduces the current flow to the load to an admissible low level (operating point A_2). Most of the voltage then lies across the PTC thermistor. The remaining current is sufficient to keep the PTC in high-resistance mode ensuring protection until the cause of the overload has been eliminated.

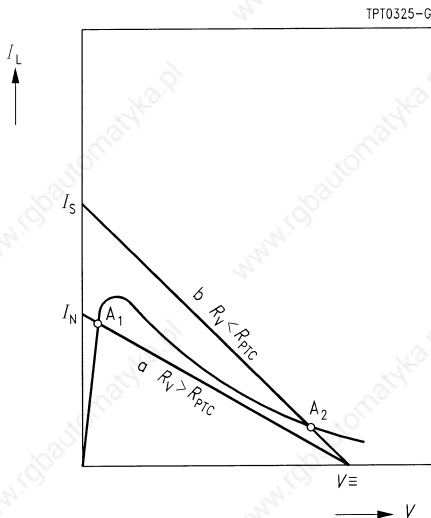

Figure 11

Operating states of a PTC thermistor for overload protection

- a Rated operation
- b Overload operation

6.1.2 Considerations on trip current

An essential parameter for the function and selection of a PTC thermistor fuse is the trip current. This is the current at which the applied electrical power heats up the PTC thermistor to such an

extent that the supply of current is limited and the protective function is triggered. The trip current is mainly a function of

- PTC dimensions,
- PTC temperature,
- PTC resistance,
- heat dissipation.

To be able to heat a PTC thermistor above its reference temperature, a minimum power (trip power) is necessary for given dimensions. A certain trip current is then established at a specified PTC resistance. The user has to take into account the tolerance of the trip current: lower limit = rated current, upper limit = minimum switching current.

Very often high trip currents are required. Higher trip currents with unchanged resistance are obtained through larger thermistor dimensions (see figure 12) or by raising the reference temperature. Favorable conditions for high trip currents can be achieved by making the best possible use of the cooling effect of the environment. The manufacturer contributes to good heat dissipation by producing the thermistors with large surfaces and making them as thin as possible. The user can enhance the heat dissipation effect by further measures (e.g. cooling fins) so that protective ratings of more than 200 W per component can be achieved.

Another mechanism for controlling the trip current is the PTC resistance itself. To keep the spread of the trip current as small as possible, PTC thermistor fuses are only produced in narrow resistance ranges. In practice this leads to PTC types with tolerances of 25 % and tighter so that the protective function is also possible in applications with only slight differences in current between rated operation and overload.

Another quantity affecting the trip current is the ambient temperature at which the PTC thermistor is operated. Figure 13 illustrates this relationship. An increase in ambient temperature means that

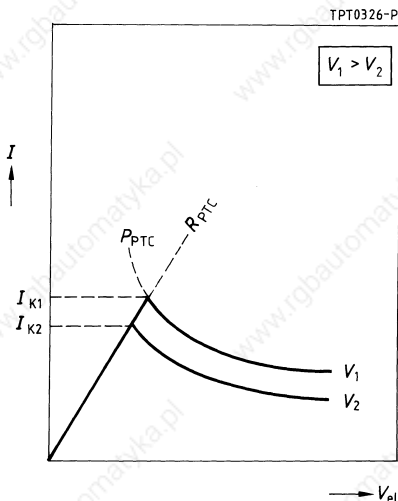

Figure 12

Influence of the PTC volume V on the trip current at given resistance R_{PTC}
(V_{ei} : applied voltage)

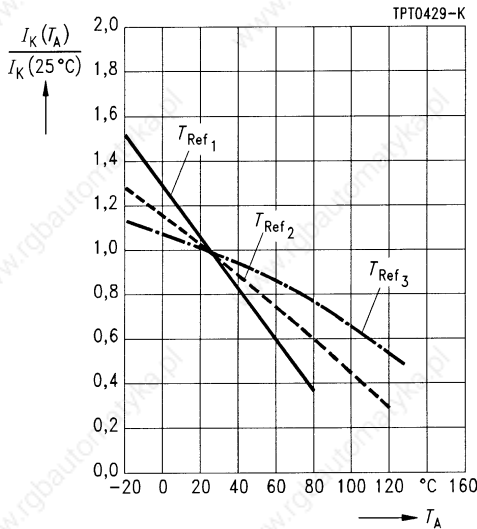

Figure 13

Standardized trip current I_K versus ambient temperature T_A (measured in still air)

Parameter: $T_{Ref\ 1} < T_{Ref\ 2} < T_{Ref\ 3}$.

the PTC thermistor reaches the temperature causing it to trip with much less power consumption. A cooler environment has the opposite effect, i. e. power consumption and trip current rise.

6.1.3 Switching time versus switching current

The dynamic heating behavior of the PTC thermistor is determined by the specific heat capacity of the titanate material, which is approx. 3 Ws/cm^3 . At short switching times – being less than 5 seconds with commonly used overcurrent protection devices – heat dissipation through the surface and lead wires is virtually negligible: almost the entire electrical dissipation is consumed to heat up the ceramic material, to increase the temperature above the reference temperature and thus to produce a stable operating point on the R/T characteristic. When dissipation increases with rising difference between device temperature and ambient, only a small amount of excess energy remains for heating the component and the result are the switching time curves as a function of switching current shown in figure 14.

S + M Components offers a wide selection of PTC thermistors for overload protection from small voltages of 20 V and rated currents of 2,9 A through line voltage to high voltages of 1000 V and 8 mA rated current. Many years of volume production and positive experience gained with the long-term features of overload protection components in practice have verified the particularly high safety and reliability of these ceramic PTC thermistors.

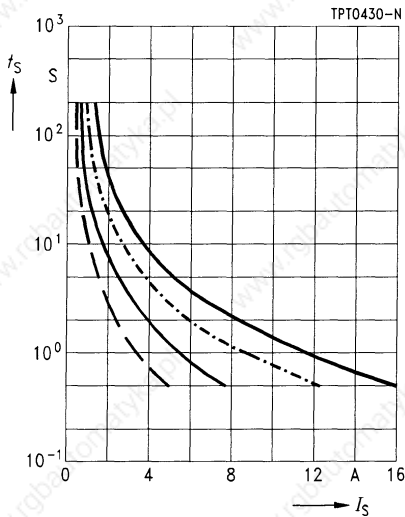

Figure 14

Switching times t_s of some PTC thermistors (parameter: different geometries) versus switching current I_s (measured at 25 °C in still air)

6.1.4 Selection criteria

In designing a circuit, the following considerations should be borne in mind when selecting a PTC thermistor.

Maximum voltage

During normal operation only a small part of the overall voltage is applied to an overload protection PTC thermistor in series with a load. When it responds, i.e. when it goes high-resistance, it has to handle virtually the entire supply voltage. For this reason the thermistor's maximum operating voltage V_{max} should be chosen sufficiently high. Possible supply voltage fluctuations should also be allowed for.

Rated current and switching current

The next thing is to find a PTC thermistor with sufficiently high rated current (that current at which the thermistor will under no circumstances turn off) within the suitable voltage class. To ensure reliable switch-off (= short switching times) the switching current should exceed twice the rated current. So you should consider whether the overall layout of the circuit can handle the increased power for the short time until the PTC thermistor reduces it. Here a worst-case estimate is necessary. Rated and switching currents depend on the ambient temperature. So, as the worst case for the rated current the maximum permissible ambient temperature for the application should be taken, and for the switching current the lowest possible ambient temperature.

General Technical Information

Maximum permissible switching current at V_{\max}

When considering possible situations in which the PTC thermistor is to give protection, it is necessary to examine whether there will be conditions in which the maximum permissible switching current will be exceeded. This will generally be the case when it is possible for the load to be short-circuited. In the data sheets a maximum permissible switching current $I_{S\max}$ is stated for the maximum operating voltage V_{\max} . Overloading the PTC thermistor by too high a switching current must be avoided. If there is indeed such a risk, e. g. through frequent shorting, it can be countered by connecting a resistor in series with the PTC thermistor.

Selection of reference temperature

S + M Components offers PTC thermistors for overload protection with reference temperatures of 80, 120, 135 und 160 °C. The rated current depends in turn on this reference temperature and the disk diameter of the thermistor. In trying to find an attractively costed solution, one could decide on a component with high reference temperature and a small disk diameter. In this case it is necessary to check whether the high surface temperature of the thermistor in the circuit could lead to undesired side-effects. The circuit board material, the configuration of the surrounding components and the spacing from any enclosure as well as any sealing compounds must all receive due attention.

Environmental effects

If any washing solutions other than those suggested in this data book are used (e. g. isopropyl alcohol), if there is any contact with chemicals or use of potting or sealing compounds, all due care should be taken. The reduction of the titanate ceramic that can be caused by chemical effects on the surface of the thermistor and the resulting formation of low-resistance conducting paths or the altered thermal relations in the sealant can lead to local overheating of the PTC thermistor and thus to failures.

6.1.5 Circuit configuration

PTC thermistors can be used for versatile protection applications. The circuit diagram below (figure 15) shows the most simple circuit configuration for protecting a transformer. The type series C18*1 is particularly suitable for this purpose. For telephone line card protection we recommend the types S102*.

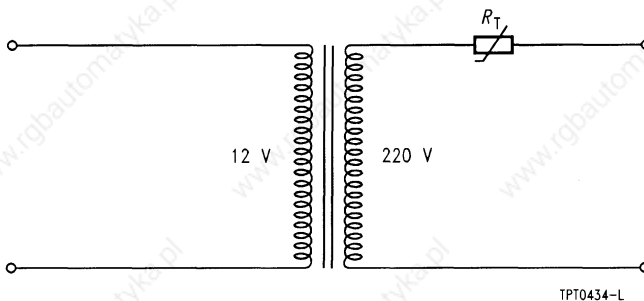

Figure 15

Most simple circuit for protecting a transformer (primary side)

TPT0434-L

PTC thermistors are also employed for input protection of measuring instrumentation up to 1000 V, for household appliances (in particular small equipment), for vehicle motor and air fan protection and for cathode preheating in energy-saving lamps.

6.2 PTC thermistors for time delay

These PTC thermistors are used when a load in series with the thermistor has to be switched off after a time delay and when switching occurs frequently. Examples of time delay applications are control of the auxiliary starting phase in ac motors and relay delays.

Figures 16a/b show a typical configuration of a PTC thermistor in series with a load and the delayed drop of the load current. The switching function of the PTC thermistor consists in limiting the current flowing through the load at high operating voltages after the thermistor has heated up. Differences in current of a factor of 1000 are the rule here. The switching time t_S can be approximated as follows:

$$t_S = \frac{k \cdot V \cdot (T_{Ref} - T_A)}{P}$$

T_{Ref}	Reference temperature of PTC thermistor
T_A	Ambient temperature
k	Material-specific constant
V	PTC thermistor volume
P	Switch-on power of PTC thermistor

This shows that the switching time can be influenced by the size of the PTC thermistor, its reference temperature and the power supplied. Manufacturing techniques allow a variation of the switching time in a wide range. Switching times are lengthened by increasing the volume or the reference temperature; high power consumption by the PTC thermistor, on the other hand, results in short switching times. The graph in figure 16c shows the switch-off behavior for different levels of current consumption.

General Technical Information

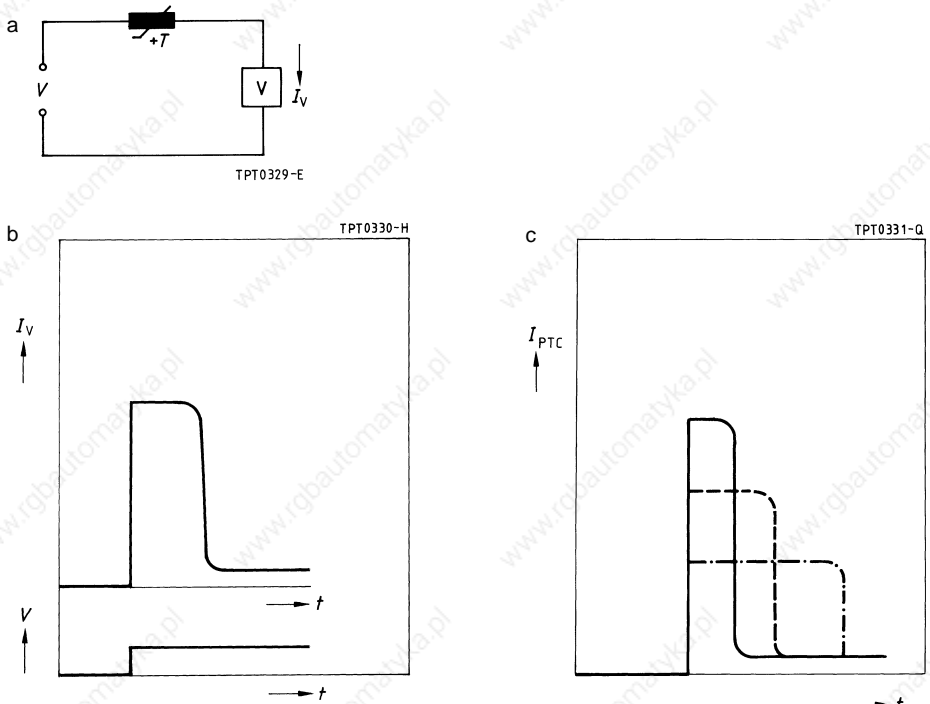

Figure 16

Typical configuration of a PTC thermistor for time delay (a)

Typical delay of the load current I_V (b)

Typical switch-off behavior of a PTC thermistor (c)

With the type series C1118/C1119 S + M Components offers a special thermistor version for energy-saving lamps. Due to a soldering technique especially employed for this version, these thermistors are able to handle a very large number of switching cycles ($> 10\,000$).

The encased J29 model is particularly suitable for use in switch-mode power supplies.

6.3 PTC thermistors for motor starting

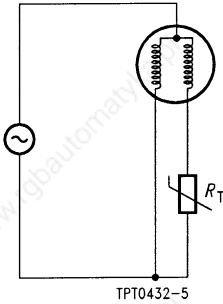

Figure 17

Simple starter circuit for single-phase ac motors
 The PTC thermistor is used for delaying the switch-off of the starter auxiliary winding (after the motor has accelerated) to protect the winding from damage

A wide range of types including some encased models is available for motor start applications. Our motor start thermistors have been designed for a large number of switching cycles (> 100 000) at high starting powers.

6.4 PTC thermistors for picture tube degaussing

PTC thermistors degauss the shadow mask of color picture tubes by reducing the alternating current flowing through the degaussing coil within a short period of time. A large difference between inrush current and residual current is crucial for good degaussing. S+M Components provides single and double PTCs for degaussing purposes. In a double PTC, a PTC connected to the power supply supports heating of another PTC that is connected to the coil. As compared to a single PTC, this configuration permits the residual current to be further reduced.

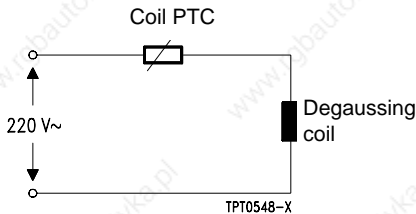

Figure 18

Degaussing with a single PTC

A PTC thermistor connected in series with the coil degausses the shadow mask of a picture tube. The high inrush current is reduced to a low residual value.

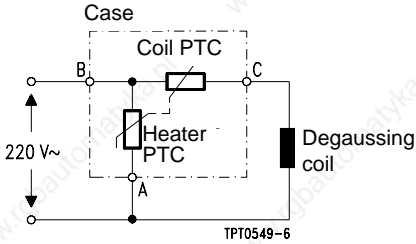

Figure 19

Degaussing with two thermally coupled PTC thermistors

Degaussing with a double PTC permits a further reduction of the residual current. This is achieved by additionally heating the coil PTC by means of a second PTC.

6.5 PTC thermistors as level sensors

A thermistor heated with a low voltage of approx. 12 V responds to a change in external cooling conditions by changing its power consumption. At constant voltage the power consumption is hence a measure for the dissipation conditions. With increasing dissipation the thermistor cools down and the PTC current rises due to the positive temperature coefficient. A marked increase in current occurs when a PTC thermistor heated in air is immersed into a liquid, where a larger amount of heat is dissipated than in air. This feature makes the PTC thermistor an ideal candidate for overflow control in tanks for liquids. The S + M product line includes a number of types especially matched to this kind of application (see page 144 ff).

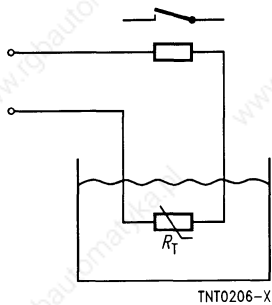

Figure 20

Circuit configuration for liquid level control

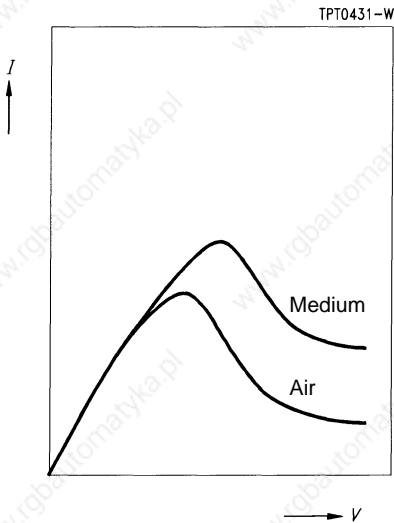

Figure 21

Current versus voltage in different media

$$\delta_{\text{Medium}} > \delta_{\text{Air}}$$

Further applications are

- Overflow protection for oil tanks (prescribed by the German Technical Inspectorate TÜV)
- Liquid level measurement
- Limit indication (e.g. indicator for too low a water level in the reservoir for the windshield wipers)
- Leakage sensing

6.6 PTC thermistors for measurement and control, temperature sensors

With PTC thermistors as temperature sensors only the steep region of the R/T characteristic is used. The resistance of the PTC is to be regarded as a function of the ambient temperature [$R_{\text{PTC}} = f(T_A)$].

The precondition for this relationship between resistance and ambient temperature is that self-heating and/or the varistor effect are excluded. This means that these PTC thermistors must be operated in the lowest possible field strengths. To enable a fast response, thermistor sensors have especially small dimensions. High control accuracy is achieved by using materials with an extra steep resistance/temperature characteristic.

Today it is possible to produce devices with temperature coefficients in an operating range of more than 30 %/K!

PTC thermistors are widely employed as temperature sensors in electrical machines to monitor winding temperature. A wide variety of sensors with trip temperatures between -30 and $+180$ °C is available for different temperature ranges.

6.7 PTC thermistors as heating elements

The use of PTC thermistors is not confined to switching and current sensing applications, but they are also ideal as heating elements because of their specific R/T characteristic. Due to the positive curve of the temperature coefficient, it is possible to dispense with the additional control and over-temperature protection devices required for conventional heating systems.

In this application, the PTC thermistors are operated directly at the available voltage without a series resistance, preferably in the low-resistance section of the R/T characteristic (see figure 2) since particularly high heating power is achieved in this section of the curve. In order to make use of this advantage, it is important to create conditions which will not cause the PTC thermistor to raise its resistance. This is ensured with extremely thin PTC thermistors by increased heat transmission from the surface. To this end, the PTC thermistor is placed between heat-emitting solid bodies so as to optimize heat flow from the thermistor to its environment to be heated. Here, symmetrical thermal decoupling is of great advantage.

Special care has to be taken when PTC thermistors are used in potted circuits. The high thermal resistance of potting materials can very much impair heat transmission so that the PTC thermistors could heat up to a critical temperature level. The PTC thermistor as a heating element is described in detail in the Siemens Components reprint "The PTC Thermistor as Heating Element", ordering no. B4-B2491-X-X-7600.

In PTC thermistors operated at line voltage steep temperature gradients and sometimes high operating temperatures are generated in the heating-up phase. In these cases soldering should be avoided since the solder joints may fatigue. The devices are offered by the manufacturer with metallized surfaces for clamp contacting, which guarantees favorable thermal decoupling.

PTC thermistors for heating applications can be manufactured for a broad temperature span (up to 340 °C) in a wide variety of dimensions, so that the suitable type for a particular application can be easily found.

Application examples for heating thermistors:

- Rib heaters: fan heaters up to 2 kW, hair-driers, tumble-driers
- Heating plates, mosquito repellent devices, egg-cookers, switchgear cabinet heating, scent evaporators etc.
- Cartidge heaters for hair curlers, facial treatment devices, travel press irons, adhesive pistols, baby food warmers
- Bimetal heaters for door latches of washing machines, overtemperature fuses
- Heating of liquids such as oil preheating in oil burners or for dilative elements
- Heating systems in automobiles: suction pipe preheating for injection motors, mirror heating, washing nozzle heating, defrosters

20 V, 150 °C

Applications

- Overcurrent and short-circuit protection

Features

- Coated thermistor disk
- Manufacturer's logo and type designation stamped on in yellow
- High thermal stability
- Flame-retardant coating material (UL 94 V-0 approved)
- UL approval (E69802)
- VDE approval

Options

- Leadless disks and leaded disks without coating available upon request
- Thermistors with diameter $b \leq 11,0$ mm are also available on tape

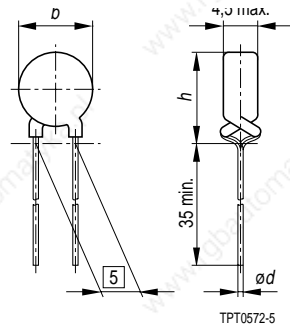

Dimensions (mm)

Type	b_{max}	$\varnothing d$	h_{max}
C 1165	9,0	0,6	12,5

Max. operating voltage ($T_A = 60$ °C)	V_{max}	20	V
Rated voltage	V_N	12	V
Switching cycles (typ.)	N	100	
Switching time at V_{max} , I_{Smax}	t_S	≤ 3	s
Reference temperature (typ.)	T_{Ref}	150	°C
Resistance tolerance	ΔR_N	± 20 %	
Operating temperature range ($V = 0$)	T_{op}	- 40/+ 125	°C
	T_{op}	- 40/+ 85	°C

Type	I_N	I_S	I_{Smax} ($V=V_{max}$)	I_r (typ.) ($V=V_N$)	I_r (typ.) ($V=V_{max}$)	R_N	R_{min}	Ordering code
	mA	mA	A	mA	mA	Ω	Ω	
C 1165	800	1300	5,0	200	150	1	0,7	B59165-C1150-A70

Characteristics (typical)

PTC resistance R_{PTC} versus
PTC temperature T_{PTC}
(measured at low signal voltage)

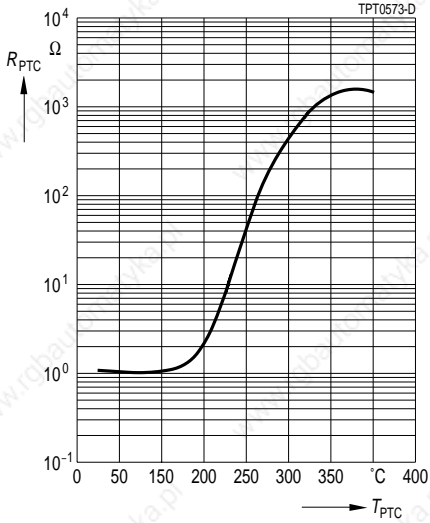

PTC current I_{PTC} versus PTC voltage V_{PTC}
(measured at 25 °C in still air)

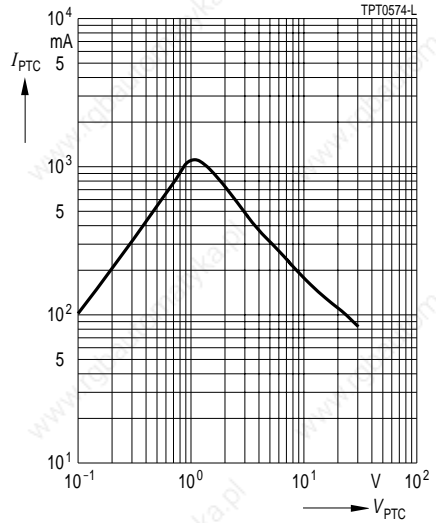

Switching time t_S versus switching current I_S
(measured at 25 °C in still air)

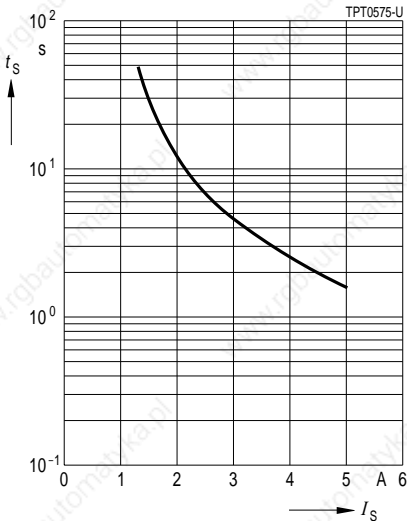

Rated current I_N versus ambient temperature T_A
(measured in still air)

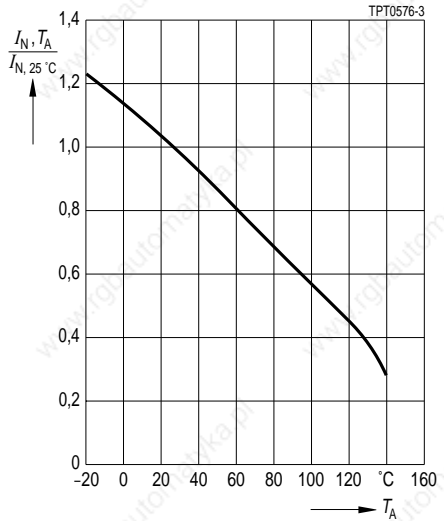

20 V, 160 °C

Applications

- Overcurrent and short-circuit protection

Features

- Coated thermistor disk
- Manufacturer's logo and type designation stamped on in yellow
- Low resistance
- For rated currents of up to 2,9 A
- High thermal stability
- UL approval (E69802)
- VDE approval (exception: C915)

Options

- Leadless disks and leaded disks without coating available upon request
- Thermistors with diameter $b \leq 11,0$ mm are also available on tape

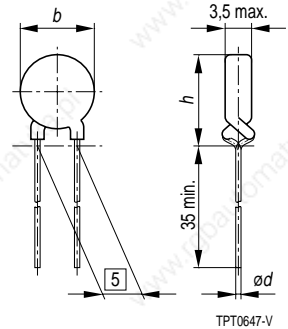

Dimensions (mm)

Type	b_{max}	$\varnothing d$	h_{max}
C 915	26,0	0,8	29,5
C 935	22,0	0,6	25,5
C 945	17,5	0,6	21,0
C 955	13,5	0,6	17,0
C 965	11,0	0,6	14,5
C 975	9,0	0,6	12,5
C 985	6,5	0,6	10,0
C 995	4,0	0,5	7,5

Max. operating voltage ($T_A = 60\text{ °C}$)	V_{max}	20	V
Rated voltage	V_N	12	V
Switching cycles (typ.)	N	100	
Switching time at V_{max}, I_{Smax}	t_S	≤ 10	s
Reference temperature (typ.)	T_{Ref}	160	°C
Resistance tolerance	ΔR_N	$\pm 25\%$	
Operating temperature range ($V = 0$)	T_{op}	- 40/+ 125	°C
	T_{op}	0/60	°C

Type	I_N	I_S	I_{Smax}	I_r (typ.)	I_r (typ.)	R_N	R_{min}	Ordering code
	mA	mA	($V=V_{max}$) A	($V=V_{max}$) mA	($V=V_N$) mA			
C 915	2900	5700	15,0	350	550	0,2	0,1	B59915-C160-A70
C 935	2100	4150	10,0	240	380	0,3	0,2	B59935-C160-A70
C 945	1500	3050	8,0	170	270	0,45	0,3	B59945-C160-A70
C 955	950	1900	5,5	120	190	0,8	0,5	B59955-C160-A70
C 965	700	1450	4,3	105	165	1,2	0,7	B59965-C160-A70
C 975	550	1100	3,0	85	135	1,8	1,1	B59975-C160-A70
C 985	300	600	1,0	65	100	4,6	2,7	B59985-C160-A70
C 995	150	300	0,7	40	65	13	7,8	B59995-C160-A70

Characteristics (typical)

PTC resistance R_{PTC} versus
 PTC temperature T_{PTC}
 (measured at low signal voltage)

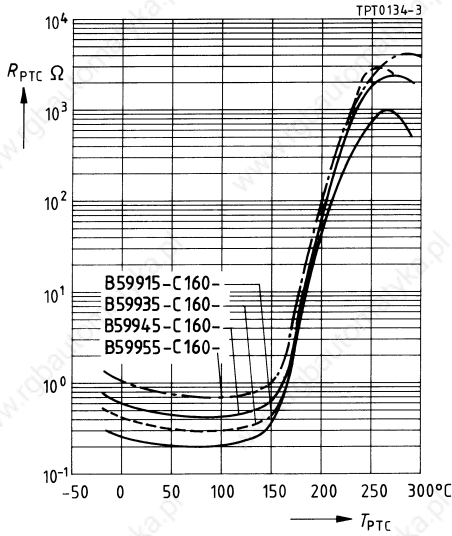

PTC current I_{PTC} versus PTC voltage V_{PTC}
 (measured at 25 °C in still air)

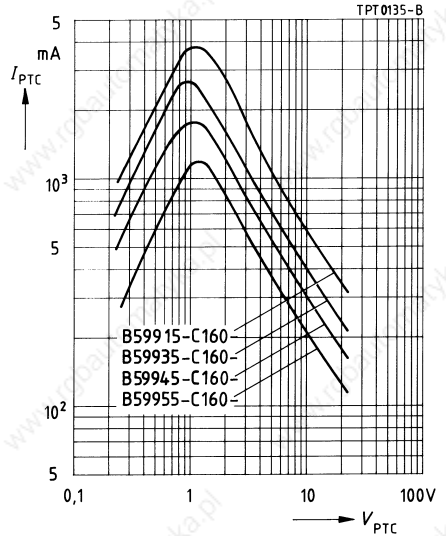

Switching time t_S versus switching current I_S
 (measured at 25 °C in still air)

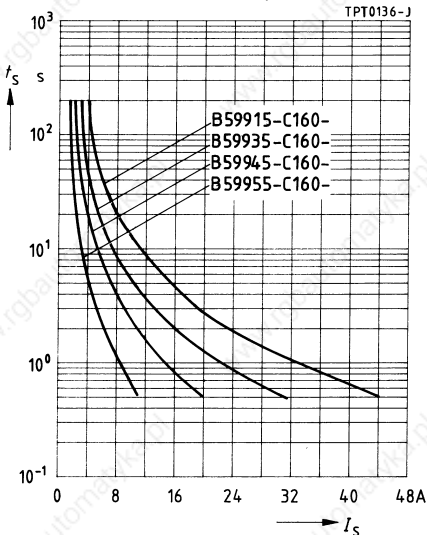

Rated current I_N versus ambient temperature T_A
 (measured in still air)

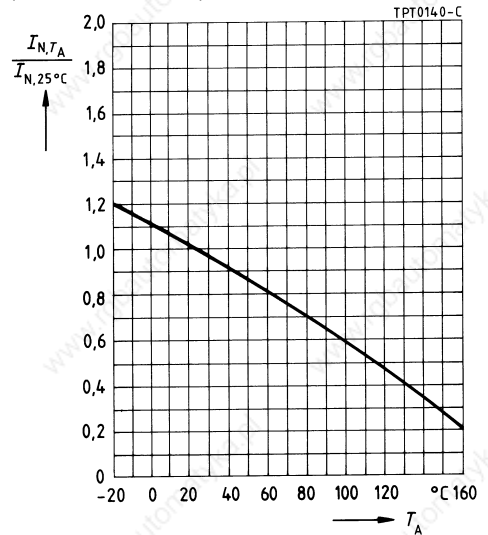

Characteristics (typical)

PTC resistance R_{PTC} versus
PTC temperature T_{PTC}
(measured at low signal voltage)

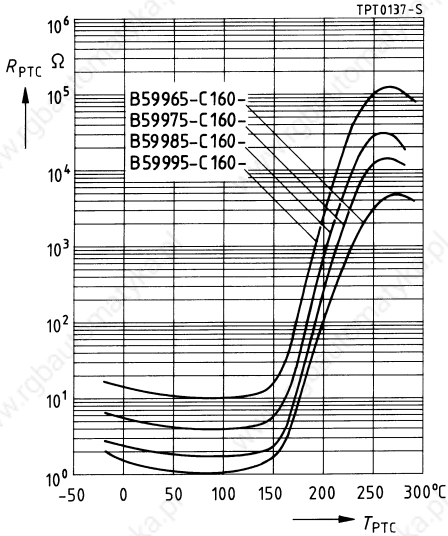

PTC current I_{PTC} versus PTC voltage V_{PTC}
(measured at 25 °C in still air)

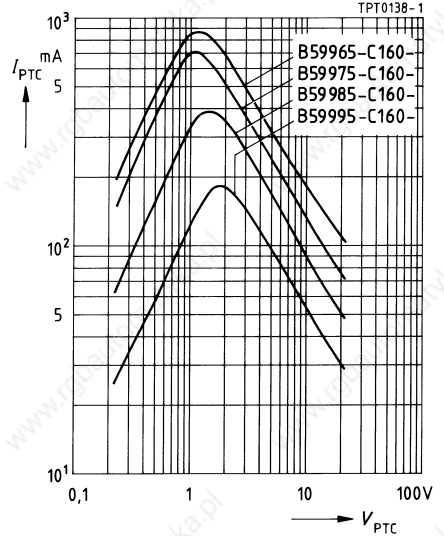

Switching time t_S versus switching current I_S
(measured at 25 °C in still air)

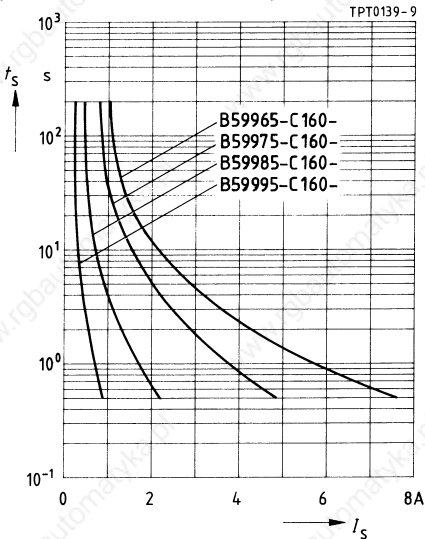

Rated current I_N versus ambient temperature T_A
(measured in still air)

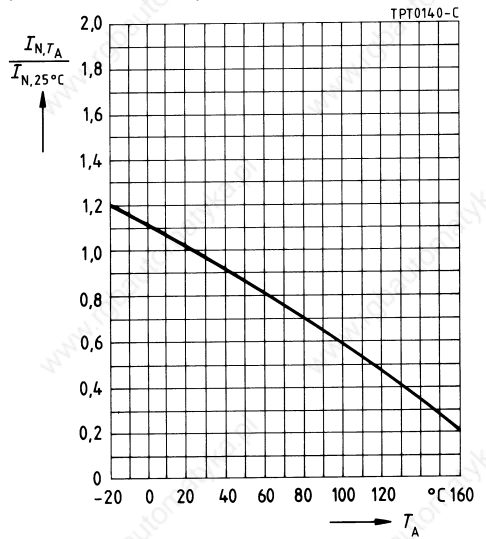

30 V, 120 °C

Applications

- Overcurrent and short-circuit protection

Features

- Coated thermistor disk
- Manufacturer's logo and type designation stamped on in white
- Low resistance
- For rated currents of up to 2,5 A
- UL approval (E69802)
- VDE approval (exception: C915)

Options

- Leadless disks and leaded disks without coating available upon request
- Thermistors with diameter $b \leq 11,0$ mm are also available on tape

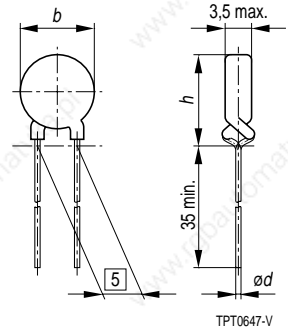

Dimensions (mm)

Type	b_{max}	$\varnothing d$	h_{max}
C 915	26,0	0,8	29,5
C 935	22,0	0,6	25,5
C 945	17,5	0,6	21,0
C 955	13,5	0,6	17,0
C 965	11,0	0,6	14,5
C 975	9,0	0,6	12,5
C 985	6,5	0,6	10,0
C 995	4,0	0,5	7,5

Max. operating voltage ($T_A = 60$ °C)	V_{max}	30	V
Rated voltage	V_N	12, 24	V
Switching cycles (typ.)	N	100	
Switching time at V_{max} , I_{Smax}	t_S	≤ 10	s
Reference temperature (typ.)	T_{Ref}	120	°C
Resistance tolerance	ΔR_N	± 25 %	
Operating temperature range ($V = 0$)	T_{op}	- 40/+ 125	°C
($V = V_{max}$)	T_{op}	0/60	°C

Type	I_N	I_S	I_{Smax} ($V = V_{max}$)	I_r (typ.) ($V = V_{max}$)	I_r (typ.) ($V = 12$ V)	R_N	R_{min}	Ordering code
	mA	mA	A	mA	mA	Ω	Ω	
C 915	2500	5000	15,0	220	490	0,2	0,1	B59915-C120-A70
C 935	1800	3600	10,0	170	380	0,3	0,2	B59935-C120-A70
C 945	1300	2600	8,0	115	250	0,45	0,3	B59945-C120-A70
C 955	850	1700	5,5	80	175	0,8	0,5	B59955-C120-A70
C 965	600	1200	4,3	70	150	1,2	0,7	B59965-C120-A70
C 975	450	900	3,0	60	130	1,8	1,1	B59975-C120-A70
C 985	250	500	1,0	45	100	4,6	2,7	B59985-C120-A70
C 995	120	240	0,7	25	54	13	7,8	B59995-C120-A70

Characteristics (typical)

PTC resistance R_{PTC} versus
 PTC temperature T_{PTC}
 (measured at low signal voltage)

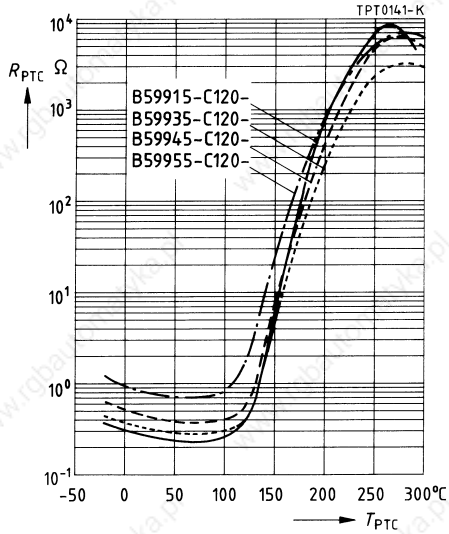

PTC current I_{PTC} versus PTC voltage V_{PTC}
 (measured at 25 $^{\circ}C$ in still air)

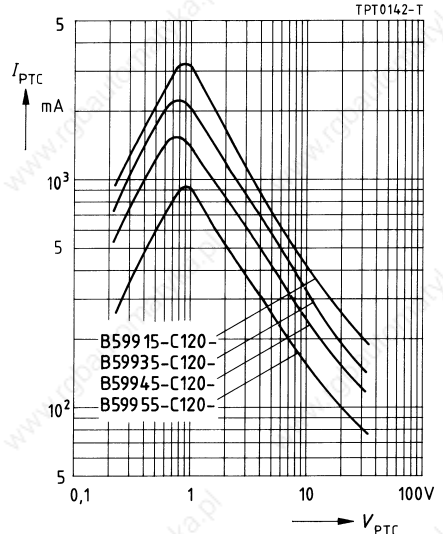

Switching time t_S versus switching current I_S
 (measured at 25 $^{\circ}C$ in still air)

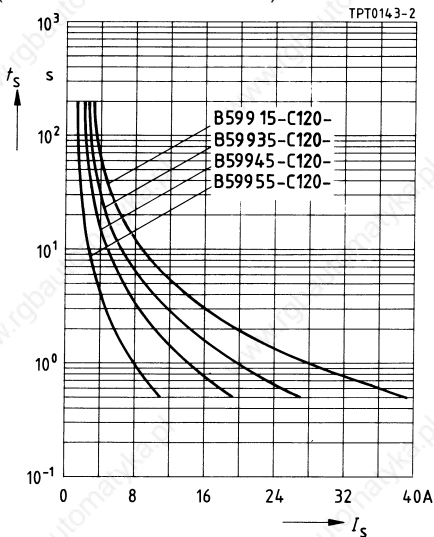

Rated current I_N versus ambient temperature T_A
 (measured in still air)

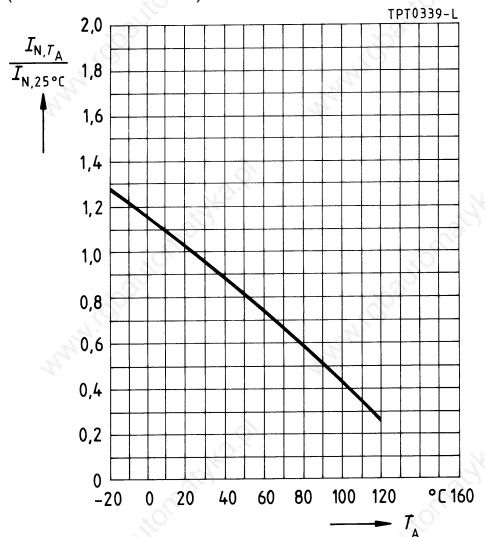

Characteristics (typical)

PTC resistance R_{PTC} versus
 PTC temperature T_{PTC}
 (measured at low signal voltage)

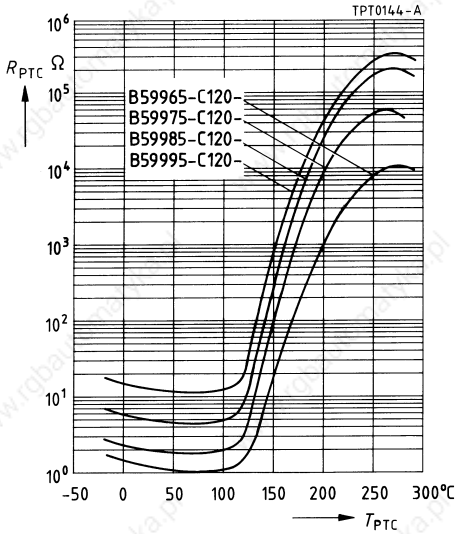

PTC current I_{PTC} versus PTC voltage V_{PTC}
 (measured at 25 °C in still air)

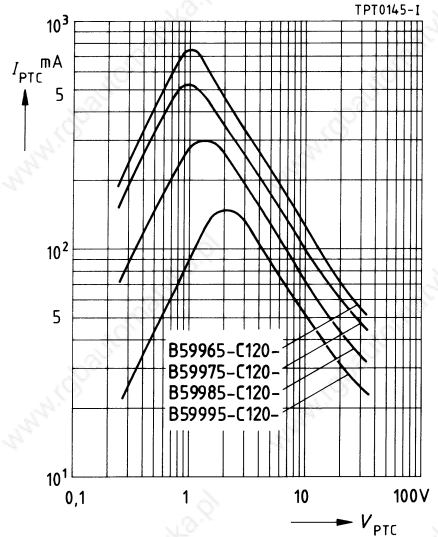

Switching time t_S versus switching current I_S
 (measured at 25 °C in still air)

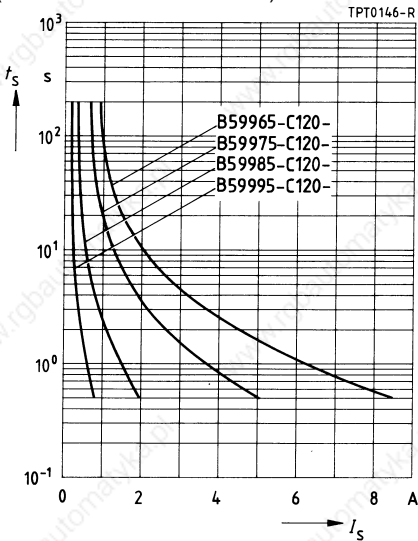

Rated current I_N versus ambient temperature T_A
 (measured in still air)

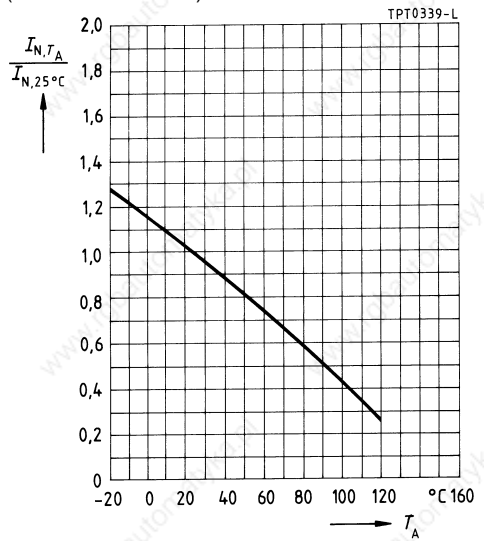

54 V, 160 °C

Applications

- Overcurrent and short-circuit protection

Features

- Coated thermistor disk
- Manufacturer's logo and type designation stamped on in yellow
- UL approval (E69802)
- VDE approval (exception: C910)

Options

- Leadless disks and leaded disks without coating available upon request
- Thermistors with diameter $b \leq 11,0$ mm are also available on tape

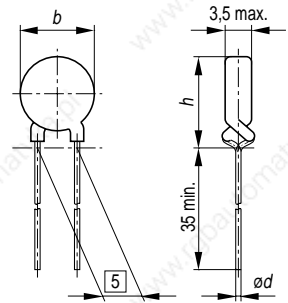

Dimensions (mm)

Type	b_{max}	$\varnothing d$	h_{max}
C 910	26,0	0,8	29,5
C 930	22,0	0,6	25,5
C 940	17,5	0,6	21,0
C 950	13,5	0,6	17,0
C 960	11,0	0,6	14,5
C 970	9,0	0,6	12,5
C 980	6,5	0,6	10,0
C 990	4,0	0,5	7,5

Max. operating voltage ($T_A = 60\text{ °C}$)	V_{max}	54	V
Rated voltage	V_N	42	V
Switching cycles (typ.)	N	100	
Switching time at V_{max} , I_{Smax}	t_S	≤ 6	s
Reference temperature (typ.)	T_{Ref}	160	°C
Resistance tolerance	ΔR_N	$\pm 25\%$	
Operating temperature range ($V = 0$)	T_{op}	$-40/+125$	°C
	T_{op}	0/60	°C

Type	I_N mA	I_S mA	I_{Smax} ($V=V_{max}$) A	I_r (typ.) ($V=V_{max}$) mA	R_N Ω	R_{min} Ω	Ordering code
C 910	1150	2370	15,0	110	0,9	0,6	B59910-C160-A70
C 930	770	1570	10,0	70	1,65	1,1	B59930-C160-A70
C 940	550	1140	8,0	50	2,3	1,5	B59940-C160-A70
C 950	360	730	5,5	35	3,7	2,4	B59950-C160-A70
C 960	280	560	4,3	30	5,6	3,7	B59960-C160-A70
C 970	170	355	3,0	25	9,4	6,2	B59970-C160-A70
C 980	95	200	1,0	20	25	16,5	B59980-C160-A70
C 990	55	120	0,7	15	55	36,3	B59990-C160-A70

Characteristics (typical)

PTC resistance R_{PTC} versus
 PTC temperature T_{PTC}
 (measured at low signal voltage)

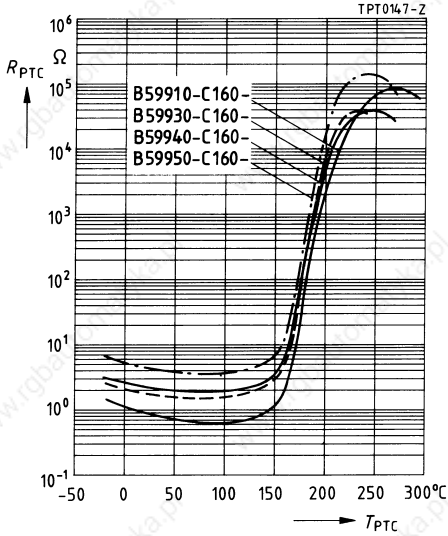

PTC current I_{PTC} versus PTC voltage V_{PTC}
 (measured at 25 °C in still air)

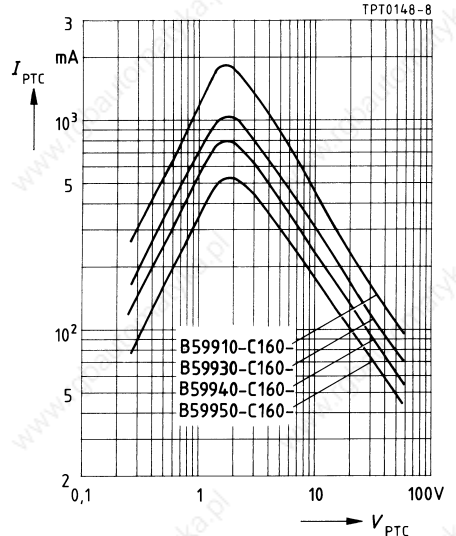

Switching time t_S versus switching current I_S
 (measured at 25 °C in still air)

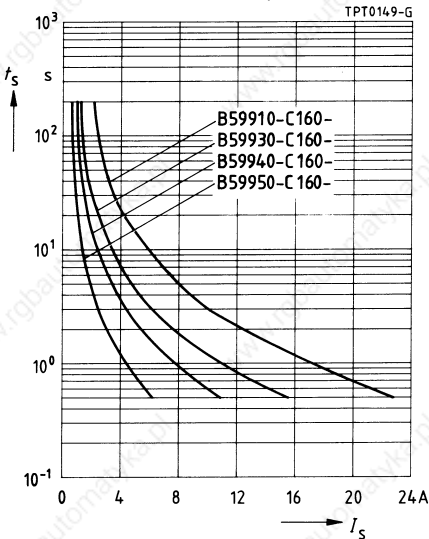

Rated current I_N versus ambient temperature T_A
 (measured in still air)

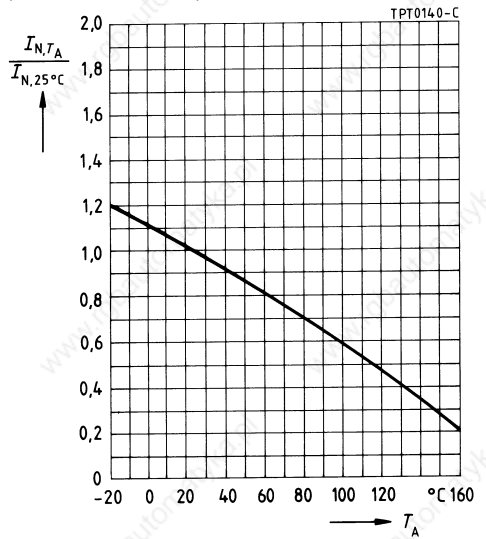

Characteristics (typical)

PTC resistance R_{PTC} versus
PTC temperature T_{PTC}
(measured at low signal voltage)

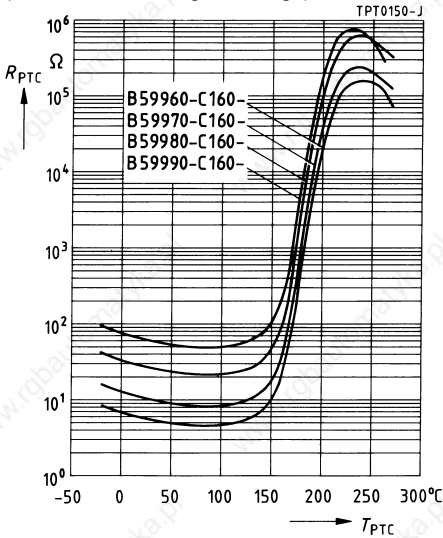

PTC current I_{PTC} versus PTC voltage V_{PTC}
(measured at 25 °C in still air)

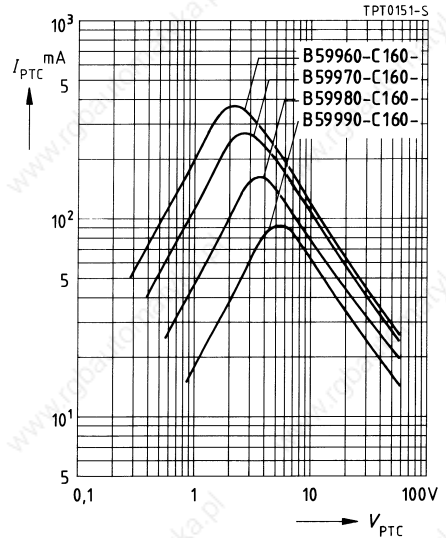

Switching time t_S versus switching current I_S
(measured at 25 °C in still air)

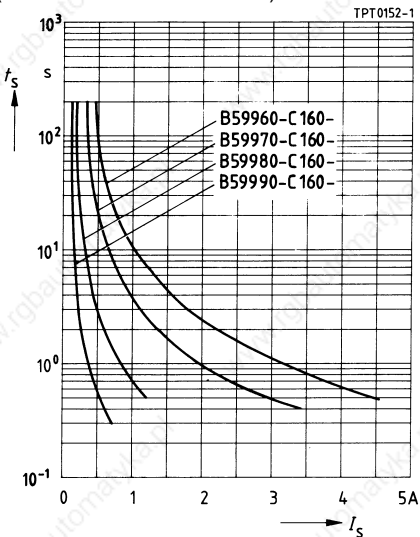

Rated current I_N versus ambient temperature T_A
(measured in still air)

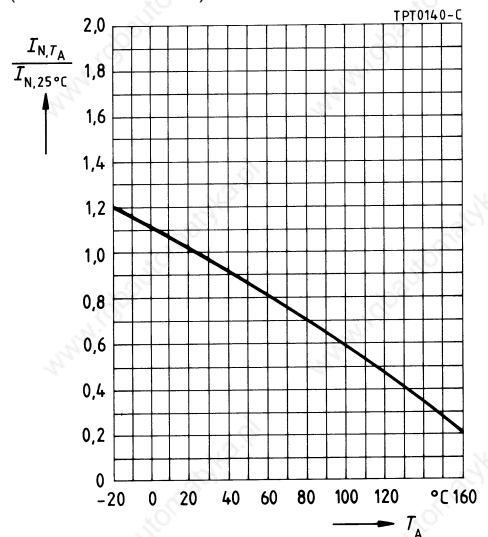

80 V, 80 °C

Applications

- Overcurrent and short-circuit protection

Features

- Coated thermistor disk
- Manufacturer's logo and type designation stamped on in black or red
- Short response times
- Reduced device temperature at V_{max}
- VDE approval (exception: C910)

Options

- Leadless disks and leaded disks without coating available upon request
- Thermistors with diameter $b \leq 11,0$ mm are also available on tape

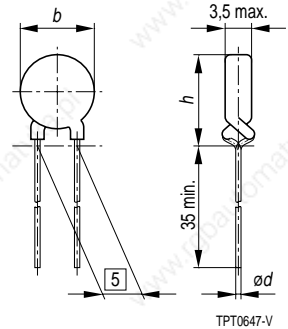

Dimensions (mm)

Type	b_{max}	$\varnothing d$	h_{max}
C 910	26,0	0,8	29,5
C 930	22,0	0,6	25,5
C 940	17,5	0,6	21,0
C 950	13,5	0,6	17,0
C 960	11,0	0,6	14,5
C 970	9,0	0,6	12,5
C 980	6,5	0,6	10,0
C 990	4,0	0,5	7,5

Max. operating voltage ($T_A = 60$ °C)	V_{max}	80	V
Rated voltage	V_N	63	V
Switching cycles (typ.)	N	100	
Switching time at V_{max} , I_{Smax}	t_S	≤ 2	s
Reference temperature (typ.)	T_{Ref}	80	°C
Resistance tolerance	ΔR_N	± 25 %	
Operating temperature range ($V = 0$)	T_{op}	$- 40/+ 125$	°C
	T_{op}	0/60	°C

Type	I_N mA	I_S mA	I_{Smax} ($V=V_{max}$) A	I_r (typ.) ($V=V_{max}$) mA	R_N Ω	R_{min} Ω	Ordering code
C 910	530	1100	15,0	50	0,9	0,6	B59910-C80-A70
C 930	340	700	10,0	35	1,65	1,1	B59930-C80-A70
C 940	245	500	8,0	25	2,3	1,5	B59940-C80-A70
C 950	170	350	5,5	20	3,7	2,4	B59950-C80-A70
C 960	130	265	4,3	15	5,6	3,7	B59960-C80-A70
C 970	90	190	3,0	11	9,4	6,2	B59970-C80-A70
C 980	50	110	1,0	8	25	16,5	B59980-C80-A70
C 990	30	60	0,7	5	55	36,3	B59990-C80-A70

Characteristics (typical)

PTC resistance R_{PTC} versus
 PTC temperature T_{PTC}
 (measured at low signal voltage)

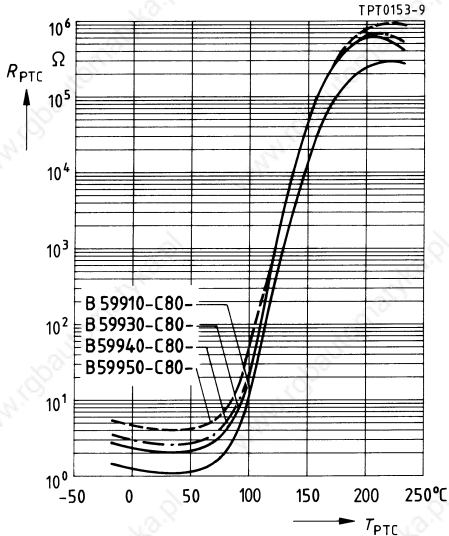

PTC current I_{PTC} versus PTC voltage V_{PTC}
 (measured at 25 °C in still air)

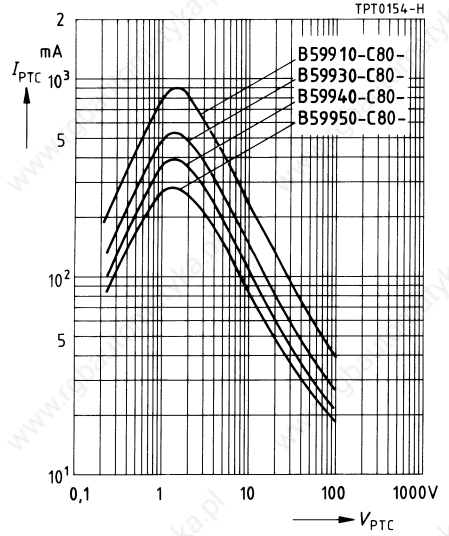

Switching time t_S versus switching current I_S
 (measured at 25 °C in still air)

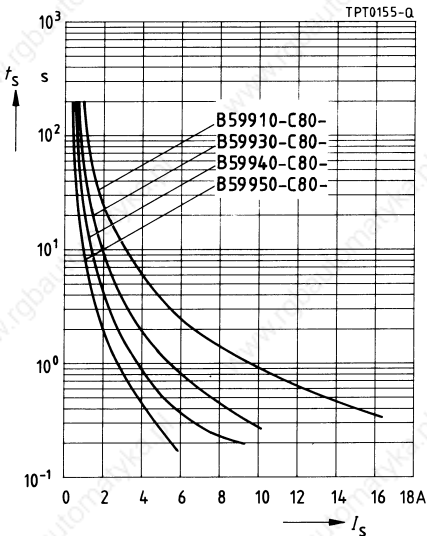

Rated current I_N versus ambient temperature T_A
 (measured in still air)

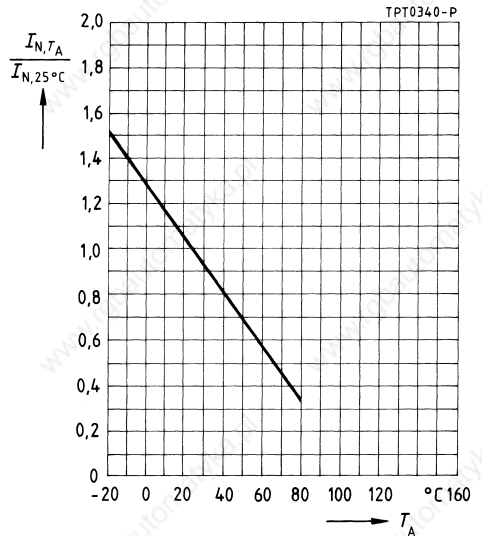

Characteristics (typical)

PTC resistance R_{PTC} versus
 PTC temperature T_{PTC}
 (measured at low signal voltage)

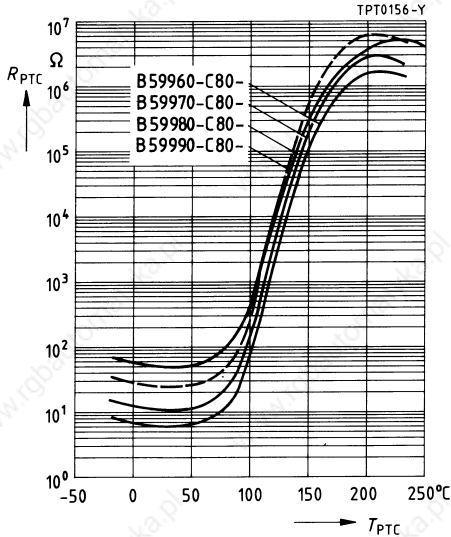

Switching time t_S versus switching current I_S
 (measured at 25 °C in still air)

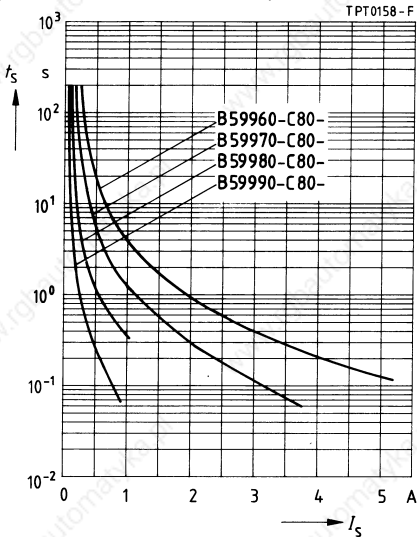

PTC current I_{PTC} versus PTC voltage V_{PTC}
 (measured at 25 °C in still air)

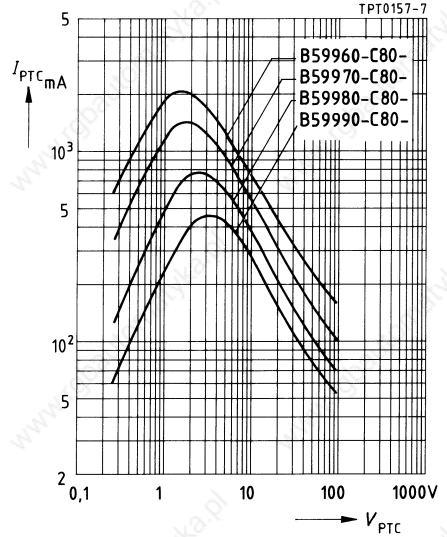

Rated current I_N versus ambient temperature T_A
 (measured in still air)

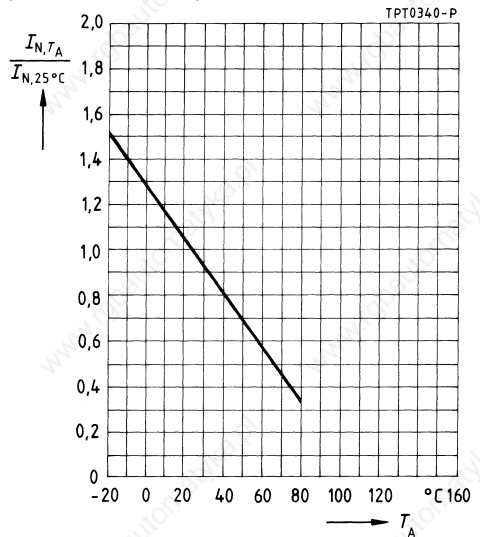

80 V, 120 °C

Applications

- Overcurrent and short-circuit protection

Features

- Coated thermistor disk
- Manufacturer's logo and type designation stamped on in white
- UL approval (E69802)
- VDE approval (exception: C910)

Options

- Leadless disks and leaded disks without coating available upon request
- Thermistors with diameter $b \leq 11,0$ mm are also available on tape

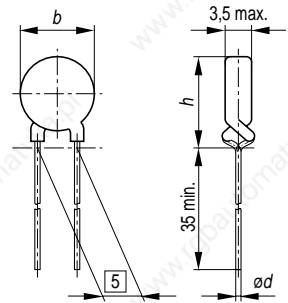

Dimensions (mm)

Type	b_{max}	$\varnothing d$	h_{max}
C 910	26,0	0,8	29,5
C 930	22,0	0,6	25,5
C 940	17,5	0,6	21,0
C 950	13,5	0,6	17,0
C 960	11,0	0,6	14,5
C 970	9,0	0,6	12,5
C 980	6,5	0,6	10,0
C 990	4,0	0,5	7,5

Max. operating voltage ($T_A = 60\text{ °C}$)	V_{max}	80	V
Rated voltage	V_N	63	V
Switching cycles (typ.)	N	100	
Switching time at V_{max} , I_{Smax}	t_S	≤ 4	s
Reference temperature (typ.)	T_{Ref}	120	°C
Resistance tolerance	ΔR_N	$\pm 25\%$	
Operating temperature range ($V = 0$)	T_{op}	$-40/+125$	°C
($V = V_{max}$)	T_{op}	0/60	°C

Type	I_N	I_S	I_{Smax} ($V = V_{max}$)	I_r (typ.) ($V = V_{max}$)	R_N	R_{min}	Ordering code
	mA	mA	A	mA	Ω	Ω	
C 910	1000	2000	15,0	65	0,9	0,6	B59910-C120-A70
C 930	700	1400	10,0	50	1,65	1,1	B59930-C120-A70
C 940	450	900	8,0	40	2,3	1,5	B59940-C120-A70
C 950	320	640	5,5	30	3,7	2,4	B59950-C120-A70
C 960	250	500	4,3	25	5,6	3,7	B59960-C120-A70
C 970	150	300	3,0	20	9,4	6,2	B59970-C120-A70
C 980	85	170	1,0	16	25	16,5	B59980-C120-A70
C 990	50	100	0,7	12	55	36,3	B59990-C120-A70

Characteristics (typical)

PTC resistance R_{PTC} versus
 PTC temperature T_{PTC}
 (measured at low signal voltage)

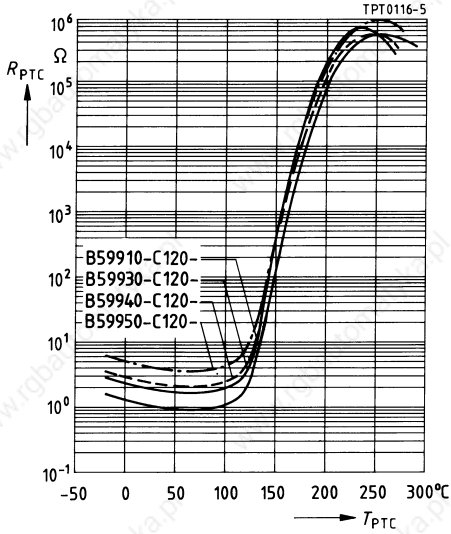

PTC current I_{PTC} versus PTC voltage V_{PTC}
 (measured at 25 °C in still air)

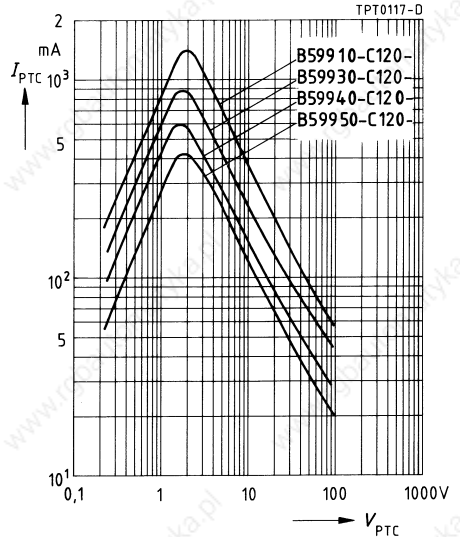

Switching time t_S versus switching current I_S
 (measured at 25 °C in still air)

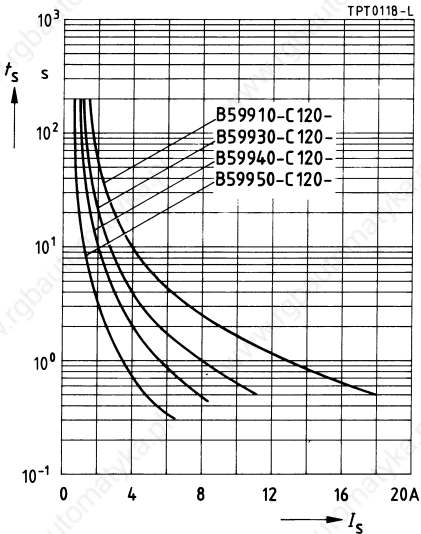

Rated current I_N versus ambient temperature T_A
 (measured in still air)

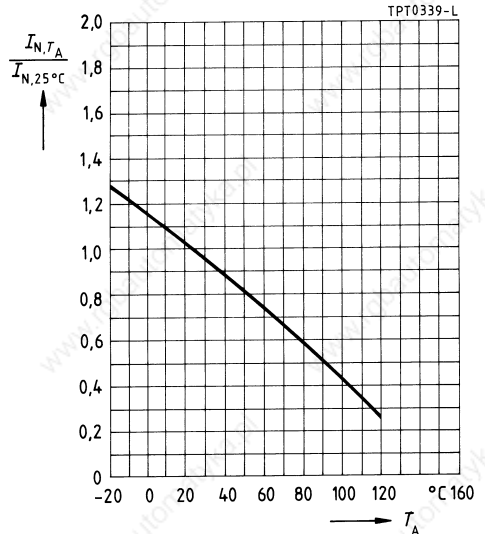

Characteristics (typical)

PTC resistance R_{PTC} versus
 PTC temperature T_{PTC}
 (measured at low signal voltage)

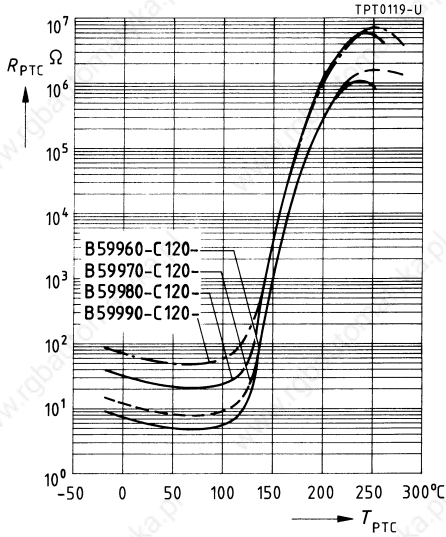

PTC current I_{PTC} versus PTC voltage V_{PTC}
 (measured at 25°C in still air)

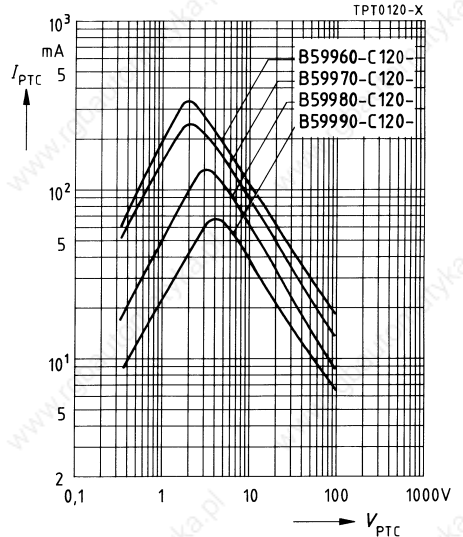

Switching time t_S versus switching current I_S
 (measured at 25°C in still air)

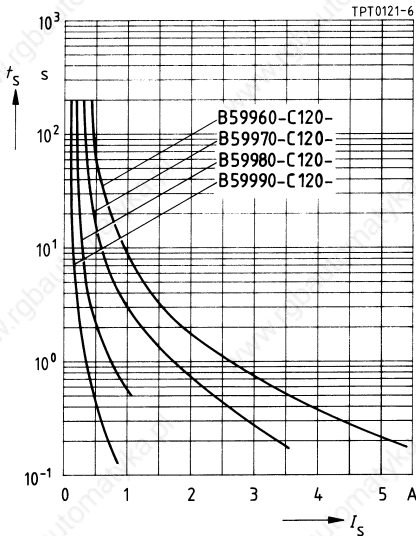

Rated current I_N versus ambient temperature T_A
 (measured in still air)

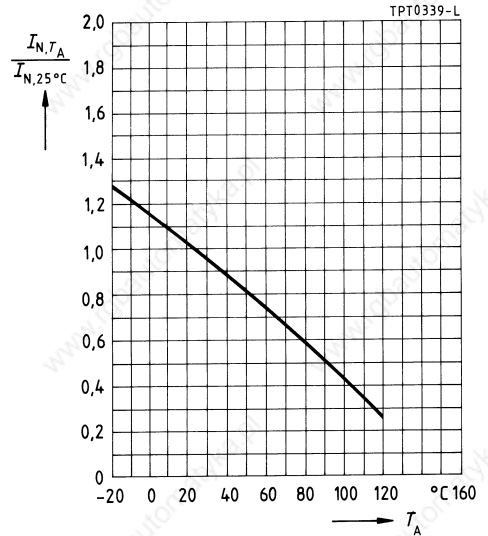

80 V, 130 °C

Applications

- Overcurrent and short-circuit protection
- Transformer protection
- Automotive electronics

Features

- Coated thermistor disk
- Manufacturer's logo and type designation stamped on in white
- UL approval (E69802)
- Ratio switching current – rated current $I_S/I_N \approx 1,5$
- Leads of pure copper wire

Options

- Leadless disks and leaded disks without coating available upon request
- Thermistors with diameter $b \leq 11,0$ mm are also available on tape

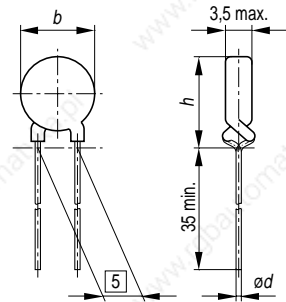

TPT0647-V

Dimensions (mm)

Type	b_{max}	$\varnothing d$	h_{max}
C 910	22,0	0,8	25,5
C 930	17,5	0,8	21,0
C 940	13,5	0,6	17,0
C 950	11,0	0,6	14,5
C 960	9,0	0,6	12,5
C 970	6,5	0,6	10,0
C 980	4,0	0,6	7,5

Max. operating voltage ($T_A = 60$ °C)	V_{max}	80	V
Rated voltage	V_N	63	V
Switching cycles (typ.)	N	100	
Switching time at V_{max}, I_{Smax}	t_S	≤ 8	s
Reference temperature (typ.)	T_{Ref}	130	°C
Resistance tolerance	ΔR_N	± 20 %	
Operating temperature range ($V = 0$)	T_{op}	$- 40/+ 125$	°C
	T_{op}	0/60	°C

Type	I_N mA	I_S mA	I_{Smax} ($V=V_{max}$) A	I_r (typ.) ($V=V_{max}$) mA	R_N Ω	R_{min} Ω	Ordering code
C 910	1000	1500	10,0	60	1,2	0,8	B59910-C130-A70
C 930	700	1100	8,0	50	2,2	1,5	B59930-C130-A70
C 940	450	690	5,5	30	3,3	2,2	B59940-C130-A70
C 950	320	500	4,3	25	4,9	3,2	B59950-C130-A70
C 960	250	380	3,0	20	8,0	5,2	B59960-C130-A70
C 970	150	240	1,0	18	20	13,2	B59970-C130-A70
C 980	85	130	0,7	15	62	40,9	B59980-C130-A70

Characteristics (typical)

PTC resistance R_{PTC} versus
 PTC temperature T_{PTC}
 (measured at low signal voltage)

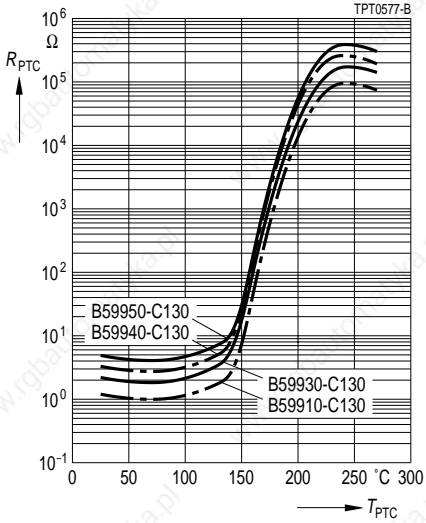

PTC current I_{PTC} versus PTC voltage V_{PTC}
 (measured at 25 °C in still air)

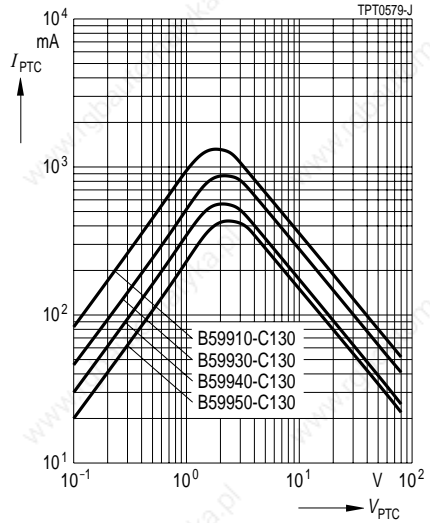

Switching time t_S versus switching current I_S
 (measured at 25 °C in still air)

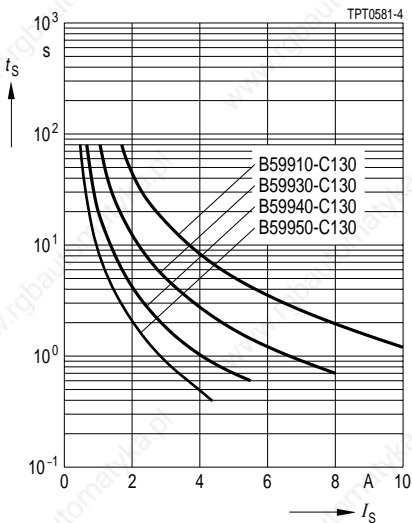

Rated current I_N versus ambient temperature T_A
 (measured in still air)

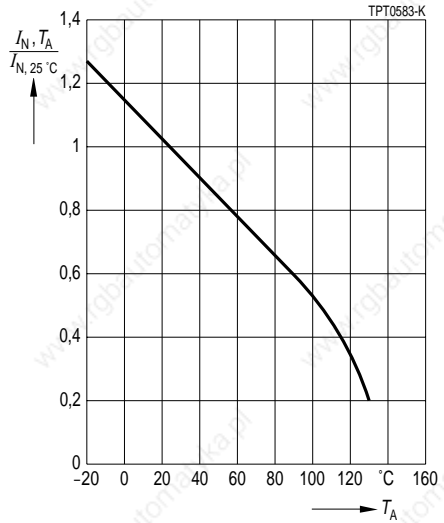

Characteristics (typical)

PTC resistance R_{PTC} versus
 PTC temperature T_{PTC}
 (measured at low signal voltage)

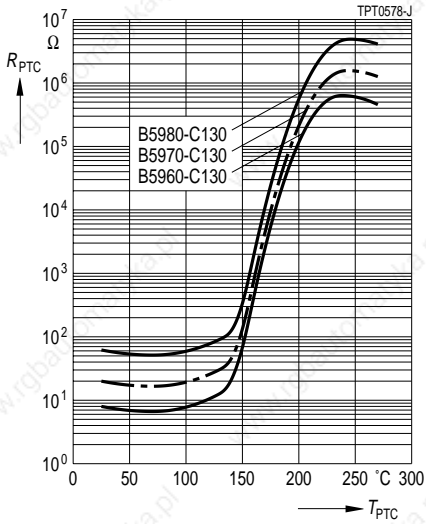

PTC current I_{PTC} versus PTC voltage V_{PTC}
 (measured at 25 °C in still air)

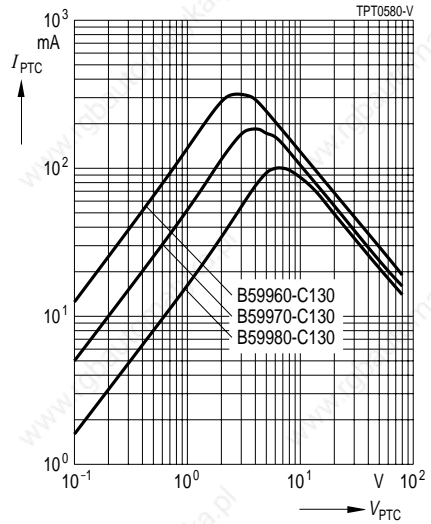

Switching time t_S versus switching current I_S
 (measured at 25 °C in still air)

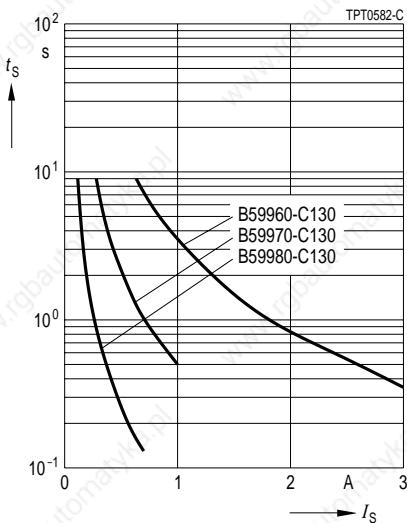

Rated current I_N versus ambient temperature T_A
 (measured in still air)

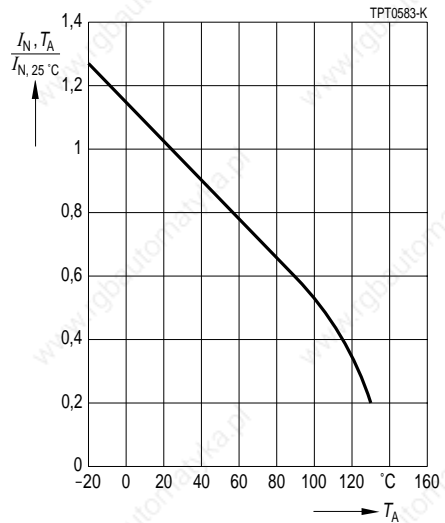

160 V, 160 °C

Applications

- Overcurrent and short-circuit protection

Features

- Coated thermistor disk
- Manufacturer's logo and type designation stamped on in yellow
- UL approval (E69802)
- VDE approval (exception: C810)

Options

- Leadless disks and leaded disks without coating available upon request
- Thermistors with diameter $b \leq 11,0$ mm are also available on tape

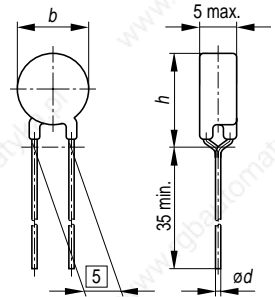

TPT0648-4

Dimensions (mm)

Type	b_{max}	$\varnothing d$	h_{max}
C 810	26,0	0,8	29,5
C 830	22,0	0,6	25,5
C 840	17,5	0,6	21,0
C 850	13,5	0,6	17,0
C 860	11,0	0,6	14,5
C 870	9,0	0,6	12,5
C 880	6,5	0,6	10,0
C 890	4,0	0,5	7,5

Max. operating voltage ($T_A = 60\text{ °C}$)	V_{max}	160	V
Rated voltage	V_N	110	V
Switching cycles (typ.)	N	100	
Switching time at V_{max} , I_{Smax}	t_S	≤ 10	s
Reference temperature (typ.)	T_{Ref}	160	°C
Resistance tolerance	ΔR_N	$\pm 25\%$	
Operating temperature range ($V = 0$)	T_{op}	$-40/+125$	°C
($V = V_{max}$)	T_{op}	0/60	°C

Type	I_N	I_S	I_{Smax} ($V = V_{max}$)	I_r (typ.) ($V = V_{max}$)	R_N	R_{min}	Ordering code
	mA	mA	A	mA	Ω	Ω	
C 810	800	1600	10,0	30	2,6	1,6	B59810-C160-A70
C 830	525	1050	7,0	24	3,7	2,2	B59830-C160-A70
C 840	400	800	4,1	18	6	3,6	B59840-C160-A70
C 850	250	500	2,2	16	10	6,0	B59850-C160-A70
C 860	180	360	1,5	13	15	7,8	B59860-C160-A70
C 870	125	250	1,0	11	25	13,1	B59870-C160-A70
C 880	70	140	0,4	8	70	36,7	B59880-C160-A70
C 890	35	70	0,2	6	150	78,7	B59890-C160-A70

Characteristics (typical)

PTC resistance R_{PTC} versus
 PTC temperature T_{PTC}
 (measured at low signal voltage)

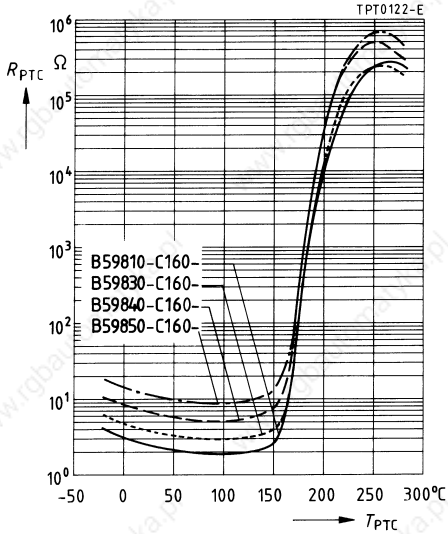

PTC current I_{PTC} versus PTC voltage V_{PTC}
 (measured at 25 °C in still air)

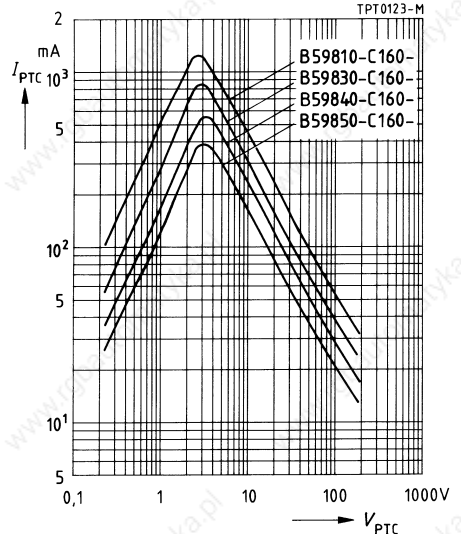

Switching time t_S versus switching current I_S
 (measured at 25 °C in still air)

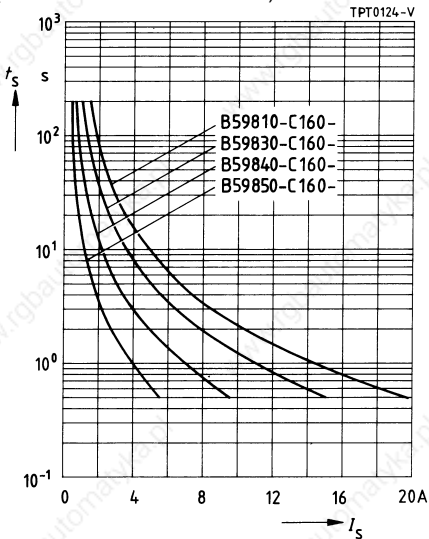

Rated current I_N versus ambient temperature T_A
 (measured in still air)

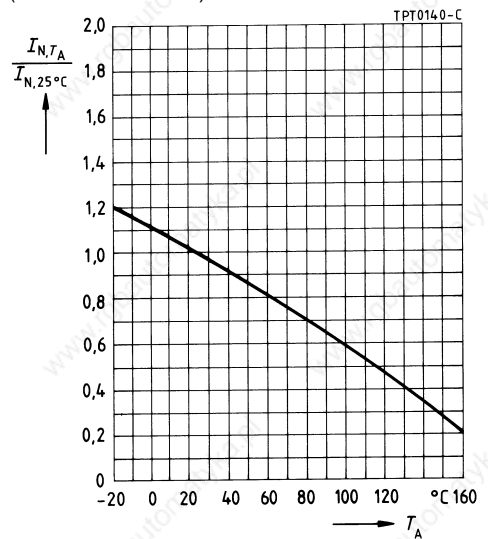

Characteristics (typical)

PTC resistance R_{PTC} versus
 PTC temperature T_{PTC}
 (measured at low signal voltage)

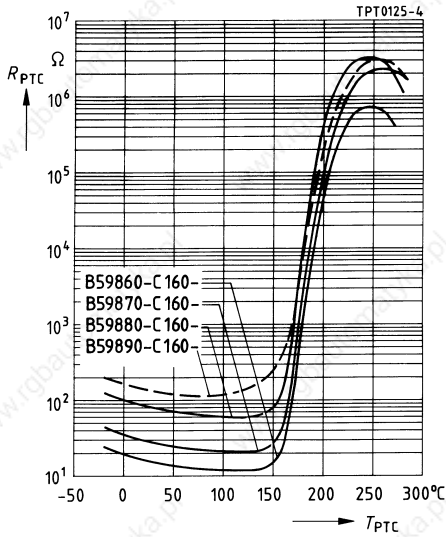

PTC current I_{PTC} versus PTC voltage V_{PTC}
 (measured at 25 °C in still air)

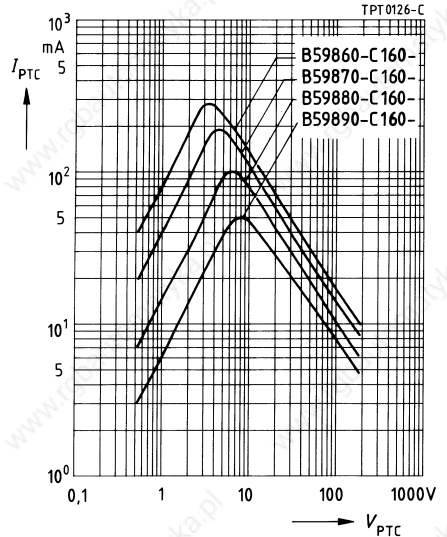

Switching time t_S versus switching current I_S
 (measured at 25 °C in still air)

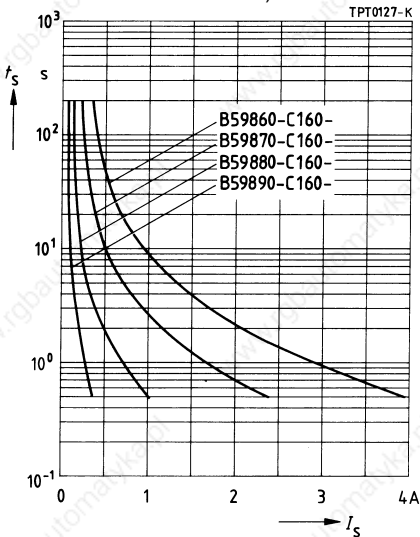

Rated current I_N versus ambient temperature T_A
 (measured in still air)

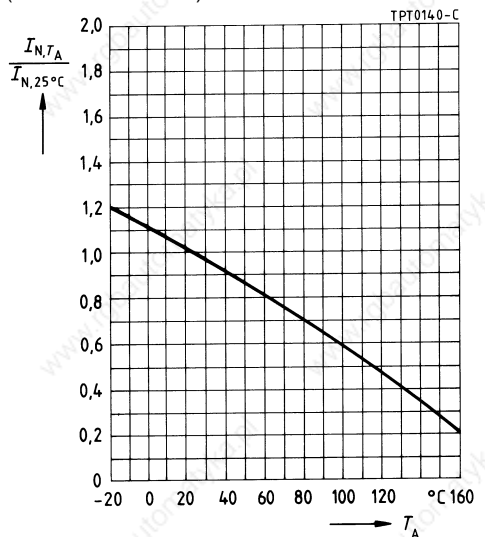

265 V, 80 °C

Applications

- Overcurrent and short-circuit protection

Features

- Coated thermistor disk
- Manufacturer's logo and type designation stamped on in black or red
- Short response times
- Reduced device temperature at V_{max}
- VDE approval (exception: C810)

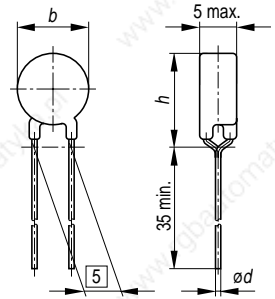

TPT0648-4

Options

- Leadless disks and leaded disks without coating available upon request
- Thermistors with diameter $b \leq 11,0$ mm are also available on tape

Dimensions (mm)

Type	b_{max}	$\varnothing d$	h_{max}
C 810	26,0	0,8	29,5
C 830	22,0	0,6	25,5
C 840	17,5	0,6	21,0
C 850	13,5	0,6	17,0
C 860	11,0	0,6	14,5
C 870	9,0	0,6	12,5
C 880	6,5	0,6	10,0
C 890	4,0	0,5	7,5

Max. operating voltage ($T_A = 60$ °C)	V_{max}	265	V
Rated voltage	V_N	230	V
Switching cycles (typ.)	N	100	
Switching time at V_{max} , I_{Smax}	t_S	≤ 6	s
Reference temperature (typ.)	T_{Ref}	80	°C
Resistance tolerance	ΔR_N	± 25 %	
Operating temperature range ($V = 0$)	T_{op}	$- 40/+ 125$	°C
	T_{op}	0/60	°C

Type	I_N	I_S	I_{Smax} ($V = V_{max}$)	I_r (typ.) ($V = V_{max}$)	R_N	R_{min}	Ordering code
	mA	mA	A	mA	Ω	Ω	
C 810	350	710	10,0	20	2,6	1,6	B59810-C80-A70
C 830	250	510	7,0	15	3,7	2,2	B59830-C80-A70
C 840	170	350	4,1	10	6	3,6	B59840-C80-A70
C 850	110	230	2,2	8	10	6,0	B59850-C80-A70
C 860	90	180	1,5	6	15	7,8	B59860-C80-A70
C 870	60	130	1,0	5	25	13,1	B59870-C80-A70
C 880	30	70	0,4	4	70	36,7	B59880-C80-A70
C 890	15	40	0,2	3	150	78,7	B59890-C80-A70

Characteristics (typical)

PTC resistance R_{PTC} versus
 PTC temperature T_{PTC}
 (measured at low signal voltage)

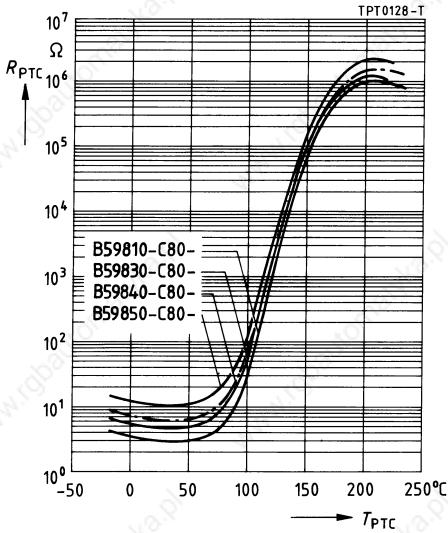

PTC current I_{PTC} versus PTC voltage V_{PTC}
 (measured at 25 $^{\circ}C$ in still air)

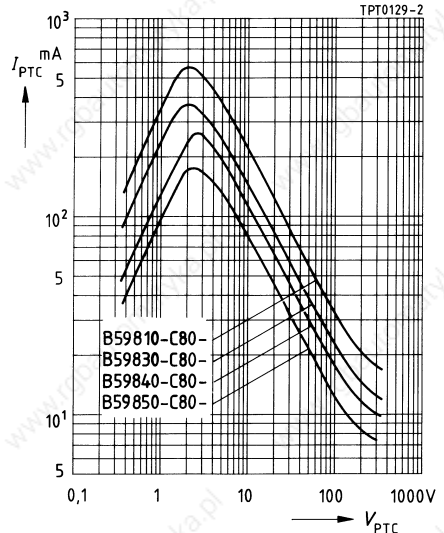

Switching time t_S versus switching current I_S
 (measured at 25 $^{\circ}C$ in still air)

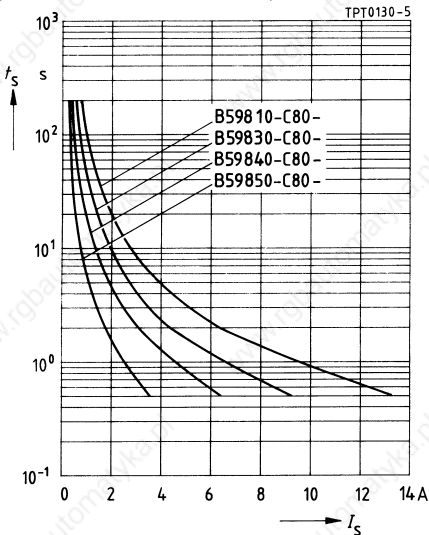

Rated current I_N versus ambient temperature T_A
 (measured in still air)

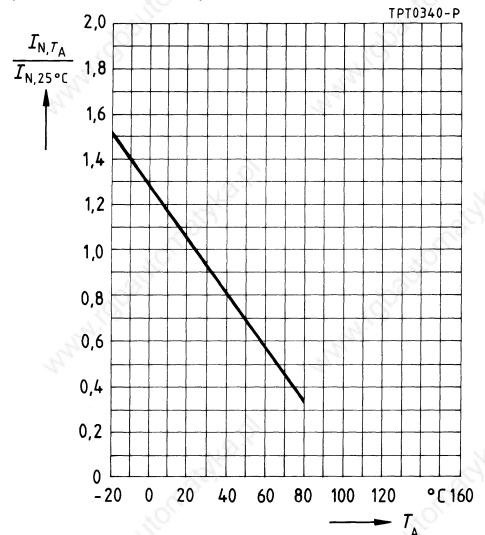

Characteristics (typical)

PTC resistance R_{PTC} versus
 PTC temperature T_{PTC}
 (measured at low signal voltage)

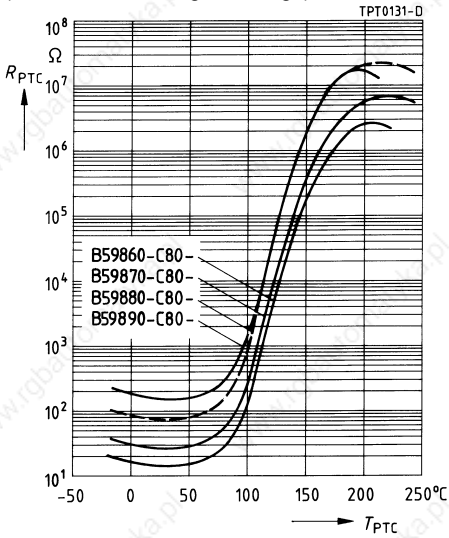

PTC current I_{PTC} versus PTC voltage V_{PTC}
 (measured at 25 °C in still air)

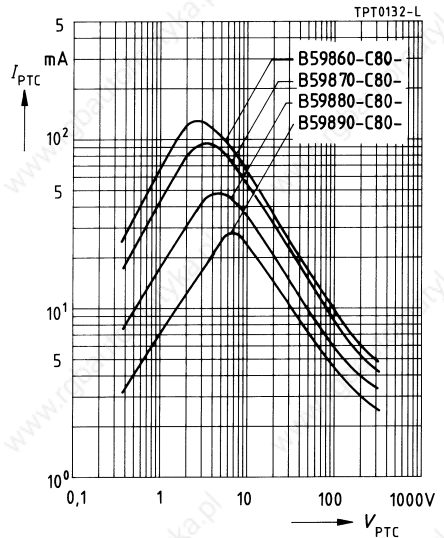

Switching time t_S versus switching current I_S
 (measured at 25 °C in still air)

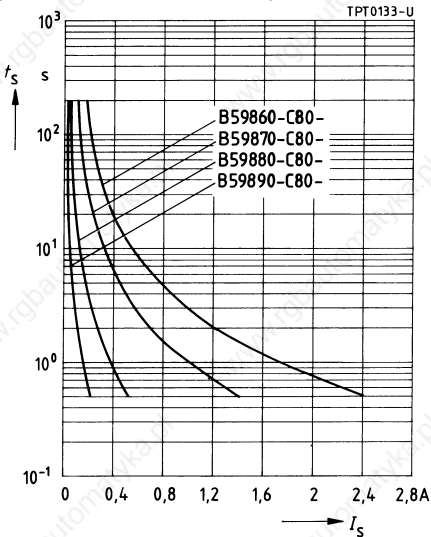

Rated current I_N versus ambient temperature T_A
 (measured in still air)

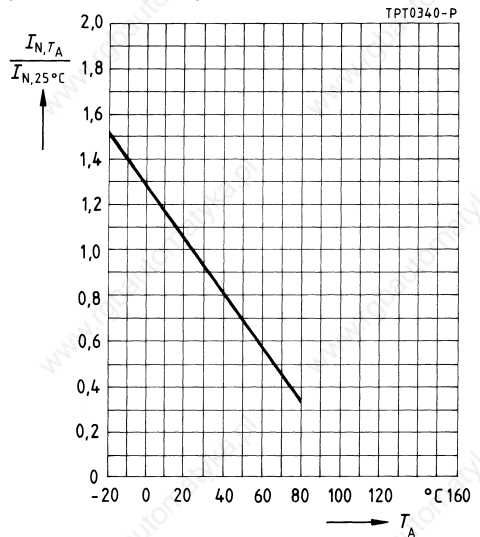

265 V, 130 °C

Applications

- Overcurrent and short-circuit protection
- Transformer protection
- Automotive electronics

Features

- Coated thermistor disk
- Manufacturer's logo and type designation stamped on in white
- UL approval (E69802)
- Ratio switching current – rated current $I_S/I_N \approx 1,5$
- Leads of pure copper wire

Options

- Leadless disks and leaded disks without coating available upon request
- Thermistors with diameter $b \leq 11,0$ mm are also available on tape

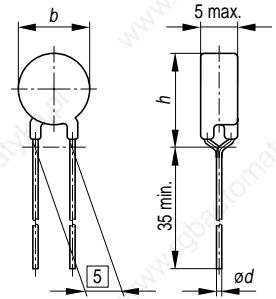

TPT0648-4

Dimensions (mm)

Type	b_{max}	$\varnothing d$	h_{max}
C 810	22,0	0,8	25,5
C 830	17,5	0,8	21,0
C 840	13,5	0,6	17,0
C 850	11,0	0,6	14,5
C 860	9,0	0,6	12,5
C 870	6,5	0,6	10,0
C 880	4,0	0,6	7,5

Max. operating voltage ($T_A = 60\text{ °C}$)	V_{max}	265	V
Rated voltage	V_N	230, 120	V
Switching cycles (typ.)	N	100	
Switching time at V_{max} , I_{Smax}	t_S	≤ 8	s
Reference temperature (typ.)	T_{Ref}	130	°C
Resistance tolerance	ΔR_N	$\pm 20\%$	
Operating temperature range ($V = 0$)	T_{op}	$-25/+125$	°C
($V = V_{max}$)	T_{op}	0/60	°C

Type	I_N	I_S	I_{Smax} ($V=V_{max}$)	I_r (typ.) ($V=V_{max}$)	I_r (typ.) ($V=120\text{ V}$)	R_N	R_{min}	Ordering code
	mA	mA	A	mA	mA	Ω	Ω	
C 810	650	980	7,0	20	40	3,5	2,3	B59810-C130-A70
C 830	450	680	4,1	15	30	5	3,3	B59830-C130-A70
C 840	330	500	2,2	13	25	9	5,9	B59840-C130-A70
C 850	200	320	1,5	10	20	13	8,6	B59850-C130-A70
C 860	140	230	1,0	9	18	25	16,5	B59860-C130-A70
C 870	100	150	0,4	6	15	50	33	B59870-C130-A70
C 880	55	90	0,2	5	12	160	106	B59880-C130-A70

Characteristics (typical)

PTC resistance R_{PTC} versus
 PTC temperature T_{PTC}
 (measured at low signal voltage)

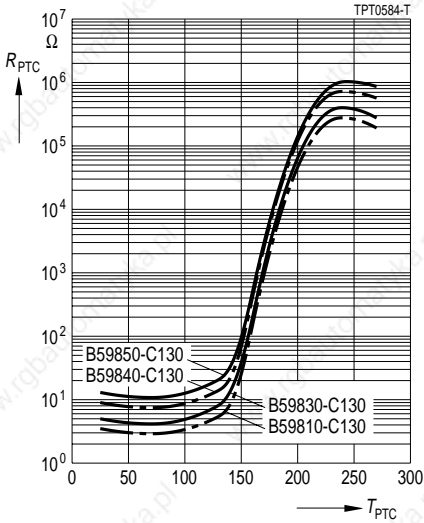

PTC current I_{PTC} versus PTC voltage V_{PTC}
 (measured at 25 °C in still air)

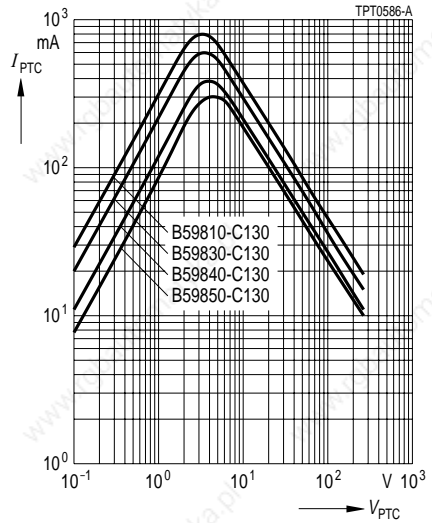

Switching time t_S versus switching current I_S
 (measured at 25 °C in still air)

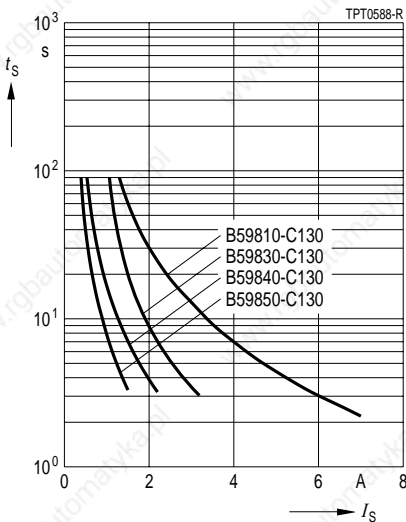

Rated current I_N versus ambient temperature T_A
 (measured in still air)

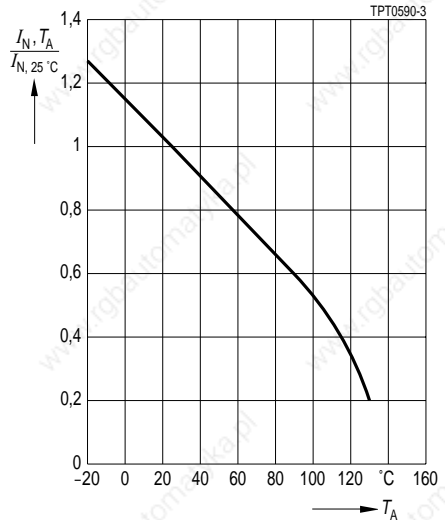

Characteristics (typical)

PTC resistance R_{PTC} versus
 PTC temperature T_{PTC}
 (measured at low signal voltage)

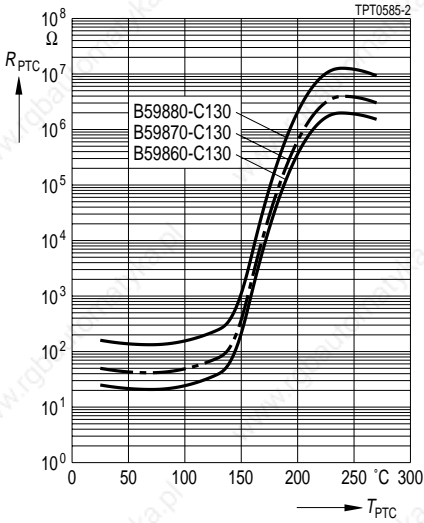

PTC current I_{PTC} versus PTC voltage V_{PTC}
 (measured at 25 °C in still air)

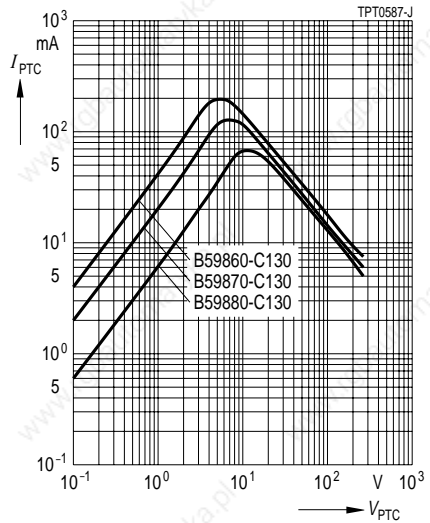

Switching time t_S versus switching current I_S
 (measured at 25 °C in still air)

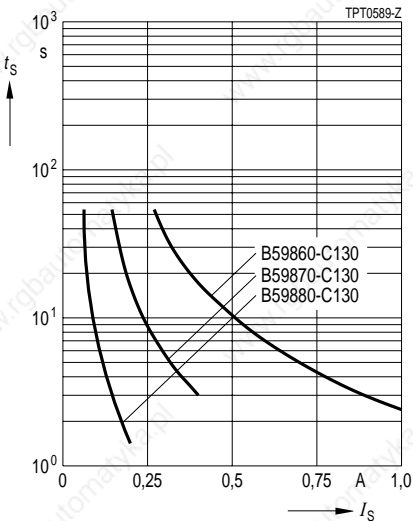

Rated current I_N versus ambient temperature T_A
 (measured in still air)

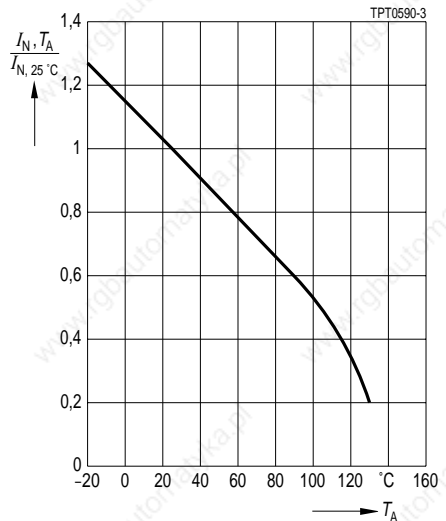

265 V, 135 °C

Applications

- Overcurrent and short-circuit protection
- For enhanced rated current requirements

Features

- Coated thermistor disk
- Surge-proof
- Manufacturer's logo and type designation stamped on in white
- VDE approval (exception: C811)

Options

- Leadless disks and leaded disks without coating available upon request
- Thermistors with diameter $b \leq 11,0$ mm are also available on tape

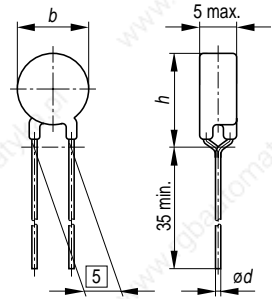

TPT0648-4

Dimensions (mm)

Type	b_{max}	$\varnothing d$	h_{max}
C 811	26,0	0,8	29,5
C 831	22,0	0,6	25,5
C 841	17,5	0,6	21,0
C 851	13,5	0,6	17,0
C 861	11,0	0,6	14,5
C 871	9,0	0,6	12,5
C 881	6,5	0,6	10,0
C 891	4,0	0,5	7,5

Max. operating voltage ($T_A = 60$ °C)	V_{max}	265	V
Rated voltage	V_N	230	V
Switching cycles (typ.)	N	100	
Reference temperature (typ.)	T_{Ref}	135	°C
Resistance tolerance	ΔR_N	± 25 %	
Operating temperature range ($V = 0$)	T_{op}	$-40/+125$	°C
	T_{op}	0/60	°C

Type	I_N	I_S	I_{Smax} ($V=V_{max}$)	t_S (V_{max}, I_{Smax})	I_r (typ.) ($V=V_{max}$)	R_N	R_{min}	Ordering code
	mA	mA	A	s	mA	Ω	Ω	
C 811	730	1450	10,0	< 10	25	2,6	1,8	B59811-C135-A70
C 831	470	970	7,0	< 8	20	3,7	2,6	B59831-C135-A70
C 841	350	700	4,1	< 8	15	6	4,3	B59841-C135-A70
C 851	215	445	2,2	< 8	13	10	7,1	B59851-C135-A70
C 861	150	320	1,5	< 8	10	15	10,6	B59861-C135-A70
C 871	108	225	1,0	< 8	9	25	17,8	B59871-C135-A70
C 881	60	120	0,4	< 8	6	70	49,8	B59881-C135-A70
C 891	30	65	0,2	< 8	5	150	107	B59891-C135-A70

Characteristics (typical)

PTC resistance R_{PTC} versus
PTC temperature T_{PTC}
(measured at low signal voltage)

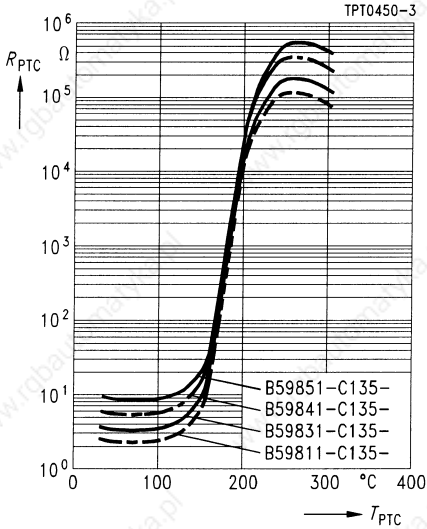

PTC current I_{PTC} versus PTC voltage V_{PTC}
(measured at 25 °C in still air)

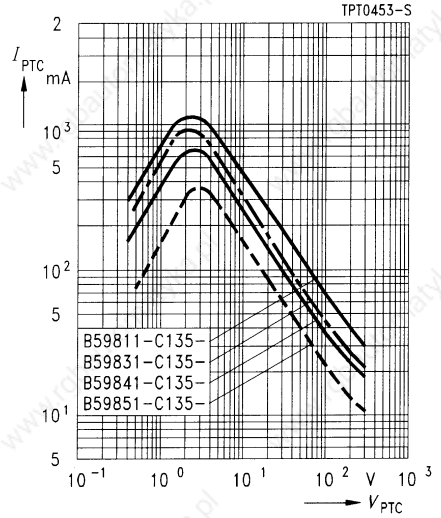

Switching time t_S versus switching current I_S
(measured at 25 °C in still air)

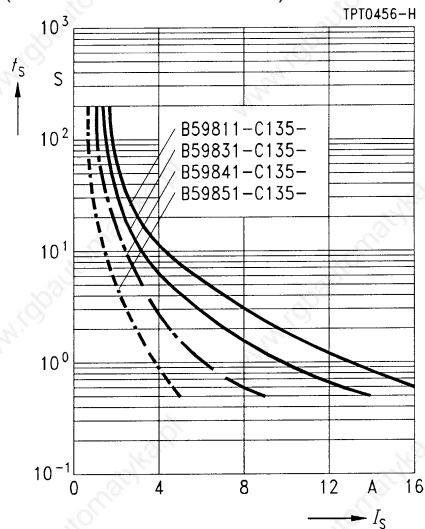

Rated current I_N versus ambient temperature T_A
(measured in still air)

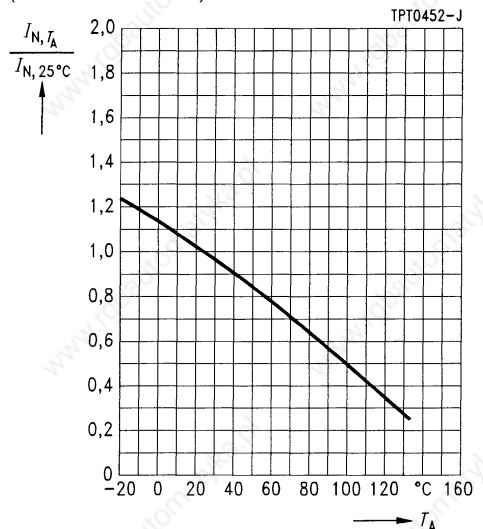

Characteristics (typical)

PTC resistance R_{PTC} versus
 PTC temperature T_{PTC}
 (measured at low signal voltage)

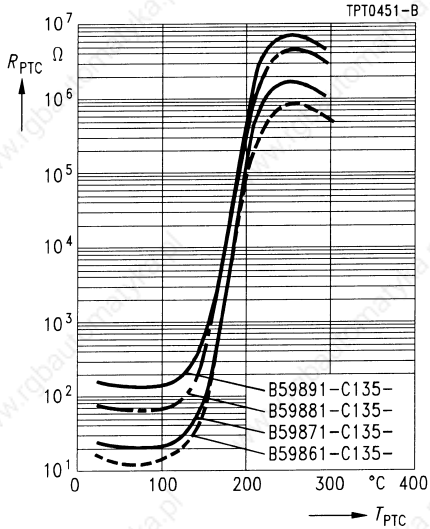

PTC current I_{PTC} versus PTC voltage V_{PTC}
 (measured at 25 °C in still air)

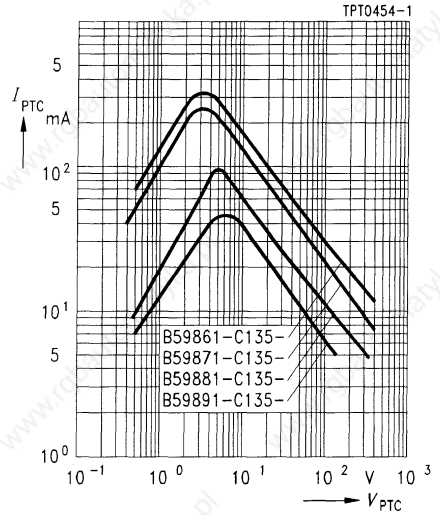

Switching time t_S versus switching current I_S
 (measured at 25 °C in still air)

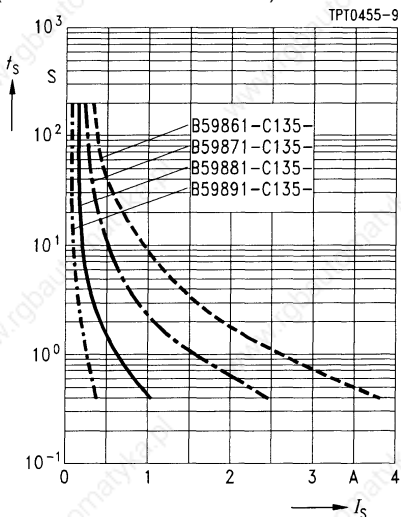

Rated current I_N versus ambient temperature T_A
 (measured in still air)

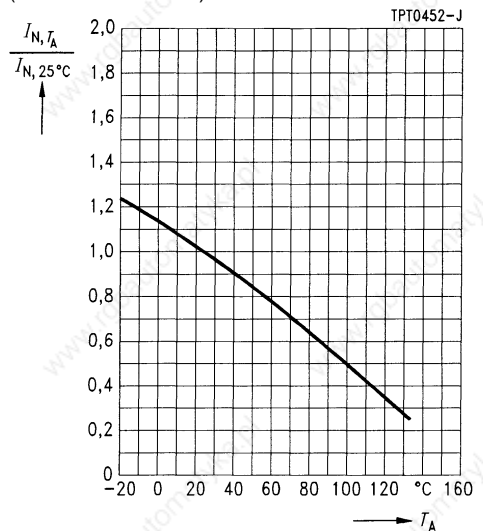

265 V to 550 V, 120 °C

Applications

- Overcurrent and short-circuit protection

Features

- Coated thermistor disk
- Manufacturer's logo and type designation stamped on in white
- UL approval (E69802) up to 265 V for all types
- VDE approval (exception: C810, C884, C885, C886)

Options

- Leadless disks and leaded disks without coating available upon request
- Thermistors with diameter $b \leq 11,0$ mm are also available on tape
- VDE / CECC approval for various 265-V types upon request

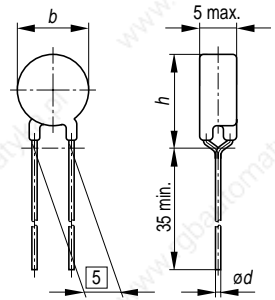

TPT0648-4

Dimensions (mm)

Type	b_{max}	$\varnothing d$	h_{max}
C 810	26,0	0,8	29,5
C 830	22,0	0,6	25,5
C 840	17,5	0,6	21,0
C 850	13,5	0,6	17,0
C 860	11,0	0,6	14,5
C 870	9,0	0,6	12,5
C 872	9,0	0,6	12,5
C 873	9,0	0,6	12,5
C 874	9,0	0,6	12,5
C 875	9,0	0,6	12,5
C 880	6,5	0,6	10,0
C 883	6,5	0,6	10,0
C 884	6,5	0,6	10,0
C 885	6,5	0,6	10,0
C 886	6,5	0,6	10,0
C 890	4,0	0,5	7,5

Switching cycles (typ.)	N	100	
Switching time at V_{max} , I_{Smax}	t_S	≤ 8	s
Resistance tolerance	ΔR_N	$\pm 25 \%$	
Operating temperature range ($V = 0$)	T_{op}	$- 40/+ 125$	°C
	T_{op}	0/60	°C

B598**
C 810 ... C 890

Type	I_N mA	I_S mA	I_{Smax} ($V=V_{max}$) A	I_r (typ.) ($V=V_{max}$) mA	I_r (typ.) ($V=120$ V) mA	R_N Ω	R_{min} Ω	Ordering code
$V_{max} = 265$ V, $V_N = 120$ V, 230 V, $T_{Ref} = 120$ °C (typ.)								
C 810	650	1300	10,0	25	50	2,6	1,6	B59810-C120-A70
C 830	460	920	7,0	20	40	3,7	2,4	B59830-C120-A70
C 840	330	660	4,1	15	30	6	3,8	B59840-C120-A70
C 850	200	400	2,2	13	20	10	6,4	B59850-C120-A70
C 860	140	280	1,5	10	18	15	9,0	B59860-C120-A70
C 870	100	200	1,0	9	15	25	15	B59870-C120-A70
C 872	80	160	1,0	9	15	35	21	B59872-C120-A70
C 873	70	140	1,0	9	15	45	27	B59873-C120-A70
C 874	60	125	1,0	9	15	55	31	B59874-C120-A70
C 875	55	110	1,0	9	15	65	36	B59875-C120-A70
C 880	55	110	0,4	6	12	70	39	B59880-C120-A70
C 883	35	70	0,4	5	12	120	67	B59883-C120-A70
C 890	30	60	0,2	5	10	150	84	B59890-C120-A70
$V_{max} = 420$ V, $V_N = 380$ V, $T_{Ref} = 120$ °C (typ.)								
C 884	21	39	0,2	3	–	600	340	B59884-C120-A70
$V_{max} = 550$ V, $V_N = 500$ V, $T_{Ref} = 115$ °C (typ.)								
C 885	15	30	0,1	3	–	1200	675	B59885-C120-A70
C 886	12	24	0,1	2	–	1500	840	B59886-C120-A70

Characteristics (typical)

PTC resistance R_{PTC} versus
 PTC temperature T_{PTC}
 (measured at low signal voltage)

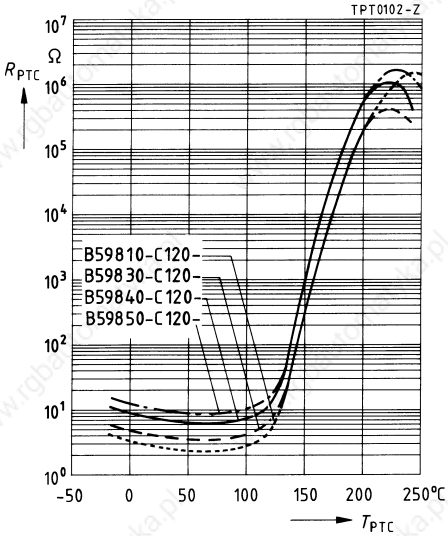

PTC current I_{PTC} versus PTC voltage V_{PTC}
 (measured at 25 °C in still air)

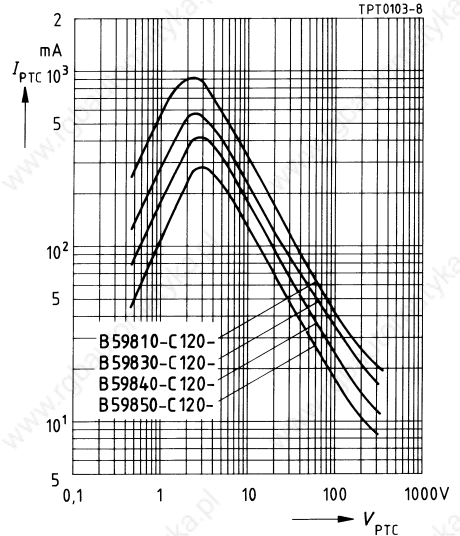

Switching time t_S versus switching current I_S
 (measured at 25 °C in still air)

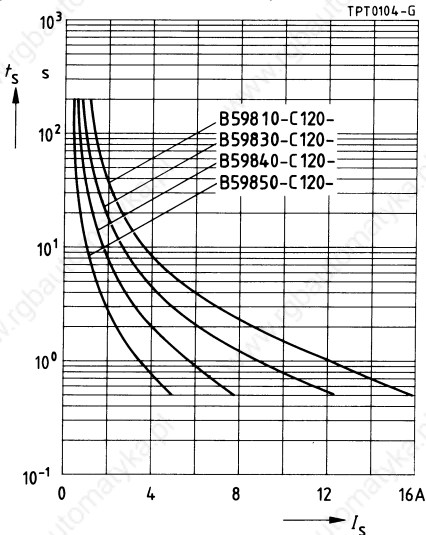

Rated current I_N versus ambient temperature T_A
 (measured in still air)

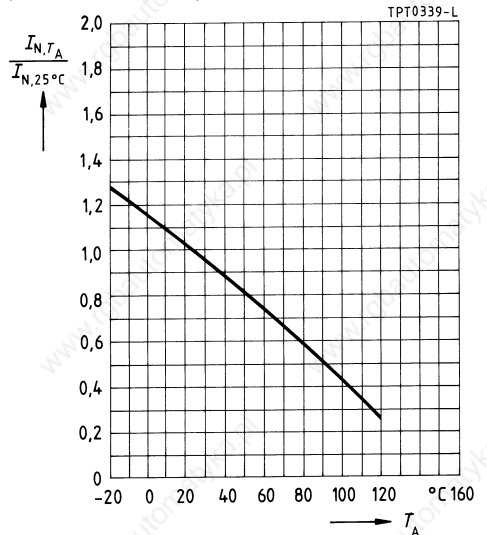

Characteristics (typical)

PTC resistance R_{PTC} versus
 PTC temperature T_{PTC}
 (measured at low signal voltage)

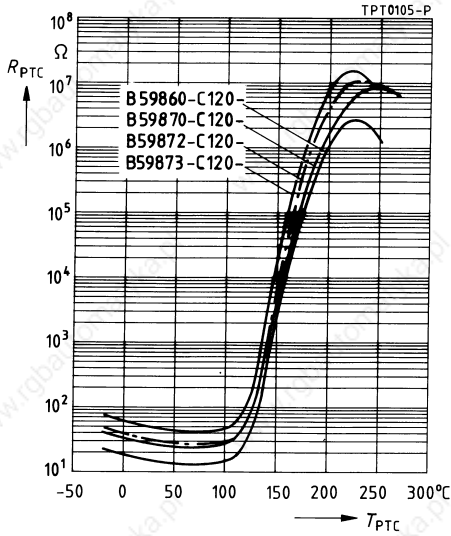

PTC current I_{PTC} versus PTC voltage V_{PTC}
 (measured at 25 °C in still air)

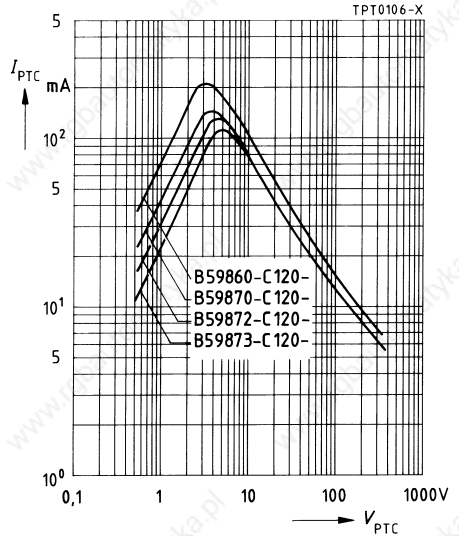

Switching time t_S versus switching current I_S
 (measured at 25 °C in still air)

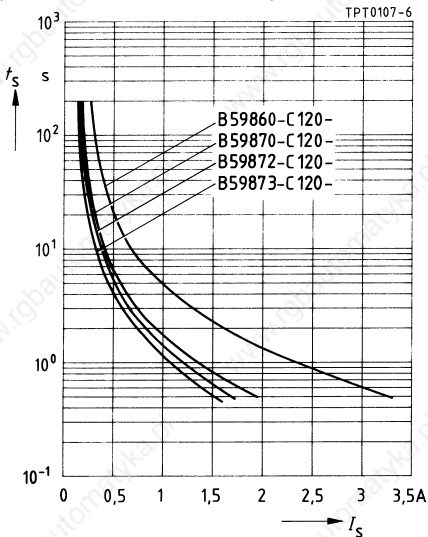

Rated current I_N versus ambient temperature T_A
 (measured in still air)

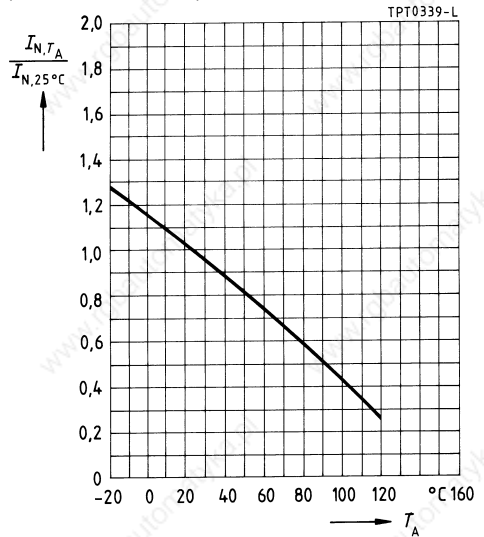

Characteristics (typical)

PTC resistance R_{PTC} versus
 PTC temperature T_{PTC}
 (measured at low signal voltage)

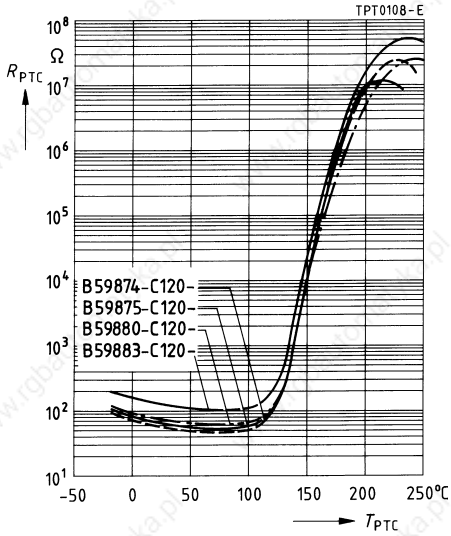

PTC current I_{PTC} versus PTC voltage V_{PTC}
 (measured at 25 °C in still air)

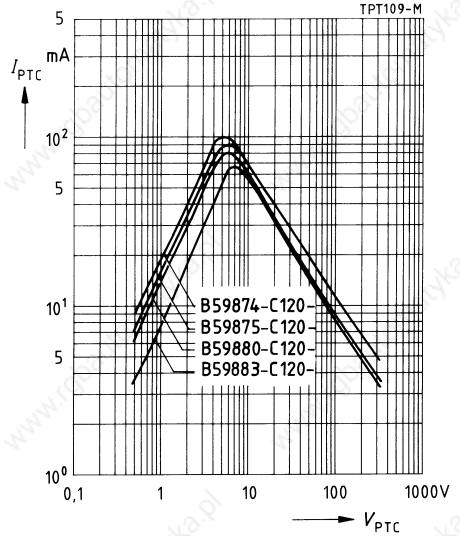

Switching time t_S versus switching current I_S
 (measured at 25 °C in still air)

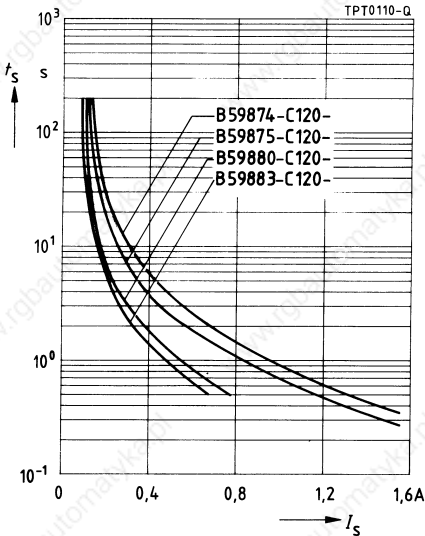

Rated current I_N versus ambient temperature T_A
 (measured in still air)

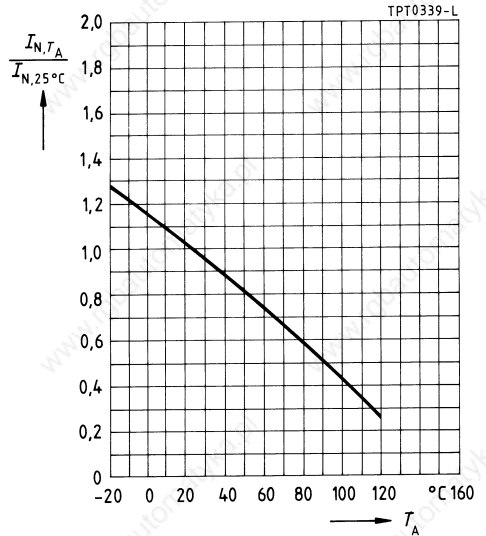

Characteristics (typical)

PTC resistance R_{PTC} versus
 PTC temperature T_{PTC}
 (measured at low signal voltage)

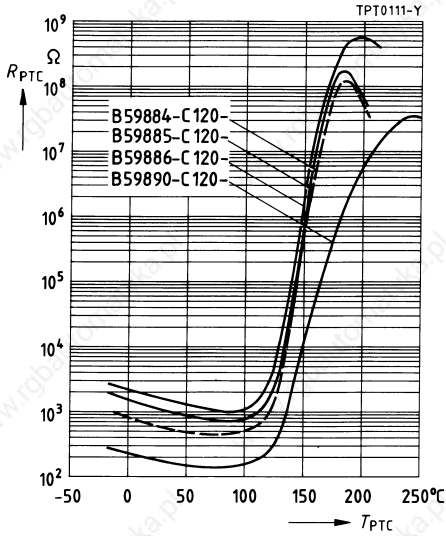

PTC current I_{PTC} versus PTC voltage V_{PTC}
 (measured at 25 °C in still air)

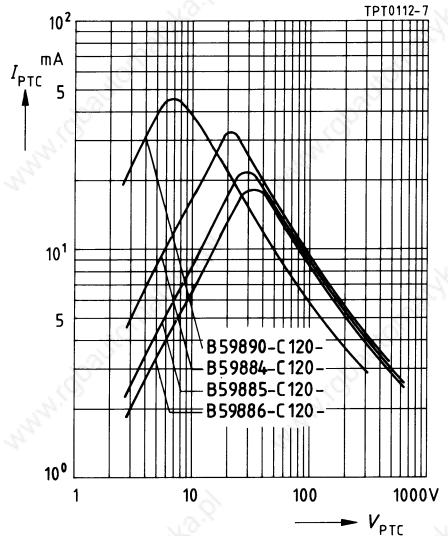

Switching time t_S versus switching current I_S
 (measured at 25 °C in still air)

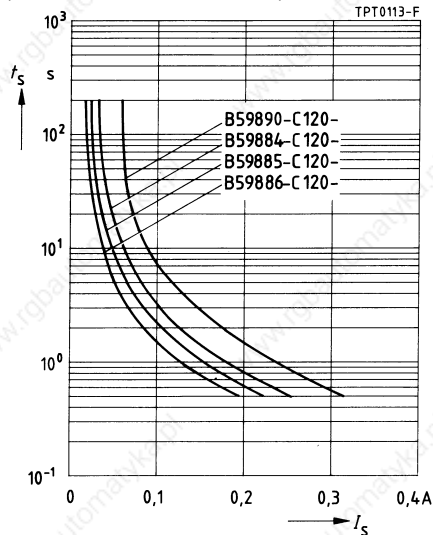

Rated current I_N versus ambient temperature T_A
 (measured in still air)

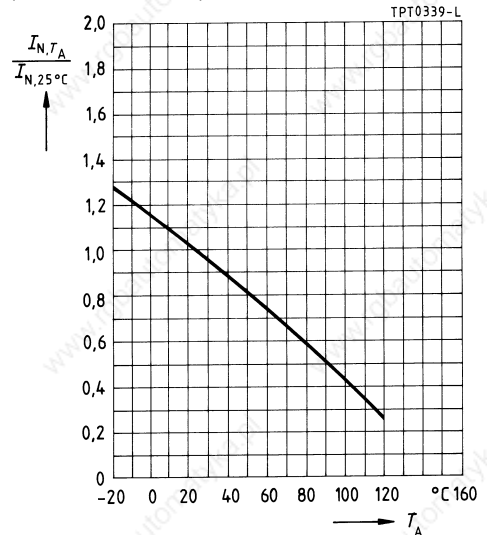

420 V to 1000 V

Applications

- Overcurrent and short-circuit protection

Features

- Uncoated thermistor disk
- Marking stamped on in black
- UL approval (E69802)
(exception: B 758)

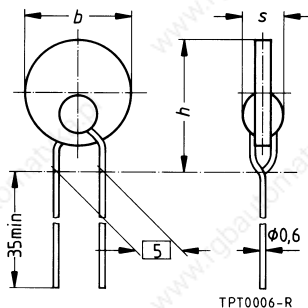

Dimensions (mm)

Type	b_{\max}	h_{\max}	s_{\max}
B 75*	12,5	16,5	7,0
B 77*	8,5	12,1	7,0

Switching cycles (typ.)	N		
Operating temperature range ($V = 0$)	T_{op}	100	
($V = V_{\max}$)	T_{op}	- 40/+ 125	°C
		0/60	°C

Type	I_N mA	I_S mA	$I_{S_{\max}}$ ($V = V_{\max}$) A	t_S ($V_{\max}, I_{S_{\max}}$) s	I_r (typ.) ($V = V_{\max}$) mA	R_N Ω	R_{\min} Ω	Ordering code
$V_{\max} = 420 \text{ V}, V_N = 380 \text{ V}, T_{\text{Ref}} = 120 \text{ }^\circ\text{C (typ.)}, \Delta R_N = \pm 25 \%$								
B 750	123	245	2,0	< 6	4,0	25	13	B59750-B120-A70
B 751	87	173	2,0	< 4	3,5	50	26	B59751-B120-A70
B 752	69	137	2,0	< 4	3,5	80	42	B59752-B120-A70
B 770	64	127	1,4	< 4	3,5	70	45	B59770-B120-A70
B 753	56	112	2,0	< 3	3,0	120	63	B59753-B120-A70
B 754	50	100	2,0	< 3	3,0	150	68	B59754-B120-A70
B 771	49	97	1,4	< 3	2,5	120	76	B59771-B120-A70
B 772	43	86	1,4	< 3	2,5	150	96	B59772-B120-A70
$V_{\max} = 550 \text{ V}, V_N = 500 \text{ V}, T_{\text{Ref}} = 115 \text{ }^\circ\text{C (typ.)}, \Delta R_N = \pm 25 \%$								
B 755	28	55	1,4	< 3	2,0	500	230	B59755-B115-A70
$V_{\max} = 550 \text{ V}, V_N = 500 \text{ V}, T_{\text{Ref}} = 120 \text{ }^\circ\text{C (typ.)}, \Delta R_N = \pm 25 \%$								
B 773	24	48	1,0	< 3	2,0	500	320	B59773-B120-A70
$V_{\max} = 550 \text{ V}, V_N = 500 \text{ V}, T_{\text{Ref}} = 115 \text{ }^\circ\text{C (typ.)}, \Delta R_N = \pm 25 \%$								
B 774	16	32	1,0	< 2	1,5	1100	700	B59774-B115-A70
$V_{\max} = 1000 \text{ V}, V_N = 1000 \text{ V}, T_{\text{Ref}} = 110 \text{ }^\circ\text{C (typ.)}, \Delta R_N = \pm 33 \%$								
B 758	8	17	0,5	< 3	3,0	7500	3380	B59758-B110-A70

Characteristics (typical)

PTC resistance R_{PTC} versus
 PTC temperature T_{PTC}
 (measured at low signal voltage)

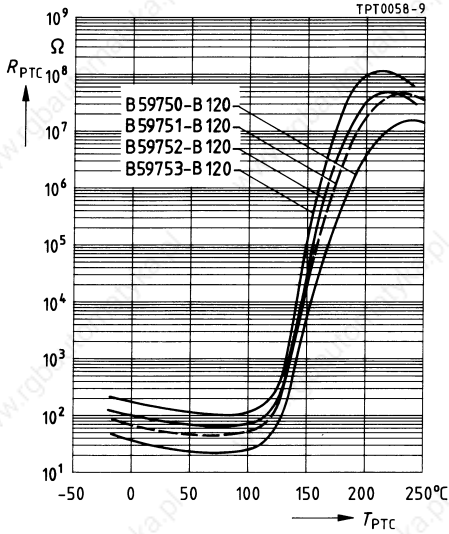

PTC current I_{PTC} versus PTC voltage V_{PTC}
 (measured at 25 °C in still air)

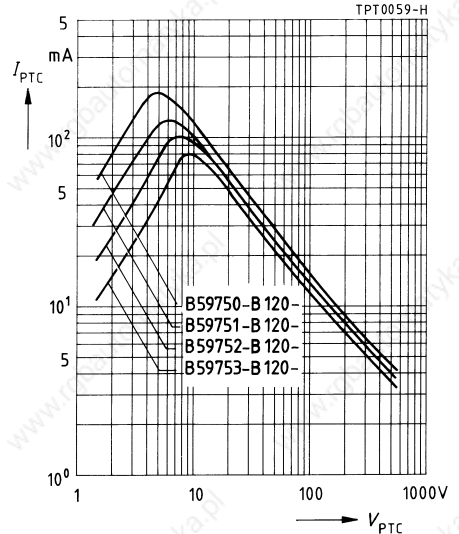

Switching time t_S versus switching current I_S
 (measured at 25 °C in still air)

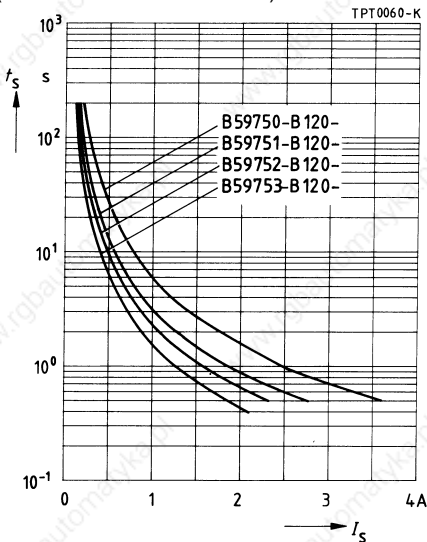

Rated current I_N versus ambient temperature T_A
 (measured in still air)

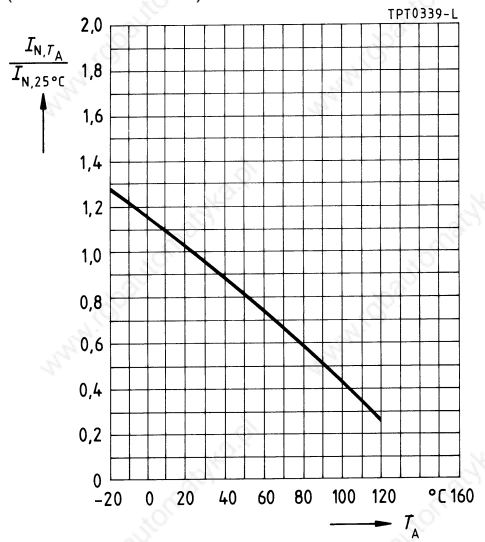

Characteristics (typical)

PTC resistance R_{PTC} versus
 PTC temperature T_{PTC}
 (measured at low signal voltage)

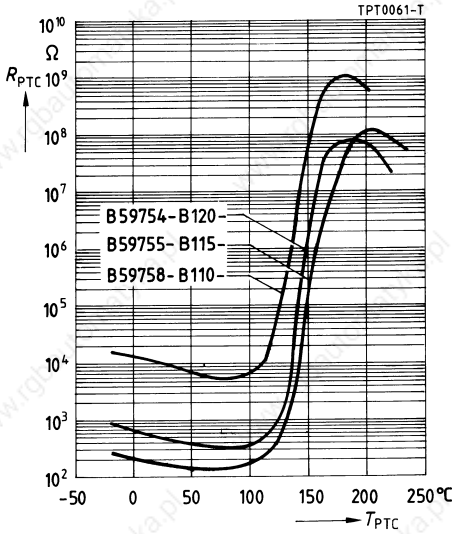

PTC current I_{PTC} versus PTC voltage V_{PTC}
 (measured at 25 °C in still air)

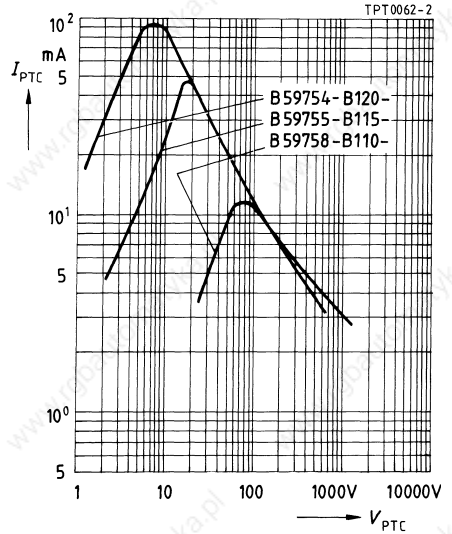

Switching time t_S versus switching current I_S
 (measured at 25 °C in still air)

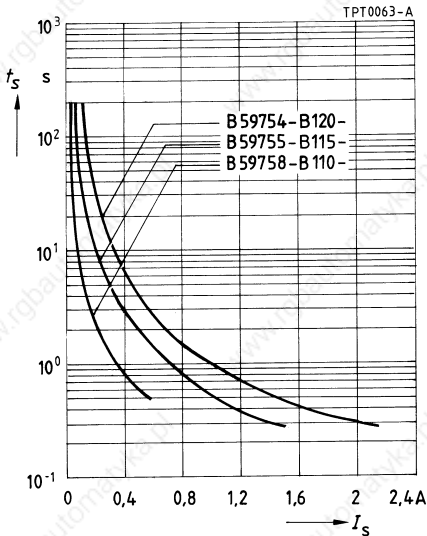

Rated current I_N versus ambient temperature T_A
 (measured in still air)

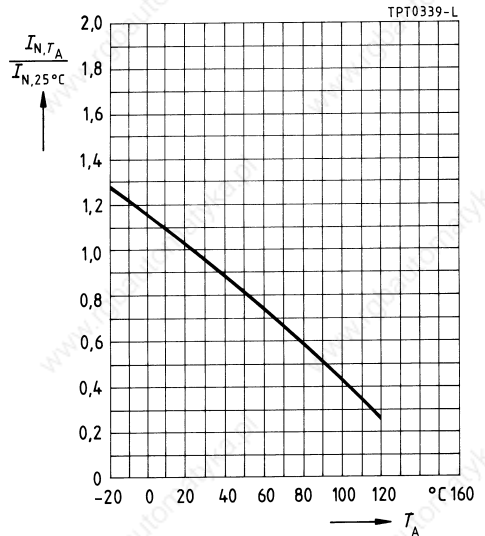

Characteristics (typical)

PTC resistance R_{PTC} versus
 PTC temperature T_{PTC}
 (measured at low signal voltage)

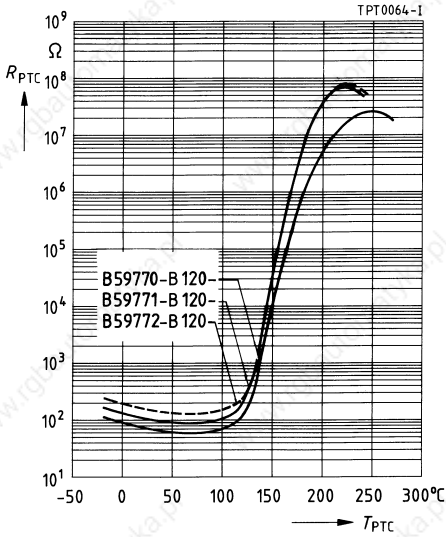

PTC current I_{PTC} versus PTC voltage V_{PTC}
 (measured at 25 °C in still air)

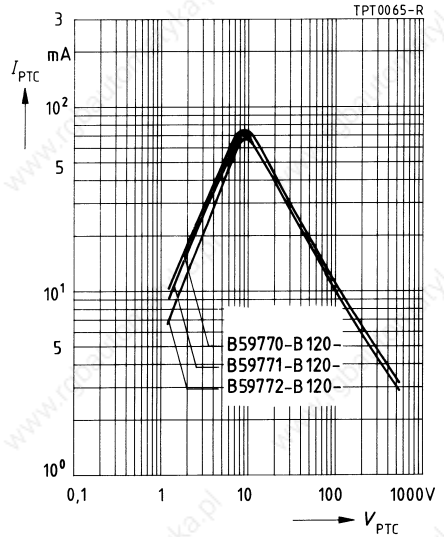

Switching time t_S versus switching current I_S
 (measured at 25 °C in still air)

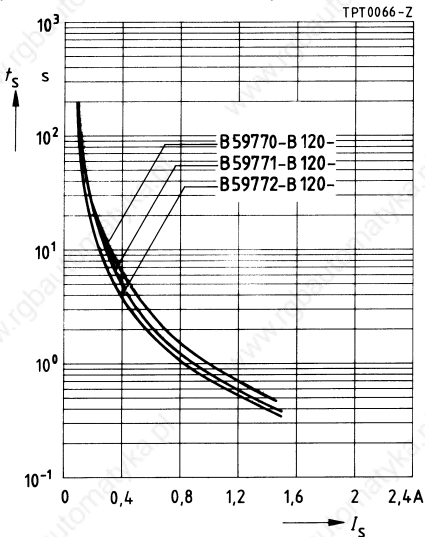

Rated current I_N versus ambient temperature T_A
 (measured in still air)

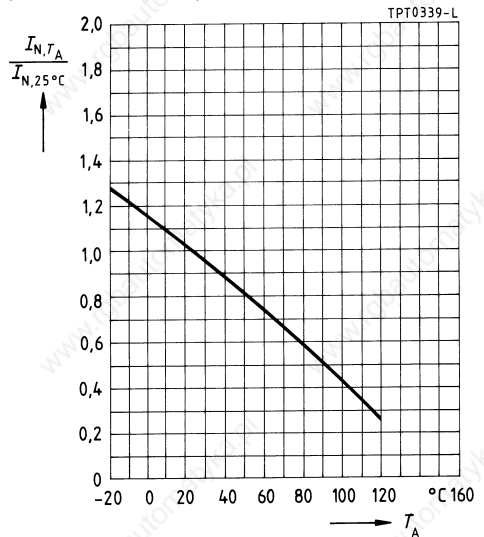

Characteristics (typical)

PTC resistance R_{PTC} versus
 PTC temperature T_{PTC}
 (measured at low signal voltage)

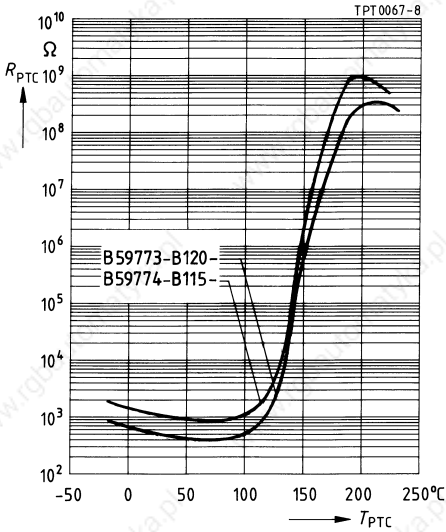

PTC current I_{PTC} versus PTC voltage V_{PTC}
 (measured at 25 °C in still air)

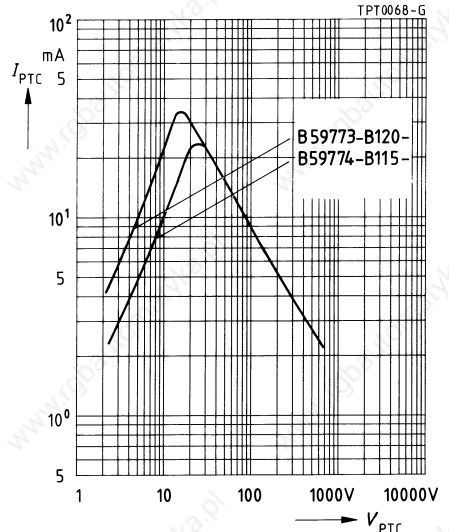

Switching time t_S versus switching current I_S
 (measured at 25 °C in still air)

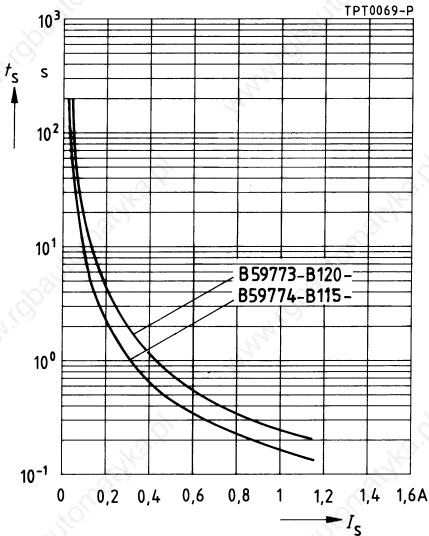

Rated current I_N versus ambient temperature T_A
 (measured in still air)

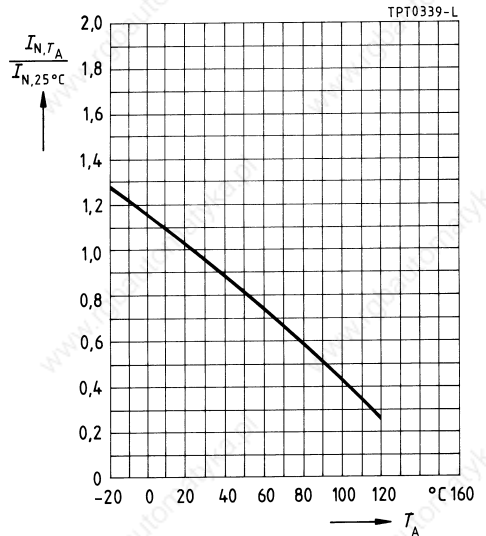

420 V to 550 V, 60 °C

Applications

- Overcurrent and short-circuit protection
- For high operating voltages

Features

- Leaded rod-type thermistor
- Low mounting height

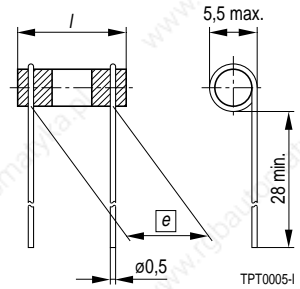

Dimensions (mm)

Type	[e]	l _{max}
B 404, B 406	12,5 ± 1	17

Switching cycles (typ.)	N	100	
Switching time at V _{max} , I _{Smax}	t _S	< 1	s
Reference temperature (typ.)	T _{Ref}	60	°C
Operating temperature range (V = 0)	T _{op}	- 40/+ 125	°C
	T _{op}	0/40	°C

Type	I _N mA	I _S mA	I _{Smax} (V=V _{max}) A	I _r (typ.) (V=V _{max}) mA	R _N Ω	ΔR _N %	R _{min} Ω	Ordering code
V _{max} = 550 V, V _N = 500 V								
B 404	4	9	0,4	1,0	3500	± 16	2880	B59404-B60-A40
V _{max} = 560 V, V _N = 500 V								
B 406	2,5	6,5	0,3	1,0	5500	± 28	3800	B59406-B60-A40

Characteristics (typical)

PTC resistance R_{PTC} versus
PTC temperature T_{PTC}
(measured at low signal voltage)

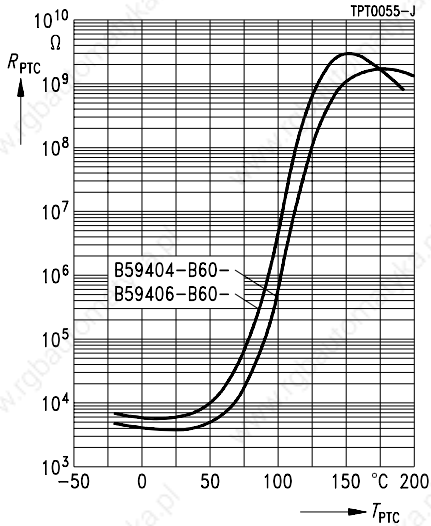

PTC current I_{PTC} versus PTC voltage V_{PTC}
(measured at 25 °C in still air)

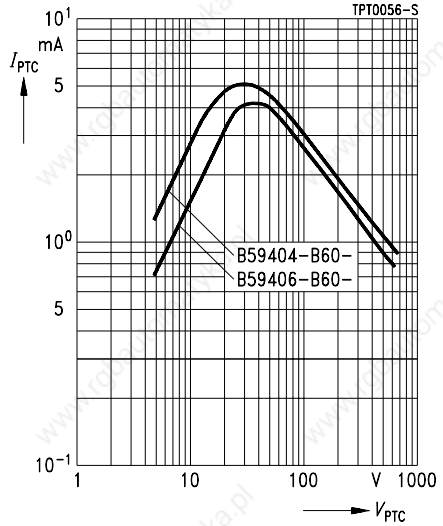

Switching time t_S versus switching current I_S
(measured at 25 °C in still air)

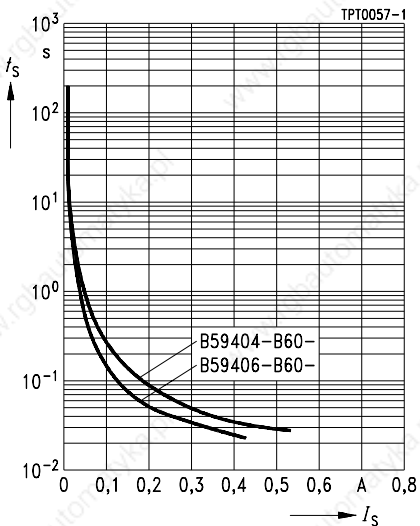

245 V, 120 °C

Applications

- Overload protection in telecom equipment (switching systems and customer premises equipment)

Features

- Uncoated thermistor disk for mounting onto PCB or in UDF module
- Marked with manufacturer's logo and type designation
- Narrow tolerance on resistance
- Available as matched pairs; resistance on each reel matched to $\pm 0,5 \Omega$
- Tested to ITU-T Rec. K21

Options

- Alternative tolerances and resistances upon request

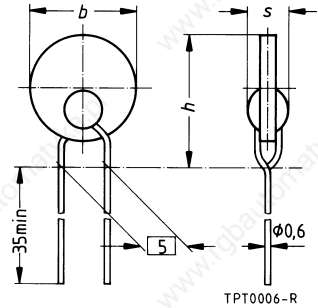

Dimensions (mm)

Type	b_{max}	h_{max}	s
B 1084	6,6	9,5	4,0
S 1022	10,2	14,1	4,0
S 1023	8,2	12,1	4,0
S 1024	8,2	12,1	4,0
S 1025	6,6	10,5	4,0

Max. operating voltage ($T_A = 60 \text{ °C}$)	V_{max}	245	V
Rated voltage	V_N	220	V
Reference temperature	T_{Ref}	120	°C
Resistance tolerance	ΔR_N	$\pm 15 \text{ \%}^1$	
Operating temperature range ($V = 0$)	T_{op}	- 25/+ 125	°C
($V = V_{max}$)	T_{op}	0/60	°C

Type	I_N mA	I_S mA	I_{Smax} ($V=V_{max}$) A	R_N Ω	Ordering code
B 1084 ²⁾	145	250	3,0	20	B59084-B1120-A151
S 1022	200	400	2,5	10	B59022-S1120-A70
S 1023	100	200	2,8	25	B59023-S1120-A70
S 1024	80	160	1,0	35	B59024-S1120-A70
S 1025	55	110	0,4	70	B59025-S1120-A70

1) For B 1084 = $\pm 20 \text{ \%}$.

2) For B 1084 resistance and switching characteristics available on request.

Characteristics (typical)

PTC resistance R_{PTC} versus
 PTC temperature T_{PTC}
 (measured at low signal voltage)

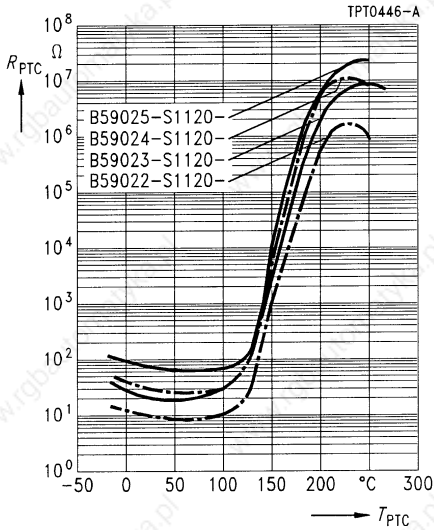

PTC current I_{PTC} versus PTC voltage V_{PTC}
 (measured at 25 $^{\circ}C$ in still air)

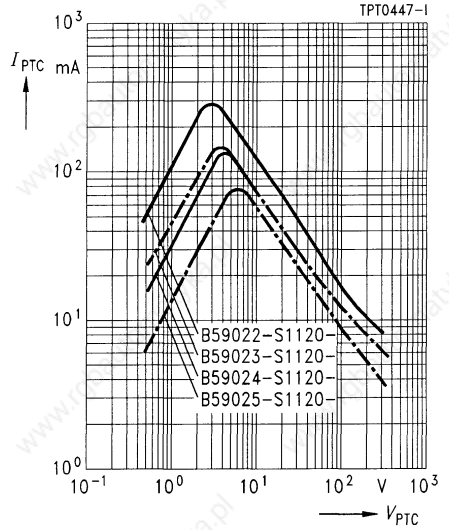

Switching time t_S versus switching current I_S
 (measured at 25 $^{\circ}C$ in still air)

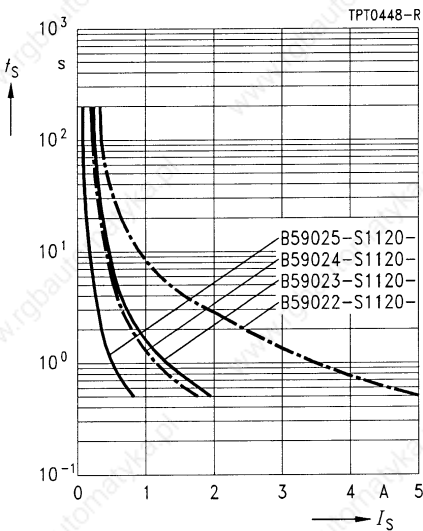

Rated current I_N versus ambient temperature T_A
 (measured in still air)

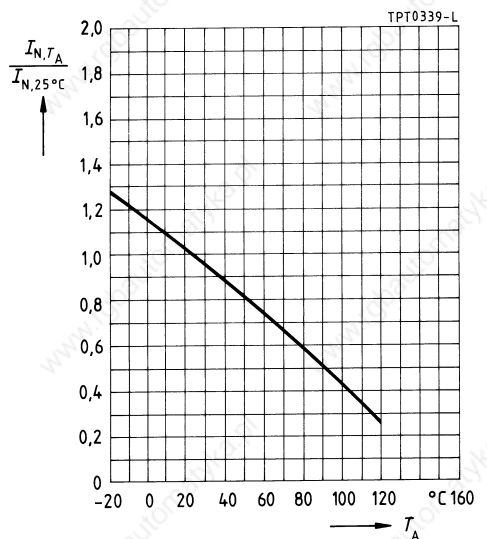

Not for new design¹⁾

245 V, 120 °C

Applications

- Overload protection in telecom equipment (switching systems and customer premises equipment)

Features

- For surface mounting onto PCB
- Marked with manufacturer's logo and type designation
- Narrow tolerance on resistance
- Available as matched pairs; resistance on each reel matched to $\pm 0,5 \Omega$
- Tested to ITU-T Rec. K20

Options

- Alternative tolerances and resistances upon request

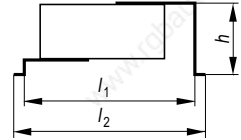
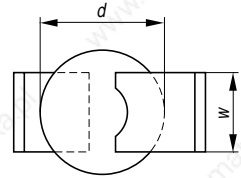

TPT0591-B

Dimensions (mm)

d_{max}	h_{max}	w_{max}	l_1_{max}	l_2_{max}
8,2	4,5	4,7	9,3	11,0

Max. operating voltage ($T_A = 60 \text{ °C}$)	V_{max}	245	V
Rated voltage	V_N	130	V
Reference temperature	T_{Ref}	120	°C
Resistance tolerance	ΔR_N	$\pm 20 \%$	
Operating temperature range ($V = 0$)	T_{op}	$- 25/+ 125$	°C
	T_{op}	0/60	°C

Type	I_N mA	I_S mA	I_{Smax} ($V=V_N$) A	R_N Ω	Ordering code
G 1031	180	360	1,0	9	B59031-G1120-A161
G 1033	150	300	1,5	16	B59033-G1120-A161
G 1030	120	260	2,8	25	B59030-G1120-A161
G 1034	90	200	2,8	50	B59034-G1120-A161

1) For new design we recommend G108* (page 90).

Characteristics (typical)

PTC resistance R_{PTC} versus
PTC temperature T_{PTC}
(measured at low signal voltage)

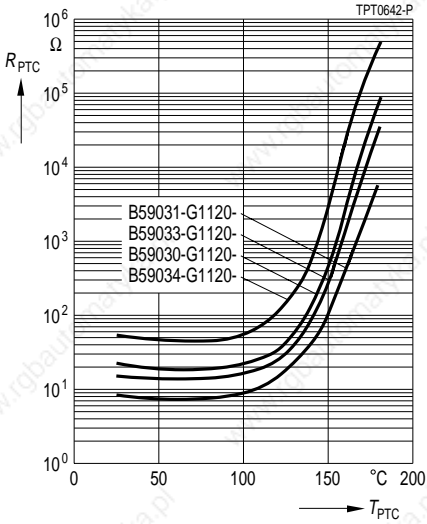

Switching time t_S versus switching current I_S
(measured at 25 °C in still air)

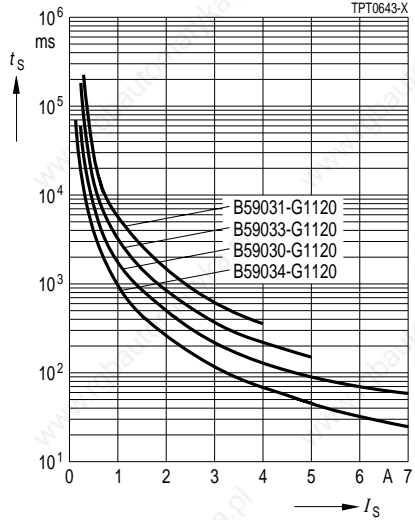

245 V, 120 °C

Applications

- Overload protection in telecom equipment (switching systems and customer premises equipment)

Features

- For surface mounting onto PCB
- Marked with manufacturer's logo and type designation
- Narrow tolerance on resistance
- Available as matched pairs; resistance on each reel matched to $\pm 0,5 \Omega$
- Tested to ITU-T Rec. K20

Options

- Alternative tolerances and resistances upon request

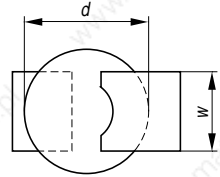

TPT0592-J

Dimensions (mm)

d_{max}	h_{max}	w_{max}	l_{max}
8,2	3,3	4,7	10,1

Max. operating voltage ($T_A = 60 \text{ }^\circ\text{C}$)	V_{max}	245	V
Rated voltage	V_N	130	V
Reference temperature	T_{Ref}	120	$^\circ\text{C}$
Resistance tolerance	ΔR_N	$\pm 20 \%$	
Operating temperature range ($V = 0$)	T_{op}	$- 25/+ 125$	$^\circ\text{C}$
	T_{op}	0/60	$^\circ\text{C}$

Type	I_N mA	I_S mA	I_{Smax} ($V = V_N$) A	R_N Ω	Ordering code
G 1081	180	360	1,0	9	B59081-G1120-A161
G 1083	150	300	1,5	16	B59083-G1120-A161
G 1082	130	260	2,8	25	B59082-G1120-A161
G 1084	90	200	2,8	50	B59084-G1120-A161

Characteristics (typical)

PTC resistance R_{PTC} versus
PTC temperature T_{PTC}
(measured at low signal voltage)

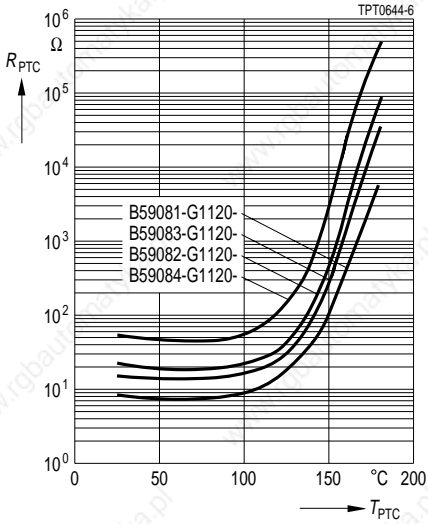

Switching time t_S versus switching current I_S
(measured at 25 °C in still air)

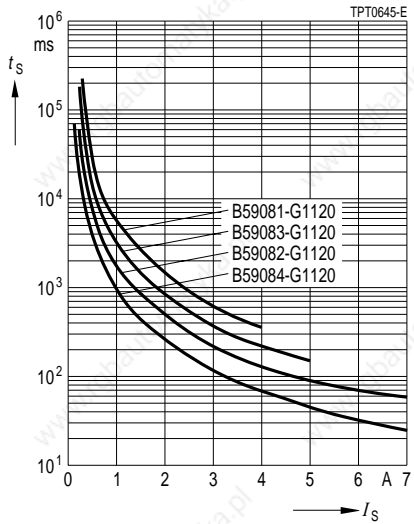

80 V, 120 °C

Applications

- Overcurrent protection
- Time delay
- Current stabilization

Features

- Thermistor chip with tinned terminations
- Small size
- Short response times
- Suitable for reflow soldering only
- Suitable for automatic placement
- Available on tape (standard delivery mode)

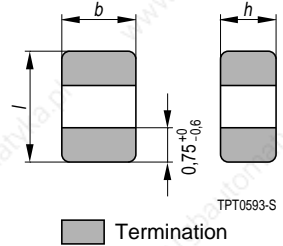

Dimensions (mm)

Tolerances (l, b, h) $\pm 0,2$ mm

Type	l	b	h	Size
A 607	3,2	2,5	1,7	1210
A 707	3,2	2,5	1,7	1210

Switching cycles (typ.)	N	100	
Reference temperature	T_{Ref}	120	°C
PTC temperature ($V = V_{max}$)	T_{PTC}	190	°C
Resistance tolerance	ΔR_N	$\pm 25\%$	
Operating temperature range ($V = 0$)	T_{op}	$-40/+125$	°C
	T_{op}	0/60	°C

Type	$I_N^{1)}$ mA	$I_S^{1)}$ mA	I_{Smax} ($V = V_{max}$) A	R_N Ω	R_{min} Ω	t_S s	Ordering code
$V_{max} = 80$ V, $V_N = 63$ V							
A 707	45	90	0,3	125	75	< 2,5	B59707-A120-A62
$V_{max} = 30$ V, $V_N = 24$ V							
A 607	65	130	0,4	55	30	< 5,0	B59607-A120-A62

1) Measured peak-to-peak

Characteristics (typical)

PTC resistance R_{PTC} versus
PTC temperature T_{PTC}
(measured at low signal voltage)

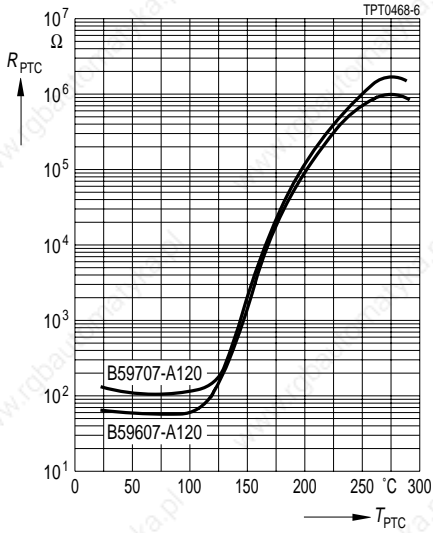

Rated current I_N versus ambient temperature T_A
(measured in still air)

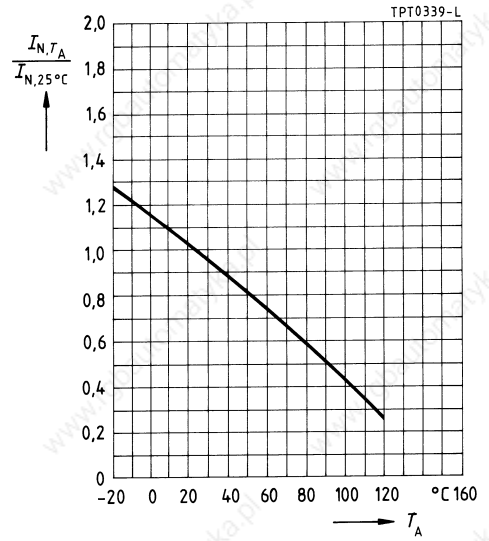

30 V

Applications

- Overcurrent protection
- Short-circuit protection

Features

- Molded epoxy encapsuation, tinned solder terminals
- Suitable for wave and reflow soldering
- Suitable for automatic placement
- Available on tape (standard delivery mode)

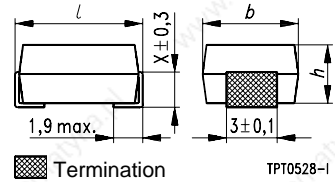

Dimensions (mm)
Tolerances $\pm 0,5$ mm

Type	h	b	l	x	Size
P 1101	3,2	6,3	8,0	1,7	3225
P 1201	3,2	6,3	8,0	1,7	3225
P 1301	3,2	8,0	10,0	2,3	4032

Max. operating voltage ($T_A = 60^\circ\text{C}$)	V_{\max}	30	V
Rated voltage	V_N	24	V
Switching cycles (typ.)	N	100	
Resistance tolerance	ΔR_N	$\pm 25\%$	
Operating temperature range ($V = 0$)	T_{op}	$-40/+125$	$^\circ\text{C}$
	T_{op}	0/60	$^\circ\text{C}$

Type	I_N mA	I_S mA	$I_{S\max}$ ($V=V_{\max}$) A	I_r ($V=V_{\max}$) mA	R_N Ω	R_{\min} Ω	t_S ($I_{S\max}$) s	Ordering code
Reference temperature $T_{\text{Ref}} = 80^\circ\text{C}$								
P 1101	90	185	0,7	25	13	7,80	$\leq 2,0$	B59101-P1080-A62
P 1201	165	340	1,0	34	4,6	2,70	$\leq 6,0$	B59201-P1080-A62
P 1301	205	420	1,6	38	3,1	1,85	$\leq 6,0$	B59301-P1080-A62
Reference temperature $T_{\text{Ref}} = 120^\circ\text{C}$								
P 1101	170	355	0,7	35	13	7,80	$\leq 4,5$	B59101-P1120-A62
P 1201	265	545	1,0	45	4,6	2,70	$\leq 12,0$	B59201-P1120-A62
P 1301	310	640	1,6	53	3,1	1,85	$\leq 12,0$	B59301-P1120-A62

Characteristics (typical)

PTC resistance R_{PTC} versus
PTC temperature T_{PTC}
(measured at low signal voltage)

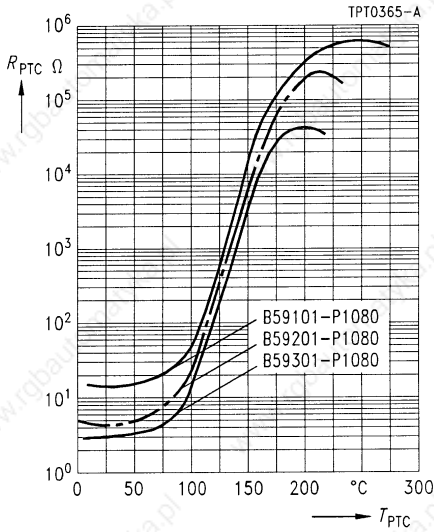

PTC current I_{PTC} versus PTC voltage V_{PTC}
(measured at 25 °C in still air)

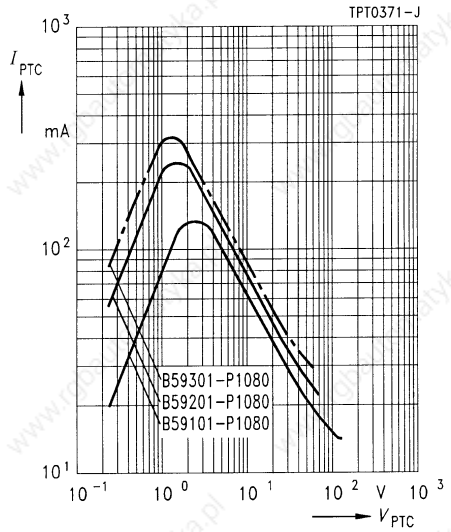

Switching time t_S versus switching current I_S
(measured at 25 °C in still air)

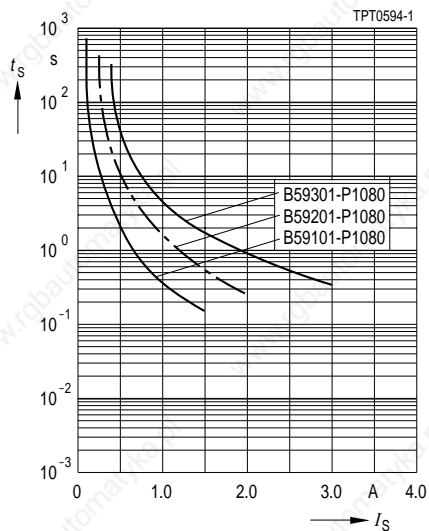

Rated current I_N versus ambient temperature T_A
(measured in still air)

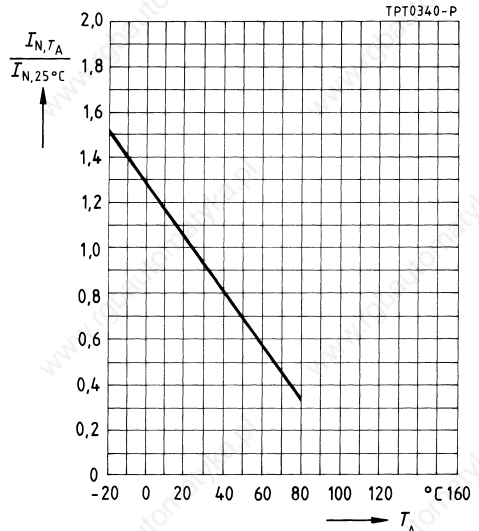

Characteristics (typical)

PTC resistance R_{PTC} versus
PTC temperature T_{PTC}
(measured at low signal voltage)

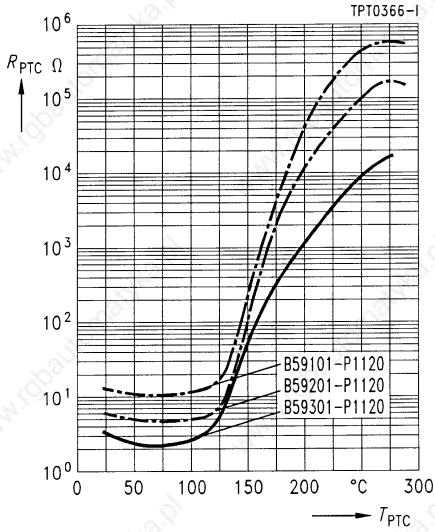

PTC current I_{PTC} versus PTC voltage V_{PTC}
(measured at 25 °C in still air)

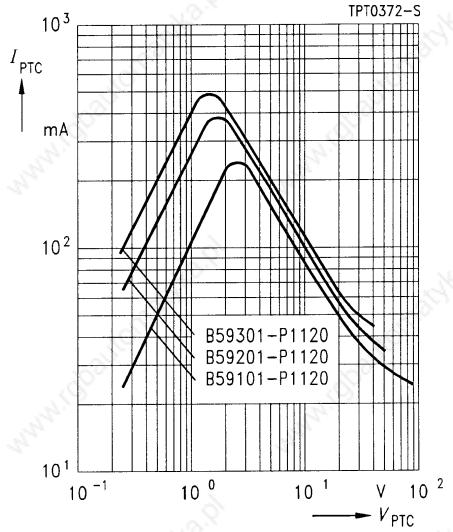

Switching time t_S versus switching current I_S
(measured at 25 °C in still air)

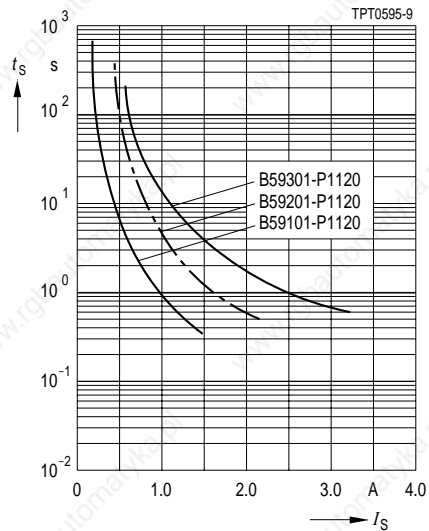

Rated current I_N versus ambient temperature T_A
(measured in still air)

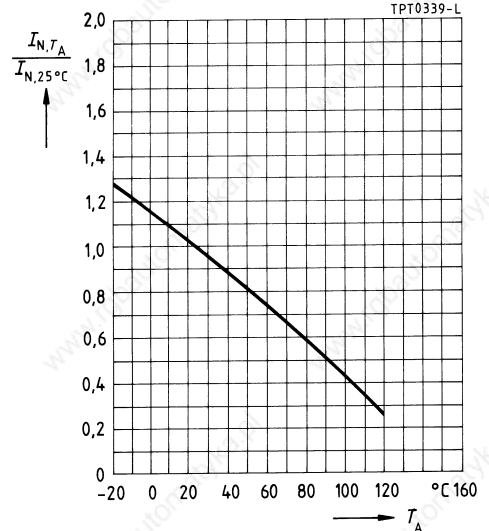

80 V

Applications

- Overcurrent protection
- Short-circuit protection

Features

- Molded epoxy encapsuation, tinned solder terminals
- Suitable for wave and reflow soldering
- Suitable for automatic placement
- Available on tape (standard delivery mode)

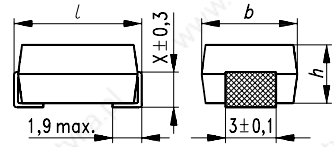

Termination

TPT0528-I

Dimensions (mm)

Tolerances $\pm 0,5$ mm

Type	h	b	l	x	Size
P 1115	3,2	6,3	8,0	1,7	3225
P 1215	3,2	6,3	8,0	1,7	3225
P 1315	3,2	8,0	10,0	2,3	4032

Max. operating voltage ($T_A = 60^\circ\text{C}$)	V_{\max}	80	V
Rated voltage	V_N	63	V
Switching cycles (typ.)	N	100	
Resistance tolerance	ΔR_N	$\pm 25\%$	
Operating temperature range ($V = 0$)	T_{op}	$-40/+125$	$^\circ\text{C}$
	T_{op}	0/60	$^\circ\text{C}$

Type	I_N mA	I_S mA	$I_{S\max}$ ($V=V_{\max}$) A	I_r ($V=V_{\max}$) mA	R_N Ω	R_{\min} Ω	t_S ($I_{S\max}$) s	Ordering code
Reference temperature $T_{\text{Ref}} = 80^\circ\text{C}$								
P 1115	40	85	0,7	9,0	55	32,2	$\leq 1,5$	B59115-P1080-A62
P 1215	65	135	1,0	11,5	25	15,0	$\leq 1,5$	B59215-P1080-A62
P 1315	80	165	1,6	15,0	16	9,6	$\leq 1,5$	B59315-P1080-A62
Reference temperature $T_{\text{Ref}} = 120^\circ\text{C}$								
P 1115	70	145	0,7	13,0	55	32,2	$\leq 2,5$	B59115-P1120-A62
P 1215	100	210	1,0	14,0	25	15,0	$\leq 3,0$	B59215-P1120-A62
P 1315	150	310	1,6	20,0	16	9,6	$\leq 3,0$	B59315-P1120-A62

Characteristics (typical)

PTC resistance R_{PTC} versus
PTC temperature T_{PTC}
(measured at low signal voltage)

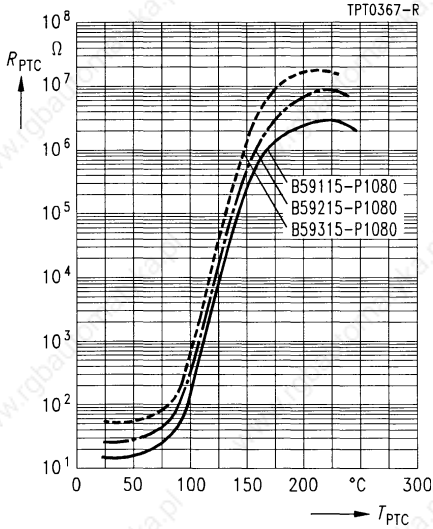

PTC current I_{PTC} versus PTC voltage V_{PTC}
(measured at 25 °C in still air)

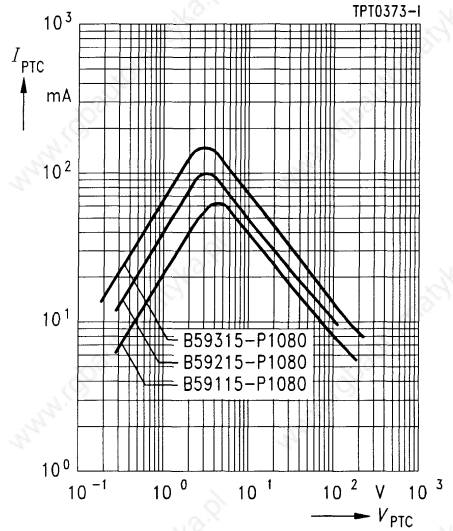

Switching time t_S versus switching current I_S
(measured at 25 °C in still air)

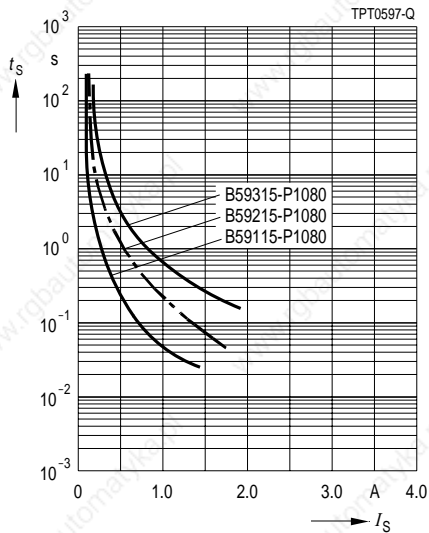

Rated current I_N versus ambient temperature T_A
(measured in still air)

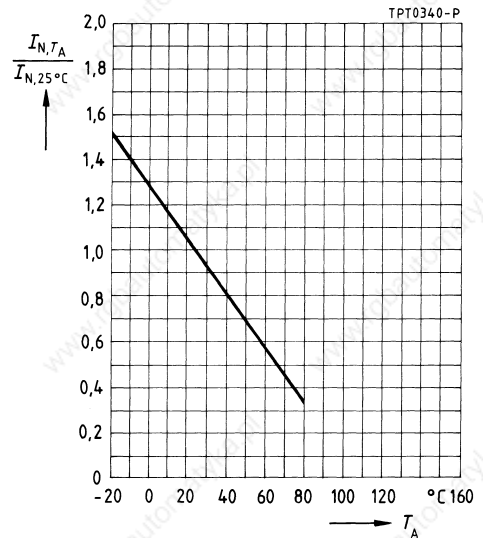

Characteristics (typical)

PTC resistance R_{PTC} versus
PTC temperature T_{PTC}
(measured at low signal voltage)

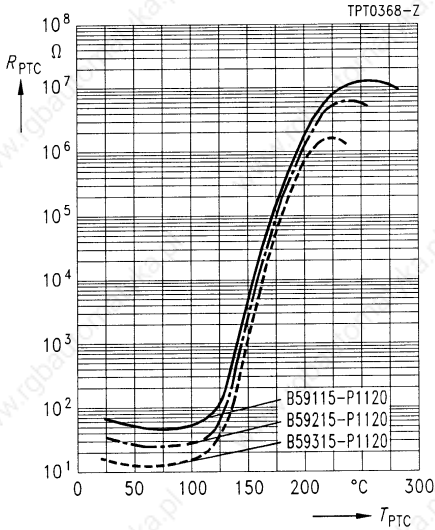

PTC current I_{PTC} versus PTC voltage V_{PTC}
(measured at 25 °C in still air)

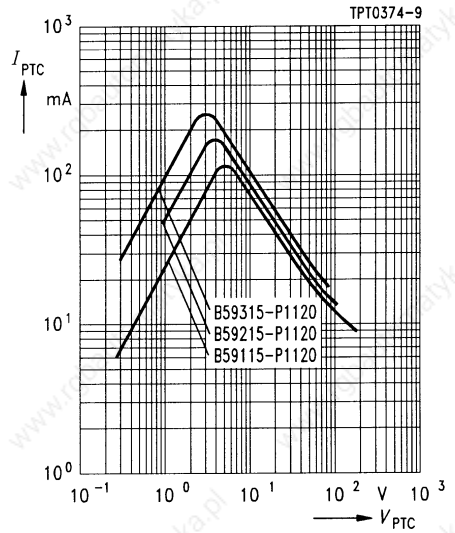

Switching time t_S versus switching current I_S
(measured at 25 °C in still air)

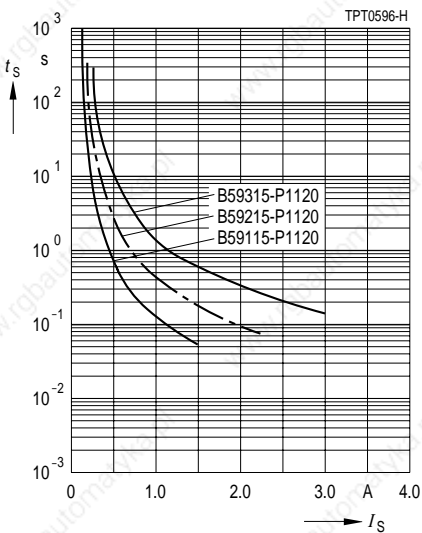

Rated current I_N versus ambient temperature T_A
(measured in still air)

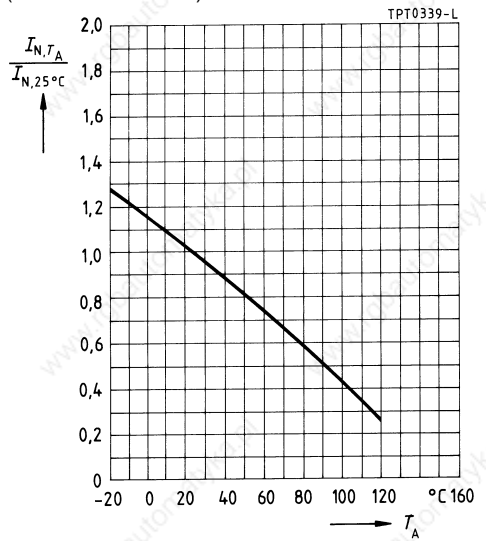

140 V / 265 V

Applications

- Degaussing of picture tubes

Features

- Coated thermistor disk
- Marked with manufacturer's logo and type designation
- Low residual current
- Stable performance throughout a large number of switching cycles

Options

- Also available on tape

C 1*50

S 14*1

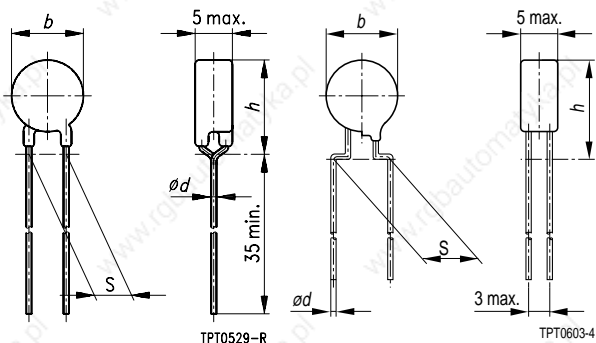

Dimensions (mm)

Type	b_{max}	S_{max}	$\varnothing d$	h_{max}
C 1250	13,5	5,0	0,6	17,0
C 1450	15,0	5,0	0,6	19,0
C 1650	17,5	5,0	0,6	21,0
S 1451	15,0	10,0	0,6	22,0
S 1461	15,0	10,0	0,6	22,0
S 1481	15,0	10,0	0,6	22,0

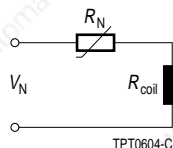

Operating temperature range ($V = 0$)	T_{op}	-25/+125	°C
($V = V_N$)	T_{op}	0/60	°C

Type	$I_{in/coil}$ (0 s) A_{pp}	$I_{r/coil}$ (180 s) ($V = V_N$, $25\text{ °C} \leq T_{op} \leq 60\text{ °C}$) mA_{pp}	R_N Ω	R_{coil} Ω	Ordering code
$V_{max} = 140\text{ V}_{rms}$; $V_N = 120\text{ V}_{rms}$					
C 1650	≥ 24	≤ 40	5	8,5	B59650-C1050-B70
S 1481	≥ 25	≤ 40	8	3,5	B59481-S1050-B10
$V_{max} = 265\text{ V}_{rms}$; $V_N = 230\text{ V}_{rms}$					
C 1450	≥ 20	≤ 25	18	12	B59450-C1080-B70
S 1451	≥ 18	≤ 25	18	12	B59451-S1080-B10
S 1461	≥ 16	≤ 25	20	15	B59461-S1080-B10
C 1250	≥ 11	≤ 20	25	25	B59250-C1080-B70

265 V

Applications

- Degaussing of picture tubes

Features

- PTC element in a plastic case (2-pin)
- Marked with manufacturer's logo, type designation and date code
- Flame-retardant case material (UL 94 V-0)
- Solderability to IEC 68-2-20 (test ta, methode 1)
- Stable performance throughout a large number of switching cycles owing to clamp contacting
- EN 144003 compliance
- CECC 44003-001

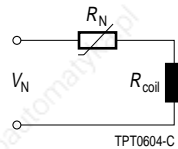
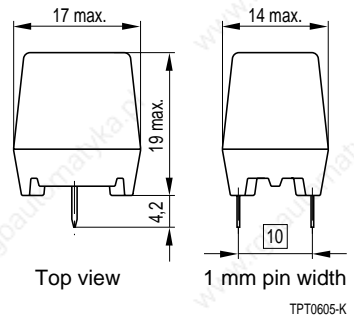

Max. operating voltage	V_{max}	265	V_{rms}
Rated voltage	V_N	230	V_{rms}
Operating temperature range ($V = 0$)	T_{op}	-25/+125	$^{\circ}C$

Type	$I_{in/coil}$ (0 s) A_{pp}	$I_{r/coil}$ ($V = V_N$, $25^{\circ}C \leq T_{op} \leq 60^{\circ}C$) mA_{pp}	R_N Ω	R_{coil} Ω	Ordering code
J 209	≥ 18	≤ 20	9	20	B59209-J80-A10
J 120	≥ 22	≤ 20	12	10	B59120-J80-A10
J 104	≥ 25	≤ 20	14	10	B59104-J80-A10
J 108	≥ 20	≤ 20	18	10	B59108-J80-A10

265 V

Applications

- Degaussing of picture tubes

Features

- Two PTC elements in a plastic case (3-pin)
- Low residual current due to double PTC configuration
- Marked with manufacturer's logo, type designation and date code
- Flame-retardant case material (UL 94 V-0)
- Solderability to IEC 68-2-20 (test ta, methode 1)
- Stable performance throughout a large number of switching cycles owing to clamp contacting
- EN 144003 compliance
- VDE approval
- CECC 44003-001

Connection

- Connection to power supply: AB
- Connection to coil: CA

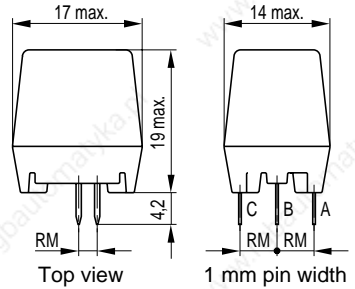

TPT0606-T

Hole arrangement

A B

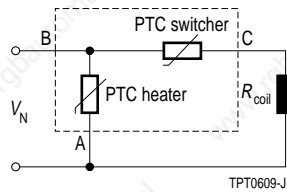
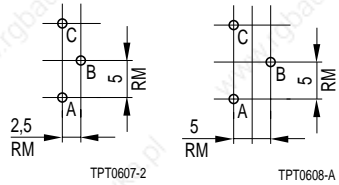

Max. operating voltage	V_{\max}	265	V_{rms}
Rated voltage	V_N	230	V_{rms}
Operating temperature range ($V = 0$)	T_{op}	-25/+125	$^{\circ}\text{C}$

Type	$t_{in/coil}$ (0 s) A_{pp}	$t_{r/coil}$ ($V=V_N, 25\text{ °C} \leq T_{op} \leq 60\text{ °C}$) mA_{pp}	R_N Ω	R_{coil} Ω	Ordering code
T 209	≥ 18	≤ 7	9	20	B59209-T80-+10
T 120	≥ 20	≤ 5	12	15,5	B59120-T80-+10
T 104	≥ 25	≤ 5	14	10	B59104-T80-+10
T 108	≥ 20	≤ 3	18	10	B59108-T80-+10
T 170	≥ 16	≤ 3	18	17	B59170-T80-+10
T 100	≥ 20	≤ 3	22,5	10	B59100-T80-+10
T 250	≥ 10	≤ 3	28	25	B59250-T80-+10
T 251	≥ 10	≤ 3	30	25	B59251-T80-+10

+: A for hole arrangement A
B for hole arrangement B

265 V

Applications

- Degaussing of picture tubes

Features

- Two PTC elements in a plastic case (3-pin)
- Switching elements in parallel
- Marked with manufacturer's logo, type designation and date code
- Flame-retardant case material (UL 94 V-0)
- Solderability to IEC 68-2-20 (test ta, methode 1)
- Stable performance throughout a large number of switching cycles owing to clamp contacting
- EN 144003 compliance / CECC 44003-001

Connection

- Connection to coil 1: C
- Connection to coil 2: A

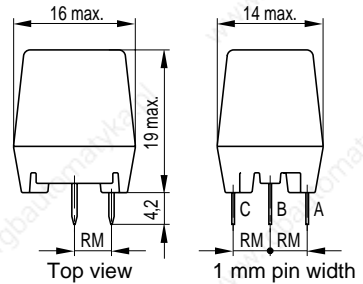

TPT0610-L

Hole arrangement

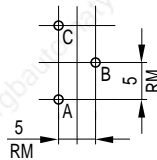

TPT0608-A

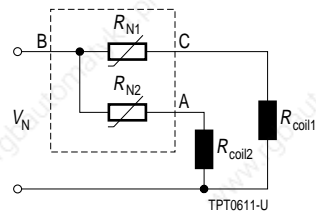

TPT0611-U

Max. operating voltage	V_{max}	265	V_{rms}
Rated voltage	V_N	230	V_{rms}
Operating temperature range ($V = 0$)	T_{op}	-25/+125	°C

Type	$I_{in/coil}$ (0 s)	$I_{r/coil}$ ($V = V_N$, $25\text{ °C} \leq T_{op} \leq 60\text{ °C}$)	R_N Ω	R_{coil} Ω	Ordering code
T 205	≥ 20	≤ 10	4,5 (2 × 9)	2 × 20	B59205-T80-B10
T 109	≥ 30	≤ 25	9 (2 × 18)	10 (2 × 20)	B59109-T80-B110
T 126	≥ 32	≤ 25	6 (2 × 12)	12 (2 × 24)	B59126-T80-B110

Types T 109 and T 126: A single coil may be used instead of the two coils (C1 + C2). The PTCs are then externally (AC) connected in parallel.

Characteristics

Typical curve of demagnetization current $I_{in/coil}$

Coil resistance: 3,5 Ω (S 1481), 25 Ω (C 1250), 8,5 Ω (C 1650),

20 Ω (C 1450, S 1451, S 1461)

Ambient temperature 25 °C

S 1481

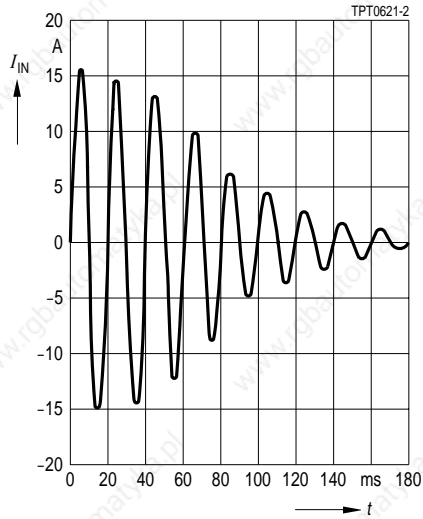

C 1250

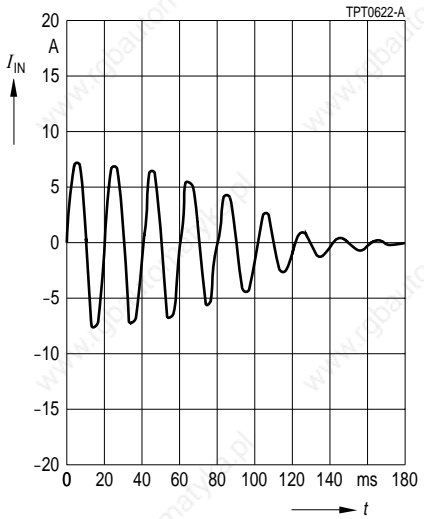

C 1450, S 1451, S 1461

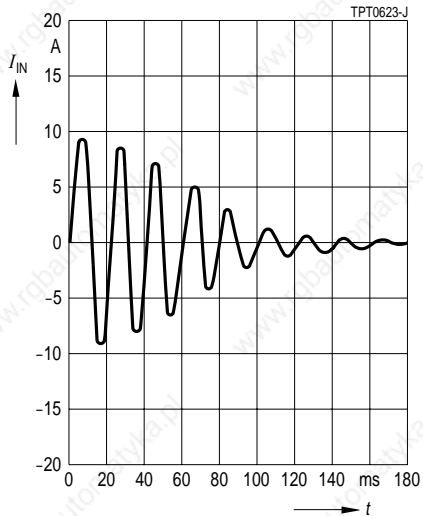

C 1650

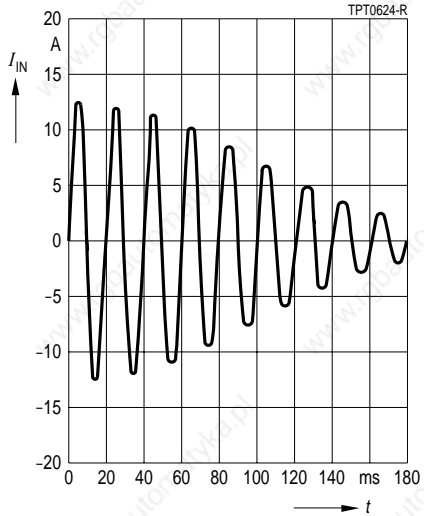

Characteristics

Typical curve of demagnetization current $I_{in/coil}$

Coil resistance: 20 Ω

Ambient temperature 25 °C

T 209

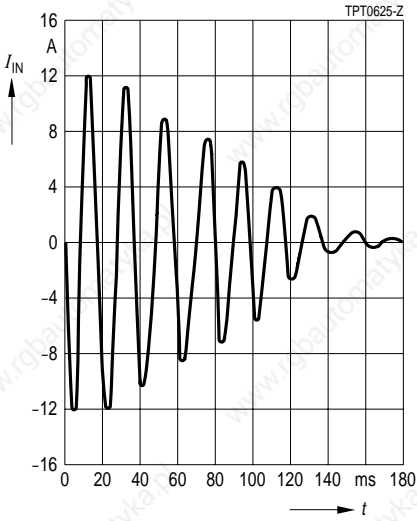

T 104

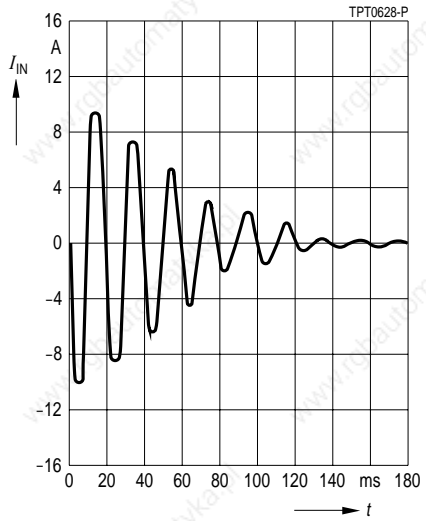

T 120

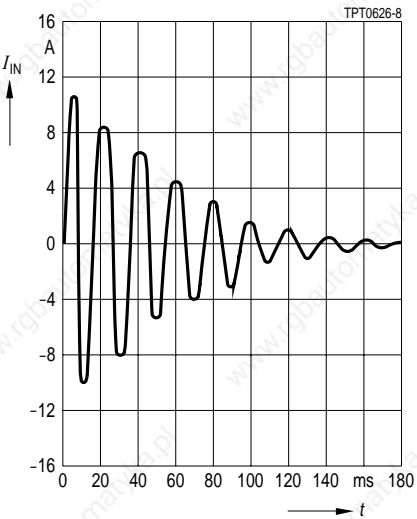

T 108

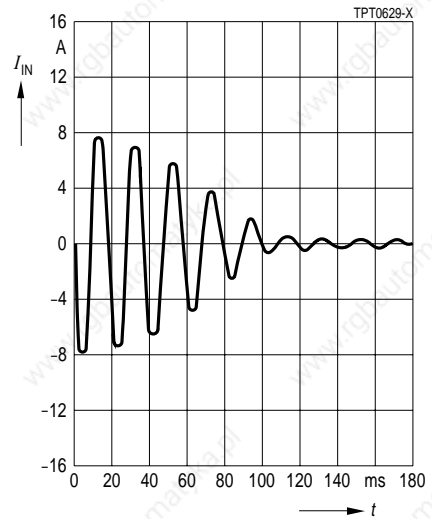

Characteristics

Typical curve of demagnetization current $I_{in/coil}$
Coil resistance: 20 Ω (T 100, T 170), 25 Ω (T 250, T 251)
Ambient temperature 25 °C

T 100

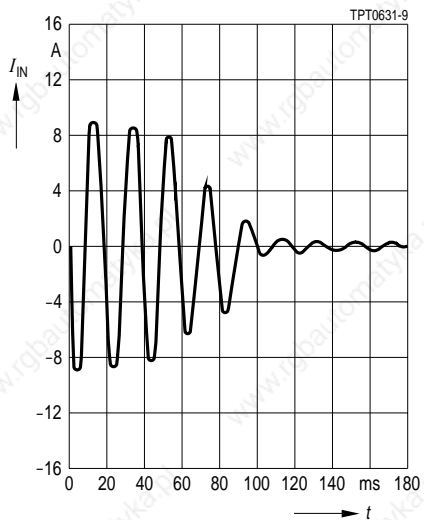

T 250

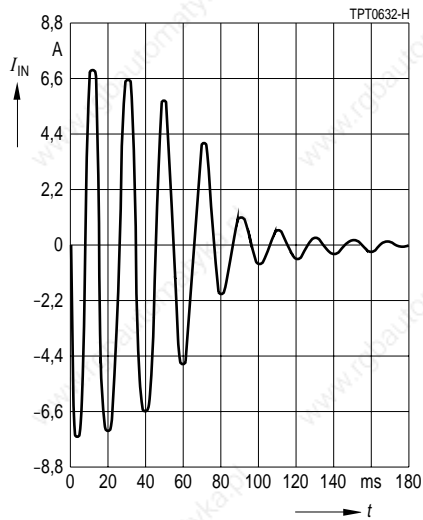

T 170

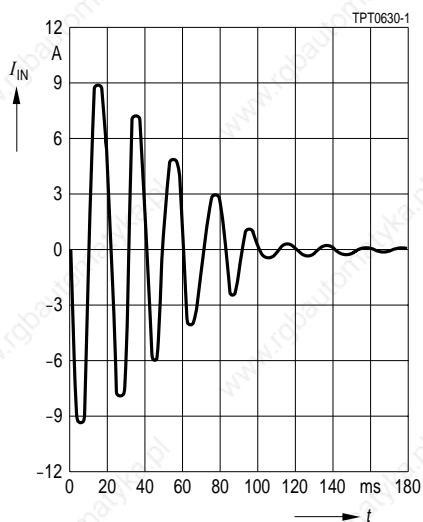

T 251

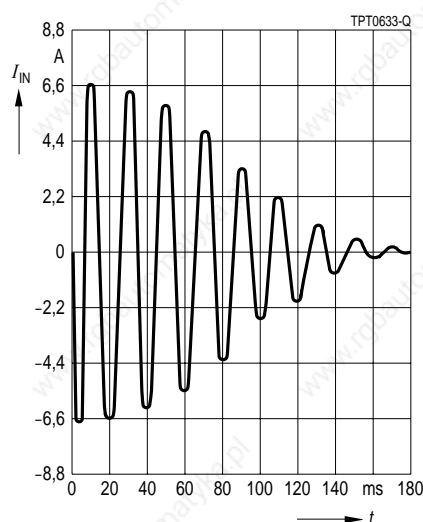

Characteristics

Typical curve of demagnetization current $I_{in/coil}$

Coil resistance: 20 Ω

Ambient temperature 25 °C

T 109

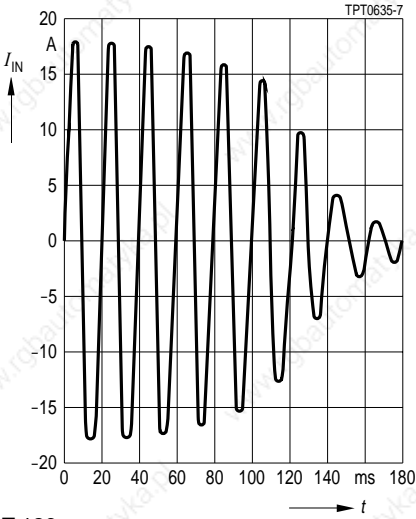

T 205

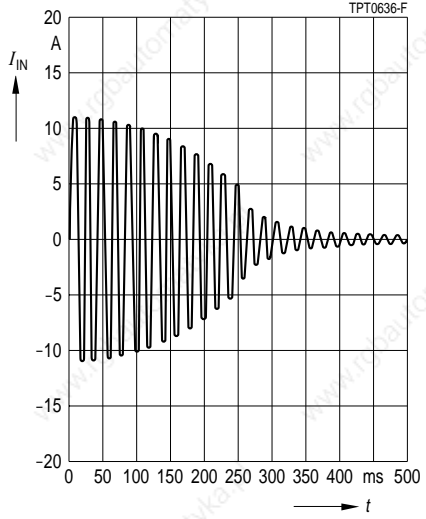

T 126

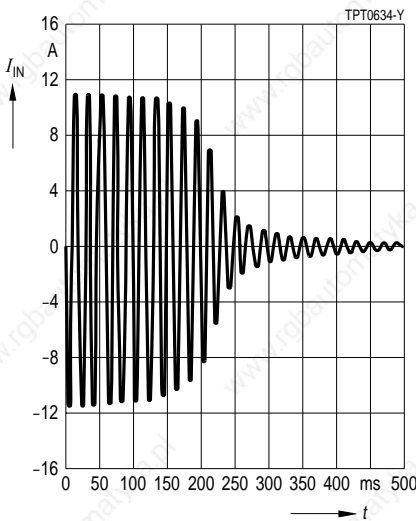

265 V

Applications

- Switching thermistor for lighting applications (e. g. in electronic ballasts for lamps etc.)
- For frequent switching

Features

- Coated thermistor disk, kinked leads
- Marked with manufacturer's logo and type designation
- Stable performance throughout 10 000 switching cycles

Options

- Also available on tape

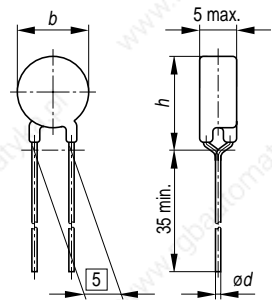

TPT0648-4

Dimensions (mm)

Type	b_{max}	h_{max}	$\varnothing d$
C 1118	6,5	10,0	0,6
C 1119	4,0	7,5	0,5

Max. operating voltage ($T_A = 60\text{ }^\circ\text{C}$)	V_{max}	265	V
Rated voltage	V_N	220	V
Switching cycles (typ.)	N	10000	
Resistance tolerance	ΔR_N	$\pm 25\%$	
Operating temperature range ($V = 0$)	T_{op}	$-25/+125$	$^\circ\text{C}$
	T_{op}	0/60	$^\circ\text{C}$

Type	I_N	I_S	I_{Smax} ($V = V_{max}$)	I_r ($V = V_{max}$)	R_N	R_{min}	t_S	Ordering code
	mA	mA	mA	mA	Ω	Ω	s	

Reference temperature $T_{Ref} = 80\text{ }^\circ\text{C}$

C 1118	30	70	400	4	70	39	$\leq 6,0$	B59118-C1080-A70
C 1119	15	40	200	3	150	84	$\leq 6,0$	B59119-C1080-A70

Reference temperature $T_{Ref} = 120\text{ }^\circ\text{C}$

C 1118	55	110	400	6	70	39	$\leq 8,0$	B59118-C1120-A70
C 1119	30	60	200	5	150	84	$\leq 8,0$	B59119-C1120-A70

Characteristics (typical)

PTC resistance R_{PTC} versus
PTC temperature T_{PTC}
(measured at low signal voltage)

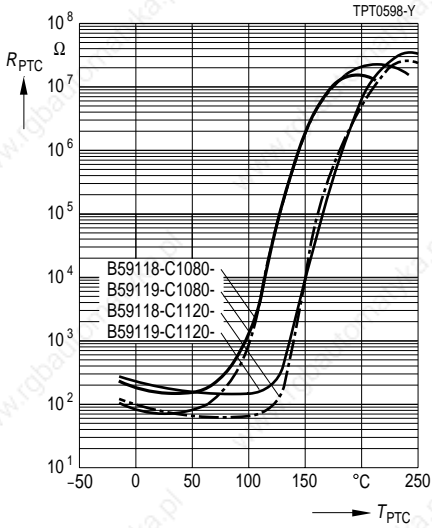

PTC current I_{PTC} versus PTC voltage V_{PTC}
(measured at 25 °C in still air)

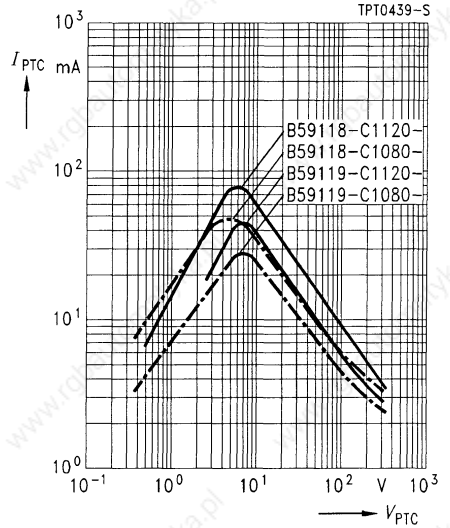

Switching time t_S versus switching current I_S
(measured at 25 °C in still air)

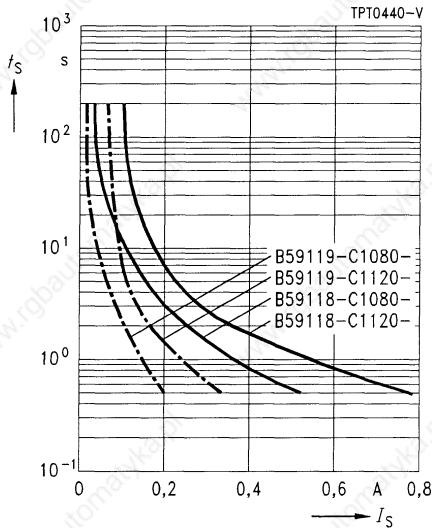

Rated current I_N versus ambient temperature T_A
(measured in still air)

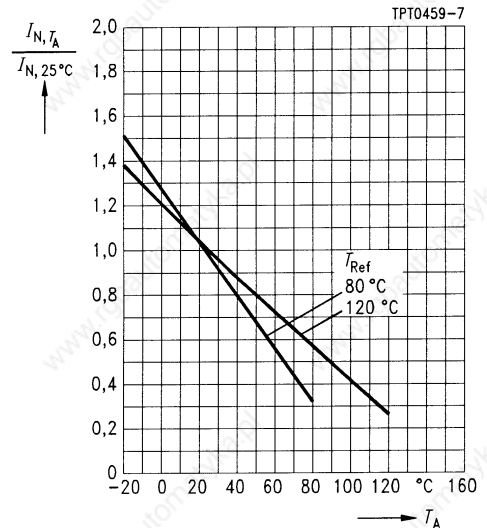

265 V

Applications

- Delayed switching of loads
(e. g. in electronic ballasts for lamps)
- For frequent switching

Features

- Encased thermistor disk with clamp contacts
- Flame-retardant plastic case
- Case material UL-listed
- Silver-plated solder pins
- Manufacturer's logo and type designation stamped on in white
- Stable performance throughout 100 000 switching cycles

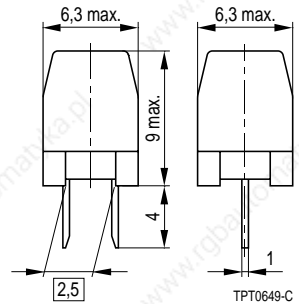

Dimensions (mm)

Switching cycles (typ.)	N	100000	
Switching time	t_S	≤ 5	s
Resistance tolerance	ΔR_N	$\pm 25\%$	
Operating temperature range ($V = 0$)	T_{op}	$-25/+125$	$^{\circ}\text{C}$
	T_{op}	0/60	$^{\circ}\text{C}$

Type	T_{Ref} $^{\circ}\text{C}$	I_N mA	I_S mA	I_{Smax} ($V=V_{max}$) A	I_r ($V=V_{max}$) mA	R_N Ω	R_{min} Ω	Ordering code
$V_{max} = 265\text{ V}, V_N = 220\text{ V}$								
J 150	120	35	70	0,45	4	150	84	B59150-J120-A20
J 200	120	30	60	0,42	4	200	110	B59200-J120-A20
J 320	120	24	50	0,33	4	320	200	B59320-J120-A20

80 V to 265 V

Applications

- Delayed switching of loads
- For frequent switching

Features

- Encased thermistor disk with clamp contacts
- Flame-retardant plastic case
- Case material UL-listed
- Silver-plated solder pins
- Manufacturer's logo and type designation stamped on in white
- Stable performance throughout 50 000 switching cycles

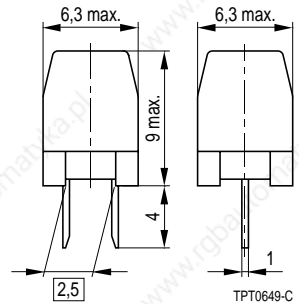

Dimensions (mm)

Switching cycles (typ.)	N	50000	
Switching time	t_S	$\leq 0,5$	s
Resistance tolerance	ΔR_N	$\pm 25\%$	
Operating temperature range ($V = 0$) ($V = V_{max}$)	T_{op}	$-25/+125$	$^{\circ}\text{C}$
	T_{op}	0/60	$^{\circ}\text{C}$

Type	T_{Ref} $^{\circ}\text{C}$	I_N mA	I_S mA	I_{Smax} ($V = V_{max}$) A	I_r ($V = V_{max}$) mA	R_N Ω	R_{min} Ω	Ordering code
$V_{max} = 80\text{ V}, V_N = 63\text{ V}$								
J 280	120	77	150	1,10	14	32	20	B59339-A1320-P20
J 281	120	60	120	0,90	10	50	31	B59339-A1500-P20
$V_{max} = 160\text{ V}, V_N = 110\text{ V}$								
J 282	120	48	100	0,70	6,0	80	50	B59339-A1800-P20
J 283	120	39	80	0,58	5,0	120	75	B59339-A1121-P20
$V_{max} = 265\text{ V}, V_N = 220\text{ V}$								
J 284	120	30	60	0,42	4,0	200	110	B59339-A1201-P20
J 285	120	24	50	0,33	4,0	320	200	B59339-A1321-P20
J 286	120	20	40	0,27	3,5	500	260	B59339-A1501-P20
J 287	120	15	30	0,22	3,0	800	480	B59339-A1801-P20
J 288	120	13	26	0,18	2,5	1200	630	B59339-A1122-P20
J 289	120	10	20	0,15	2,0	2000	900	B59339-A1202-P20
J 290	115	8	16	0,12	1,5	3200	1500	B59339-A1322-P20

Characteristics (typical)

PTC resistance R_{PTC} versus
 PTC temperature T_{PTC}
 (measured at low signal voltage)

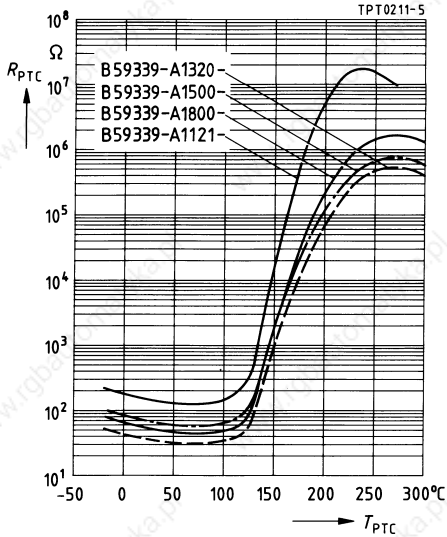

PTC current I_{PTC} versus PTC voltage V_{PTC}
 (measured at 25 °C in still air)

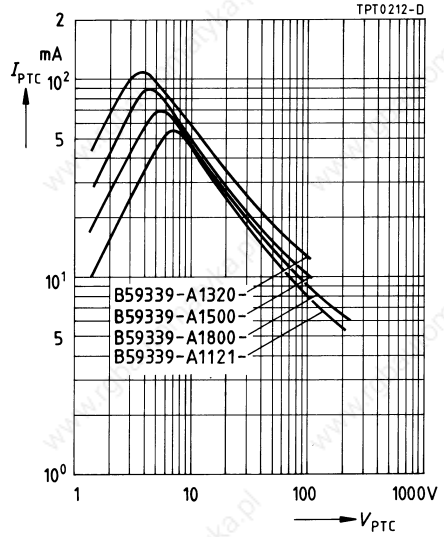

Switching time t_S versus switching current I_S
 (measured at 25 °C in still air)

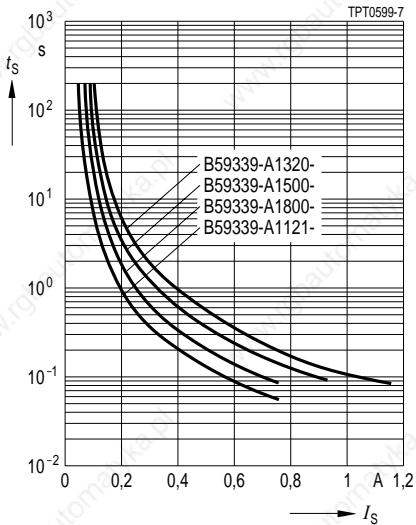

Characteristics (typical)

PTC resistance R_{PTC} versus
 PTC temperature T_{PTC}
 (measured at low signal voltage)

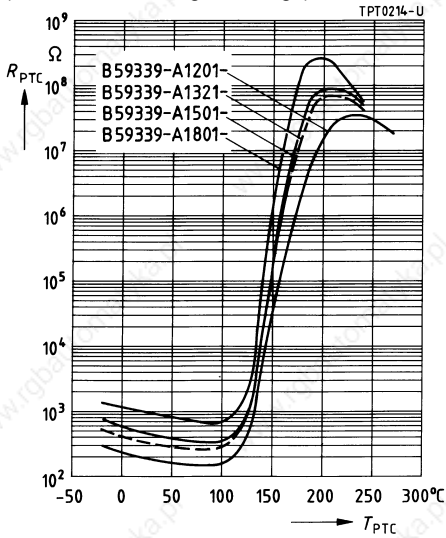

PTC current I_{PTC} versus PTC voltage V_{PTC}
 (measured at 25 °C in still air)

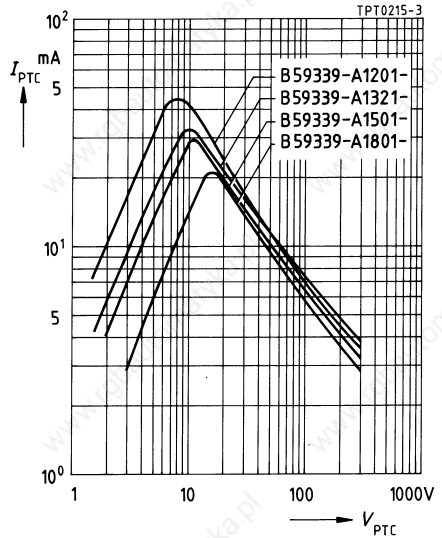

Switching time t_S versus switching current I_S
 (measured at 25 °C in still air)

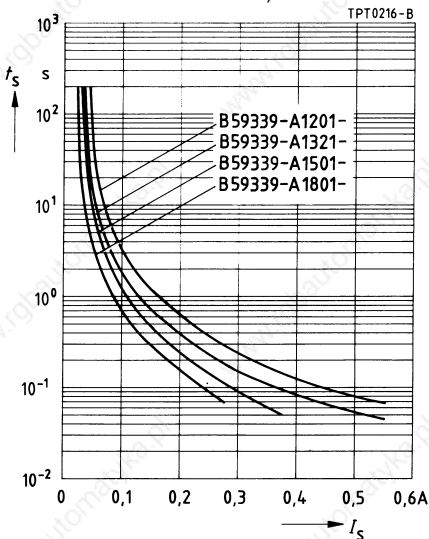

Characteristics (typical)

PTC resistance R_{PTC} versus
 PTC temperature T_{PTC}
 (measured at low signal voltage)

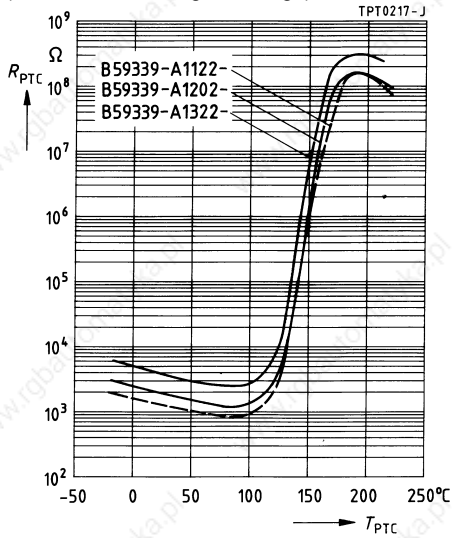

PTC current I_{PTC} versus PTC voltage V_{PTC}
 (measured at 25 °C in still air)

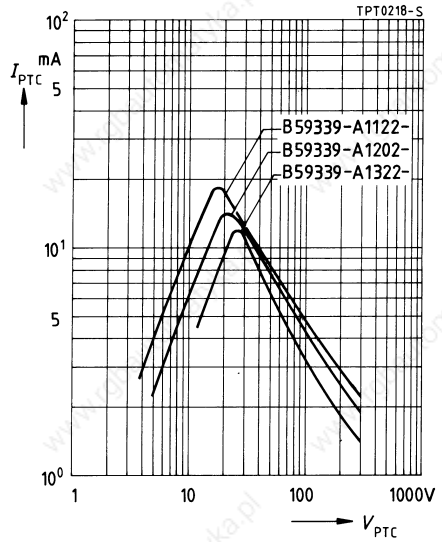

Switching time t_S versus switching current I_S
 (measured at 25 °C in still air)

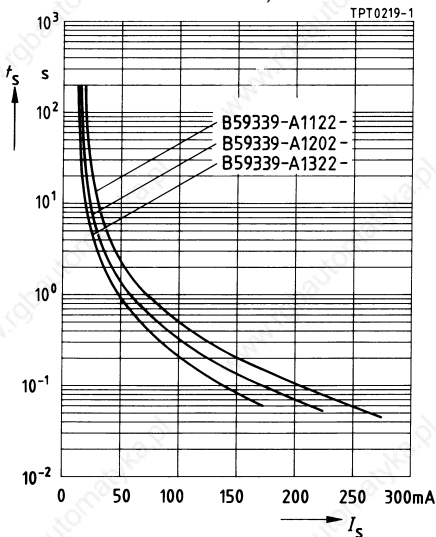

265 V

Applications

- Starting resistance in switch-mode power supplies

Features

- Encased thermistor disk with clamp contacts
- Flame-retardant plastic case
- Case material UL-listed
- Silver-plated solder pins
- Manufacturer's logo and type designation stamped on in white
- Stable performance throughout 50 000 switching cycles

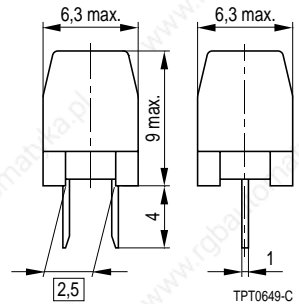

Dimensions (mm)

Max. operating voltage ($T_A = 60\text{ }^\circ\text{C}$)	V_{\max}	265	V
Rated voltage	V_N	220	V
Switching cycles (typ.)	N	50000	
Rated resistance	R_N	5000	Ω
Resistance tolerance	ΔR_N	$\pm 25\%$	
Operating temperature range ($V = 0$)	T_{op}	$-25/+125$	$^\circ\text{C}$
	T_{op}	0/60	$^\circ\text{C}$

Type	T_{Ref} $^\circ\text{C}$	I_N mA	I_S mA	$I_{S\max}$ ($V=V_{\max}$) A	t_S s	I_r ($V=V_{\max}$) mA	R_{\min} Ω	Ordering code
J 29	115	7	15	0,1	$\leq 0,5$	1,5	1500	B59339-A1502-P20
J 29	150	10	20	0,1	$\leq 1,0$	1,8	2200	B59342-A1502-P20
J 29	190	14	30	0,1	$\leq 2,0$	2,0	2200	B59346-A1502-P20

Characteristics (typical)

PTC resistance R_{PTC} versus
PTC temperature T_{PTC}
(measured at low signal voltage)

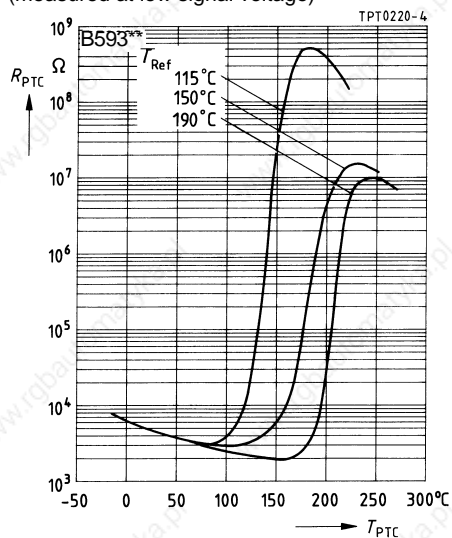

PTC current I_{PTC} versus PTC voltage V_{PTC}
(measured at 25 °C in still air)

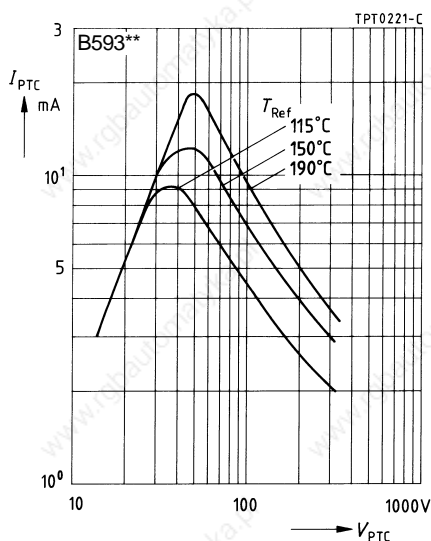

Switching time t_s versus switching current I_s
(measured at 25 °C in still air)

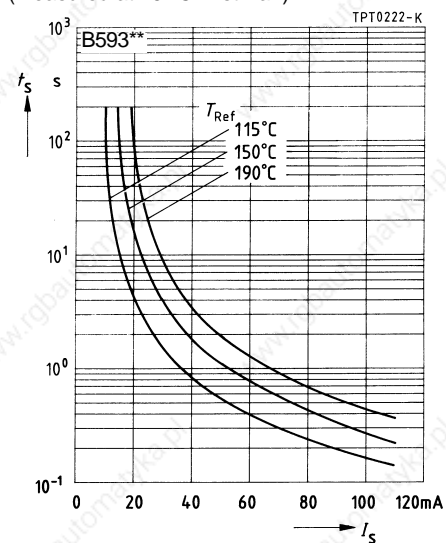

175 V to 400 V

Applications

- Time delay
- Motor starting
- Time delay in turning off the auxiliary winding of single-phase ac motors

Features

- Two versions available
- Version A:
Uncoated, metallized disk for clamp-contacting
UL approval for all types with the exception of A 196, A 502
- Version J:
Thermistor disk encapsulated in heat-resistant, flame-retardant plastic case with connections for compressor power supplies and tab connectors;
other cases and other terminal options upon request
UL approval for all types with the exception of J 502
- VDE approval for A 192, A 501, J 501 and J 502

Switching cycles	N	> 100000	
Operating temperature range ($V = 0$) ($V = V_{\max}$)	T_{op}	5/80	°C
	T_{op}	5/80	°C

Type	V_{\max} V	I_{\max} A	T_{Ref} °C	V_D V	$R_N \pm \Delta R$ ($V_{\text{PTC}} \leq 2,5 \text{ V}$) Ω	I_r mA
A 192	325	8	120	> 650	25 + 15/- 20 %	10
A 196	350	8	120	> 700	15 +/- 30 %	10
A 501	355	6	135	700	33 ± 20 %	9
A 502	400	4	120	750	47 ± 30 %	9
A 508	180	10	135	360	4,7 ± 20 %	25
A 544	320	8	120	650	20 + 20/- 30 %	15
J 501	355	6	135	700	33 ± 20 %	9
J 502	400	4	120	750	47 ± 30 %	9

Version A

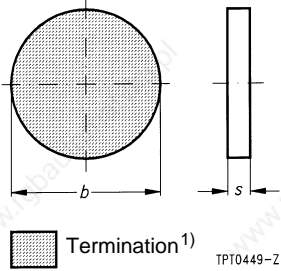

Version J

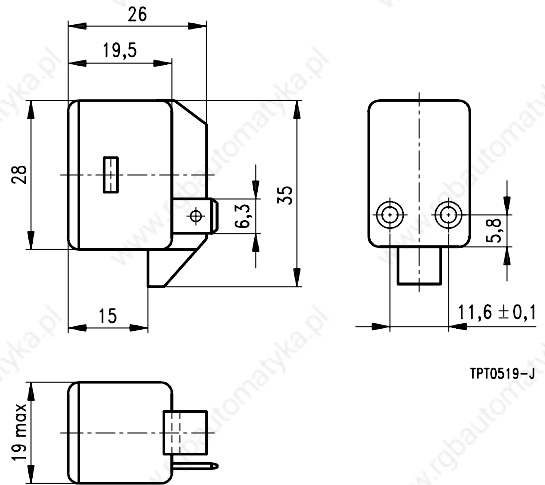

Dimensions (mm)

Type	<i>b</i>	<i>s</i>
A 192	20,5 + 0,5/- 1,0	2,5 ± 0,2
A 196	20,5 + 0,5/- 1,0	3,2 ± 0,2
A 501	19,5 + 0,5	2,5 ± 0,2
A 502	19,5 + 0,5	2,5 ± 0,2
A 508	18,0 ± 1,0	2,5 ± 0,2
A 544	17,5 ± 0,5	2,5 ± 0,2

Type	T_{surf} °C	t_s s	Metallization	Ordering code
A 192	180	0,7	Ag	B59192-A120-A10
A 196	180	1,2	Ag	B59196-A120-A10
A 501	180	0,8	Ag	B59501-A135-A10
A 502	170	0,7	Ag	B59502-A120-A10
A 508	185	1,3	Ag	B59508-A135-A10
A 544	180	0,5	Cr Ni + Ag	B59544-A120-A20
J 501	—	0,8	Ag	B59501-J135-A110
J 502	—	0,7	Ag	B59502-J120-A110

1) A 544 with boarder (1 mm typ.)

Applications

- Thermal protection of winding in electric motors
- Limit temperature monitoring

Features

- Thermistor pellet with insulating encapsulation
- Low-resistance type
- Silver-plated and Teflon(PTFE)-insulated AWG 26 litz wires
- Trip temperature coded in litz wire color
- Extremely fast response due to small dimensions
- Characteristics for nominal threshold temperatures of 90 bis 160 °C conform with DIN 44 081
- Can be used in conjunction with Siemens tripping units

Max. operating voltage	$(T_A = 0 \dots 40 \text{ }^\circ\text{C})$	V_{\max}	30	V
Max. measuring voltage	$(T_A - 25 \text{ K} \dots T_{\text{NAT}} + 15 \text{ K})$	$V_{\text{Mes,max}}$	7,5	V
Rated resistance	$(V_{\text{PTC}} \leq 2,5 \text{ V})$	R_N	≤ 100	Ω
Insulation test voltage		V_{is}	2,5	kV ac
Response time		t_a	< 3	s
Operating temperature range	$(V = 0)$ $(V = V_{\max})$	T_{op} T_{op}	$-25/+180$ 0/40	$^\circ\text{C}$ $^\circ\text{C}$

Type	$T_{\text{NAT}} \pm \Delta T$ $^\circ\text{C}$	$R(T_{\text{NAT}} - \Delta T)$ $(V_{\text{PTC}} \leq 2,5 \text{ V})$ Ω	$R(T_{\text{NAT}} + \Delta T)$ $(V_{\text{PTC}} \leq 2,5 \text{ V})$ Ω	$R(T_{\text{NAT}} + 15 \text{ K})$ $(V_{\text{PTC}} \leq 7,5 \text{ V})$ Ω	$R(T_{\text{NAT}} + 23 \text{ K})$ $(V_{\text{PTC}} \leq 2,5 \text{ V})$ Ω
M 1100	60 ± 5	≤ 570	≥ 570	—	$\geq 10 \text{ k}$
M 1100	70 ± 5	≤ 570	≥ 570	—	$\geq 10 \text{ k}$
M 1100	80 ± 5	≤ 570	≥ 570	—	—
M 1100	90 ± 5	≤ 550	≥ 1330	$\geq 4 \text{ k}$	—
M 1100	100 ± 5	≤ 550	≥ 1330	$\geq 4 \text{ k}$	—
M 1100	110 ± 5	≤ 550	≥ 1330	$\geq 4 \text{ k}$	—
M 1100	120 ± 5	≤ 550	≥ 1330	$\geq 4 \text{ k}$	—
M 1100	130 ± 5	≤ 550	≥ 1330	$\geq 4 \text{ k}$	—
M 1100	140 ± 5	≤ 550	≥ 1330	$\geq 4 \text{ k}$	—
M 1100	145 ± 5	≤ 550	≥ 1330	$\geq 4 \text{ k}$	—
M 1100	150 ± 5	≤ 550	≥ 1330	$\geq 4 \text{ k}$	—
M 1100	155 ± 5	≤ 550	≥ 1330	$\geq 4 \text{ k}$	—
M 1100	160 ± 5	≤ 550	≥ 1330	$\geq 4 \text{ k}$	—
M 1100	170 ± 7	≤ 570	≥ 570	—	$\geq 10 \text{ k}$
M 1100	180 ± 7	≤ 570	≥ 570	—	$\geq 10 \text{ k}$
M 1100	190 ± 7	≤ 570	≥ 570	—	$\geq 10 \text{ k}$

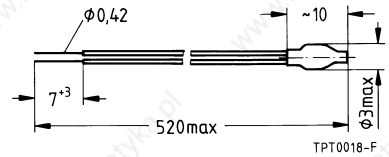

Dimensions in mm

Type	Color coding of litz wires	Ordering code
M 1100	white/grey	B59100-M1060-A70
M 1100	white/brown	B59100-M1070-A70
M 1100	white/white	B59100-M1080-A70
M 1100	green/green	B59100-M1090-A70
M 1100	red/red	B59100-M1100-A70
M 1100	brown/brown	B59100-M1110-A70
M 1100	grey/grey	B59100-M1120-A70
M 1100	blue/blue	B59100-M1130-A70
M 1100	white/blue	B59100-M1140-A70
M 1100	white/black	B59100-M1145-A70
M 1100	black/black	B59100-M1150-A70
M 1100	blue/black	B59100-M1155-A70
M 1100	blue/red	B59100-M1160-A70
M 1100	white/green	B59100-M1170-A70
M 1100	white/red	B59100-M1180-A70
M 1100	black/grey	B59100-M1190-A70

Characteristics (typical)

PTC resistance R_{PTC} versus PTC temperature T_{PTC}
(measured at low signal voltage)

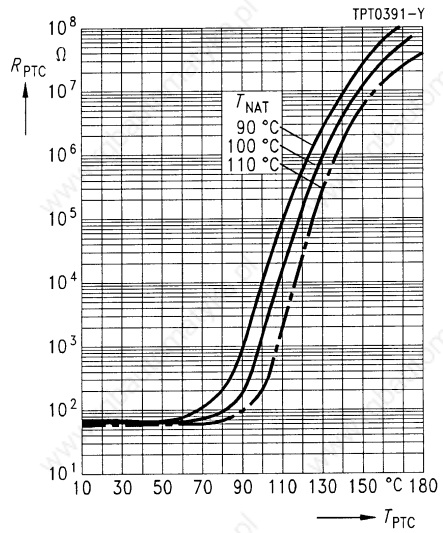
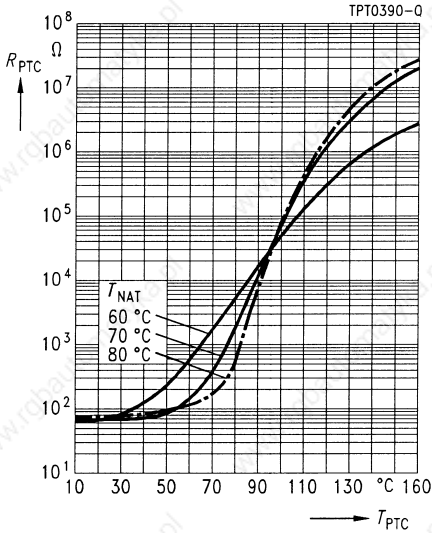

PTC resistance R_{PTC} versus PTC temperature T_{PTC}
(measured at low signal voltage)

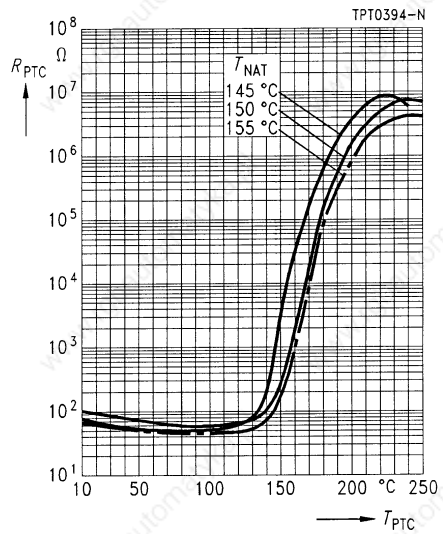
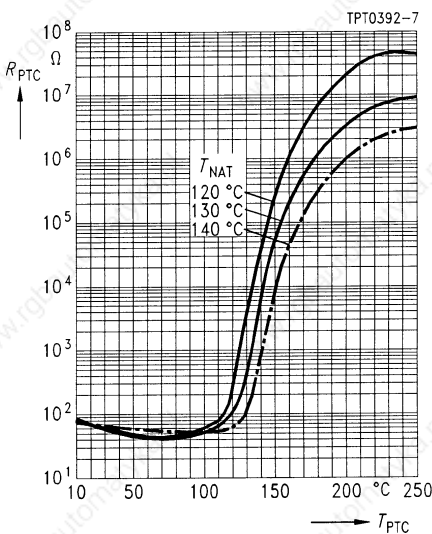

Characteristics (typical)

PTC resistance R_{PTC} versus PTC temperature T_{PTC}
(measured at low signal voltage)

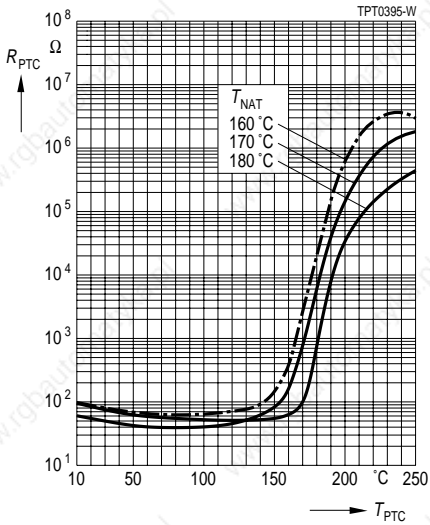

Applications

- Thermal protection of winding in electric motors
- Limit temperature monitoring

Features

- Thermistor pellets with insulating encapsulation in series connection (triple sensor)
- Low-resistance type
- Silver-plated and Teflon(PTFE)-insulated AWG 26 litz wires
- Trip temperature coded in litz wire color, connecting wires all yellow
- Characteristics for nominal threshold temperatures of 90 bis 160 °C conform with DIN 44 082
- Can be used in conjunction with Siemens tripping units

Max. operating voltage	($T_A = 0 \dots 40 \text{ }^\circ\text{C}$)	V_{\max}	30	V
Max. measuring voltage	($T_A - 25 \text{ K} \dots T_{\text{NAT}} + 15 \text{ K}$)	$V_{\text{Mes,max}}$	7,5	V
Rated resistance	($V_{\text{PTC}} \leq 2,5 \text{ V}$)	R_N	≤ 300	Ω
Insulation test voltage		V_{is}	2,5	kV ac
Response time		t_a	< 3	s
Operating temperature range	($V = 0$)	T_{op}	$-25/+180$	$^\circ\text{C}$
	($V = V_{\max}$)	T_{op}	0/40	$^\circ\text{C}$

Type	$T_{\text{NAT}} \pm \Delta T$ $^\circ\text{C}$	$R(T_{\text{NAT}} - \Delta T)$ ($V_{\text{PTC}} \leq 2,5 \text{ V}$) Ω	$R(T_{\text{NAT}} + \Delta T)$ ($V_{\text{PTC}} \leq 2,5 \text{ V}$) Ω	$R(T_{\text{NAT}} + 15 \text{ K})$ ($V_{\text{PTC}} \leq 7,5 \text{ V}$) Ω	$R(T_{\text{NAT}} + 23 \text{ K})$ ($V_{\text{PTC}} \leq 2,5 \text{ V}$) Ω
M 1300	60 ± 5	≤ 1710	≥ 1710	—	$\geq 30 \text{ k}$
M 1300	70 ± 5	≤ 1710	≥ 1710	—	$\geq 30 \text{ k}$
M 1300	80 ± 5	≤ 1710	≥ 1710	—	$\geq 30 \text{ k}$
M 1300	90 ± 5	≤ 1650	≥ 3990	$\geq 12 \text{ k}$	—
M 1300	100 ± 5	≤ 1650	≥ 3990	$\geq 12 \text{ k}$	—
M 1300	110 ± 5	≤ 1650	≥ 3990	$\geq 12 \text{ k}$	—
M 1300	120 ± 5	≤ 1650	≥ 3990	$\geq 12 \text{ k}$	—
M 1300	130 ± 5	≤ 1650	≥ 3990	$\geq 12 \text{ k}$	—
M 1300	140 ± 5	≤ 1650	≥ 3990	$\geq 12 \text{ k}$	—
M 1300	145 ± 5	≤ 1650	≥ 3990	$\geq 12 \text{ k}$	—
M 1300	150 ± 5	≤ 1650	≥ 3990	$\geq 12 \text{ k}$	—
M 1300	155 ± 5	≤ 1650	≥ 3990	$\geq 12 \text{ k}$	—
M 1300	160 ± 5	≤ 1650	≥ 3990	$\geq 12 \text{ k}$	—
M 1300	170 ± 7	≤ 1710	≥ 1710	—	$\geq 30 \text{ k}$
M 1300	180 ± 7	≤ 1710	≥ 1710	—	$\geq 30 \text{ k}$
M 1300	190 ± 7	≤ 1710	≥ 1710	—	$\geq 30 \text{ k}$

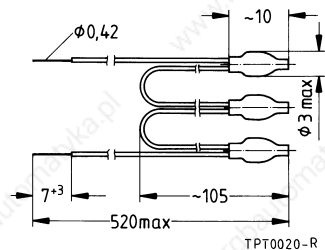

Dimensions in mm

Type	Color coding of litz wires	Ordering code
M 1300	white/grey	B59300-M1060-A70
M 1300	white/brown	B59300-M1070-A70
M 1300	white/white	B59300-M1080-A70
M 1300	green/green	B59300-M1090-A70
M 1300	red/red	B59300-M1100-A70
M 1300	brown/brown	B59300-M1110-A70
M 1300	grey/grey	B59300-M1120-A70
M 1300	blue/blue	B59300-M1130-A70
M 1300	white/blue	B59300-M1140-A70
M 1300	white/black	B59300-M1145-A70
M 1300	black/black	B59300-M1150-A70
M 1300	blue/black	B59300-M1155-A70
M 1300	blue/red	B59300-M1160-A70
M 1300	white/green	B59300-M1170-A70
M 1300	white/red	B59300-M1180-A70
M 1300	black/grey	B59300-M1190-A70

Characteristics (typical)

PTC resistance R_{PTC} versus PTC temperature T_{PTC}
(measured at low signal voltage)

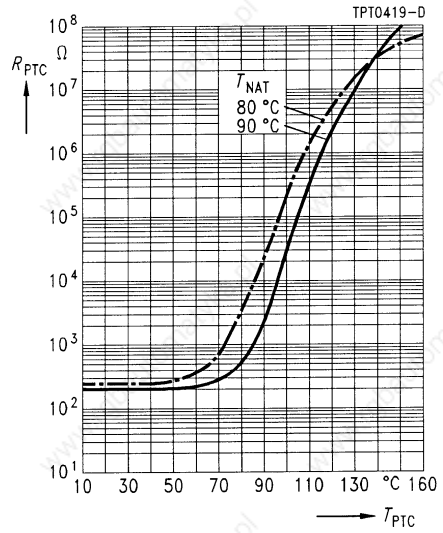
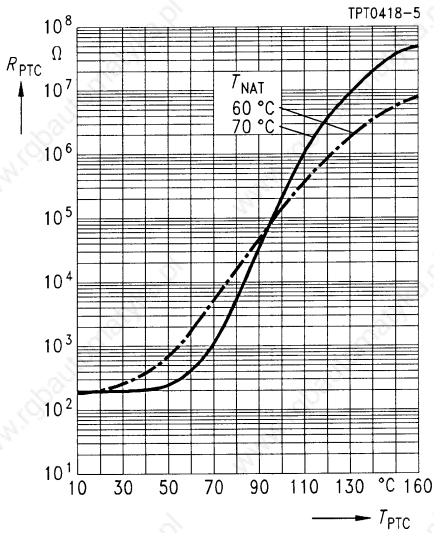

PTC resistance R_{PTC} versus PTC temperature T_{PTC}
(measured at low signal voltage)

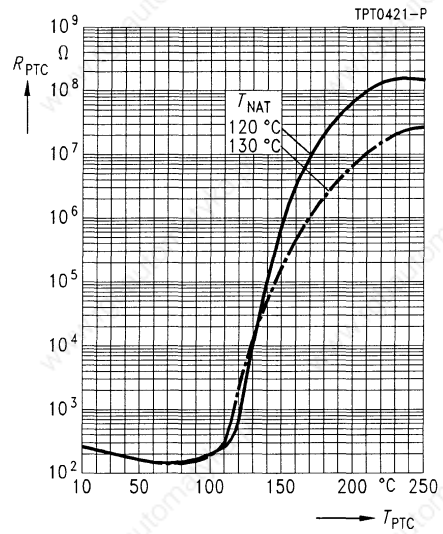
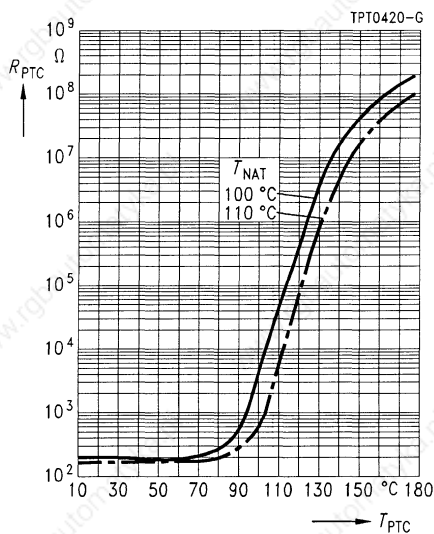

Characteristics (typical)

PTC resistance R_{PTC} versus PTC temperature T_{PTC}
(measured at low signal voltage)

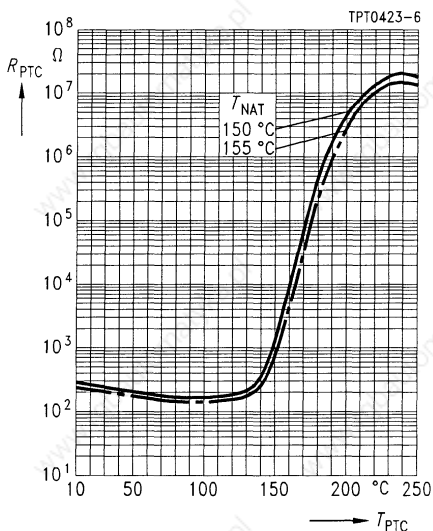
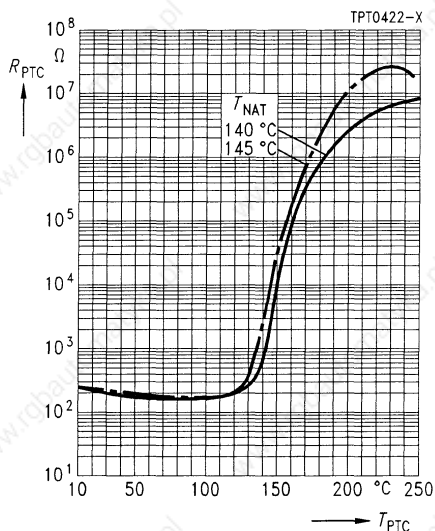

PTC resistance R_{PTC} versus PTC temperature T_{PTC}
(measured at low signal voltage)

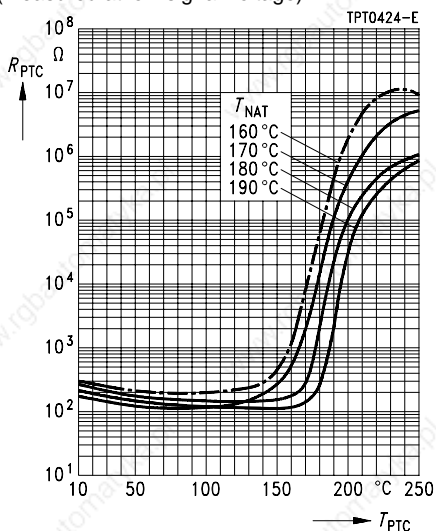

Applications

- Thermal protection of winding in electric motors
- Limit temperature monitoring

Features

- Thermistor pellet with insulating encapsulation
- Silver-plated and Teflon(PTFE)-insulated AWG 26 litz wires
- Trip temperature coded in litz wire color
- Extremely fast response due to small dimensions
- Characteristics for nominal threshold temperatures of 90 bis 160 °C conform with DIN 44 081
- Can be used in conjunction with Siemens tripping units

Max. operating voltage	($T_A = 0 \dots 40 \text{ }^\circ\text{C}$)	V_{\max}	30	V
Max. measuring voltage	($T_A - 25 \text{ K} \dots T_{\text{NAT}} + 15 \text{ K}$)	$V_{\text{Mes,max}}$	7,5	V
Rated resistance	($V_{\text{PTC}} \leq 2,5 \text{ V}$)	R_N	≤ 250	Ω
Insulation test voltage		V_{is}	2,5	kV ac
Response time		t_a	< 3	s
Operating temperature range ($V = 0$)		T_{op}	$- 25/+ 180$	$^\circ\text{C}$
	($V = V_{\max}$)	T_{op}	0/40	$^\circ\text{C}$

Type	$T_{\text{NAT}} \pm \Delta T$ $^\circ\text{C}$	$R(T_{\text{NAT}} - \Delta T)$ ($V_{\text{PTC}} \leq 2,5 \text{ V}$) Ω	$R(T_{\text{NAT}} + \Delta T)$ ($V_{\text{PTC}} \leq 2,5 \text{ V}$) Ω	$R(T_{\text{NAT}} + 15 \text{ K})$ ($V_{\text{PTC}} \leq 7,5 \text{ V}$) Ω	$R(T_{\text{NAT}} + 23 \text{ K})$ ($V_{\text{PTC}} \leq 2,5 \text{ V}$) Ω
M 135	60 ± 5	≤ 570	≥ 570	—	≥ 4 k
M 135	70 ± 5	≤ 570	≥ 570	—	≥ 4 k
M 135	80 ± 5	≤ 570	≥ 570	—	≥ 4 k
M 135	90 ± 5	≤ 550	≥ 1330	≥ 4 k	—
M 135	100 ± 5	≤ 550	≥ 1330	≥ 4 k	—
M 135	110 ± 5	≤ 550	≥ 1330	≥ 4 k	—
M 135	120 ± 5	≤ 550	≥ 1330	≥ 4 k	—
M 135	130 ± 5	≤ 550	≥ 1330	≥ 4 k	—
M 135	140 ± 5	≤ 550	≥ 1330	≥ 4 k	—
M 135	145 ± 5	≤ 550	≥ 1330	≥ 4 k	—
M 135	150 ± 5	≤ 550	≥ 1330	≥ 4 k	—
M 135	155 ± 5	≤ 550	≥ 1330	≥ 4 k	—
M 135	160 ± 5	≤ 550	≥ 1330	≥ 4 k	—
M 135	170 ± 7	≤ 570	≥ 570	—	≥ 4 k
M 135	180 ± 7	≤ 570	≥ 570	—	≥ 4 k

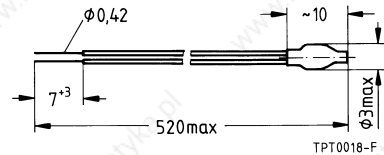

Dimensions in mm

Type	Color coding of litz wires	Ordering code
M 135	white/grey	B59135-M60-A70
M 135	white/brown	B59135-M70-A70
M 135	white/white	B59135-M80-A70
M 135	green/green	B59135-M90-A70
M 135	red/red	B59135-M100-A70
M 135	brown/brown	B59135-M110-A70
M 135	grey/grey	B59135-M120-A70
M 135	blue/blue	B59135-M130-A70
M 135	white/blue	B59135-M140-A70
M 135	white/black	B59135-M145-A70
M 135	black/black	B59135-M150-A70
M 135	blue/black	B59135-M155-A70
M 135	blue/red	B59135-M160-A70
M 135	white/green	B59135-M170-A70
M 135	white/red	B59135-M180-A70

Characteristics (typical)

PTC resistance R_{PTC} versus PTC temperature T_{PTC}
(measured at low signal voltage)

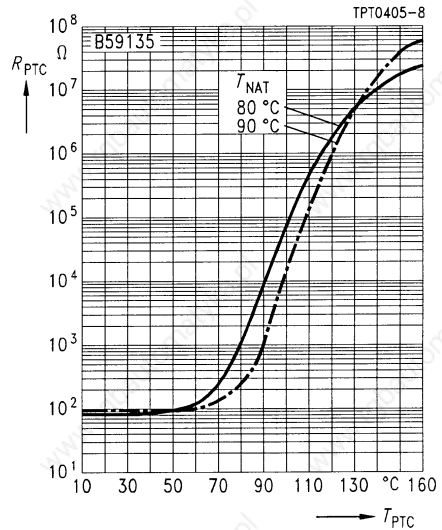
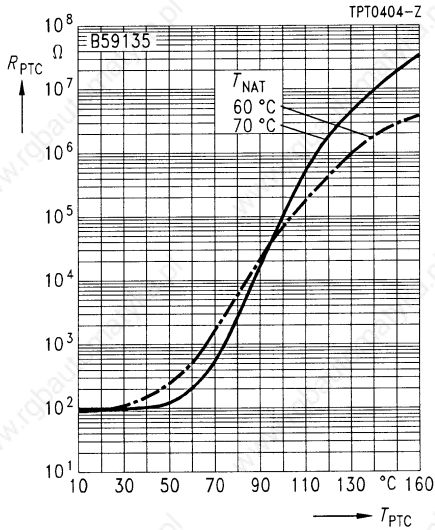

PTC resistance R_{PTC} versus PTC temperature T_{PTC}
(measured at low signal voltage)

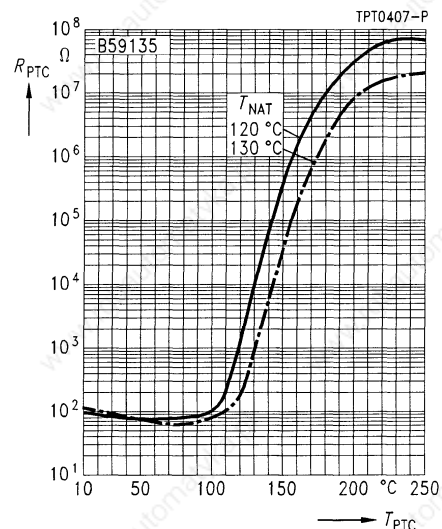
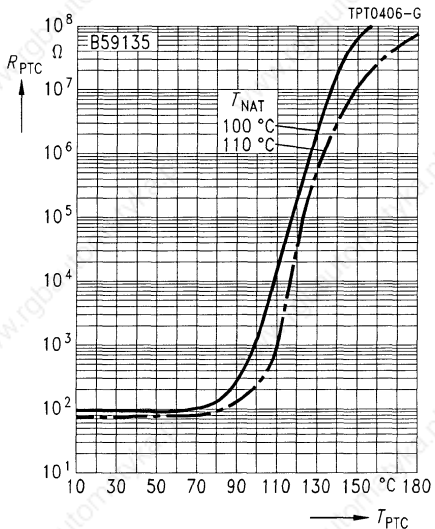

Characteristics (typical)

PTC resistance R_{PTC} versus PTC temperature T_{PTC}
(measured at low signal voltage)

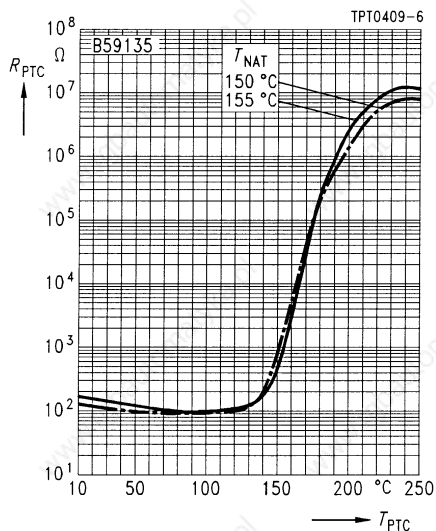
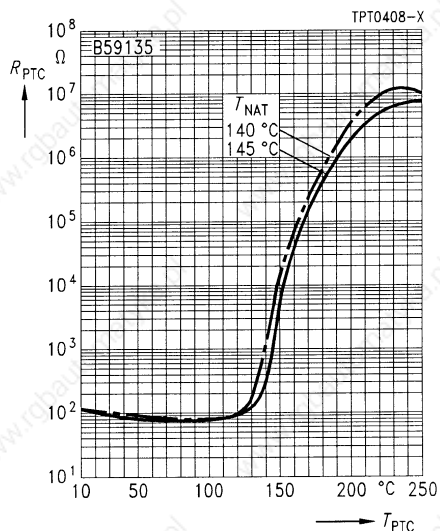

PTC resistance R_{PTC} versus PTC temperature T_{PTC}
(measured at low signal voltage)

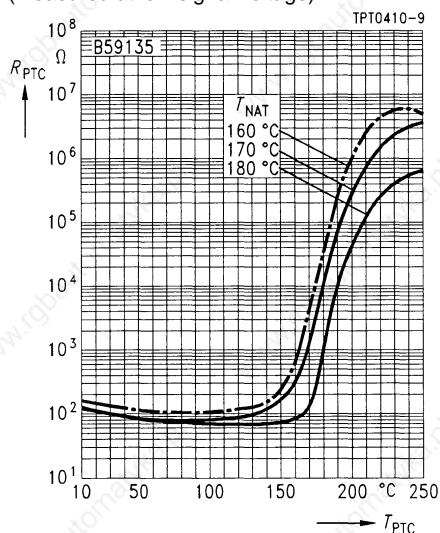

Applications

- Thermal protection of winding in electric motors

Features

- Thermistor pellets with insulating encapsulation in series connection (triple sensor)
- Low-resistance type
- Silver-plated and Teflon(PTFE)-insulated AWG 26 litz wires
- Trip temperature coded in litz wire color, connecting wires all yellow
- Extremely fast response due to small dimensions
- Characteristics for nominal threshold temperatures of 90 bis 160 °C conform with DIN 44 082
- Can be used in conjunction with Siemens tripping units

Max. operating voltage	$(T_A = 0 \dots 40 \text{ }^\circ\text{C})$	V_{max}	30	V
Max. measuring voltage	$(T_A - 25 \text{ K} \dots T_{\text{NAT}} + 15 \text{ K})$	$V_{\text{Mes,max}}$	7,5	V
Rated resistance	$(V_{\text{PTC}} \leq 2,5 \text{ V})$	R_N	≤ 750	Ω
Insulation test voltage		V_{is}	2,5	kV ac
Response time		t_a	< 3	s
Operating temperature range	$(V = 0)$	T_{op}	$- 25/+ 180$	$^\circ\text{C}$
	$(V = V_{\text{max}})$	T_{op}	0/40	$^\circ\text{C}$

Type	$T_{\text{NAT}} \pm \Delta T$ $^\circ\text{C}$	$R(T_{\text{NAT}} - \Delta T)$ $(V_{\text{PTC}} \leq 2,5 \text{ V})$ Ω	$R(T_{\text{NAT}} + \Delta T)$ $(V_{\text{PTC}} \leq 2,5 \text{ V})$ Ω	$R(T_{\text{NAT}} + 15 \text{ K})$ $(V_{\text{PTC}} \leq 7,5 \text{ V})$ Ω	$R(T_{\text{NAT}} + 23 \text{ K})$ $(V_{\text{PTC}} \leq 2,5 \text{ V})$ Ω
M 335	60 ± 5	≤ 1710	≥ 1710	—	≥ 12 k
M 335	70 ± 5	≤ 1710	≥ 1710	—	≥ 12 k
M 335	80 ± 5	≤ 1710	≥ 1710	—	≥ 12 k
M 335	90 ± 5	≤ 1650	≥ 3990	≥ 12 k	—
M 335	100 ± 5	≤ 1650	≥ 3990	≥ 12 k	—
M 335	110 ± 5	≤ 1650	≥ 3990	≥ 12 k	—
M 335	120 ± 5	≤ 1650	≥ 3990	≥ 12 k	—
M 335	130 ± 5	≤ 1650	≥ 3990	≥ 12 k	—
M 335	140 ± 5	≤ 1650	≥ 3990	≥ 12 k	—
M 335	145 ± 5	≤ 1650	≥ 3990	≥ 12 k	—
M 335	150 ± 5	≤ 1650	≥ 3990	≥ 12 k	—
M 335	155 ± 5	≤ 1650	≥ 3990	≥ 12 k	—
M 335	160 ± 5	≤ 1650	≥ 3990	≥ 12 k	—
M 335	170 ± 7	≤ 1710	≥ 1710	—	≥ 12 k
M 335	180 ± 7	≤ 1710	≥ 1710	—	≥ 12 k

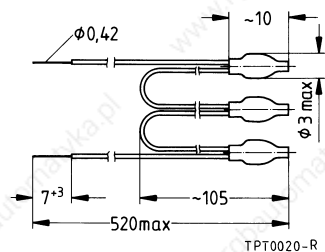

Dimensions in mm

Type	Color coding of litz wires	Ordering code
M 335	white/grey	B59335-M60-A70
M 335	white/brown	B59335-M70-A70
M 335	white/white	B59335-M80-A70
M 335	green/green	B59335-M90-A70
M 335	red/red	B59335-M100-A70
M 335	brown/brown	B59335-M110-A70
M 335	grey/grey	B59335-M120-A70
M 335	blue/blue	B59335-M130-A70
M 335	white/blue	B59335-M140-A70
M 335	white/black	B59335-M145-A70
M 335	black/black	B59335-M150-A70
M 335	blue/black	B59335-M155-A70
M 335	blue/red	B59335-M160-A70
M 335	white/green	B59335-M170-A70
M 335	white/red	B59335-M180-A70

Characteristics (typical)

PTC resistance R_{PTC} versus PTC temperature T_{PTC}
(measured at low signal voltage)

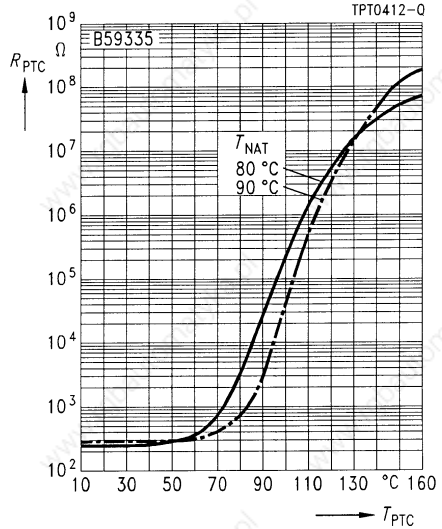
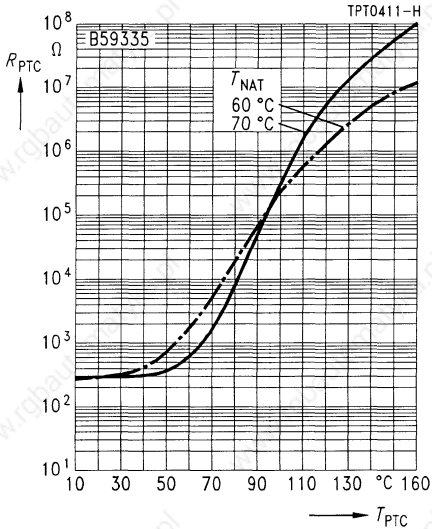

PTC resistance R_{PTC} versus PTC temperature T_{PTC}
(measured at low signal voltage)

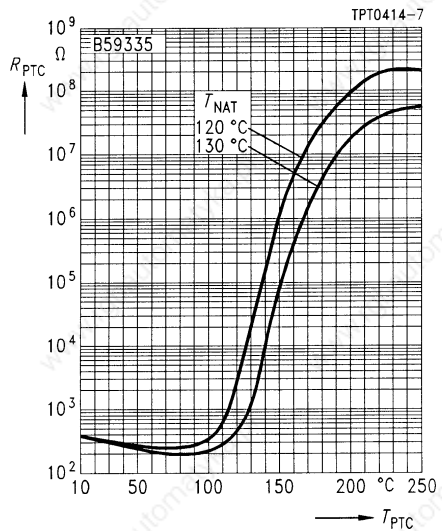
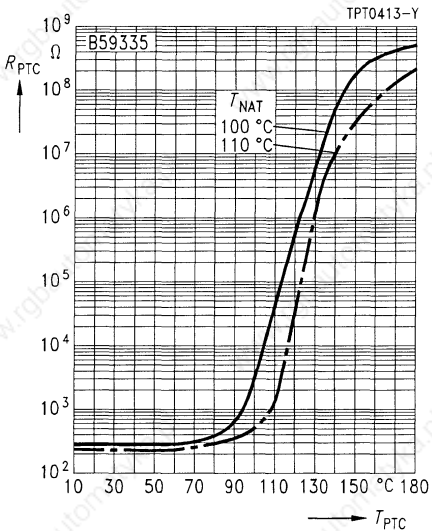

Characteristics (typical)

PTC resistance R_{PTC} versus PTC temperature T_{PTC}
(measured at low signal voltage)

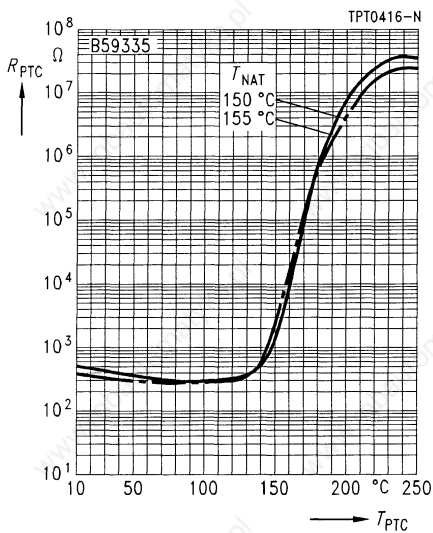
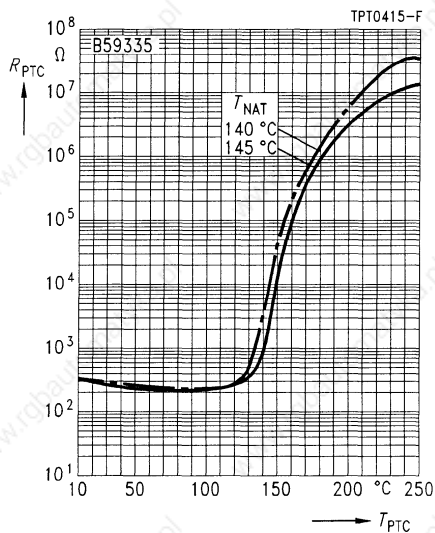

PTC resistance R_{PTC} versus PTC temperature T_{PTC}
(measured at low signal voltage)

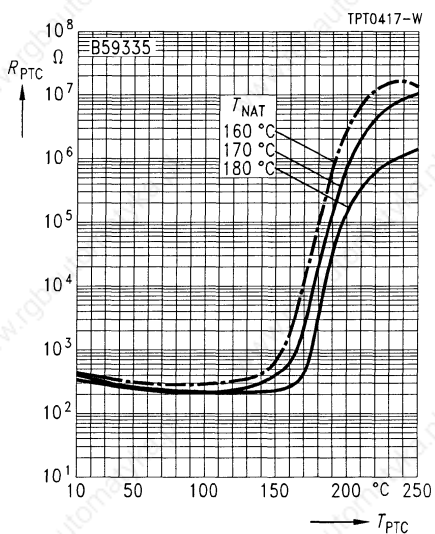

Applications

- Thermal protection of winding in electric motors

Features

- Thermistor pellet with insulating encapsulation
- Silver-plated and Teflon(PTFE)-insulated AWG 26 litz wires
- Trip temperature coded in litz wire color
- Characteristics for nominal threshold temperatures of 90 bis 160 °C conform with DIN 44 081
- Can be used in conjunction with Siemens tripping units

Max. operating voltage	$(T_A = 0 \dots 40 \text{ }^\circ\text{C})$	V_{max}	30	V
Max. measuring voltage	$(T_A - 25 \text{ K} \dots T_{\text{NAT}} + 15 \text{ K})$	$V_{\text{Mes,max}}$	7,5	V
Rated resistance	$(V_{\text{PTC}} \leq 2,5 \text{ V})$	R_N	≤ 100	Ω
Insulation test voltage		V_{is}	2,5	kV ac
Response time		t_a	< 5	s
Operating temperature range	$(V = 0)$	T_{op}	$-25/+180$	$^\circ\text{C}$
	$(V = V_{\text{max}})$	T_{op}	0/40	$^\circ\text{C}$

Type	$T_{\text{NAT}} \pm \Delta T$ $^\circ\text{C}$	$R(T_{\text{NAT}} - \Delta T)$ $(V_{\text{PTC}} \leq 2,5 \text{ V})$ Ω	$R(T_{\text{NAT}} + \Delta T)$ $(V_{\text{PTC}} \leq 2,5 \text{ V})$ Ω	$R(T_{\text{NAT}} + 15 \text{ K})$ $(V_{\text{PTC}} \leq 7,5 \text{ V})$ Ω	$R(T_{\text{NAT}} + 23 \text{ K})$ $(V_{\text{PTC}} \leq 2,5 \text{ V})$ Ω
M 155	60 ± 5	≤ 570	≥ 570	—	$\geq 10 \text{ k}$
M 155	70 ± 5	≤ 570	≥ 570	—	$\geq 10 \text{ k}$
M 155	80 ± 5	≤ 570	≥ 570	—	$\geq 10 \text{ k}$
M 155	90 ± 5	≤ 550	≥ 1330	$\geq 4 \text{ k}$	—
M 155	100 ± 5	≤ 550	≥ 1330	$\geq 4 \text{ k}$	—
M 155	110 ± 5	≤ 550	≥ 1330	$\geq 4 \text{ k}$	—
M 155	120 ± 5	≤ 550	≥ 1330	$\geq 4 \text{ k}$	—
M 155	130 ± 5	≤ 550	≥ 1330	$\geq 4 \text{ k}$	—
M 155	140 ± 5	≤ 550	≥ 1330	$\geq 4 \text{ k}$	—
M 155	145 ± 5	≤ 550	≥ 1330	$\geq 4 \text{ k}$	—
M 155	150 ± 5	≤ 550	≥ 1330	$\geq 4 \text{ k}$	—
M 155	155 ± 5	≤ 550	≥ 1330	$\geq 4 \text{ k}$	—
M 155	160 ± 5	≤ 550	≥ 1330	$\geq 4 \text{ k}$	—
M 155	170 ± 6	≤ 550	≥ 1330	$\geq 4 \text{ k}$	—
M 155	180 ± 6	≤ 550	≥ 1330	$\geq 4 \text{ k}$	—

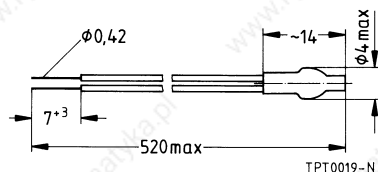

Dimensions in mm

Type	Color coding of litz wires	Ordering code
M 155	white/grey	B59155-M60-A70
M 155	white/brown	B59155-M70-A70
M 155	white/white	B59155-M80-A70
M 155	green/green	B59155-M90-A70
M 155	red/red	B59155-M100-A70
M 155	brown/brown	B59155-M110-A70
M 155	grey/grey	B59155-M120-A70
M 155	blue/blue	B59155-M130-A70
M 155	white/blue	B59155-M140-A70
M 155	white/black	B59155-M145-A70
M 155	black/black	B59155-M150-A70
M 155	blue/black	B59155-M155-A70
M 155	blue/red	B59155-M160-A70
M 155	white/green	B59155-M170-A70
M 155	white/red	B59155-M180-A70

Characteristics (typical)

PTC resistance R_{PTC} versus PTC temperature T_{PTC}
(measured at low signal voltage)

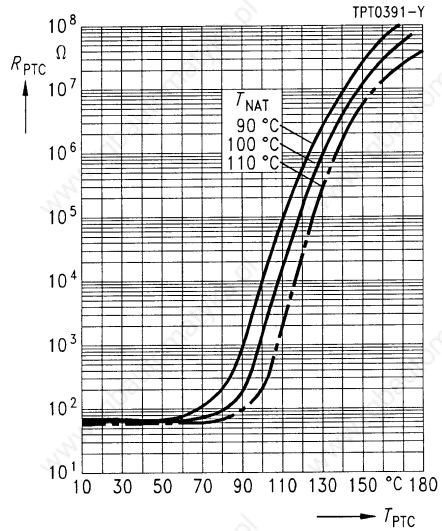
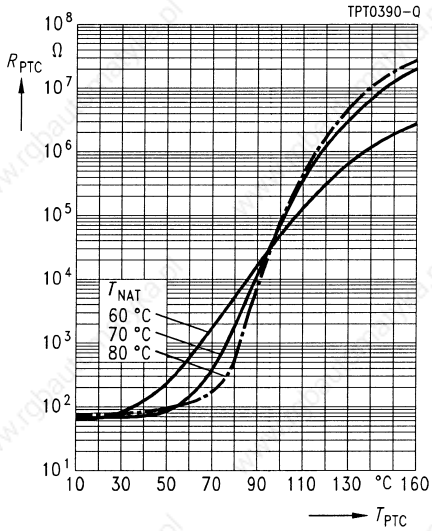

PTC resistance R_{PTC} versus PTC temperature T_{PTC}
(measured at low signal voltage)

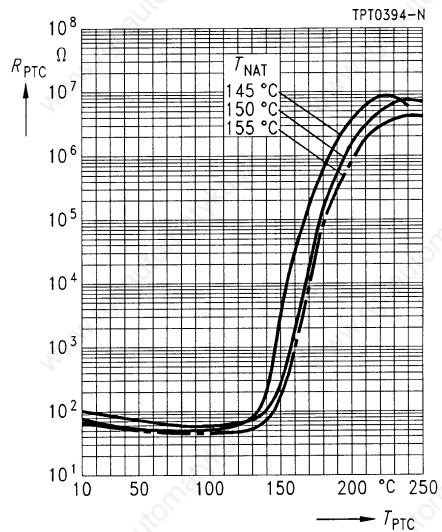
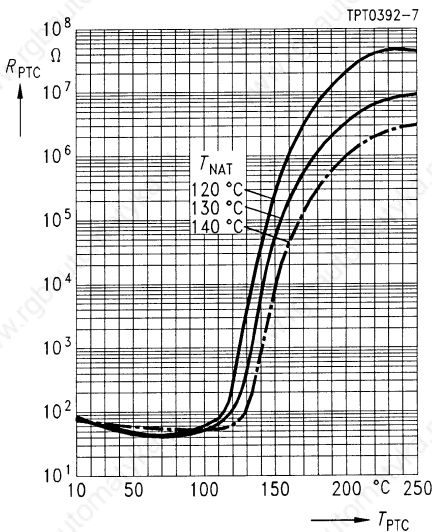

Characteristics (typical)

PTC resistance R_{PTC} versus PTC temperature T_{PTC}
(measured at low signal voltage)

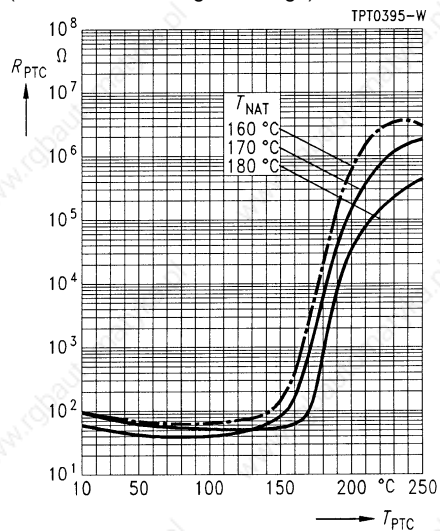

Applications

- Thermal protection of winding in electric motors

Features

- Thermistor pellets with insulating encapsulation in series connection (triple sensor)
- Silver-plated and Teflon(PTFE)-insulated AWG 26 litz wires
- Trip temperature coded in litz wire color, connecting wires all in black
- Characteristics for nominal threshold temperatures of 90 bis 160 °C conform with DIN 44 082
- Can be used in conjunction with Siemens tripping units 3UN6 to 3UN9

Max. operating voltage	$(T_A = 0 \dots 40 \text{ }^\circ\text{C})$	V_{\max}	30	V
Max. measuring voltage	$(T_A - 25 \text{ K} \dots T_{\text{NAT}} + 15 \text{ K})$	$V_{\text{Mes,max}}$	7,5	V
Rated resistance	$(V_{\text{PTC}} \leq 2,5 \text{ V})$	R_N	≤ 300	Ω
Insulation test voltage		V_{is}	2,5	kV ac
Response time		t_a	< 5	s
Operating temperature range	$(V = 0)$	T_{op}	$- 25/+ 180$	$^\circ\text{C}$
	$(V = V_{\max})$	T_{op}	0/40	$^\circ\text{C}$

Type	$T_{\text{NAT}} \pm \Delta T$ $^\circ\text{C}$	$R(T_{\text{NAT}} - \Delta T)$ $(V_{\text{PTC}} \leq 2,5 \text{ V})$ Ω	$R(T_{\text{NAT}} + \Delta T)$ $(V_{\text{PTC}} \leq 2,5 \text{ V})$ Ω	$R(T_{\text{NAT}} + 15 \text{ K})$ $(V_{\text{PTC}} \leq 7,5 \text{ V})$ Ω	$R(T_{\text{NAT}} + 23 \text{ K})$ $(V_{\text{PTC}} \leq 2,5 \text{ V})$ Ω
M 355	60 ± 5	≤ 1710	≥ 1710	—	≥ 30 k
M 355	70 ± 5	≤ 1710	≥ 1710	—	≥ 30 k
M 355	80 ± 5	≤ 1710	≥ 1710	—	≥ 30 k
M 355	90 ± 5	≤ 1650	≥ 3990	≥ 12 k	—
M 355	100 ± 5	≤ 1650	≥ 3990	≥ 12 k	—
M 355	110 ± 5	≤ 1650	≥ 3990	≥ 12 k	—
M 355	120 ± 5	≤ 1650	≥ 3990	≥ 12 k	—
M 355	130 ± 5	≤ 1650	≥ 3990	≥ 12 k	—
M 355	140 ± 5	≤ 1650	≥ 3990	≥ 12 k	—
M 355	145 ± 5	≤ 1650	≥ 3990	≥ 12 k	—
M 355	150 ± 5	≤ 1650	≥ 3990	≥ 12 k	—
M 355	155 ± 5	≤ 1650	≥ 3990	≥ 12 k	—
M 355	160 ± 5	≤ 1650	≥ 3990	≥ 12 k	—
M 355	170 ± 6	≤ 1650	≥ 3990	≥ 12 k	—
M 355	180 ± 6	≤ 1650	≥ 3990	≥ 12 k	—

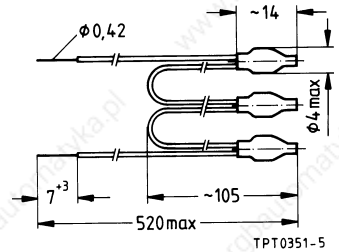

Dimensions in mm

Type	Color coding of litz wires	Ordering code
M 355	white/grey	B59355-M60-A70
M 355	white/brown	B59355-M70-A70
M 355	white/white	B59355-M80-A70
M 355	green/green	B59355-M90-A70
M 355	red/red	B59355-M100-A70
M 355	brown/brown	B59355-M110-A70
M 355	grey/grey	B59355-M120-A70
M 355	blue/blue	B59355-M130-A70
M 355	white/blue	B59355-M140-A70
M 355	white/black	B59355-M145-A70
M 355	black/black	B59355-M150-A70
M 355	blue/black	B59355-M155-A70
M 355	blue/red	B59355-M160-A70
M 355	white/green	B59355-M170-A70
M 355	white/red	B59355-M180-A70

Characteristics (typical)

PTC resistance R_{PTC} versus PTC temperature T_{PTC}
(measured at low signal voltage)

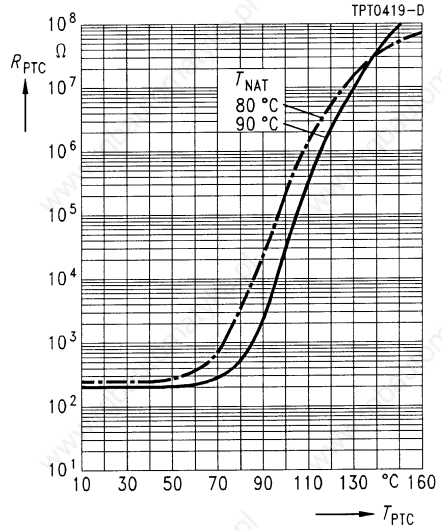
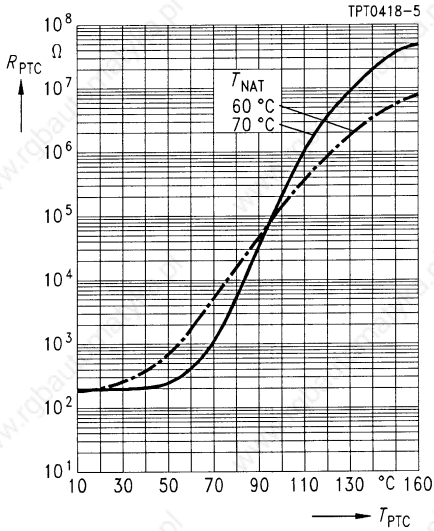

PTC resistance R_{PTC} versus PTC temperature T_{PTC}
(measured at low signal voltage)

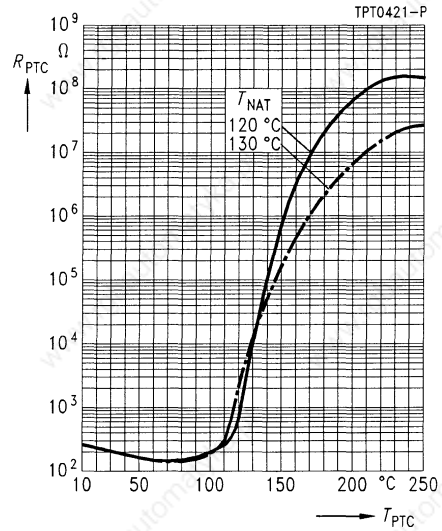
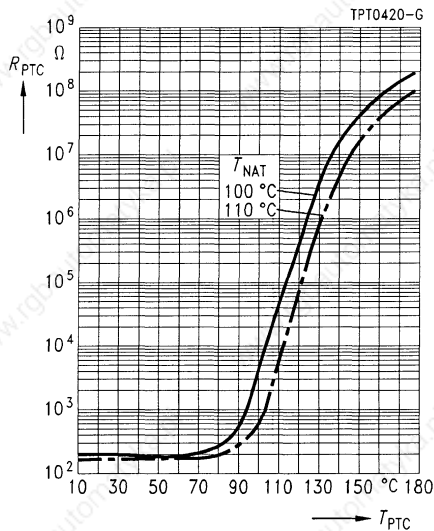

Characteristics (typical)

PTC resistance R_{PTC} versus PTC temperature T_{PTC}
(measured at low signal voltage)

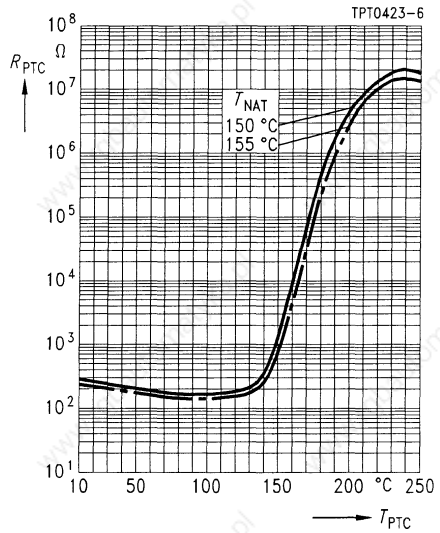
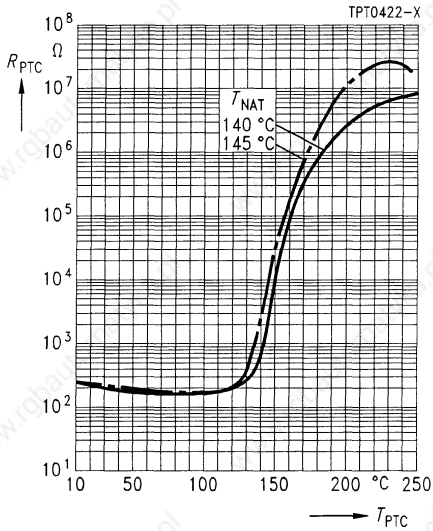

PTC resistance R_{PTC} versus PTC temperature T_{PTC}
(measured at low signal voltage)

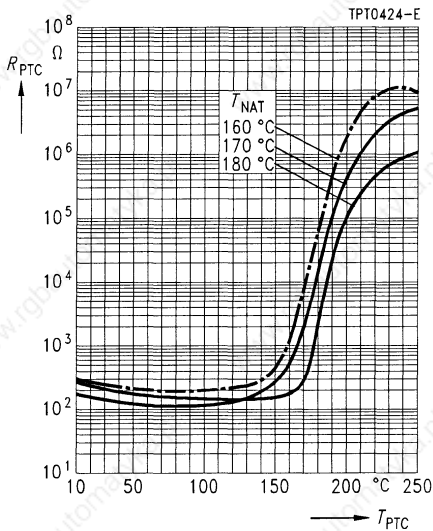

Applications

- Liquid level detection, e. g. for overflow protection in oil tanks

Features

- Hermetically sealed glass case
- Marked with date of manufacture
 Example: 11 B 3
 G = 1996
 3 = March
- Solderability complies with IEC 68-2-20
- TÜV approval

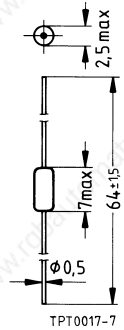

Dimensions (mm)

Type		Ordering code	
E 11		Q63100-P430-E11	
Max. operating voltage	V_{max}	24	V
Rated resistance	$R_N \pm \Delta R$	140 ± 60	Ω
Pressure test	p	4	bar
Operating temperature range ($V = 0$ V)	T_{op}	- 55/+ 100	°C
	T_{op}	- 25/+ 50	°C
Number of cycles ($R_V = 100$ Ω)	N	≥ 5000	
Residual current in oil ($V = 12$ V, $T_A = 50$ °C)	$I_{r,oil}$	≥ 45	mA
Residual current in air ($V = 14$ V, $T_A = - 25$ °C)	$I_{r,air}$	≤ 33,5	mA
Minimum resistance ($V = 24$ V)	R_{min}	70	Ω
Switching time	t_S	2	s
Settling time	t_E	40	s
Surface temperature ($V = 24$ V)	T_{surf}	< 200	°C

Test set-up

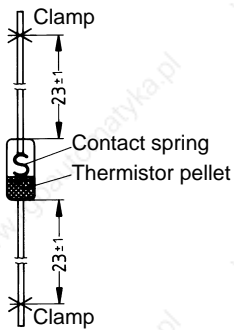

TPT0024-P

- Unclipped leads, held at the ends by clamps
- Sensor in vertical position
- Distance of clamping point to body: min. 22 mm
- Pellet points downwards
- Settling time after application of voltage: min. 40 s

Limits of operating range

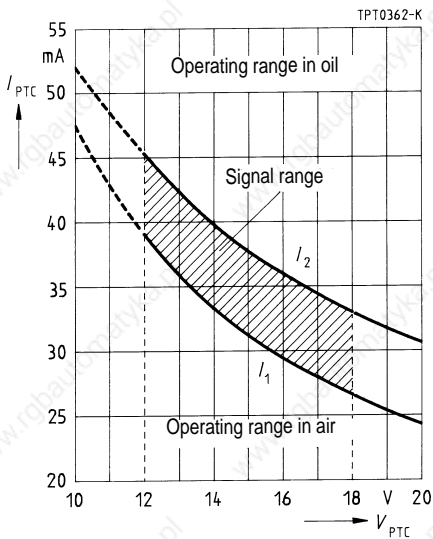

Applications

- Liquid level detection

Features

- Hermetically sealed glass case
- Marked with type designation and manufacturer's logo
- Solderability complies with IEC 68-2-20
- ESD packing

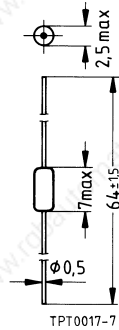

Dimensions (mm)

Type		Ordering code	
E 1020		B59020-E1160-A41	
Max. operating voltage	V_{max}	24	V
Rated resistance	$R_N \pm \Delta R$	135 ± 35	Ω
Operating temperature range ($V = 0$ V)	T_{op}	- 55/+ 100	°C
	T_{op}	- 25/+ 60	°C
Number of cycles	N	≥ 5000	
Residual current in oil	$I_{r,oil}$	≥ 41,7	mA
Residual current in air	$I_{r,air}$	≤ 26,7	mA
Minimum resistance	R_{min}	70	Ω
Switching time	t_S	2	s
Settling time	t_E	40	s
Surface temperature	T_{surf}	< 200	°C

Test set-up

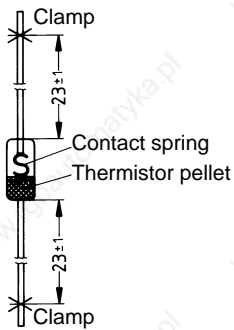

- Unclipped leads, held at the ends by clamps
- Sensor in vertical position
- Distance of clamping point to body: min. 22 mm
- Pellet points downwards
- Settling time after application of voltage: min. 40 s

Applications

- Liquid level detection in tanks (oil, gas, etc.) and household appliances

Features

- Hermetically sealed stainless steel case (withstands liquid pressure of up to 10 bar)
- Solderability complies with IEC 68-2-20
- Rust- and acid-resistant in accordance with DIN 17440

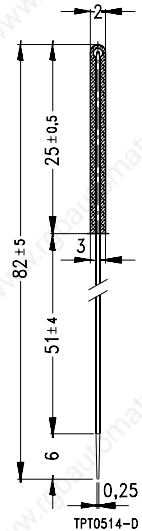

Dimensions (mm)

Type		Ordering code	
D 1010		B59010-D1135-B40	
Max. operating voltage	V_{max}	24	V
Rated resistance	R_{25}	100 – 200	Ω
Pressure test	p	25	bar
Operating temperature range ($V = 0$ V)	T_{op}	- 55/+ 100	$^{\circ}C$
	T_{op}	- 25/+ 50	$^{\circ}C$
Number of cycles	N	5000	
Residual current in oil	$I_{r,oil}$	≥ 45	mA
Residual current in air	$I_{r,air}$	$\leq 33,5$	mA
Minimum resistance	R_{min}	70	Ω
Switching time	t_S	2	s
Settling time	t_E	40	s
Surface temperature	T_{surf}	< 200	$^{\circ}C$

Test set-up

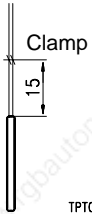

- Unclipped leads, held at the ends by clamps
- Sensor in vertical position
- Distance of clamping point to body: min. 15 mm
- Pellet points downwards
- Settling time after application of voltage: min. 40 s

Limits of operating range

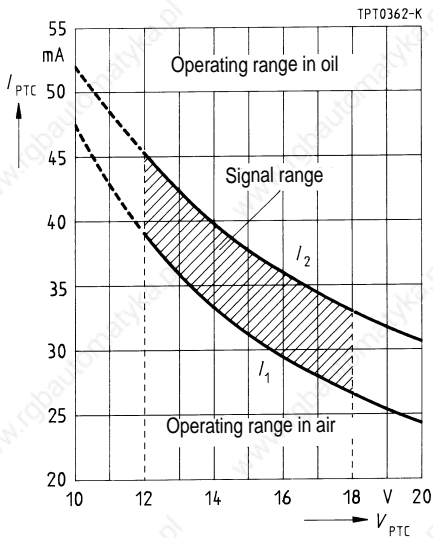

30 V

Applications

- Sensor for small measuring points
- Limit temperature monitoring

Features

- Coated thermistor disk
- Tinned leads
- Marked with coded nominal threshold temperature
- Characteristics for nominal threshold temperatures of 90 to 160 °C conform with DIN 44 081
- Extremely fast response due to small dimensions

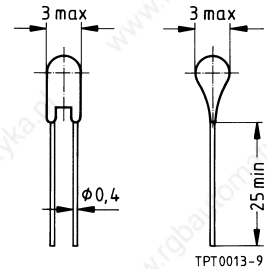

Dimensions (mm)

Max. operating voltage	$(T_A = 0 \dots 40 \text{ }^\circ\text{C})$	V_{\max}	30	V
Max. measuring voltage	$(T_A - 25 \text{ K} \dots T_{\text{NAT}} + 15 \text{ K})$	$V_{\text{Meas,max}}$	7,5	V
Rated resistance	$(V_{\text{PTC}} \leq 2,5 \text{ V})$	R_N	≤ 250	Ω
Response time		t_a	< 3	s
Operating temperature range ($V = 0$)		T_{op}	$- 25/+ 125$	$^\circ\text{C}$
	$(V = V_{\max})$	T_{op}	0/40	$^\circ\text{C}$

Type/ Stamp code	$T_{\text{NAT}} \pm \Delta T$ $^\circ\text{C}$	R^1 $(T_{\text{NAT}} - \Delta T)$ Ω	R^1 $(T_{\text{NAT}} + \Delta T)$ Ω	R^2 $(T_{\text{NAT}} + 15 \text{ K})$ Ω	R^1 $(T_{\text{NAT}} + 23 \text{ K})$ Ω	Ordering code
C 8 f	60 ± 5	≤ 570	≥ 570	—	$\geq 4 \text{ k}$	B59008-C60-A40
C 8 g	70 ± 5	≤ 570	≥ 570	—	$\geq 4 \text{ k}$	B59008-C70-A40
C 8 h	80 ± 5	≤ 570	≥ 570	—	$\geq 4 \text{ k}$	B59008-C80-A40
C 8 i	90 ± 5	≤ 550	≥ 1330	$\geq 4 \text{ k}$	—	B59008-C90-A40
C 8 j	100 ± 5	≤ 550	≥ 1330	$\geq 4 \text{ k}$	—	B59008-C100-A40
C 8 k	110 ± 5	≤ 550	≥ 1330	$\geq 4 \text{ k}$	—	B59008-C110-A40
C 8 l	120 ± 5	≤ 550	≥ 1330	$\geq 4 \text{ k}$	—	B59008-C120-A40
C 8 m	130 ± 5	≤ 550	≥ 1330	$\geq 4 \text{ k}$	—	B59008-C130-A40
C 8 n	140 ± 5	≤ 550	≥ 1330	$\geq 4 \text{ k}$	—	B59008-C140-A40
C 8 o	145 ± 5	≤ 550	≥ 1330	$\geq 4 \text{ k}$	—	B59008-C145-A40
C 8 p	150 ± 5	≤ 550	≥ 1330	$\geq 4 \text{ k}$	—	B59008-C150-A40
C 8 r	155 ± 5	≤ 550	≥ 1330	$\geq 4 \text{ k}$	—	B59008-C155-A40
C 8 s	160 ± 5	≤ 550	≥ 1330	$\geq 4 \text{ k}$	—	B59008-C160-A40
C 8 t	170 ± 7	≤ 570	≥ 570	—	$\geq 4 \text{ k}$	B59008-C170-A40
C 8 u	180 ± 7	≤ 570	≥ 570	—	$\geq 4 \text{ k}$	B59008-C180-A40

1) $V_{\text{PTC}} \leq 2,5 \text{ V}$
2) $V_{\text{PTC}} \leq 7,5 \text{ V}$

Characteristics (typical)

PTC resistance R_{PTC} versus PTC temperature T_{PTC}
(measured at low signal voltage)

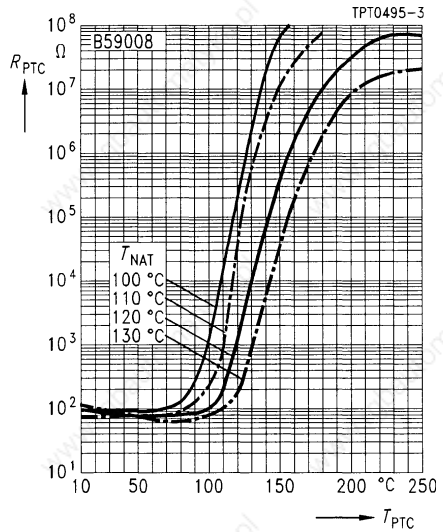
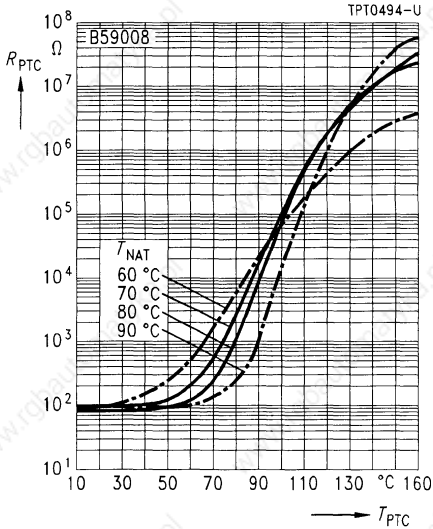

PTC resistance R_{PTC} versus PTC temperature T_{PTC}
(measured at low signal voltage)

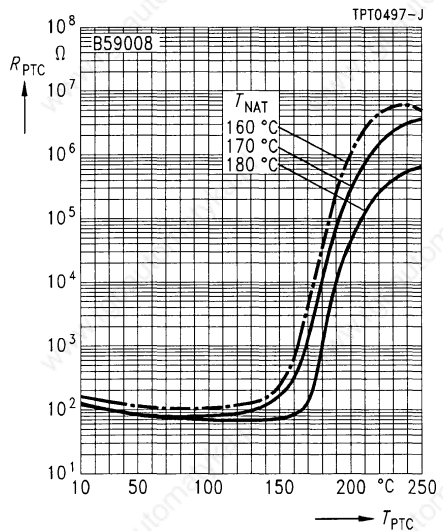
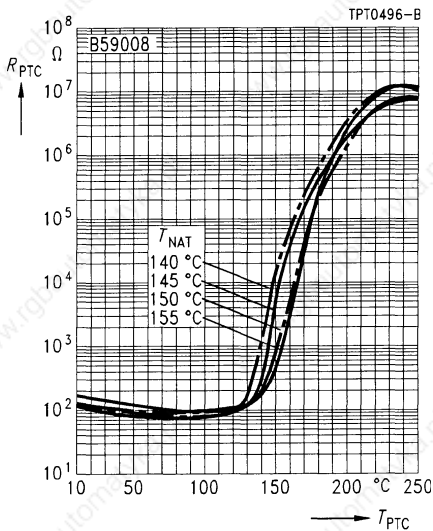

30 V

Applications

- Sensor for small measuring points
- Limit temperature monitoring

Features

- Coated thermistor disk
- Tinned leads
- Manufacturer's logo and type designation stamped on in white
- Characteristics for nominal threshold temperatures of 90 to 160 °C conform with DIN 44 081
- Also available on tape

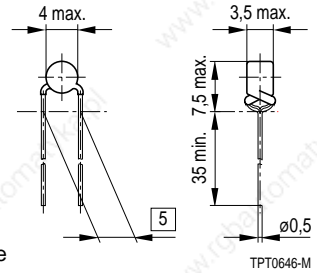

Dimensions (mm)

Max. operating voltage	$(T_A = 0 \dots 40 \text{ }^\circ\text{C})$	V_{\max}	30	V
Max. measuring voltage	$(T_A - 25 \text{ K} \dots T_{\text{NAT}} + 15 \text{ K})$	$V_{\text{Meas,max}}$	7,5	V
Rated resistance	$(V_{\text{PTC}} \leq 2,5 \text{ V})$	R_N	$\leq 100^3)$	Ω
Response time		t_a	< 5	s
Operating temperature range ($V = 0$)		T_{Op}	- 25/+ 125	$^\circ\text{C}$
	$(V = V_{\max})$	T_{Op}	0/40	$^\circ\text{C}$

Type	$T_{\text{NAT}} \pm \Delta T$ $^\circ\text{C}$	$R^1)$ $(T_{\text{NAT}} - \Delta T)$ Ω	$R^1)$ $(T_{\text{NAT}} + \Delta T)$ Ω	$R^2)$ $(T_{\text{NAT}} + 15 \text{ K})$ Ω	$R^1)$ $(T_{\text{NAT}} + 23 \text{ K})$ Ω	Ordering code
C 100	-20 ± 5	≤ 2300	≥ 2300	—	$\geq 10 \text{ k}$	B59100-C920-A70
C 100	10 ± 5	≤ 2300	≥ 2300	—	$\geq 10 \text{ k}$	B59100-C10-A70
C 100	50 ± 5	≤ 400	≥ 400	—	$\geq 4 \text{ k}$	B59100-C50-A70
C 100	60 ± 5	≤ 570	≥ 570	—	$\geq 10 \text{ k}$	B59100-C60-A70
C 100	70 ± 5	≤ 570	≥ 570	—	$\geq 10 \text{ k}$	B59100-C70-A70
C 100	80 ± 5	≤ 570	≥ 570	—	$\geq 10 \text{ k}$	B59100-C80-A70
C 100	90 ± 5	≤ 550	≥ 1330	$\geq 4 \text{ k}$	—	B59100-C90-A70

1) $V_{\text{PTC}} \leq 2,5 \text{ V}$

2) $V_{\text{PTC}} \leq 7,5 \text{ V}$

3) Exception: B59100-C920-A70: $R_N > 100 \text{ k}\Omega$
 B59100-C10-A70: $R_N > 5 \text{ k}\Omega$
 B59100-C50-A70: $R_N < 150 \text{ }\Omega$

Type	$T_{\text{NAT}} \pm \Delta T$ °C	$R^1)$ ($T_{\text{NAT}} - \Delta T$) Ω	$R^1)$ ($T_{\text{NAT}} + \Delta T$) Ω	$R^2)$ ($T_{\text{NAT}} + 15 \text{ K}$) Ω	$R^1)$ ($T_{\text{NAT}} + 23 \text{ K}$) Ω	Ordering code
C 100	100 ± 5	≤ 550	≥ 1330	$\geq 4 \text{ k}$	—	B59100-C100-A70
C 100	110 ± 5	≤ 550	≥ 1330	$\geq 4 \text{ k}$	—	B59100-C110-A70
C 100	120 ± 5	≤ 550	≥ 1330	$\geq 4 \text{ k}$	—	B59100-C120-A70
C 100	130 ± 5	≤ 550	≥ 1330	$\geq 4 \text{ k}$	—	B59100-C130-A70
C 100	140 ± 5	≤ 550	≥ 1330	$\geq 4 \text{ k}$	—	B59100-C140-A70
C 100	145 ± 5	≤ 550	≥ 1330	$\geq 4 \text{ k}$	—	B59100-C145-A70
C 100	150 ± 5	≤ 550	≥ 1330	$\geq 4 \text{ k}$	—	B59100-C150-A70
C 100	155 ± 5	≤ 550	≥ 1330	$\geq 4 \text{ k}$	—	B59100-C155-A70
C 100	160 ± 5	≤ 550	≥ 1330	$\geq 4 \text{ k}$	—	B59100-C160-A70
C 100	170 ± 6	≤ 550	≥ 1330	$\geq 4 \text{ k}$	—	B59100-C170-A70
C 100	180 ± 6	≤ 550	≥ 1330	$\geq 4 \text{ k}$	—	B59100-C180-A70

1) $V_{\text{PTC}} \leq 2,5 \text{ V}$
2) $V_{\text{PTC}} \leq 7,5 \text{ V}$

Characteristics (typical)

PTC resistance R_{PTC} versus PTC temperature T_{PTC}
(measured at low signal voltage)

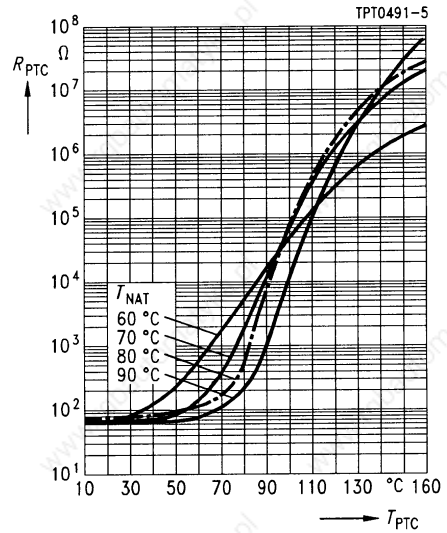
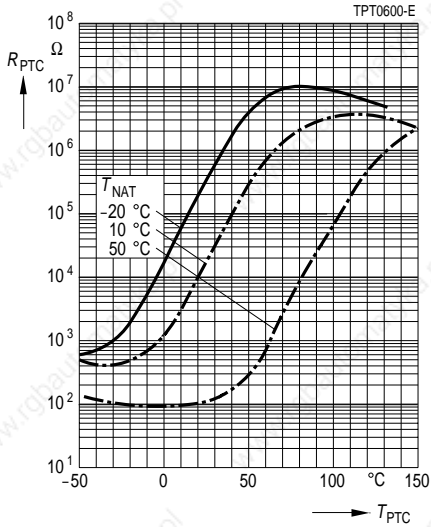

PTC resistance R_{PTC} versus PTC temperature T_{PTC}
(measured at low signal voltage)

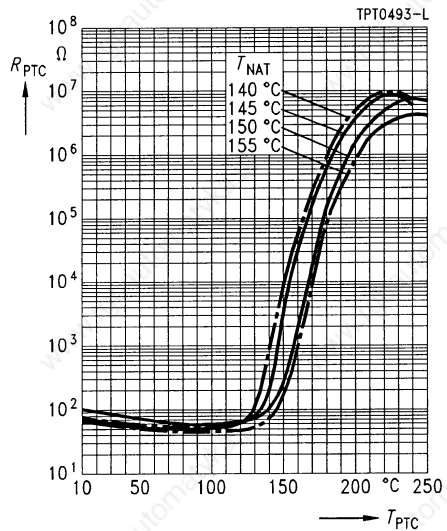
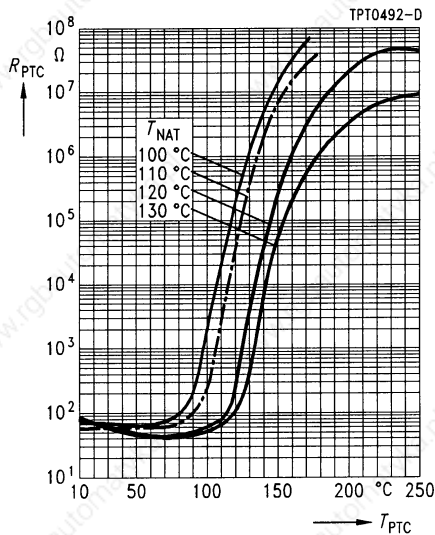

Characteristics (typical)

PTC resistance R_{PTC} versus PTC temperature T_{PTC}
(measured at low signal voltage)

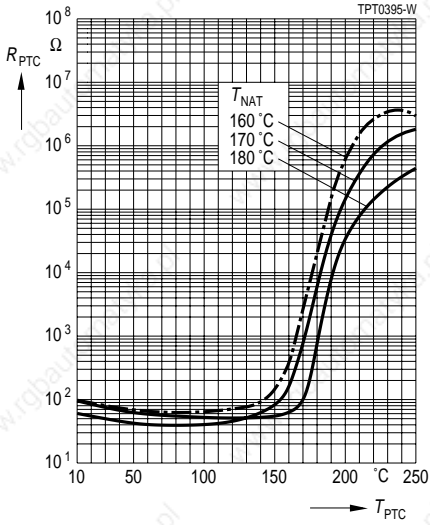

Not for new design

20 V

Applications

- Limit temperature sensor in screw-type case

Features

- Insulated screw-type metal case, thread M4
- Tinned leads
- Color-coded sealing with black dot
- Case permits good thermal coupling

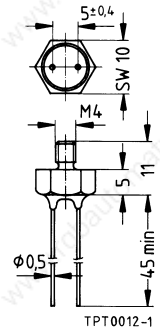

Dimensions (mm)

Max. operating voltage	V_{max}	20	V
Tolerance of rated resistance	ΔR_N	+ 50/– 25 %	
Insulation test voltage	V_{is}	3	kV ac
Response time	t_a	< 50	s
Operating temperature range ($V = 0$)	T_{op}	– 25/+ 125	°C
($V = V_{max}$)	T_{op}	0/60	°C

Type	$T_{Ref} \pm \Delta T$ °C	R_N Ω	R_{Ref} Ω	$R(T_{Ref} - \Delta T)$ Ω	$R(T_{Ref} + \Delta T)$ Ω	R_{min} Ω
D 401	40 ± 5	130	230	≤ 350	≥ 170	115
D 401	60 ± 5	80	160	≤ 240	≥ 120	80
D 401	80 ± 5	80	152	≤ 230	≥ 110	76
D 401	90 ± 5	80	152	≤ 230	≥ 110	76
D 401	120 ± 5	80	148	≤ 225	≥ 105	74

Characteristics (typical)

PTC resistance R_{PTC} versus PTC temperature T_{PTC}
(measured at low signal voltage)

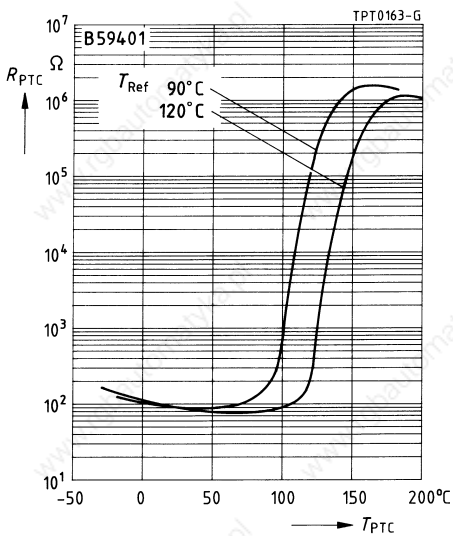
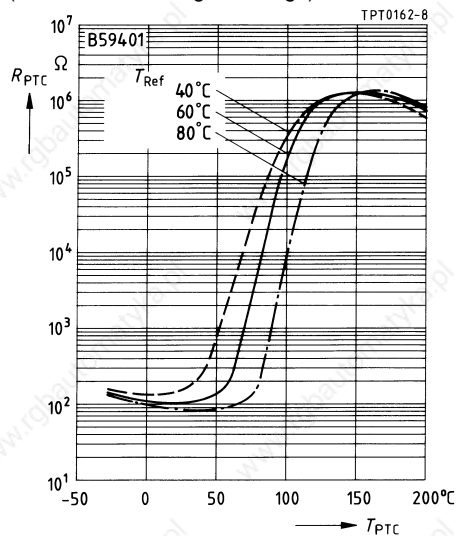

Type	I_{max} mA	T_{Rmin} °C	T_{PTC} °C	$R(T_{PTC})$ Ω	Color of sealing	Ordering code
D 401	175	- 10	95	≥ 100 k	blue	B59401-D40-A40
D 401	270	20	110	≥ 100 k	violet	B59401-D60-A40
D 401	270	40	125	≥ 100 k	orange	B59401-D80-A40
D 401	270	50	130	≥ 100 k	clear	B59401-D90-A40
D 401	270	80	155	≥ 100 k	green	B59401-D120-A40

30 V

Applications

- Limit temperature sensor

Features

- Insulated screw-type metal case
- Thread M3
- Tinned leads
- Marked with nominal threshold temperature and type designation
- Characteristics for nominal threshold temperatures of 90 to 160 °C conform with DIN 44 081
- Fast response due to small dimensions

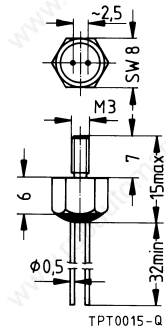

Dimensions (mm)

Max. operating voltage	($T_A = 0 \dots 40 \text{ }^\circ\text{C}$)	V_{\max}	30	V
Max. measuring voltage	($T_A - 25 \text{ K} \dots T_{\text{NAT}} + 15 \text{ K}$)	$V_{\text{Meas,max}}$	7,5	V
Rated resistance	($V_{\text{PTC}} \leq 2,5 \text{ V}$)	R_N	≤ 100	Ω
Insulation test voltage		V_{is}	1,5	kV ac
Response time	($T_{\text{NAT}} - 20 \text{ K} \dots T_{\text{NAT}} + 15 \text{ K}$)	t_a	< 20	s
Operating temperature range	($V = 0$)	T_{op}	- 25/+ 125	$^\circ\text{C}$
	($V = V_{\max}$)	T_{op}	0/40	$^\circ\text{C}$

Type	$T_{\text{NAT}} \pm \Delta T$ $^\circ\text{C}$	R^1 ($T_{\text{NAT}} - \Delta T$) Ω	R^1 ($T_{\text{NAT}} + \Delta T$) Ω	R^2 ($T_{\text{NAT}} + 15 \text{ K}$) Ω	R^1 ($T_{\text{NAT}} + 23 \text{ K}$) Ω	Ordering code
D 801	60 ± 5	≤ 570	≥ 570	—	$\geq 10 \text{ k}$	B59801-D60-A70
D 801	70 ± 5	≤ 570	≥ 570	—	$\geq 10 \text{ k}$	B59801-D70-A70
D 801	80 ± 5	≤ 570	≥ 570	—	$\geq 10 \text{ k}$	B59801-D80-A70
D 801	90 ± 5	≤ 550	≥ 1330	$\geq 4 \text{ k}$	—	B59801-D90-A70
D 801	100 ± 5	≤ 550	≥ 1330	$\geq 4 \text{ k}$	—	B59801-D100-A70
D 801	110 ± 5	≤ 550	≥ 1330	$\geq 4 \text{ k}$	—	B59801-D110-A70
D 801	120 ± 5	≤ 550	≥ 1330	$\geq 4 \text{ k}$	—	B59801-D120-A70
D 801	130 ± 5	≤ 550	≥ 1330	$\geq 4 \text{ k}$	—	B59801-D130-A70
D 801	140 ± 5	≤ 550	≥ 1330	$\geq 4 \text{ k}$	—	B59801-D140-A70
D 801	145 ± 5	≤ 550	≥ 1330	$\geq 4 \text{ k}$	—	B59801-D145-A70
D 801	150 ± 5	≤ 550	≥ 1330	$\geq 4 \text{ k}$	—	B59801-D150-A70
D 801	155 ± 5	≤ 550	≥ 1330	$\geq 4 \text{ k}$	—	B59801-D155-A70
D 801	160 ± 5	≤ 550	≥ 1330	$\geq 4 \text{ k}$	—	B59801-D160-A70

1) $V_{\text{PTC}} \leq 2,5 \text{ V}$
2) $V_{\text{PTC}} \leq 7,5 \text{ V}$

Characteristics (typical)

PTC resistance R_{PTC} versus PTC temperature T_{PTC}
(measured at low signal voltage)

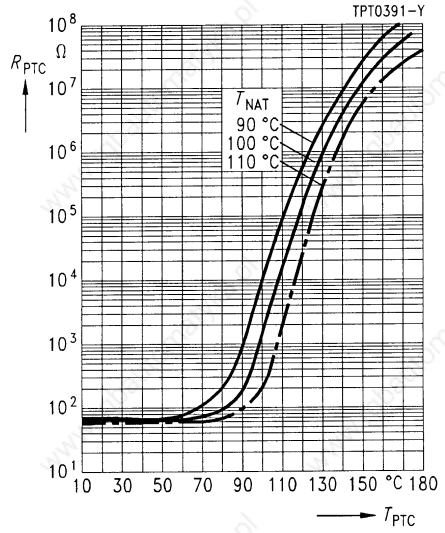
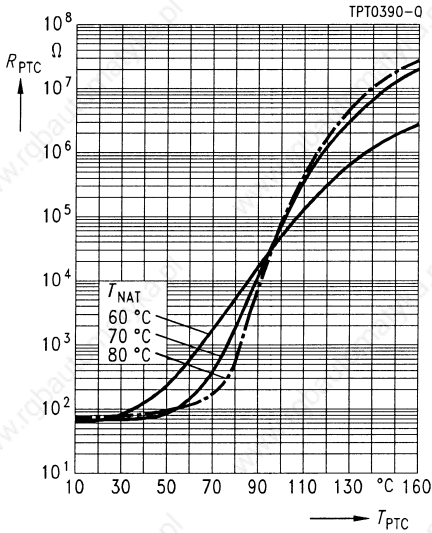

PTC resistance R_{PTC} versus PTC temperature T_{PTC}
(measured at low signal voltage)

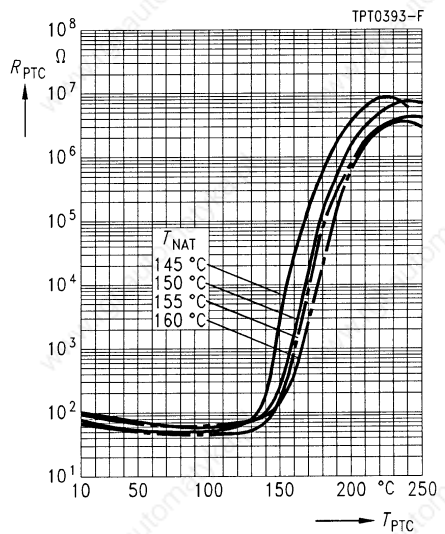
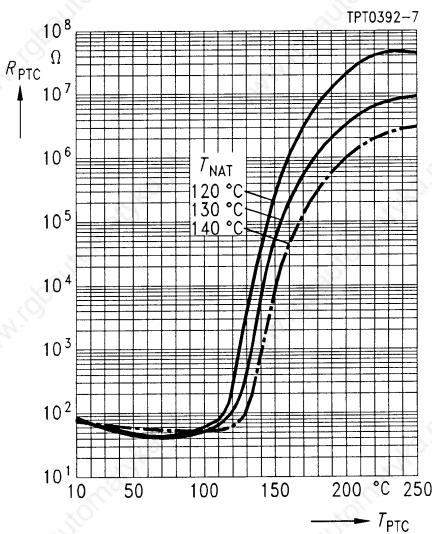

30 V

Applications

- Limit temperature sensor

Features

- Sensor with epoxy resin coating
- Tinned leads
- Metal tag for easy mounting
- Characteristics for nominal threshold temperatures of 90 to 160 °C conform with DIN 44 081
- Metal tag permits good thermal coupling and thus short response times

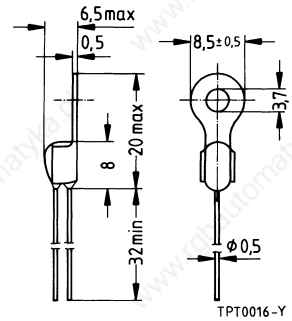

Dimensions (mm)

Max. operating voltage	$(T_A = 0 \dots 40 \text{ } ^\circ\text{C})$	V_{\max}	30	V
Max. measuring voltage	$(T_A - 25 \text{ K} \dots T_{\text{NAT}} + 15 \text{ K})$	$V_{\text{Meas,max}}$	7,5	V
Rated resistance	$(V_{\text{PTC}} \leq 2,5 \text{ V})$	R_N	≤ 100	Ω
Response time		t_a	< 20	s
Operating temperature range ($V = 0$)		T_{op}	$- 25/+ 125$	$^\circ\text{C}$
	$(V = V_{\max})$	T_{op}	0/40	$^\circ\text{C}$

Type/ Stamp code	T_{NAT} $\pm \Delta T$ $^\circ\text{C}$	R^1 $(T_{\text{NAT}} - \Delta T)$ Ω	R^1 $(T_{\text{NAT}} + \Delta T)$ Ω	R^2 $(T_{\text{NAT}} + 15 \text{ K})$ Ω	R^1 $(T_{\text{NAT}} + 23 \text{ K})$ Ω	Ordering code
D 901 331	60 ± 5	≤ 570	≥ 570	—	$\geq 10 \text{ k}$	B59901-D60-A40
D 901 341	70 ± 5	≤ 570	≥ 570	—	$\geq 10 \text{ k}$	B59901-D70-A40
D 901 351	80 ± 5	≤ 570	≥ 570	—	$\geq 10 \text{ k}$	B59901-D80-A40
D 901 361	90 ± 5	≤ 550	≥ 1330	$\geq 4 \text{ k}$	—	B59901-D90-A40
D 901 371	100 ± 5	≤ 550	≥ 1330	$\geq 4 \text{ k}$	—	B59901-D100-A40
D 901 381	110 ± 5	≤ 550	≥ 1330	$\geq 4 \text{ k}$	—	B59901-D110-A40
D 901 391	120 ± 5	≤ 550	≥ 1330	$\geq 4 \text{ k}$	—	B59901-D120-A40
D 901 401	130 ± 5	≤ 550	≥ 1330	$\geq 4 \text{ k}$	—	B59901-D130-A40
D 901 411	140 ± 5	≤ 550	≥ 1330	$\geq 4 \text{ k}$	—	B59901-D140-A40

1) $V_{\text{PTC}} \leq 2,5 \text{ V}$
2) $V_{\text{PTC}} \leq 7,5 \text{ V}$

Characteristics (typical)

PTC resistance R_{PTC} versus PTC temperature T_{PTC}
(measured at low signal voltage)

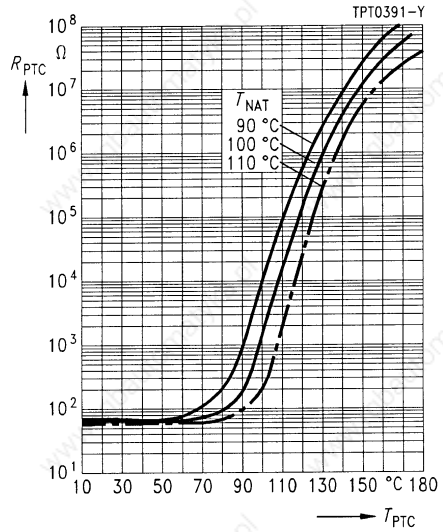
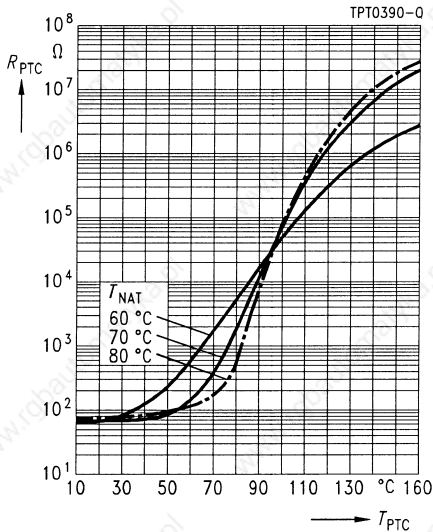

PTC resistance R_{PTC} versus PTC temperature T_{PTC}
(measured at low signal voltage)

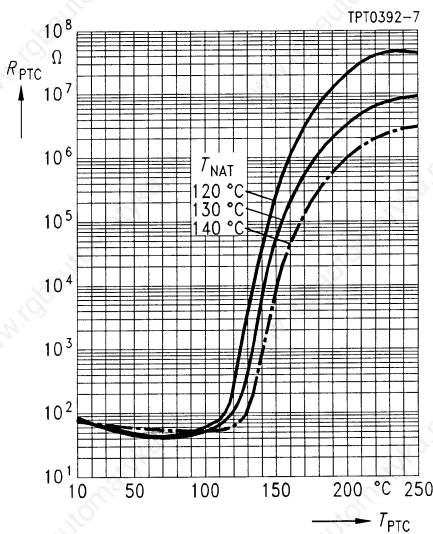

25 V

Applications

- Limit temperature sensor

Features

- Thermistor chip with tinned terminations
- Very small size
- Fast and reliable response
- Suitable for reflow soldering
- Suitable for automatic placement
- Available on 8-mm blister tape (standard delivery mode)

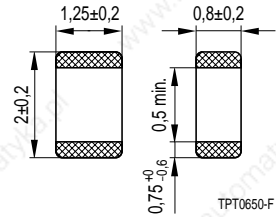

Termination

Dimensions (mm)

Max. operating voltage	$(T_A = 0 \dots 40 \text{ }^\circ\text{C})$	V_{\max}	25	V
Max. measuring voltage	$(T_A - 40 \text{ K} \dots T_{\text{NAT}} + 15 \text{ K})$	$V_{\text{Meas,max}}$	7,5	V
Rated resistance	$(V_{\text{PTC}} \leq 2,5 \text{ V})$	R_N	≤ 1	k Ω
Operating temperature range ($V = V_{\text{Meas,max}}$)		T_{op}	$- 25/T_{\text{NAT}} + 15$	$^\circ\text{C}$

Type	$T_{\text{NAT}} \pm \Delta T$ $^\circ\text{C}$	$R^1)$ $(T_{\text{NAT}} - \Delta T)$ k Ω	$R^1)$ $(T_{\text{NAT}} + \Delta T)$ k Ω	$R^2)$ $(T_{\text{NAT}} + 15 \text{ K})$ k Ω	Ordering code
A 701	70 ± 5	$\leq 5,7$	$\geq 5,7$	$\geq 40^3)$	B59701-A70-A62
A 701	90 ± 5	$\leq 5,5$	$\geq 13,3$	≥ 40	B59701-A90-A62
A 701	100 ± 5	$\leq 5,5$	$\geq 13,3$	≥ 40	B59701-A100-A62
A 701	110 ± 5	$\leq 5,5$	$\geq 13,3$	≥ 40	B59701-A110-A62
A 701	120 ± 5	$\leq 5,5$	$\geq 13,3$	≥ 40	B59701-A120-A62
A 701	130 ± 5	$\leq 5,5$	$\geq 13,3$	≥ 40	B59701-A130-A62

1) $V_{\text{PTC}} \leq 2,5 \text{ V}$
 2) $V_{\text{PTC}} \leq 7,5 \text{ V}$
 3) $T_{\text{NAT}} + 25 \text{ K}$

Characteristics (typical)

PTC resistance R_{PTC} versus PTC temperature T_{PTC}
(measured at low signal voltage)

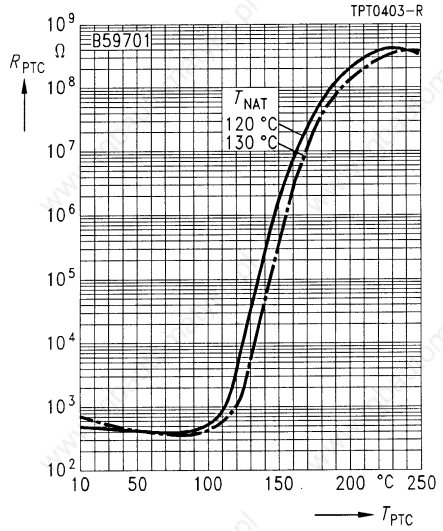
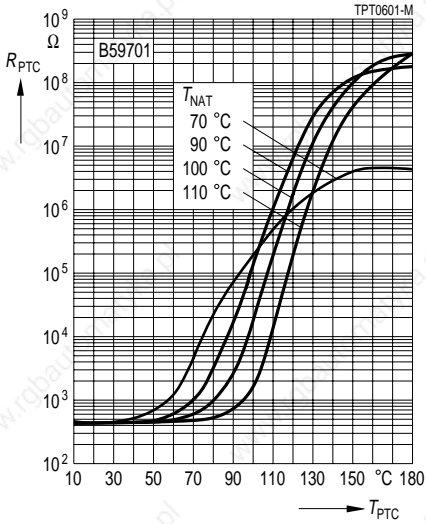

12 V

Applications

- Heating element for small heating systems, e. g. in automobiles

Features

- Thermistor disk with silver metallization on front surfaces
- Suitable for clamp-contacting and glue-bonding
- Curvature < 0,2 mm

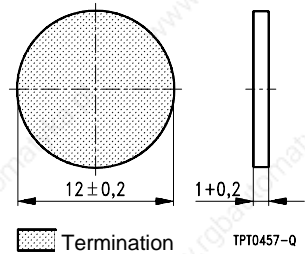

Dimensions (mm)

Options

Other dimensions and electrical parameters available upon request

Max. operating voltage	V_{max}	30	V
Rated voltage	V_N	12	V
Breakdown voltage	V_D	> 36	V
Operating temperature range ($V = 0$)	T_{op}	- 40/+ 200	°C
($V = V_N$)	T_{op}	- 25/+ 60	°C
Resistance tolerance	ΔR	± 30 % ¹⁾	

Type	T_{Ref} °C	R_{min} ($V = V_N$) Ω	T_{surf} ³⁾ ($V = V_N$) °C	R_N ($V_{Meas} \leq 1,5 V$) Ω	Ordering code
A 60	0	20 ²⁾	40	≥ 320	B59060-A-A10
A 60	40	4 ²⁾	70	9	B59060-A40-A10
A 60	60	5	80	9	B59060-A60-A10
A 60	80	4	95	9	B59060-A80-A10
A 60	120	4	130	9	B59060-A120-A10
A 60	160	3	165	9	B59060-A160-A10
A 60	180	3	185	9	B59060-A180-A10
A 60 ⁴⁾	220	2	210	9	B59060-A220-A10
A 60	280	3	265	18	B59060-A280-A10

1) Tolerance not valid for B59060-A-A10

2) Valid for $T_A < 25$ °C

3) Measured peak-to-peak

4) UL approval

Characteristics (typical)

PTC resistance R_{PTC} versus PTC temperature T_{PTC}
(measured at low signal voltage)

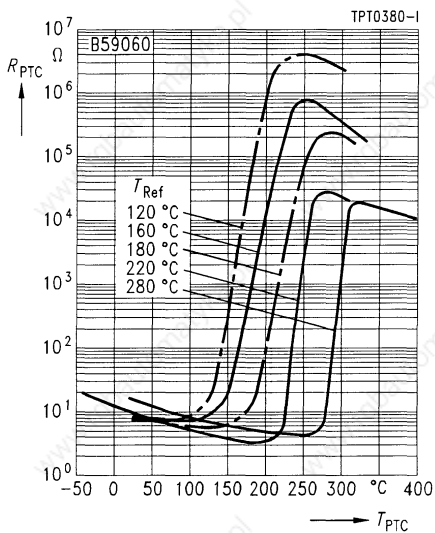
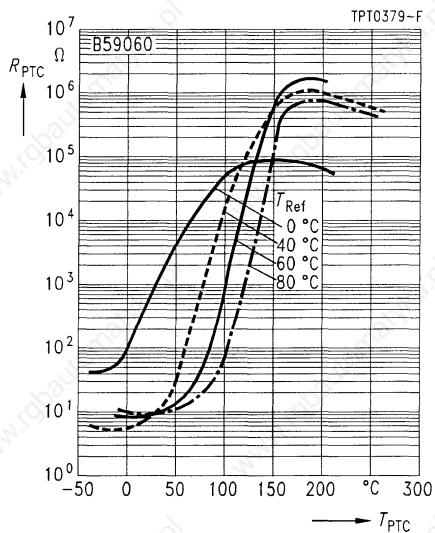

12 V

Applications

- General-purpose heating element, e. g. for automotive applications

Features

- Thermistor rectangle with aluminum metallization
- No migration effects
- For clamp-contacting
- Max. curvature 0,05 mm

Options

Other dimensions and electrical parameters available upon request

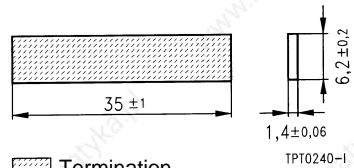

 Termination
Dimensions (mm)

Max. operating voltage	V_{\max}	20	V
Rated voltage	V_N	12	V
Breakdown voltage	V_D	> 40	V
Operating temperature range ($V = 0$)	T_{op}	- 40/+ 200	°C
	T_{op}	- 25/+ 60	°C
Resistance tolerance	ΔR	± 50 %	

Type	T_{Ref} °C	R_{min} ($V = V_N$) Ω	$T_{surf}^{2)}$ ($V = V_N$) °C	R_N ($V_{Meas} \leq 1,5 V$) Ω	Ordering code
R 42-A40	40	1,00 ¹⁾	75	3,2	B59042-R40-A10
R 42-A60	60	1,25	90	3,2	B59042-R60-A10
R 42-A80	80	1,00	110	3,2	B59042-R80-A10
R 42-A120	120	1,00	145	3,2	B59042-R120-A10
R 42-A160	160	0,75	180	3,2	B59042-R160-A10
R 42-A180	180	0,75	200	3,2	B59042-R180-A10
R 42-A220	220	1,00	230	6,4	B59042-R220-A10
R 42-A280	280	1,00	280	12,8	B59042-R280-A10

1) Valid for $T_A < 25$ °C

2) Measured peak-to-peak

Characteristics (typical)

PTC resistance R_{PTC} versus PTC temperature T_{PTC}
(measured at low signal voltage)

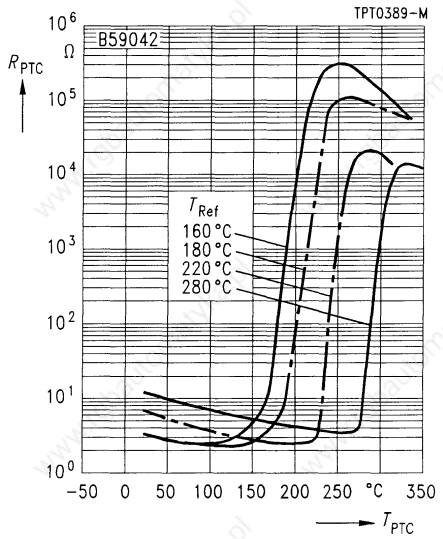
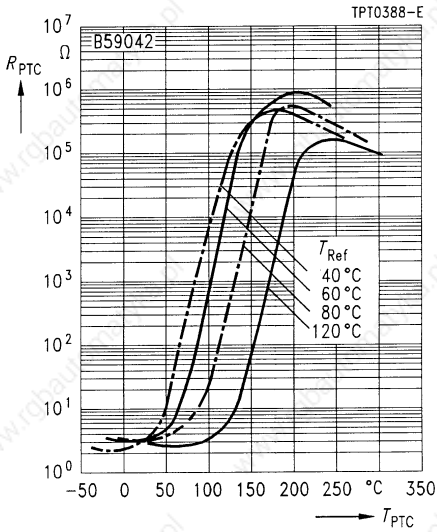

230 V

Applications

- Self-regulating heating element

Features

- Thermistor disk with silver metallization on front surfaces
- High electric strength
- Suitable for clamp-contacting and glue-bonding
- Curvature < 0,2 mm

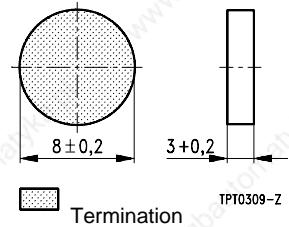

Dimensions (mm)

Options

Other dimensions and electrical parameters available upon request

Max. operating voltage	V_{max}	265	V
Rated voltage	V_N	230	V
Breakdown voltage	V_D	500	V
Operating temperature range ($V = 0$)	T_{op}	- 40/+ 200	°C
	T_{op}	0/60	°C
Resistance tolerance	ΔR	± 35 %	

Type	T_{Ref} °C	R_{min} ($V = V_N$) Ω	$T_{surf}^{2)}$ ($V = V_N$) °C	R_N ($V_{Meas} \leq 1,5 V$) Ω	Ordering code
A 53	50	1750 ¹⁾	90	4200	B59053-A50-A10
A 53	70	1400	105	4200	B59053-A70-A10
A 53	90	1200	120	4200	B59053-A90-A10
A 53	110	960	135	4200	B59053-A110-A10
A 53	130	840	155	4200	B59053-A130-A10
A 53	150	700	170	4200	B59053-A150-A10
A 53	180	530	200	4200	B59053-A180-A10
A 53	220	640	235	6000	B59053-A220-A10
A 53	270	530	275	6000	B59053-A270-A10

1) Valid for $T_A < 25$ °C
2) Measured peak-to-peak

Characteristics (typical)

PTC resistance R_{PTC} versus PTC temperature T_{PTC}
(measured at low signal voltage)

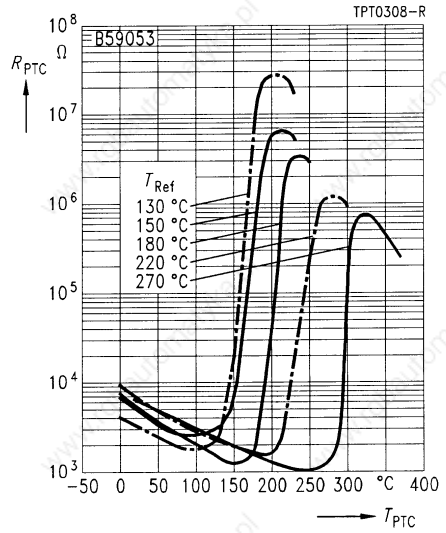
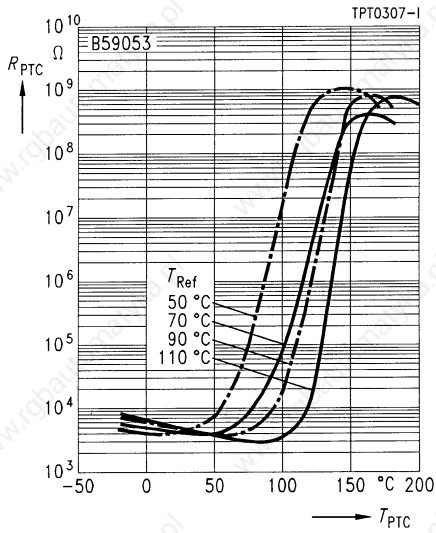

230 V

Applications

- Self-regulating heating element

Features

- Thermistor disk with aluminum metallization on front surfaces
- No migration effects
- Suitable for clamp-contacting
- Curvature < 0,2 mm

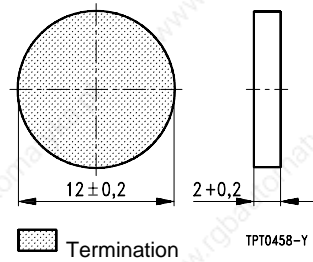

Dimensions (mm)

Options

Other dimensions and electrical parameters available upon request

Max. operating voltage	V_{max}	265	V
Rated voltage	V_N	230	V
Operating temperature range ($V = 0$)	T_{op}	- 40/+ 200	°C
($V = V_N$)	T_{op}	0/60	°C
Resistance tolerance	ΔR	± 35 %	

Type	V_D V	T_{Ref} °C	R_{min} ($V = V_N$) Ω	$T_{surf}^{2)}$ ($V = V_N$) °C	R_N ($V_{Meas} \leq 1,5 V$) Ω	Ordering code
A 66	400	50	500 ¹⁾	100	1200	B59066-A50-A10
A 66	400	70	400	110	1200	B59066-A70-A10
A 66 ³⁾	400	90	345	125	1200	B59066-A90-A10
A 66 ³⁾	400	110	275	140	1200	B59066-A110-A10
A 66	400	130	240	160	1200	B59066-A130-A10
A 66	400	150	200	180	1200	B59066-A150-A10
A 66	400	180	150	200	1200	B59066-A180-A10
A 66	400	220	180	235	1700	B59066-A220-A10
A 66	340	270	150	280	1700	B59066-A270-A10

1) Valid for $T_A < 25$ °C

2) Measured peak-to-peak

3) UL approval

Characteristics (typical)

PTC resistance R_{PTC} versus PTC temperature T_{PTC}
(measured at low signal voltage)

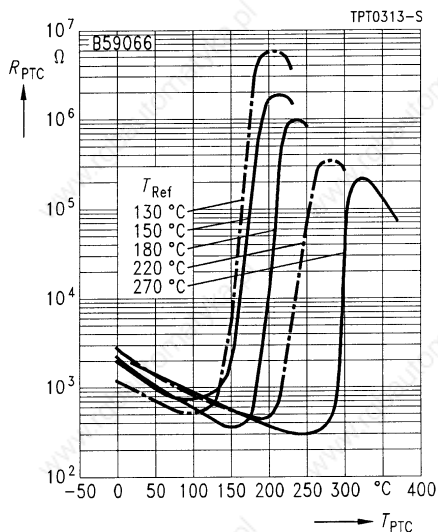
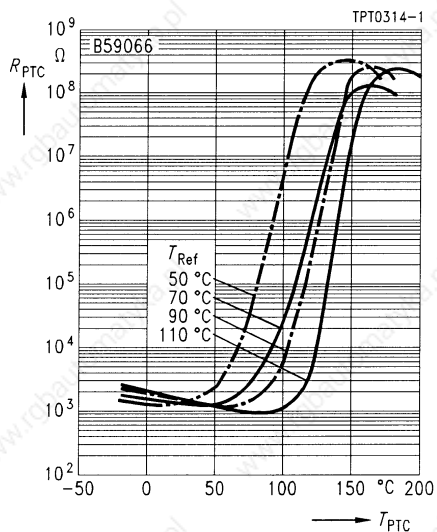

230 V

Applications

- Self-regulating heating element

Features

- Thermistor rectangle with aluminum metallization on front surfaces
- No migration effects
- Suitable for clamp-contacting
- Curvature < 0,05 mm

Options

Other dimensions and electrical parameters available upon request

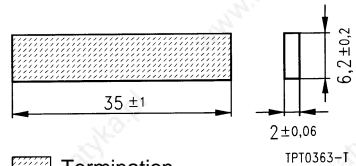

 Termination
Dimensions (mm)

Max. operating voltage	V_{max}	265	V
Rated voltage	V_N	230	V
Operating temperature range ($V = 0$)	T_{op}	- 40/+ 200	°C
	T_{op}	0/60	°C
Resistance tolerance	ΔR	± 50 %	

Type	V_D V	T_{Ref} °C	R_{min} ($V = V_N$) Ω	$T_{surf}^{2)}$ ($V = V_N$) °C	R_N ($V_{Meas} \leq 1,5 V$) Ω	Ordering code
R 102	400	50	225 ¹⁾	100	700	B59102-R50-A10
R 102	400	70	180	115	700	B59102-R70-A10
R 102	400	90	155	130	700	B59102-R90-A10
R 102	400	110	125	145	700	B59102-R110-A10
R 102	400	130	105	160	700	B59102-R130-A10
R 102	400	150	90	180	700	B59102-R150-A10
R 102 ³⁾	400	180	66	205	700	B59102-R180-A10
R 102	400	220	80	240	1000	B59102-R220-A10
R 102	400	240	75	255	1000	B59102-R240-A10
R 102	340	270	85	280	1300	B59102-R270-A10
R 102	320	290	78	295	1300	B59102-R290-A10

1) Valid for $T_A < 25$ °C

2) Measured peak-to-peak

3) UL approval

Characteristics (typical)

PTC resistance R_{PTC} versus PTC temperature T_{PTC}
(measured at low signal voltage)

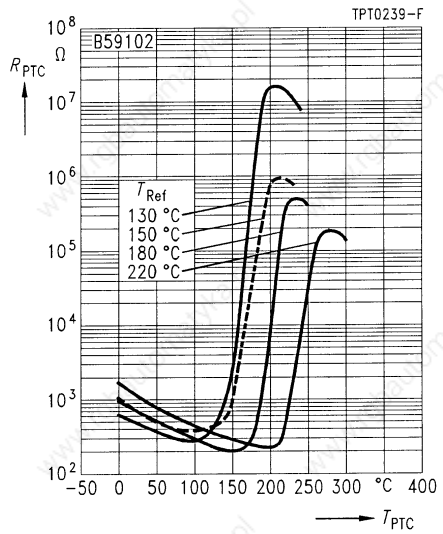
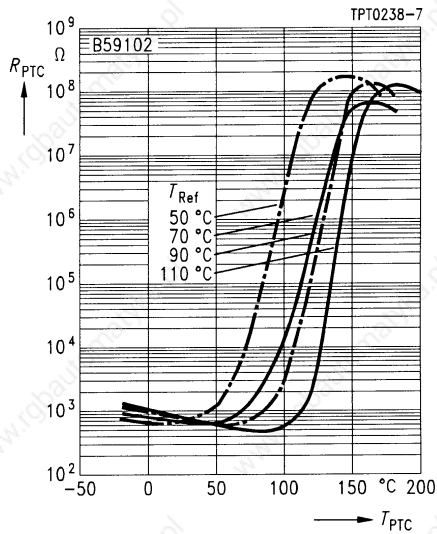

PTC resistance R_{PTC} versus PTC temperature T_{PTC}
(measured at low signal voltage)

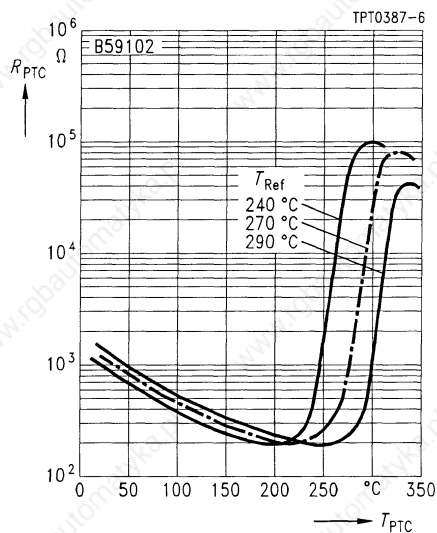



Siemens Matsushita Components

Applications with a future

We set your ideas in motion

When it comes to implementing ideas, you couldn't choose a better partner. Our flexibility turns standard products into new ones with all the right features. Whether capacitors and converter filters for wind-driven power plants, ferrite antennas for radio wrist-watches or SAW filters for the new wide-screen TV generation. If you've got the application, we've got the component.



SCS – dependable, fast and competent



Mounting Instructions

1 Soldering

1.1 Leaded PTC thermistors

Leaded PTC thermistors comply with the solderability requirements specified by CECC.

When soldering, care must be taken that the thermistors are not damaged by excessive heat. The following maximum temperatures, maximum time spans and minimum distances have to be observed:

	<i>Dip soldering</i>	<i>Iron soldering</i>
Bath temperature	max. 260 °C	max. 360 °C
Soldering time	max. 4 s	max. 2 s
Distance from thermistor	min. 6 mm	min. 6 mm

Under more severe soldering conditions the resistance may change.

1.2 Leadless PTC disk thermistors

In case of PTC thermistors without leads, soldering is restricted to devices which are provided with a solderable metallization. The temperature shock caused by the application of hot solder may produce fine cracks in the ceramic, resulting in changes in resistance.

To prevent leaching of the metallization, solder with silver additives or with a low tin content should be used. In addition, soldering methods should be employed which permit short soldering times.

1.3 SMD PTC thermistors

The notes on soldering leadless thermistors also apply to the SMD versions (see IEC 60068-2-58).

1.3.1 Chrome/nickel/tin terminations

(Sizes 0805, 1210)

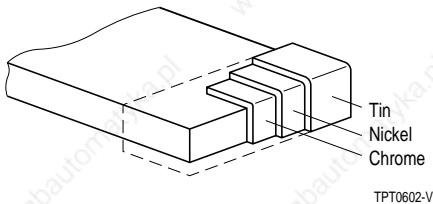

As shown in the diagram above, the terminations consists of three metallic layers. A primary chrome layer provides for good electrical contact. "Leaching" is prevented by a nickel barrier layer. The outer tin coating prevents corrosion of the nickel and ensures good component solderability.

Mounting Instructions

1.3.2 Geometry of solder pads

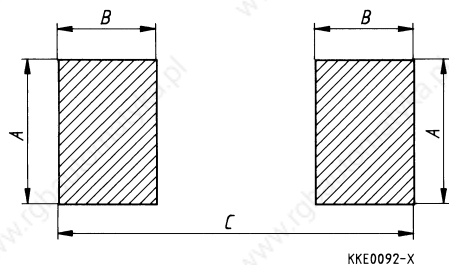

Recommended maximum dimensions (mm)

Size inch/mm	A	B	C
0805/2012	1,3	1,2	3,4
1210/3225	2,8	1,2	4,5

1.3.3 Wave soldering (only for Pxxx types)

a) Soldering temperature profile

Temperature characteristic at component terminal with dual wave soldering

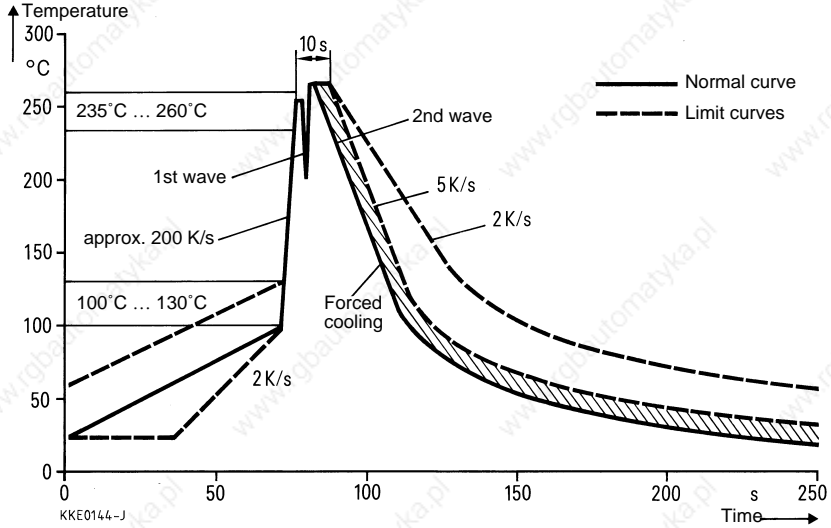

b) Solder joint profiles for chrome/nickel/tin terminations

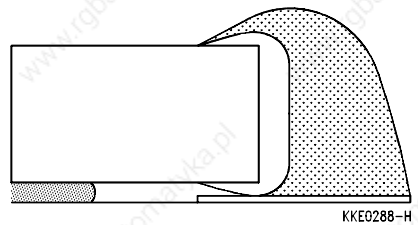
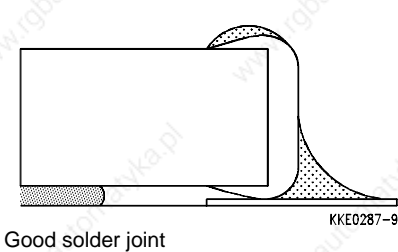

Mounting Instructions

1.3.4 Infrared-reflow soldering

a) Soldering temperature profile

Temperature characteristic at component terminal with infrared soldering

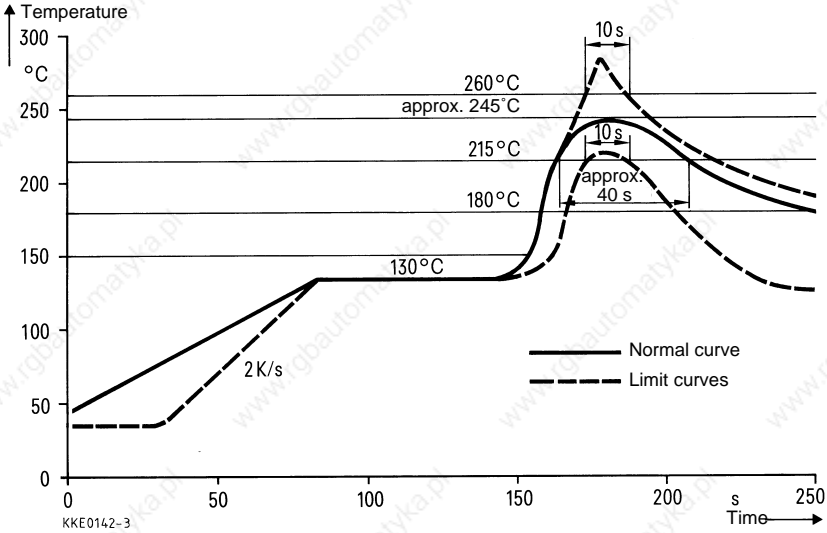

b) Solder joint profiles for chrome/nickel/tin terminations

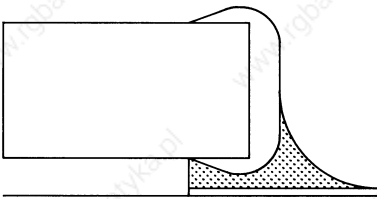

Good solder joint

KKE0070-2

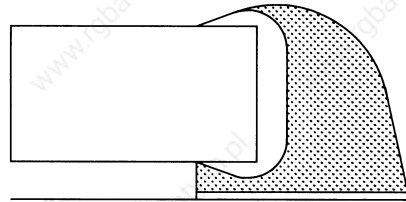

Too much solder
Pad geometry too large

KKE0071-A

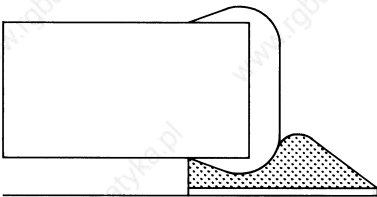

Poor wetting

KKE0072-1

1.3.5 Wettability test in accordance with IEC 60068-2-58

Preconditioning: immersion in F-SW 32 flux.

Evaluation criterion: wetting of pads $\geq 95\%$.

Terminals	Solder	Bath temperature (°C)	Immersion time (s)
CrNiSn	SnPb 60/40	215 \pm 3	3 \pm 0,3

1.3.6 Leaching resistance in accordance with IEC 60068-2-58

Preconditioning: immersion in F-SW 32 flux.

Evaluation criterion: no leaching of contacts.

Terminals	Solder	Bath temperature (°C)	Immersion time (s)
CrNiSn	SnPb 60/40	260 \pm 5	30 \pm 1

Mounting Instructions

1.3.7 Placement and orientation of SMD on PCB

a) Incorrect

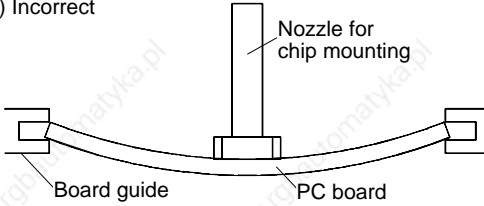

b) Correct

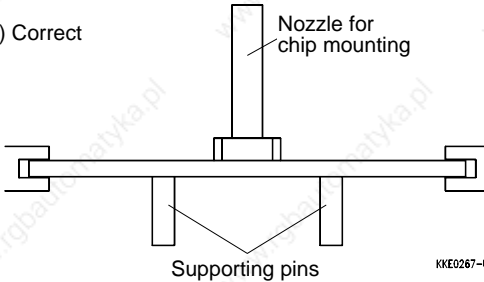

It is recommended that the PC board should be held by means of some adequate supporting pins such as shown in fig. b to prevent the SMDs from being damaged or cracked.

c) Cracks
SMDs located near an easily warped area

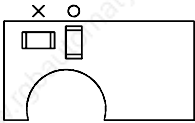

SMD breakage probability due to stress at a breakaway

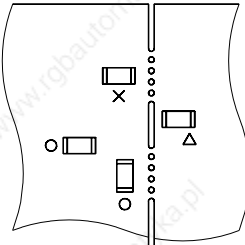

KKE0268-3

When placing a component near an area which is apt to bend or a grid groove on the PC board, it is advisable to have both electrodes subjected to uniform stress, or to position the component's electrodes at right angles to the grid groove or bending line (fig. c).

d) Component orientation

Locate chip horizontal to the direction in which stress acts

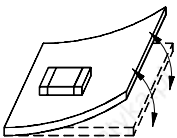

Incorrect orientation

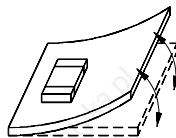

Correct orientation

KKE0269-B

Choose a mounting position that minimizes the stress imposed on the chip during flexing or bending of the board.

1.3.8 Storage of SMD PTC thermistors

Solderability is guaranteed for one year from date of delivery provided that the components are stored in the original packages.

Storage temperature: – 25 ... + 45 °C

Relative humidity: ≤ 75 % annual average, ≤ 95 % on 30 days in a year

The solderability of the external electrodes may be deteriorated if SMDs are stored where they are exposed to high humidity, dust or harmful gas (hydrogen chloride, sulfurous acid gas or hydrogen sulfide).

Do not store SMDs where they are exposed to heat or direct sunlight. Otherwise, the packing material may be deformed or SMDs may stick together, causing problems during mounting.

After opening the factory seals, such as polyvinyl-sealed packages, it is recommended to use the SMDs as soon as possible.

2 Conductive adhesion

An alternative to soldering is the gluing of thermistors with conductive adhesives. The benefit of this method is that it involves no thermal stress. The adhesives used must be chemically inert.

3 Clamp contacting

Pressure contacting by means of clamps is particularly suitable for applications involving frequent switching and high turn-on powers. PTC thermistors for heating and motor starting have metallized surfaces for clamp contacting.

4 Robustness of terminations

The leads meet the requirements of IEC 60068-2-21. They may not be bent closer than 4 mm from the solder joint on the thermistor body or from the point at which they leave the feed-throughs. During bending, any mechanical stress at the outlet of the leads must be removed. The bending radius should be at least 0,75 mm.

Tensile strength: Test Ua1:

Leads $\varnothing \leq 0,5 \text{ mm} = 5 \text{ N}$

$\varnothing > 0,5 \text{ mm} = 10 \text{ N}$

Bending strength: Test Ub:

Two 90°-bends in opposite directions at a weight of 0,25 kg.

Torsional strength: Test Uc: severity 2

The lead is bent by 90° at a distance of 6 to 6,5 mm from the thermistor body.

The bending radius of the leads should be approx. 0,75 mm. Two torsions of 180° each (severity 2).

When subjecting leads to mechanical stress, the following should be observed:

Tensile stress on leads

During mounting and operation tensile forces on the leads are to be avoided.

Mounting Instructions

Bending of leads

Bending of the leads directly on the thermistor body is not permissible.

A lead may be bent at a minimum distance of twice the wire's diameter + 2 mm from the solder joint on the thermistor body. During bending the wire must be mechanically relieved at its outlet. The bending radius should be at least 0,75 mm.

Twisting of leads

The twisting (torsion) by 180° of a lead bent by 90° is permissible at 6 mm from the bottom of the thermistor body.

5 Sealing and potting

When thermistors are sealed or potted, there must be no mechanical stress through differing thermal expansion in the curing process and during later operation. In the curing process the upper category temperature of the thermistor must not be exceeded. It is also necessary to ensure that the potting compound is chemically neutral.

Sealing and potting compounds may reduce the titanate ceramic of PTC thermistors and lead to the formation of low-ohmic conduction bridges. In conjunction with a change in dissipation conditions due to the potting compound, local overheating may finally damage the thermistor.

6 Cleaning

You may use common cleaners based on organic solvents (eg dowanol or alcohol) to clean ceramic and solder joints.

Solvents may cause plastic encapsulations to swell or detach. So be sure to check the suitability of a solvent before using it.

Caution is required with ultrasonic processes. If the sound power is too high, for example, it can degrade the adhesive strength of the terminal metallization or cause the encapsulation to detach.

7 Precautions for PTC thermistor use

1. S + M thermistors are designed for specific applications and should not be used for purposes not identified in our specifications, application notes and data books unless agreed with S + M during the design-in-phase.
2. Ensure suitability of thermistor through reliability testing during the design-in-phase. The thermistors should be evaluated in equipment with worst case conditions.
3. Electrode must not be scratched before/during/after the mounting process.
4. PTCs must not be dropped. Chip-offs must not be caused when handling the PTCs.
5. Components must not be touched with bare hands. Gloves are recommended.
6. Contacts and housing have to be clean before mounting. Especially grease or oil has to be removed.
7. Use thermistors only within the specified temperature operating range.
8. Use thermistors only within the specified voltage and current ranges.
9. Environmental precautions (if not otherwise explicitly stated in application notes):
 - a) Use thermistors only in normal atmospheric conditions (e. g. avoid use in reducing agents, aggressive gases, wet or salty conditions).
 - b) Contact with any liquids and solids should be prevented.
10. Do not encapsulate thermistor with sealing materials.
11. When the thermistor is mounted, there must not be any foreign body between the electrode of the thermistor and the clamping contact.
12. The minimum force of the clamping contacts pressing against the PTC must be 1 kp.
13. During operation, the thermistors surface temperature can be very high. Ensure that adjacent components are placed at a sufficient distance from the thermistor to allow for proper cooling at the thermistor.
14. Storage conditions:
 - a) Store thermistor only in original packaging.
 - b) Do not open the package before storage.
15. Avoid contamination of thermistors surface during storage, handling and processing.
16. Storage conditions in original packaging: storage temperature $-25^{\circ}\text{C} \dots +45^{\circ}\text{C}$, relative humidity $\leq 75\%$ annual mean, maximum 95 %, dew precipitation is inadmissible.



Siemens Matsushita Components

EMI suppression capacitors

Play it safe

Whether video recorder, television, refrigerator or toaster – our EMI suppression capacitors do a grand job in every possible kind of entertainment and consumer electronics appliance. They've also proven their worth in switch-mode power supplies for PCs. No wonder, because the advantages of film technology are there to be seen: low cost, no risk of failure through damp, and optimum self-



healing capability. The result – less destruction of equipment and ensuing fires. Plus the line is safeguarded against surges. In this way our capacitors satisfy the user's need for safety, and the new EMC standards too of course.

SCS – dependable, fast and competent



1 Manufacturing process and quality assurance

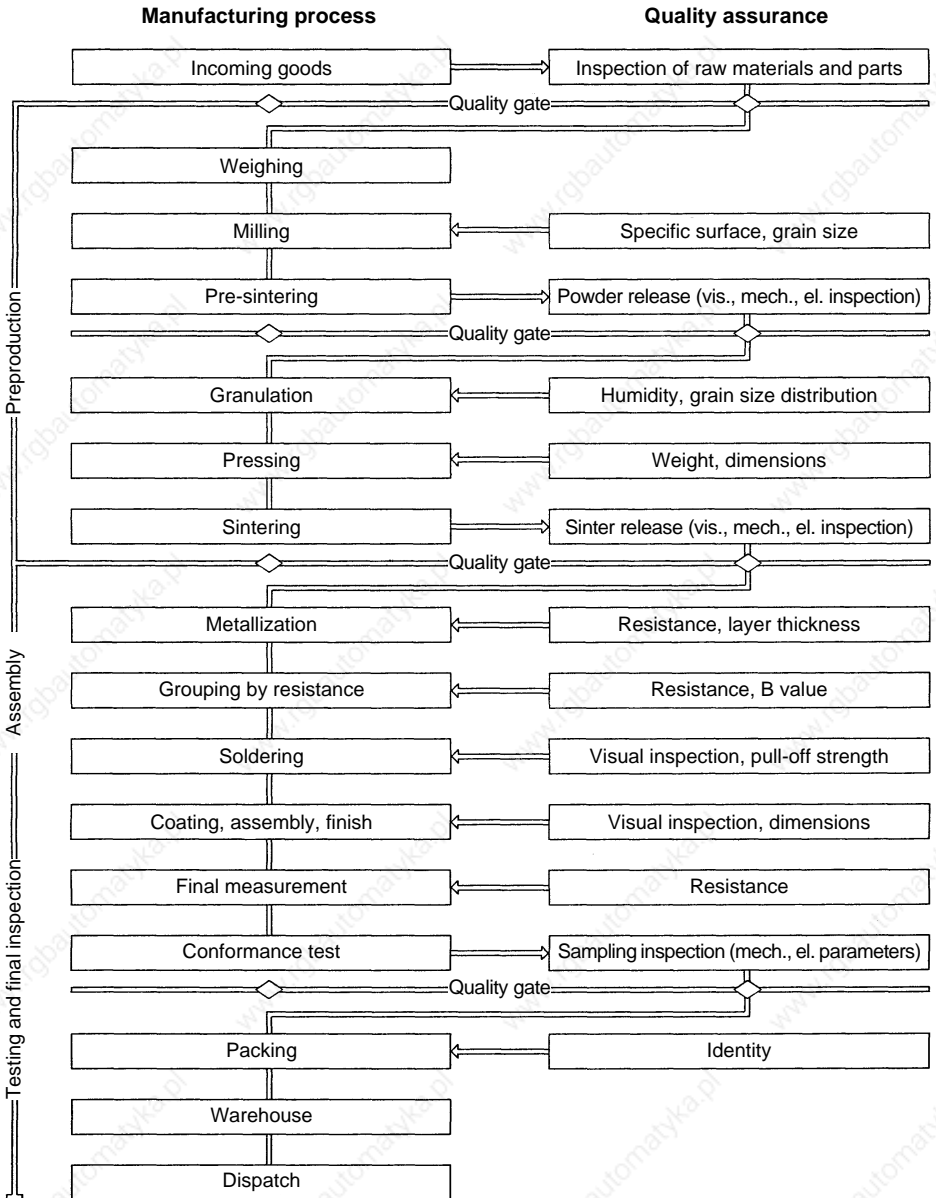

2 Introduction

In order to meet the high technical demands of a free world market, the S + M Ceramic Components Division has established a sophisticated quality assurance system. This is based on the standards QS-9000/VDA 6.1, ISO 9001 and CECC as well as on customer requirements. Certification to QS-9000/VDA 6.1 was obtained in October 1997, certification to ISO 9001 in September 1991.

3 Quality assurance procedure

The PTC thermistors described in this data book were qualified and released for production according to the following criteria: compliance with type specification and capability of production, measuring and test equipment.

The following tests are carried out in order to ensure a consistently high quality:

3.1 Incoming goods inspection

The properties of the parts and materials required for production are defined in close cooperation with qualified suppliers. Quality is ensured by quality assurance measures at the supplier as well as by quality assurance agreements (QSV) and defined inspection procedures for incoming goods.

3.2 Process assurance

To achieve the objective of eliminating defects as efficiently as possible and at their very source, quite different measures are taken. Modern quality tools such as FMEA (Failure Mode and Effect Analysis) are used already during the starting phase: A risk-priority figure is assigned to *potential* defects according to their significance as well as to the probability of occurrence and detection. In case of high risk-priority figures, remedial measures are taken from the beginning. During production all essential processes are subject to statistical process control (SPC).

3.3 Product assurance

Each manufacturing stage is followed by a so-called "quality control gate", i.e. the product is only released for the next stage after passing a corresponding test. The test results are constantly monitored and evaluated and are then used to assess the quality of the manufacturing process itself (refer to 3.2).

3.4 Final inspection

During final inspection, specification-based parameters are checked in conformance tests.

4 Delivery quality

The term delivery quality designates the conformance with agreed data at the time of delivery.

5 Classification of defects

A component is considered defective if it does not comply with the specifications stated in the data sheets or in an agreed delivery specification. Defects which generally exclude the functional use of the component (inoperatives) are classified separately from less significant defects.

Inoperatives of thermistors are:

- Short circuit or open circuit
- Component, case, terminals or encapsulation broken
- Incorrect marking
- Mixing of different types

Other defects are:

- Electrical defects (maximum ratings are exceeded)
- Mechanical defects, e. g. incorrect dimensions, damaged housings, illegible marking, twisted leads

6 Incoming goods inspection by the customer

The quality of our products is ensured by the procedures shown at the beginning of this section ([page 185](#)). If the customer wishes to carry out an incoming goods inspection all the same, we recommend the use of the sampling inspection plan for normal inspection, inspection level II, in accordance with ISO 2859-1. The inspection methods employed should be agreed upon by the customer and the supplier. Often stricter inspection criteria are agreed upon, whereby the size of the sample lot corresponds to the plan, but in which “zero defects” are required. i.e. the lot will only be accepted if it is entirely free of defects. Independent of such agreements, all random sample inspections made by S + M Components are subjected to such stricter criteria (zero defects).

The following details are required for judging any possible claims: test circuit, sample size, number of defectives found, sample defectives, lot number.

7 Reliability

We conduct a large variety of endurance trials and environmental tests to assure the reliability of PTC thermistors. These tests derive from the extremes of expected application conditions, with extra tightening of the conditions so that significant results can be obtained within a reasonable amount of time.

The reliability testing programs of S + M are based on the test plans of relevant CECC standards for assessing the quality of electronic components. Environmental tests are conducted according to IEC 60068-2 (Electrical Engineering, Basic Environmental Testing Procedures).





S + M performs reliability tests both in qualifying new component families as well as for periodic re-qualification.

8 Identification and traceability

The packing of all delivered PTC thermistors has a barcode label with details of type, ordering code, quantity, manufacturing date and lot number. This information is required in order to process complaints quickly and efficiently.

Due to our systematic, unambiguous identification system, each component *and* inspection report can be allocated to a specific production lot. If we know the lot number, we can retrace the component back through the entire production process, right back to purchasing.

Example:

S+M	PTC THERMISTOR	8X2,5
	C 870-A 120-A 70	
[1P] PROD ID: B59870-C 120-A 70		
		
[1T] LOT NO: 12345678	[10D] D/C: 99082	
		
[30P] PRODUCT NO: 94645875	[Q] QTY: 0000500	
		
MADE IN AUSTRIA		
		
		TPT0651-N

9 Corrective and preventive measures

Quality issues are handled by interdisciplinary Q teams using the 8D (8 disciplines) method. This method is also applied for handling customer complaints. The focus is on eliminating quality problems from the very start. If a problem has occurred nevertheless, the target is quick response and effective elimination.

10 Supplementary information

PTC thermistors may only be used in line with the corresponding specifications, mounting instructions and state of the art. If there is any issue you are not sure about, do not hesitate to consult our specialists, who will be pleased to give you support. Non-observance of limit specifications, operating conditions or processing instructions may lead to circuit malfunction (and further consequences) or at least to increased failure rates.

The specification of quality data – which always refer to a fairly large number of components – does not constitute a guarantee of characteristics or properties in the legal sense. However, agreement on these specifications does not mean that the customer may not claim for replacement of individual defective thermistors within the terms of delivery. S+M Components cannot, however, assume any further liability beyond the replacement of defective components. This applies in particular to any further consequences of component failure.

Furthermore, it must be taken into consideration that failure rate figures refer to the average production status and are therefore to be understood as mean values (statistical expectations) for a large number of delivery lots of identical thermistors. These figures are based on application experience and on data obtained from preceding tests under normal conditions, or – for purposes of accelerated aging – more severe conditions.



Siemens Matsushita Components

Siemens filters from stock

Ready,
steady, go

SCS has 100,000 SIFI filters in stock, ready to go as soon as your order arrives. We offer a big selection through all the many variants, ie



building-block system, different attenuation characteristics and packages, various kinds of leads and current ratings from 1 through 20 A.

SCS – dependable, fast and competent



Environmental Protection Measures

Siemens Matsushita Components GmbH & Co. KG (S + M Components for short) is responsible for protection of the environment in the development, fabrication and use of its products for the intended purpose. S + M Components is very thorough in fulfilling the resulting obligations. Over and above the legal prescriptions, our guiding principle here is the corporation's responsibility towards man and environment.

Responsibility for safety in working with materials that have a potential environmental impact is in the hands of the various managers. This involves, in the first place, instructing and informing the staff concerned. A specially trained environmental protection supervisor watches over adherence to regulations, reports on the introduction of processes within an environmental context and on decisions relating to investment (e.g. he checks that all environmentally associated requirements like filters and sumps have been considered). But advising and informing staff take on the highest priority; this is the only way to ensure that all protective measures are known and observed.

All chemicals employed in development and fabrication are examined for environmental compatibility or harmful effects *before* their use on the basis of DIN safety specifications. Alternatives are devised if risks emerge. The result of this procedure is that today all CFCs as well as all highly toxic materials have been eliminated entirely from the fabrication process.

Dust and vapor generated during fabrication are filtered away for disposal. The emission figures of the filters are constantly examined; considerable efforts are undertaken to ensure that these figures are well below the legally prescribed limits. The same applies to the water used in a plant. This being cleansed in a special waste-water treatment process. Water consumption has been reduced substantially in recent years through the use of cooling water circuits and water recycling.

Waste produced in the fabrication of components is sorted and collected on the spot and recycled by state-of-the-art methods.

The packaging material used for our components can be fully recycled.

All thermistors can be disposed of on a dump for industrial waste that is similar to household refuse without any special precautions.

Of course, we are still by no means satisfied with what we have already achieved, and more steps are due to follow in the interest of further reducing and ultimately eliminating entirely all environmental impact created in the development and fabrication of our components.



Siemens Matsushita Components

Ceramic chip capacitors from stock

Small in size, big in performance

Our selection of capacitors ranges from standard sizes down to a miniature highlight in 0402 style. Measuring only 1 x 0.5 x 0.5 mm, it's an ideal solution for applications where space is tight, like in handies and cardiac pacemakers. At the same time all our chips can boast excellent soldering characteristics, with special terminal variants for conductive adhesion. And we also thought about the right packing for automatic placement. You get all sizes down to 1206 in bulk case for example, plus voltage ratings from 16 to 500 V. By the way, our leaded models have CECC approval of course, in fact they were certified more than ten years ago.

More in the new short form catalog!

SCS - dependable, fast and competent



Climatic Conditions

1 Reliability data

For most measuring PTCs reliability data are given in the data sheets. These data provide information on the deviation of rated resistance under high thermal, electrical or mechanical stress.

2 Operating temperature range

The permissible operating temperature ranges are specified in the data sheets. Here, a difference is made between the permissible temperature ranges for loaded and for unloaded PTC thermistors.

For unloaded PTC thermistors the operating temperatures indicated are identical with the surface temperature of the device. The operating temperature ranges for $V = 0$ correspond to the lower category temperature LCT and the upper category temperature UCT as per CECC 44 000. Under load the power dissipation of a PTC thermistor depends on the heat removal conditions. To prevent electrical overload the temperature has to be kept within the specified range.



Siemens Matsushita Components

Disk varistors from stock

The choice is yours

In our selection of disk varistors there's something for everything. We offer you application support and deliver models rated from 11 to 460 V straight from SCS stock. Our product certification like UL and CECC makes sure your product conforms with CE. All disk varistors are manufactured in Europe, just like our block, strap and SMD varistors.



SCS - dependable, fast and competent



Taping and Packing

Many of the components presented in this data book are suitable for processing on automatic insertion or placement machines. These thermistors can be supplied on tape for easy handling by automatic systems. The individual modes of taping and packing will be described in the following.

1 Taping of SMD thermistors (in accordance with IEC 60286-3)

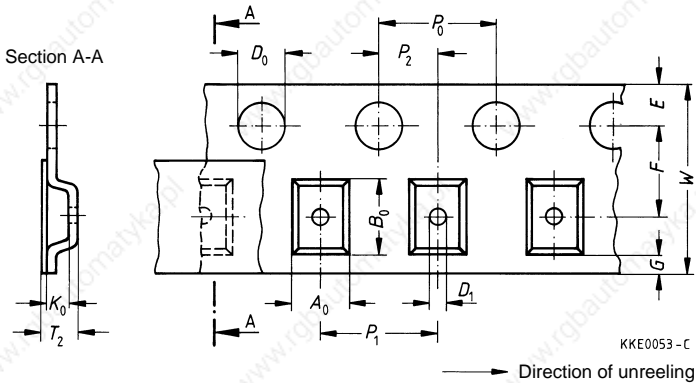

Dimension (mm)	Size (8-mm tape)			Size (12-mm tape)		Size (16-mm tape)		Tolerance
	0805	1206	1210	1812	2220	3225	4032	
$A_0 \times B_0$	The rated dimensions of the component compartment have been derived from the relevant component specification and are chosen such that the components cannot change their orientation within the tape.							
K_0								
T_2								
D_0	1,50			1,50		1,50		+ 0,10 / - 0 min.
D_1	1,00			1,50		1,50		
P_0	4,00			4,00		4,00		$\pm 0,10^1)$
P_2	2,00			2,00		2,00		$\pm 0,05$
P_1	4,00			8,00		12,00		$\pm 0,10$
W	8,00			12,00		16,00		$\pm 0,30$
E	1,75			1,75		1,75		$\pm 0,10$
F	3,50			5,50		7,50 ²⁾		$\pm 0,05$
G	0,75			0,75		0,75		min.

¹⁾ $\leq 0,2$ mm over 10 sprocket holes

²⁾ Tolerance $\pm 0,1$

Taping and Packing

Reel packing

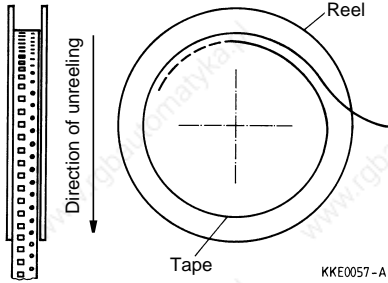
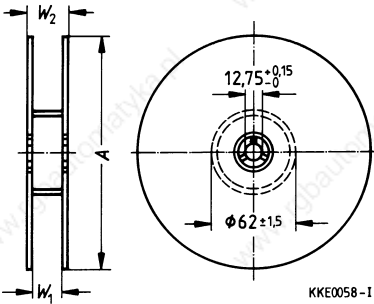

8-mm-tape

(for sizes 0805, 1206, 1210)

Dimension	180-mm reel
A	180 - 2/+ 0
W ₁	8,4 + 1,5/- 0
W ₂	14,4 max.

12-mm-tape

(for sizes 1812, 2220)

Dimension	180-mm-reel
A	180 - 2/+ 0
W ₁	12,4 + 2,0/- 0
W ₂	18,4 max.

16-mm-tape

(for sizes 3225, 4032)

Maß	330-mm-reel
A	330 - 2/+ 0
W ₁	16,4 + 2,0/- 0
W ₂	22,4 max.

2 Taping of radial-lead PTC thermistors

Dimensions and tolerances (taping in accordance with IEC 60286-2 and for LS 7,5 based on IEC 60286-2)

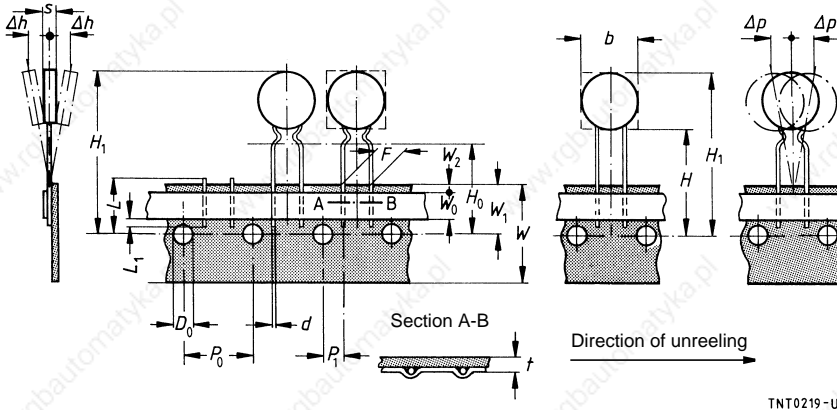

Dimension (mm)	Lead spacing 2,5 mm	Lead spacing 5,0 mm	Tolerance of LS 2,5/5,0	Lead spacing 7,5 mm	Tolerance of LS 7,5	Remarks
b						see dimensional drawings
s	5,0	6,0	max.	7	max.	
d	0,5/0,6	0,5/0,6	$\pm 0,05$	0,8/1,0	$\pm 0,05$	
P_0	12,7	12,7	$\pm 0,3$	12,7	$\pm 0,3$	± 1 mm / 20 sprocket holes
P_1	5,1	3,85	$\pm 0,7$	8,95	$\pm 0,8$	
F	2,5	5,0	$+ 0,6/- 0,1$	7,5	$\pm 0,8$	
Δh	0	0	$\pm 2,0$	0	*)	measured at top of component body
Δp	0	0	$\pm 1,3$	0	$\pm 2,0$	
W	18,0	18,0	$\pm 0,5$	18,0	$\pm 0,5$	
W_0	5,5	5,5	min.	11,0	min.	peel-off force ≥ 5 N
W_1	9,0	9,0	$+ 0,75/- 0,5$	9,0	$+ 0,75/- 0,5$	
W_2	3,0	3,0	max.	3,0	max.	
H	18,0	18,0	$+ 2,0/- 0$	18,0	$+ 2,0/- 0$	
H_0	16,0	16,0	$\pm 0,5$	16,0	$\pm 0,5$	
H_1	32,2	32,2	max.	45,0	max.	
D_0	4,0	4,0	$\pm 0,2$	4,0	$\pm 0,2$	
t	0,9	0,9	max.	0,9	max.	without wires
L	11,0	11,0	max.	11,0	max.	
L_1	4,0	4,0	max.	4,0	max.	

*) Depends on s

Taping and Packing

Modes of packing

AMMO packing

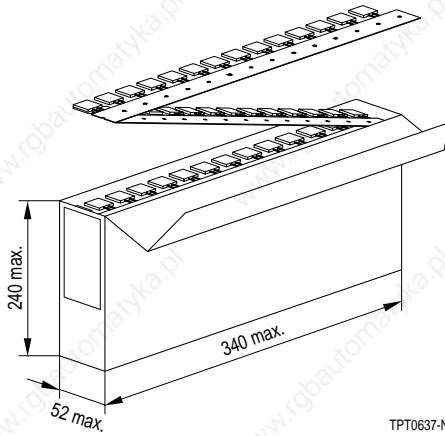

TPT0637-N

Number of pieces: 1000 ... 2000

Reel packing

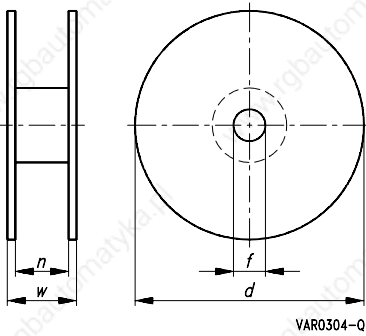

VAR0304-Q

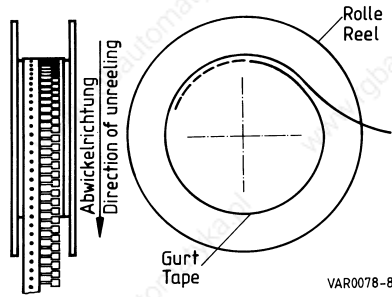

VAR0078-8

Number of pieces: 1000 ... 2000

Reel dimension (in mm)

Reel type	d	f	n	w
I	360 max.	31 ± 1	approx. 45	54 max.

Cassette packing

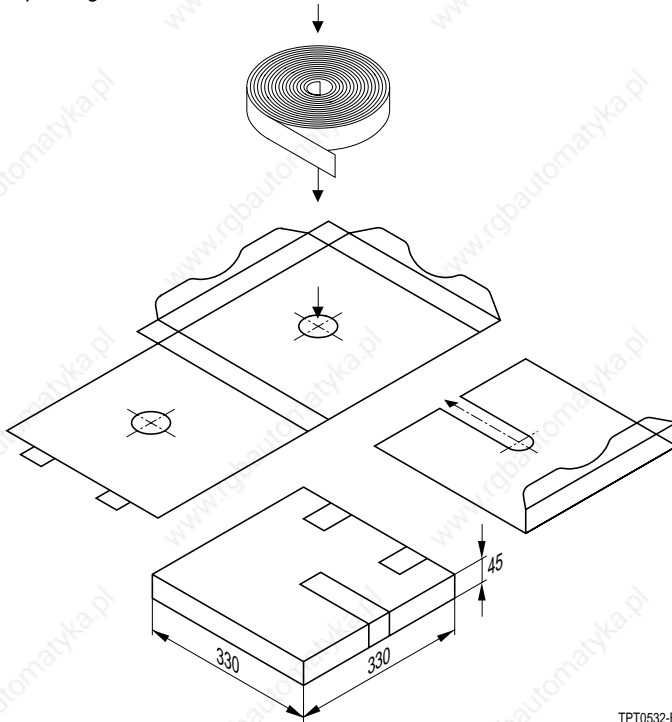

TPT0532-B

Number of pieces: 1000 ... 2000

3 Packing codes

The last two digits of the complete ordering code state the packing mode:

40		Bulk	
50	Radial leads, kinked	Tape	Cassette packing
51	Radial leads, kinked	Tape	Reel packing
52	Radial leads, straight	Tape	Cassette packing
53	Radial leads, straight	Tape	Reel packing
54	Radial leads, kinked	Tape	AMMO packing
55	Radial leads, straight	Tape	AMMO packing
62	SMDs	Tape	Reel packing
70	Radial leads	Bulk	Cardboard strips

Example: B59890-C120-A70 Untaped
 B59890-C120-A51 Taped



Siemens Matsushita Components

SAW resonators for radio remote control

Making a lot of things a lot easier

The key to convenience and security: radio remote controls for keyless entry in automobiles and opening the garage gate. Or in the household, for cordless headphones or metering heating costs for example. Here the evaporation pipe is replaced by a sensor that signals consumption by



a transmitter to a receiver outside the domicile, thus doing away with readings on all the radiators. Transmitter and receiver are both fitted with a SAW resonator.

SCS – dependable, fast and competent



Symbols and Terms

A	Area
C_{th}	Heat capacity
I	Current
$I_{in/coil}$	Inrush current through degaussing coil
I_N	Rated current
I_K	Trip current
I_r	Residual current
I_{rms}	Root-mean-square value of current
I_S	Switching current
N	Number (integer)
P	Power
P_{25}	Maximum power at 25 °C
P_{el}	Electrical power
P_V	Dissipation power
R_{min}	Minimum resistance
R_N	Rated resistance
ΔR_N	Resistance tolerance
R_P	Parallel resistance
R_{PTC}	PTC resistance
R_{Ref}	Reference resistance
R_S	Series resistance
R_T	Resistance at temperature T (e.g. R_{25} = resistance at 25 °C)
R_V	Load resistance
T	Temperature
t	Time
T_A	Ambient temperature
t_a	Thermal threshold time
t_E	Settling time (for level sensors)
T_N	Rated temperature
T_{NAT}	Nominal threshold temperature
T_{op}	Operating temperature
T_{PTC}	PTC temperature
t_R	Response time
T_{Ref}	Reference temperature
T_{Rmin}	Temperature at minimum resistance
t_S	Switching time
T_{surf}	Surface temperature
V or V_{el}	Voltage (with subscript only for distinction from volume)
V	Volume

Symbols and Terms

V_{rms}	Root-mean-square value of voltage
V_D	Breakdown voltage
V_{is}	Insulation test voltage
V_{max}	Maximum operating voltage
V_{Meas}	Measuring voltage
$V_{Meas,max}$	Maximum measuring voltage
V_N	Rated voltage
V_{op}	Operating voltage
V_{PTC}	Voltage drop across a PTC thermistor
V_p	Pulse strength
α	Temperature coefficient
Δ	Tolerance, change
δ_{th}	Dissipation factor
τ_a	Thermal time constant
τ_c	Thermal cooling time constant
λ	Failure rate

Abbreviations / Notes

SMD Surface-mount devices

* To be replaced by a number in ordering codes, type designations etc.

+ To be replaced by a letter

All dimensions are given in mm.

The commas used in numerical values denote decimal points.

Subject Index

A

ambient temperature 28

B

breakdown voltage V_D 24

C

ceramic material 19

clamp contacting 40, 181

cleaning 182

conductive adhesion 181

current/voltage characteristic 23

D

decay time 25

defects 187

degaussing 37

directly heated 29

E

energy-saving lamps 35, 36

F

frequency dependence 27

fuses 29

G

grain boundaries 19

H

heat dissipation 28

heating elements 40

I

identification 188

impedance 27

incoming goods inspection 186

indirectly heated 29

infrared-reflow soldering 178

insulation test voltage V_{is} 25

ISO 9001 186

L

leaching resistance 179

leakage sensing 39

level sensors 38

limit indication 39

M

maximum measuring voltage $V_{Meas,max}$ 24

maximum operating voltage V_{max} 24

media 39

minimum resistance R_{min} 21

motor starting 37

N

nominal threshold temperature T_{NAT} 22

O

operating point 28

operating states 30

overflow control 38

overload protection 29

P

peak voltage 25

placement of SMD on PCB 180

potting 182

PTC thermistor 19

PTC thermistor effect 19

PTC volume 31

pulse strength V_p 25

Q

QS-9000 186

quality assurance 185

R

rated current I_N 24

rated resistance R_N 21

rated voltage V_N 24

reference resistance R_{Ref} 21

reference temperature T_{Ref} 21

residual current I_r 24

resistance R_{PTC} 22

Subject Index

response time t_R	25	thermal threshold time t_a	25
rise time	25	time delay	35
robustness of terminations	181	traceability	188
S		transformer protection	34
sealing	182	trip current I_K	23, 30
self-heating	20, 22	trip temperature	39
settling time t_E	26	V	
soldering	175	varistor effect	26
storage	183	VDA 6.1	186
storage of SMD PTC thermistors	181	voltage dependence	26
surface temperature T_{surf}	23	W	
switching current I_S	24	wave soldering	177
switching time t_S	24, 32	wettability test	179
T		Z	
telephone line card protection	34	zero defects	187
temperature coefficient α	22	zero-power characteristics	20
temperature dependence	20	zero-power resistance R_T	20
temperature sensors	39		
temperature T_{PTC}	22		
thermal cooling time constant τ_c	25		