



E	5.96065.03
---	------------

BAUMÜLLER

**SERVO
POWER UNIT**

BUS 3 / 21 / 20

Technical description and
operation manual

Edition 11. June 1999

BAUMÜLLER

SERVO POWER UNIT

BUS 3 / 21 / 20

Technical description and operation manual

Edition June 1999

5.96065.03

<p>PLEASE READ AND PAY ATTENTION TO SAFETY INSTRUCTIONS AND OPERATING GUIDE PRIOR TO COMMISSIONING</p>

This manual contains the necessary information for normal operation of the products described therein. The drives may only be used, maintained and repaired by personnel familiar with the operation manual and the applicable regulations on working safety and accident prevention. The devices are manufactured to a high technical specification and are operationally safe. Provided that all safety instructions have been adhered to, there will be no personal danger during the installation and commissioning stages.

The commissioning is prohibited until it has been positively determined that the machine, into which these components are to be incorporated, complies with EC machine regulations.

We cannot guarantee that the product documentation is completely error-free unless this is expressly indicated in our General Conditions of Business and Supply.

This technical description replaces and nullifies all previous description. In order to provide the best possible service, we reserve the right to alter information without notice.

Manufacturer and Baumüller Nürnberg GmbH

Supplier's address: Ostendstr. 80 - 90

90482 Nürnberg

Germany

Tel. 00 49 (0)9 11 / 54 32 - 0

Fax - 1 30

Copyright: The technical description and the operation manual may not be copied or duplicated without our permission.

Country of origin: Made in Germany

Date of manufacture: Determined from the serial number on the machine/motor.

TABLE OF CONTENTS

1 Safety Information..... 7

2 Technical Data..... 11

 2.1 General..... 11

 2.1.1 Description of Function 12

 2.2 Electrical Data 14

 2.2.1 BUS 3..... 14

 2.2.2 BUS 21 15

 2.2.3 BUS 20..... 16

 2.3 Type Code 19

3 Transportation, Unpacking..... 21

4 Assembly 23

 4.1 Dimensions 24

 4.1.1 BUS 3..... 24

 4.1.2 BUS 20 und BUS 21 25

 4.1.3 Fastening Holes..... 26

 4.2 Assembly Information 27

5 Installation 29

 5.1 Danger Information 29

 5.2 EMC Information..... 30

 5.3 Connection Diagram 36

 5.3.1 BUS 3 Connection Diagram 36

 5.3.2 BUS 21 Connection Diagram 37

 5.3.3 BUS 20 Connection Diagram 38

 5.3.4 Double-Axis BUS 20 Connection Diagram 39

 5.4 Pin Assignments 41

 5.5 Accessories 43

 5.5.1 Brushless Tachometer Generator Connection..... 43

 5.5.2 Incremental Encoder Connection 45

 5.5.3 Test Adapter 46

Table of Contents

6 Commissioning	49
6.1 BUG/BUS Commissioning Instructions.....	52
6.2 Messages and Warnings.....	56
6.3 Operating Data Store, BEDAS	57
7 Maintenance	59
7.1 Maintenance Information	59
7.2 Disposal.....	60
8 Appendix	61
8.1 Manufacturer Declaration.....	61
8.2 Declaration of Conformity	62
8.3 Conditions of Business and Delivery	63
8.4 Index	64

ABBREVIATIONS

AC	Alternating current
AM	Asynchronous motor
BEDAS	German abbreviation of Operating data store
BUC	Baumotronic Converter Feed/Feed back Unit
BUG	Baumotronic Converter Basic Feed Unit
BUM	Baumotronic Converter Mono Power Unit
BUS	Baumotronic Converter Servo Power Unit
DC	Direct current
DIN	German Standardization Institute (Deutsches Institut für Normung e.V.)
EMC	Electromagnetic compatibility
EN	European standard
HS	Main contactor
IPM	Intelligent Power Module
MSL	Mean sea level
PE	Protective earth
SM	Synchronous motor
ZK	Intermediate circuit

Abbreviations

1 SAFETY INFORMATION

Preliminary Remarks

During operation, the principles on which the power converter and the motor work lead to leakage currents to earth that may be dissipated via the specified protective earths and may result in a current-operated e.l.c.b. on the input side blowing prematurely.

In the case of a short-circuit to frame or to ground, a direct proportion may arise in the leakage current that makes triggering a higher-level current-operated e.l.c.b. either more difficult or totally impossible.

This means that connecting the power converter to the mains using only the current-operated e.l.c.b. is prohibited (preliminary standard EN 50178/VDE 0160/11.94, Sections 5.2.11 and 5.3.2.1).

The units are protected from direct contact by being installed in commercially available switching cabinets that meet the minimum protection requirements of preliminary standard EN 50178/VDE 0160/11.94, Section 5.2.4.

Sheets of plastic covering the equipment connection act as additional guards preventing accidental contact at commissioning and in the case of casual use of control elements located close to the equipment (DIN VDE 0106 Part 100, Accident Prevention Regulation VBG4 "Electrical Systems and Equipment").

At routine testing of this equipment, a high-voltage test is carried out that conforms with preliminary standard EN 50178/VDE 0160/11.94, Section. 9.4.5.

The protective measures and safety regulations according to DIN/VDE are binding for personal security.

Neglecting to fit PE connections on the equipment or the motor will result in serious personal injury and/or considerable damage to property.

The equipment may only be run on grounded supply networks.

Sections carrying current take more than one minute to discharge.

The equipment is conditionally shortcircuit-proof.

General Information

These operating instructions contain all the information necessary for correct operation of the products described. The document is intended for specially trained, technically qualified personnel who are well-versed in all warnings and commissioning activities.

The equipment/system is manufactured using state-of-the-art technology and is safe in operation. It can safely be installed and commissioned and functions without problems if the safety information below is followed.

Safety Information



WARNING

When operating electrical equipment, some parts of the equipment always carry dangerous voltages. Ignoring these safety instructions and warnings may result in serious personal injury and/or damage to property.

Only qualified personnel who are familiar with the safety information, assembly, operation and maintenance instructions may carry out work on this equipment.

Danger Information

On the one hand, the information below is for your own personal safety and on the other to prevent damage to the described products or to other connected equipment.

In the context of the operating instructions and the information on the products themselves, the terms used have the following meanings:

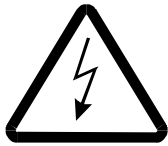

DANGER

This means that death, severe personal injury, or damage to property **will** occur unless appropriate safety measures are taken.



WARNING

This means that death, severe personal injury, or considerable damage to property **may** occur unless appropriate safety measures are taken.

NOTE

This draws your attention to important information about the product, handling of the product or to a particular section of the documentation.

Qualified Personnel

In the context of the safety-specific information in this document or on the products themselves, qualified personnel are considered to be persons who are familiar with setting up, assembling, commissioning and operating the product and who have qualifications appropriate to their activities.

Trained or instructed or authorized to commission, ground and mark circuits and equipment in accordance with recognized safety standards.

Trained or instructed in accordance with recognized safety standards in the care and use of appropriate safety equipment.

Appropriate Use



WARNING

You may only use the equipment/system for the purposes specified in the operating instructions and in conjunction with the third-party equipment and components recommended or authorized by BAUMÜLLER NÜRNBERG GmbH.

For safety reasons, you must not change or add components on/to the equipment/system.

The machine minder must report immediately any changes that occur which adversely affect the safety of the equipment/system.

Appropriate use also includes observing the operating instructions and complying with the conditions of inspection and maintenance.

2 TECHNICAL DATA

2.1 General

The motor and the converter must be matched to one another to be able to fulfil the requirements made of the drive system three-phase current servo motor and the converter. Our BAUMOTRONIC BUS 3, BUS 21 and BUS 20 servo power units, which have been specially developed for servo drives are transistor converters for four-quadrant operation.

The BAUMOTRONIC converter system is of modular structure and comprises the following units:

- the BUG basic feed unit
- the BUS servo power unit

Features:

- BUS 3 for motors with rated currents of up to 15 A
- BUS 21 for motors with rated currents of up to 30 A
- BUS 20 for motors with rated currents of up to 160 A
- Servo power units can be arranged as an array on the basic unit
- Short-circuit- and earth-fault-proof
- Customer- and drive-specific optimization in the exchangeable operating data store, BEDAS
- Easy-to-service

2.1.1 Description of Function

Power Unit

The power unit is a transistorized three-phase bridge and converts the triggering signals coming from the closed-loop controller to voltage pulses or feeding three-phase current (synchronous and asynchronous) motors.

Monitoring

The power unit is automatically protected and has monitoring facilities for the intermediate circuit voltage, the earth fault and motor currents.

Circuit Diagram

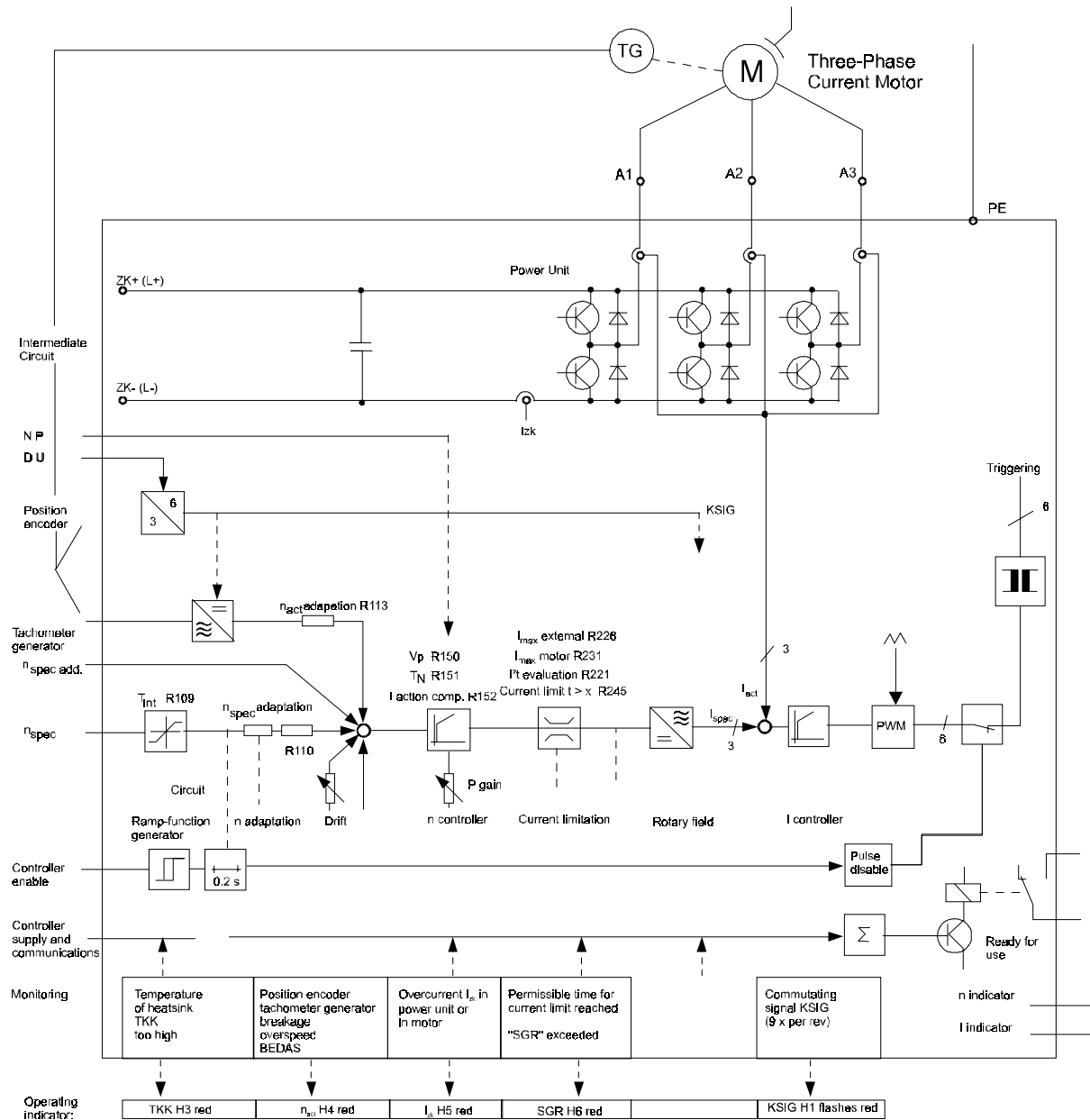

2.2 Electrical Data

2.2.1 BUS 3

Servo Power Unit	BUS 3 - 10/20	BUS 3 - 15/30
Connection Voltage U_{ZK}	310 VDC	
Rated current I_N at * TK = 35° C and TB = 35° C TK = 45° C and TB = 45° C	10 A 10 A	15 A 10 A
Peak current I_S for 200 ms < t < 10 s *	20 A	30 A
Specified speed n_{spec} Adapation * n_{spec} additional Integrator ramp-up/ramp-down time tH^*	0 ... ±10 V 5 V ... 11.5 V 0 ... ±10 V 10 ms ... 250 ms	
Actual speed n_{act} $n_N \leq 3000$ RPM $n_N > 3000$ RPM	3.3 V/1000 RPM ±10% 1.65 V/1000 RPM ±10%	
Max. speed n^*_{max}	Motor-specific	
Current specified value I_{spec} for display	10 V at 20 A	10 V at 30 A
External current limitation SGR_{ext} Analog (if desired) * Switchable to fixed value * Peak current time-limited to *	0 ... +10 V ↔ 0 ... 100% Default value 10% (if desired, other value between 0 and 100%) 0.3/0.5/1/2 s/∞	
Controller enable RF With "braked off" controller disable With "unbraked off" controller disable	Undelayed For 200 ms Undelayed	
Direction reversal DU	+24 V	
Ready for use, Contacts can be loaded with Operational disturbance* Speed monitoring at	24 V/1 A Crossing to the other axes (optionally not crossing) 120% of n_N	
Triggering power PA	12 W	14 W
Power loss PV In rated operation Idling	90 W 25 W	120 W 30 W
Environmental operating temperature T_B Coolant temperature range T_K	0 ... 45° C 0 ... 45° C	0 ... 35° C (45° C) 0 ... 35° C (45° C)
Storage temperature range	-30° C ... +70° C	
Site altitude ¹⁾	1000 m above sea level	
Relative humidity	15% ... 85% no condensation	
Dimensions	80 x 250 x 230 mm	
Weight	3 kg	

* Individual adaptation is possible ex-works by means of the operating data store, BEDAS.

¹⁾ For site altitudes above 1000 m, refer to curve 1 on page 17

The standard settings are printed in bold type

For explanations, refer to page 17 ff.

2.2.2 BUS 21

Servo Power Unit	BUS 21 - 7.5/15	BUS 21 - 15/30	BUS 21 - 22/45	BUS 21 - 30/60
Connection Voltage U_{ZK}	310 VDC			
Rated current I_N at * TK = 35° C and TB = 35° C TK = 45° C and TB = 45° C	7.5 A 5 A	15 A 10 A	22 A 15 A	30 A 20 A
Peak current I_S for 200 ms < t < 10 s *	15 A	30 A	45 A	60 A
Specified speed n_{spec} Adapatation * n_{spec} additional Integrator ramp-up/ramp-down time tH*	0 ... +10 V 5 V ... 11.5 V 0 ... +10 V 10 ms ... 250 ms			
Actual speed n_{act} $n_N \leq 3000$ RPM $n_N > 3000$ RPM	3.3 V/1000 RPM $\pm 10\%$ 1.65 V/1000 RPM $\pm 10\%$			
Max. speed n^*_{max}	Motor-specific			
Current specified value I_{spec} for display	10 V at 15 A	10 V at 30 A	10 V at 45 A	10 V at 60 A
External current limitation SGR_{ext} Analog (if desired) * Switchable to fixed value * Peak current time-limited to *	0 ... +10 V \Leftrightarrow 0 ... 100% Default value 10% (if desired, other value between 0 and 100%) 0.3/0.5/1/2 s/∞			
Controller enable RF With "braked off" controller disable With "unbraked off" controller disable	Undelayed For 200 ms Undelayed			
Direction reversal DU	+24 V			
Ready for use, Contacts can be loaded with Operational disturbance* Speed monitoring at	24 V/1 A Crossing to the other axes (optionally not crossing) 120% of n_N			
Triggering power PA	15 W	16 W	17 W	18 W
Power loss PV In rated operation Idling	80 W 25 W	120 W 30 W	160 W 40 W	230 W 50 W
Environmental operating temperature T_B Coolant temperature range T_K	0 ... 45° C (55° C) 0 ... 35° C (45° C)			
Storage temperature range	-30° C ... +70° C			
Site altitude ¹⁾	1000 m above sea level			
Relative humidity	15% ... 85% no condensation			
Dimensions	52.5 x 400 x 330 mm			
Weight	5 kg			

* Individual adaptation is possible ex-works by means of the operating data store, BEDAS.

¹⁾ For site altitudes above 1000 m, refer to curve 1 on page 17

The standard settings are printed in bold type

For explanations, refer to page 17 ff.

2.2.3 BUS 20

Servo Power Unit	BUS 20 - 40/60	BUS 20 - 60/90	BUS 20 - 80/135	BUS 20 - 160/270
Connection Voltage U_{ZK}	310 VDC			
Rated current I_N at * TK = 35° C and TB = 35° C TK = 45° C and TB = 45° C	40 A 40 A	60 A 60 A	80 A 80 A	160 A 160 A
Peak current I_S for 200 ms < t < 10 s *	60 A	90 A	135 A	270 A
Specified speed n_{spec} Adapatation * n_{spec} additional Integrator ramp-up/ramp-down time tH^*	0 ... ±10 V 5 V ... 11.5 V 0 ... ±10 V 10 ms ... 250 ms			
Actual speed n_{act} $n_N \leq 3000$ RPM $n_N > 3000$ RPM	3.3 V/1000 RPM ±10% 1.65 V/1000 RPM ±10%			
Max. speed n^*_{max}	Motor-specific			
Current specified value I_{spec} for display	10 V at 60A	10 V at 90 A	10 V at 135 A	10 V at 270 A
External current limitation SGR_{ext} Analog (if desired) * Switchable to fixed value * Peak current time-limited to *	0 ... +10 V ⇔ 0 ... 100% Default value 10% (if desired, other value between 0 and 100%) 0.3/0.5/1/2 s/∞			
Controller enable RF With "braked off" controller disable With "unbraked off" controller disable	Undelayed For 200 ms Undelayed			
Direction reversal DU	+24 V			
Ready for use, Contacts can be loaded with Operational disturbance* Speed monitoring at	24 V/1 A Crossing to the other axes (optionally not crossing) 120% of n_N			
Triggering power PA	19 W	27 W	31 W	61 W
Power loss PV In rated operation Idling	250 W 50 W	350 W 70 W	460 W 100 W	920 W 200 W
Environmental operating temperature T_B Coolant temperature range T_K	0 ... 45° C (55° C) 0 ... 35° C (45° C)			
Storage temperature range	-30° C ... +70° C			
Site altitude ¹⁾	1000 m above sea level			
Relative humidity	15% ... 85% no condensation			
Dimensions	105 x 400 x 330 mm			210 x 400 x 330 mm
Weight	8 kg	9 kg		18 kg

* Individual adaptation is possible ex-works by means of the operating data store, BEDAS.

¹⁾ For site altitudes above 1000 m, refer to curve 1 on page 17

The standard settings are printed in bold type

For explanations, refer to page 17.

Explanations of the Technical Data

Characteristic curve 1: Load in dependence on the site elevation

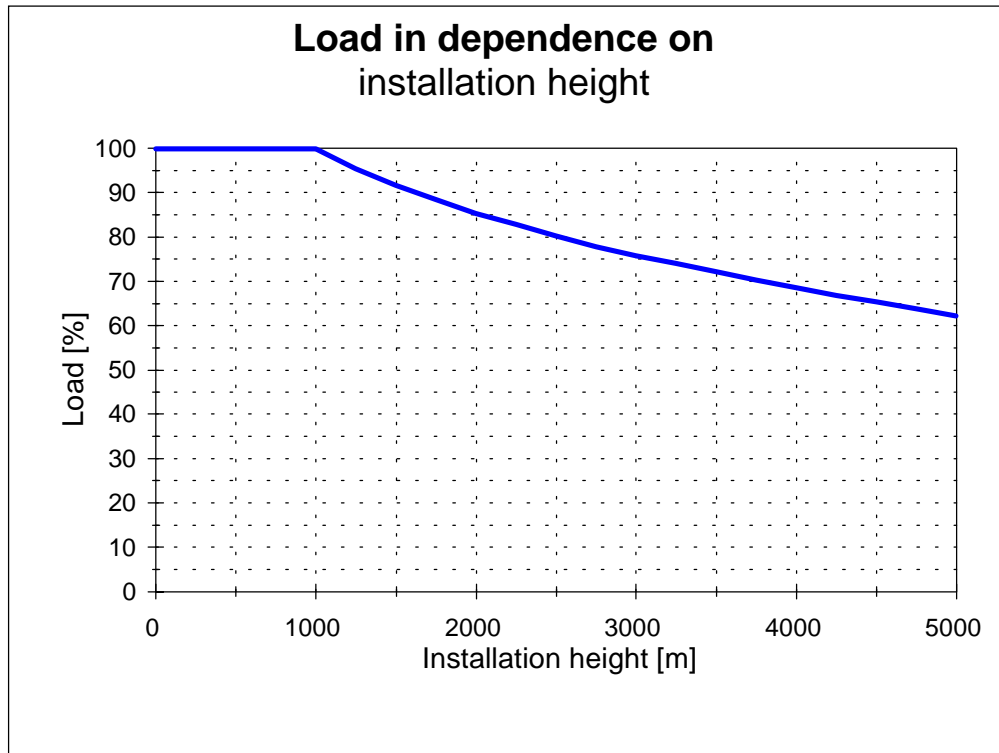

U_{ZK} Rated voltage of the intermediate circuit 310 V; Tolerance -10%/+10%; balance the deviation via transformer T1.

n_{act} Speed actual value, depending on the tachometer, $\pm 10\%$ tolerance; can be loaded with 2 mA

I_{spec} Specified current value of 10 V, reached at the peak current of the respective BUS servo power unit; can be loaded with 2 mA

n_{spec} Additional specified value, (e.g. as an offset); when added to the specified value, it may not exceed a total of 10 V

DU Direction reversal on applying +24 V;

NOTE

You can also correct the direction of rotation by reversing the specified value connections (at the differential amplifier input).

I_N Rated current of the servo power unit (direct current value); rated direct current is allowed permanently while the specified coolant temperature, T_K, and the operating environment temperature, T_B, are not exceeded.

Reduction factors of 3%/°C apply to some devices in the case of a coolant temperature range of 35° C < T_K < 45° C and an operating environment temperature range of 35° C < T_B < 55° C. When equipment is used at site elevations above 1000 m, a reduction factor applies (see the table on page 17)

Reduction to the rated motor current is possible if desired (operating data store)

I_S Peak current of the servo power unit; amongst other things, this is the basis of the dynamics of the drive; reduction to the rated motor current is possible if desired (BEDAS); an I²t evaluation component regulates the duration of the peak current:

Without preloading, the peak current flows for a maximum of 10 s

With preloading with I_N, the system suppresses the peak current.

Intermediate values according to the equation:

$$\sum I^2 \cdot t = I_N^2 \cdot (t_1 + t_2 + \dots) = I_{Red}^2 \cdot t_1 + I_S^2 \cdot t_2$$

Where: t₁ = time for which the rated current is reduced to I_{Red}
 t₂: = time in which the peak current, I_S, flows

After the time has expired, the current falls back to the device's rated value. The BEDAS circuit only corrects the peak value downwards in the case of motors with relatively low peak currents. This means that, in intermittent operation, the dc motor can take up currents ranging between the device's rated current and four-times the motor's rated current, I_N. To prevent thermally overloading the motor in this case, it is advisable to exactly determine the effective motor torque and the average speed, n_m. The torque is approximated by means of the current specified value. This value reaches 10 V on achieving the peak current of the device.

P_V Power losses of the devices; on the one hand, this is important for rating the switching cabinet, and on the other for rating the BUG basic unit:

$$\sum P_V + \sum P_{to\ motor} \leq P_N \text{ (BUG) (see also Transformer Rating)}$$

P_A Triggering power required by the servo power unit; this is virtually independent of the loading. The total of all the triggering power of all the axes on one basic unit may not be greater than the power rating of the basic feed unit's power unit (e.g. 90 W for BUG 2; 200 W for BUG 20)

T_K Coolant temperature measured 50 mm below the device; in rated operation, T_K as well as T_B must be below the specified limit temperatures. Otherwise, you must reduce the device's rated current.

Please ask for information about the conditions for use at coolant temperatures above 45° C as well as use in the case of permissible operating environment temperatures being exceeded.

T_B Operating environment temperatures measured 300 mm away from the unit at the most, half-way up the device; T_B and T_K must not exceed the specified limit temperature. The same conditions apply as before.

2.3 Type Code

BUS - 3 - 10/ 20 - 31 - 003
BUS - 3 - 15/ 30 - 31 - 003
BUS - 21 - 7.5/ 15 - 31 - 001
BUS - 21 - 15/ 30 - 31 - 001
BUS - 21 - 22/ 45 - 31 - 001
BUS - 21 - 30/ 60 - 31 - 001
BUS - 20 - 40/ 60 - 31 - 001
BUS - 20 - 60/ 90 - 31 - 001
BUS - 20 - 80/ 135 - 31 - 001
BUS - 20 - 160/ 60 - 31 - 008

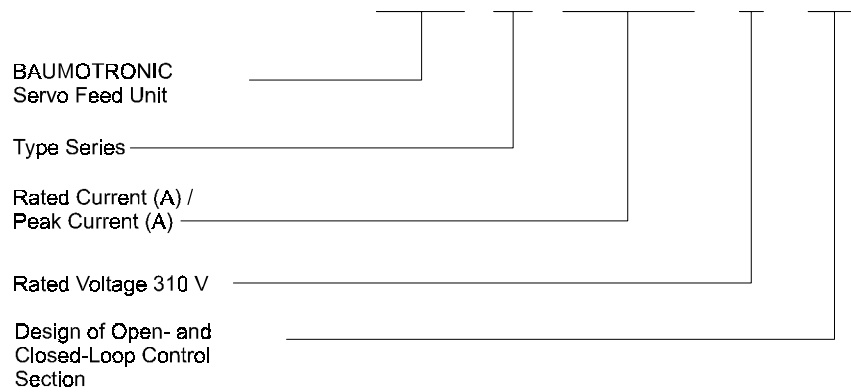

3 TRANSPORTATION, UNPACKING

The units are packed at the factory in accordance with the order.

You should avoid jarring packages in transit or jolting them, e.g. when setting them down on the ground.

After unpacking the package(s) and checking that the shipment is complete, you can start assembly.

Fibreboard, cartridge paper and/or wood are used as packaging materials and they can be disposed of in accordance with local regulations.

Report any damage in transit without delay.

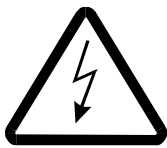

DANGER

If the unit has been damaged in transit, do not connect it to the mains until appropriate high-voltage testing has been carried out.

Ignoring this information can result in death, severe personal injury, or considerable damage to property.

4 ASSEMBLY



WARNING

The owner is responsible for assembly of the described unit, motor, transformer as well as any other equipment in accordance with safety regulations, such as DIN or VDE; equally, you must ensure that all other relevant national and local regulations are met with regard to cable ratings and protection, grounding, disconnectors, overcurrent protection, etc.

Protect drive converters from impermissible loading. In particular, components may not be warped and/or insulation gaps changed during transportation and handling. Avoid touching electronic components and contacts.

Ensure that there is no blockage of cooling air flowing into and out of the equipment and that there is enough space above and below the equipment to prevent overheating.

The units are protected from direct contact by being installed in commercially available switching cabinets that meet the minimum protection requirements of preliminary standard EN 50178/VDE 0160/11.94, Section 5.2.4.

Sheets of plastic on the devices that cover the equipment connection act as additional guards preventing accidental contact at commissioning and in the case of casual use of control elements located close to the equipment (DIN VDE 0106 Part 100, Accident Prevention Regulation VBG4 "Electrical Systems and Equipment").

Drive converters contain components at risk from electrostatic energy which can be damaged by incorrect handling.

Electrical components must not be mechanically damaged or impaired as this could lead to health risks!



WARNING

Lifting incorrectly can result in personal injury or damage to property. The device should only be lifted by appropriately qualified personnel using the proper equipment.

4.1 Dimensions

4.1.1 BUS 3

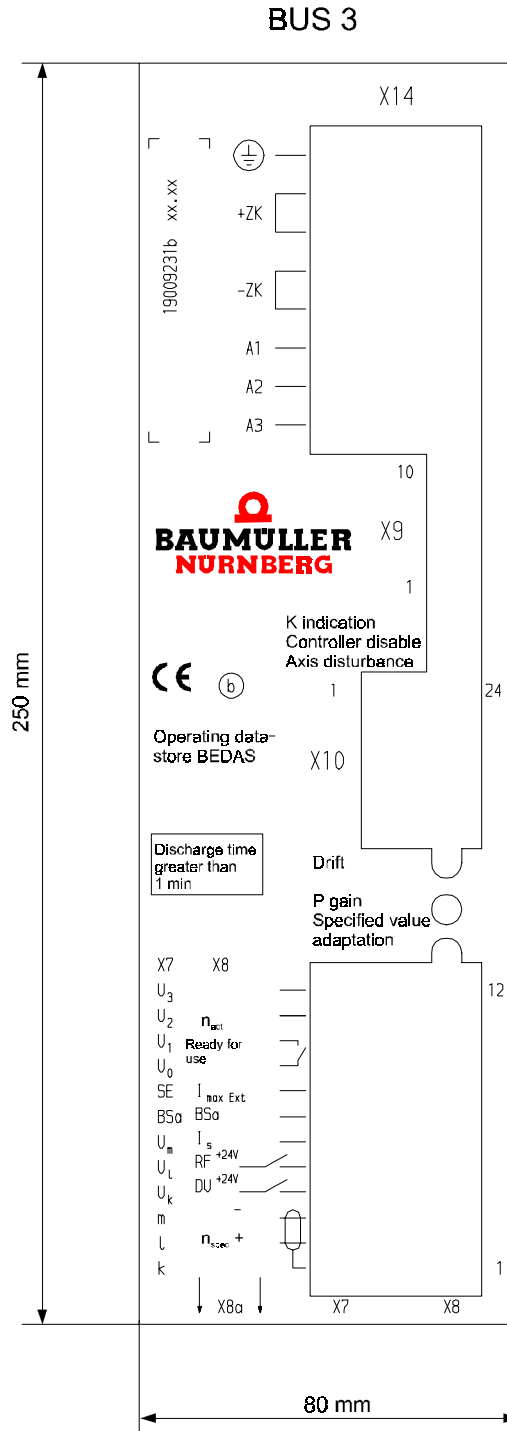

Depth of housing: 200 mm
with BEDAS and sub-unit terminals fitted: 230 mm

4.1.2 BUS 20 und BUS 21

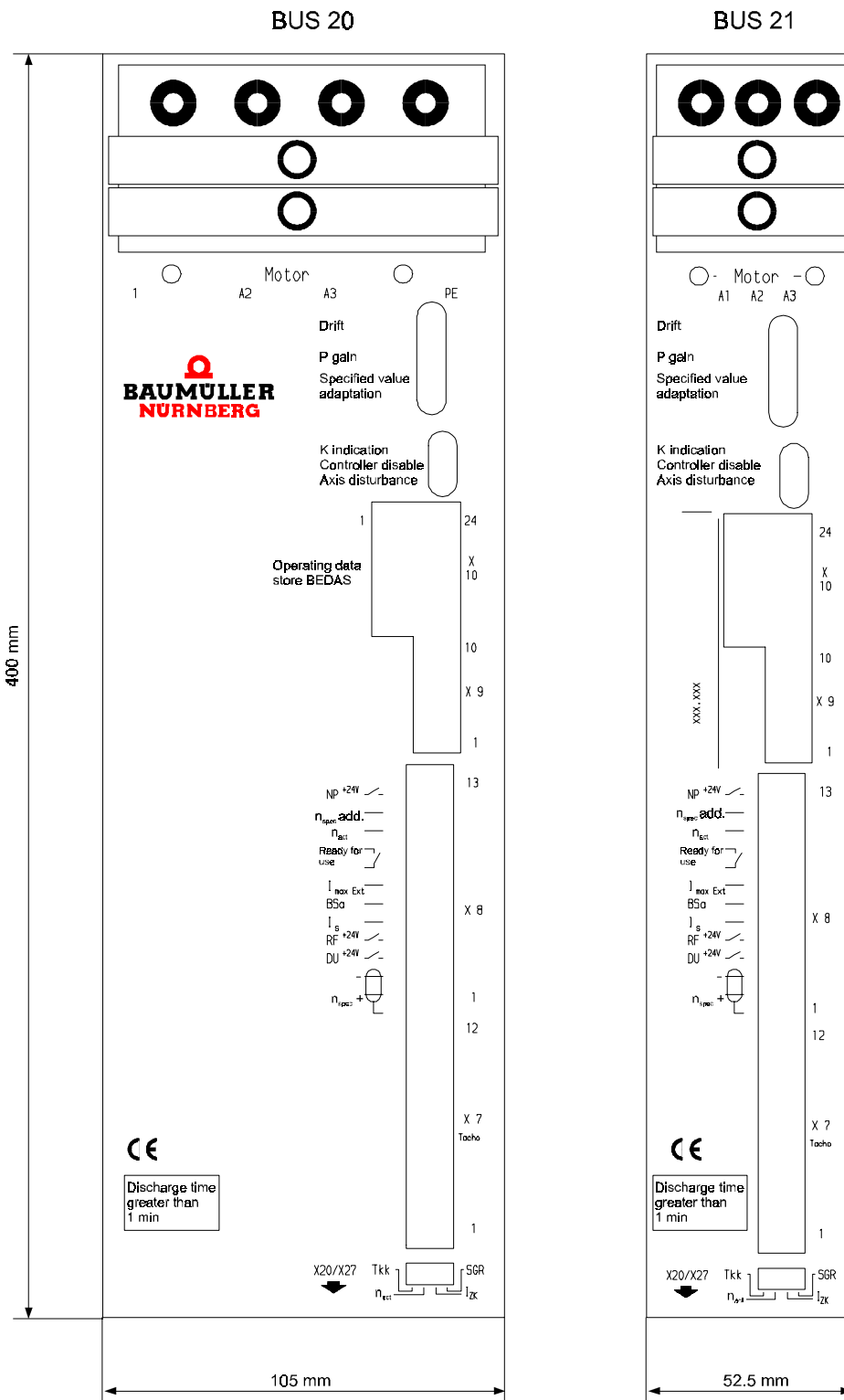

Depth of housing: 307 mm
with BEDAS and sub-unit terminals fitted: 320 mm

4.1.3 Fastening Holes

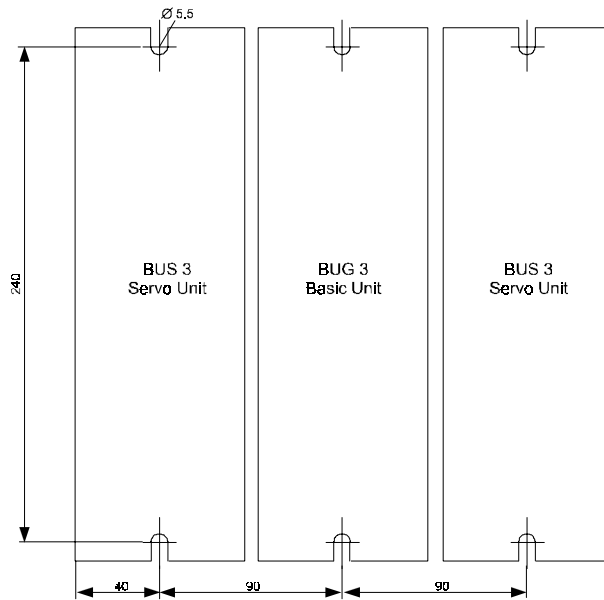
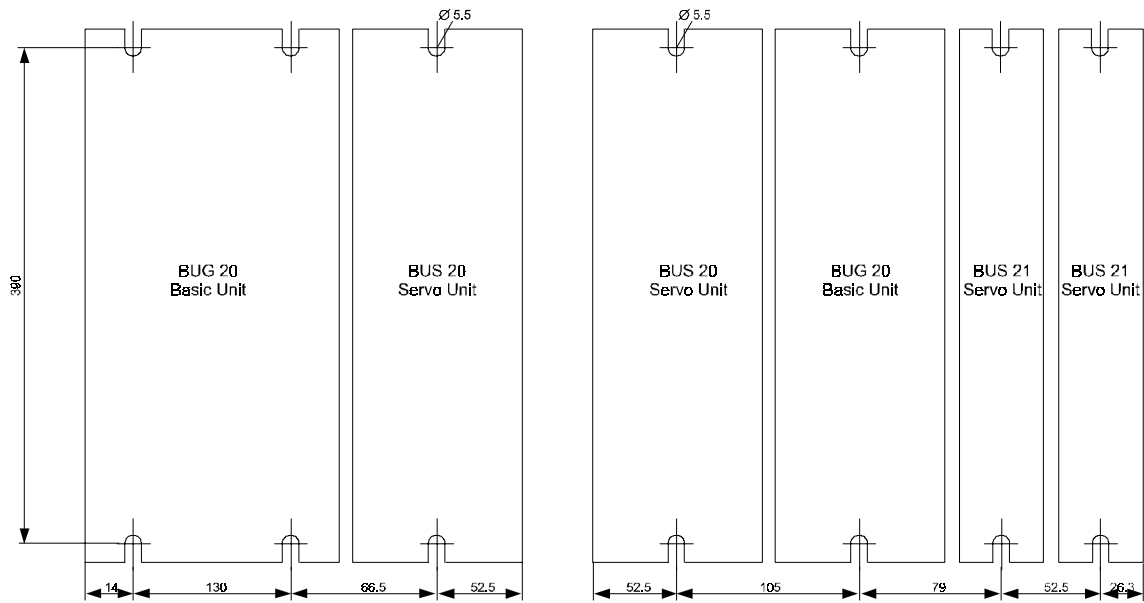

4.2 Assembly Information



WARNING

Lifting incorrectly can result in personal injury or damage to property. The device should only be lifted by appropriately qualified personnel using the proper equipment.

- Install the units vertically in a switching cabinet. Mount the BUS 3/21/20 servo power units next to the BUG 3/2/20 basic feed unit and connect the intermediate circuit using the supplied rails.

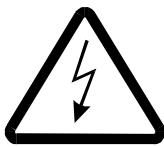

DANGER

Relatively long connections are not allowed, since there is a risk of destroying the device!



WARNING

It is crucial to comply with the ventilation measures listed below. Ignoring these measures can lead to the device overheating.

- Ventilation must be in the specified direction from the bottom to the top.
- Ensure that the flow of air is unobstructed.
- There must be a minimum clearance above and below the device of
100 mm
and you must ensure that there is enough cooling air that can circulate freely!
- The temperature of the coolant 50 mm below the devices may be up to 45° C.
- Do not locate any additional sources of heat above or below the devices.
- You must avoid degrees of contamination 3 and 4 according to provisional standard EN 50178:1994 Section 5.2.15.2. The devices are suitable for use in enclosed workshops. (VDE 0558 Part 1a, Sections 5.4.3.2.1 and 5.4.3.2.2).
- The live parts take more than one minute to discharge.

5 INSTALLATION

5.1 Danger Information



WARNING

This equipment carries a dangerously high voltage and has dangerous rotating parts (fans). Ignoring the safety and warning information may result in death, severe personal injury or damage to property.

The machine operator is responsible for mounting the mono power unit, the motor, the transformer and any other equipment in accordance with appropriate safety regulations (e.g. DIN, VDE); equally, you must ensure that all other relevant national and local regulations are met with regard to cable ratings and protection, grounding, disconnectors, overcurrent protection, etc.

Relatively high leakage to ground occurs in the converter and the motor, i.e. the drive may be incompatible with current-operated e.l.c.b.s (corresponding to provisional standard EN 50178:1994 Section 5.2.11.2).

You may only use variable-speed drives in applications that correspond to valid EN specifications.

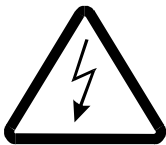

DANGER

The intermediate circuit carries a voltage!

Be particularly careful before touching the drive shaft directly or indirectly with your hands. This is only allowed when the system is deenergized and the drive is stationary.

Safety devices must never be deactivated.

5.2 EMC Information

General Information about Converters

Modern semiconductor technologies such as MCTs and IGBTs are intended to minimize the power loss in the converter by switching more quickly and, with this, to continually reduce the size of the power section. As a result, when running converters you must meet specific conditions to avoid electromagnetic influences caused by switching operations.

Disturbances can occur due to:

- capacitive fault currents caused by high rates of voltage rise when bipolar transistors and IGBTs switch.

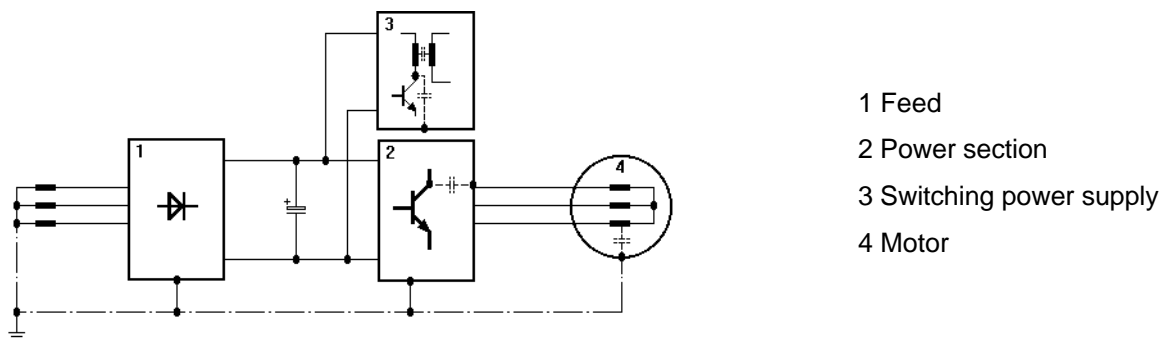

- high current and high rates of current rise in the motor lines. The disturbance energy bound in magnetic fields reaches frequencies of between a few Hertz and about 30 MHz. Due to the high rates of current rise, additional electromagnetic fields occur with frequencies of up to approximately MHz.
- high clock rates and fast logic circuits (electromagnetic field/16 MHz...1 GHz).
- system perturbation and harmonics caused by commutations and non-sinusoidal network loading, in particular with line-commutated converters (100 Hz ... 20 kHz).

German EMC Law (EMVG)

This converter complies with Paragraph 5, Section 5, Sentence 3 of the German EMC Law (EMVG) dated 09.11.92.

"Devices that are exclusively manufactured or stocked as vendor parts or spare parts for further processing by industrial companies or craftsmen or by other specialists in the field of electromagnetic compatibility not need to comply with the protective requirements of Paragraph 4, Section 1, nor do they need EU conformity certification and marking, assuming that the devices in question cannot be run automatically."

This does justice to the fact that EMC is heavily dependent on the individual subassemblies and components in the switching cabinet. With regard to the total costs of the machine, it is preferable to troubleshoot an entire system rather than each of its individual components.

The information on the next few pages is intended to allow you to configure your system on the basis of the latest knowledge in the field of EMC and to comply with legal regulations.

Measures for Ensuring EMC

To ensure EMC, you must observe the configuration information below.

Cabling

- To suppress radiated noise outside the converter, you should screen **all** the connected cabling. Also observe the topics in the section entitled "Screening".

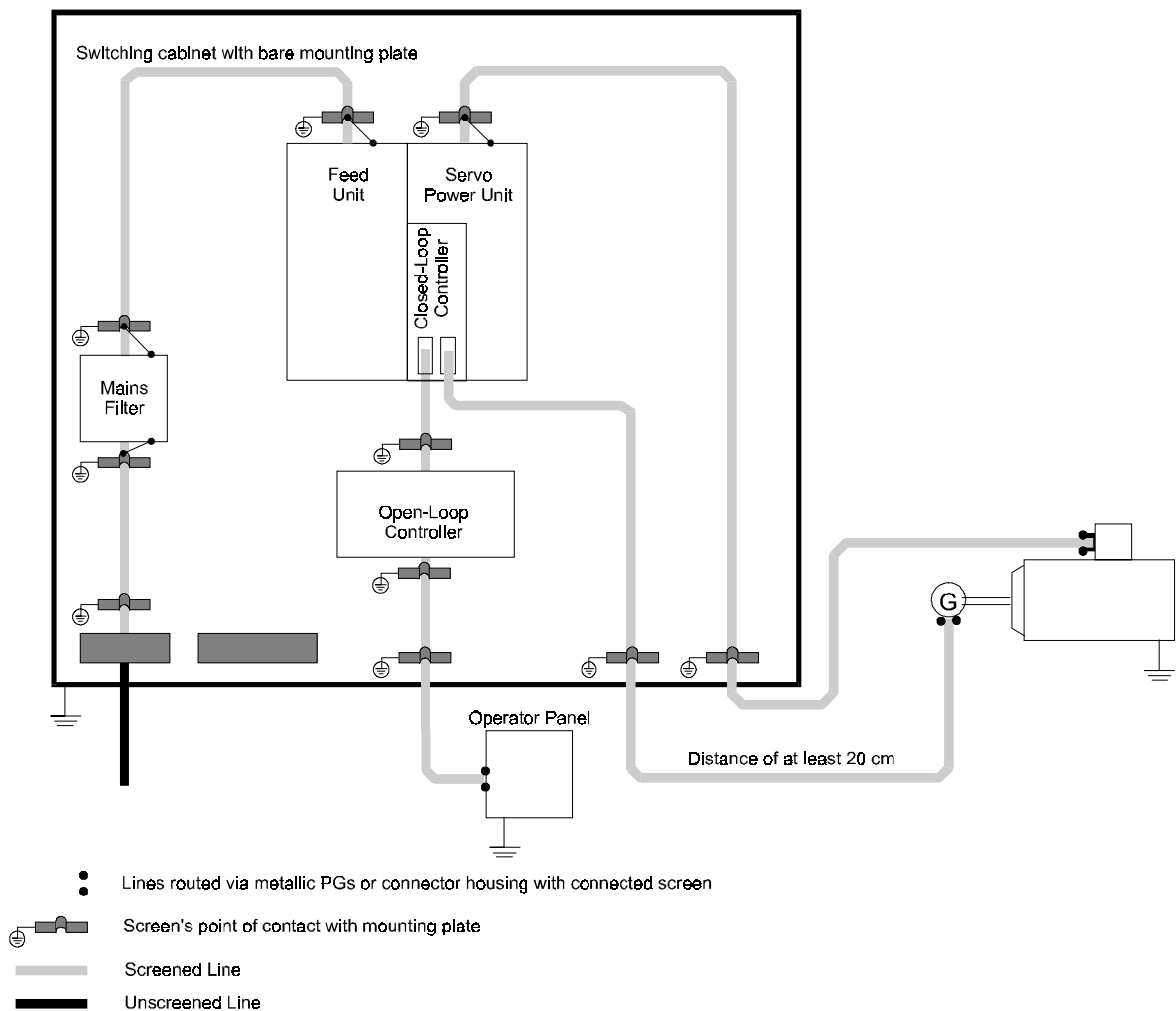

- You achieve the lowest possible effective antenna height by routing the cable directly on the ground of the metallic rack.

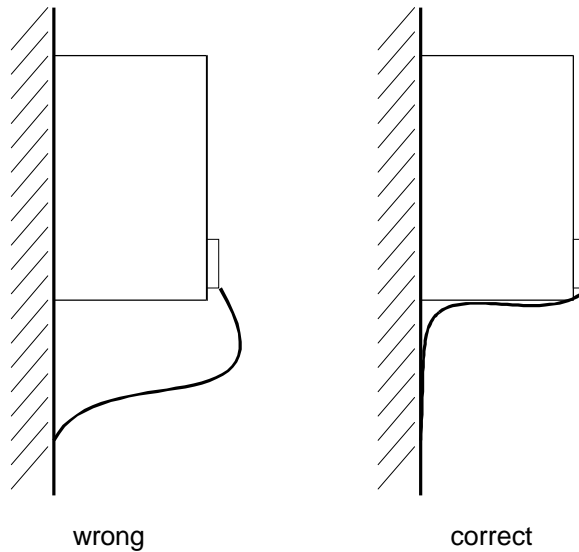

- You should route all lines as close as possible to the conductors of the ground system to reduce the effective loop area for magnetic coupling.

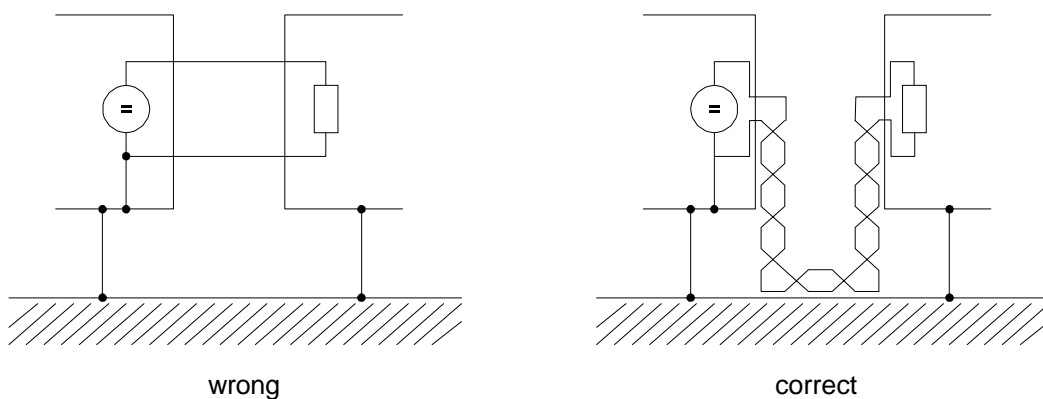

- When parallel-routing signal and control lines across power cables, the conductors must be at least 20 cm apart.
- Lines of different EMC categories should only cross at an angle of 90°.
- In the case of symmetrical signal transfer (e.g. differential amplifier inputs for the speed specified value), twist the conductors of each pair of wires together and twist the pairs of wires together.
- The converter to ground plate earth connection should be as short as possible (less than 30 cm). Use large cross-sections (more than 10 mm²).
- Sources of interference such as fuses, transformers and chokes and modules that are sensitive to interference like μ Ps, bus systems, etc. should be located at least 20 cm away from the converter and its cabling.

- Avoid reserve loops on overlong cables.
- You **must** ground reserve lines at both ends (this has an additional screening effect, avoids capacitively coupled, dangerous touch voltages).

Grounding

- From an EMC point of view, classical star grounding is no longer adequate for reducing the influence of disturbances at relatively high frequencies that occur as a result of converter operation. Better results can be achieved by a reference surface that must be linked to the devices' frame grounds over a wide area (e.g. a bare, metallic mounting plate and parts of the housing). If it is not possible to use a broad reference place, it is sensible to mount the main equipotential busbar directly next to the converter, since this device generates the greatest potential jumps, compared with the other components in the switching cabinet, due to the steep switching edges (the ground connection should be less than 30 cm long if possible).
- Route all earth conductors and screens as closely as possible above the frame ground to prevent earth circuits.
- If it is possible to earth the controller reference voltage, make this connection with cabling that has as large a cross-section as possible and is less than 30 cm long.
- Remove insulating layers, such as varnish, adhesives, etc., from the frame ground connections. If necessary, use DIN 6798 serrated lock washers or similar to ensure a permanent, conductive contact. To prevent corrosion of frame ground connections, use suitable pairs of metals (electrochemical displacement series), and keep conductive electrolytes away from the connection by means of a protective coating (e.g. grease).
- Always connect screens at both ends to the frame ground; the connection should be over a wide area and conductive. This is the only way to suppress the effects of magnetic or high-frequency noise interference fields. If there are problems with earth circuits (e.g. double earth fault of the specified value conductor screen), the receive side should be galvanically connected and the transmit side capacitively connected.
- When routing cable screens through panels that separate different EMC areas, the cables must be in contact with the panel. Cables that are routed through the outer panels of screening housings without special measures (e.g. filtering), can have an adverse effect on the screening capability of the housing. For this reason, you must make a conductive connection of the cable screens to the screening outer panel at the point at which the cable enters the housing. The distance of the last screen contact point to the exit from the cabinet must be as short as possible.

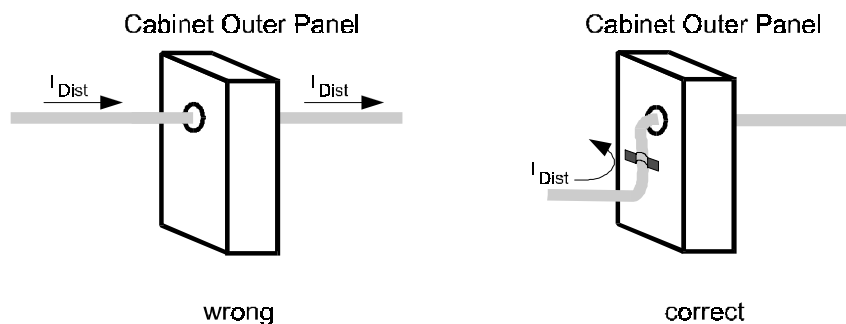

Screening

- The screen is effective against magnetic fields if it is connected to frame ground at both ends.

With electrical fields, the screen is effective when it is connected to frame ground at one end.

However, in the case of (electrical or magnetic) fields with high frequencies (depending on the length of the line), you must always connect the screen at both ends due to the linkage (electromagnetic field).

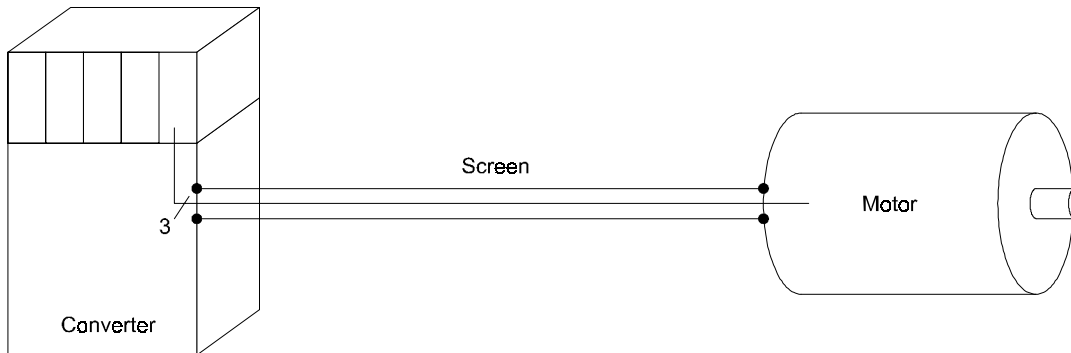

Connecting the screen to frame ground at both ends ensures that the conductor does not leave the screening "system housing".

- Frame-grounding of conductor screens on both sides does not entirely rule out the influence of earth circuits (potential differences on the frame ground system). However, this is very rare if you carry out the measures described in the previous sections entitled "Cabling" and "Grounding". You can also make a capacitive RF connection of a screen to frame ground. This prevents low-frequency interference due to earth circuits. Screened cables that pass through different EMC areas must not be separated at terminals, since screen damping would otherwise be considerably reduced. The cables should be routed to the next module without interruption.
- Make the screen connection low-impedance and over a wide surface area. Cable tails that are only three centimetres long ($1 \text{ cm of wire} = 10 \text{ nH}$) reduce the screening effect in the megahertz range by up to 30 dB!

NOTE

The braided screen must have a coverage of at least 85%.

The following lines have particularly high levels of interference potential:

- the motor line
- the line to the external ballast resistors
- the line between the mains filter and the converter

- Suggestion for screen connection:

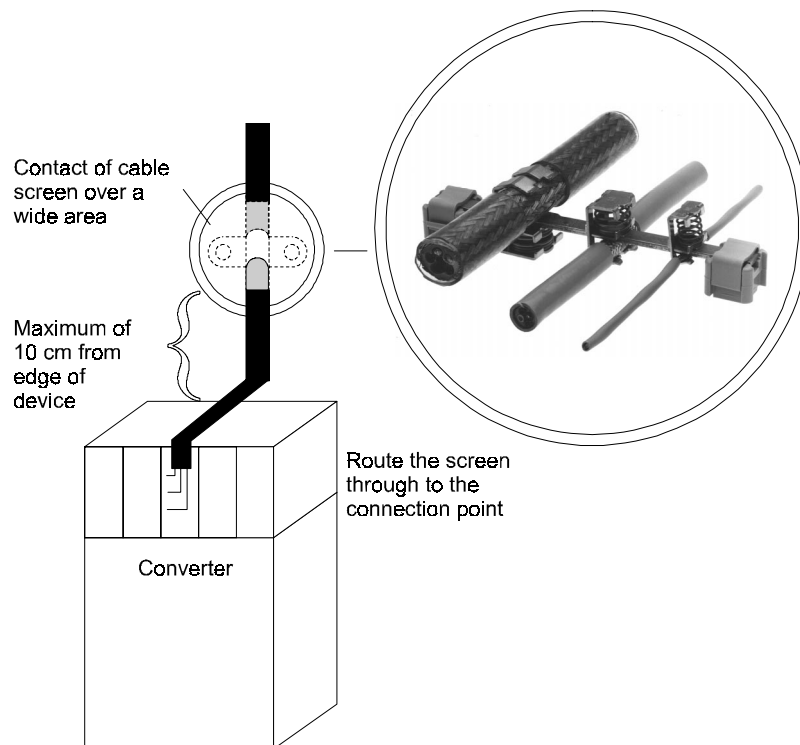

Filtering

No filters are needed for the converter to function. However, under some circumstances, filters may be needed on the input or the output side to comply with EMC regulations.

If you have any queries about filter design, please ask for the description entitled Baumüller Filters for Network Applications, BFN.

Filter Assembly

- Mount the filter directly next to the converter. With lines that are more than 30 cm long, you must screen the mains line between the converter and the filter (frame-ground on both sides).
- Physically separate the filter's input and output lines by more than 30 cm.
- Make a broad connection between the filter housing and frame ground.

Discharge Currents

Due to the principle of operation, parasitic capacities in the filter, the mains unit, the motor cable and the motor winding cause discharge currents of around 100 mA and higher.

This means that converters with earth leakage circuit-breakers may be incompatible!

In this context, you should observe the safety information in provisional standard EN 50178: Section 5.2.11.2.

5.3 Connection Diagram

5.3.1 BUS 3 Connection Diagram

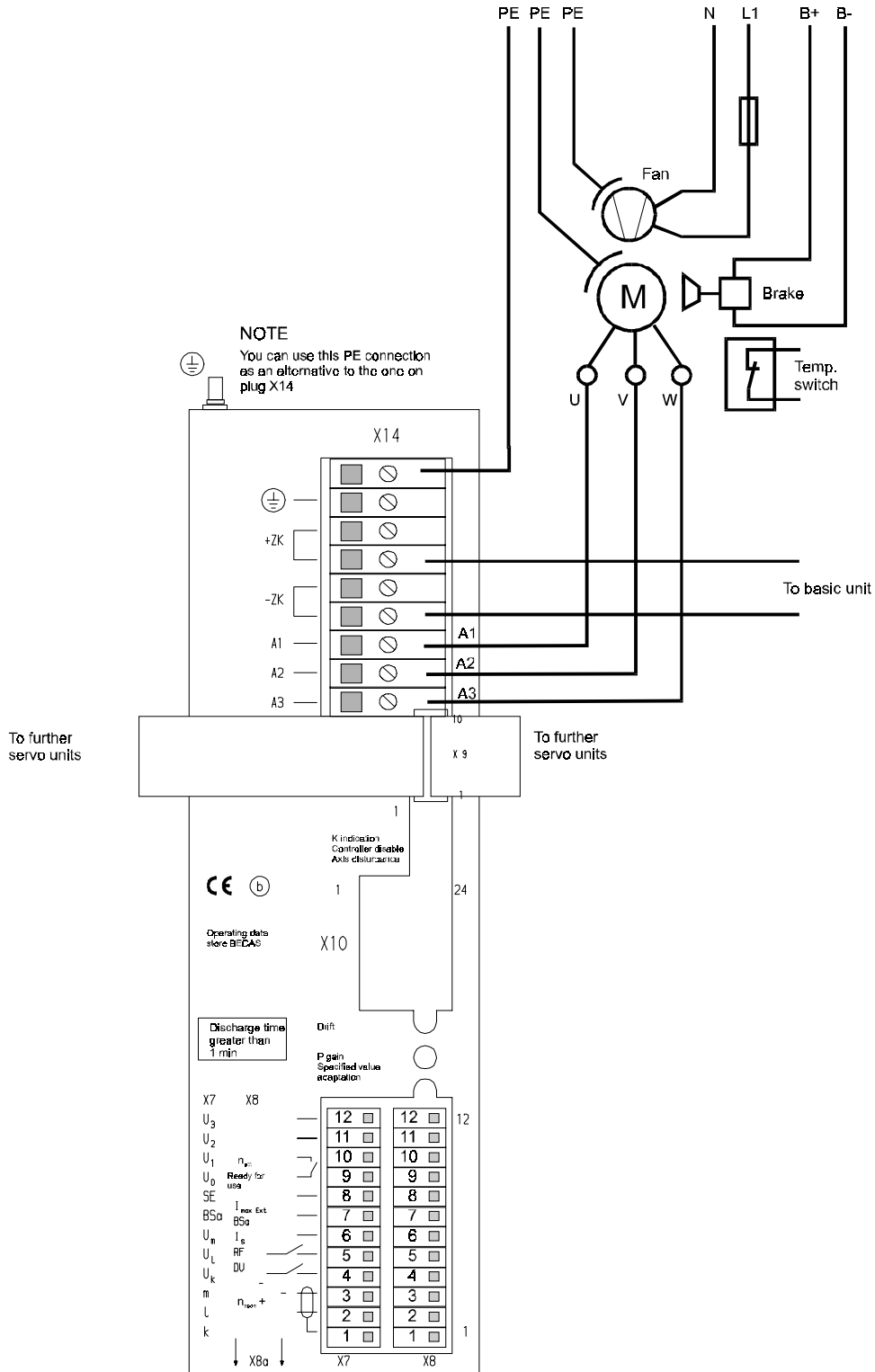

5.3.2 BUS 21 Connection Diagram

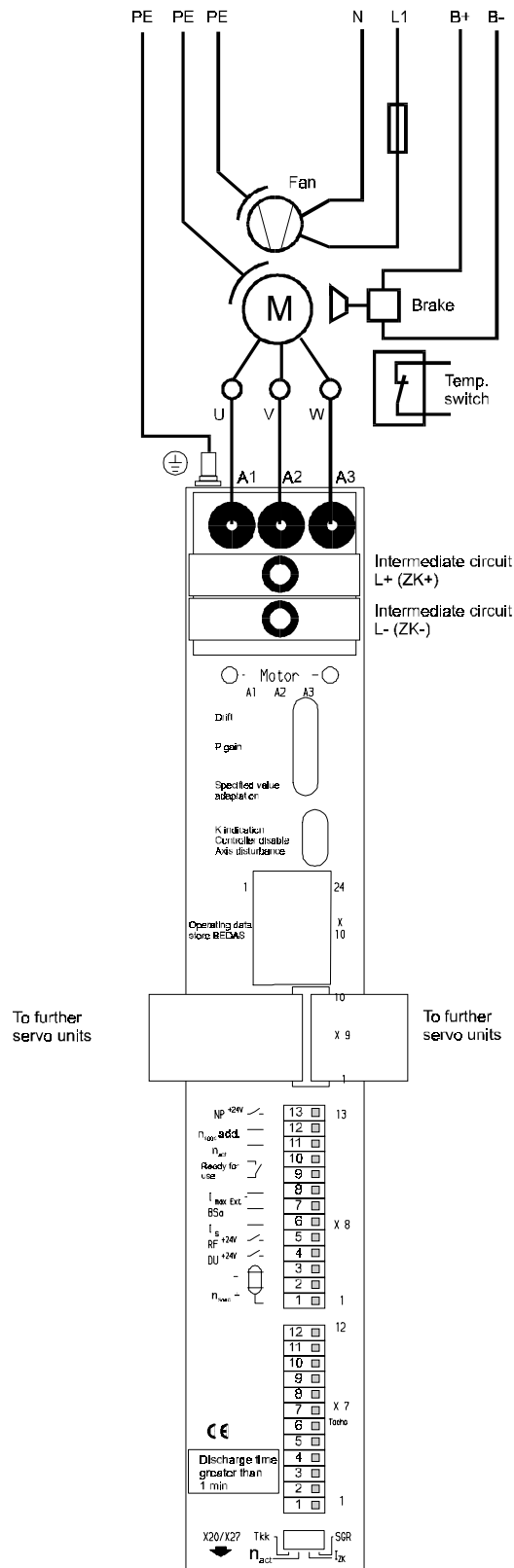

5.3.3 BUS 20 Connection Diagram

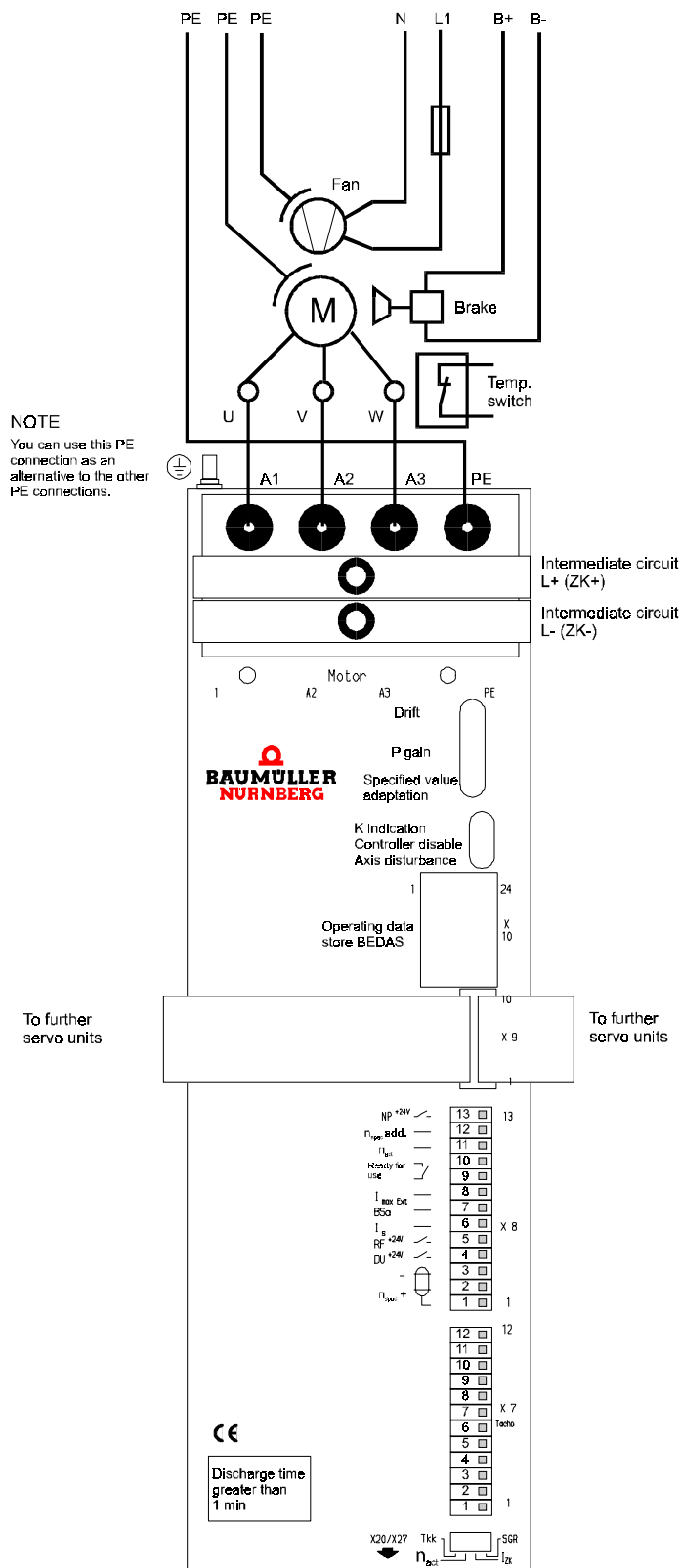

5.3.4 Double-Axis BUS 20 Connection Diagram

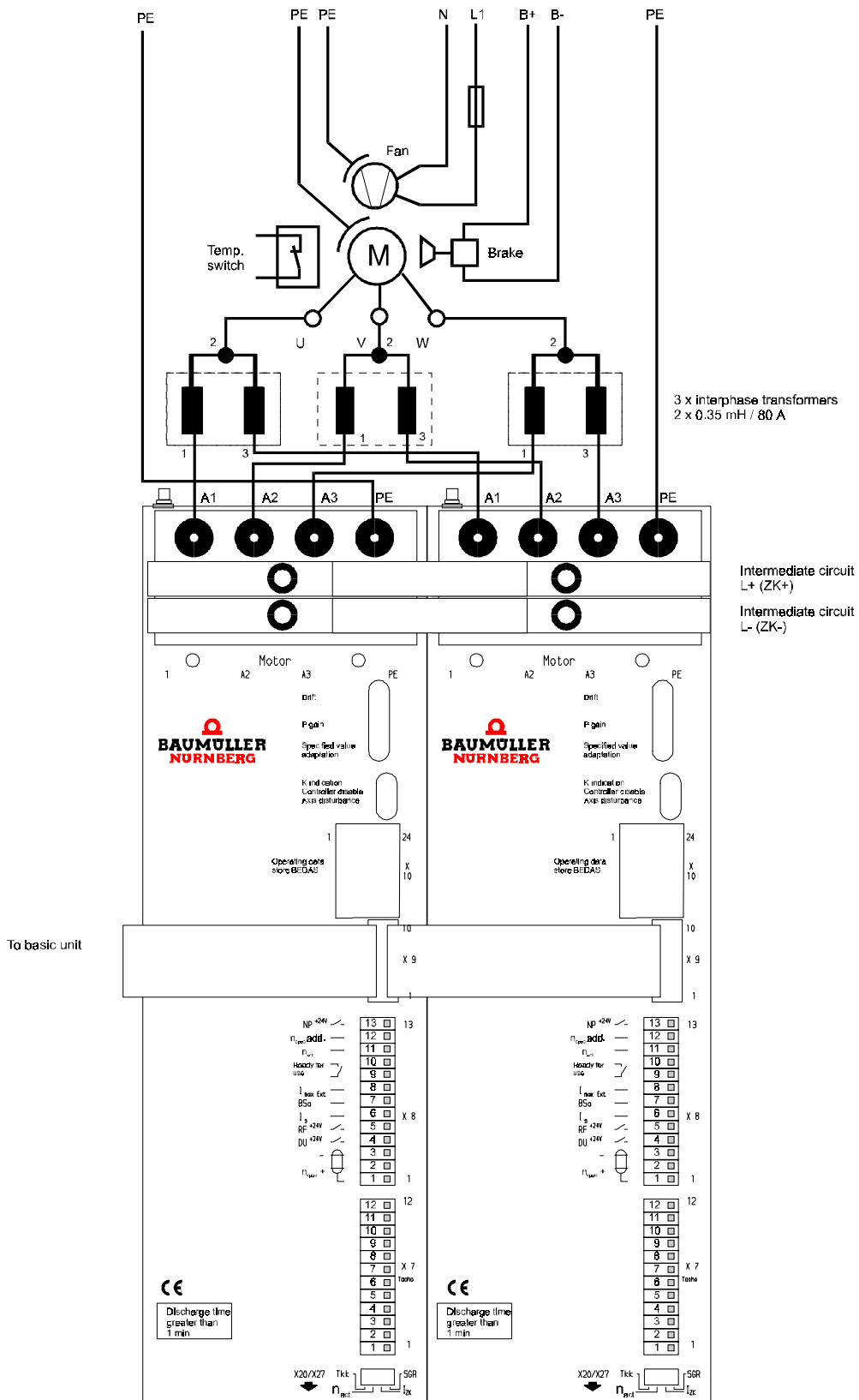

Connection Information

Current-operat
e.l.c.b.

The principles on which the power converter and the motor work lead to relatively high leakage currents to earth, i.e. the drive may be incompatible with current-operated e.l.c.b. system
For configuration, take into account provisional standard EN 50178:1994 Section 5.2.11.2.

A1, A2, A3

Cross-section of motor connections in accordance with EN 60204-1:1992. For cable-laying, refer to EMC information.

ZK+, ZK-
L+, L-

Intermediate circuit connection to the BUG units using the supplied conductor rails. If you are using only BUS 20 or only BUS 21 servo power units, arrange the basic unit in the middle between the servo power units. Otherwise, you must arrange all the BUS 20 devices on one side (e.g. on the left) and all the BUS 21 devices on the other side (i.e. on the right). Wire series 3 with 4 mm² wires; in this case too, you must arrange the basic unit in the middle. Discharging of the intermediate circuit takes about 1 min.

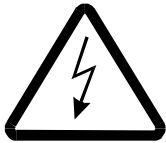

DANGER

When using autotransformers, the intermediate circuit carries a voltage. Always use the supplied cover. When using isolating transformers, ground the intermediate circuit, L-.



, PE

Protective earth

In the case of BUS 21 ... devices, do not exceed the maximum torque of 5 Nm.

The same cross-section as with the power connections. However, lay each PE **individually** to **one** central ground point and from there to the protective earth.

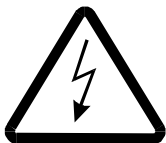

In the servo power units, the control terminals are insulated against mains potential in accordance with provisional standard EN 50178 and completely fulfill the requirements of basic insulation. This also applies to insulation between the individual circuits.

If an insulation fault should occur, there is a risk of the control terminals being live. You may not connect SELV and PELV circuits without taking additional measures (interface converter with safe isolation). The control elements of connected potentiometers, switches, etc. must have at least one basic insulation towards the electrical functioning sections. In this connection, the rated voltage is 300 V_{AC}.

5.4 Pin Assignments

X7

Pin No.	Assignment
1	k position encoder
2	l position encoder
3	m position encoder
4	U _k position encoder
5	U _l position encoder
6	U _m position encoder
7	BSA frame ground
8	SE protective earth
9	U ₀ tachometer generator
10	U ₁ tachometer generator
11	U ₂ tachometer generator
12	U ₃ tachometer generator

X8

Pin No	Assignment
1	Reference ground (bring into contact with screen of specified value line)
2	Speed specified value; one line per axis
3	Speed specified value; one line per axis
4	DU direction reversal with positive specified value and not switched Clockwise
5	Controller enable (High active +24 V); at 0 V brake motor to a standstill. Braking is interrupted automatically after 200 ms.
6	Current specified value $\pm I_S$ can be loaded with 2 mA, 10 V for maximum current of device
7	Reference ground of controller (BSA)
8	By switching against BSA, maximum current reduced to 10% of I_{max} (variable current limitation if desired)
9	Ready for use axis (contact closed)
10	Relay output can be loaded with 24 V/1 A
11	Speed actual value $\pm n_{act}$ for display: $n_N \leq 3000$ RPM; $U = 3.3$ V/1000 RPM 3000 RPM $n_N \leq 6000$ RPM; $U = 1.65$ V/1000 RPM
12	Additional speed controller input 0 ... 10 V
13	Speed controller proportional by deactivating the integral-action component (+24 V active)

X9

BUS connection (controller supply) to BUG basic feed unit or to other BUS servo power units.

X10

BEDAS operating data store, drive-specific component fitting

X20

Plug for connecting the BU test adapter to the bottom of BUS servo power units.

X27

Customer-specific male connector:

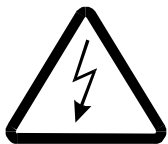

DANGER

Never break any connections with devices that are live.

5.5 Accessories

5.5.1 Brushless Tachometer Generator Connection

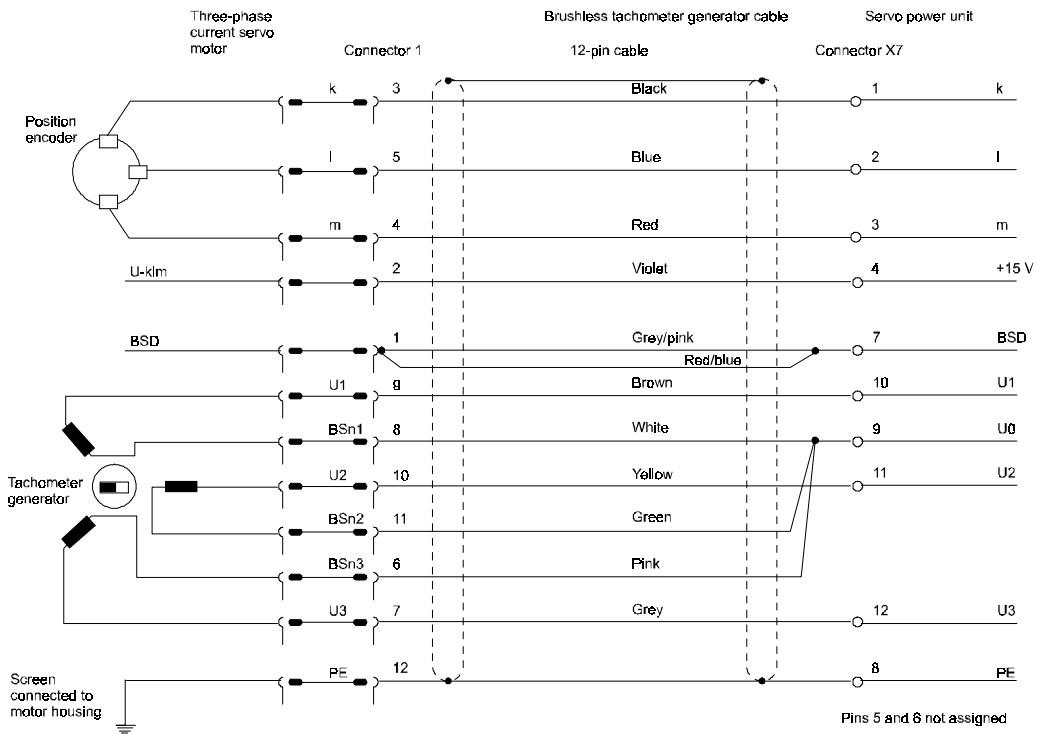

Connect the sub-unit terminal to socket X7 on the controller. If necessary, unscrew the sub-unit terminal before laying the cable.

Two different versions of the cable are supplied that are pre-cut and have integrated Interconnectron PLD 171 circular plugs. You must only use original manufacturer parts that guarantee contact protection, tension relief, protection levels and permanent contact.

Pre-Cut Cables with Connectors

Length	Article Number: Standard	Article Number: "Power Chain"
2 m	113 580	
3 m	113 146	197 362
5 m	102 124	194 122
7 m	194 152	
8 m	110 620	195 502
10 m	102 125	195 503
15 m	102 126	195 504
20 m	110 433	195 505
25 m	110 844	195 506
30 m	112 220	198 666
35 m	113 579	
38 m	197 418	
44 m	197 419	
50 m	112 155	
60 m	112 759	
65 m	197 048	
75 m	197 049	
100 m	188 349	

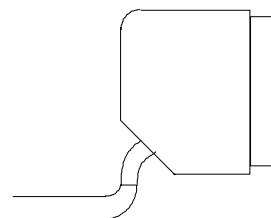
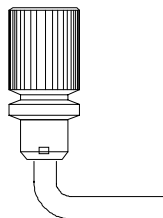
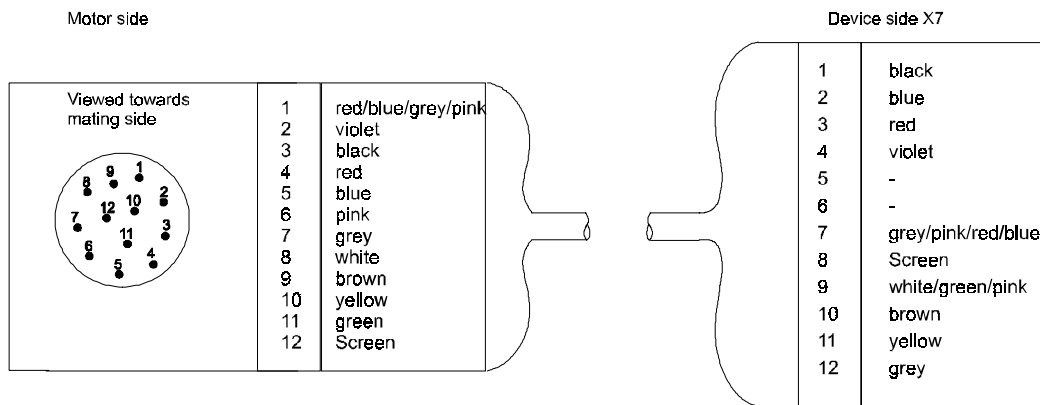

5.5.2 Incremental Encoder Connection

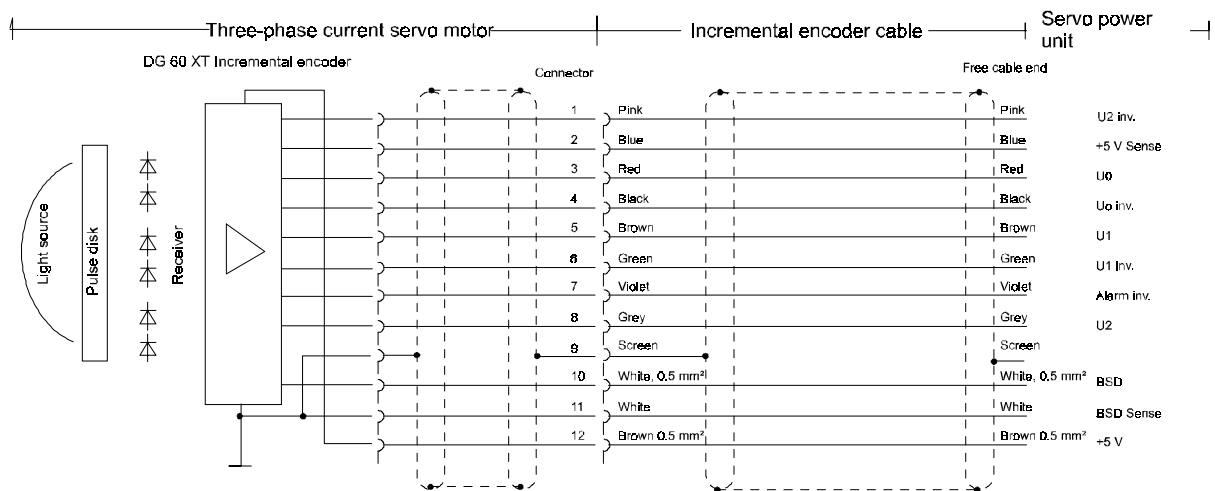

Two different versions of the cable are supplied that are pre-cut and have integrated Interconnectron PLD 121 circular plugs. You must only use original manufacturer parts that guarantee contact protection, tension relief, protection levels and permanent contact.

Pre-Cut Cables with Connectors

Length	Article Number: Standard	Article Number: "Power Chain"
3 m	198665	198962
5 m	197054	198963
8 m	198794	198964
10 m	197053	198965
15 m	197052	198966
20 m	197051	198967
25 m	197950	198968
30 m	198524	198969

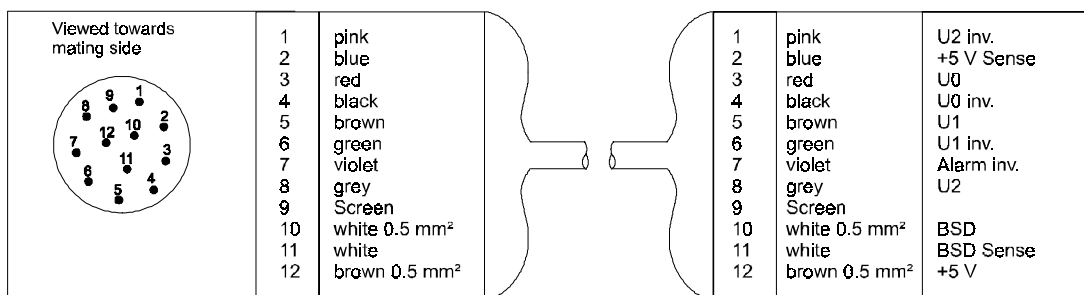

5.5.3 Test Adapter

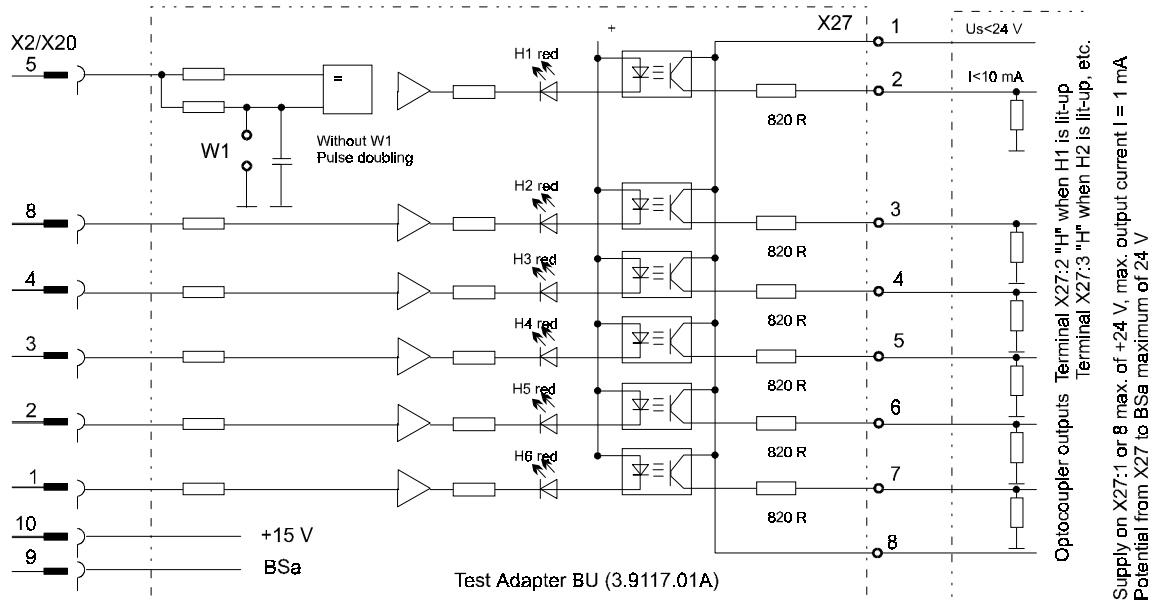

• Connection to the BUS 3 Servo Power Unit

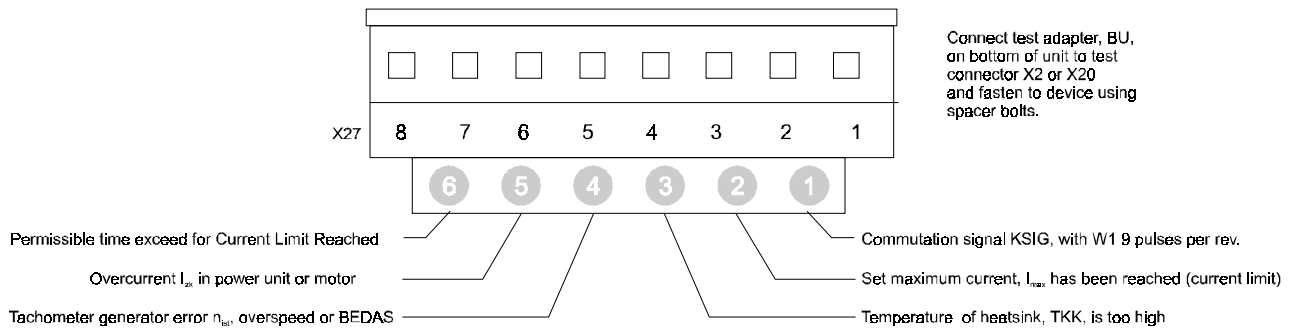

• Fault Evaluation BUS 3 Servo Power Unit

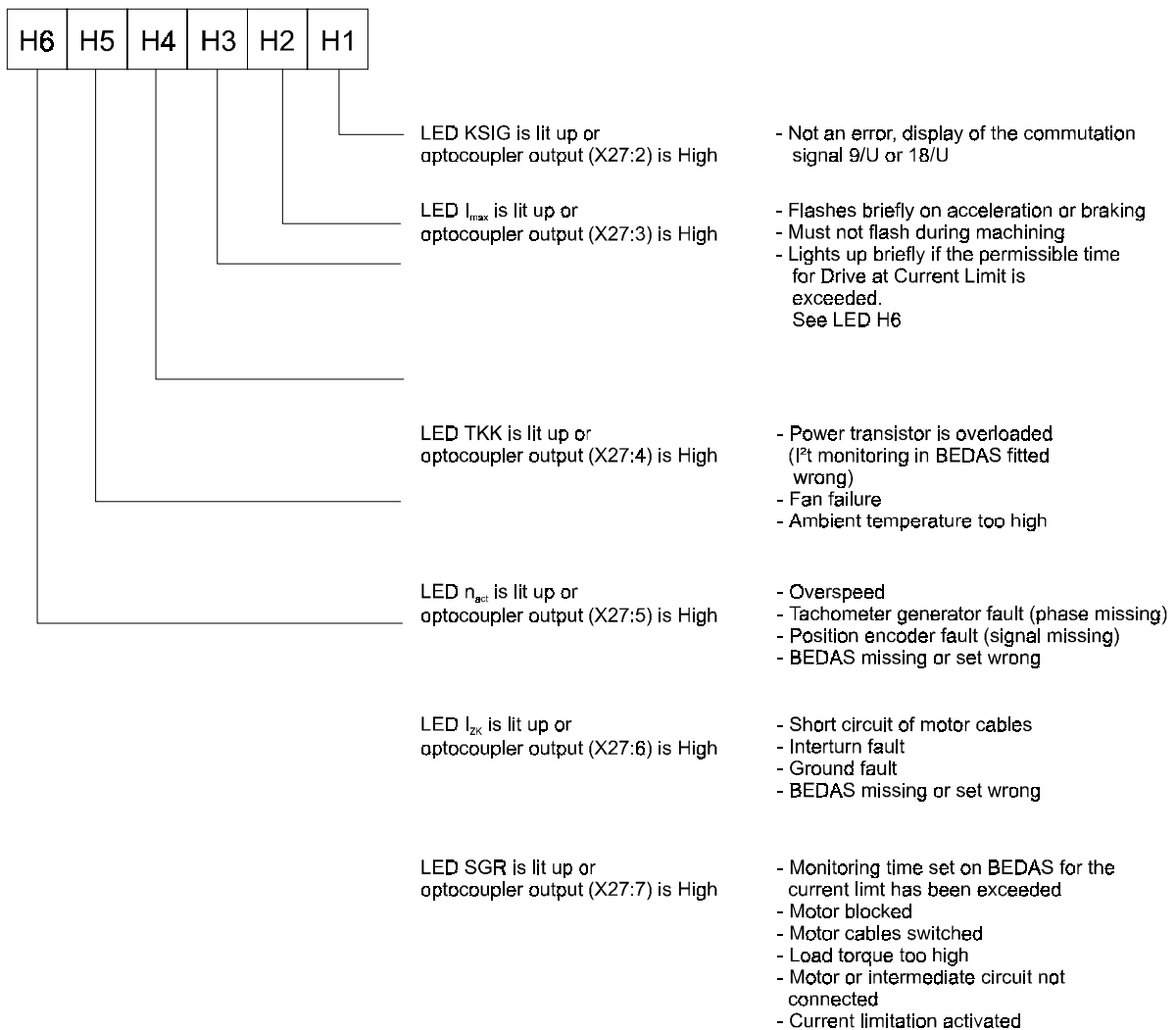

6 COMMISSIONING



WARNING

This equipment carries a dangerous voltage and contains dangerous rotating parts (fans). Ignoring the safety and warning information may result in death, severe personal injury or damage to property.

You are responsible for mounting the Mono power unit, the motor and any other equipment in accordance with appropriate safety regulations (e.g. DIN, VDE); equally, you must ensure that all other relevant national and local regulations are met with regard to cable ratings and protection, grounding, disconnectors, overcurrent protection, etc.

The most important factors for protecting people are the DIN/VDE protective measures and safety regulations. If there are no protective earth connections on the equipment, commutating reactor or the motor, personal injuries are inevitable, since the surfaces may carry dangerously high voltages.

The mains unit and the field connector of the power converter carry a dangerous voltage even when the main contactor has dropped.

During operation, the principles on which the power converter and the motor work lead to leakage currents to earth that are dissipated via the specified protective earths and may result in a current-operated e.l.c.b on the input side blowing prematurely.

In the case of a short-circuit to frame or to ground, a direct proportion may arise in the leakage current that makes triggering a higher level current-operated e.l.c.b either more difficult or totally impossible. Make the PE connection in accordance with DIN EN 60204/VDE 0113 Part 1/06.93; Section 8.2.2 taking into account provisional standard EN 50178/ VDE 0160/11.94, Sections 5.3.2.1 and 8.3.4.4.

Before carrying out commissioning, check whether the plastic covers over the power stage connections are in place.



WARNING

Faulty drive response

During initial commissioning, faulty or uncontrolled motion of the driven machine elements is always possible. At this stage, you should therefore proceed with particular care.

Before switching on the drive, you must carefully check the functions of all the higher level safety equipment to prevent injury to people.

Take particular care when directly or indirectly touching the drive shaft with your hand. This is only allowed when the shaft is stationary and the power converter is deenergized. Any exposed parts of the machine, such as the shafts, fans, etc., must be covered during operation.

Contact Protection In Accordance with Paragraph 4 Section 4 VBG 4

Protection against direct contact comprises all the measures against danger that can result from touching the active parts of electrical equipment.

You must therefore protect the active parts from being touched by means of insulation, the construction and arrangement of the equipment or directly mounted guards. The guards in question are standard covers, barriers and procedures that guarantee that people cannot touch active parts that are carrying power.

Switching cabinets must have an emergency off facility to switch off any voltages that could be dangerous. This does not include equipment which, if switched off, would cause an even more dangerous situation. The emergency off releasing element must be arranged in such a way that it can be reached quickly in case of danger. In the case of work that is considerably more dangerous than usual, another person **must** be present.

The machine minder must ensure that unauthorized people do not work at the machine.

The machine minder must report immediately any changes that occur at the machine which adversely affect safety.

When dismantling safety equipment during commissioning, repair and maintenance work, you must ensure that the machine is taken out of commission in accordance with applicable regulations. You must remount and check safety equipment immediately after completing commissioning, repair and maintenance work.



WARNING

Follow the safety information on the motor and tachometer in the appropriate operating and maintenance instructions.

Avoid any working practices that jeopardize safety at the machine.

After carrying out any work involving intervention in the drive – regardless of whether this involves the motor, actual value acquisition or the power converter – the owner must carry out acceptance testing of the machine and document it chronologically in the machine log (maintenance manual or similar). Failure to do this may result in the owner being faced with consequences relating to liability legislation.

This is not a complete list of all the procedures necessary for safe operation of the unit. If you need further information or have particular problems, contact BAUMÜLLER NÜRNBERG or one of our distributors.

Observe the warning information in chapter 1 of these operating instructions.

NOTE

- Before touching the modules, you must discharge electrostatic energy from your body to protect electronic components from high voltages resulting from electrostatic charging. The easiest way to do this is to touch a grounded conductive object before handling components.

Units containing components or modules at risk from electrostatic energy are clearly marked as such by the sticker below.

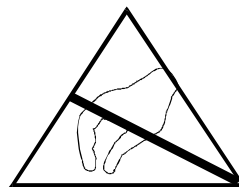

6.1 BUG/BUS Commissioning Instructions

We have carefully inspected this drive in our factory and optimized it using the BEDAS operating data store. You may only make changes to this operating data store after consulting with the factory.



WARNING

All the power connections carry a voltage: the intermediate circuit voltage is 310 V; after switching off, the intermediate circuit condenser is charged for several minutes. You should monitor discharging with an analog meter. In rated operation, the motor surfaces can have a temperature of up to 90° C so you should never touch the motors! The speed and P gain values are at their minimum when the potentiometer is turned all the way to the left (turn it counterclockwise).

1. Check the assignment of the motor ⇒ BEDAS ⇒ servo power unit;
Place the BUG basic unit in the middle between the servo power units.
2. Check the connections on the basis of the connection suggestion; carry out complete connection except for the BUS X9
Observe the connection information, particularly with regard to cable-laying;
Comply with protective measures according to VDE!
Connect the following:
 - a possible BU test adapter, which may be present with BUS 3 units, to connector X20 (extended operating messages); this is not necessary with the BUS 21/20
 - a voltmeter for checking the intermediate circuit voltage for the duration of commissioning
 - (do not yet connect BUS X9 for controller supply and communications).
3. Feeding via an isolating transformer or an autotransformer
When using isolating transformers, you must ground ZK-.
4. In the case of transformers with rated powers above 5 kVA, the current at power on must be limited by means of a starting current limitation device!
5. Check the motor:

<ul style="list-style-type: none"> – Assignments of the main connections – Brushless tachometer generator cable – Plug-in connections – Temperature monitoring 	<ul style="list-style-type: none"> – Holding brake if present – PE connection! – Motor fixed firmly to flange
--	--
6. With feed units, locate the slide in the middle.
7. Limit the current to 10% of the peak device current, I_{max} by connecting terminal X8:8 with X8:7
8. Connect the control switch for controller enable between terminals X8:5 and X1:6 (+24 V)
9. Release L1, L2 and L3 on the BUG basic unit.

10. Check the mains voltage and the transformer output voltage by connecting and switching on the voltmeter. The connection voltage of the BUG basic units should be approximately $U_N = 230 \text{ V}$.

NOTE

If necessary, choose another tap on transformer T1 to be able to get as close as possible to 230 V.

11. Switch off the system; when you switch on again, check the time delay of K2 (starting current limitation device) if there is one. Switch off the system!
12. Reconnect L1, L2 and L3 to the basic unit.
13. Switch on the system
Check the operation indicators (LEDs) on the BUG basic unit:
For this, refer to the BUG 2/3/20 Technical Description
14. Check the intermediate circuit voltage: $U_{ZK} = 310 \text{ V} \pm 10 \%$
Switch off the system and wait until the intermediate circuit has discharged.
15. Lay the BUS X9 to the first axis (drive);
Release the holding brake (if present).
Apply the minimum speed current (approximately 100 mV) at terminals X8:2 and 3 (battery box):
16. Switch on the system and briefly press the control button for controller enable:
- the yellow LED for controller disable goes out
 - the green K indicator LED flashes
 - the motor turns
 - power transmissions works without disturbances
 - the direction of rotation is OK
 - speed control functions (the motor runs evenly in dependence on the specified value).
 - switch off the system!

Correct the direction of rotation using direction reversal DU (connect X8:4 to X1:6) or by exchanging the two specified value cables.

For messages and warnings, refer to page 56

17. Roughly set the speed using a manual tachometer or the frequency, f , of the position encoder signal at terminal X7:1 against X7:7:
$$\text{Speed actual value } n_{\text{act}} = \frac{f \cdot 60}{3}$$

Match the speed using the specified value adaptation potentiometer to a speed specified value of 500 mV, for example.
18. Run in the drive while taking into account the final position and the maximum speed.
19. Check emergency stop
20. Switch on again at RPM specified value of $n_{\text{spec}} = 0$, carry out drift compensation using the Drift potentiometer.
21. Cancel current limitation by disconnecting X8:8 from X8:7.

22. Using potentiometer P gain, increase the P gain as a proportion of external torque to motor torque to just below the stability limit. You know that this limit has been reached when the specified current value, I_S , on terminal X8:7 rises.

NOTE

Increasing the P gain in an uncontrolled manner does not improve the dynamics of the drive at all, in continuous operation, the oscillations of the current specified value can lead to thermic overload of the motor.

Switch off the system!

23. Remove the pushbuttons for controller enable and the battery box and make connections to the controller instead.
24. Carry out fine compensation of the RPM by means of the screen display, contouring error, manual tachometer and correct the drift compensation
25. Check the dynamic response:
 - Acceleration to rapid traverse (with/without load)
 - Braking to $n = 0$ (check ballast, braking time $t < 200$ ms)
 - Position control with NC (set closed-loop gain factor in the controller)
 - Response in feed range (machining)
 - Emergency stop

In each case, record the speed actual value n_{act} (terminal X8:11) and the current specific value I_S at X8:6.

26. Does the torque curve $M_L(I_S)$ correspond to the intended operating mode load?
27. The holding brake releases and brakes at the right time
28. Repeat points 1 to 28 for all the other drives.
29. Release all the axes. Specified value pulse only on one axis in each case. Do the other axes change their positions in this situation? Check the NC and controller grounding and the screening of the specified value cables; as a test, connect on one side and on both sides.
30. After one hour's continuous operation:
 - Measure the temperatures of the switching cabinet and the motor with a probe not with your hands (due to the high temperature on the motor!)
 - Temperature on flange $\vartheta < 35^\circ \text{C}$ (with cabinet closed)
31. Final check:
 - Power failure/braking of all axes/emergency stop
 - Does a disturbance on one axis stop all the axes?
 - Limit switch
 - Start/stop operation

Special features of double axes with BUG 20-120-30-B-000 and BUS 20-160/270-30-008/9

To 1: Devices are laid out as shown in the connection diagram; currently available versions are BUS 20-160/270-30-008 for the master and ...-009 for the slave; version 8/91.

Not backwards-compatible with the previous version; in all enquiries, quote the device, motor and BEDAS numbers.

To 4: For possible operation with switch-on current limitation, refer to the transformer layout

To 13: Check the BUG 20 LED operation indicators. Fault evaluation same as with BUG 2.

To 16: The directions of rotation, DU, of the master and the slave must be reversed with respect to each other.

- Connect BUS connection X9, cross connection of terminal strips X7, X8 and the basic signals; **do not yet** connect the intermediate circuit!
- Resistors for current limit reached: R245

Solder slots 7-18 (use test BEDAS if necessary)

- Turn potentiometer R125 (P gain) of the slave axis **all the way to the left**. Set the RPM specified value on the master.

After the master's I²t limitation has started, check whether identical voltages are pending on the slave's input X8:8 and on its speed controller output, X8:6.

Carry out checking for both polarities.

Offset matching is possible using potentiometer R111 of the slave axis.

- Lacquer potentiometer R125 of the slave axis
- Switch off, wait until circuits have discharged and lay the ZK rails.

6.2 Messages and Warnings

On the front panel of BUS 3 servo power units, there are three LEDs, BUS 21/20 units have seven LEDs; they indicate the messages listed below.

BUS 3	BUS 21/20	Function/Cause	Status
K indicator		Display of the commutation signal – Not an error	
Controller disable		System displays controller is disabled If there is no disturbance, the indicator goes out when you enable the controller	
Axis disturbance		Group error message Localize and remove the cause using the optional BU test adapter or complementary indications in the case of the BUG 3 and the BUS 21/20 respectively.	Stored
	TKK	Over temperature of heatsink – Output stage overloaded (wrong BEDAS fitted) – Fan failure – Ambient temperature too high	Stored
	n_{act}	Actual speed – Overspeed – Tachometer fault (phase missing) – Position encoder fault (signal missing) – BEDAS missing or set wrong	Stored
	I_{zk}	Overcurrent – Short-circuit of motor lines – Interturn fault – Fault to ground – BEDAS missing or set wrong	Stored
	SGR	Current limit – Monitoring period exceeded for current limit set on BEDAS – Motor blocked – Motor lines mixed up – Load torque too high – Motor or intermediate circuit not connected – Current limitation activated	Stored

You can clear messages using RESET on the basic feed unit (for more information, refer to the BUG 2/3/21 Technical Description).

NOTE

You cannot clear messages whose causes are still indicated.

6.3 Operating Data Store, BEDAS

You plug this component into location X10 on the controller. BEDAS contains all the circuitry necessary for adapting the power unit to the respective three-phase current motor. The great advantage is the ease of handling at commissioning and maintenance. The marking on the device clearly defines the assignment to the three-phase current servo motor and to the power unit.

Marking

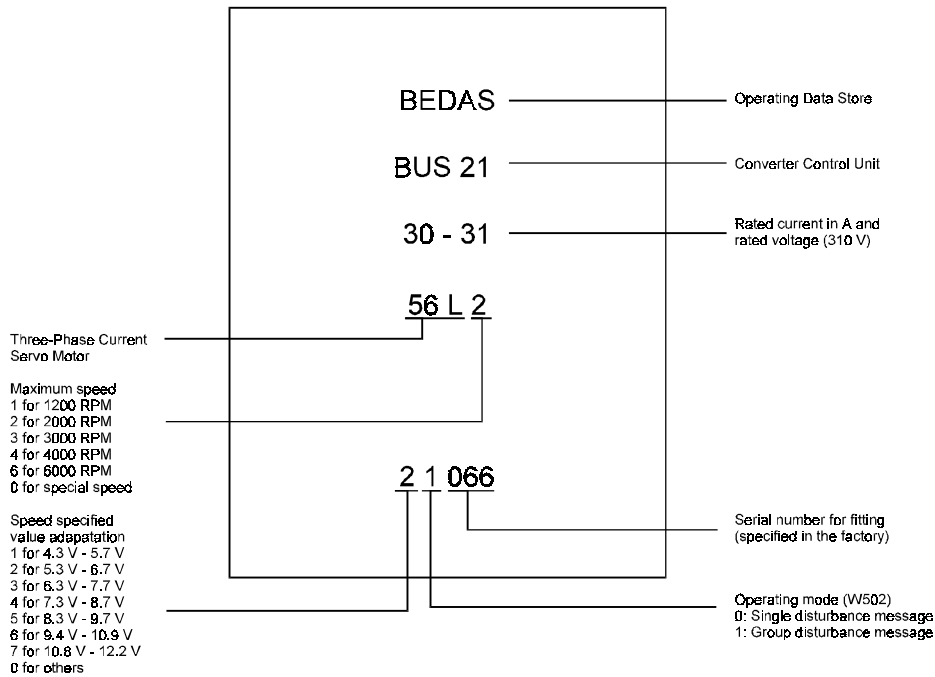

Fitting the operating data store

(this may only be changed by specialist personnel after consulting with the manufacturer)

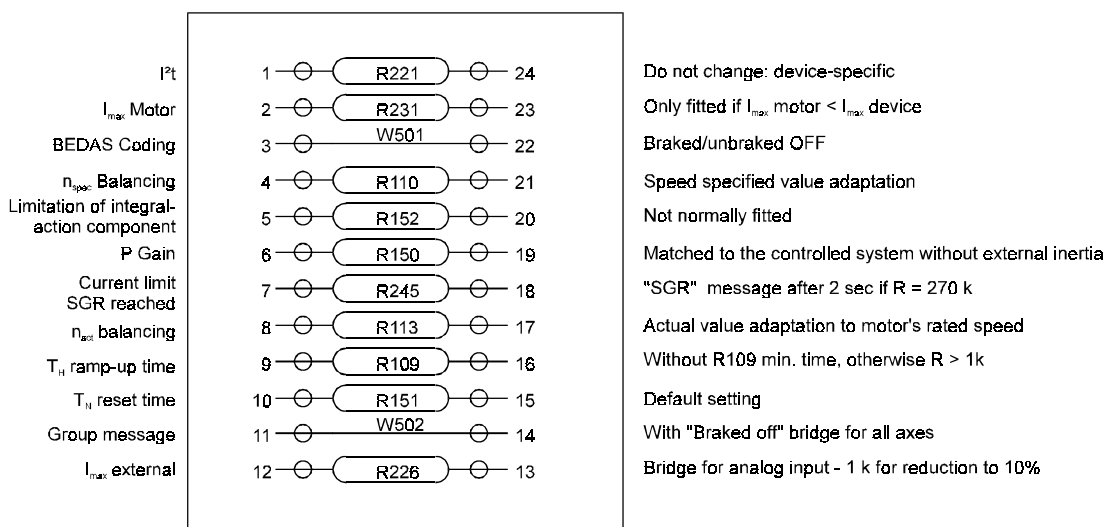

7 MAINTENANCE



WARNING

This equipment carries a dangerously high voltage and has dangerous rotating parts (fans). Ignoring the safety and warning information may result in death, severe personal injury or damage to property.

You may only carry out maintenance and corrective maintenance work when the equipment is deenergized.

Do not begin work on the power stage and the connections until you have made sure that the system has been deenergized.

When dismantling safety equipment during commissioning, repair and maintenance work, you must ensure that the machine is taken out of commission in accordance with applicable regulations. You must remount and check safety equipment immediately after completing commissioning, repair and maintenance work.

After carrying out any work involving intervention in the machine – regardless of whether this involves the motor, the actual value acquisition or the power converter – the owner must carry out acceptance testing of the machine and document it chronologically in the machine log. Failure to do this may result in the owner being faced with consequences relating to liability legislation.

In addition, you should observe the warning information in the previous chapter.

When mounting and dismantling, you must never use force on the bus bars.

Due to technical requirements, devices or motors may include individual components that contain dangerous substances.

You may only use manufacturer-approved spares.

7.1 Maintenance Information

The supplied units are maintenance-free.

Prohibition of Unauthorized Modifications

For safety reasons, unauthorized additions or modifications to the drive are not allowed.

7.2 Disposal

For the most part, the equipment consists of the following components and materials:

Component	Material
Housing, various intermediate panels, fan impeller, mounting panels	Sheet steel
Heat sink in the power stage	Aluminium
Various spacer bolts	Steel
Various spacers, housing of current converter and unit fan, etc.	Plastic
Bus bars in the power stage	Copper
Cable harnesses	PVC-insulated copper wire
Power electronics: Module thyristors mounted on a heat sink	Metal base plate, semiconductor chip, plastic housing, various insulation materials
PCBs on which all the open- and closed-loop electronics are mounted	Base material: Epoxy-resin fibreglass woven material, copper-coated on both sides and plated-through, various electronic components such as condensers, resistors, relays, semiconductors, etc.

For technical reasons, electronic components might need to contain dangerous materials, so you should not open them.

If the components are used correctly, there is no danger to human beings or to the environment.

In case of fire, dangerous compounds may result or hazardous materials may be released.

You must dispose of or recycle equipment or components according to national regulations as well as any applicable local or regional ordinances.

8 APPENDIX

8.1 Manufacturer Declaration

Manufacturer Declaration in Accordance with the EC–Machine Guidelines 89/392/EEC, Appendix II B

We herewith declare that this delivery includes the following specified machine component and that its putting into operation is prohibited until the declaration is made that the machine, in which this component is built in, complies with the regulations of the EC–machine guideline 89/392/EWG, a p-pendix II B.

Specification of the machine component:

Type:

Servo Power Unit

BUS - 3 - .. / .. - 31 - ...
BUS - 21 - .. / .. - 31 - ...
BUS - 20 - .. / .. - 31 - ...

Nürnberg, 8. January 1997
Signature of the Manufacturer:



Information regarding the Undersigned:

Head Division Electronics

8.2 Declaration of Conformity

EG Declaration of conformity of equipment regarding low voltage directive 73/23/EWG

Specification of the machine component:

Type:

Servo Power Unit

BUS - 3 - .. / .. - 31 - ...
BUS - 21 - .. / .. - 31 - ...
BUS - 20 - .. / .. - 31 - ...

Conformity of the signficated product with the guidelines will be proved by following rules:

pr EN 50178: 1994 (VDE 0160/11.94)

"Equipment of power installation concerned electronic operating materials"

Nürnberg, 8. January 1997

Signature of the Manufacturer



Dr.-Ing. P. Kreisfeld

Head Division Electronics



Dipl.-Ing. (FH) R.-A. Geller

CE-Agent Electronic

8.3 Conditions of Business and Delivery

1. Scope
- 1.1 Deliveries and performance provided by Baumüller and offers made by Baumüller are exclusively and completely subject to these general terms and conditions (from now on referred to as "these terms"). Unless a mutual agreement has been made which differs from this statement, these terms also apply to future business relationships.
- 1.2 If a customer places an order with Baumüller, this implies that these terms are accepted. Any counterconfirmations made by persons or legal persons placing an order with Baumüller with reference to their own general terms and conditions or their terms and conditions of purchase are thereby objected to.
- 1.3 Supplements or modifications to these terms require written consent from Baumüller in order to take effect.
2. Offer and Copyright
- 2.1 Offers made by Baumüller are subject to confirmation and not binding. Supplements, modifications or ancillary agreements require written consent from Baumüller in order to take effect.
- 2.2 Any pictures, drawings, measures, weights or other performance specifications are only binding if this is explicitly stipulated in writing. Drawings, dimensional drawings and descriptions of projects are subject to the copyright of Baumüller and must neither be copied nor revealed to third parties without prior written consent from Baumüller. Baumüller reserves the right to demand that these objects are immediately returned to Baumüller if they are not used for orders to Baumüller.
- 2.3 The purchaser must not use any process engineering knowledge revealed to him in his business relationship with Baumüller for his own purposes and must not reveal that knowledge to third parties. Any violation of this condition makes the purchaser (violation) liable for damages of an amount of DM 70,000.
3. Scope and Term of Delivery
- 3.1 The deadlines and terms specified by Baumüller are not binding unless explicitly specified otherwise in a written agreement.
- 3.2 The delivery term begins at one of the points in time listed below:
 - Date of confirmation of order
 - Date on which the purchaser meets all of the technical, commercial or other prerequisites he is obliged to meet
 - Date on which a downpayment or security required prior to delivery of the merchandise is furnished by the purchaser
 - If the stipulated downpayments to Baumüller are made delayed, the delivery term is extended proportionally.
- 3.3 Baumüller has the right to make partial deliveries and provide partial performance and to issue partial invoices for these deliveries or performance at any time of their choice. Excess volume or short deliveries up to 5% of the delivery quantity are permitted. The amount charged is calculated according to the delivery quantity.
- 3.4 Baumüller is not responsible for delayed delivery or performance or the inability to deliver or perform due to acts of god or force majeure or other events which make it impossible or more difficult for Baumüller to deliver - e.g. war, problems in the provision of materials which arise after the time the offer has been made, malfunctions, strike, lockout, personnel shortage, shortages of means of transportation, instructions issued by the authorities etc. which occur at suppliers of Baumüller or their sub-suppliers. Therefore, Baumüller has the right to postpone deliveries or performance by the duration of the problem plus an appropriate startup time and Baumüller also has the right to withdraw from the contract partially or completely. If the problems persist for more than 3 months the purchaser has the right to withdraw from that part of the contract which has not yet been fulfilled after having fixed an appropriate extension of the time limit.
- 3.5 The deadline is considered to have been met if the object to be delivered leaves the storage facility on the fixed date or if the purchaser is informed of its availability for shipment on the fixed date.
- 3.6 Baumüller or subcontractors of Baumüller will install and assemble the delivered objects exclusively subject to conditions and terms separately agreed upon not later than 4 weeks before delivery.
4. Passage of risk, acceptance, packing
- 4.1 Delivery is made free carrier (FRC, INCOTERM 1980). The goods are packed at the discretion of Baumüller at the costs of the customer. The risk is passed to the customer as soon as the consignment has been handed over to the person carrying out the transport or has left the store.
- 4.2 If the shipment is delayed or becomes impossible due to reasons for which Baumüller is not responsible, the risk is passed to the customer with the notification of readiness for shipment if the delivery is stipulated to be carried out upon call-forward notice, the goods are regarded as called off at the latest one year after the date of order.
- 4.3 Special acceptance conditions must be defined at conclusion of the contract at the latest. The acceptance test has to take place in the works of Baumüller. The costs for the acceptance test will be charged to the customer. If the customer omits the acceptance test, the goods are regarded as delivered as stipulated when they leave our works.
5. Prices and terms of payment
- 5.1 The prices stipulated by Baumüller in the order confirmation plus the respective legal value added tax apply. Additional deliveries and services will be separately invoiced. The prices are valid ex works or store excluding packing.
- 5.2 If not otherwise agreed upon, the prices stipulated in the order confirmation are binding for 30 days only.
- 5.3 Payments shall be made in cash without any deductions free paying office of the vendor in the currency agreed upon. Bills of exchange and checks are only accepted on account of payment. The customer has to bear any costs and bank charges arising thereof. A payment is regarded as made only, if the amount is available to Baumüller. In case of payment by check, the payment is regarded as made when the check has been irrevocably cashed.
- 5.4 Invoices are to be paid without deductions within 30 days from the date of issue. Baumüller is entitled to enter payments of the customer on older open invoices in spite of deviating instructions by the customer. If costs and interests have arisen, Baumüller is entitled to enter the payment first on the costs, then on the interests and last on the main service.
- 5.5 The customer is entitled to offset, to retain or reduce the payment - independent of notices of complaint or possible counterclaims - only, if Baumüller has explicitly agreed or if the counterclaims have been legally verified.
- 5.6 If payments are delayed, Baumüller is entitled to charge interest on arrears at a rate corresponding to the interest rate for open credits in current account, however, at least corresponding to the current discount rate of the Deutsche Bundesbank. This does not affect the assertion of another damage caused by delayed payment.
- 5.7 If the customer fails to meet his payment obligations, especially if he does not cash a check or stops his payment or if Baumüller is informed of other circumstances making the credit worthiness of the customer uncertain, Baumüller is entitled to demand advance payments or securities before delivery or to invoice the total remaining amount in the case that instalments had been previously agreed upon.
6. Retention of ownership
- 6.1 Until all claims for present or future relations have been satisfied, Baumüller can at any time demand securities from the customer. Baumüller will arbitrarily release provided securities if the value of the securities continuously exceeds the claims by more than 20%.
- 6.2 Any goods delivered remain property of Baumüller until payment has been made in full (= delivery under proviso). Goods delivered under proviso are processed or reconfigured at the purchaser's for Baumüller as the manufacturer but without additional obligations. If Baumüller ownership rights are nullified because the goods are integrated into or assembled to other objects, a portion of the ownership rights of the purchaser to that object covering the amount in question is transferred to Baumüller. The purchaser keeps the property of Baumüller in custody for no charges.
- 6.3 The purchaser has - unless he is in delay of payment - the right to process and sell the goods delivered under proviso in normal business. However, he must not distress or transfer ownership of the goods delivered under proviso by way of security. The purchaser transfers any receivables arising from the selling of the goods or for another legal reason completely to Baumüller when the goods are received. Baumüller revocably entitles the purchaser to collect the receivables transferred to Baumüller on the account of Baumüller under his own name. Upon request by Baumüller, the purchaser will reveal the transfer.
- 6.4 If third parties access the goods delivered under proviso, the purchaser will inform them about the ownership rights of Baumüller and will immediately inform Baumüller. Any expenses and damages are paid for by the purchaser.
- 6.5 If the purchaser violates any of the terms of the contract - in particular if he is in delay of payment - Baumüller has the right to reposes the goods delivered under proviso at the cost of the purchaser or Baumüller has the right to require transfer of the restitution title the purchaser has against third parties. If Baumüller repossesses or distresses the goods delivered under proviso, this does not mean that Baumüller withdraws from the contract. The right to receive payment for damages remains unaffected by this.
7. Warranty
- 7.1 If the delivered products are faulty or fail to have properties guaranteed by Baumüller or if the products become defective during the warranty period because of faults which occurred or were caused during the process of manufacturing or in case of material defects Baumüller supplies - excluding any other warranty claims by the purchaser, in particular excluding any direct or indirect secondary claims for damages from the purchaser - replacement parts of their own choice or rectifies defects. Multiple rectification is permitted. For essential products and parts not manufactured by Baumüller - in particular if the purchaser has made specifications - the liability of Baumüller is limited to the transfer of the claims for damages Baumüller has against the supplier of these products or parts.
- 7.2 The warranty period is 12 months and starts on the day the goods are shipped to the purchaser or - if the delivery scope is installed and assembled by Baumüller - the warranty period starts on the day the installation is complete.
- 7.3 The purchaser is obliged to inspect the delivered goods for damages or defects immediately or at least within two weeks after receiving the goods or - if the product is installed - within two weeks after completion of the installation process. In addition, he is obliged to inform Baumüller of any damages, defects or losses immediately by sending a report created by the carrier or a corresponding report in the form of a statement in lieu of an oath which must have been signed by two witnesses and by the purchaser. In addition, Baumüller must be informed in writing of obvious defects or shortcomings immediately or at least within two weeks after delivery. If shortcomings and defects cannot be detected in thorough tests within two weeks and are found at a later time, Baumüller must be informed of these problems immediately after they are detected. Defective products must be submitted to Baumüller for testing on request in the condition in which the defect was detected. Defective products must not be returned to Baumüller unless Baumüller requests in writing that the products are returned. Failure to observe any of the regulations specified above nullifies all warranty claims against Baumüller.
- 7.4 If rectification or replacements are not successful within an appropriate period of time, the purchaser may either request reduction of the purchase price or cancellation of the delivery contract.
- 7.5 If Baumüller manufactures a product based on design specifications, drawings, models or other specifications provided by the purchaser, Baumüller is responsible only for the fact that the manufactured product meets the specifications. Baumüller is not responsible for the usability of the product for the purposes the purchaser intends to use it for.
- 7.6 Excluded from warranty are shortcomings or defects caused by instructions and/or assembly not effected by Baumüller, insufficient equipment of the customer, overload of the components exceeding the capacity specified by Baumüller, negligent and improper treatment and utilization of unsuitable operating materials at the customer. This also applies to shortcomings or defects arising due to material provided by the customer. The warranty does not apply to damages caused by third parties, atmospheric discharges, overvoltages and chemical influences or to the replacement of parts which are exposed to natural wear. The warranty is void if the customer or a third party changes or repairs the units delivered without written permit by Baumüller.
- 7.7 In case of guarantee and/or warranty claims, the motor, the spare part or the unit shall be shipped free of duty and with free packing after prior agreement with Baumüller. Baumüller is freed of any warranty, if the customer returns the defective products without prior agreement or without observing the arrangements.
- 7.8 Baumüller is entitled to install spare parts and units into the plants of the customer for warranties to be fulfilled within the warranty period, in order to replace the defective products so that the efficiency of the customer's parts is affected as little as possible. The warranty period for installed spare parts and units is 6 months from the date of replacement at the customer. Taking into account the service time for the delivered products, the warranty period of 12 months from date of delivery acc. to item 7.2 remains unchanged.
8. Liability
- 8.1 Baumüller is liable for information and consulting activities on the utilization of the ordered and delivered products only with written confirmation in accordance with the below regulations. Verbal statements and information are not binding.
- 8.2 Claims for damages due to impossibility of performance, nondelivery, positive breach of obligations, culpa in contrahendo and unlawful act to Baumüller as well as to the persons employed in performing an obligation are excluded, if the damage has not been caused deliberately or grossly negligent or Baumüller is liable according to the product liability law.
9. Lump-sum damages in case of withdrawal
- 9.1 If the customer withdraws from the written order due to reasons for which Baumüller is not responsible, Baumüller is entitled to charge lump-sum damages of 50% of the net order amount. This applies also, if Baumüller withdraws from the contract due to reasons for which the customer is responsible.
10. Miscellaneous
- 10.1 Place of fulfillment and jurisdiction is Nuremberg. However, Baumüller is entitled to advance claims at the legal place of jurisdiction of the customer.
- 10.2 The legal regulations applicable in the Federal Republic of Germany are applicable to these conditions and terms of sales and delivery. The regulations or the UN law of sales are excluded.
- 10.3 If one or several regulations of these conditions and terms of sales and delivery are or become ineffective or if any arising situation and circumstances are not covered by this contract text, jurisdiction will replace or supplement the ineffective or incomplete stipulations by appropriate regulations corresponding to the economic purpose of the intended regulation to the largest possible extent. The validity of the other regulations remains unchanged.

8.4 Index

A

Accessories • 43
Appendix • 61
Assembly • 23
Assembly Information • 27

B

BEDAS • 57
Brushless Tachometer Generator Connection • 43
BUS 20 Connection Diagram • 38
BUS 21 Connection Diagram • 37
BUS 3 Connection Diagram • 36

C

Cable screens • 33
Circuit Diagram • 13
Commissioning • 49; 52
Connection Diagram • 36
Connection Information • 40
Connection voltage • 14; 15; 16
Controller supply • 42

D

DANGER • 8
Danger Information • 8; 29
Declaration of Conformity • 62
Degrees of contamination • 27
Description of Function • 12
Dimensions • 24
Discharge Currents • 35
Disposal • 60
Double-Axis BUS 20 Connection Diagram • 39

E

Earth circuits • 33
Electrical Data • 14
EMC Information • 30

F

Fastening Holes • 26
Fault Evaluation • 47
Features • 11
Filter Assembly • 35
Filtering • 35

G

Grounding • 33

I

Incremental Encoder Connection • 45
Initial Commissioning • 50
Installation • 29

M

Maintenance • 59
Manufacturer Declaration • 61
Messages • 56
Monitoring • 12
Motor connections • 40

N

NOTE • 8

O

Operating Data Store • 57

P

Personnel, qualified • 9
Pin Assignments • 41
Power Unit • 12

S

Safety Information • 7
Screening • 34
Site altitude • 14; 15; 16

T

Technical Data • 11
Temperature of coolant • 27
Test Adapter • 46
Transportation • 21
Type Code • 19

U

Unpacking • 21
Use, appropriate • 9

V

Ventilation • 27

W

WARNING • 8
Warnings • 56