

SÜTRON

ELECTRONIC GMBH

Technical Manual

TesiMod Operating Terminal

BT15N

Version 1.0 issued 26th November 1999

Süttron electronic GmbH
Kurze Straße 29
70794 Filderstadt
Tel.: ++49 7 11 / 77 09 80
Fax: ++49 7 11 / 77 09 86 0
Email: support@suetron.de

TesiMod BT15N

V1.0

15.06.1999

First edition

TesiMod BT15N

Table of Contents

1	Explanation of Symbols	5
2	The Operating Terminal BT15N	5
2.1	Front View	6
2.2	Keyboard	7
2.2.1	Editing Keys	7
2.2.2	Control Keys	8
2.2.3	Special Keys	9
2.2.4	Function Keys	10
2.2.4.1	Function Key Arrangement	10
2.2.4.2	Slide-in Identification Strips for the Function Keys	11
2.3	Rear View	12
2.3.1	Standard	12
2.3.2	InterBus	13
2.3.3	SUCOnet K	14
2.3.4	PROFIBUS-DP	15
2.3.5	CAN-Bus	16
2.3.6	InterBus Optical Fibre	17
2.4	Mounting the Terminal	18
2.4.1	Front Panel Dimensions	19
2.4.2	Side View, Mounting Depth	20
2.4.3	Panel Cutout	21
2.5	Pin Assignments	22
2.5.1	Pin Assignment X1 Supply Voltage	23
2.5.2	Pin Assignment X2.1 / X2.2 InterBus	24
2.5.3	Pin Assignment X2.1 / X2.2 SUCOnet K	25
2.5.4	Pin Assignment X2 PROFIBUS-DP	26
2.5.5	Pin Assignment X2.1 / X2.2 CAN-Bus	27
2.5.6	Pin Assignment InterBus Optical Fibre	28
2.5.7	Pin Assignment X3 SER1 TTY / 20 mA Current Loop	29
2.5.8	Pin Assignment X3 SER1 RS485	30
2.5.9	Pin Assignment X3 SER1 RS232c	31
2.5.10	Pin Assignment X3 SER2 RS232c	31
2.5.11	Pin Assignment X4 Parallel Outputs	32
2.6	Shielding	32

TesiMod BT15N

2.7	Display	33
2.7.1	Display Contrast Setting	34
2.7.2	Default Contrast Setting	34
2.7.3	Character Attributes	34
2.7.4	Font Normal	35
2.7.5	Font Zoom	35
2.7.6	ASCII Character Set Table	36
2.8	User-Mode Switch	37
2.9	Battery	38
2.10	Fuse	39
2.11	Application Memory	39
3	Technical Data	40
4	Declaration of Conformity	43
5	Index	45
A	Appendix A	A-1
A.1	Shielding of SubminD - Interconnections	A-1

TesiMod BT15N

1 Explanation of Symbols

This manual uses the following symbols to indicate notes and hazardous situations.



Notes for the User



General Danger



Specific Danger

2 The Operating Terminal BT15N

The operating terminal **BT15N** makes it easier for the operator to input and visualise process values. A comfortable operation is established by means of the TesiMod operating concept.

The **BT15N** is equipped with an extensive keyboard to input process values and to access several functions. The LED backlit LCD module has a wide contrast and has full graphics capability. It supports character oriented positioning of graphics, text elements and variables.

A built-in lithium battery buffers the data in the RAM and also supplies the real-time clock with power. The discharge state of the battery is monitored constantly by the system.

The communication with the **BT15N** is supported by standardized interfaces. The modularity of the software allows a quick adjustment to different protocols.

TesiMod BT15N

2.1 Front View

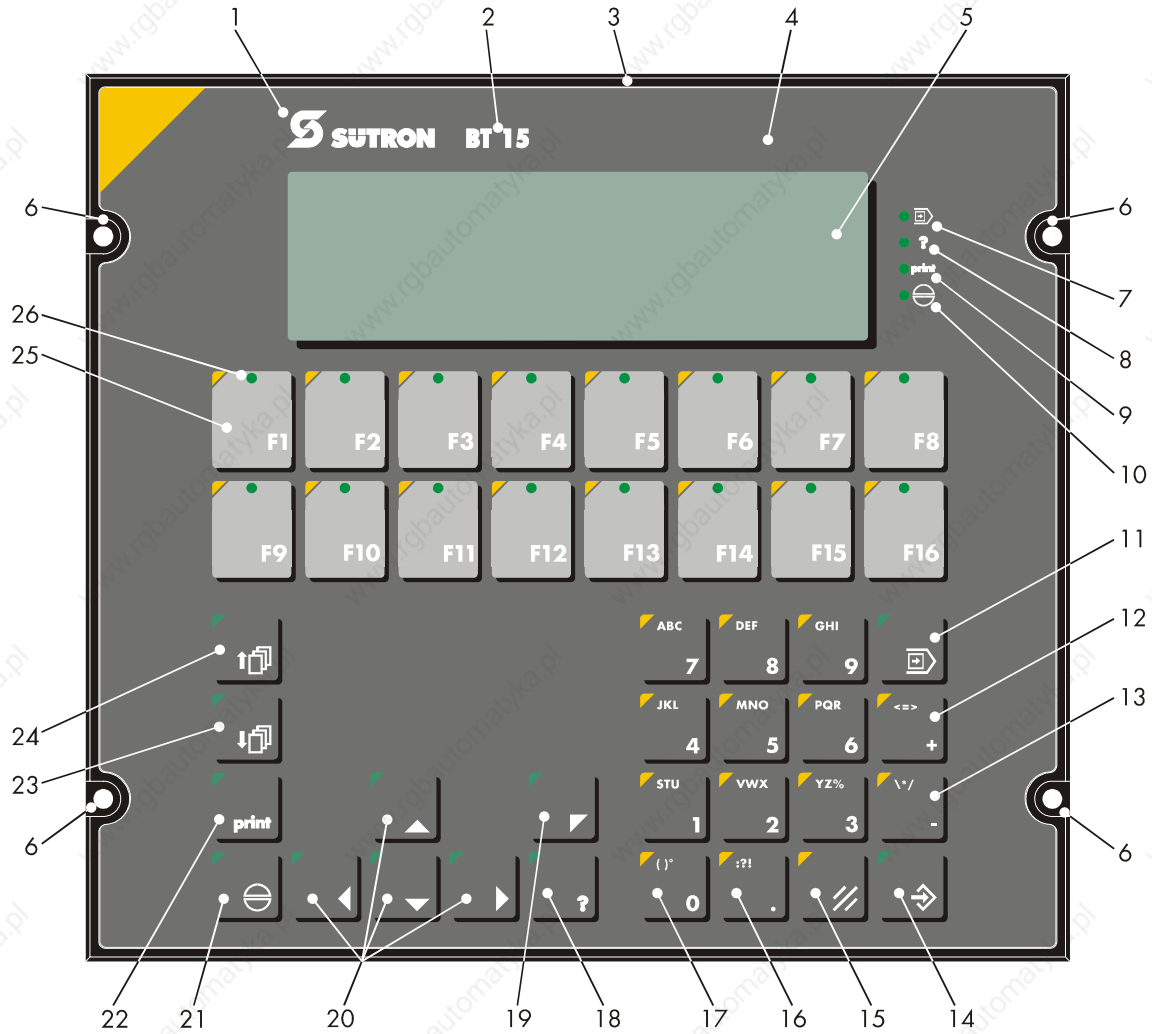

- | | | | |
|----|------------------------------|----|----------------------------------|
| 1 | Company Logo | 14 | Special Key Enter |
| 2 | Operating Terminal Type Logo | 15 | Special Key Clear |
| 3 | Front Panel | 16 | Editing Key Dot |
| 4 | Front Cover | 17 | Editing Keys 0 to 9, Alphabet |
| 5 | Filter Plate, Display Cutout | 18 | Special Key Help |
| 6 | Fastening Holes | 19 | Key Cursor Home |
| 7 | Status-LED Data Release | 20 | Key Cursor Right, Left, Up, Down |
| 8 | Status LED Help | 21 | Special Key Acknowledge |
| 9 | Status LED Print | 22 | Special Key Print |
| 10 | Status-LED Acknowledge | 23 | Control Key Page Down |
| 11 | Special Key Data Release | 24 | Control Key Page Up |
| 12 | Editing Key Plus | 25 | Function Keys F1 to F16 |
| 13 | Editing Key Minus | 26 | Status-LED Function Keys |

TesiMod BT15N

2.2 Keyboard

The **BT15N** supports all important key functions in spite of the small measures. The keyboard consists of membrane keys. The stroke distance is 0.3 mm and the key area is 16 x 16 mm. The key elements are covered by an embossed polyester foil against environmental influences. This combination allows a sensitive use of the keys. The Status LEDs illuminate green. The keyboard has a lifetime of 2 mill switching cycles.

In transparent mode, the keys supply a fixed start and stop code. In standard mode, the function of the keys is as defined by the user.

2.2.1 Editing Keys



Key: **0 and () °** is used to edit data within the editor. If the system variable **Shift** or **ShiftCase** is programmed, the characters (and) and ° can be entered.



Key: **1 and STU** is used to edit data within the editor. If the system variable **Shift** or **ShiftCase** is programmed, the characters S and T and U can be entered.



Key: **2 and VWX** is used to edit data within the editor. If the system variable **Shift** or **ShiftCase** is programmed, the characters V and W and X can be entered.



Key: **3 and YZ%** is used to edit data within the editor. If the system variable **Shift** or **ShiftCase** is programmed, the characters Y and Z and % can be entered.



Key: **4 and JKL** is used to edit data within the editor. If the system variable **Shift** or **ShiftCase** is programmed, the characters J and K and L can be entered.



Key: **5 and MNO** is used to edit data within the editor. If the system variable **Shift** or **ShiftCase** is programmed, the characters M and N and O can be entered.



Key: **6 and PQR** is used to edit data within the editor. If the system variable **Shift** or **ShiftCase** is programmed, the characters P and Q and R can be entered.



Key: **7 and ABC** is used to edit data within the editor. If the system variable **Shift** or **ShiftCase** is programmed, the characters A and B and C can be entered.



Key: **8 and DEF** is used to edit data within the editor. If the system variable **Shift** or **ShiftCase** is programmed, the characters D and E and F can be entered.

TesiMod BT15N



Key: **9 and GHI** is used to edit data within the editor. If the system variable **Shift** or **ShiftCase** is programmed, the characters G and H and I can be entered.



Key: **Decimal Point and :?!** is used to edit data within the editor. If the system variable **Shift** or **ShiftCase** is programmed, the characters : and ? and ! can be entered.



Key: **Minus and */** can be used to enter negative values within the editor. In the increment editor, the variable value is decremented by 1. When the key is held down, the function is repeated at a rate of repetition that is automatically increased. If the system variable **Shift** or **ShiftCase** is programmed, the characters \ and * and / can be entered.



Key: **Plus and <=>** can be used to enter positive values within the editor. In the increment editor, the variable value is incremented by 1. When the key is held down, the function is repeated at a rate of repetition that is automatically increased. If the system variable **Shift** or **ShiftCase** is programmed, the characters < and = and > can be entered.

2.2.2 Control Keys



Key: **Cursor left** can be programmed to directly select I/O masks. In the editor, it moves the cursor to the left.



Key: **Cursor right** can be programmed to directly select I/O masks. In the editor, it moves the cursor to the right.



Key: **Cursor up** can be programmed to directly select I/O masks. In the editor, it moves the cursor upwards.



Key: **Cursor down** can be programmed to directly select I/O masks. In the editor, it moves the cursor downwards.



Key: **Cursor home** can be programmed to directly select I/O masks. In the editor, it moves the cursor to the position of the first input variable.

TesiMod BT15N



Key: **Page up** is used to page through tables, recipes and messages. The functionality corresponds to the system variable “**TabPgUp**”. The key allows data contents towards the top of the table to be viewed.



Key: **Page down** is used to page through tables, recipes and messages. The functionality corresponds to the system variable “**TabPgDn**”. The key allows data contents towards the bottom of the table to be viewed.

2.2.3 Special Keys



Key: **Help key** always displays the current help text (online help). When the status-LED help flashes, it signals that an error message is pending. The error or system message is always displayed in plain-text.



Key: **Data Release** key is used to switch from a menu into the editor. The status-LED data release lights up when the editing mode is active. When the Data Release key is pressed within the editor, the editing mode is exited.



Key: **Enter** is used to conclude data entry. When pressed while in the startup mask, the key switches into the setup mask.



Key: **Clear** deletes the character beneath the cursor when it is used in an editor. Deletes the selected messages from the data memory.



Key: **Acknowledge** is used as an acknowledge key for the message system.



Key: **Print** can be used as a soft key to activate various print processes.

TesiMod BT15N

2.2.4 Function Keys

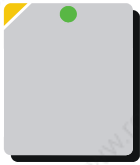

Function key F1 to F16 with integrated LEDs for functional feedback. The key functions can be freely assigned to a softkey functionality, either as direct access keys for menu control or to activate a function in the controller.

2.2.4.1 Function Key Arrangement

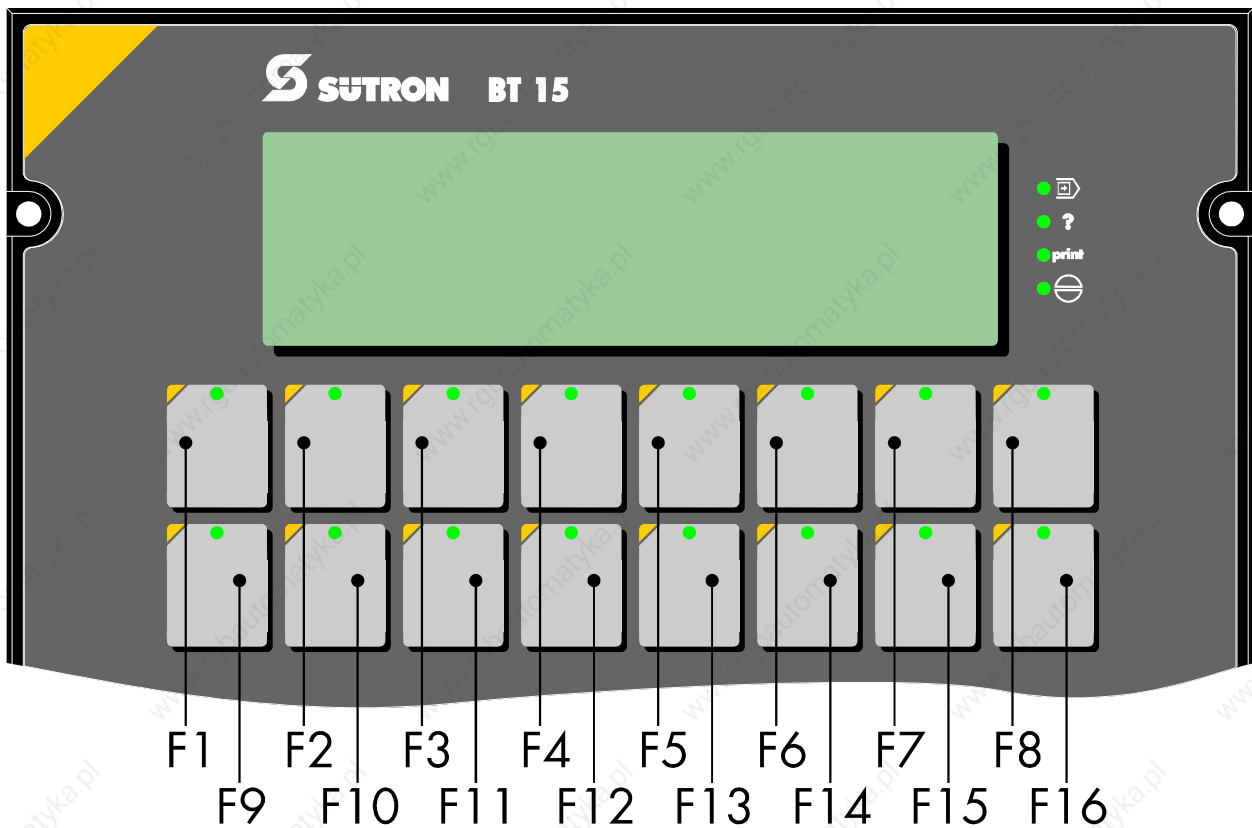

TesiMod BT15N

2.2.4.2 Slide-in Identification Strips for the Function Keys

The identification strips can be replaced after the terminal is dismantled. Inserting the strips from the rear of the front panel does not affect the tightness specified for the unit.

The unit is delivered with a set of identification strips.

The set consists of:

- two identification strips, labelled with F1 to F16
- two blank identification strips.

Various labelling methods are recommended, depending on the number of units involved.

Suitable labelling methods for:

Single units, prototypes:	labelling with an indelible pen
Small batch production:	transparency with laser printing
Large batch production:	custom specific printed identification strips

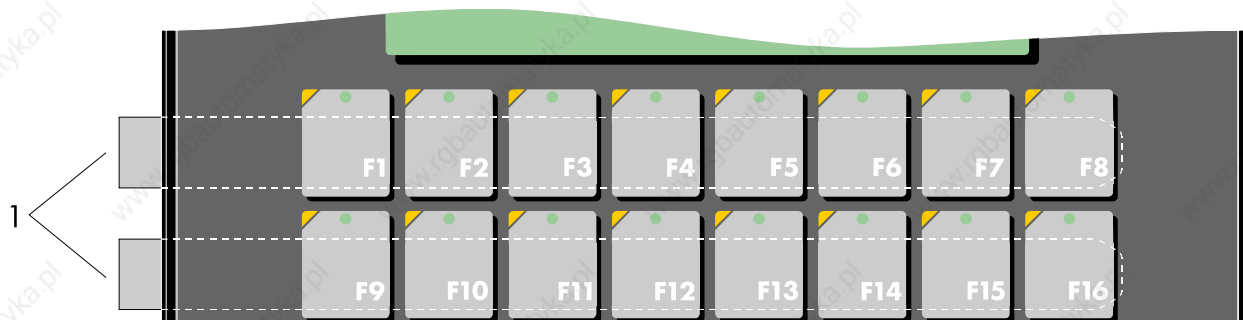

1 Position of identification strips



Labelled identification strips, standard



Blank identification strips

TesiMod BT15N

2.3 Rear View

2.3.1 Standard

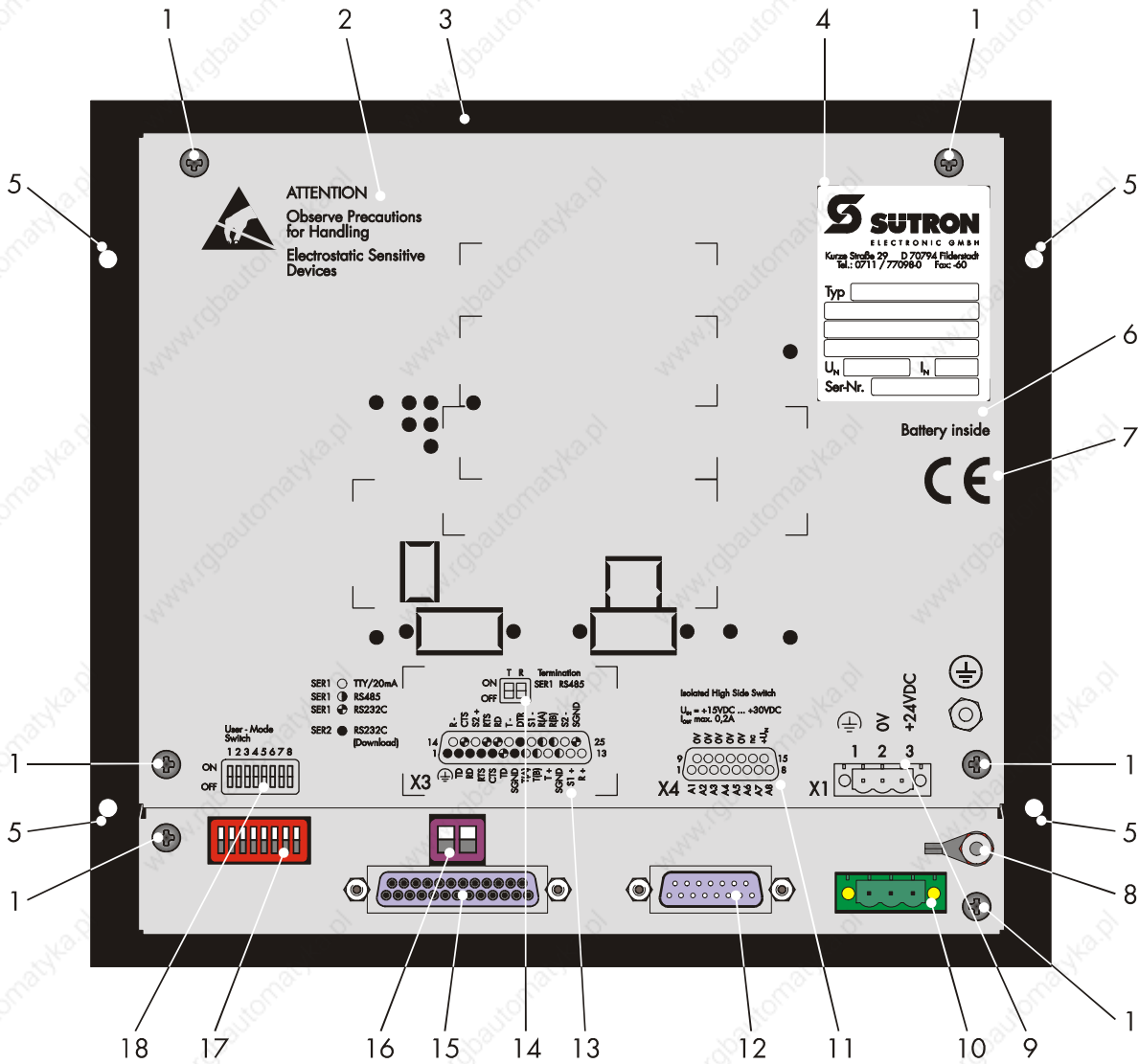

- | | | | |
|---|--|----|---|
| 1 | Fastening Screw for Enclosure | 11 | Pin Assignment Connector X4 (Parallel Outputs) |
| 2 | Warning | 12 | Connector X4 (Parallel Outputs) |
| 3 | Front Panel | 13 | Pin Assignment Female Connector X3 (TTY/RS485/RS232c) |
| 4 | Name Plate | 14 | Switch Positions of Terminator Switch |
| 5 | Mounting Holes | 15 | Female Connector X3 (TTY/RS485/RS232c) |
| 6 | Battery-related information | 16 | Terminator Switch (X3-SER1 RS485) |
| 7 | CE Mark | 17 | User-Mode Switch |
| 8 | Threaded Bolt for Protective Ground | 18 | Switch Positions of User-Mode Switch |
| 9 | Pin Assignment Connector X1 (Power Supply) | | |

TesiMod BT15N

2.3.2 InterBus

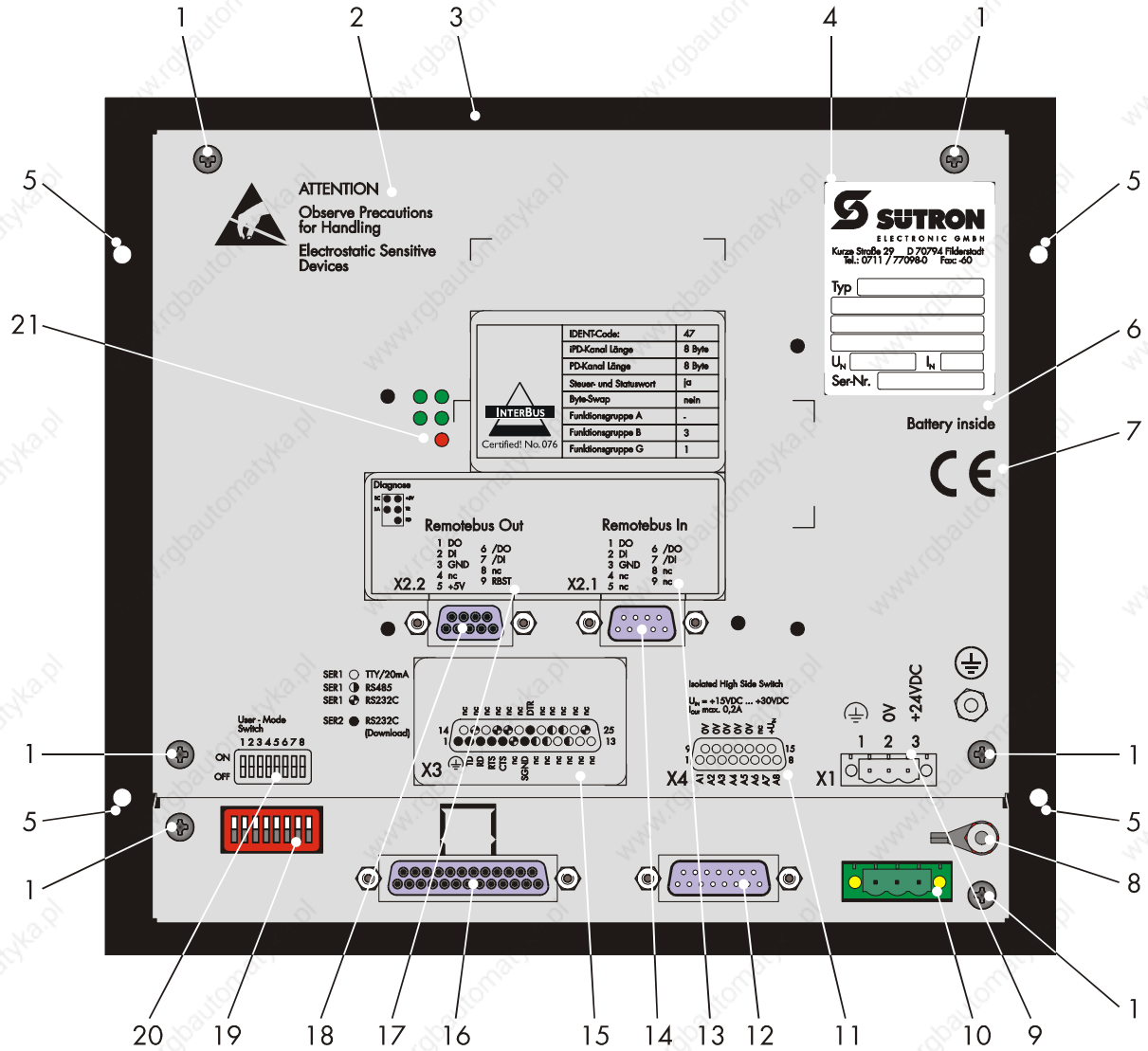

- | | | | |
|----|---------------------------------------|----|---------------------------------------|
| 1 | Fastening Screw for Enclosure | 12 | Outputs) |
| 2 | Warning | 13 | Connector X4 (Parallel Outputs) |
| 3 | Front Panel | 14 | Pin Assignment X2.1 (Remotebus In) |
| 4 | Name Plate | 15 | Male Connector X2.1 (Remotebus In) |
| 5 | Mounting Hole | 16 | Pin Assignment X3 (SER2-RS232c) |
| 6 | Battery-related Information | 17 | Female Connector X3 (SER2-RS232c) |
| 7 | CE Mark | 18 | Pin Assignment X2.2 (Remotebus Out) |
| 8 | Threaded Bolt for Protective Ground | 19 | Female Connector X2.2 (Remotebus Out) |
| 9 | Pin Assignment Connector X1 | 20 | User-Mode Switch |
| 10 | Connector X1 (Power Supply) | 21 | Switch Positions of User-Mode Switch |
| 11 | Pin Assignment Connector X4 (Parallel | | Diagnosis LEDs |

/001-9330/
BT15N_grau_eng_V10.3/00000AOKKO

TesiMod BT15N

2.3.3 SUCOnet K

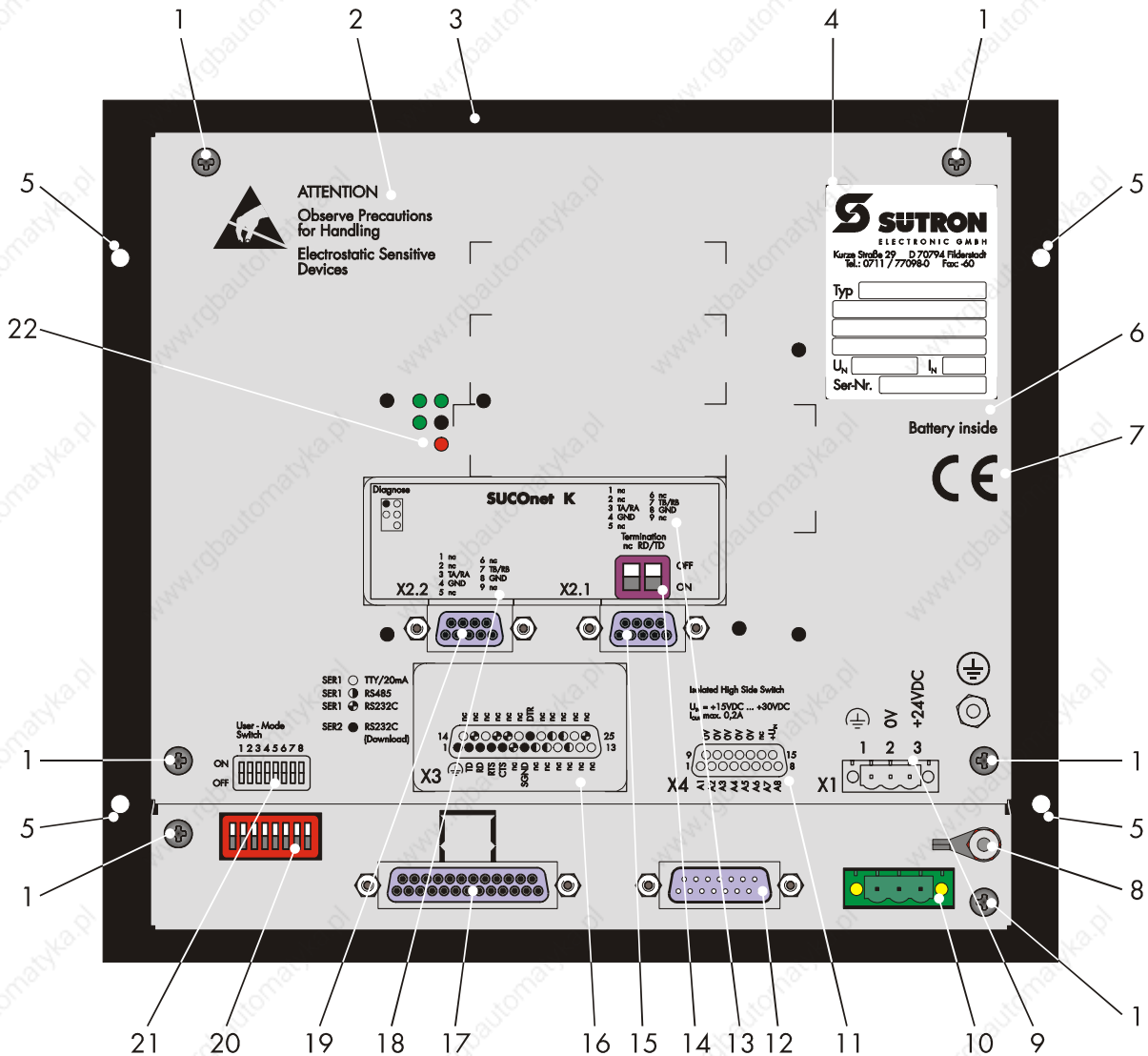

- | | | | |
|----|--|----|---------------------------------------|
| 1 | Fastening Screw for Enclosure | 12 | Connector X4 (Parallel Outputs) |
| 2 | Warning | 13 | Pin Assignment X2.1 (SUCOnet K) |
| 3 | Front Panel | 14 | Terminator Switch X2.1 (SUCOnet K) |
| 4 | Name Plate | 15 | Female Connector X2.1 (SUCOnet K) |
| 5 | Mounting Holes | 16 | Pin Assignment X3 (SER2-RS232c) |
| 6 | Battery-related Information | 17 | Female Connector X3 (SER2-RS232c) |
| 7 | CE Mark | 18 | Pin Assignment X2.2 (SUCOnet K) |
| 8 | Threaded Bolt for Protective Ground | 19 | Female Connector X2.2 (SUCOnet K) |
| 9 | Pin Assignment Connector X1 | 20 | User-Mode Switch |
| 10 | Connector X1 (Power Supply) | 21 | Switch Positions of User-Mode Switch |
| 11 | Pin Assignment Connector X4 (Parallel Outputs) | 22 | Diagnosis LED X2.1 / X2.2 (SUCOnet K) |

TesiMod BT15N

2.3.4 PROFIBUS-DP

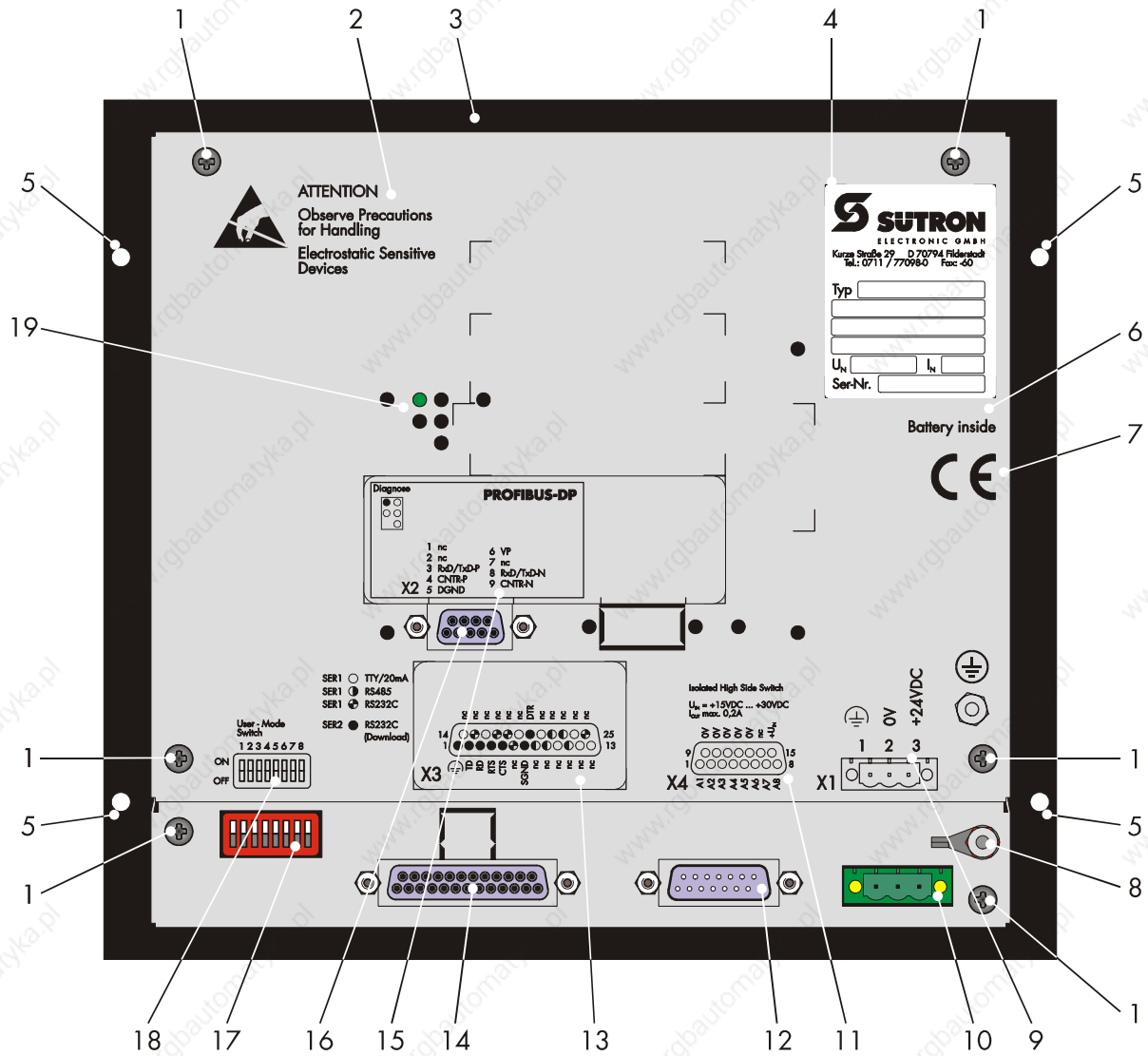

- | | | | |
|----|-------------------------------------|----|--|
| 1 | Fastening Screw for Enclosure | 11 | Pin Assignment Connector X4 (Parallel Outputs) |
| 2 | Warning | 12 | Connector X4 (Parallel Outputs) |
| 3 | Front Panel | 13 | Pin Assignment X3 (SER2-RS232c) |
| 4 | Name Plate | 14 | Female Connector X3 (SER2-RS232c) |
| 5 | Montagebohrungen | 15 | Pin Assignment X2 (PROFIBUS-DP) |
| 6 | Battery-related Information | 16 | Female Connector X2 (PROFIBUS-DP) |
| 7 | CE Mark | 17 | User-Mode Switch |
| 8 | Threaded Bolt for Protective Ground | 18 | Switch Positions of User-Mode Switch |
| 9 | Pin Assignment Connector X1 | 19 | Diagnosis LED |
| 10 | Connector X1 (Power Supply) | | |

/001-9330/
BT15N_grau_eng_V10.3/00000AOKK0

TesiMod BT15N

2.3.5 CAN-Bus

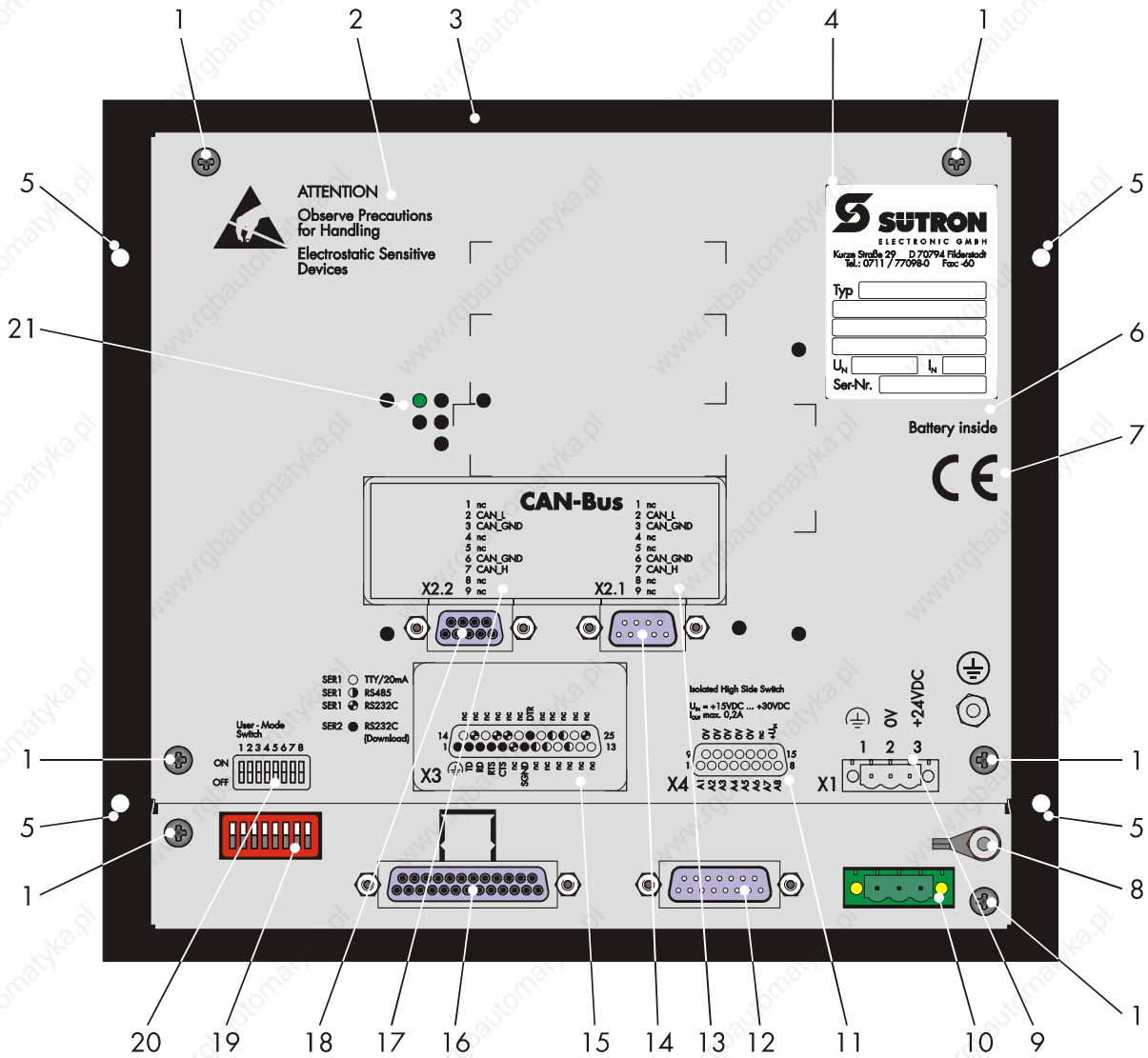

- | | | | |
|----|---------------------------------------|----|--------------------------------------|
| 1 | Fastening Screw for Enclosure | 12 | Outputs) |
| 2 | Warning | 13 | Pin Assignment X2.1 (CAN-Bus) |
| 3 | Front Panel | 14 | Male Connector X2.1 (CAN-Bus) |
| 4 | Name Plate | 15 | Pin Assignment X3 (SER2-RS232c) |
| 5 | Mounting Hole | 16 | Female Connector X3 (SER2-RS232c) |
| 6 | Battery-related Information | 17 | Pin Assignment X2.2 (CAN-Bus) |
| 7 | CE Mark | 18 | Female Connector X2.2 (CAN-Bus) |
| 8 | Threaded Bolt for Protective Ground | 19 | User-Mode Switch |
| 9 | Pin Assignment Connector X1 | 20 | Switch Positions of User-Mode Switch |
| 10 | Connector X1 (Power Supply) | 21 | Diagnosis LEDs |
| 11 | Pin Assignment Connector X4 (Parallel | | |

TesiMod BT15N

2.3.6 InterBus Optical Fibre

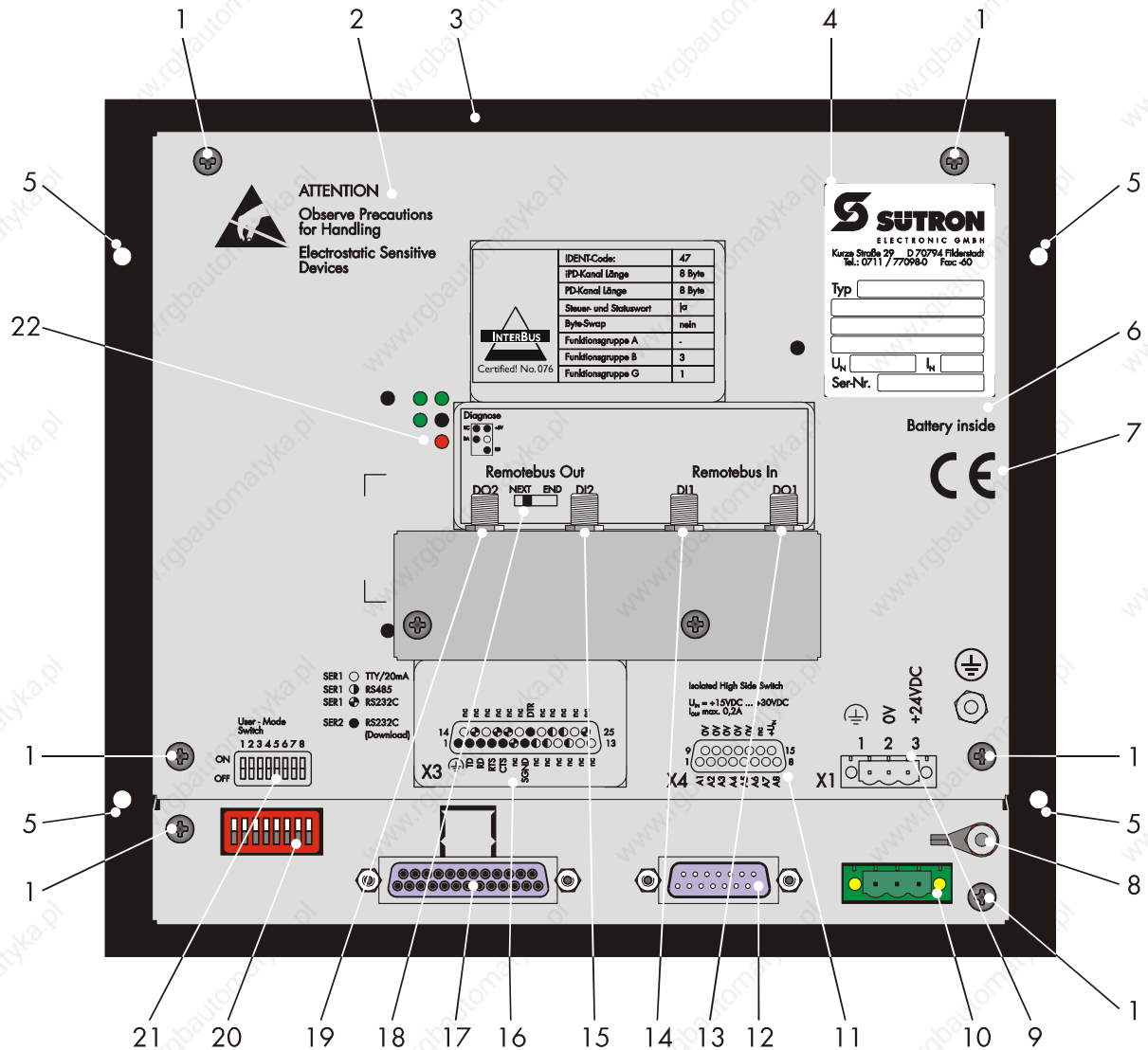

- 1 Fastening Screw for Enclosure
- 2 Warning
- 3 Front Panel
- 4 Name Plate
- 5 Mounting Hole
- 6 Battery-related Information
- 7 CE Mark
- 8 Threaded Bolt for Protective Ground
- 9 Pin Assignment Connector X1
- 10 Connector X1 (Power Supply)
- 11 Pin Assignment Connector X4 (Parallel Outputs)
- 12 Connector X4 (Parallel Outputs)
- 13 Fibre Optical DO1 (Remotebus In)
- 14 Fibre Optical DI1 (Remotebus In)
- 15 Fibre Optical DI2 (Remotebus Out)
- 16 Pin Assignment X3 (SER2-RS232c)
- 17 Female Connector X3 (SER2-RS232c)
- 18 Terminator Switch (InterBus)
- 19 Fibre Optical DO2 (Remotebus Out)
- 20 User-Mode Switch
- 21 Switch Positions of User-Mode Switch
- 22 Diagnosis LEDs

/001-9330/
BT15N_grau_eng_V10.3/00000A/Q/KO



TesiMod BT15N

2.4 Mounting the Terminal

The front panel mounting is suitable for easy and sealed installation in places where the rear side of the unit is not accessible. The unit is particularly suitable for mounting in enclosures.

The front panel permits sealed installation of the unit in accordance with the IP65 degree of protection (at the front). At the rear side of the front panel a circumferential sealing is attached.

All parts for mounting the unit are given with the spare parts set.

Special care needs to be taken during installation to maintain this high degree of protection. The unit is inserted from the front through the panel cutout and screwed to the mounting wall from the front. The seal must be positioned evenly and the fastening elements tightened uniformly.

When installing the terminal, keep a minimum space of 30 mm around the terminal for adequate air circulation.

The tightness between the front panel and the mounting surface depends on the care during installation.



Mounting and maintenance may only be performed by qualified and authorized personnel!

Front Panel Dimensions: 202.0 x 224.0 x 4.0 mm (H x W x D)

Panel Cutout: 188 x 204 mm (H x W)

TesiMod BT15N

2.4.1 Front Panel Dimensions

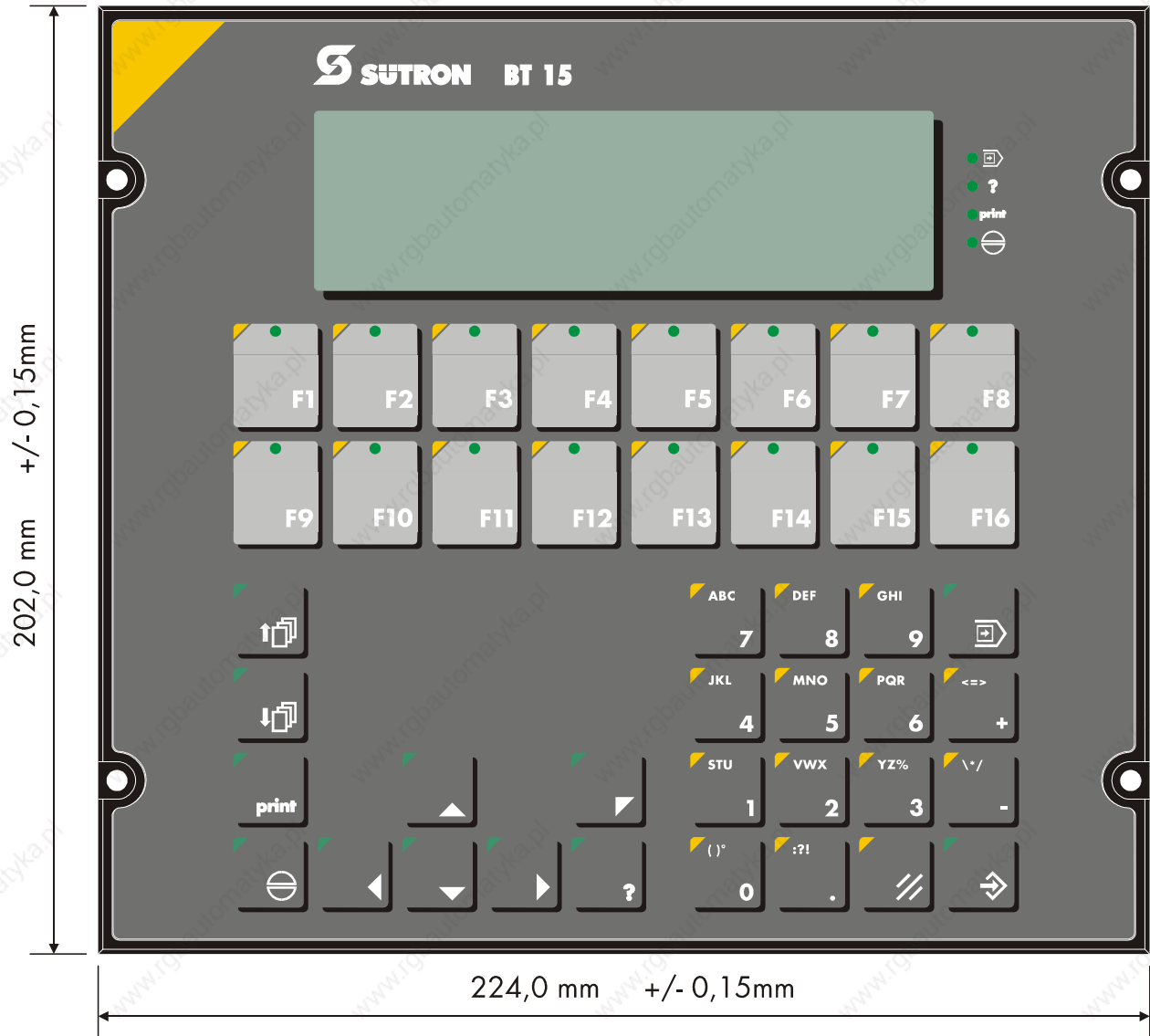

/001-9330/
BT15N_grau_eng_V10.300000A00K0

TesiMod BT15N

2.4.2 Side View, Mounting Depth

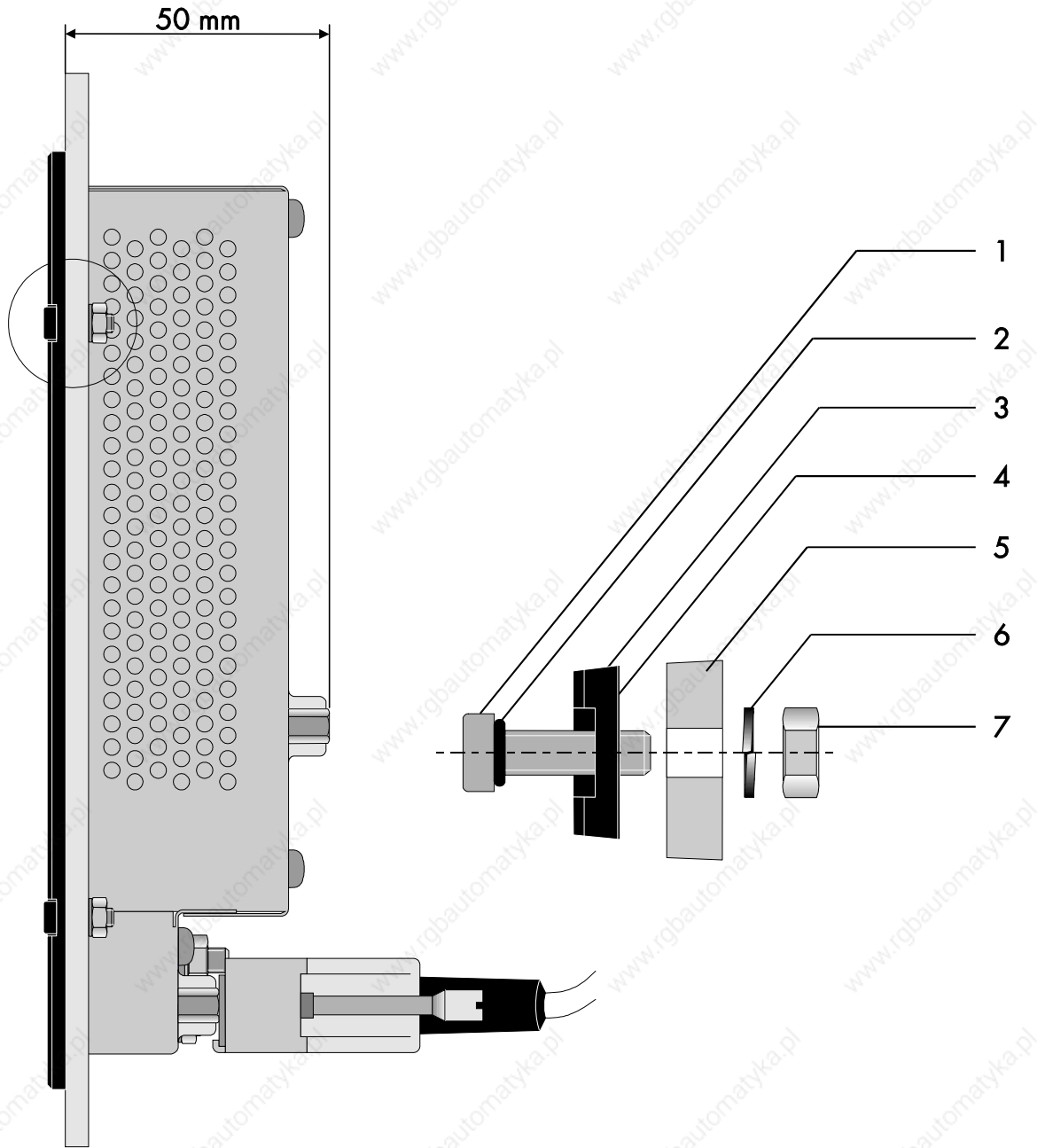

- 1 Cheese Head Screw M4 x 12 DIN7984
- 2 O-Ring 4.00 x 0.6 N70B
- 3 Front Panel
- 4 Circumferencial Sealing

- 5 Mounting Surface Thickness 1 to 10 mm
- 6 Spring Lock Washer B4 DIN127 Form B
- 7 Nut M4 DIN934

TesiMod BT15N

2.4.3 Panel Cutout

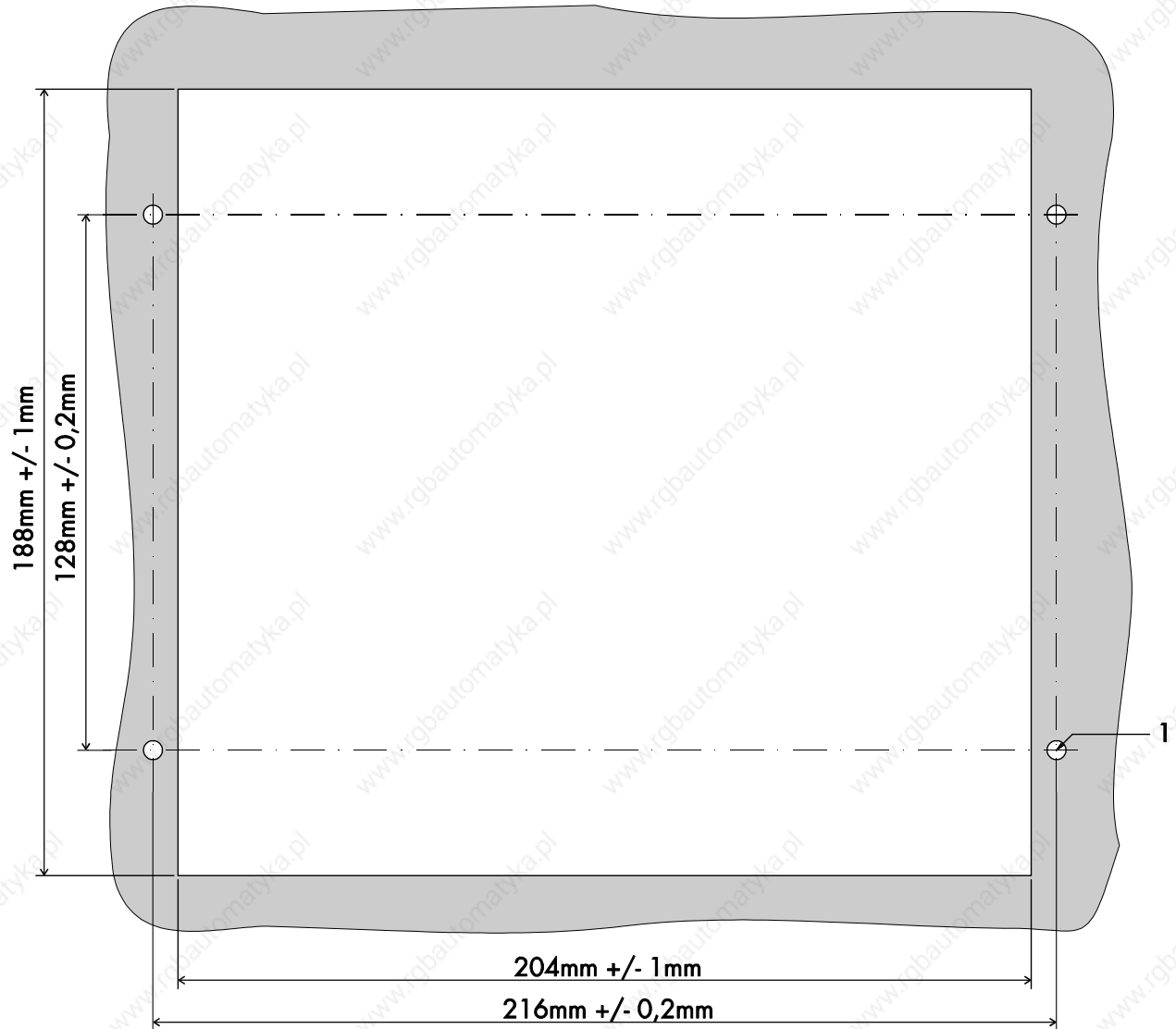

1 4 Holes with a Diameter of 4,5 mm, alternatively Threads M4

/001-9330/
BT15N_grau_eng_V10.300000AOKO

TesiMod BT15N

2.5 Pin Assignments

The operating terminal is fitted as standard terminal or as bus terminal:

The connector X3 combines several interface standards within one physical connector. The connector is divided into two channels. The channel for communication (SER1) is divided from the channel for upload/download/logging printer/scanner (SER2). The channels can operate independent of each other.

The channel of communication (SER1) can handle - specified by protocol - only one of the three interface standards.

Standard terminal:

Connector X1	24 VDC	Supply Voltage
Connector X3 SER1	TTY / 20 mA	Communication
Connector X3 SER1	RS232c	Communication
Connector X3 SER1	RS485	Communication
Connector X3 SER2	RS232c	Upload/Download/Logging Printer/Scanner
Connector X4	Parallel Outputs	Influencing Inputs of PLC

Bus terminal:

Connector X1	24 VDC	Supply Voltage
Connector X3 SER2	RS232c	Upload/Download/Logging Printer/Scanner
Connector X2.1 / X2.2	InterBus	Communication
Connector X2.1 / X2.2	SUCOnet K	Communication
Connector X2	PROFIBUS-DP	Communication
Connector X2.1 / X2.2	CAN-Bus	Communication
Connector DO1 / DI1 and DO2 / DI2	InterBus Optical Fibre	Communication
Connector X4	Parallel Outputs	Influencing Inputs of PLC

The parallel outputs are suitable for direct access on inputs of PLCs.

TesiMod BT15N

2.5.1 Pin Assignment X1 Supply Voltage

The supply voltage is connected via the connector X1.

The unit is equipped with a reverse voltage protection. If the poling is wrong, the unit doesn't operate.

This unit confirms to the safety class I. For safe operation it is necessary to use safety extra-low voltage (SELV) in accordance with DIN EN 61131 for the supply voltage.

Connector in the terminal: 3-pin male connector strip Phoenix COMBICON MSTBV 2,5/3-GF

Pin	Designation	Function
1		Signal Ground
2	0 V	Supply Voltage 0 V
3	24 VDC	Supply Voltage 24 VDC

The supply voltage is connected via a plug-in 3-pin female connector strip. The cable is secured in the female connector strip by means of screw terminals. Cables with fine wires with a cross-section of up to 2.5mm² can be used. The female connector strip is secured in position by means of a screw-type locking.

The female connector strip of the type **Phoenix COMBICON MSTB 2.5/3-STF** is supplied.



Hazardous voltages can exist inside electrical installations that can pose a danger to humans. Coming in contact with live parts may result in **electric shock!**



Please note with respect to pin assignment:

If shielded connecting cables are used for the supply voltage, the shield should be connected to pin 1.



Threaded bolt for protective grounding

A separate ground conductor must be provided for the ground screw in each case. The minimum cross-section of the ground conductor must be 1.5 mm² and the length as short as possible. Compliance with this information increases the operational safety.

TesiMod BT15N

2.5.2 Pin Assignment X2.1 / X2.2 InterBus

The unit can be fitted with the bus interfaces X2.1 and X2.2 for connection to the InterBus instead of the standard interfaces TTY / 20 mA and RS422 / RS485. The InterBus connection is certified under the number 076. The connectors are of the 9-pin Submin D female and male connector strip type.

Connector in the terminal: 9-pin SubminD male connector strip for **Remotebus In**

Assignment:

Pin	Designation	Function
1	DO	Data Out
2	DI	Data In
3	GND	Signal Ground
4	nc	not connected
5	nc	not connected
6	/DO	Data Out Reverse
7	/DI	Data In Reverse
8	nc	not connected
9	nc	not connected

Connector in the terminal: 9-pin SubminD female connector strip for **Remotebus Out**

Assignment:

Pin	Designation	Function
1	DO	Data Out
2	DI	Data In
3	GND	Signal Ground
4	nc	not connected
5	+5 V	Power Supply +5 VDC
6	/DO	Data Out Reverse
7	/DI	Data In Reverse
8	nc	not connected
9	RBST	Remote Bus Status

A shielded cable with twisted pairs (Cable type LiYCY-TP) is used. The maximum cable length depends on the usage within the InterBus topology.

TesiMod BT15N

2.5.3 Pin Assignment X2.1 / X2.2 SUCOnet K

To integrate the unit into a network topology of the SUCOnet K it can be equipped with the special interfaces for SUCOnet K instead of the standard interfaces TTY / 20 mA and RS422 / RS485. The connectors are 9-pin SubminD female and male connectors. The pinning of either connectors is identical.

Termination:

Activate the **termination** of the physically first (master) and last station in the network **at all times**. The termination of the stations located in between remains inactivated. To activate the termination, the termination switch RD/TD must be set to **ON**.

Connector in the operating terminal: 9-pin SubminD female/male connector strip

Pin	Designation	Function
1	nc	not connected
2	nc	not connected
3	TA/RA	Transmit- / Receive Channel A
4	GND	Signal Ground
5	nc	not connected
6	nc	not connected
7	TB/RB	Transmit- / Receive Channel B
8	GND	Signal Ground
9	nc	not connected

A shielded cable with twisted pair wires (cable type LiYCY-TP) must be used.

The maximum cable length depends on the data transmission rate that is used.

For a transmission rate of 187.5 kbps the maximum cable length is 600 m, for a transmission rate of 375 kbps a cable length of 300 m should not be exceeded. If longer cable length are required, repeaters must be used for signal conditioning. Self-controlled repeaters may be used for this process.

TesiMod BT15N

2.5.4 Pin Assignment X2 PROFIBUS-DP

To integrate the unit into a network of the PROFIBUS-DP it can be equipped with the special interface for PROFIBUS-DP connection instead of the standard interfaces TTY / 20 mA and RS422 / RS485. A 9-pin SubminD female connector strip is used as a connector.

Connector on the operating terminal: 9-pin SubminD female connector strip

Assignment:

Pin	Designation	Function
1	nc	not connected
2	nc	not connected
3	TB/RB	Transmit / Receive Data Plus
4	RTS	Request to Send
5	GND	Signal Ground
6	+5 V	Power Supply +5 VDC
7	nc	not connected
8	TA/RA	Transmit / Receive Data Minus
9	nc	not connected

Principally, all cable types specified in EN 50170 as cable type A can be used.

This allows the following cable lengths (depending on the baud rate):

Baud Rate (bps)	Cable Length (m)
9 600	1200
19 200	1200
93 750	1200
187 500	1000
500 000	400
1 500 000	200
12 000 000	100

TesiMod BT15N

2.5.5 Pin Assignment X2.1 / X2.2 CAN-Bus

To integrate the unit into a network topology of the CAN bus it can be equipped with the special interfaces X2.1 and X2.2 for CAN Bus. The CAN bus is stated as a high-speed-bus according to ISO-DIS 11898.

Connector: 9-pin SubminD male connector strip X2.1

Pin	Designation	Function
1	nc	not connected
2	CANL	CAN_L bus line (dominant LOW)
3	CAN_GND	CAN Ground
4	nc	not connected
5	nc	not connected
6	CAN_GND	CAN Ground
7	CANH	CAN_H bus line (dominant HIGH)
8	nc	not connected
9	nc	not connected.

Connector: 9-pin SubminD female connector strip X2.2

Pin	Bezeichnung	Funktion
1	nc	not connected
2	CANL	CAN_L bus line (dominant LOW)
3	CAN_GND	CAN Ground
4	nc	not connected
5	nc	not connected
6	CAN_GND	CAN Ground
7	CANH	CAN_H bus line (dominant HIGH)
8	nc	not connected
9	nc	not connected

All signals of X2.1 to X2.2 are interconnected. The connecting cable has to be connected to all pins including the reserved ones. The intention is, that there shall be no interruption of any of the wires in the bus cable, assuming a possible future specification of the use of the reserved pins.

A shielded cable with twisted pair wires (cabe type LiYCY-TP) must be used. The CAN bus must be terminated with resistors on both ends of the cable structure.

TesiMod BT15N

2.5.6 Pin Assignment InterBus Optical Fibre

To integrate the unit into a network topology of the InterBus optical fibre device net it can be equipped with the special interfaces for InterBus Optical Fibre.
The optical fibre interface is stated as F-SMA type 905.

The connectors for the optical fibres are
DO1 and DI1 for Remotebus In and
DO2 and DI2 for Remotebus Out.

The connection must conform to „Technical Guideline For Optical Transmission“.

For the optical transmission a dielectrical fibre with refractive index profile, likely a polymer fibre with a diameter of 980 μm of the core and 1000 μm of the coating. The connector of the type F-SMA is according to the specifications of IEC 874-2 respectively DIN 47258.

The permitted distance between two subscribers of the optical fibre device bus is 1 through 5 m.



Infrared light can **damage the retina of the eye!** Never look into the open end of the optical fibre! Secure the open ends of the optical fibres and the plugs with caps!
Always wear safety glasses!



The transmitter and receiver units may get unusable by dirt. For transportation, storage and when a unit is not in use, place caps on the plug terminals.

TesiMod BT15N

2.5.7 Pin Assignment X3 SER1 TTY / 20 mA Current Loop

TTY / 20 mA current loop, passive

Pin	Designation	Channel	Function
10	T+	SER1	Transmit Data, Positive Polarity
13	R+	SER1	Receive Data, Positive Polarity
14	R-	SER1	Receive Data, Negative Polarity
19	T-	SER1	Transmit Data, Negative Polarity

TTY / 20 mA current loop, active

Pin	Designation	Channel	Function
10	T+	SER1	Transmit Data, Positive Polarity
12	S1+	SER1	Power Source 2, Positive Polarity
13	R+	SER1	Receive Data, Positive Polarity
14	R-	SER1	Receive Data, Negative Polarity
16	S2+	SER1	Power Source 1, Positive Polarity
19	T-	SER1	Transmit Data, Negative Polarity
21	S1-	SER1	Power Sink 1, Negative Polarity
24	S2-	SER1	Power Sink 2, Negative Polarity

Termination:

When using the channel SER1 as current loop the terminator switches for RS485 must be switched OFF!

The interface can be connected as either an active or passive current loop depending on the wiring. The transmit line and the receive line are provided with separate 20mA power sources. The compliance voltage is approximately 24 VDC.

The maximum baud rate is 19200Bd. The maximum cable length depends on the baud rate and rate of transmission errors.

For longer cable lengths, the 20mA power supply should be fed by the transmitting unit. This can decrease crosstalk on the signal lines considerably.

In idle state (signal logical 1) a current loop of 20 mA can be measured on the cable.

Signal logical 1	-	Current flow 20mA
Signal logical 0	-	Current flow is interrupted

A shielded cable with twisted pair wires (cable type LiYCY-TP) and a minimum cross section of 0.08 mm² must be used. The maximum cable length is 100 m.



Connect the cable shield to the metal hoods of the connectors over as large a surface as possible! Please refer to appendix A.

TesiMod BT15N

2.5.8 Pin Assignment X3 SER1 RS485

The interface RS485 is suitable for point-to-point connections and multipoint connections.

Termination for point-to-point connection:

For operation with point-to-point connection the **termination** must always be activated.

Termination for multipoint connection:

For operation with multipoint connections only the **termination** at the cable end must be activated.

The signals of the interface are electrically isolated.

The configuration of the hardware can be adapted to different systems. The associated wires are marked with "A" and "B". Some descriptions refer to the pins with "+" and "-", where the following applies: A = + and B = -. The voltage levels comply with the standards and are defined as follows:

Signal logical 1 - $U_A - U_B \leq -0.3 \text{ V}$ i.e. ($U_A < U_B$)
Signal logical 0 - $U_A - U_B \geq +0.3 \text{ V}$ i.e. ($U_A > U_B$)

Pin	Designation	Channel	Function
8	T(A)	SER1	Transmit Data Channel A
9	T(B)	SER1	Transmit Data Channel B
11	SGND	SER1	Signal Ground
22	RD(A)	SER1	Receive Data Channel A
23	RD(B)	SER1	Receive Data Channel B

A shielded cable with twisted pair wires (cable type LiYCY-TP) and a minimum cross section of 0.34 mm² (for 400 m) must be used. The maximum cable length is 400 m.



Connect the cable shield to the metal hoods of the connectors over as large a surface as possible! Please refer to appendix A.

TesiMod BT15N

2.5.9 Pin Assignment X3 SER1 RS232c

Interface for communication with controller.

Pin	Designation	Channel	Function
6	TD	SER1	Transmit Data
15	CTS	SER1	Clear To Send
17	RTS	SER1	Request To Send
18	RD	SER1	Receive Data
25	SGND	SER1	Signal Ground

A shielded cable with stranding in layers (cable type LiYCY) and with a minimum cross-section of 0.25 mm² must be used. The maximum cable length is 15 m.



Connect the cable shield to the metal hoods of the connectors over as large a surface as possible! Please refer to appendix A.

2.5.10 Pin Assignment X3 SER2 RS232c

Interface for download, upload, logging printer and scanner.

Pin	Designation	Channel	Function
1		SER2	Low-noise Earth
2	TD	SER2	Transmit Data
3	RD	SER2	Receive Data
4	RTS	SER2	Request to Send
5	CTS	SER2	Clear To Send
7	SGND	SER2	Signal Ground
20	DTR	SER2	Data Terminal Ready

A shielded cable with stranding in layers (cable type LiYCY) and with a minimum cross-section of 0.25 mm² must be used. The maximum cable length is 15 m.



Connect the cable shield to the metal hoods of the connectors over as large a surface as possible! Please refer to appendix A.

TesiMod BT15N

2.5.11 Pin Assignment X4 Parallel Outputs

Open-collector-outputs, which switch the positive potential, are used as parallel outputs. These outputs are suitable for direct control of PLC inputs. The outputs can be activated by means of function keys or the controller. The assignment of these functions is carried out in the programming software. The parallel outputs are designed for use in standard mode only.

Technical Data:

Input voltage	15 through 30 VDC
Output Current	max. 0.2 A for each output
Delay	30 to 50 ms

The outputs are short-circuit-proof!

The voltage supply must be provided externally. Pins 9 through 13 for the negative potential are connected internally.

Connector in the operating terminal: 15-pin SubminD male connector strip

Pin	Designation	Function
1	A1	Output 1
2	A2	Output 2
3	A3	Output 3
4	A4	Output 4
5	A5	Output 5
6	A6	Output 6
7	A7	Output 7
8	A8	Output 8
9	0V	Negative Potential
10	0V	Negative Potential
11	0V	Negative Potential
12	0V	Negative Potential
13	0V	Negative Potential
14	nc	Not Connected
15	+24 V	Positive Potential

2.6 Shielding

The shield must be connected to the metal hoods of the connector housings at both ends and over as large a surface as possible. It should be noted that a potential equalization line with a minimum cross-section equal to 10 times that of the shield may be necessary as a result of the grounding on both sides.

TesiMod BT15N

2.7 Display

The display in the **BT15N** consists of a backlit LCD module with full graphics capability. The display is capable of simultaneously displaying up to 320 characters of the normal font. The characters of the normal font are displayed by a matrix of 5 x 7 dots and with a height of 3.5 mm. The format allows 8 lines with 40 characters each to be displayed. The drift of contrast of the display is compensated over the full temperature range. The operating terminal has an optimum viewing angle of approximately 90°.

In the operating mode standard mode the default contrast can be adjusted at operating time by means of a system variable.

The display is capable of displaying either the extended ASCII character set (semi graphics) with the font normal and zoom, and of displaying full graphics.

Overview of the Display of the BT15N:

Type:	LCD Module
Resolution:	240 x 64 Dots
Backlight:	LED
Lifetime LCD:	100000 h
Lifetime Backlight:	100000 h
Lines (Font Normal):	8
Characters/Line (Font Normal):	40
Dot Size:	0.49 mm x 0.49 mm
Gap Size:	0.04 mm
Dot Colour:	Black
Character of Font Normal:	6 x 8 Dots
Character of Font Zoom:	12 x 16 Dots
Background Colour:	Yellow-Green
Visible Front Cutout (H x W):	40.4 mm x 134.0 mm



If the display is damaged, do not swallow or breathe in the liquids or gases being emitted and avoid direct contact with skin.

Danger of Poisoning! Could Result in Burns!

TesiMod BT15N

2.7.1 Display Contrast Setting

The contrast for the display can be adjusted by means of the software. This requires the system variable **LCDContrast** to be set up in an I/O mask of the application. The value can then be modified using any editor that can handle integer numbers.

The limit values for the brightness must be set to

Lower level: -40
Upper level: +75

If this variable is not defined in the menus or the value is out of the range of values, the default setting (value 25) will be loaded when the system is initialized.

The system variable can be stated in any I/O-mask of the application!

2.7.2 Default Contrast Setting

If the contrast of the display should be such that the masks are no longer legible, the default contrast setting can be restored using the user mode switch.

Position of the switch to restore the contrast:

S1 ON
S2 OFF
S3 OFF
S4 ON

This switch position coincides with “activating download by hardware”. The contrast will be reset before the warning is displayed. The warning will be displayed in a legible manner.

How to setup the default contrast:

- Switch off the operating terminal
- Set the DIP-switches to the above described switch positions
- Switch on the operating terminal
- Upon display of a warning, switch off the operating terminal
- Set the switch S4 to the OFF-position
- Switch on the terminal again.

The application description is not lost.

2.7.3 Character Attributes

By preselecting an attribute, any characters can be displayed as follows:

- normal
- flashing
- underlined
- inverse

and in any combination.

TesiMod BT15N

2.7.4 Font Normal



2.7.5 Font Zoom

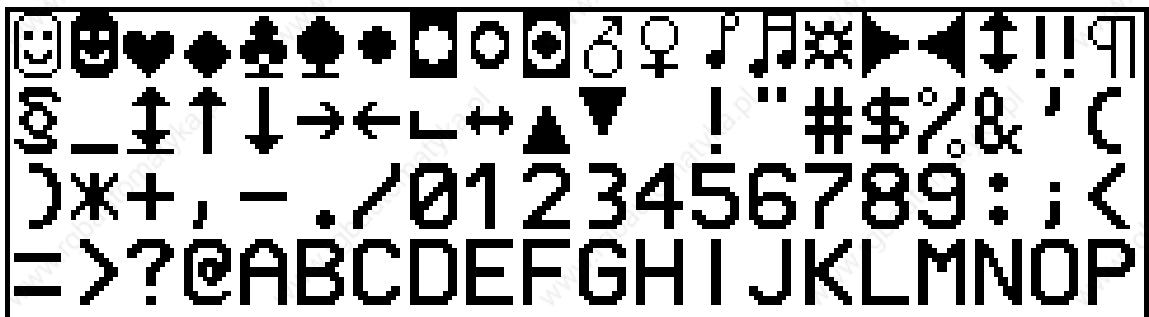

TesiMod BT15N

2.7.6 ASCII Character Set Table

000		032		064	@	096	`	128	Ç	160	á	192	Ł	224	α
001	☺	033	!	065	A	097	a	129	ü	161	í	193	ł	225	β
002	☹	034	"	066	B	098	b	130	é	162	ó	194	Ł	226	Γ
003	♥	035	#	067	C	099	c	131	â	163	ú	195	ł	227	Π
004	♦	036	\$	068	D	100	d	132	ä	164	ñ	196	ł	228	Σ
005	♣	037	%	069	E	101	e	133	à	165	ñ	197	ł	229	σ
006	♠	038	&	070	F	102	f	134	å	166	º	198	ł	230	μ
007	•	039	'	071	G	103	g	135	ç	167	º	199	ł	231	τ
008	■	040	<	072	H	104	h	136	ê	168	¿	200	ł	232	ϑ
009	○	041	>	073	I	105	i	137	ë	169	ƒ	201	ł	233	θ
010	□	042	*	074	J	106	j	138	è	170	ƒ	202	ł	234	Ω
011	♂	043	+	075	K	107	k	139	ï	171	½	203	ł	235	δ
012	♀	044	,	076	L	108	l	140	î	172	¾	204	ł	236	ω
013	♪	045	-	077	M	109	m	141	ì	173	¿	205	ł	237	ø
014	♫	046	.	078	N	110	n	142	ä	174	«	206	ł	238	€
015	✱	047	/	079	O	111	o	143	å	175	»	207	ł	239	π
016	▶	048	0	080	P	112	p	144	é	176	▩	208	ł	240	≡
017	◀	049	1	081	Q	113	q	145	æ	177	▩	209	ł	241	±
018	↕	050	2	082	R	114	r	146	œ	178	▩	210	ł	242	≥
019	!!	051	3	083	S	115	s	147	ô	179		211	ł	243	≤
020	¶	052	4	084	T	116	t	148	ö	180		212	ł	244	ƒ
021	§	053	5	085	U	117	u	149	ò	181		213	ł	245	J
022	■	054	6	086	U	118	v	150	û	182		214	ł	246	÷
023	±	055	7	087	W	119	w	151	ù	183		215	ł	247	≈
024	↑	056	8	088	X	120	x	152	ÿ	184		216	ł	248	°
025	↓	057	9	089	Y	121	y	153	ÿ	185		217	ł	249	·
026	→	058	:	090	Z	122	z	154	Ü	186		218	ł	250	·
027	←	059	;	091	[123	<	155	ç	187		219	ł	251	√
028	└	060	<	092	\	124	!	156	£	188		220	ł	252	n
029	↕	061	=	093]	125	>	157	¥	189		221	ł	253	z
030	▲	062	>	094	^	126	~	158	℞	190		222	ł	254	
031	▼	063	?	095	_	127	Δ	159	ƒ	191		223	ł	255	

TesiMod BT15N

2.8 User-Mode Switch

The user-mode switch is placed at the rear side of the unit. The switch levers can be accessed by using a pen or a small screwdriver.

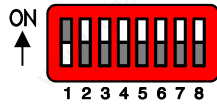

The switches S5 to S8 can be used by the user as needed. The switch positions are stored at initialization time and afterwards they can be overtaken to the controller.

Legend of above table:

I = Switch position ON

S1	S2	S3	S4	S5	S6	S7	S8	Function
I	X	-	-	X	X	X	X	Standard-Mode with SPS (delivery state)
I	X	I	-	X	X	X	X	Standard-Mode without SPS
-	I	-	-	X	X	X	X	Transparent-Mode with start and stop code of the keys
-	-	-	I	X	X	X	X	Transparent-Mode without stop code of the keys
I	-	-	I	X	X	X	X	Activate download (deletes application memory) und default contrast setting

- = Switch position OFF

X = Switch position irrelevant

TesiMod BT15N

2.9 Battery

A built-in lithium battery buffers the data in the CMOS-RAM and also supplies the real-time clock with power. The battery provides a minimum life of 5 years, even under unfavourable operating conditions. If the battery is drained the system message „change battery“ is generated.

We recommend to replace the battery every 4 years while performing the regular maintenance.

A new battery is supported by Sutron electronic or the sales representative of your country.

If the system message „change battery“ would not be recognized in due, eg the real time clock is interrupted or displays a wrong time, a loss of data in the CMOS-RAM can be expected. In this case you must check all alterable data like passwords, parameters in the system variables, data sets of recipes and the entries of the message system after replacing the battery.

Replacing the battery:

The battery can be replaced while the operating voltage is connected to ensure that the message data and time setting are not lost. Mind the safety instructions!

- Remove the mounting bolts of the connectors
- Remove the fastening screws of the enclosure and remove the enclosure
- Replace the cable fastener, which is used to hold the battery
- Plug off the connector of the battery cable and replace the battery
- Plug on the connector of the new battery
- Place the new battery onto the plastic carrier on the printed circuit board and fasten it with a new cable fastener
- Place the enclosure on the rear side of the unit
- At first fasten the bolts of the interface connectors and at last fasten the screws of the enclosure properly

Changing the battery may only be performed by qualified and authorized personnel!

Sewage and refuse disposal:

Dispose only drained batteries into the collection box of the community or of the local dealer. The battery is stated as drained when the message „change battery“ appears on the display of the appliance.

To prevent short circuitry in the collection boxes insulate the poles of each battery with insulation tape or put each single battery into a plastic bag.



Do not put lithium batteries in fire or heat them above 100° C and do not recharge them. **Danger of Explosion!**



Do not open lithium batteries. **Danger of Poisoning!**



Hazardous voltages can exist inside electrical installations that can pose a danger to humans. Coming in contact with live parts may result in **electric shock!**



Electrostatic discharges can damage electronic components! ESD protective measures must be observed!

TesiMod BT15N

2.10 Fuse

A semiconductor fuse is used to prevent damage to the operating terminal. Once the fuse has been activated, the device must be disconnected from the supply voltage to allow the semiconductor fuse to regenerate. With an ambient temperature of 20 °C, the regeneration takes about 20 seconds. The higher the ambient temperature, the longer the regeneration period. The semiconductor fuse is not designed to be replaced.

2.11 Application Memory

The unit is equipped with either a 256 KByte or 768 KByte flash memory an application memory. After switching on the unit the size of the application memory is displayed. This memory area is available to store the user application, the loadable protocol driver, the fonts and the recipe data.

TesiMod BT15N

3 Technical Data

Keyboard	<p>a Total of 42 Keys, Membrane Keys with Tactile Feedback, 2 Million Switch Cycles Divided into</p> <ul style="list-style-type: none"> 7 Control Keys 16 Function Keys with LED and Slide-in Identification Strips 2 Special Key without LED 4 Special Keys with LED 13 Editing Keys 												
Display	<p>Backlit LCD Module with full Graphics Capability, 8 Lines with 40 Characters Each, Character Size 3.5 mm, Display Area 40.4 x 134.0 mm (H x W) Lifetime LCD: 100000 h Lifetime Backlight: 100000 h</p>												
Display Screen	Glare Suppression for Increased Contrast												
Interface X3	<p>Variable Baud Rates and Data Formats</p> <table border="0"> <tr> <td>SER1 TTY/20 mA</td> <td>Communication</td> </tr> <tr> <td>SER1 RS485</td> <td>Communication</td> </tr> <tr> <td>SER1 RS232c</td> <td>Communication</td> </tr> <tr> <td>SER2 RS232c, not galvanical isolated</td> <td>Download/Upload/Scanner/ Logging Printer</td> </tr> </table>	SER1 TTY/20 mA	Communication	SER1 RS485	Communication	SER1 RS232c	Communication	SER2 RS232c, not galvanical isolated	Download/Upload/Scanner/ Logging Printer				
SER1 TTY/20 mA	Communication												
SER1 RS485	Communication												
SER1 RS232c	Communication												
SER2 RS232c, not galvanical isolated	Download/Upload/Scanner/ Logging Printer												
Interface X4	8 Parallel Outputs 24 VDC / 0.2 A, Short Circuit Proof												
Options	<table border="0"> <tr> <td>X2.1/X2.2 InterBus</td> <td>Communication</td> </tr> <tr> <td>X2.1/X2.2 SUCOnet K</td> <td>Communication</td> </tr> <tr> <td>X2 PROFIBUS-DP</td> <td>Communication</td> </tr> <tr> <td>X2.1/X2.2 CAN-Bus</td> <td>Communication</td> </tr> <tr> <td>DO1/DI1/ InterBus</td> <td></td> </tr> <tr> <td>DO2/DI2 Optical Fibre</td> <td>Communication</td> </tr> </table>	X2.1/X2.2 InterBus	Communication	X2.1/X2.2 SUCOnet K	Communication	X2 PROFIBUS-DP	Communication	X2.1/X2.2 CAN-Bus	Communication	DO1/DI1/ InterBus		DO2/DI2 Optical Fibre	Communication
X2.1/X2.2 InterBus	Communication												
X2.1/X2.2 SUCOnet K	Communication												
X2 PROFIBUS-DP	Communication												
X2.1/X2.2 CAN-Bus	Communication												
DO1/DI1/ InterBus													
DO2/DI2 Optical Fibre	Communication												
Protocolls Standard	<p>ABB CS31 ABB T200 AEG KS-Functions AEG Modbus Allen Bradley Bosch BUEP19/BUEP19E DIN-Meßbus Slave, DIN-Meßbus Gateway GE Fanuc SNP IDEC Micro3 Jetter PASE / PCOM5 Mitsubishi FX-Series and A-Series Moeller SUCOM 1 (PS306/316) Moeller SUCOM 1 (PS4-201)</p>												

TesiMod BT15N

	OMRON Host-Link OMRON NT-Link Siemens SINEC L1 Master Link Siemens 3964R/RK512 Siemens S5 PG (AS511) Siemens S7 PPI Siemens S7 MPI (HMI-Host Adaptor)
Protocols Field Bus	CAN/CANopen InterBus LON Moeller SUCOnet K PROFIBUS-DP Siemens S7 MPI
Central Unit	TMPZ84C015, 10 MHz, Watchdog Timer, Real-Time Clock, Programmable Interface Parameters, Temperature Compensation of the Display, Adjustment of Contrast, Battery Monitoring, User Mode Switch
Memory	256 / 768 KByte Flash Memory, Application Memory 256 KByte Flash Memory, Firmware 128 KByte stat. CMOS-RAM, Battery-Backed
Connection System	Plug-in Type, via SubminD Female/Male Connector Strip
Supply Voltage	24 V Direct Voltage, Residual Ripple Max. 10%, SELV in accordance to DIN EN 61131 Minimum Voltage 19.2 V Maximum Voltage 30.2 V Typ. Power Consumption <0.4 A Peak Current (10 ms) <0.6 A
Connected Load	~10 W
Fuse	Semiconductor Fuse
Reverse Voltage Protection	Protection Diode

TesiMod BT15N

Noise Immunity	EC Electromagnetic Compatibility Directive 89/336/EEC EN 50081-1 Table A1 EN 50082-2 EN 55011 Limit Class B EN 55022 EN 61000-4-2 EN 61000-4-3 EN 61000-4-4 EN 61000-4-5 EN 61000-4-6
Environmental Test	Operating Temperature 0°C to 50°C Storage Temperature -25°C to 70°C Relative Humidity for: Operation max. 75% annual average Storage max. 75% annual average Non-condensing
Degrees of Protection	EN 60529 Mechanical Degrees of Protection Front: IP65 Rear: IP20
Front Panel	Aluminium, Black Anodized with Affixed Polyester Cover, Circumferential Rubber Sealing at Rear Side of Front Panel. 202.0 x 224.0 x 4.0 mm (H x W x D)
Panel Cutout	188 x 204 mm (H x W)
Mounting Depth	50 mm without Connector (approx. 90 mm with connector)
Enclosure	Zinc-Coated Steel Plate
Total Weight	Approx. 1500 g

TesiMod BT15N

4 Declaration of Conformity

EG - Konformitätserklärung

Seriennummer : BT15N/151xxx

Dokument - Nr./
Monat. Jahr : CE-BT15N.151_1/11.1998

Der Unterzeichner, der den nachstehenden Hersteller vertritt

Hersteller :		
Anschrift :	SÜTRON ELECTRONIC GMBH Kurze Straße 29 D-70794 Filderstadt (Bonlanden)	Telefon 0711/77098-0 Telefax 0711/77098-60

oder der den vom Hersteller nachstehend benannten Bevollmächtigten vertritt, der innerhalb der Gemeinschaft (oder des EWR) niedergelassen ist (falls zutreffend)

Bevollmächtigter:	Siegfried Buck	
Anschrift:	Kurze Straße 29	D-70794 Filderstadt

erklärt hiermit, daß das Produkt

Produktkennzeichnung :	Tesimod Bedienterminal BT15N/151xxx
------------------------	-------------------------------------

in Übereinstimmung mit den Bestimmungen der nachstehenden EG-Richtlinie(n) (einschließlich aller zutreffenden Änderungen)

Referenz-Nr.	89 / 336 / EWG
Titel	Richtlinie des Rates zur Angleichung der Rechtsvorschriften der Mitgliedsstaaten über die elektromagnetische Verträglichkeit

und daß die Normen und/oder technischen Spezifikationen, die auf der Umseite in Bezug genommen sind, zur Anwendung gelangt sind.

Die letzten beiden Ziffern des Jahres in dem die CE-Kennzeichnung angebracht wurde: (nur einzutragen, wenn die Übereinstimmung mit den Bestimmungen der Niederspannungsrichtlinie 73/23/EWG erklärt wird)

Aussteller : 
ELECTRONIC GMBH

Ort , Datum : Filderstadt , 24.11.98

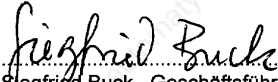
Unterschrift: 
Siegfried Buck , Geschäftsführer
(Name und Funktion der vom Hersteller oder von seinem Bevollmächtigten zur Unterschrift berechtigten Person)

Die Sicherheitshinweise der mitgelieferten Produktdokumentation sind zu beachten .

001-9330/
BT15N_grau_eng_V10.3:00000AOKO

Seite 1



TesiMod BT15N

EG-Konformitätserklärung

Seriennummer : BT15N/151xxx

Dokument - Nr./

Monat. Jahr : CE-BT15N.151_1/11.1998

Bezugnahme auf Normen und/oder technische Spezifikationen oder Teile von diesen die für diese Konformitätserklärung zur Anwendung gelangt sind :

- harmonisierte Normen :

Referenznummer	Ausgabedatum	Titel	Teile (1)
DIN EN 55011	10.97	Funkstörungen bei ISM-Geräten	
DIN EN 50081-1 Tab. A1	01.92	EMV-Störaussendung Wohnbereich	1
DIN EN 50082-2	02.96	EMV-Störfestigkeit Industriebereich	2
DIN EN 61000-4-2	1995	EMV-Störfestigkeit ESD	2
DIN EN 61000-4-3	08.97	EMV-Störf. Hf-elektromagn. Felder	3
DIN EN 61000-4-4	1995	EMV-Störfestigkeit Burst	4
DIN EN 61000-4-5	1995	EMV-Störfestigkeit Surge	5
DIN EN 61000-4-6	04.97	EMV-Störf. leitungsgef. Störgr.	6
DIN EN 55022	05.95	Funkstörungen bei ITE-Geräte	

- oder andere Normen und/oder technische Spezifikationen:

Referenznummer	Ausgabedatum	Titel	Teile (1)
----------------	--------------	-------	-----------

- andere Technische Lösungen, deren Details in den technischen Unterlagen oder in der technischen Dokumentation enthalten sind :

- Andere in Bezug genommene Dokumente oder Informationen, die von den anzuwendenden EG-Richtlinien gefordert werden :

Prüfbericht : 86215-1-BCD,PNR64

(1) Wo zutreffend, müssen die angewandten Teile oder Abschnitte der Norm oder der technischen Spezifikation in Bezug genommen werden.

SÜTRON ELECTRONIC GMBH Kurze Straße 29 D-70794 Filderstadt (Bonlanden)	Telefon 0711/77098-0 Telefax 0711/77098-60	Geschäftsführer: Siegfried Buck Frank Mohn	Amtsgericht Nürtingen HRB - Nr. 981
--	---	--	--

TesiMod BT15N

5 Index

A

Application Memory 39
ASCII Character Set Table 36

B

Battery 38

C

Character Attributes 34
Control Keys 8

D

Declaration of Conformity 43
Default Contrast Setting 34
Display 33
Display Contrast Setting 34

E

Editing Keys 7
Explanation of Symbols 5

F

Font
Normal 35
Zoom 35
Front Panel Dimensions 19
Front View 6
Function Key Arrangement 10
Function Keys 10
Fuse 39

K

Key
Acknowledge 9
Clear 9
Cursor down 8
Cursor home 8
Cursor left 8
Cursor right 8
Cursor up 8
Data Release 9
Decimal Point 8
Enter 9
F1 to F16 10
Help 9
Minus 8
Page down 9

Page up 9
Plus 8
Print 9
Keyboard 7

M

Mounting Depth 20
Mounting the Terminal 18

P

Panel Cutout 21
Pin Assignment
InterBus Optical Fibre 28
X1 Supply Voltage 23
X2 PROFIBUS-DP 26
X2.1 / X2.2 CAN-Bus 27
X2.1 / X2.2 InterBus 24
X2.1 / X2.2 SUCOnet K 25
X3 SER1 RS232c 31
X3 SER1 RS485 30
X3 SER1 TTY / 20 mA Current Loop 29
X3 SER2 RS232c 31
X4 Parallel Outputs 32

R

Rear View
CAN-Bus 16
InterBus 13
InterBus Optical Fibre 17
PROFIBUS-DP 15
Standard 12
SUCOnet K 14

S

Shielding 32
Side View 20
Slide-in Identification Strips 11
Special Keys 9

T

Technical Data 40

U

User-Mode Switch 37

TesiMod BT15N

Appendix A

A Appendix A

A.1 Shielding of SubminD - Interconnections

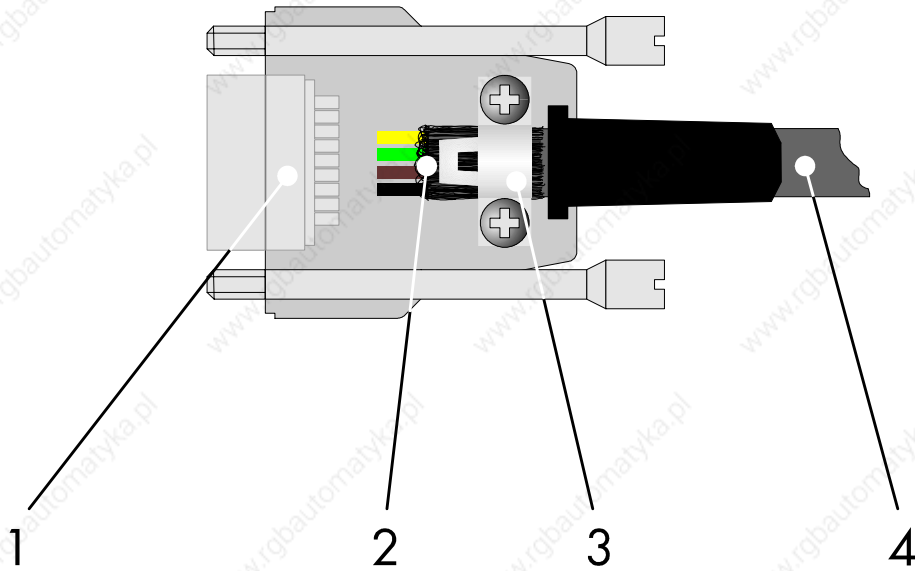

- 1 SubminD Connector
- 2 Shield
- 3 Cord Grip
- 4 Cable

The shield must be pushed back tubularly.

By fastening the cable with the cord grip you have to ensure an electrical contact of the shield to the housing over an area as wide as possible and an appropriate strain relief.