



TOE-S616-40 1D

TRANSISTOR INVERTER

Varispeed™-616HII

200 TO 230V 0.4 TO 7.5kW (0.5 TO 10HP) 1 TO 10kVA

INSTRUCTION MANUAL

Before initial operation
read these instructions
thoroughly and retain
for future reference

When properly installed, operated and maintained, this equipment will provide a lifetime of service. It is mandatory that the person who operates, inspects, or maintains this equipment thoroughly read and understand this manual, before proceeding.

This manual applies to VS-616HII Model CIMR-0.4B, -0.75B, -2.2B, -3.7B, -5.5B, and -7.5B.

The VS-616HII Drive is an AC variable speed drive system for high-precision variable speed applications. It basically consists of a three-phase squirrel-cage induction motor, a VS-616HII controller (VS-616HII), an operator control station, and optional control units. This manual primarily describes VS-616HII, but contains basic information for operator control station as well. For details of the operation of individual units, refer to their respective manuals.

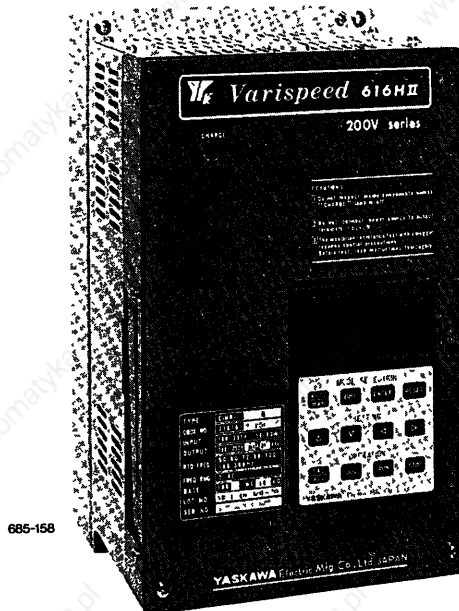

VS 616HII Inverter
with Digital Operator (Optional)

CONTENTS

| | |
|--|---|
| <p>1. RECEIVING 5</p> <p>2. VS-616HII FUNCTIONAL DESCRIPTION 6</p> <p>2.1 VS-616HII Functional Block Diagram and Major Control Component Layout 6</p> <p>2.2 Circuit Operational Description 8</p> <p>2.2.1 Main Circuit 8</p> <p>2.2.2 Control Circuit 8</p> <p>2.2.3 Protective Circuits 9</p> <p>3. INSTALLATION 9</p> <p>3.1 Location 9</p> <p>3.2 Positioning 10</p> <p>3.3 Mounting Dimensions 10</p> <p>4. WIRING 11</p> <p>4.1 Interconnections 11</p> <p>4.2 Molded-Case Circuit Breaker (MCCB) and Power Supply Magnetic Contactor (MC) 12</p> <p>4.3 Surge Absorber 12</p> <p>4.4 Wire Size 12</p> <p>4.5 Wiring Instructions 13</p> <p>4.5.1 Control Circuit 13</p> <p>4.5.2 Main Circuit Input/Output 13</p> <p>4.5.3 Grounding 14</p> <p>5. TEST RUN 15</p> <p>5.1 Checks Before Test Run 15</p> <p>5.2 Presetting and Adjustment Before Test Run 15</p> <p>5.3 Trial Operation/Test Run 21</p> <p>5.3.1 Use of Analog Operator Model JVOP-72 (optional) 22</p> <p>5.3.2 Use of Digital Operator Model JVOP-71 (optional) 23</p> <p>5.3.3 Use of VS Operator Model JVOP-65 (optional) 24</p> | <p>5.4 Frequency Meter Calibration 25</p> <p>6. OPERATION AT LOAD 25</p> <p>7. MAINTENANCE 26</p> <p>8. FAILURE INDICATION AND DETAILS 27</p> <p>9. TROUBLESHOOTING 28</p> <p>9.1 Measuring Point and Instrument 28</p> <p>9.2 Troubleshooting for Motor Symptom 29</p> <p>9.3 Troubleshooting for Failure Indications 31</p> <p>APPENDIX 1 VS-616HII RATINGS AND SPECIFICATIONS 36</p> <p>APPENDIX 2 TERMINAL FUNCTIONS 37</p> <p>APPENDIX 3 INTERNAL CIRCUIT AND INTERCONNECTION DIAGRAMS 38</p> <p>A3-1 VS-616HII Internal Circuit 38</p> <p>A3-2 Interconnection Diagrams for VS-616HII Applications 39</p> <p>APPENDIX 4 VS-616HII OPTIONAL AND AUXILIARY UNITS 48</p> <p>A4-1 VS-616H Optional Units 48</p> <p>A4-2 VS-616HII Auxiliary Units 49</p> <p>APPENDIX 5 CHECKING OF DIODE AND TRANSISTOR MODULES 50</p> <p>A5-1 Diode Module 50</p> <p>A5-2 Transistor Module 50</p> <p>APPENDIX 6 PARTS REPLACEMENT 52</p> <p>A6-1 Replacement of Control PC Board 52</p> <p>A6-2 Replacement of Base Drive PC Board 52</p> <p>A6-3 Replacement of Diode Module and Transistor Module 53</p> <p>A6-4 Replacement of Cooling Fan 53</p> <p>APPENDIX 7 RENEWAL PARTS 53</p> |
|--|---|

INDEX

| Subject | Chapter | Section | Page |
|---|------------|---------|------|
| A ANALOG OPERATOR MODEL JVOP-72• [] (OPTIONAL), USE OF | 5 | 5.3.1 | 22 |
| Auxiliary Units, VS-616H | APPENDIX 4 | A4-2 | 49 |
| B Before Test Run, Checks | 5 | 5.1 | 15 |
| BLOCK AND INTERCONNECTION DIAGRAMS | APPENDIX 3 | | 38 |
| C Circuit Operational Description of | 2 | 2.2 | 8 |
| CONTROL CIRCUIT | 2 | 2.2.2 | 8 |
| Control PC Board, Replacement of | APPENDIX 6 | A6-1 | 52 |

INDEX (Cont'd)

| Subject | Chapter | Section | Page |
|--|----------------------|-----------------|------|
| D Digital Operator Model JVOP-71 (Optional) (Fig. 17), Use of | 5 | 5.3.2 | 23 |
| Diode Module | APPENDIX 5 | A5-1 | 50 |
| Diode Module and Transistor Module, Replacement of | APPENDIX 6 | A6-3 | 52 |
| F FAILURE INDICATION AND DETAILS | 8 | | 27 |
| Frequency Meter Calibration | 5 | 5.4 | 25 |
| Functional Block Diagram and Major Control Component Layout, VS-616HII | 2 | 2.1 | 6 |
| FUNCTIONAL DESCRIPTION, VS-616HII | 2 | | 6 |
| I INSTALLATION | 3 | | 9 |
| Internal Circuit, VS-616HII | APPENDIX 3 | A3-1 | 38 |
| Interconnection Diagrams for VS-616HII Applications | APPENDIX 3 | A3-2 | 39 |
| Interconnections | 4 | 4.1 | 11 |
| L Location. | 3 | 3.1 | 9 |
| M Main Circuit | 2 | 2.2.1 | 8 |
| MAINTENANCE | 7 | | 26 |
| Measuring Point and Instrument | 9 | 9.1 | 28 |
| Molded-Case Circuit Breaker (MCCB) and Power Supply Magnetic Contactor (MC) | 4 | 4.2 | 12 |
| Mounting Dimensions | 3 | 3.3 | 10 |
| N NOTES FOR OPERATION | 6 | | 25 |
| O OPERATION AT LOAD | .6. | | 25 |
| OPTIONAL UNITS, AND AUXILIARY UNITS, VS-616HII | APPENDIX 4 | | 48 |
| Optional Units, VS-616HII | APPENDIX 4 | A4-1 | 48 |
| P PARTS REPLACEMENT | APPENDIX 6 | | 52 |
| Positioning | 3 | 3.2 | 10 |
| Protective Circuit | 2 | 2.2.3 | 9 |
| R Ratings and Specifications, VS-616HII | APPENDIX 1 | | 36 |
| RECEIVING | 1 | | 5 |
| RENEWAL PARTS | APPENDIX 7 | | 54 |
| S Surge Absorber. | 4 | 4.3 | 12 |
| T TEST RUN | 5 | | 15 |
| Test Run, Presetting and Adjustment before Transistor Module | 5 | 5.2 | 15 |
| Trial Operation/Test Run | APPENDIX 5 | A5-2 | 50 |
| TROUBLESHOOTING | 5 | 5.3 | 21 |
| Troubleshooting for Motor Symptom | 9 | | 28 |
| Troubleshooting for Failure Indications | 9 | 9.2 | 29 |
| | 9 | 9.3 | 31 |
| V VS OPERATOR MODEL JVOP-65. (OPTIONAL) (Fig. 18), USE OF | 5 | 5.3.3 | 24 |
| W WIRE SIZE | 4 | 4.4 | 12 |
| WIRING | 4 | | 11 |
| WIRING INSTRUCTIONS | 4 | 4.5 | 13 |

INDEX OF FIGURES

- Fig. 1 VS-616HII Functional Block Diagram 6
Fig. 2 Major Control Component Layout of VS-616HII Model CIMR-7.5B 7
Fig. 3 Accel/Decel Time Setting 8
Fig. 4 Example of V/f Setting 8
Fig. 5 VS-616HII Clearance Requirements for Proper Cooling and Maintenance 10

Fig. 6 Cabinet Mounting Dimensions 10
Fig. 7 Example of VS-616HII Interconnections 11
Fig. 8 Shielded Lead Termination 13
Fig. 9 Grounding of Three VS-616HII Units 14
Fig. 10 Connections for Megger Testing 14

Fig. 11 Accel/Decel Time Set by Notch ① of 2S 17
Fig. 12 ON/OFF Switches of 6S (1 to 8) 20
Fig. 13 Master Frequency Reference Signal Selection 20
Fig. 14 Auxiliary Frequency Reference Signal Selection 20
Fig. 15 Run and Stop Time Chart 21

Fig. 16 Analog Operator (Optional) 22
Fig. 17 Digital Operator (Optional) 23
Fig. 18 VS Operator (Optional) 24
Fig. 19 Exploded View of VS-616HII 26
Fig. 20 Points for Measurement 29

Fig. 21 Output Voltage Measurement 29
Fig. 22 VS-616HII Internal Circuit 38
Fig. 23 With Analog Operator 39
Fig. 24 With Digital Operator 39
Fig. 25 With VS Operator 40

Fig. 26 With User-Arranged Operation Circuit 41
Fig. 27 With Magnetic Contactor for Start/Stop Operation 42
Fig. 28 With VS Operator and Analog Operator 44
Fig. 29 With VS Operator and Digital Operator 45
Fig. 30 With Braking Module and Braking Resistor Unit 46

Fig. 31 With Transistor (Open-collector) for Start/Stop Operation 47
Fig. 32 Control PC Board 52
Fig. 33 Base Drive PC Board 52
Fig. 34 Removing Diode Module and Transistor Module 53
Fig. 35 Cooling Fan Assembly 53

INDEX OF TABLES

- Table 1 VS616HII Model Name and Ratings 5
Table 2 Molded-Case Circuit Breakers and Magnetic Contactors 12
Table 3 Surge Absorbers 12
Table 4 Wire Size for Main and Control Circuits 12
Table 5 Round Pressure Terminals 12

Table 6 List of Setting Switches 15
Table 7 V/f Pattern Selection 16
Table 8 Accel/Decel Time Range Setting 17
Table 9 Notch Selection of Electronic Thermal Setting Switch (Use of Standard Motor) 18
Table 10 Notch Selection of Electronic Thermal Setting Switch (Use of VS-616HII Motor) 18

Table 11 Inverter Capacity Selection 18
Table 12 Selection of Operation Modes 19
Table 13 Periodical Inspection 26
Table 14 Failure Indication Analog and Digital Operators 27
Table 15 Failure Indication of VS-616HII 27
Table 16 Measuring Points and Instruments 28

Table 17 VS-616HII Ratings and Specifications 36
Table 18 Terminal Functions and Voltages of Main Circuit 37
Table 19 Terminal Functions and Signals of Control Circuit 37
Table 20 VS-616HII Optional Units 48
Table 21 VS-616HII Auxiliary Units 49

Table 22 Devices of VS Operator Model JVOP-65. 49
Table 23 Diode Module Resistances 50
Table 24 Transistor Module Resistances of Model CIMR-0.4B 50
Table 25 Transistor Module Resistances of Model CIMR-0.75B, -2.2B and -3.7B 51
Table 26 Transistor Module Resistances of Model CIMR-5.5B and -7.5B 51

Table 27 Renewal Parts 54

DANGER

- Do not touch circuit components until "CHARGE" lamp is extinguished after turning off the AC main circuit power supply. The capacitors are still charged and can be quite dangerous.
- Before changing switch settings (1S to 6S), turn off the power and make sure that CHARGE lamp is off.
- Do not connect or disconnect wires and connectors while power is applied to the the circuit.
- Do not check signals during operation.

IMPORTANT

- Be sure to ground VS-616HII using the ground terminal (E). See par 4.5.3 on page 14.
- Never connect main circuit output terminals (U(T1), V(T2), W(T3)) to AC main circuit power supply.
- All the potentiometers of VS-616HII have been adjusted at the factory. Do not change their settings unnecessarily.
- Do not make withstand voltage test on any part of the VS-616HII unit, because it is electronic equipment using semi-conductors and vulnerable to high voltage.
- To make the insulation resistance test with a megger, special precautions must be taken. Before test, See Insulation Resistance Test on page 14.
- Control PC board employs C MOS IC's which are easily damaged by static electricity. Take care not to touch the C MOS elements inadvertently.

1. RECEIVING

This VS-616HII has been put through severe tests at the factory before shipped. After unpacking, however, check and see the following.

- Nameplate ratings meet your requirements. See Table 1.
- Leads and connectors are not disengaged.
- No damage while in transit.
- Bolts and screws are not loose.

If any part of VS-616HII is damaged or lost, immediately notify us giving full details and nameplate data.

Table 1 VS-616HII Model Name and Ratings

| VS-616HII Model CIMR- | 0.4B | 0.75B | 2.2B | 3.7B | 5.5B | 7.5B |
|----------------------------|--------------|-------------|------------|------------|--------------|-------------|
| Max Motor Output kW(Hp) | 0.4 (0.5) | 0.75 (1) | 2.2 (3) | 3.7 (5) | 5.5 (7.5) | 7.5 (10) |
| Inverter Capacity kVA | 1 | 1.5 | 3 | 5 | 7.5 | 10 |

2. VS-616H II FUNCTIONAL DESCRIPTION

2.1 VS-616H II FUNCTIONAL BLOCK DIAGRAM AND MAJOR CONTROL COMPONENT LAYOUT

VS-616H II functional block diagram is shown in Fig. 1 and major control component layout, in Fig. 2.

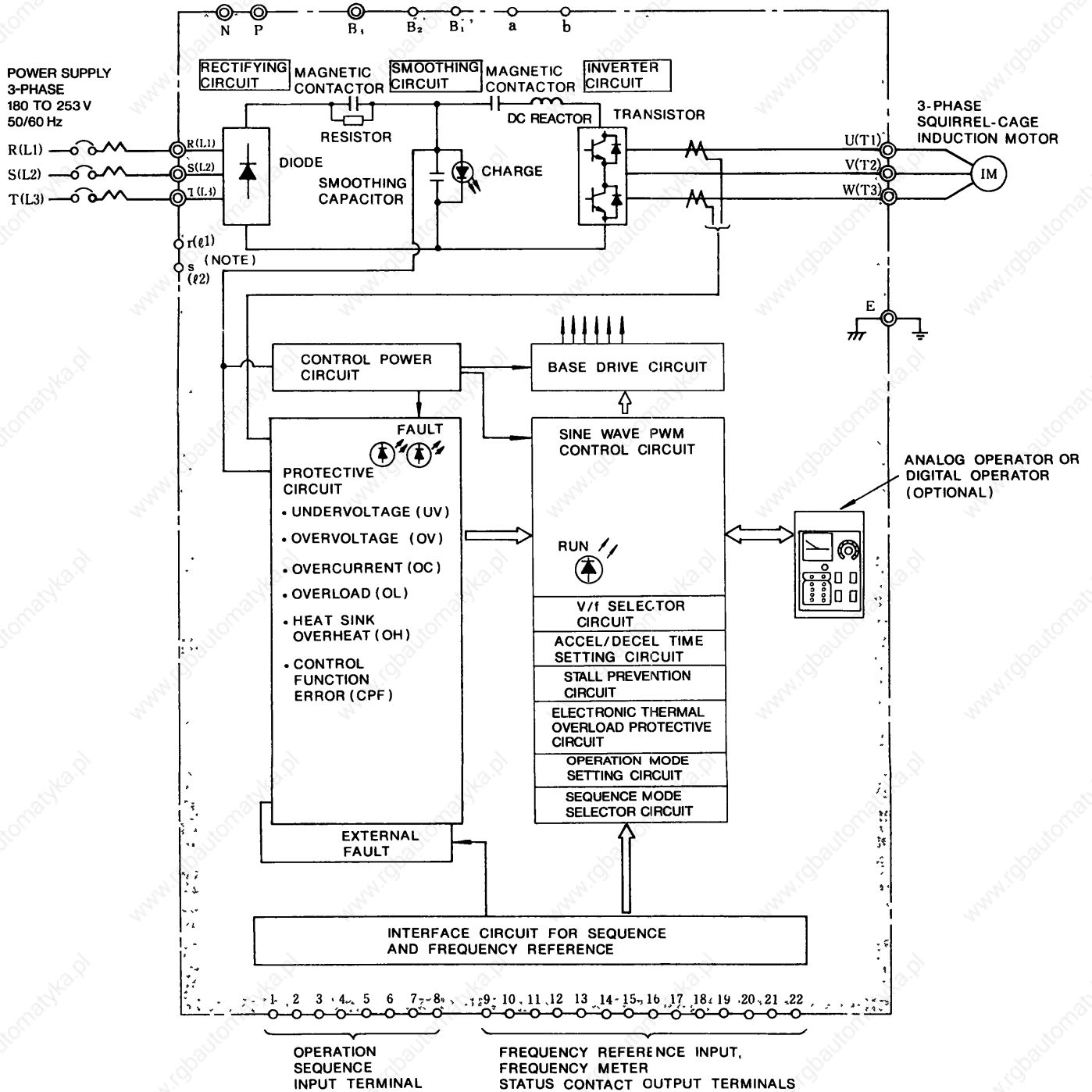

Note Terminals (r)(l1) and (s)(l2) are not provided with Models CIMR-37 B, -22 B, -075 B, and -04 B

Fig 1 VS-616H II Functional Block Diagram

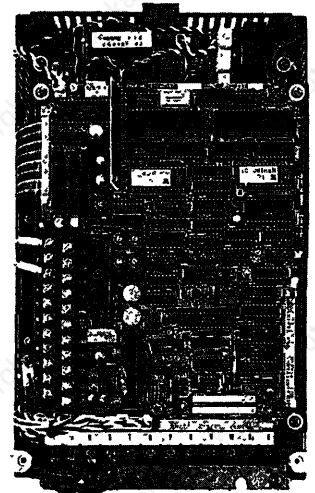
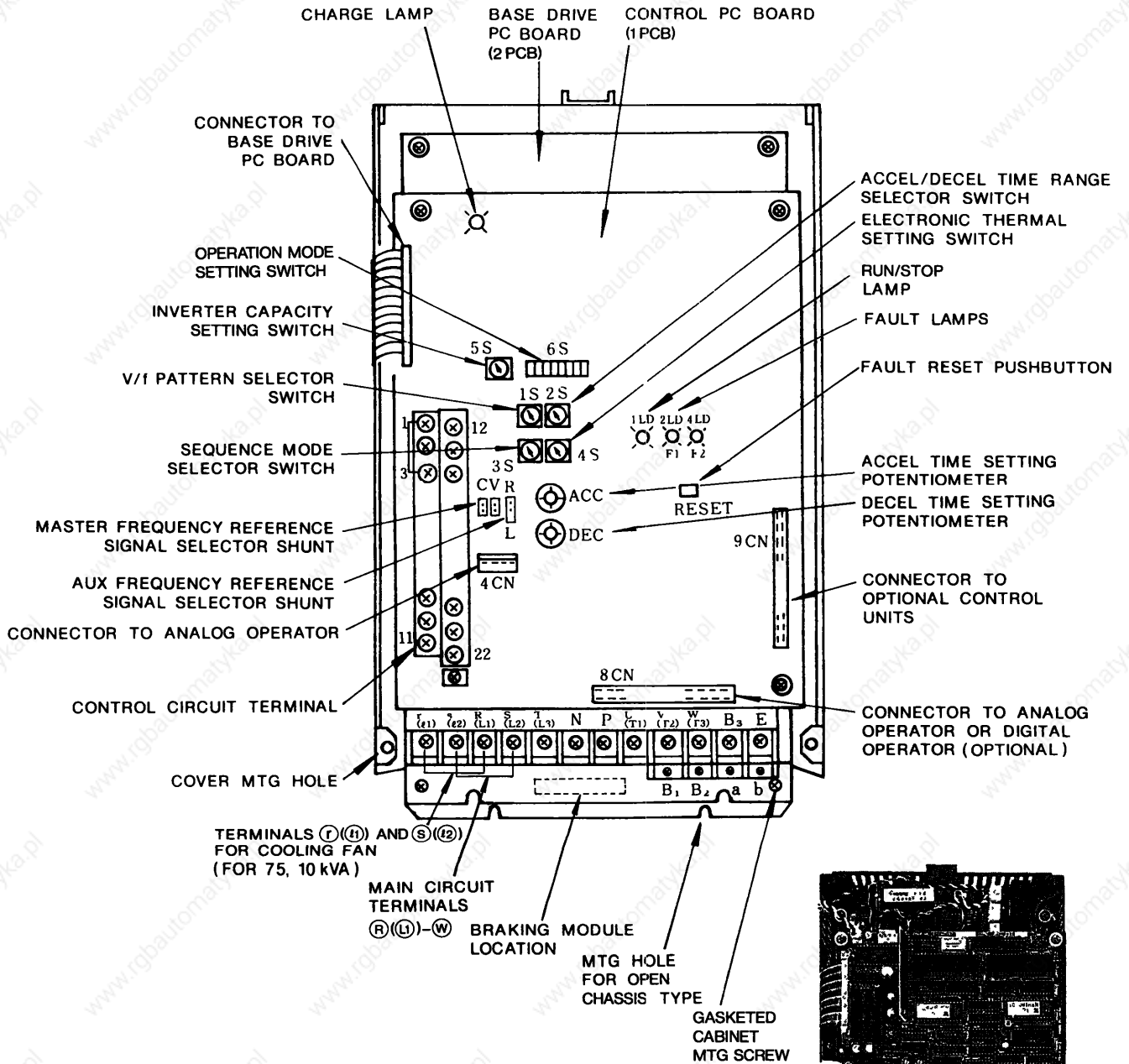

Fig 2 Major Control Component Layout of VS-616 HII Model CIMR-75 B

2.2 CIRCUIT OPERATIONAL DESCRIPTION

2.2.1 MAIN CIRCUIT

- (1) Rectifying circuit: Converts three-phase AC inputs through diodes to DC voltage.
- (2) Smoothing circuit: Smooths ripples in DC voltage by means of a capacitor.
- (3) Inverter circuit: Converts DC voltage to AC voltage of a preset frequency by switching six transistors. The output voltage level is controlled by changing the pulse width ratio, thus generating pseudo-sine waves.

2.2.2 CONTROL CIRCUIT

- (1) Base drive circuit: Drives the transistors in the inverter circuit.
- (2) Sine wave PWM control circuit: Calculates the pulse width every time a reference signal is received from the V/f control circuit, and outputs a PWM signal approximating a sine wave.
- (3) V/f selector circuit: Selects V/f pattern from 15 types of built-in voltage/frequency (V/f) patterns (Fig. 3).
- (4) Acceleration and deceleration time setting circuit: Smoothly changes the output frequency upon a rapid change of the frequency reference signal. Acceleration and deceleration times can be independently set by the acceleration (ACC) and deceleration (DEC) time setting potentiometers (Fig. 4).
- (5) Stall prevention circuit
 - During acceleration—Stops acceleration in the event of overcurrent condition and prevent the motor from stopping due to overcurrent. When the current returns to the rated value, acceleration is resumed.
 - During deceleration—Stops deceleration in the event of overvoltage condition and prevents the motor from stopping due to overvoltage. When the voltage returns to the rated value, deceleration is resumed.
 - In constant-speed operation—Reduces motor speed in the event of overload condition so as to prevent the motor from stopping due to overload. When overload condition is alleviated, motor resumes running at normal speed.

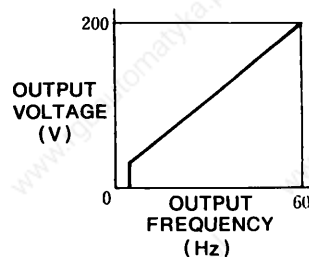

Fig 3 Example of V/f Pattern

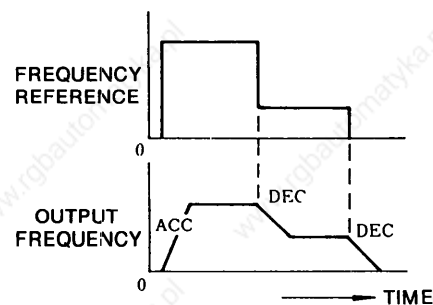

Fig 4 Accel/Decel Time Setting

(6) Operation mode selector circuit: Selects one of eight operation modes individually to tailor the inverter to a specific application.

(7) Sequence mode selector circuit: Selects the optimum function from ten modes, according to the application.

2.2.3 PROTECTIVE CIRCUITS

See 8. Failure Indication and Details on page 26 when protective circuits function.

(1) Undervoltage protective circuit: If the supply voltage drops below a set level or any one of phases is open, the undervoltage protective circuit shuts off the power transistors in the main circuit, and outputs a fault signal (UV operation). With the appropriate operation mode selected, operation can continue if the power is resumed in approximately 2 seconds (operation after momentary power failure).

(2) Overvoltage protective circuit: If the main circuit DC voltage becomes higher than the set level, the overvoltage protective circuit shuts off the power transistors in the main circuit, and outputs a fault signal (OV operation).

(3) Overcurrent protective circuit: If more than 200% of the rated current flow is detected, the overcurrent protective circuit immediately shuts off the power transistors in the main circuit, and outputs a fault signal (OC operation).

(4) Overload protective circuit: When inverter or motor overload is detected by increased motor current, the overload protective circuit shuts off the power transistors in the main circuit after a specified time, and outputs a fault signal (OL operation).

(5) Electronic thermal overload protective circuit: Automatically adjusts protective characteristics to current and time to maximize operating capability.

3. INSTALLATION

3.1 LOCATION

Location of the equipment is important to achieve proper performance and normal operating life. The VS-616HII units should be installed in areas where the following conditions exist.

- Ambient temperature: -10 to +40°C
- Protected from rain or moisture.
- Protected from direct sunlight.
- Protected from corrosive gases or liquids.
- Free from airborne dust or metallic particles.
- Free from vibration.

CAUTION

Never move, lift or handle the VS-616HII cabinet by the front cover.

3.2 POSITIONING

For cooling and maintenance purposes, make sure that there is sufficient clearance around the equipment, as shown in Fig. 5.

To keep effective cooling conditions, it must be installed vertically to the ground using the four mounting screws.

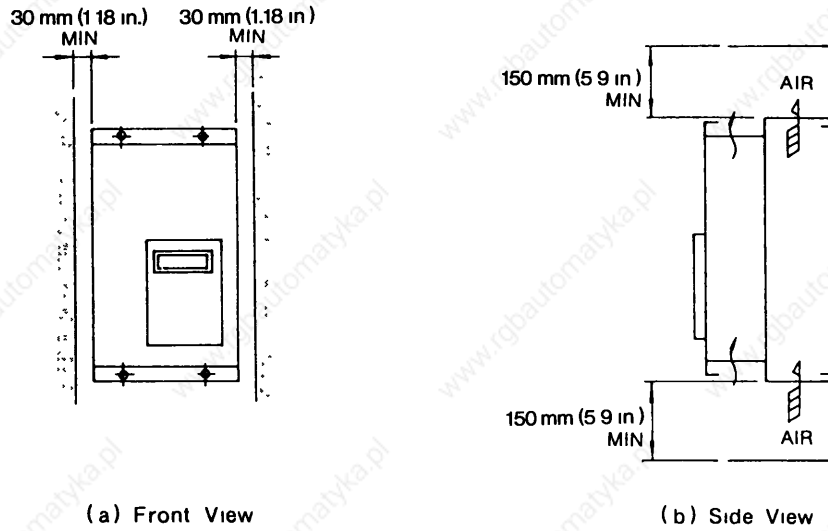
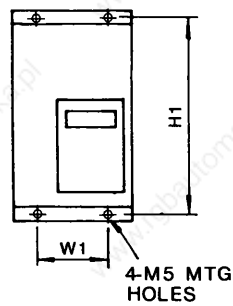

Fig 5 VS-616HII Clearance Requirements for Proper Cooling and Maintenance

3.3 MOUNTING DIMENSIONS

The mounting dimensions for the VS-616HII are given in Fig. 6.



| VS-616 H II Model CIMR- | Dimensions in mm(in) | | | | | |
|----------------------------|----------------------|------|-----|-----|------------|-----|
| | 04B | 075B | 22B | 37B | 55B | 75B |
| W1 | 175 (6.89) | | | | 125(4.92) | |
| H1 | 290 (11.42) | | | | 340(13.39) | |

Fig. 6 Cabinet Mounting Dimensions

4. WIRING

4.1 INTERCONNECTIONS

Fig. 7 shows the connection diagram for combination of VS-616HII with VS operator. Remove the front cover before wiring. Connections should be made correctly, referring to Fig. 7.

POWER SUPPLY, 3-PHASE,
200/208/220 VAC, 50 Hz
200/208/220/230 VAC, 60 Hz

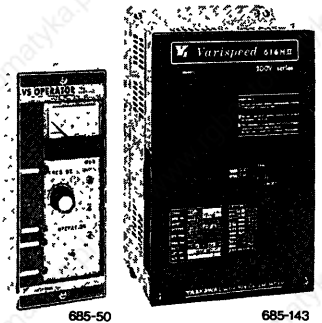
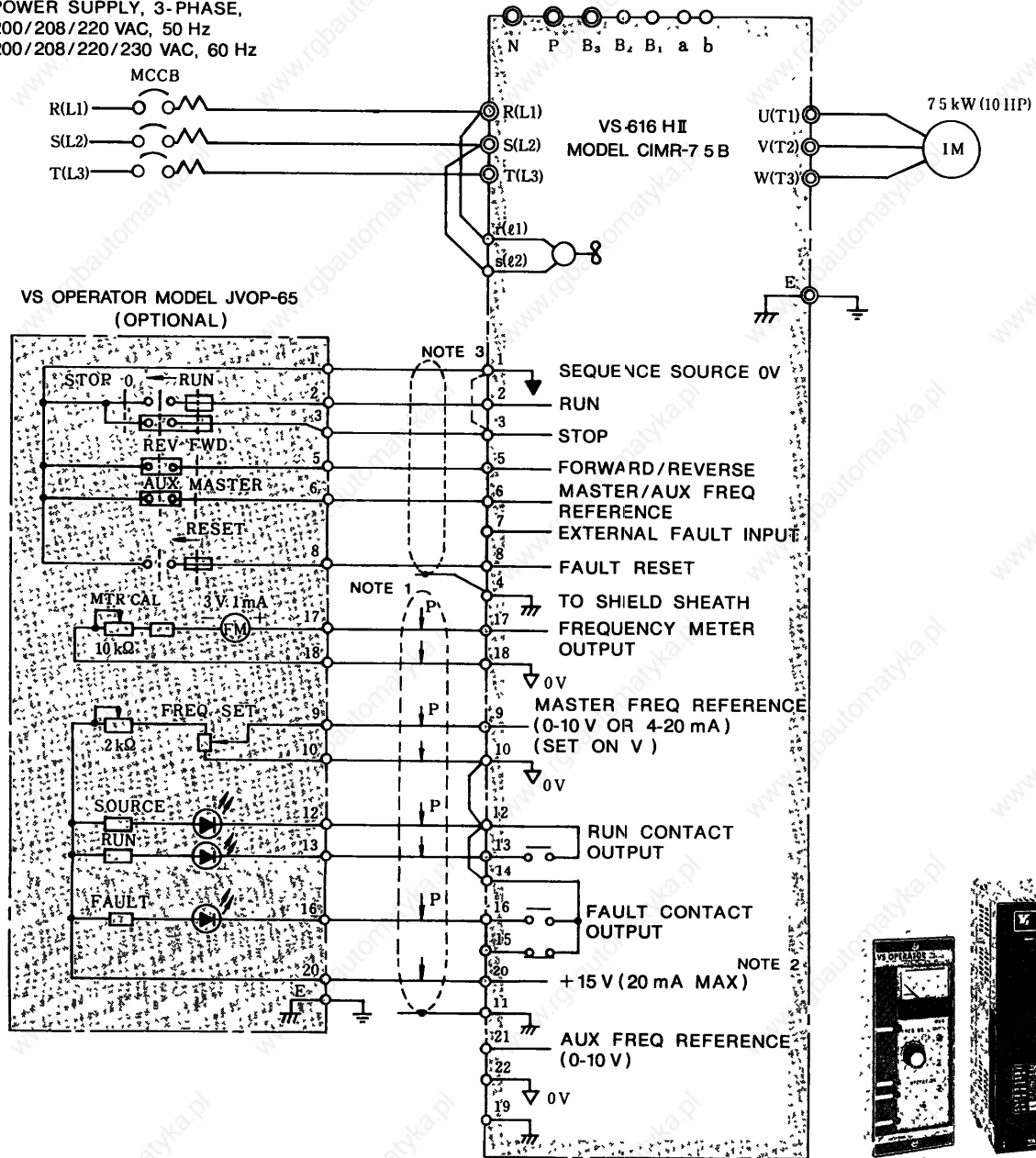

Note

- 1 indicates shielded leads and twisted-pair shielded leads.
- 2 External terminal 20 of +15 V has maximum output current capacity of 20 mA. It accommodates a single VS operator, if used.
- 3 When VS operator is used, remove external terminal connections between 1 and 3.
- 4 Terminal symbol (C) shows main circuit, and (O), control circuit.

NOTE

Be sure to connect a surge absorber to the coils of relays, magnetic contactors, magnetic valves, or magnetic brakes.

Fig 7 Example of VS-616 HII Interconnections

4.2 MOLDED-CASE CIRCUIT BREAKER (MCCB) AND POWER SUPPLY MAGNETIC CONTACTOR (MC)

Be sure to connect MCCBs between power supply and VS-616HII input terminals (R)(L), (S)(L2), (T)(L3). Recommended MCCBs are listed in Table 2.

When a ground fault interrupter is used to prevent malfunction, setting current should be 200 mA or over and operating time, 0.2 sec or over.

Table 2 Molded-Case Circuit Breakers and Magnetic Contactors

| VS-616HII | Model CIMR- | 0.4B | 0.75B | 2.2B | 3.7B | 5.5B | 7.5B | |
|-----------------------------------|----------------------|------|-------|-------|----------|--------|--------|--------|
| | Capacity | kVA | 1 | 1.5 | 3 | 5 | 7.5 | 10 |
| | Rated Output Current | A | 3 | 4.5 | 9 | 15 | 23 | 30 |
| Molded-Case Circuit Breaker | Rated Current* | | 5A | 10A | 20A | 30A | 50A | 60A |
| Yaskawa Magnetic Contactors Model | | | HI-7E | HI-7E | HI-10-2E | HI-20E | HI-25E | HI-30E |

*Comply with NEMA AB1

4.3 SURGE ABSORBER

For the surge absorbers to be connected to the coils of relays, magnetic contactors, magnetic valves, or magnetic relays, select types from the ones listed in Table 3.

Table 3 Surge Absorbers

| Coils of Magnetic Contactor and Control Relay | Surge Absorber* | | |
|--|-----------------|-----------------------|---------|
| | Model | Specifications | Code No |
| Large-size Magnetic Contactors | DCR2-50A22E | 250 VAC 0.5μF+200Ω | C002417 |
| Control Relay LY-2,-3(OMRON) HH-22,-23(Fuji) MM-2,-4(OMRON) | DCR2-10A25C | 250 VAC 0.1μF+100Ω | C002482 |

*Made by MARCON Electronics

4.4 WIRE SIZE

Wire sizes for main and control circuits are listed in Table 4, and Table 5 gives the selection of round pressure terminals according to wire size.

Table 4 Wire Size for Main and Control Circuits

| Circuit | VS 616 H II Model CIMR- | Inverter Capacity kVA | Terminal Symbols | Terminal Screw | Wire Size* | | Lead Type |
|---------|-------------------------|---|---|----------------|-----------------|-------|--|
| | | | | | mm ² | AWG | |
| Main | 0.4B | 1 | (R)(L), (S)(L2), (T)(L3), (U)(T1), (V)(T2), (W)(T3), (N), (P), (E), (E) | M4 | 2-5.5 | 14-10 | Power Cable 600 V vinyl-sheathed lead or equivalent |
| | 0.75B | 1.5 | (R)(L), (S)(L2), (T)(L3), (U)(T1), (V)(T2), (W)(T3), (N), (P) | M4 | 3.5-5.5 | 12-10 | |
| | 2.2B | 3 | (E), (E) | | 2-5.5 | 14-10 | |
| | 3.7B | 5 | (R)(L), (S)(L2), (T)(L3), (U)(T1), (V)(T2), (W)(T3), (N), (P) | M4 | 3.5-5.5 | 12-10 | |
| | | | (E), (E) | | 2-5.5 | 14-10 | |
| | 5.5B | 7.5 | (R)(L), (S)(L2), (T)(L3), (U)(T1), (V)(T2), (W)(T3), (N), (P) | M5 | 5.5-8 | 10-8 | |
| | | (R)(L), (S)(L2), (T)(L3), (U)(T1), (V)(T2), (W)(T3), (N), (P) | M4 | 2-5.5 | 14-10 | | |
| | | (R)(L), (S)(L2), (T)(L3), (U)(T1), (V)(T2), (W)(T3), (N), (P) | M5 | 5.5-8 | 10-8 | | |
| | | (R)(L), (S)(L2), (T)(L3), (U)(T1), (V)(T2), (W)(T3), (N), (P) | M4 | 2-5.5 | 14-10 | | |
| Control | - | - | ①-② | M4 | 0.5-2 | 20-14 | Twisted shielded lead† for instrumentation |

Table 5 Round Pressure Terminals

| Wire Size | | Terminal Screw | Round Pressure Terminal |
|-----------------|-----|----------------|-------------------------|
| mm ² | AWG | | |
| 0.5 | 20 | M4 | 1.25-4 |
| 0.75 | 18 | | |
| 1.25 | 16 | | |
| 2 | 14 | M4 | 2-4 |
| 3.5 | 12 | M4 | 5.5-4 |
| 5.5 | 10 | | |
| | | M5 | 5.5-5 |
| 8 | 8 | M5 | 8-5 |

*Lead size should be determined considering voltage drop of leads.

†Polyethylene-insulated vinyl-sheathed, with shielding.

4.5 WIRING INSTRUCTIONS

4.5.1 CONTROL CIRCUIT

(1) Separation of control circuit leads and main circuit leads

Signal leads ① through ②② must be separated from main circuit leads R(①①), S(①②), T(①③), N, P, U(①④), V(①⑤), W(①⑥), r(①⑦), s(①⑧) and B₃ to prevent erroneous operation caused by noise interference. If signal leads ①⑨ to ①⑬ (contact output) are connected to another power supply, separate them from ① to ①⑪ and ①⑭ to ②②.

(2) Control circuit leads

Use the twisted shielded or twisted-pair shielded lead for the control circuit line and connect the shield sheath to the any of the inverter terminals ④, ①⑪, or ①⑨. See Fig. 8.

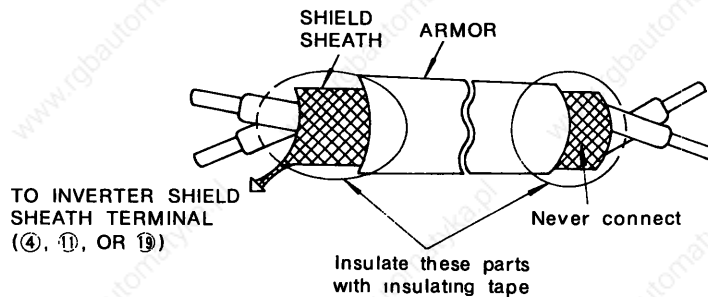

Fig 8 Shielded Lead Termination

(3) Wiring distance

It is recommended that the wiring distance of the signal leads (① - ②②) be 50 meters (164 feet) or below.

4.5.2 MAIN CIRCUIT INPUT/OUTPUT

(1) Direction of phase rotation of power

- Phase rotation of power is available to each direction, clockwise and counterclockwise.
- When inverter output terminals U(①④), V(①⑤), and W(①⑥) are connected to motor terminals U(①④), V(①⑤), and W(①⑥), respectively, motor rotates counterclockwise, viewed from opposite drive end, upon forward operation command. To reverse the rotation interchange any two of motor leads.

(2) Never connect power supply to output terminals U(①④), V(①⑤), and W(①⑥).

(3) Care should be taken to prevent contact of wiring leads with VS-616HII cabinet, for short-circuit may result.

(4) To feed DC power supply from terminals P and N, remove the leads across R(①①) and r(①⑦), and S(①②) and s(①⑧). Connect cooling fan power supply (200/230 V, 50/60 Hz; 220/230 V, 60 Hz) across terminals r(①⑦) and s(①⑧), for Models CIMR-5.5B and -7.5B.

(5) Never connect power factor correction capacitor, noise filter to VS-616HII output.

(6) After completing VS-616HII interconnections, be sure to check that connections are correct. Never use control circuit buzzer check.

4.5.3 GROUNDING

Make a positive grounding using ground terminal \textcircled{E} on the casing of VS-616HII.

(1) Ground resistance should be 100Ω or less.

(2) Never ground VS-616HII in common with welding machines, motors, and other large-current electrical equipment, or ground pole. Run the ground lead in a separate conduit from leads for large-current electrical equipment.

(3) Use ground lead listed in Table 3 and make the length as short as possible.

(4) Even when VS-616HII is grounded through its mountings such as channel base or steel plate, be sure to ground VS-616HII using the ground terminal \textcircled{E} .

(5) Where several VS-616HII units are used side by side, all the units should preferably be grounded directly to the ground poles. However, connecting all the ground terminals of VS-616HII in parallel, and ground only one of VS-616HII to the ground pole is also permissible (Fig. 9). However, do not form a loop with the ground leads.

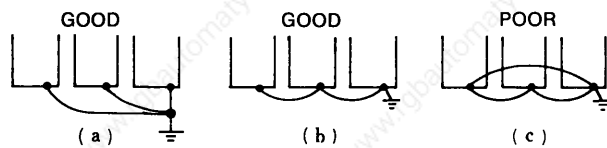

Fig 9 Grounding of Three VS-616HII Units

INSULATION RESISTANCE TEST

For megger-testing the main circuit, measure the insulation resistance with a 500 V megger.

Connect the AC input, output terminals \textcircled{r} ($\textcircled{L1}$), \textcircled{s} ($\textcircled{L2}$), \textcircled{R} ($\textcircled{L1}$), \textcircled{S} ($\textcircled{L2}$), \textcircled{T} ($\textcircled{L3}$), \textcircled{N} , \textcircled{P} , \textcircled{U} ($\textcircled{T1}$), \textcircled{V} ($\textcircled{T2}$), \textcircled{W} ($\textcircled{T3}$), $\textcircled{B_1}$, $\textcircled{B_2}$, $\textcircled{B_3}$, \textcircled{a} , and \textcircled{b} by a common wire, and connect the control terminals ① - ②② (excluding ④, ⑪, ⑲) by a common wire as shown in Fig. 10. After that, measure the insulation resistance between the common wire of input/output terminals and ground with a megger. Never measure the insulation resistance of circuit other than the main circuit (power line). For both the input and output terminals, a reading above $1M\Omega$ is considered satisfactory.

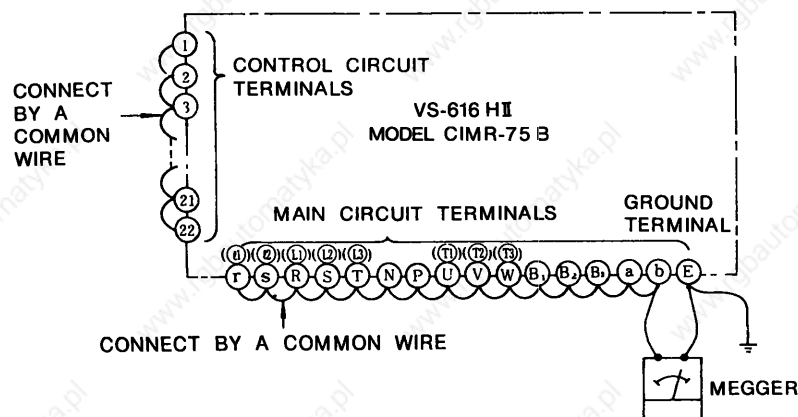

Fig 10 Connections for Megger Testing

5. TEST RUN

5.1 CHECKS BEFORE TEST RUN

After completing mounting and connection of units, check for:

- Correct connections
- No short-circuit conditions
- No loose screw terminals (Check especially for loose wire clippings.)
- Proper load condition

5.2 PRESETTING AND ADJUSTMENT BEFORE TEST RUN









Before setting, be sure to shut off the AC main circuit power and make sure that the CHARGE lamp goes out. If any setting except for accel/decel time is performed with the power on, the following failure indicators will blink:

- FAULT lamp on the inverter
- CPF lamp, if the Analog or Digital operator is used

If any setting is changed during operation, the operation will continue with the setting made before the change. If the VS-616HII is turned off and then on again, it operates with the changed settings.

- The VS operator provides no failure indication for setting with power ON.

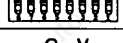
Table 6 List of Setting Switches

| Switch Name | Symbol | Function | Factory-setting |
|---|---|---|------------------------|
| V/f Pattern Selector Switch | 1S  | Selects one of 15V/f patterns to match specific applications. | Notch ① |
| Accel/Decel Time Setting | Switch 2S  | Selects accel/decel time range (0.2 to 1800 seconds) | Notch ① |
| | Potentiometer ACC DEC  | Accel/decel times independently adjustable between the time range selected by 2S. | Scale 5 |
| Sequence Mode Selector Switch | 3S  | Selects one of 15 types of sequences according to application requirements. CAUTION Do not tamper with this switch. Any changes or adjustments must be made by the factory. | Notch ① |
| Electronic Thermal Setting Switch | 4S  | Protects motor and inverter from overcurrent conditions if motor capacity is different from inverter capacity. | (See Tables 9 and 10.) |
| Inverter Capacity Selector Switch | 5S  | Set according to inverter capacity. CAUTION Same as for 3S. | (See Table 11.) |
| Operation Mode Selector Switch | 6S  | Selects the operation mode according to specific applications. | OFF |
| Master Frequency Reference Signal Selector Shunt | C V  | Selects either a current signal (4-20mA) or a voltage signal (0-10V) to feed frequency reference signal at terminal ⑨. | V (Voltage signal) |
| Auxiliary Frequency Reference Signal Selector Shunt | R  L | Set to input frequency reference at external terminal ⑩. When the Analog operator is used for frequency setting, set the shunt on "L" because signals from external terminal ⑩ are not accepted. | R |

5.2 PRESETTING AND ADJUSTMENT BEFORE TEST RUN (Cont'd)

(1) Setting of V/f pattern selector switch (1S)

The V/f pattern selector switch (1S) has been factory-set at the notch ① for most applications. For specific applications such as fans and pumps, high-starting torques, or machine tools, select the optimum V/f pattern for motor running, according to the load characteristics. (See Table 7.)

Table 7 V/f Pattern Selection (Input Supply Voltage 200 V)

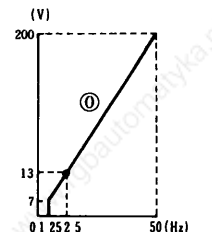
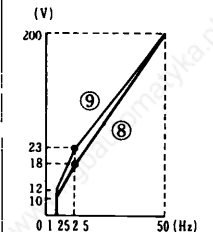
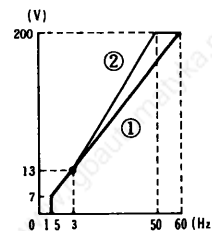
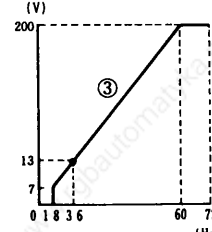
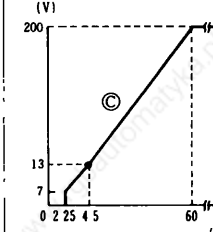
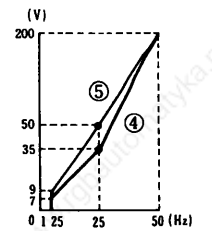
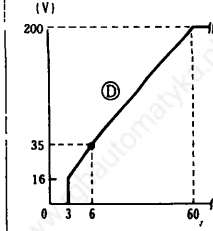
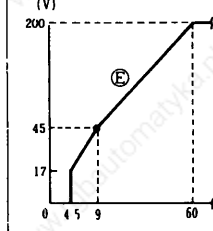
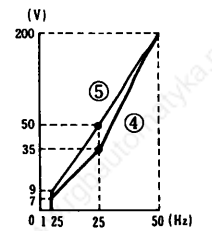
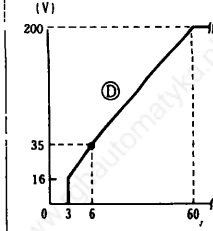
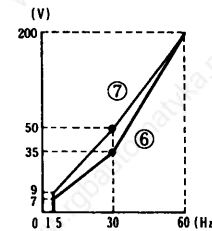
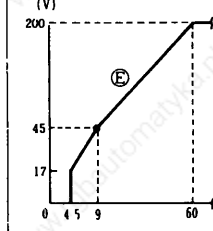
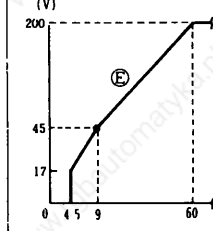
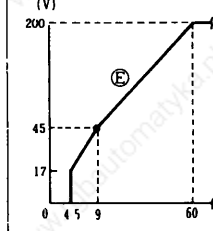
| Application | Specification | 1S Notch | V/f Pattern | Application | Specification | 1S Notch | V/f Pattern |
|--|-------------------|---|---|---|---|---|---|
| General Purpose | 50Hz | ① |  | High Starting Torque | Starting Torque Low | ⑧ |  |
| | 60Hz | 60Hz Saturation | ① | |  | Starting Torque High | ⑨ |
| | | 50Hz Saturation | ② |  | Starting Torque Low | A |  |
| | 72Hz | ③ |  | Constant Output Operation (Machine Tools) | Starting Torque High | B |  |
| Variable Output Operation (Fans and Pumps) | 50Hz | Variable Torque 2 | ④ | | 90Hz | ④ |  |
| | | Variable Torque 1 | ⑤ |  | | | |
| | 60Hz | Variable Torque 2 | ⑥ | 120Hz | ⑤ |  | |
| | | Variable Torque 1 | ⑦ | |  | | |
| 180Hz | ⑥ |  | 180Hz | ⑥ |  | | |
| | Variable Torque 2 | ⑦ | |  | | | |

Note 1 Take account of the following conditions and others when selecting V/f pattern

- Pattern matching the voltage-frequency characteristic of the motor
- According to the maximum motor speed

2. V/f pattern for high starting torque should be selected for:

- Long wiring distance
- Large voltage drop at start.
- AC reactor connected to input or output of the inverter
- Use of motor of the rating below the max.

For details, contact Yaskawa representative

(2) Setting of acceleration and deceleration times (2S, ACC, DEC)

Set the acceleration and deceleration times using acceleration time range selector switch (2S), and the acceleration (ACC) and deceleration (DEC) time setting potentiometers (Table 8).

2S has been factory-set to notch ①, and the ACC and DEC potentiometers have been individually set to scale 5 (approximately 10 seconds).

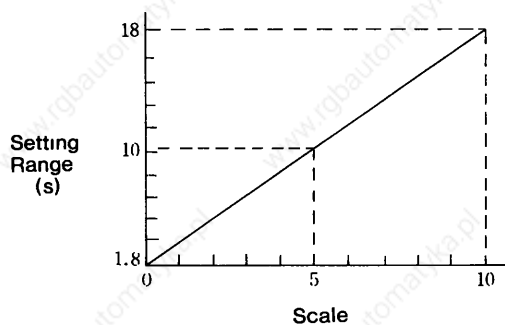

Fig 11 Accel/Decel Time Set by Notch ① of 2S

Table 8 Accel/Decel Time Range Setting

| 2S Notch | Accel/Decel Time Setting Range (sec) |
|------------------------|--|
| ① | 0.2-6 |
| ① (Factory setting) | 1.8-18 |
| ② | 6-60 |
| ③ | 18-180 |
| ④ | 60-600 |
| ⑤-⑥ | 180-1800 |
| Ⓔ | 0 |
| Ⓔ | For calibrating freq meter See par. 54 on page 25 |

(3) Selection of sequence mode (3S)

The standard sequence mode selector switch (3S) is paint-locked to notch ①.

Notches ① to ⑥ provide sequences for special applications. For details, contact Yaskawa representative.

(4) Setting of electronic thermal setting switch (4S)

When a motor has a capacity different from the maximum applicable capacity of the inverter, the VS-616H setting must be changed to suit the motor capacity to protect the motor positively. Table 9 on page 18 shows the selections of Yaskawa standard motors (4 poles). The switch has been factory-set to the notch marked off by shading.

When VS-616H motors are used, set the switch (4S) according to Table 10 on page 18. (Notch F inactivates the motor protection by the electronic thermal function.)

5.2 PRESETTING AND ADJUSTMENT BEFORE TEST RUN (Cont'd)

Table 9 Notch Selection of Electronic Thermal Overload Protective Switch
(Use of Standard Motor)

| VS-616HII Model CIMR- | kVA | Max Motor Output kW (Hp) | | | | | | |
|-----------------------------|-----|--------------------------|---------|--------|--------|--------|----------|---------|
| | | 0.4 (0.5) | 0.75(1) | 1.5(2) | 2.2(3) | 3.7(5) | 5.5(7.5) | 7.5(10) |
| 0.4B | 1 | ④ | — | — | — | — | — | — |
| 0.75B | 1.5 | ① | ⑥ | — | — | — | — | — |
| 2.2B | 3 | — | — | ③ | ⑥ | — | — | — |
| 3.7B | 5 | — | — | ① | ③ | ⑥ | — | — |
| 5.5B | 7.5 | — | — | — | ① | ③ | ⑥ | — |
| 7.5B | 10 | — | — | — | — | ① | ③ | ⑥ |

Shaded areas show factory-set notches

Table 10 Notch Selection of Electronic Thermal Overload Protective Switch
(Use of VS-616HII Motor)

| VS-616HII Model CIMR- | kVA | Max Motor Output kW (Hp) | | | | | | |
|-----------------------------|-----|--------------------------|---------|--------|--------|--------|----------|---------|
| | | 0.4 (0.5) | 0.75(1) | 1.5(2) | 2.2(3) | 3.7(5) | 5.5(7.5) | 7.5(10) |
| 0.4B | 1 | Ⓑ | — | — | — | — | — | — |
| 0.75B | 1.5 | Ⓔ | ⑨ | — | — | — | — | — |
| 2.2B | 3 | — | — | Ⓒ | ⑨ | — | — | — |
| 3.7B | 5 | — | — | Ⓔ | Ⓒ | ⑨ | — | — |
| 5.5B | 7.5 | — | — | — | Ⓔ | Ⓒ | ⑨ | — |
| 7.5B | 10 | — | — | — | — | Ⓔ | Ⓒ | ⑨ |

(5) Selection of inverter capacity (5S)

The switch 5S has been factory-set to agree with the inverter capacity as shown in Table 11.

Table 11 Inverter Capacity
Selection

| VS-616HII Model CIMR- | kVA | 5S Notch |
|--------------------------|-----|----------|
| 0.4B | 1 | ① |
| 0.75B | 1.5 | |
| 2.2B | 3 | ② |
| 3.7B | 5 | ③ |
| 5.5B | 7.5 | |
| 7.5B | 10 | ④ |

(6) Selection of operation modes (6S)

Select the operation modes from Table 12 according to the application, and set the switch (6S) as appropriate. All notches have been factory-set to OFF (□).

Table 12 Selection of Operation Modes

| 6S Notch | Function | ON/OFF Setting | Description of Operation Mode |
|----------|--|----------------|---|
| ① | Dynamic Braking (DB) | OFF | The motor is decelerated until it reaches 1/40 rated speed with the frequency reduced, and DB operation is performed at the speeds less than 1/40 rating. |
| | | ON | The motor is decelerated until it reaches 1/40 rated speed with the frequency reduced, and is coasting to a stop |
| ② | Stopping | OFF | The motor stops in the mode set by notch ① of 6S when a STOP command is input. |
| | | ON | The motor is coasting to a stop when a STOP command is input ignoring 6S setting of notch ① |
| ③ | Stall Prevention during Deceleration | OFF | Too high load GD^2 during deceleration activates stall prevention function and extends the set decel time |
| | | ON | Stall prevention function during deceleration not provided. |
| ④ | Stopping Free-run Motor | OFF | DB operation is not applied at the start |
| | | ON | Motor starts after DB operation is applied (DB operation within 1/5 decel time) |
| ⑤ | Operation Continuation after Momentary Power Failure | OFF | Motor coasts to a stop after momentary power failure |
| | | ON | Motor resumes running after momentary power failure of approximately 2 seconds or less; it coasts to a stop more than 2 seconds of momentary power failure. |
| ⑥ | Operation Continuation after Momentary Power Failure* (When notch ⑤ of 6S is ON) | OFF | Restarts operation after motor residual voltage is reduced upon recovery from momentary power failure. |
| | | ON | Immediately restarts operation upon recovery from momentary power failure.† |
| ⑦ | Jogging | OFF | Full-voltage operation is performed at 1/10 rated speed when jog command is input |
| | | ON | Frequency acceleration and deceleration is performed at 1/10 rated speed when jog command is input |
| ⑧ | Supply Voltage | OFF | 200 to 230 V. |
| | | ON | 380 to 460 V |

*Speed search function starts when motor speed is decreased due to momentary power failure and load current.

† OC (overvoltage) protective circuit may be activated according to power recovery timing and load conditions.

AC reactor should be connected or an inverter one size larger than specified should be selected.

5.2 PRESETTING AND ADJUSTMENT BEFORE TEST RUN (Cont'd)

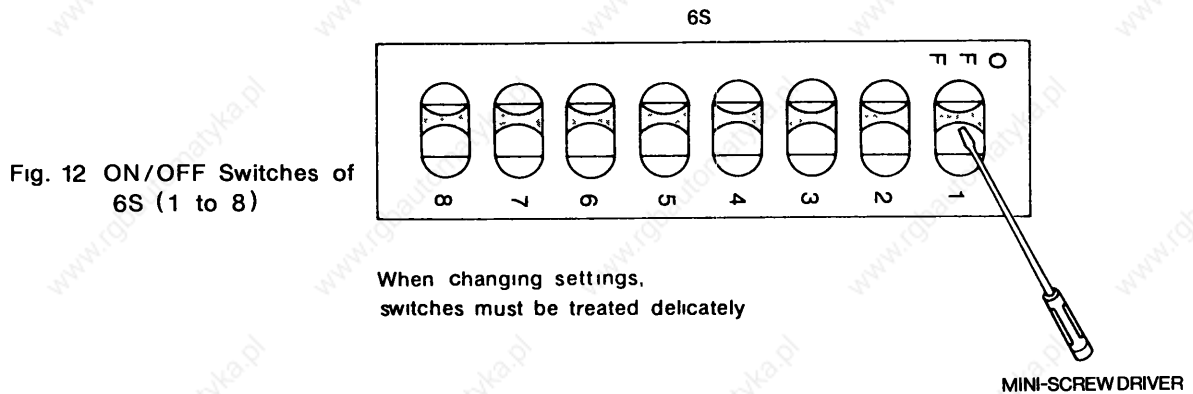

(7) Selection of master frequency reference signal

When the frequency reference signal is input from input terminal ⑨, select either a current signal (4 to 20 mA) or a voltage signal (0 to 10 V) (Fig. 13). The voltage reference signal (V) is factory-selected.

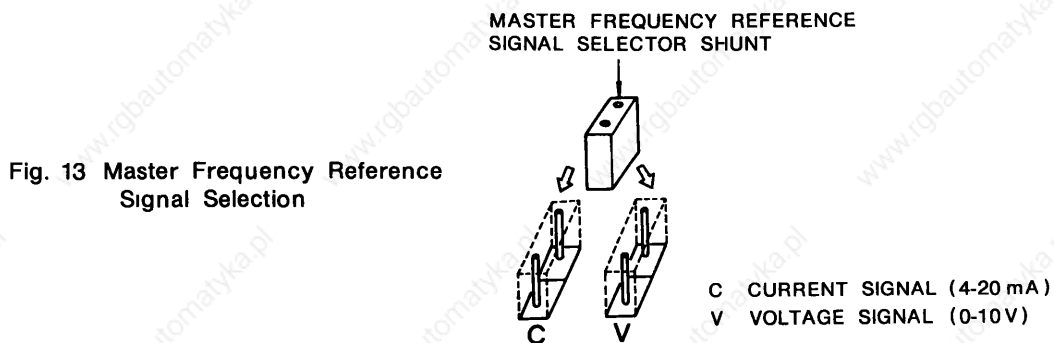

(8) Selection of auxiliary frequency reference signal

When the Analog operator (optional) is not used, input terminal ⑳ can be used for frequency setting. The auxiliary frequency reference signal selector shunt must be set as illustrated in Fig. 14.

The shunt is factory-set to (L) for use with Analog operator, and to (R) for other applications.

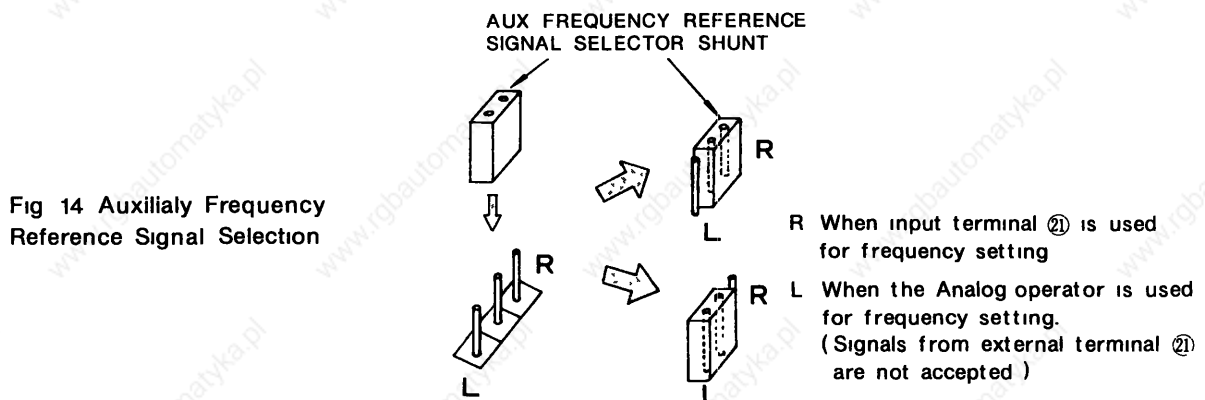

(9) Radio noise reducing filter selection

Radio noise reducing filter is incorporated. If ground fault breaker trips, remove the short-circuit lead across terminals E_N and E .

Ground circuit is disconnected and erroneous operation is prevented.

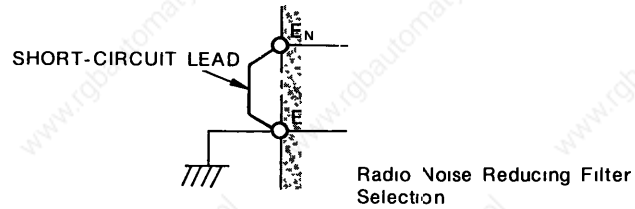

5. 3 TRIAL OPERATION/TEST RUN

Whenever possible, uncouple the motor from the driven machine. If the motor must be rotated with the driven machine connected, make sure that all dangerous conditions have been eliminated.

Fig. 15 shows the run-stop time chart when notches ① and ② of operation mode setting switch 6S are set to OFF.

Test run procedure is given in three ways (use of Analog operator, Digital operator, and VS operator). If any fault occurs, isolate the trouble spot, referring to par. 9 Troubleshooting.

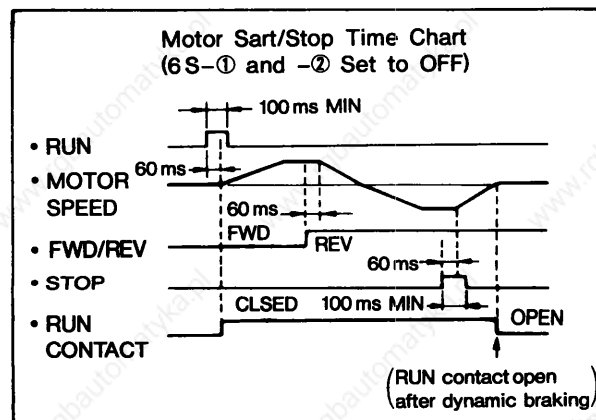

Fig 15 Run and Stop Time Chart

5.3.1 Use of Analog Operator Model JVOP-72□ (Optional)

1. Set the AUTO/MAN switch to MAN, move the FWD/REV switch to FWD, and turn the FREQ SET potentiometer fully counterclockwise to LOW.
2. Turn on the VS-616HII AC main circuit power (circuit breaker). The STOP lamp (orange) lights.
3. Move the RUN/STOP switch to RUN with the FREQ SET potentiometer at LOW. It causes the RUN lamp (green) to light.
4. Slowly turning the FREQ SET potentiometer clockwise starts running the motor, with the frequency meter reading the output frequency. Make sure that the motor is running forward. If shaft rotation is incorrect, turn off AC main circuit power, and reverse any two of motor leads U(T1), V(T2), W(T3).
5. By turning the FREQ SET potentiometer slowly clockwise or counterclockwise, the motor accelerates or decelerates smoothly. Set the maximum motor speed by turning the FREQ SET potentiometer fully clockwise to HIGH and check the motor for normal running. After this check, return the FREQ SET potentiometer fully counterclockwise to LOW.
6. To stop the motor, set the RUN/STOP switch to STOP, and the STOP lamp comes on.

PRESET START

To make the preset start (a "one-touch" operation at a preset frequency), use steps 1 to 2 mentioned above and then proceed as follows.

(a) Set the frequency using frequency setting potentiometer. Move the RUN/STOP switch to RUN, and the motor accelerates within the time set in par. 5.2 (2) on page 17, then keeps on running at the preset frequency. If the motor does not run smoothly during acceleration (with the acceleration stall prevention function working), or if any FAULT lamp comes on, the acceleration time is assumed to have been set too short for the load level; extend the acceleration time.

(b) Set the RUN/STOP switch to STOP to stop the motor. The motor decelerates in the time set in par. 5.2 (2) on page 17, then stops. If the motor does not run smoothly during deceleration function working), or if any failure indicator comes on, the deceleration time is assumed to have been set too short for the load level; increase the deceleration time.

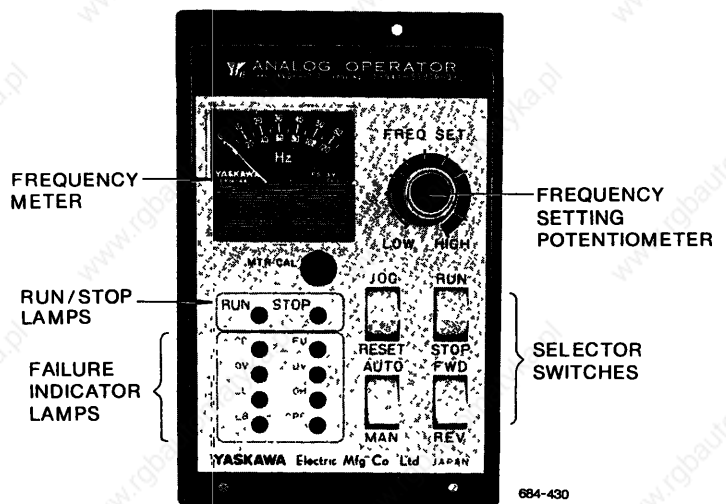

Fig 16 Analog Operator (Optional)

5.3.2 Use of Digital Operator Model JVOP-71 (Optional) (Fig. 17)

1. Turn on the VS-616H AC main circuit power (circuit breaker). Then "AUTO," "MONI," "0.0 Hz," "STOP," and "FWD" are shown on the Digital operator display.
2. Display "MAN" by pressing

| |
|------|
| AUTO |
| MAN |

 key.
3. Make sure that "FWD" is displayed.
If "REV" is displayed, press

| |
|-----|
| FWD |
| REV |

 key to display "FWD."
4. Confirm that the motor runs forward slowly while

| |
|-----|
| JOG |
|-----|

 key is being pressed. If shaft rotation is incorrect, turn off AC main circuit power, and reverse any two of motor leads. (The jog operation mode outlined in par. 5.2 (6) on page 19 is selected.)
5. Display "REV" by pressing

| |
|-----|
| FWD |
| REV |

 key again, and make sure that the motor runs in reverse direction with JOG key pressed.
6. Pressing

| |
|------|
| DISP |
|------|

 key changes "MONI" to "SET," placing the operator in the setting mode. Select a digit to be set by operating

| |
|---|
| < |
|---|

 or

| |
|---|
| > |
|---|

 key. It is indicated by blinking. Pressing

| |
|---|
| < |
|---|

 key moves blinking one space to the left, and

| |
|---|
| > |
|---|

 key one space to the right. Set the required frequency by operating

| |
|---|
| △ |
|---|

 or

| |
|---|
| ▽ |
|---|

. Pressing

| |
|---|
| △ |
|---|

 key increases the blinking value by one, and

| |
|---|
| ▽ |
|---|

 key decreases by one. After finishing the setting, press

| |
|-------|
| ENTER |
|-------|

 key.
7. Pressing

| |
|-----|
| RUN |
|-----|

 key displays "RUN." The motor then accelerates within the preset acceleration time and keeps on running at the frequency set in step 6.
8. To display the output frequency, press

| |
|------|
| DISP |
|------|

 key again. "SET" changes to "MONI," and the output frequency appears.
9. Pressing

| |
|------|
| STOP |
|------|

 key switches "RUN" to "STOP." The motor then decelerates within the preset deceleration time and stops.

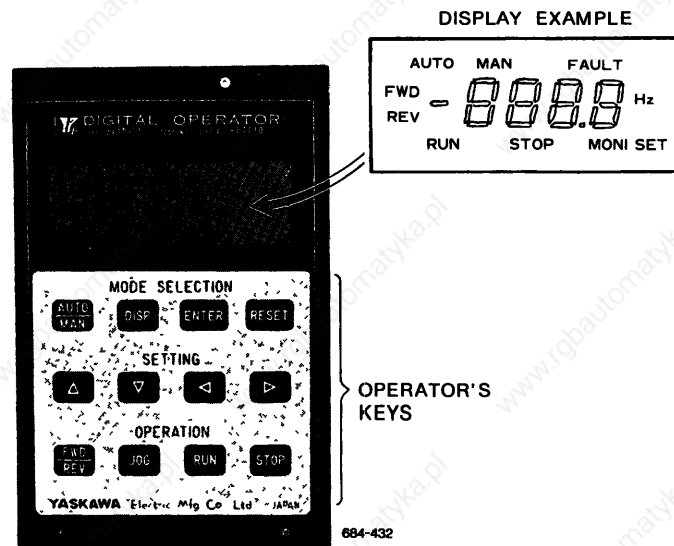

Fig 17 Digital Operator (Optional)

5.3.3 Use of VS Operator Model JVOP-65 (Optional) (Fig. 18)

Complete the connection of units according to example in Fig. 7, on page 11 and perform the test run using the following procedures.

1. Set the MASTER/AUX switch to MASTER, move the FWD/REV switch to FWD, and turn the FREQ SET potentiometer fully counterclockwise to LOW.
2. Turn on the VS-616HI AC main circuit power (circuit breaker), and the SOURCE lamp (green) will light.
3. Change the RUN/STOP switch to RUN with the FREQ SET potentiometer at LOW, and RUN lamp (green) will light.
4. Slowly turning the FREQ SET potentiometer clockwise causes the motor to start running and the frequency meter to indicate the output frequency. Make sure that the motor is running forward. If shaft rotation is incorrect, turn off AC main circuit power, and reverse any two of motor leads $\text{U}(\text{T1})$, $\text{V}(\text{T2})$, $\text{W}(\text{T3})$.
5. By turning the FREQ SET potentiometer clockwise or counterclockwise, the motor accelerates or decelerates smoothly. Also, set the maximum speed of the motor by turning the FREQ SET potentiometer fully clockwise to HIGH, and check the motor for normal running. After this check, return the FREQ SET potentiometer fully counterclockwise to LOW.
6. To stop the motor, set the RUN/STOP switch to STOP, and the RUN lamp goes out after the motor stops.

PRESET START

To make the preset start (a "one-touch" operation at a preset frequency), apply steps 1 to 2 mentioned above and then proceed as follows.

(a) Set the frequency using frequency setting potentiometer. Set the RUN/STOP switch to RUN, and the motor accelerates within the time set in par. 5.2 (2) on page 17, then keeps on running at the preset frequency. If the motor does not run smoothly during acceleration (with the acceleration stall prevention function working), or if a FAULT lamp comes on, the acceleration time is assumed to have been set too short for the load level; increase the acceleration time.

(b) To stop the motor, change the RUN/STOP switch to STOP. The motor decelerates within time set in par. 5.2 (2) on page 17, then stops. If the motor does not run smoothly during deceleration (with the deceleration stall prevention function working), or if a FAULT lamp comes on, the deceleration time is assumed to have been set too short for the load level; increase the deceleration time.

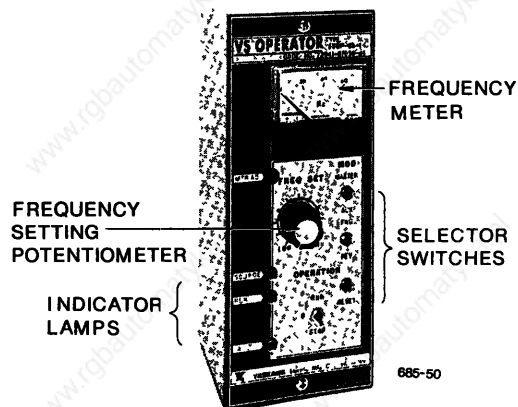

Fig. 18 VS Operator (Optional)

5.4 FREQUENCY METER CALIBRATION

When the Analog or VS operator is used, the frequency meter must be calibrated. The motor need not be run during calibration. Perform the following procedures:

1. Shut off the AC main circuit power.
2. Record the position (notch number) of setting switch 2S on the control PC board.
3. Set 2S to notch ①.
4. Turning on the main circuit power causes the meter to indicate approximately the rated frequency.
5. Adjust MTR CAL potentiometer of the Analog operator (or MTR ADJ potentiometer of the VS operator) so that the meter reads the rated frequency.
6. After the adjustment, turn off AC main circuit power again, then return setting switch 2S to the recorded position.

6. OPERATION AT LOAD

After the no-load operation, turn off the AC main circuit power, and connect the driven machine to the motor. Make sure that the driven machine is in running condition, and there is no danger around VS-616HII system, and run the motor under load in exactly the same way as for test run.

PRECAUTION

- (1) Start the motor after making sure that the motor is stopped. If the operation is started during motor coasting, overvoltage (OV) or overcurrent (OC) protective circuit may be operated.
- (2) The motor can be operated by an operation signal from either the inverter-mounted operator or external terminal ②. This selection can be made only when the inverter is standby.
- (3) The motor can be stopped unconditionally by a STOP signal from either the inverter-mounted operator or external terminal ③. Either stop command takes priority over any other command in operation.
- (4) When a standard motor is driven with the inverter, there is a little increase in motor temperature, noise, and vibration as compared to the operation from the commercial power supply.
- (5) The motor cooling effect lowers during low-speed running. The torque needs to be reduced in accordance with the frequency. (For the reduction ratio, refer to the catalog or technical sheet.)
- (6) Even with small load, never use a motor whose current exceeds the inverter rating. When two or more motors are operated, check to be sure that the total motor current is not larger than inverter rating.
- (7) When starting and stopping the motor, be sure to use the operation signals (RUN and STOP), not the magnetic contactor on the power supply side. Exception: If the magnetic contactor is to be used to start and stop a motor, see A3-2, (5) on page 41. Care should be taken not to start and stop the motor frequently.

7. MAINTENANCE

VS-616HII requires almost no routine checks. It will function efficiently and longer if it is kept clean, cool and dry, observing precautions listed in 3.1 Location, on page 9. Especially check for tightness of electrical connections, discoloration or other signs of overheating. Use Table 13 as the inspection guide. Fig. 19 gives the exploded view of VS-616HII to easily identify the components for inspection. Before servicing inspection, turn off AC main circuit power and be sure that CHARGE lamp is off.

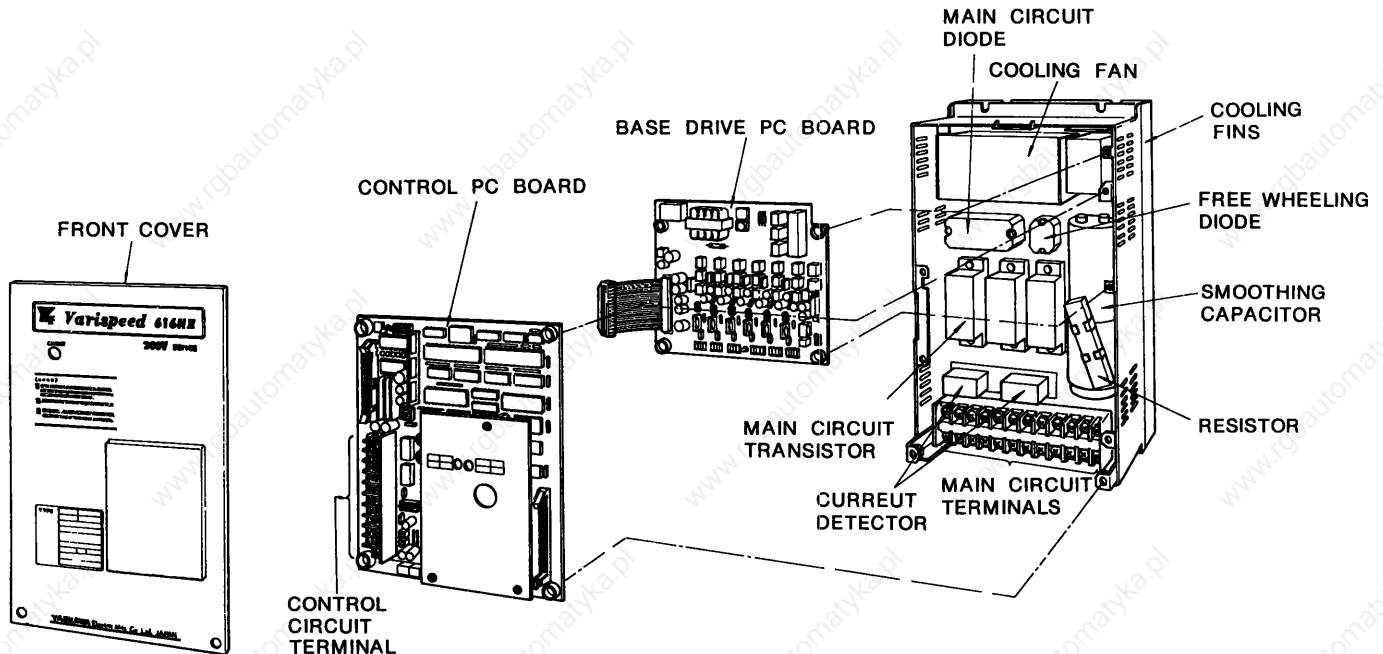

Fig. 19 Exploded View of VS-616 HII

Table 13 Periodical Inspection

| Component | Check | Corrective Action |
|---|--|--|
| External terminals, unit mounting bolts, connectors, etc. | Loosened screws | Tighten |
| | Loosened connectors | Tighten |
| Cooling fins | Build-up of dust and dirt | Blow with a dry compressed air of 4 to 6 kg·cm ² (57 to 85 lbs·in ²) pressure |
| Printed circuit board | Accumulation of conductive dust and oil mist | Clean the board. If dust and oil cannot be removed, replace the board. |
| | Discoloration to brown | Replace the board. |
| Cooling fan (for Models CIMR-5.5B and -7.5B) | For abnormal noise and vibration. Whether the cumulative operation time exceeds 20,000 hours or not. | Replace the cooling fan. |
| Power elements | Accumulation of dust and dirt | Blow with a dry compressed air of 4 to 6 kg·cm ² (57 to 85 lbs·in ²) pressure |
| Smoothing capacitor | Discoloration or odor | Replace the capacitor or inverter unit. |

8. FAILURE INDICATION AND DETAILS

A failure, if it is detected, can shut off the output power transistor and output FAULT contact signals across control circuit terminals ⑭, ⑮, and ⑯.

When Analog or Digital operator is used, failure indications listed in Table 14 will function. When neither of them is used, failure conditions are shown by FAULT lamps F1 and F2 on the VS-616HII.

Table 14 Failure Indication

| Indication | | Symptom | VS 616 HII Operation |
|---|--|---|--|
| FU (Fuse Blown) | | Main circuit fuse blown | Inverter stops output momentarily (Motor is coasting) |
| OC (Overcurrent) | | More than 200 percent of rated current flow in inverter output side (Instantaneous operation) | |
| OL (Overload) | | Overload of motor and inverter detected by electronic thermal | |
| OV or OU ^{††} (Overvoltage) | | Main circuit DC voltage higher than approx 395 V | |
| UV* or UU* [†] (Undervoltage) | | Main circuit DC voltage lower than approx 210V | |
| OH (Heat Sink Overheat) | | Thermoswitch operated by overheat of heat sink of main circuit semiconductor | |
| EB or Eb [†] (External Failure) | | Fault signal is input from external terminal ⑦ | # |
| CPF | Steady (Major Control Function Error) | CPU and major control function error detected by self-diagnostic function | |
| | Blinks (Setting error) | Any one of setting switches (1S to 6S) changed with power ON | |

* In operation continuation after a momentary power failure mode (⑤ notch of 6S ON), UV lamp is flashing for approx two seconds

† For Digital operator display

†† FAULT will be displayed with OU on the screen of Digital operator

Inverter continues operation When the setting is returned to the state before change, the display replaces the normal operation status

Table 15 Failure Indication of VS-616 HII

| Indication | | Cause | VS 616 HII Operation |
|------------|----|---|--|
| F1 | F2 | | |
| | | FU (Fuse Blown) Main circuit fuse blown | Inverter stops output momentarily (Motor is coasting) |
| | | OC (Overcurrent) More than 200 percent of rated current flow in inverter output side | |
| | | OL (Overload) Overload of motor and inverter detected by electronic thermal overload protective circuit | |
| | | OV (Overvoltage) DC bus voltage higher than 395V | |
| | | UV 1 (Undervoltage) DC bus voltage lower than approx 210V with 6S-⑤ set to ON (F1 blinking for 2 seconds UV 1 indication changed to UV 2) | |
| | | UV 2 (Undervoltage) DC bus voltage lower than 210V | |
| | | OH (Heat Sink Overheat) Thermoswitch operated by overheat of heat sink of main circuit semiconductor | # |
| | | EB (External Failure) Fault signal is input from external terminal ⑦ | |
| | | CPF (Control Function Error) Detection of the failure of CPU and main control function by self-diagnostic function | |
| | | CPF SEL (Selection Error) Any one of setting switches (1S to 6S) changed with power ON | # |

Note Indication status is as follows

Light OFF

Blinking at equal intervals

Blinking at short-long intervals

Light ON

Inverter continues operation When the setting is returned to the state before change, the display replaces the normal operation status

9. TROUBLESHOOTING

If the VS-616HII malfunctions, find the cause and take the corrective action by following the flowcharts given in this section.







If the cause cannot still be located by the flowcharts, the inverter or some parts are damaged, or any other problem occurs, contact Yaskawa representative.

9.1 MEASURING POINT AND INSTRUMENT

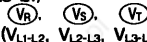
Since the VS-616HII transistor inverters utilize the PWM control mode, unless specified instruments are used, correct measurement cannot be made.

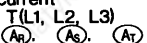
The measuring points and the measuring instruments are shown in Fig. 20 on page 28 and Table 16.

Table 16 Measuring Points and Instruments

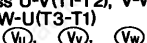
| Item | Points | Instrument | Note |
|-------------------------------------|--|--|--|
| Supply Voltage V_1 | Across R-S(L1-L2), S-T(L2-L3) T-R(L3-L1) (V_R, V_S, V_T) $(V_{L1-L2}, V_{L2-L3}, V_{L3-L1})$ |  Moving-iron type, or rectifier type voltmeter | — |
| Power Supply Current I_1 | Line current R, S, T(L1, L2, L3) (A_R, A_S, A_T) (A_{L1}, A_{L2}, A_{L3}) |  Moving-iron type | — |
| Power Supply Power* P_1 | R, S, T(L1, L2, L3) and across R-S(L1-L2), S-T(L2-L3) T-R(L3-L1) (W_R, W_S, W_T) (W_{L1}, W_{L2}, W_{L3}) |  Electro-dynamometer type, Use 3 identical single-phase meters | $P_1 = W_R + W_S + W_T$ |
| Power Supply Power Factor Pf_1 | Calculate from measured supply voltage, supply current, and supply power $Pf_1 = \frac{P_2}{\sqrt{3}V_1 I_1} \times 100 (\%)$ | | |
| Output Voltage V_2 | Across U-V(T1-T2), V-W(T2-T3), W-U(T3-T1) (V_U, V_V, V_W) $(V_{T1-T2}, V_{T2-T3}, V_{T3-T1})$ |  Rectifier type (YOKOGAWA 2017 or equivalent) Moving-iron type can not be used | 1000 V full scale for 400 V circuit |
| Output Current I_2 | Line current at U, V, W(T1, T2, T3) (A_U, A_V, A_W) (A_{T1}, A_{T2}, A_{T3}) |  Moving-iron type | — |
| Output Current P_2 | U, V, W(T1, T2, T3) and across U-V(T1-T2), V-W(T2-T3), W-U(T3-T1) (W_U, W_V, W_W) (W_{T1}, W_{T2}, W_{T3}) |  Electro-dynamometer type, Three identical rating single-phase meters are used | $P_2 = W_U + W_V + W_W$ |
| Output Power Factor Pf_2 | Calculated same as power factor on supply side $Pf_2 = \frac{P_2}{\sqrt{3}V_2 I_2} \times 100 (\%)$ | | |
| Frequency Setting Signal | Across ①-⑩ Across ⑪-⑫ |  Moving-coil type (Multimeter is OK) (Internal resistance 50 kΩ max) | 0 to 10 V DC |
| Frequency Monitor | Across ⑬-⑭ | | 10 VDC at max frequency (Without frequency meter) |

*To measure the power, use the power meter incorporating a hall generator
HIOKI TYPE 3161 Power meter (made by HIOKI Electric, Japan)

The output voltage $U(T1)$, $V(T2)$, $W(T3)$ has been measured with a YOKOGAWA 2017 (moving iron type) voltmeter before shipping.

Fig. 21 on page 28 shows an example of actually measured output voltage. The rectifier type instruments give different readings, depending on type.

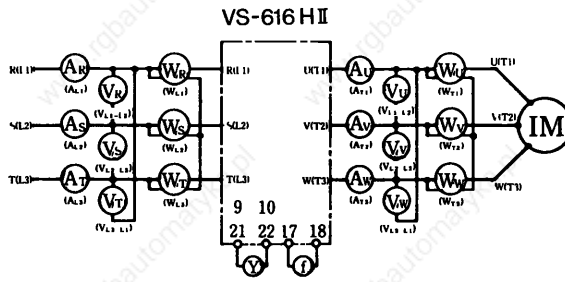

Fig 20 Points for Measurement

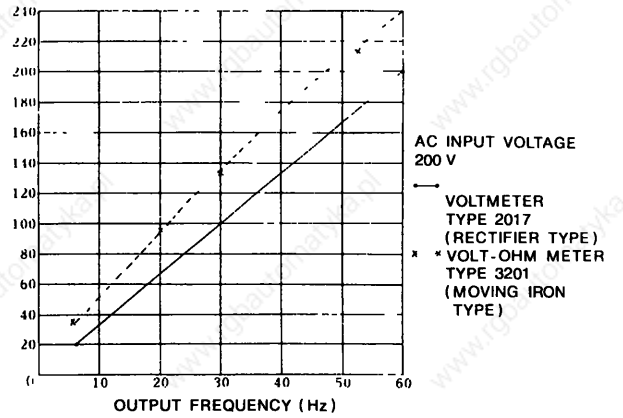
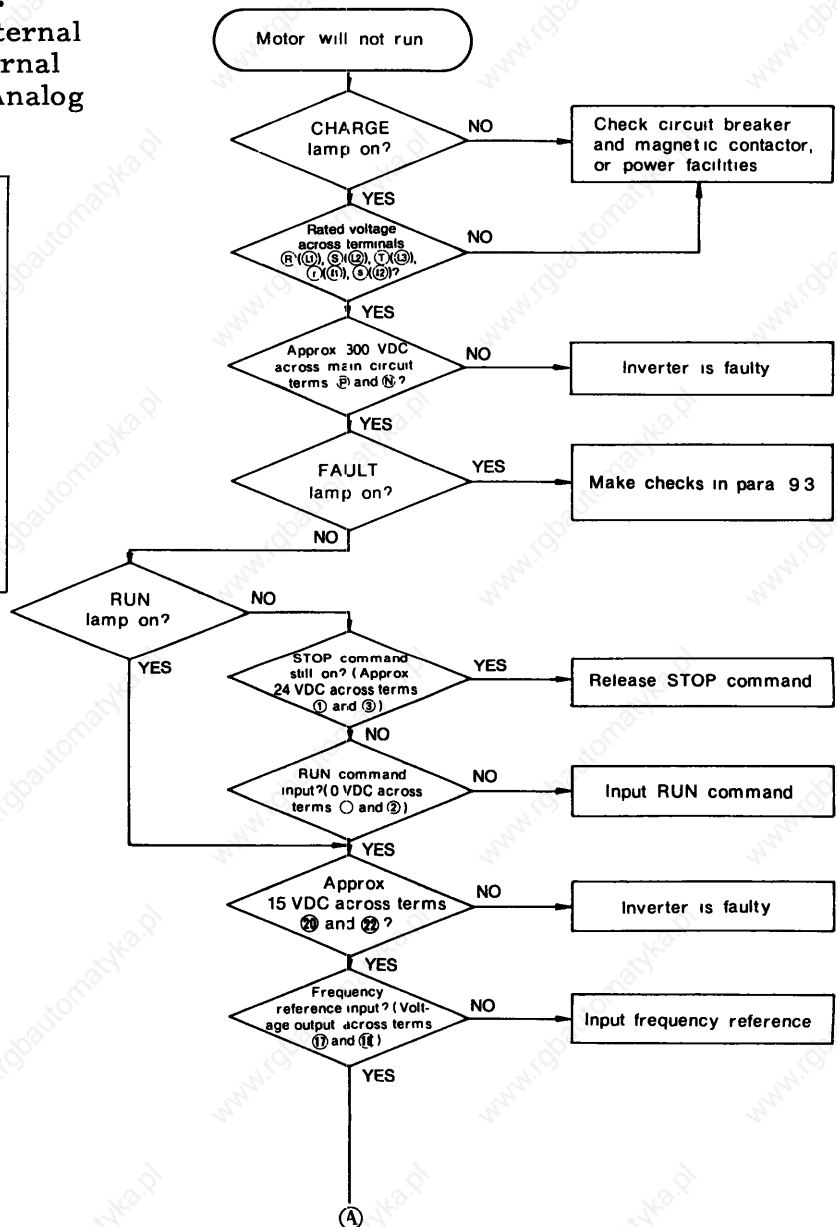
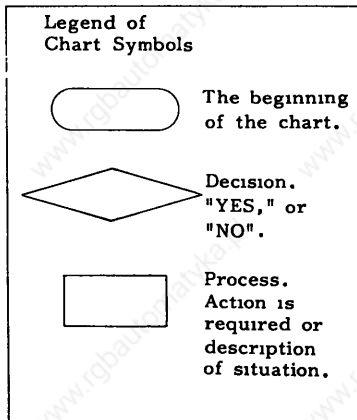

Fig 21 Output Voltage Measurement

9. 2 TROUBLESHOOTING FOR MOTOR SYMPTOM

(1) Motor will not run.

For operation from external command through external terminals (Digital or Analog operator not used)



Continued to A on page 30

9. 2 TROUBLESHOOTING FOR MOTOR SYMPTOM (Cont'd)

Continued from (A) on page 29

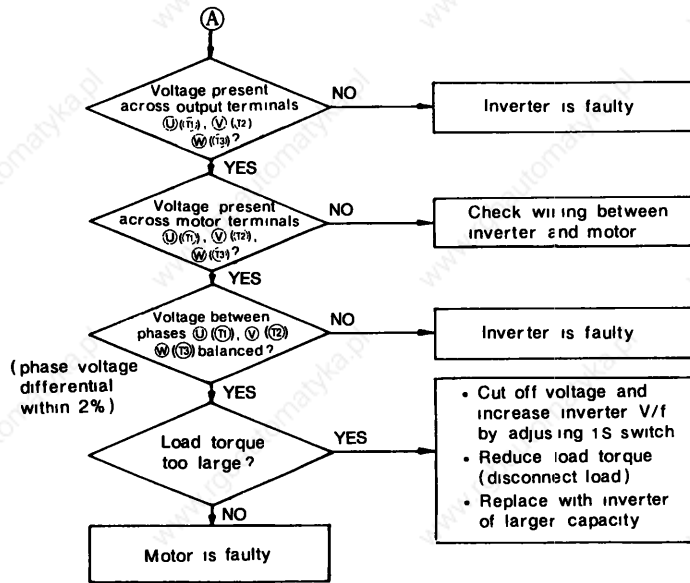

(2) Motor stalls during acceleration

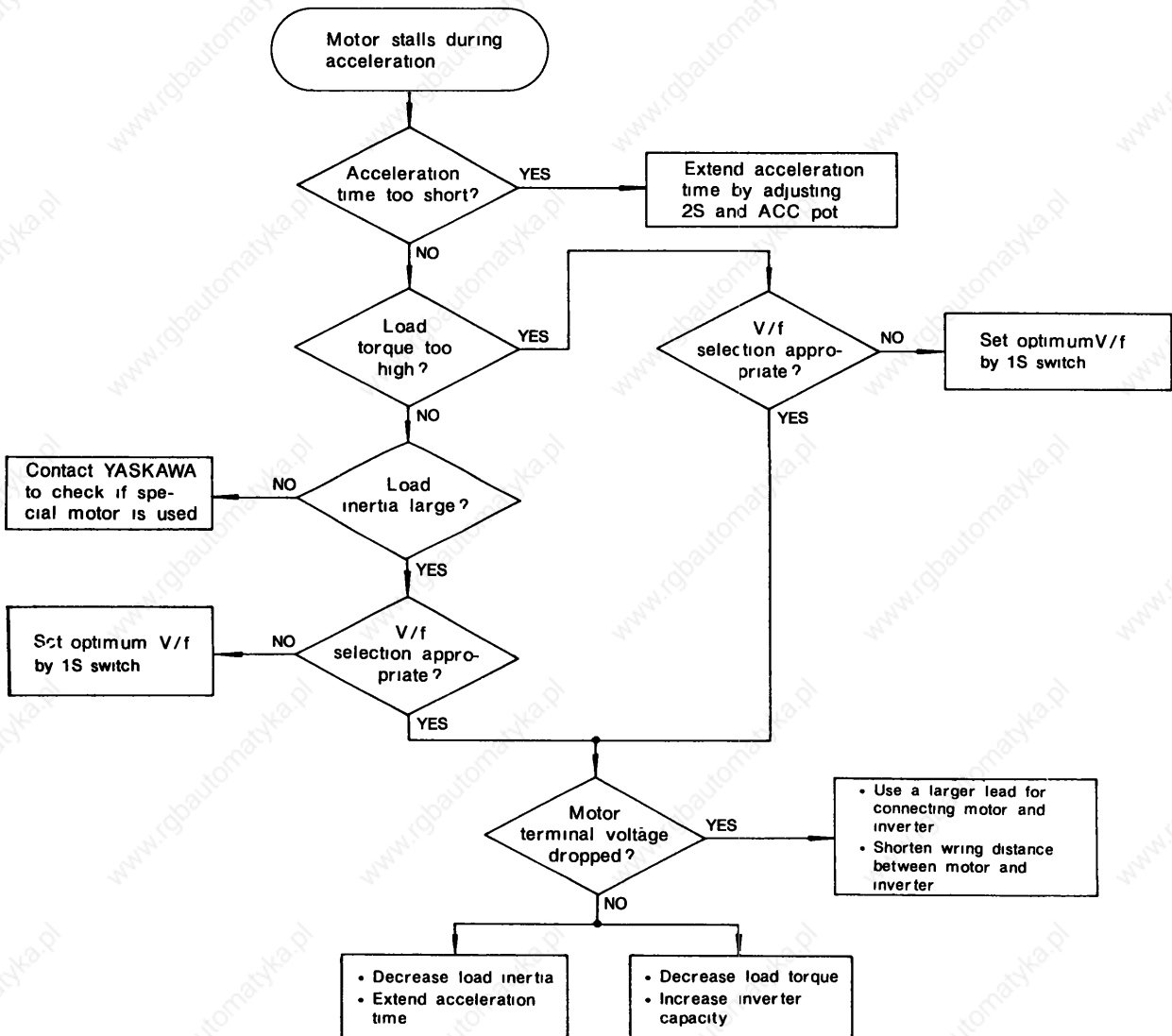

9.3 TROUBLESHOOTING FOR FAILURE INDICATIONS

When the inverter protective function works, the malfunctions are detected by failure indicators. The predictable symptoms are as follows:

- (1) Fuse blown
- (2) Overvoltage of the main circuit DC bus.
- (3) Overcurrents in load.
- (4) Overloaded operation.
- (5) Undervoltage of the main circuit DC bus.
- (6) The inverter overheated.
- (7) The control function went down.
- (8) A fault signal input.

(1) Fuse blow (FU) is turned on:

When the fuse blows, be sure to check the power transistor, even when the cause is on the load side.

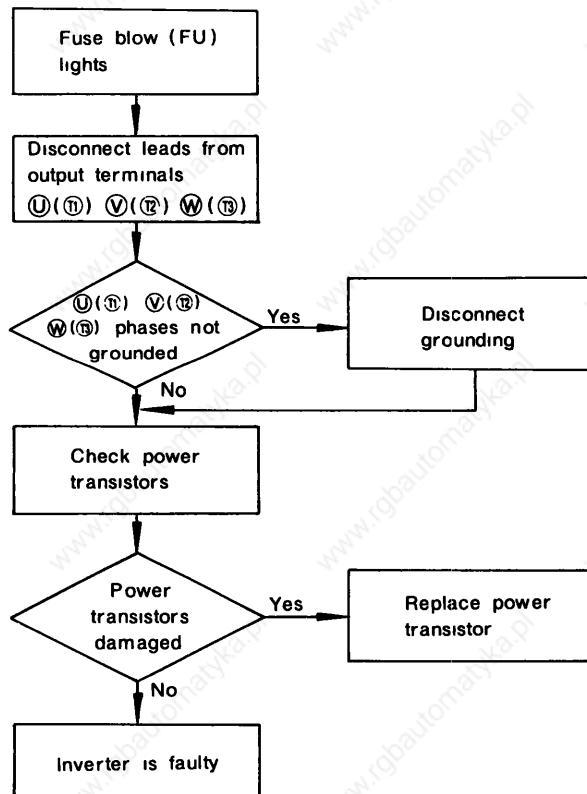

9. 3 TROUBLESHOOTING FOR FAILURE INDICATIONS (Cont'd)

(2) Overvoltage (OV) indication

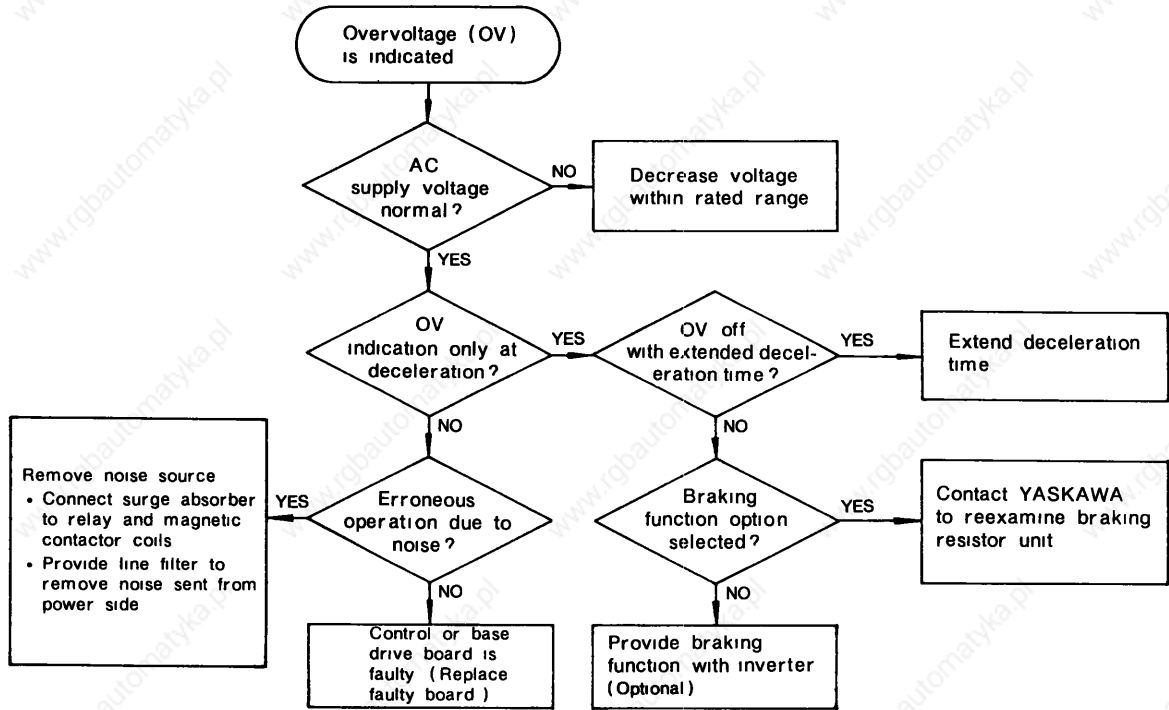

(3) Overcurrent (OC) indication

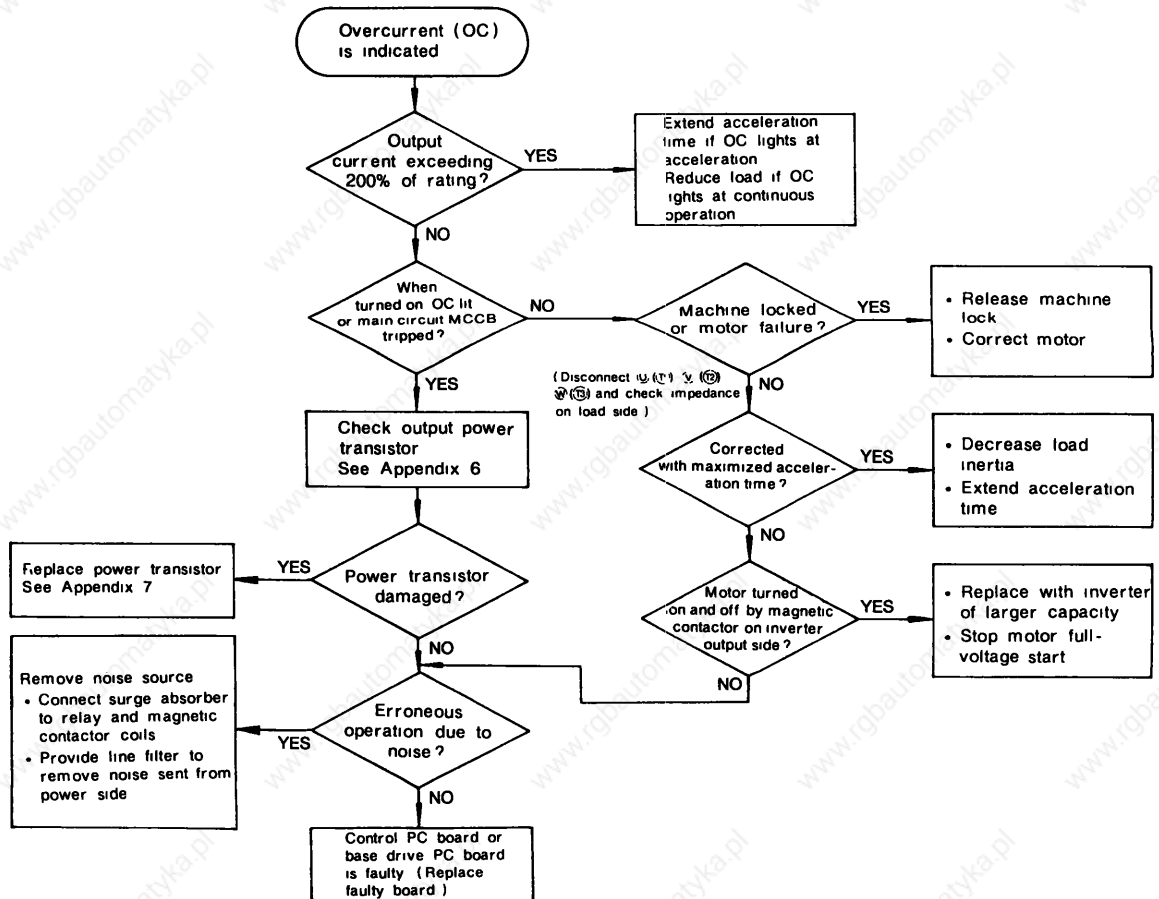

(4) Overload (OL) indication

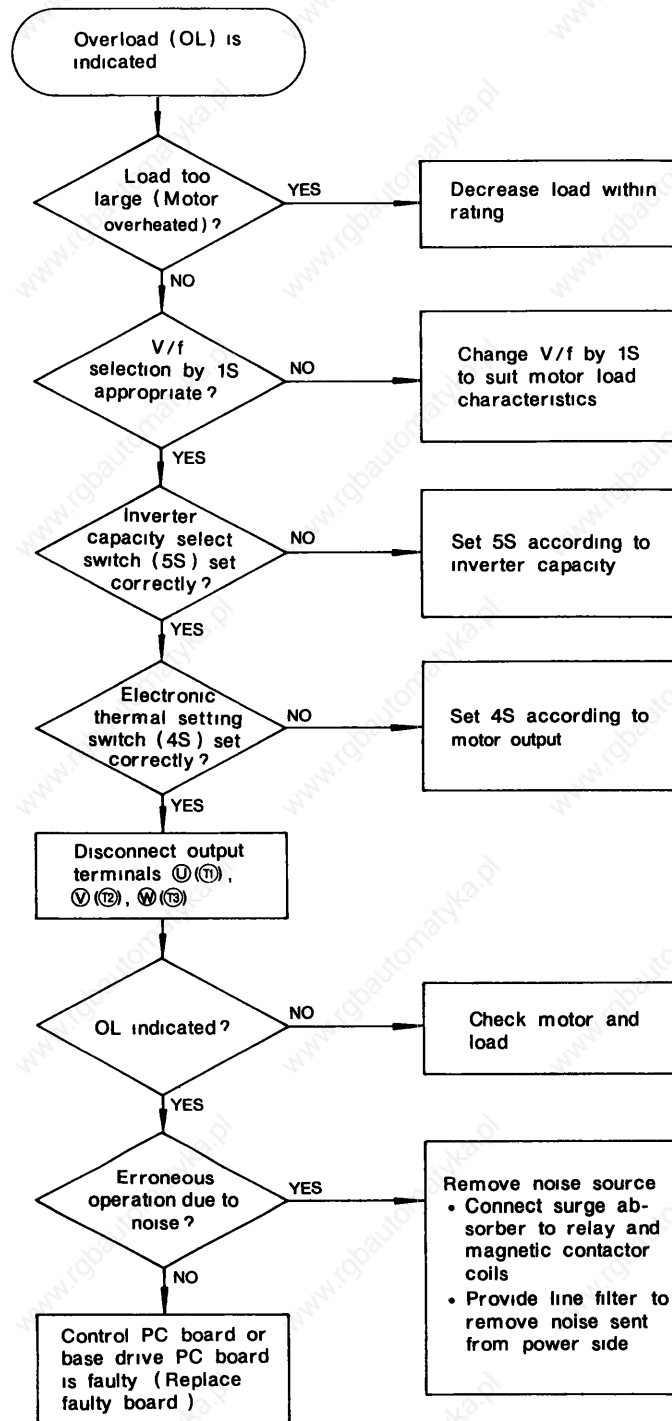

9. 3 TROUBLESHOOTING FOR FAILURE INDICATIONS (Cont'd)

(5) Undervoltage (UV) indication

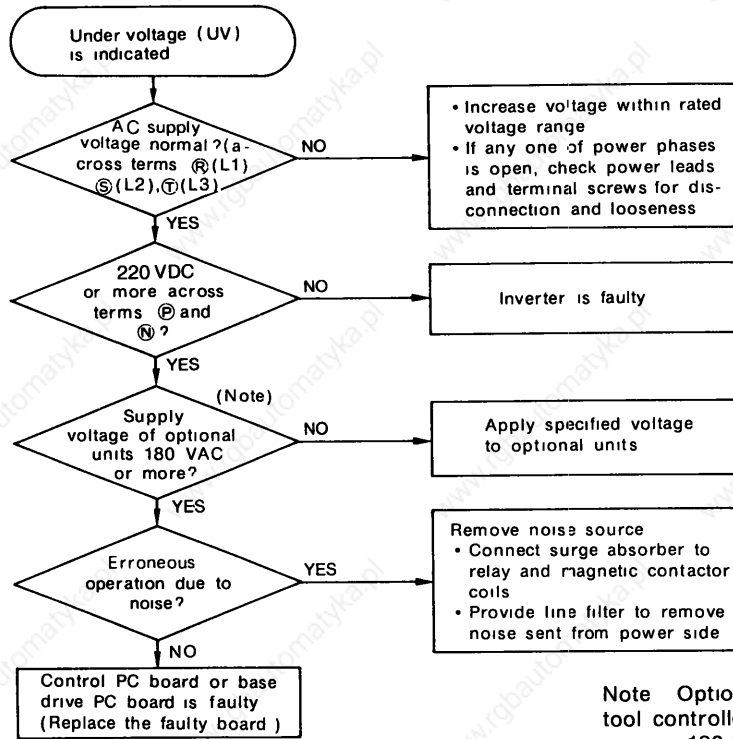

Note Optional units such as machine tool controller and precision controller require 180 to 253 VAC as supply voltage

(6) Inverter overheat (OH) indication

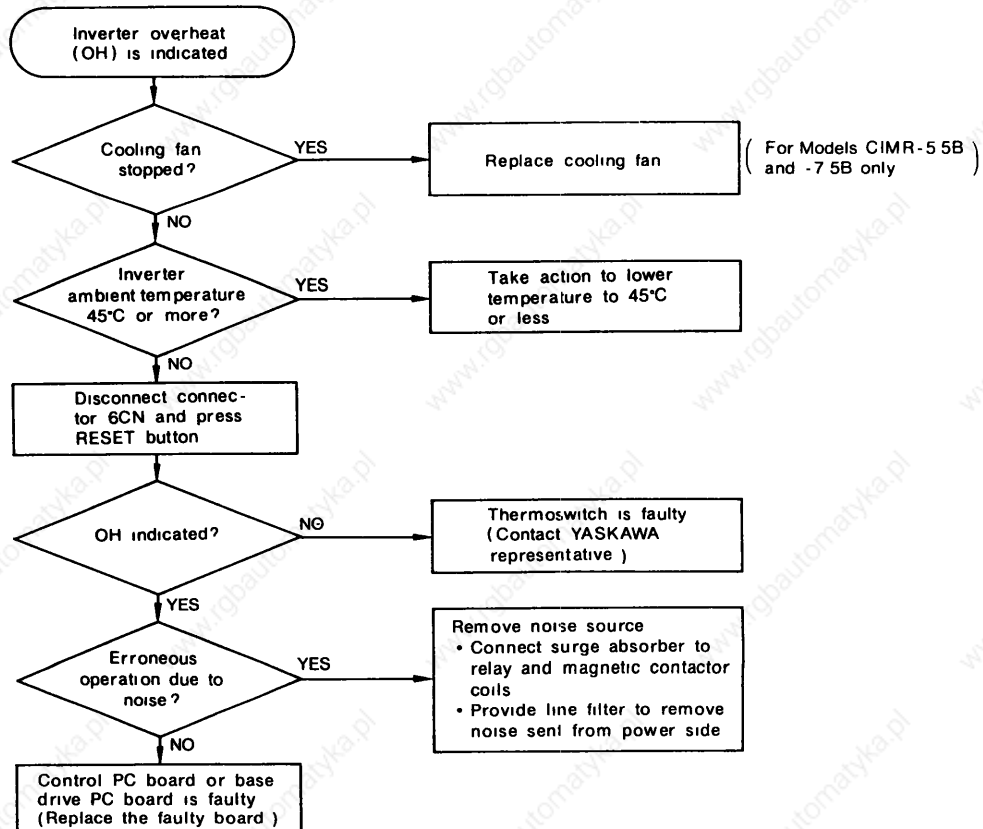

(7) Major control function error (CPF) indication

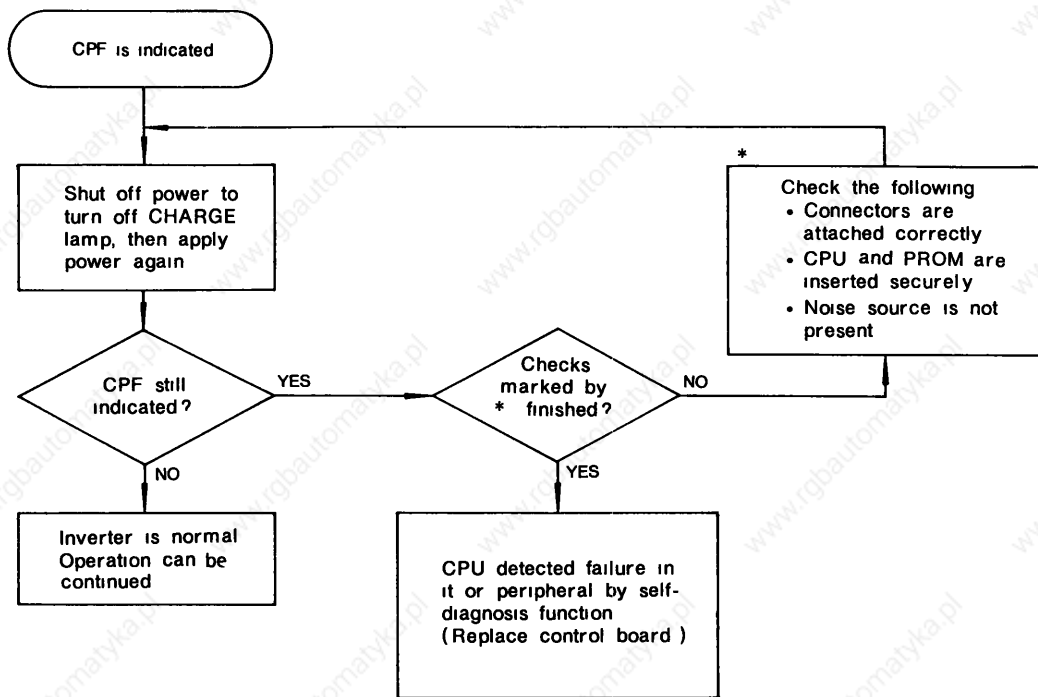

(8) External failure (EB) indication

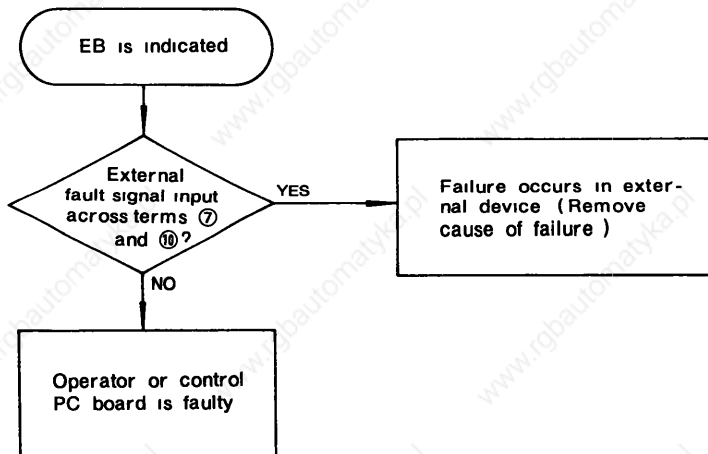

APPENDIX 1 VS-616H II RATINGS AND SPECIFICATIONS

Table 17 VS-616H II Ratings and Specifications

| Inverter Model CIMR- () | | 04B | 075B | 22B | 37B | 55B | 75B |
|---------------------------|--|--|------------------------------|------------|-----------|---|-----------|
| Output Characteristics | Max Applicable Motor Output (1) kW (Hp) for 4-pole | 0.5 (0.5) | 0.75 (1) | 2.2 (3) | 3.7 (5) | 5.5 (7.5) | 7.5 (10) |
| | Inverter Capacity (2) kVA | 1 (1.3) | 1.5 (2.0) | 3 (3.9) | 15 (6.6) | 7.5 (10) | 10 (13.1) |
| | Rated Output Current (3) A | 3 (3.3) | 4.5 (5.0) | 9 (9.9) | 15 (16.5) | 23 (25.3) | 30 (33) |
| | Rated Output Voltage | 3-Phase, 200/208/220/230 VAC | | | | | |
| | Rated Output Frequency | 50, 60, 72, 90, 120, 180 Hz (240, 360 Hz available as an option) | | | | | |
| Power Supply | Rated Input Voltage and Frequency | 3-Phase, 200/208/220/230 V, 50/60 Hz | | | | 3-Phase, 200/208/220 V, 50 Hz, 200/208/220/230 V, 60 Hz | |
| | Allowable Voltage Fluctuation | Within $\pm 10\%$ | | | | | |
| | Allowable Frequency Fluctuation | Within $\pm 5\%$ | | | | | |
| Control Characteristics | Control Method | Sine wave PWM | | | | | |
| | Frequency Control Range | 40-1 | | | | | |
| | Frequency Accuracy | Digital command 0.01% (-10 to 40°C), Analog command 0.2% (25°C $\pm 10^\circ\text{C}$) | | | | | |
| | Frequency Resolution | Analog input (0 to 10 V) 0.06 Hz/60 Hz, 0.18 Hz/180 Hz, 0.36 Hz/360 Hz Digital input 0.005 Hz/60 Hz, 0.015 Hz/180 Hz, 0.03 Hz/360 Hz | | | | | |
| | Overload Capacity | 150% for one minute | | | | | |
| | Frequency Setting Signal | 0 to 10 VDC, 4-20 mA (500 Ω) | | | | | |
| | Accel/Decel Time | 0.2 to 1800 sec, 6 ranges selectable, Accel/Decel time set independently | | | | | |
| | Efficiency | Approx 95% | | | | | |
| | Braking Torque | Approx 20% (100%, provided with braking module and braking resistor unit 10% duty cycle) | | | | | |
| | No of V/f Patterns | 15 in total 4 For general purpose, 4 For high starting torque 4 For fans and pumps, 3 For machine tools | | | | | |
| | Protective Functions | Motor Overload Protection | Electronic thermal relay (4) | | | | |
| Instantaneous Overcurrent | | Base blocked at approx 200% rated current | | | | | |
| Overload | | Base blocked at 150% load for 1 minute | | | | | |
| Overvoltage | | Base blocked if converter output voltage exceeds 395V | | | | | |
| Undervoltage | | Base blocked if converter output voltage drops to 210V or below | | | | | |
| Momentary Power Failure | | Immediately stop by momentary power failure detection (Continues system operation during power failure less than 2 sec by setting on notch ⑤ of 6S switch) | | | | | |
| Fin Overheat | | Thermostat | | | | | |
| Stall Prevention | | Stall prevention at acceleration/deceleration and constant-speed operation | | | | | |
| Environmental Condition | Power Charge Indication | Charge lamp keeps ON until converter output voltage drops below 50V | | | | | |
| | Location | Indoor (protected from corrosive gases and dust) | | | | | |
| | Ambient Temperature | -10 to 40°C (not frozen) (5) | | | | | |
| | Storage Temperature | -20 to 60°C (6) | | | | | |
| | Humidity | 90% RH (no condensation) | | | | | |
| Vibration | 1G less than 20Hz, up to 0.2G at 20 to 50 Hz | | | | | | |
| Approx Weight | kg (lbs) | 7 (15.40) | | 9 (19.80) | | 13 (28.63) | |
| Dimensions mm (in) | Width | 200 (7.87) | | 200 (7.87) | | 200 (7.87) | |
| | Height | 300 (11.8) | | 300 (11.8) | | 350 (13.77) | |
| | Depth | 175 (6.89) | | 205 (8.07) | | 215 (8.46) | |

- (1) For standard motors rated 4 poles at 60 Hz
- (2) Parenthesized values indicate max continuous output capacity
- (3) Parenthesized values indicate max continuous output current
- (4) Protects motors having the torque characteristics shown below

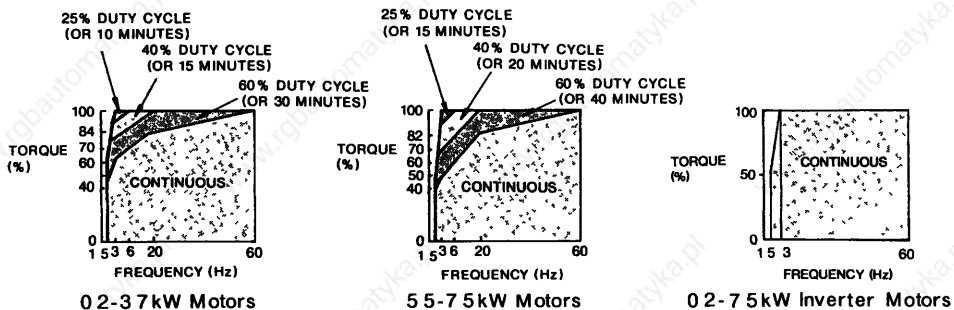

- (5) Up to 50°C when built-in a panel, with front cover removed
- (6) Temperature during shipping Storing in this temperature for a long-period may deteriorate main circuit capacitor, contact your Yaskawa representative

APPENDIX 2 TERMINAL FUNCTIONS

Table 18 Terminal Functions and Voltages of Main Circuit

| Terminals | Functions | Levels | |
|---|---|---|--|
| | | Model CIMR-0.4B to -3.7B | Type CIMR-5.5B and -7.5B |
| R (L1) S (L2) T (L3) | Main circuit input power supply | Three-phase 200/208/220/230 VAC at 50/ 60Hz (Voltage fluctuation $\pm 10\%$) | Three-phase 200/208/220 VAC, 50Hz; 200/208/220/230 VAC, 60 Hz (Voltage fluctuation $\pm 10\%$) |
| r (L1) s (L2) | Cooling fan input power supply (For Models CIMR-5.5B and -7.5B) | — | |
| U (T1) V (T2) W (T3) | VS-616HII output | Three-phase 200/208/220/230 VAC (corresponding to input voltage) | |
| B ₁ , B ₂ a, b | Braking module | 0 or Approx 300 VDC (across the terminals Ⓟ - Ⓝ) | |
| B ₃ | Braking resistor unit | | |
| P N | Main circuit DC power supply | Approx 300 VDC (across the terminals Ⓟ - Ⓝ) | |
| E | Ground terminal | — | |

Table 19 Terminal Functions and Signals of Control Circuit

| Terminals | Functions | Levels | |
|-----------|--|---|--|
| 1 | Sequence control input common terminal | Sequence control input 0V | |
| 2 | Run signal | Run at closed* | |
| 3 | Stop signal | Stop at open [†] | |
| 4 | Connection to shield sheath of signal lead | — | |
| 5 | Forward / Reverse operation selector. | Forward at open [†] , Reverse at closed* | |
| 6 | Master/Aux frequency reference selector | Master speed at open [†] , Aux at closed | |
| 7 | External fault input | Fault at closed [†] | |
| 8 | Fault reset input (external) | Fault reset at closed* | |
| 9 | Master speed frequency reference input | 0 to +10V or 4–20mA (500 Ω) | |
| 10 | | 0V | |
| 11 | Connection to shield sheath of signal lead | — | |
| 12 | Run contact output [‡] (1NC) | Open [†] during run | Contact capacity: 250 VAC at 1A or below 30 VDC at 1A or below |
| 14 | | Common | Contact capacity: 250VAC at 1A or below 30 VDC at 1A or below |
| 15 | | Closed* at fault | |
| 16 | Fault contact output (1NONC) | Open [†] at fault | |
| 17 | Frequency meter input | | Approx +10V/100%, output impedance 3k Ω |
| 18 | | | 0 |
| 19 | Connection to shield sheath of signal lead | — | |
| 20 | Aux frequency input | | +15V (VS-616HII internal power supply) |
| 21 | | | +10V/100% |
| 22 | | | 0V |

*Short-circuited with terminal ①

[†]Opening terminal

[‡]Used as a zero-interlock contact With notches ① and ② of operation mode selector switch 6S set OFF, RUN contact is on at RUN command and off after DB operation at STOP command

APPENDIX 3 INTERNAL CIRCUIT AND INTERCONNECTION DIAGRAMS

VS-616HII used in the internal circuit and interconnection diagrams is of Model CIMR-7.5B, 200-230 V, 10 kVA.

A3-1 VS-616HII INTERNAL CIRCUIT

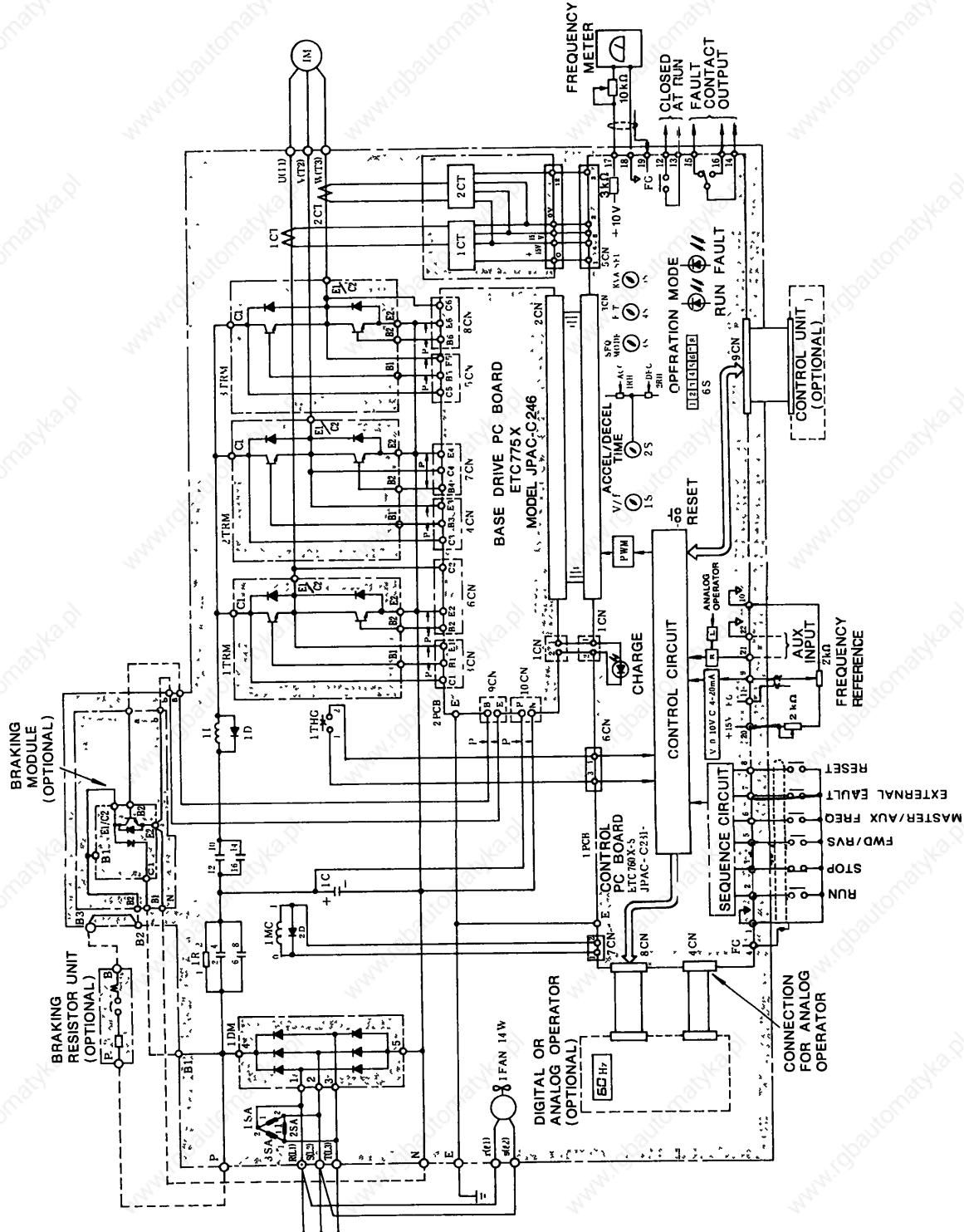

Fig 22 VS-616 HII Internal Circuit

A3-2 INTERCONNECTION DIAGRAMS FOR VS-616H II APPLICATIONS

(1) WITH ANALOG OPERATOR

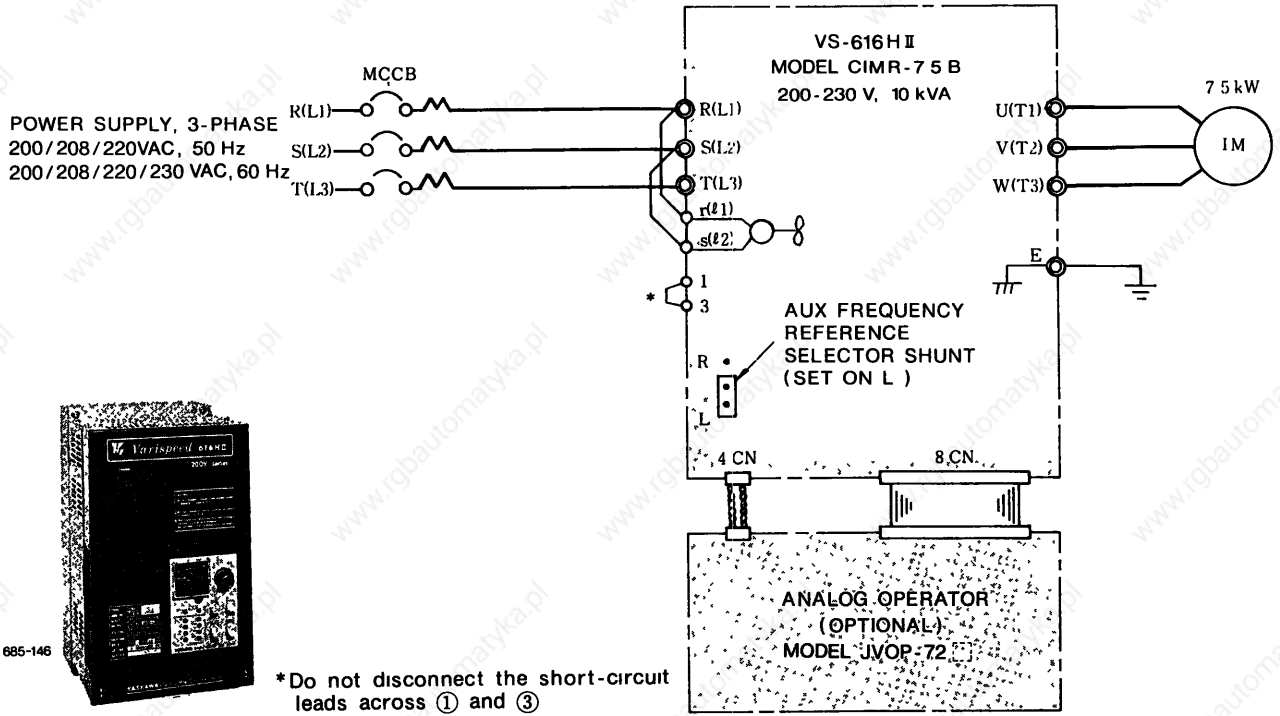

Fig 23 With Analog Operator

(2) WITH DIGITAL OPERATOR

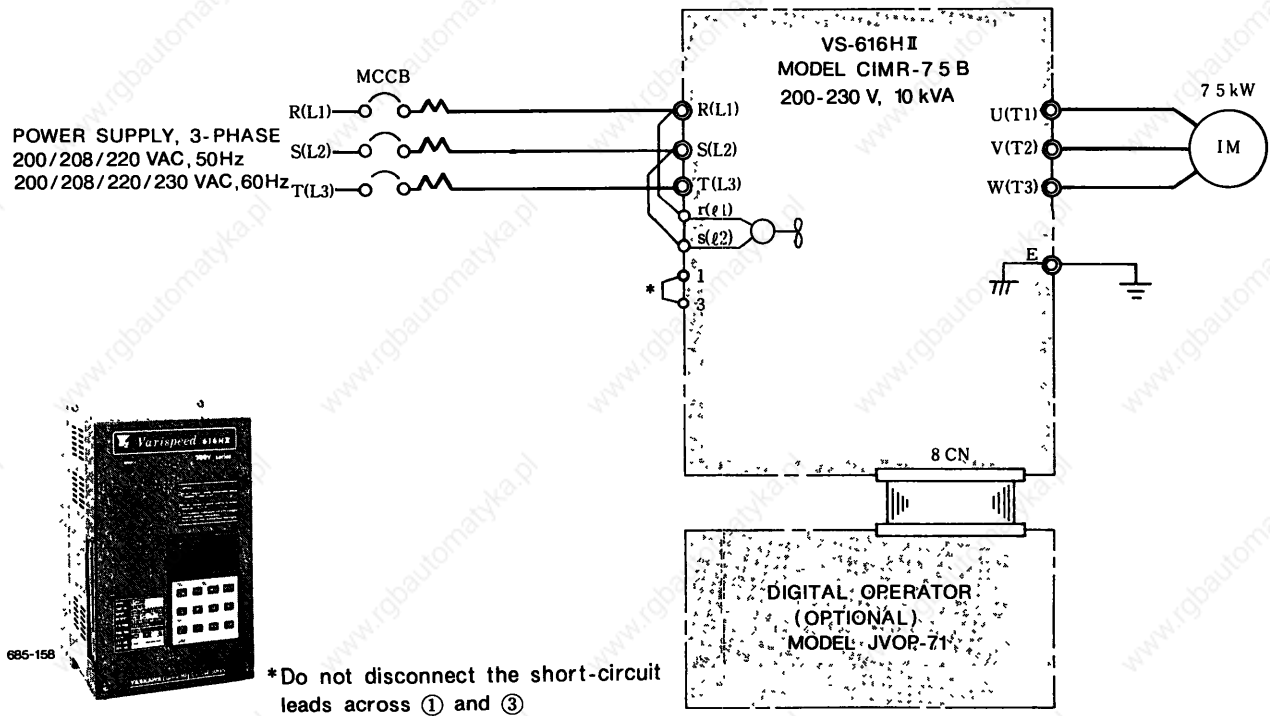
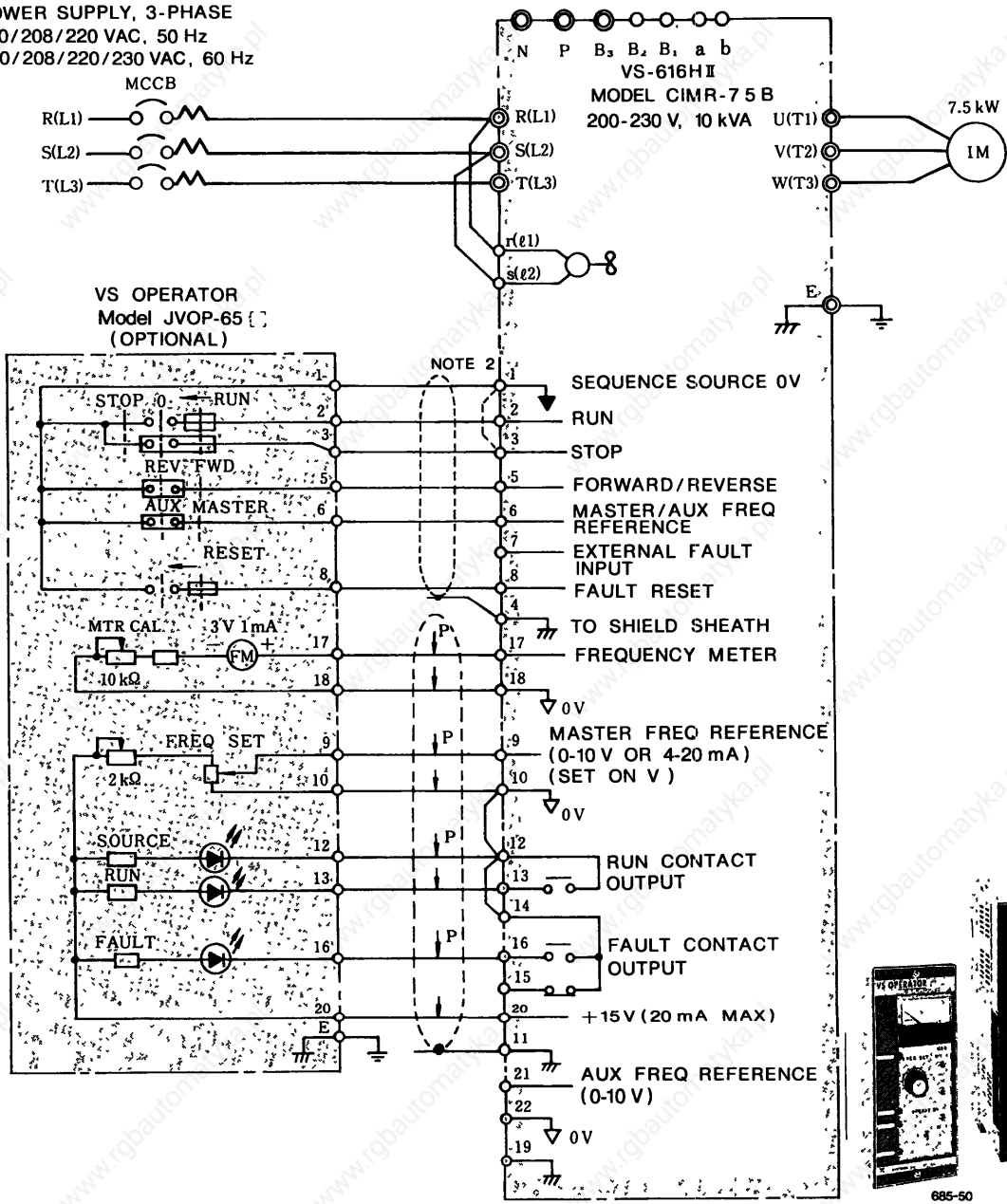

Fig 24 With Digital Operator

A3-2 INTERCONNECTION DIAGRAMS FOR VS-616 HII APPLICATIONS (Cont'd)

(3) WITH VS OPERATOR

POWER SUPPLY, 3-PHASE
 200/208/220 VAC, 50 Hz
 200/208/220/230 VAC, 60 Hz



Note

- 1 To give frequency reference from VS operator, set the VS operator MASTER/AUX switch to MASTER
- 2 Remove the short-circuit leads across ① and ③.

Fig 25 With VS Operator



685-143

685-50

(4) WITH USER-ARRANGED OPERATION CIRCUIT

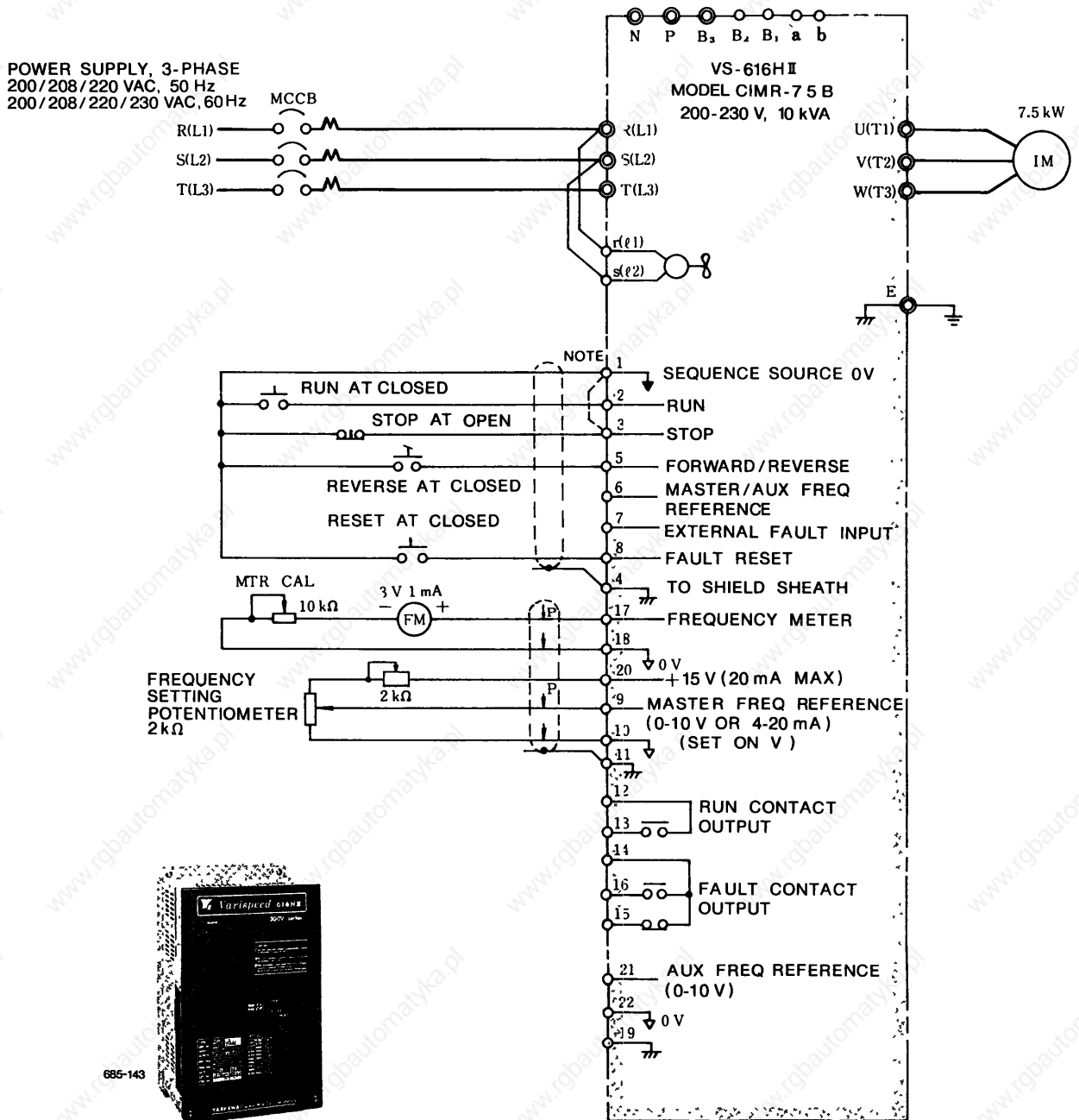

Note Remove the short-circuit lead across external terminals ① and ③

Fig 26 With User-Arranged Operation Circuit

A3-2 INTERCONNECTION DIAGRAMS FOR VS-616H II APPLICATIONS (Cont'd)

(5) WITH MAGNETIC CONTACTOR FOR START/STOP OPERATION

(a) Magnetic contactor opened at inverter fault

Before turning on AC main circuit power, be sure the motor is at rest.
For frequent start/stop operations, this drive circuit is not recommended.

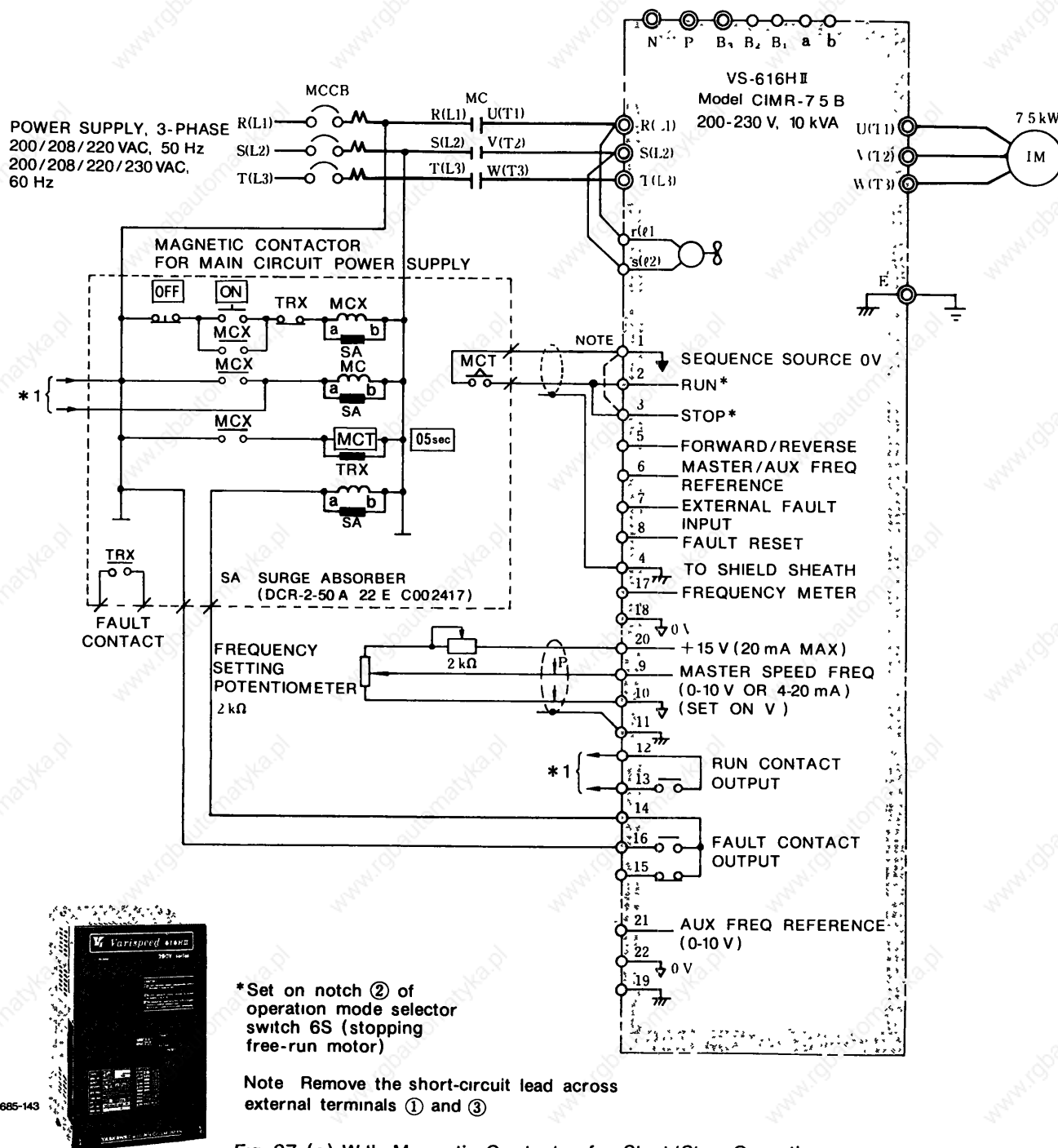
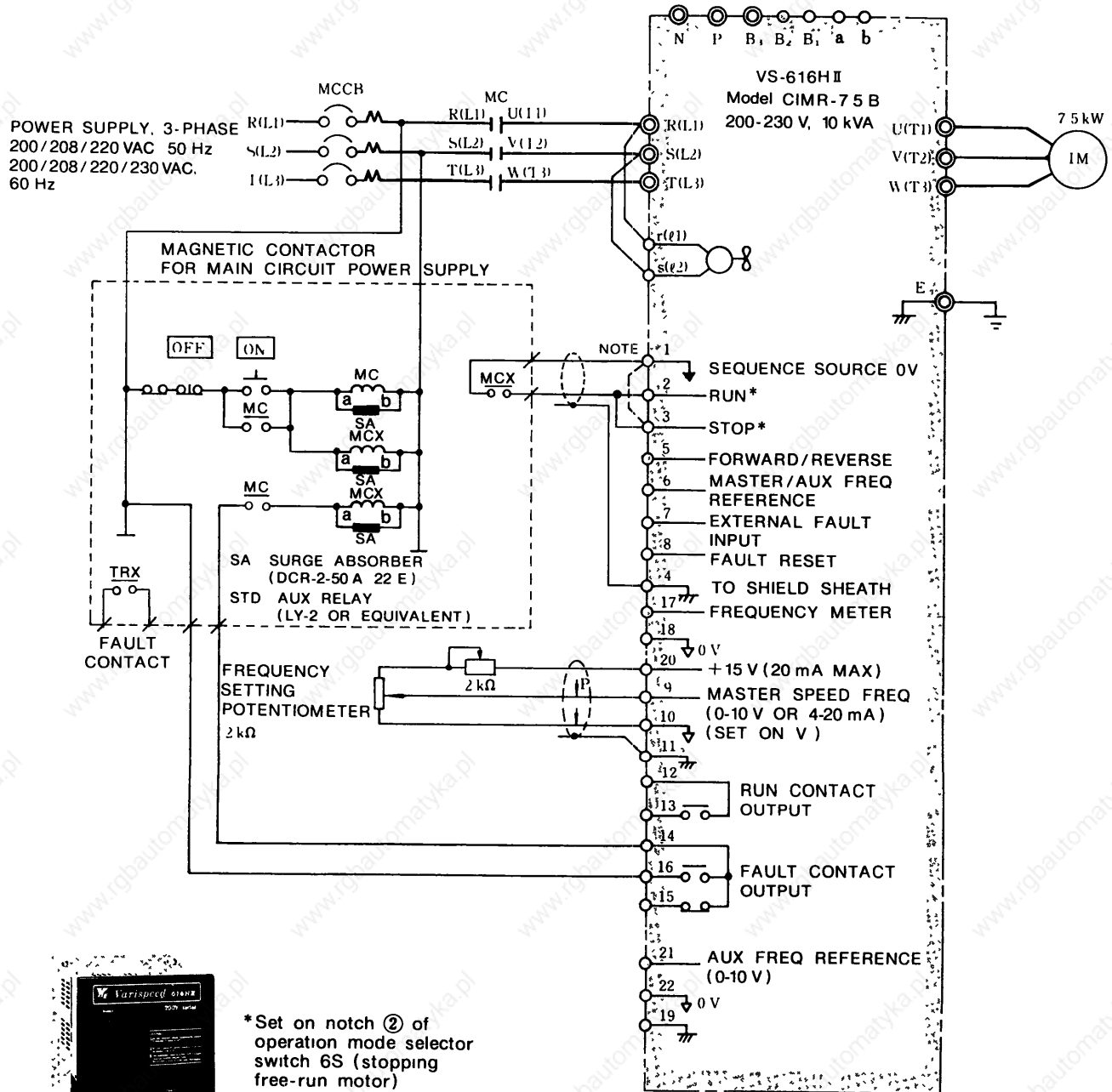

Fig 27 (a) With Magnetic Contactor for Start/Stop Operation

(b) Magnetic contactor not opened at inverter fault

Before turning on AC main circuit power, be sure the motor is at rest.
For frequent start/stop operations, this drive circuit is not recommended.



685-143

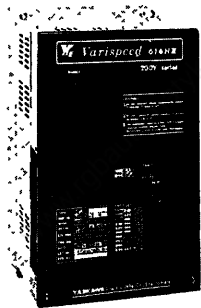

Fig. 27 (b) With Magnetic Contactor for Start/Stop Operation

(6) WITH VS OPERATOR AND ANALOG OPERATOR

POWER SUPPLY, 3-PHASE
200/208/220 VAC, 50 Hz
200/208/220/230 VAC,
60 Hz

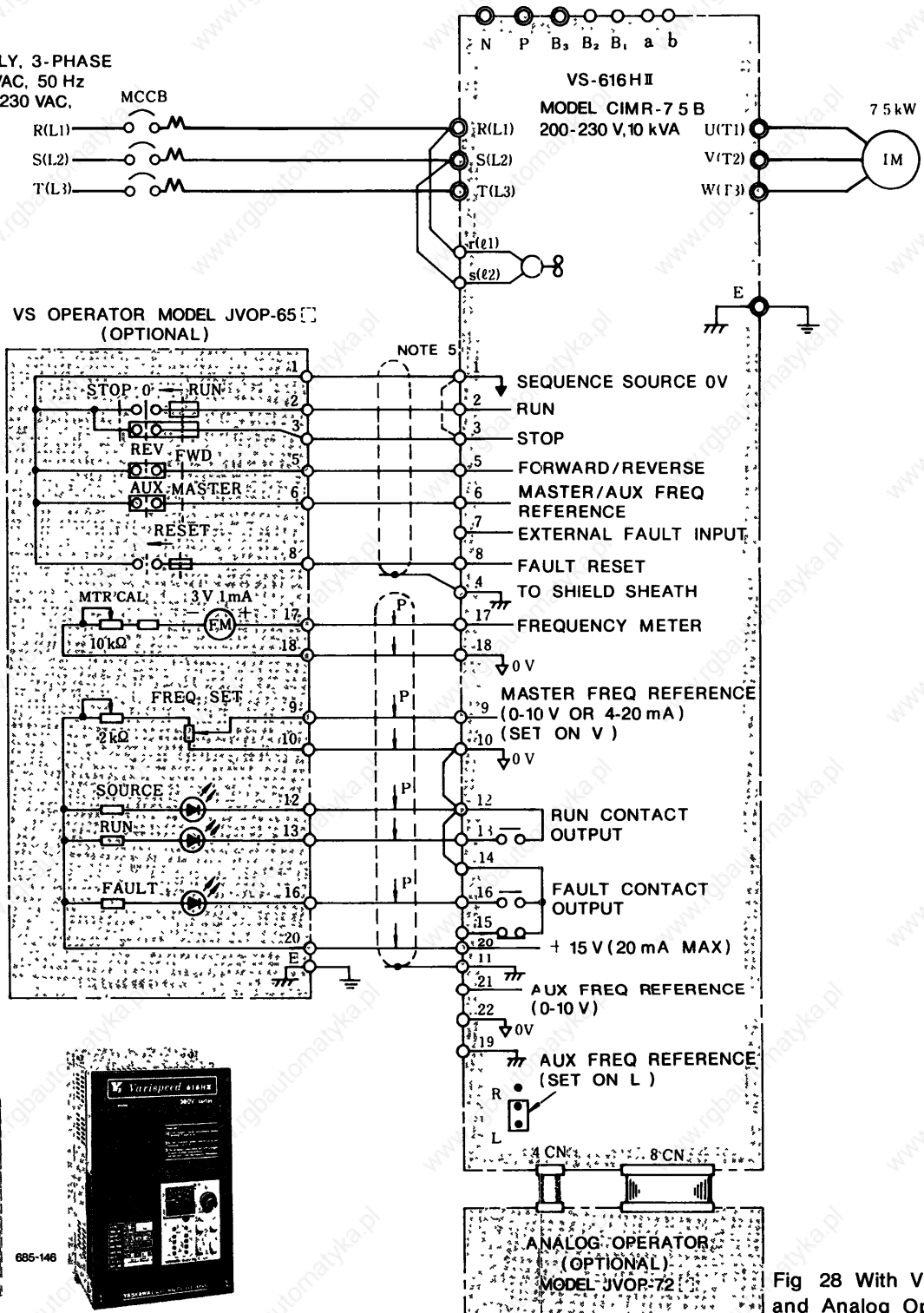

Fig 28 With VS Operator and Analog Operator

Note

- 1 To give the frequency reference from VS operator, change the Analog operator AUTO/MAN switch to AUTO, and VS operator MASTER/AUX switch to MASTER
- 2 To give the frequency reference from Analog operator, set the AUTO/MAN switch to MAN
- 3 Use of Analog operator does not permit the use of auxiliary frequency reference terminal ②
- 4 Stop operation can be made by either VS operator or Analog operator Stop command
Either stop command takes priority over any command
- 5 Disconnect the short-circuited terminals ① and ③

A3-2 INTERCONNECTION DIAGRAMS FOR VS-616 H II APPLICATIONS (Cont'd)

(7) WITH VS OPERATOR AND DIGITAL OPERATOR

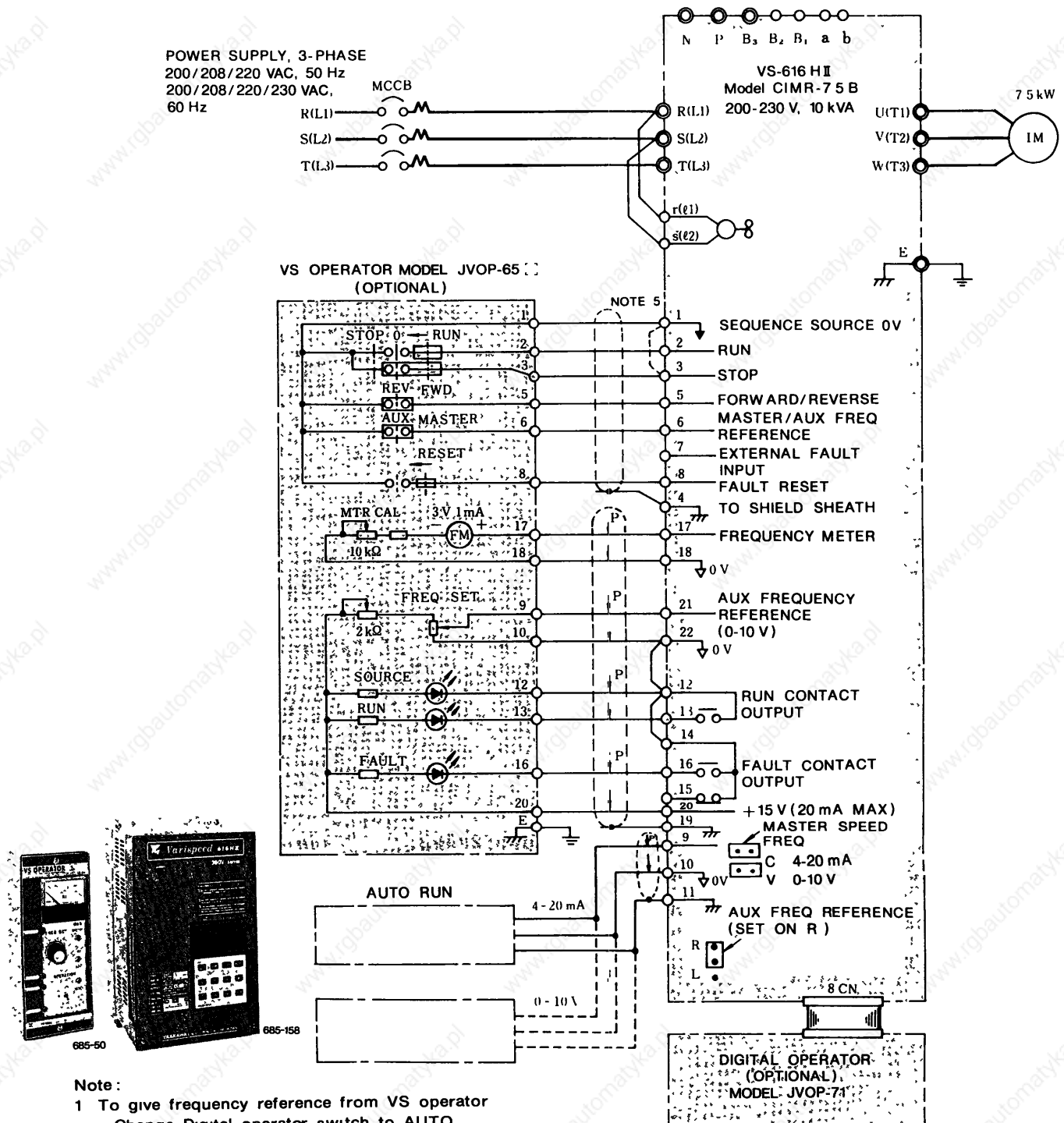

Note:

- To give frequency reference from VS operator
 - Change Digital operator switch to AUTO
 - Change VS operator MASTER/AUX switch to AUTO
- To give frequency reference through automatic operation command,
 - Change the Digital operator switch to AUTO
 - Change the VS operator MASTER/AUX switch to MASTER
 - For voltage reference of 0 to 10 V, set the MASTER SPEED FREQUENCY shunt on (V) and for current reference of 4 to 20 mA, set it on (C)
- To set frequency reference from Digital operator, set the Digital operator switch to MAN Switching frequency reference from Digital operator to the other devices can be made at motor standstill only
- Stop operation can be made by either VS operator or Digital operator
Either stop command takes priority over any command
- Disconnect the short-circuited terminals ① and ③

Fig 29 With VS Operator and Digital Operator

(8) WITH BRAKING MODULES AND BRAKING RESISTOR UNIT

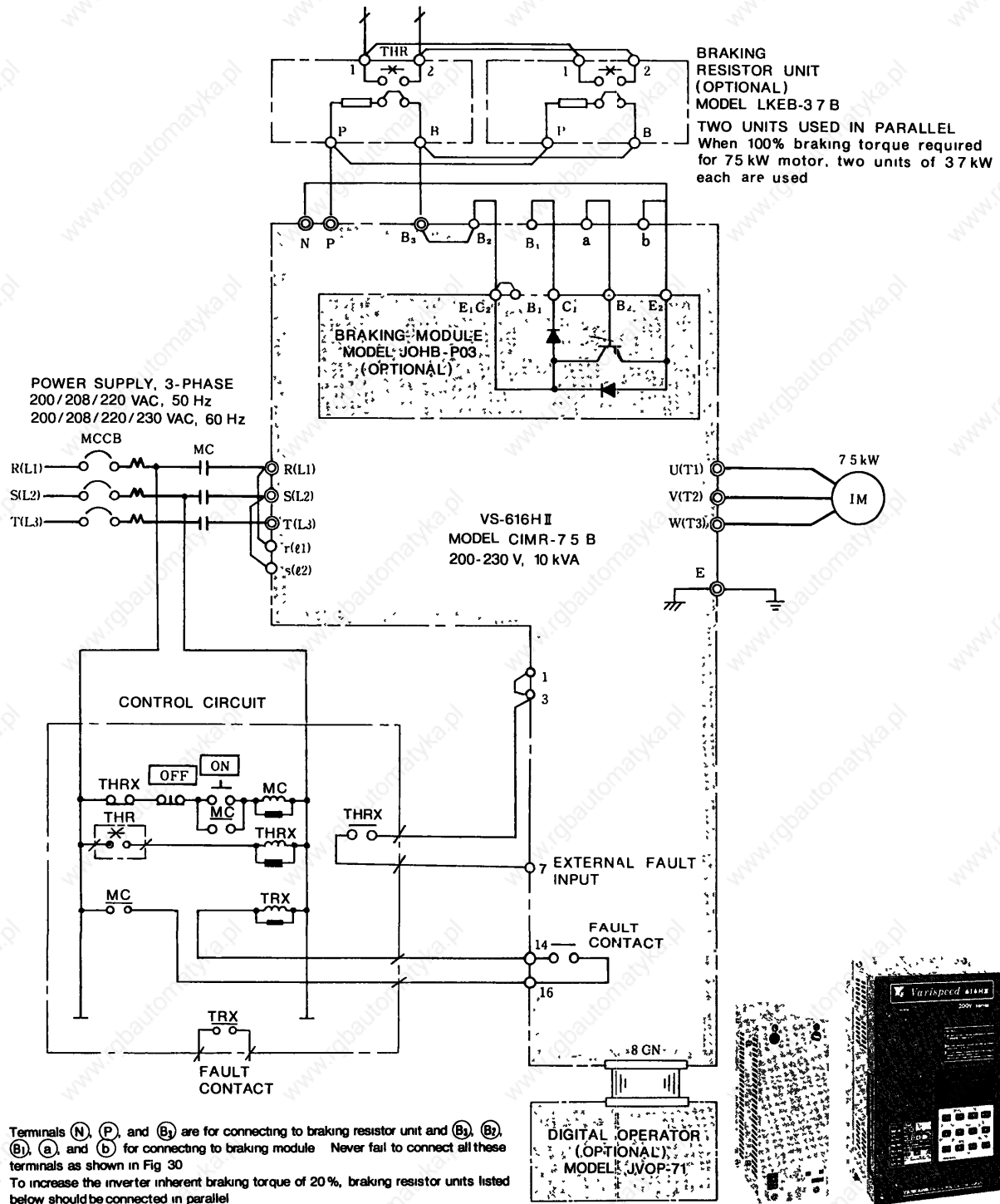

Fig 30 With Braking Module and Braking Resistor Unit

A3-2 INTERCONNECTION DIAGRAMS FOR VS-616 H II APPLICATIONS (Cont'd)

(9) WITH TRANSISTOR (OPEN-COLLECTOR) FOR START/STOP OPERATION

To input start/stop signals by relay contacts or transistor (open collector), use the following elements:

- Relay contact:
Contact capacity — 30 VDC or above
Rated current — 100 mA or above
- Transistor (open collector):
Withstand voltage — 35 VDC or above
Rated current — 100 mA or above

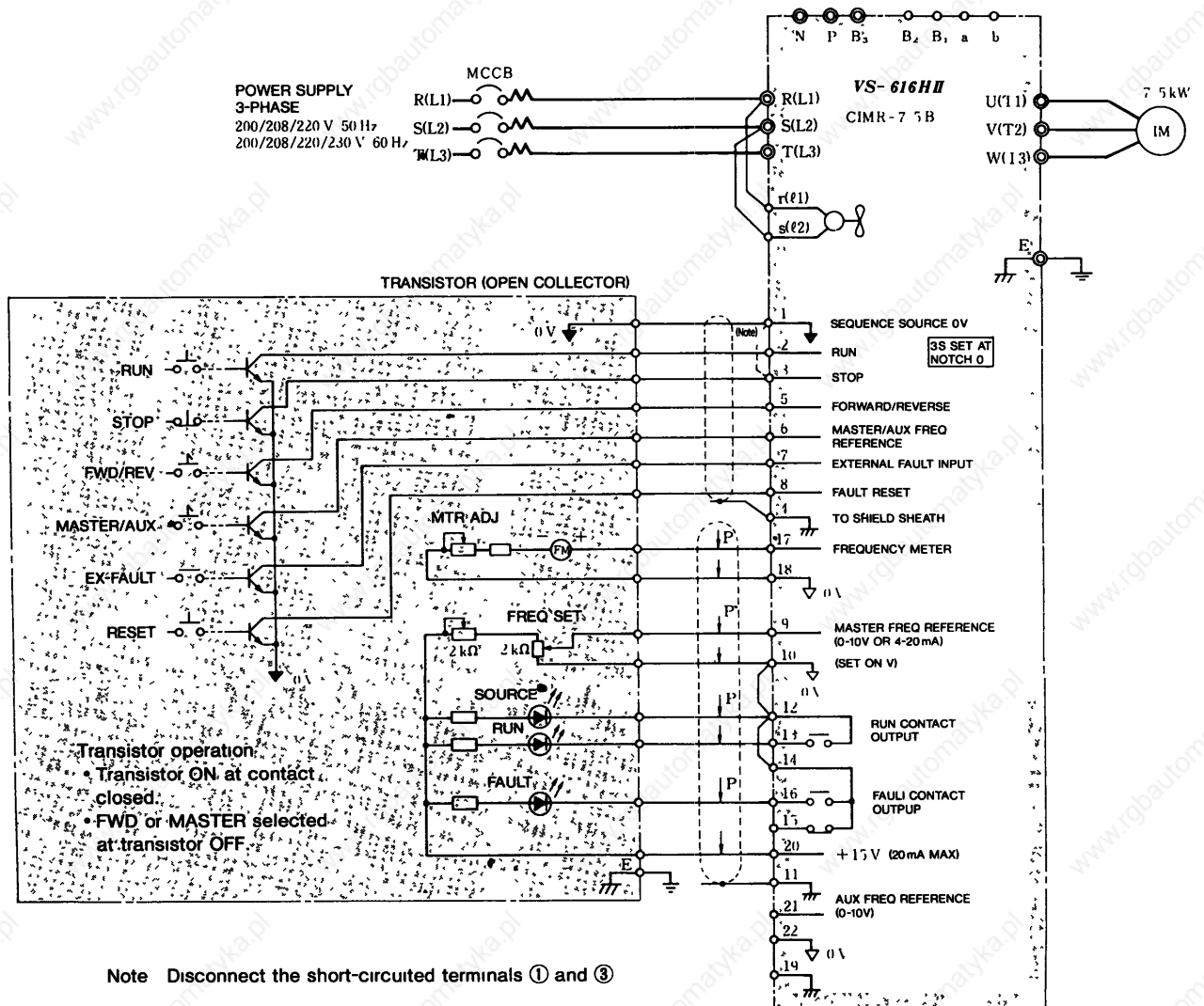

Fig. 31 With Transistor (Open-Collector) for Start/Stop Operation

APPENDIX 4 VS-616H II OPTIONAL AND AUXILIARY UNITS

A4-1 VS-616H II OPTIONAL UNITS

Table 20 VS-616HII Optional Units

| Name | Model | Code No | Functions |
|-----------------------|-------------|------------------|--|
| Digital Operator | JVOP-71 | 73041-0701X | Mounted on the inverter. Issues operation commands, sets the frequency by the digital signal, and displays the preset or current frequency in digital form. Also, displays the type of fault in characters when a failure occurs |
| Analog Operator | JVOP-72-□□* | 73041-0702X-□□□* | Mounted on the inverter Gives operation commands, sets the frequency by the analog signal, and indicates the current frequency on the frequency meter |
| VS Operator | JVOP-65-□□* | 73041-0703X-□□□* | Used for remote operation Outputs operation commands, sets the frequency by analog commands, and indicates the current frequency on the frequency meter. |
| Braking Module | JOHB-P0 1 | 73616-0001X | Mounted on the inverter If the main circuit DC voltage exceeds a specified level during motor regeneration, causes the braking resistor to absorb regeneration energy |
| | JOHB-P0 2 | 73616-0002X | |
| | JOHB-P0 3 | 73616-0003X | |
| Braking Resistor Unit | LKEB-0.75B | 73616-0020X | Absorbs regeneration energy of the motor, enhancing the inverter braking capability |
| | LKEB-3 7B | 73616-0021X | |

*Code No and model name suffixes indicate the type of frequency meter as shown below

•Analog Operator

| Model JVOP-72-□□ | | Code No 73041-0702X-□□□ | |
|---------------------------|-----------|-------------------------|----|
| Frequency Meter Max Scale | 60/120 Hz | 1 | 01 |
| | 72 Hz | 4 | 04 |
| | 90/180 Hz | 5 | 05 |
| | 240 Hz | 8 | 08 |
| | 360 Hz | 9 | 09 |

•VS Operator

| Model JVOP-65-□□ | | Code No 73041-0703X-□□□ | |
|---------------------------|--------|-------------------------|----|
| Frequency Meter Max Scale | 75 Hz | 1 | 01 |
| | 150 Hz | 2 | 02 |
| | 220 Hz | 3 | 03 |

A4-2 VS-616HII AUXILIARY UNITS

Table 21 VS-616HII Auxiliary Units

| Name | Function |
|---|--|
| Main Circuit Magnetic Contactor | Switches on and off the main circuit, and interlocks the circuit if a failure occurs |
| Molded-case Circuit Breaker (MCCB) | Protects the main circuit wiring and inverter from damage caused by short-circuit current |
| AC Reactor | Improves the high-frequency content of the power or prevents mutual interference due to voltage waveform distortion when connected to the power side. Better the current waveform, lowers noise, and increases the motor torque when connected to the output of the inverter |
| Noise Filter | <ul style="list-style-type: none"> • Suppresses transmission of high-frequency noise produced by the inverter to the power side (input noise filter) • Suppresses transmission of high-frequency noise produced by the inverter to the motor (output noise filter) |
| Thermal Overload Relay | Protects the motors from burning when two or more motors are operated by one inverter |
| Ground Fault Interrupter | Detects degradation in main circuit insulation, and shuts off the main circuit. (Set the Setting to 200mA, and the operating time to 0.2sec or more.) |
| Surge Absorber | Prevents problems due to noise when connected coils of the sequence relay, magnetic switch, magnetic valve, and so on (DCR2-50A22E or DCR2-10A25C). (If power waveform distortion is serious, contact YASKAWA representative.) |
| Frequency Setting Potentiometer | Variable resistor used to set the analog frequency (2k Ω , 0.5W or more). |
| Frequency Meter Calibration Potentiometer | Calibrates the maximum indication value of the frequency meter. (10k Ω , 0.25W or more) |
| Frequency Meter | Indicates the output frequency of the inverter. (3V, 1mA at full scale) |

Table 22 Devices of VS Operator Model JVOP-65-[]

| Device | Model | Specifications | Part Code |
|---------------------------------|------------------|------------------|-----------------------------------|
| Frequency Meter | DCF-6A | 3V, 1mA | 75 Hz at full scale FM 000067 |
| | | | 150 Hz at full scale FM 000069 |
| | | | 220 Hz at full scale FM 000072 |
| Frequency Setting Potentiometer | RV30YN 20S-HV | 2k Ω , 1W | RH 000649 |

APPENDIX 5 CHECKING OF DIODE AND TRANSISTOR MODULES

A5-1 DIODE MODULE

Measure the resistance across the module terminals with a volt-ohm meter. Use the meter by setting at $\times 1\Omega$ range. The measured resistance should be within the reference value listed in Table 23.

Table 23 Diode Module Resistances

| Diode Module Terminals | Volt-ohm Meter Terminals | | Reference Resistances | Abnormal Resistances |
|--|--------------------------|-----------|------------------------|------------------------|
| | \ominus | \oplus | | |
| Model CIMR-04B, -075B, -5.5B, -75B. | \ominus | \ominus | ∞ | Approx several 10 ohms |
| | \oplus | \ominus | | |
| | \ominus | \oplus | Approx several 10 ohms | ∞ or 0Ω |
| | \oplus | \oplus | | |
| Model CIMR-22B, -37B | \ominus | \ominus | ∞ | Approx several 10 ohms |
| | \oplus | \ominus | | |
| | \ominus | \oplus | Approx several 10 ohms | ∞ or 0Ω |
| | \oplus | \oplus | | |



A5-2 TRANSISTOR MODULE

Measure the resistance across the module terminals with a volt-ohm meter. Use the meter by setting at $\times 1\Omega$ range. The measured resistance should be within the reference value listed in Table 24.

Table 24 Transistor Module Resistances of Model CIMR-04B

| Transistor Module Terminals | | Reference Resistances | Abnormal Resistances | Transistor Module Terminals |
|-----------------------------|-----------------------|--|---------------------------|-----------------------------|
| VOM Terminal \ominus | VOM Terminal \oplus | | | |
| U (T1) | P | Approx several 10 ohms | 0Ω or ∞ | |
| V (T2) | P | | | |
| W (T3) | P | | | |
| N | U (T1) | | | |
| N | V (T2) | | | |
| N | W (T3) | | | |
| P | U (T1) | Approx several 100 kilohms | 0Ω | |
| P | V (T2) | | | |
| P | W (T3) | | | |
| U (T1) | N | | | |
| V (T2) | N | | | |
| W (T3) | N | | | |
| BuP | EuP | Approx several 10 ohms | Approx several 10 kilohms | |
| BvP | EvP | | | |
| BwP | EwP | | | |
| BuN | EuN | | | |
| BvN | EvN | | | |
| BwN | EwN | | | |
| EuP | BuP | Approx several 100 ohms to several kilohms | 0Ω or ∞ | |
| EvP | BvP | | | |
| EwP | BwP | | | |
| EuN | BuN | | | |
| EvN | BvN | | | |
| EwN | BwN | | | |



A5-2 TRANSISTOR MODULE (Cont'd)

Table 25 Transistor Module Resistances of Model CIMR-075B, -22B and -37B

| Transistor Module Terminals | | Reference Resistances | Abnormal Resistances | Transistor Module Terminals |
|-----------------------------|----------------|--|----------------------------|-----------------------------|
| VOM Terminal ⊖ | VOM Terminal ⊕ | | | |
| U (T1) | + | Approx several 10 ohms | 0 Ω or ∞ | |
| V (T2) | + | | | |
| W (T3) | + | | | |
| - | U (T1) | | | |
| - | V (T2) | | | |
| - | W (T3) | | | |
| + | U (T1) | Approx several 100 kilohms | 0 Ω | |
| + | V (T2) | | | |
| + | W (T3) | | | |
| U (T1) | - | Approx several 10 ohms | Approximate 10 kΩ or above | |
| V (T2) | - | | | |
| W (T3) | - | | | |
| Bu | Eu | | | |
| Bv | Ev | | | |
| Bw | Ew | | | |
| Bx | E- | Approx several 100 ohms to several kilohms | 0 Ω or ∞ | |
| Bγ | E- | | | |
| Bz | E- | | | |
| Eu | Bu | | | |
| Ev | Bv | | | |
| Ew | Bw | | | |
| E- | Bx | | | |
| E- | Bγ | | | |
| E- | Bz | | | |

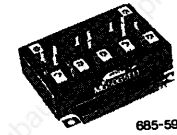

Table 26 Transistor Module Resistances of Type CIMR-5.5B and -7.5B

| Transistor Module Terminals | | Reference Resistances | Abnormal Resistances | Transistor Module Terminals |
|-------------------------------|-------------------------------|--|------------------------------------|-----------------------------|
| VOM Terminal ⊖ | VOM Terminal ⊕ | | | |
| E ₁ C ₂ | C ₁ | Approx several 10 ohms | 0 Ω or ∞ | |
| C ₁ | E ₁ C ₂ | Approx several 100 kilohms | 0 Ω | |
| B ₁ | E ₁ C ₂ | Approx several 10 ohms | Approx several 10 kilohms or above | |
| E ₁ C ₂ | B ₁ | Approx several 100 ohms to several kilohms | 0 Ω or ∞ | |
| E ₂ | E ₁ C ₂ | Approx several 10 ohms | 0 Ω or ∞ | |
| E ₁ C ₂ | E ₂ | Approx several 100 kilohms | 0 Ω | |
| B ₂ | E ₂ | Approx several 10 ohms | Approx several 10 kilohms or above | |
| E ₂ | B ₂ | Approx several 100 ohms to several kilohms | 0 Ω or ∞ | |



APPENDIX 6 PARTS REPLACEMENT

For checking or replacing parts, observe the following.

- Tag leads to insure correct reconnection before disconnecting the leads without marks.
- Tighten the parts mounting screws or lead terminal screws firmly. Even one loose screw may cause malfunction.

A6-1 REPLACEMENT OF CONTROL PC BOARD

1. Remove the connectors 1CN, 5CN, 6CN, and 7CN by the lead lock. To remove the lead lock, press the top of the locking clip to release from the header and pull out.
2. Remove the connector 3CN. Open the lock lever, and the connector is released.

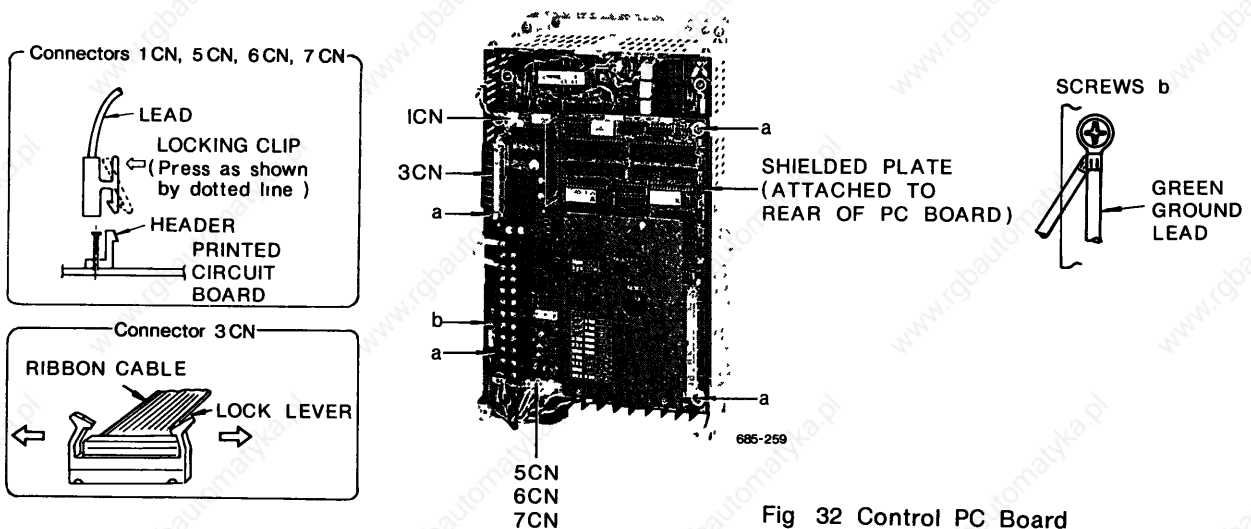

Fig 32 Control PC Board

3. Remove 4 screws (a) and a ground lead screw (b) to remove the control PC board.
4. Take off the control printed PC board and shield plate which is attached to the rear of the board.

A6-2 REPLACEMENT OF BASE DRIVE PC BOARD

1. Pull out the connectors 3CN to 8CN and 10CN.
2. Remove three mounting screws (a) and ground lead screw (b).
3. Remove the base drive PC board with shield plate.

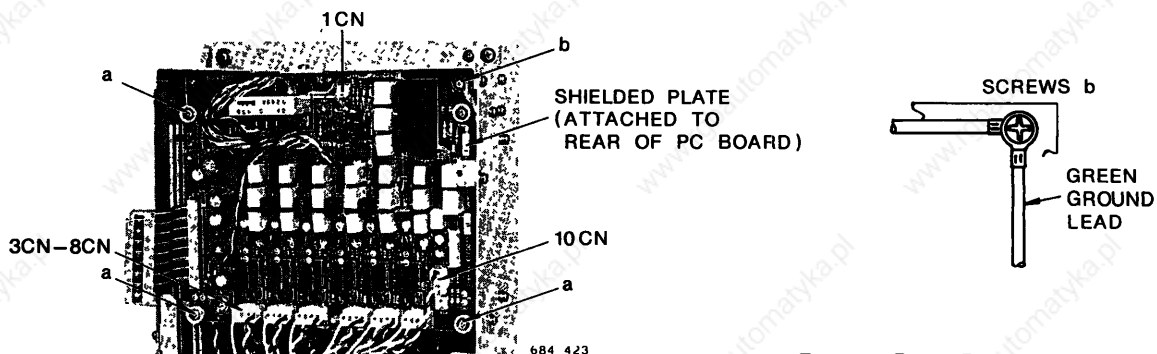

Fig 33 Base Drive PC Board

A6-3 REPLACEMENT OF DIODE MODULE AND TRANSISTOR MODULE

CAUTION

When remounting transistor or diode modules, apply thermal compound "JOINTAL Z" (Nippon Light Metal Co., Ltd.), or equivalent compound to the mounting surface, to assure good contact and heat conduction between the module and the mounting surface for cooling.

MODULE REMOVAL

1. Remove the bus bar mounting screws (c).
2. Remove module lead terminal screws (a).
3. Remove module mounting screws (b) and (d).
4. Remove the modules.

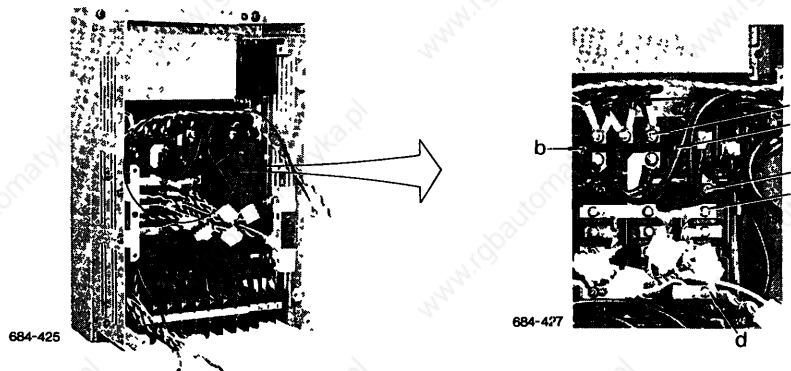

Fig 34 Removing Diode Module and Transistor Module

A6-4 REPLACEMENT OF COOLING FAN

VS-616HII Models CIMR-5.5B, and -7.5B incorporate cooling fans. Replace the fan after approximately 20,000 hours of cumulative operation.

1. After removing the control PC and base drive PC boards as outlined in par. A6-1 and A6-2, remove fan casing mounting screws (a).
2. Remove screws (b) and take the fan support with fan out of the fan casing.
3. Remove screws (c) and separate fan from fan support.

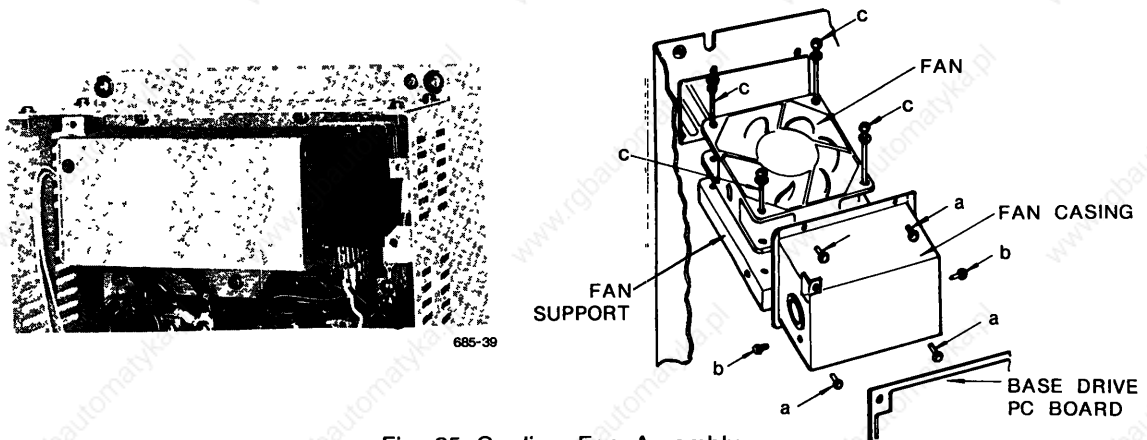

Fig 35 Cooling Fan Assembly

APPENDIX 7 RENEWAL PARTS

As insurance against costly downtime, it is strongly recommended that renewal parts to be kept on hand in accordance with the table below. When ordering renewal parts, please specify to Yaskawa Electric office or representative with; Parts Name, Parts Code No. and Quantity.

Table 27 Renewal Parts

| Parts Name | | Main Circuit Transistor | Main Circuit Diode | Base Drive PC Board* | Control PC Board†‡ | Cooling Fan | |
|----------------------------|---------|-------------------------|--------------------|----------------------|--------------------|------------------|-----------------------|
| VS-616HII Model CIMR | - 0.4B | Model | QM10TB-H | RM10TA-H | JPCA-C242 | JPAC-C231-□□□ | — |
| | | Code | STR000197 | SID000360 | ETC00771X | ETC00760X-S□□□XX | |
| | | Q' ty | 1 | 1 | 1 | 1 | |
| | - 0.75B | Model | MG15G6EL1 | RM10TA-H | JPCA-C242 | JPAC-C231-□□□ | — |
| | | Code | STR000152 | SID000360 | ETC00771X | ETC00760X-S□□□XX | |
| | | Q' ty | 1 | 1 | 1 | 1 | |
| | - 2.2B | Model | MG30G6EL1 | D10VD60 | JPAC-C244 | JPAC-C231-□□□ | — |
| | | Code | STR000198 | SID000288 | ETC00773X | ETC00760X-S□□□XX | |
| | | Q' ty | 1 | 3 | 1 | 1 | |
| | - 3.7B | Model | MG50G6EL1 | D10VD60 | JPAC-C244 | JPAC-C231-□□□ | — |
| | | Code | STR000199 | SID000288 | ETC00773X | ETC00760X-S□□□XX | |
| | | Q' ty | 1 | 3 | 1 | 1 | |
| | - 5.5B | Model | MG75G2CL1 | 100L6P41 | JPAC-C246 | JPAC-C231-□□□ | 4715PS-22T -B30-07 |
| | | Code | STR000195 | SID000291 | ETC00775X | ETC00760X-S□□□XX | FAN00121 |
| | | Q' ty | 3 | 1 | 1 | 1 | 1 |
| | - 7.5B | Model | MG100G2CL1 | 100L6P41 | JPAC-C246 | JPAC-C231-□□□ | 4715PS-22T -B30-07 |
| | | Code | STR000200 | SID000291 | ETC00775X | ETC00760X-S□□□XX | FAN00121 |
| | | Q' ty | 3 | 1 | 1 | 1 | 1 |

*If braking function (optional) is not provided, base drive board is not required

†□□□ of the control PC board type name shows the type of function

Renewal board should have the same model name suffix as that of the board in use.

‡XX of Code No for the control PC board indicates the revision number of the control PC board

New board should have the same code suffix number or larger than that of the board being replaced

MEMO

TRANSISTOR INVERTER

Varispeed™ 616H II

200 TO 230 V, 0.4 TO 7.5 kW (0.5 TO 10 HP), 1 TO 10 kVA



A Better Tomorrow for Industry through Automation

YASKAWA Electric Mfg. Co., Ltd.

TOKYO OFFICE Ohtemachi Bldg, 1-6-1 Ohtemachi, Chiyoda-ku, Tokyo, 100 Japan
Phone (03) 3284-9111, -9145 Telex YASKAWA J33530 Fax (03) 3284-9034

SEOUL OFFICE Seoul Center Bldg, 91-1, So Kong-Dong, Chung-Ku, Seoul, Korea
Phone (02) 776-7844 Fax (02) 753-2639

SINGAPORE OFFICE CPF Bldg, 79 Robinson Road No. 24-03, Singapore 0106
Phone 2217530 Telex (87) 24890 YASKAWA RS Fax (65) 224-5854

TAIPEI OFFICE Union Commercial Bldg, 137, Nanking East Road, Sec 2, Taipei, Taiwan
Phone (02) 507-7065, -7732 Fax (02) 506-3837

YASKAWA ELECTRIC AMERICA, INC. SUBSIDIARY

Chicago Office (Head Office) 3160 MacArthur Blvd, Northbrook, Illinois 60062-1917, U S A
Phone (708) 291-2340, 291-2348 Telex (230) 270197 YSKW YSNC NBRK Fax (708) 498-2430, 480-9731

Los Angeles Office 7341 Lincoln Way, Garden Grove, California 92641, U S A
Phone (714) 894-5911 Telex (230) 678396 YASKAWAUS TSTN Fax (714) 894-3258

New Jersey Office 30 Two Bridges Road, Fairfield, New Jersey 07006, U S A
Phone (201) 575-5940 Fax (201) 575-5947

YASKAWA ELECTRIC EUROPE GmbH. SUBSIDIARY

Niederhöchstädter Straße 71-73, W 6242 Kronberg-Oberhöchstädt, Germany
Phone (06173) 640071, 640072, 640073 Telex 415660 YASE D Fax (06173) 68421

YASKAWA ELETRICO DO-BRASIL COMERCIO LTDA SUBSIDIARY

Av Brig Faria Lima, 1664-cj 721/724, Pinheiros, São Paulo-SP, Brasil CEP-01452
Phone (011) 813-3933, 813-3694 Telex (011) 82869 YSKW BR Fax (011) 815-8795