

CATALOGUE

IMPULSES FOR AUTOMATION with Kuhnke Relays

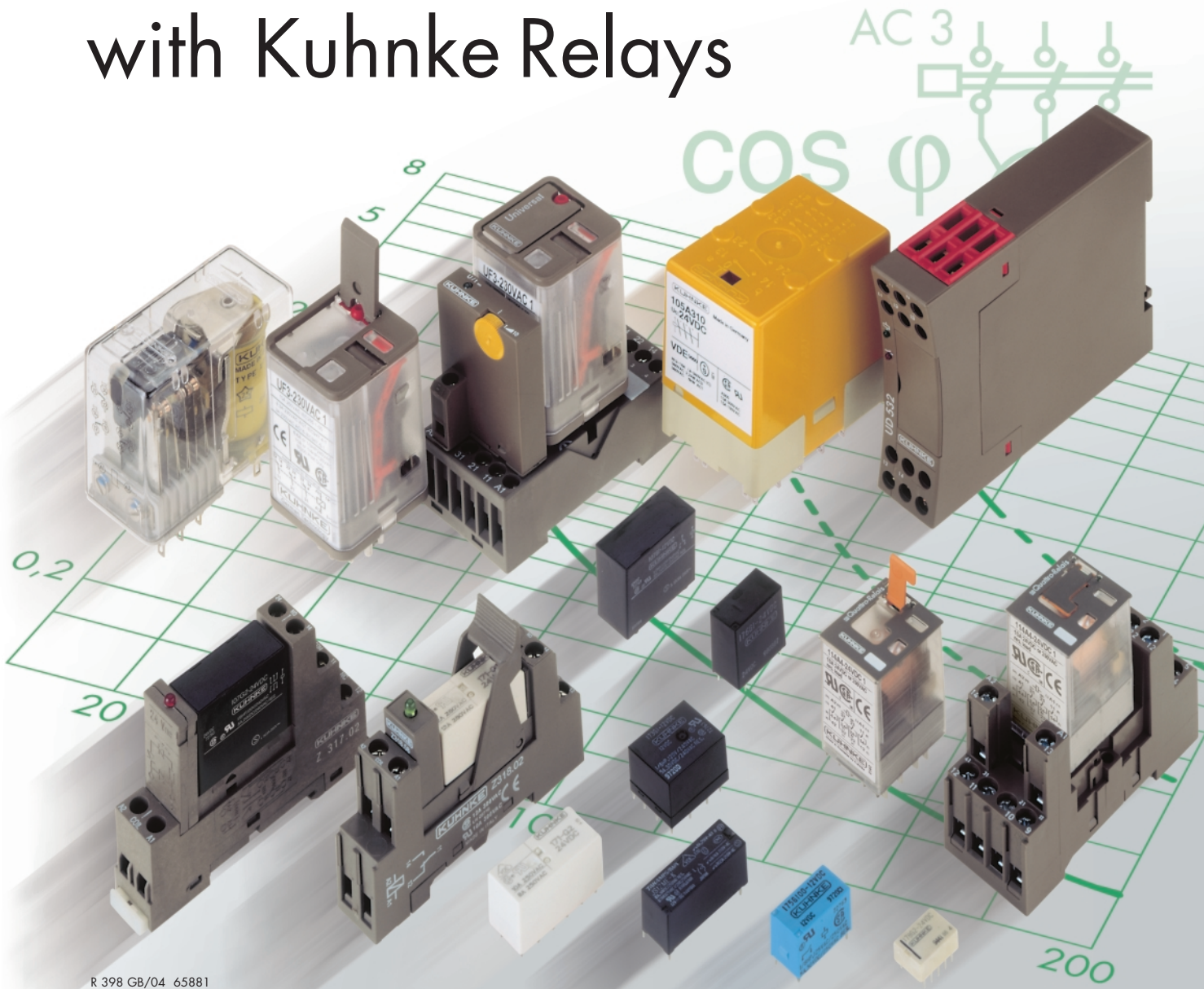

This catalogue is primarily intended for the design and development engineer.

It is not an indication of delivery possibilities. The data herein contained serve only to describe the product and should not be regarded as representing guaranteed properties in the legal sense.

Claims for damages against us – on whatever grounds – are excluded, except in instances of deliberate intent or gross negligence on our part. Reproduction, even of extracts only with the author's approval.

We reserve the rights of modification, omission, error.

IMPULSES FOR AUTOMATION with Kuhnke Relays

Sales & Service

Kuhnke GmbH
Lütjenburger Straße 101
D-23714 Malente

Phone +49 (0) 4523 402-0
Fax +49 (0) 4523 4022 47
E-mail sales@kuhnke.de
Internet www.kuhnke.com

Customer Service
Phone +49 (0) 4523 40 22 00
Fax +49 (0) 4523 40 22 01
E-mail service@kuhnke.de

Worldwide

Afghanistan
please see Cyprus

Arab. Rep. Jemen
please see Cyprus

Australia
G.Z. Pneumatic Pty. Ltd.
46 Lillimur Avenue
Heidelberg West, Vic.3081
Phone +61 3 9459 33 41
Fax +61 3 9458 34 67
E-mail gzpneumatic@ozemail.com.au

Austria
Kuhnke Automation Ges.m.b.H.
Schumanngasse 38a
2380 Perchtoldsdorf
Phone +43 1 869 62 00 0
Fax +43 1 869 62 00 6
E-mail office@kuhnke.at
Internet www.kuhnke.at

Bahrain
please see Cyprus

Belgium
Estebel bv / Stuijfmeele Techniek bv
Coenecoop 133
2741 PJ Waddinxveen
Phone +31 182 64 70 60
Fax +31 182 63 16 31
E-mail info@stuijfmeele.nl
Internet www.stuijfmeele.nl

Bulgaria
Electroinvent
43, Cherny vrah Blvd.
P.O. Box 74
1407 Sofia
Phone +359 2 868 70 65
Fax +359 2 862 30 96
E-mail elinvent@techno-link.com

Chile
Electronica Industrial Schädler y Cia. Ltda.
Antonio Varas 1871 - Providencia
Casilla 189 - 9
6641545 Santiago - Chile
Phone +56 2 274 74 30
Fax +56 2 204 93 38
E-mail info@schadler.com
Internet www.schadler.com

China
Huafeng Corporation
Tsinghua University
Dept. of Engineering Mechanics
100084 Beijing
Phone +86 (10) 62 79 19 19
Fax +86 (10) 62 77 06 06
E-mail tsinghua_huafeng@yahoo.com.cn

China
Ric Company Ltd.
10/F, Unit 2-3
Wing Lee Ind. Bld.
54-58 Tong Mi Road
Mongkok, Kowloon, Hong Kong
Phone +852 2 391 84 63
Fax +852 2 789 83 35
E-mail riccoltd@netvigator.com

Croatia
please see Austria

Cyprus
Nissad Development Company Ltd
10 Mykenae Street
P.O. Box 25086
1306 Nicosia
Phone +357 22 76 50 14
Fax +357 22 76 15 35
E-mail info@nissad.com
Internet www.nissad.com

Czech Republic
please see Austria

Denmark
J.D. Friderichsen AS
Sydmarken 46
2860 Søborg
Phone +45 70 27 23 27
Fax +45 70 27 23 37
E-mail p.husum@jdf.dk
Internet www.jdf.dk

Egypt
please see Cyprus

Finland
Kontram OY
Olarinluoma 12
P.O. Box 88
02201 Espoo
Phone +358 9 8866 4500
Fax +358 9 8866 4799
E-mail kontram@kontram.fi
Internet www.kontram.fi

France
Kuhnke Pneumatic S.A.R.L.
La Croix Rouge
35530 Brécé
Phone +33 2 99 00 28 98
Fax +33 2 99 00 25 85
E-mail info@kuhnke.fr
Internet www.kuhnke.fr

Germany
Kuhnke GmbH
Verkauf Deutschland
Strohgäustraße 3
73765 Neuhausen
Phone +49 7158 90 74 - 0
Fax +49 7158 90 74 80
E-mail sales@kuhnke.de
Internet www.kuhnke.de

Greece
2 Kappa Ltd.
Electrological-Electronic &
Lighting Components
Sofokli Venizelou 13
54628 Nenenemi Thessaloniki
Phone +30 2 31 0 77 55 10
Fax +30 2 31 0 77 55 14-15
E-mail info@2kappa.gr
Internet www.2kappa.gr
Industrial Relays

Greece
Tsilakopoulos Electronics Ltd.
Imports - Exports
Athanasiou Asteriou 31
60100 Katerini
Phone +30 2 3510 279 02
Fax +30 2 3510 261 75
E-mail tsilako@internet.gr
PCB Relays

Hungary
please see Austria

India
Iota Epsilon Electricals Pvt. Ltd.
B/4 Rockside
116, Walkeshwar Road
400 006 Mumbai
Phone +91 22 23 64 28 50
Fax +91 22 23 63 06 03
E-mail rockside@vsnl.com

Irak
please see Cyprus

Iran

please see Cyprus

Ireland

please see UK

Israel

Tapuz K.S. Import & Export Ltd.
13 Hamercava
P.O. Box 5365
Holon 58851
Phone +972 3 559 42 01
Fax +972 3 558 42 98
E-mail tapuz@tapuz.net
Internet www.tapuz.net

Italy

Elestream.com S.p.A.
Via Lomellina, 41
20133 Milano MI
Phone +39 02 752 23 23
Fax +39 02 752 23 30
E-mail mail@elestream.com
Internet www.elestream.com

Jordan

please see Cyprus

Korea

Euroko Trading Ltd.
2nd Floor, Bory Building
70-1, Shinkil 1-dong
Youngdeungpo-ku
Seoul
Phone +82 2 836 26 02
Fax +82 2 836 26 04
E-mail euroko@euroko.co.kr
Internet www.euroko.co.kr

Kuwait

please see Cyprus

Libanon

please see Cyprus

Malaysia

please see Australia

Mexico

Moeller México
Calle Ingenieros Civiles No 204
Parque Industrial Chachapa
Chachapa, Puepla C.P. 72990
Phone +52 222 286 6000
Fax +52 222 286 6002
E-mail ocastell@moeller.com.mx
Internet www.moeller.com.mx

Morocco

please see France

Netherlands

Stuifmeel Techniek bv
Coenecoop 133
2741 PJ Waddinxveen
Phone +31 182 64 70 60
Fax +31 182 63 16 31
E-mail info@stuifmeel.nl
Internet www.stuifmeel.nl

Norway

Elteco AS
Floodmyrveien 24
P.O. Box 96
3901 Porsgrunn
Phone +47 35 573 8 00
Fax +47 35 573 8 49
E-mail firmapost@elteco.no
Internet www.elteco.no

Oman

please see Cyprus

Pakistan

please see Cyprus

Peru

Somerinca Sa
Av Tingo Maria - 888
Lima 1
Phone +51 1 337 00 48
Fax +51 1 337 00 53
E-mail somerinca@terra.com.pe
Internet www.kmsomerinca.com.pe

Poland

Soyter Sp. z o.o.
Blizne Laszczynskiego
ul. Warszawska 3
05-082 Stare Babice
Phone +48 22 722 06 85
Fax +48 22 722 05 50
E-mail handlowy@soyter.com.pl
Internet www.soyter.pl

Portugal

please see Spain

Qatar

please see Cyprus

Romania

Kuhnke Relee S.R.L.
Str. Raului 33
2400 Sibiu
Phone +40 269 22 36 53
Fax +40 269 23 61 64
E-mail sales@kuhnke.ro
Internet www.kuhnke.com

San Salvador

Prestegard Electro S.A. de C.V
11 Avenida Norte 240
El Salvador
Phone +503 221 38 51
Fax +503 271 16 90

Saudi Arabia

please see Cyprus

Serbia

please see Austria

Singapore

Hoerbiger – Origa Pte Ltd.
5012, #05-01, Ang Mo Kio Ave 5
Tech II
Singapore 569876
Phone +65 6 483 29 59
Fax +65 6 483 29 79
E-mail sgmarket@hoerbiger-origa.com
Internet www.hoerbiger-origa.com

Slovenia

please see Austria

South Africa

Hoerbiger Origa (SA) (Pty.) Ltd.
P.O. Box 17846
1457 Randhart
Phone +27 11 908 13 10
Fax +27 11 908 13 12
E-mail gunter@hoerbiger.co.za

Spain

Kuhnke España
c/ Cartagena 108 Bajo 2 A
28002 Madrid
Phone +34 91 415 61 36
Fax +34 91 415 61 36
E-mail mguerrero@kuhnke.es
Internet www.kuhnke.com

Sweden

Kuhnke Automation AB
Bryggerigatan 7
Box 5025
29105 Kristianstad
Phone +46 44 10 36 60
Fax +46 44 10 95 15
E-mail sales@kuhnke.se
Internet www.kuhnke.se

Switzerland

Ferratec AG
Grossmattstrasse 19
8964 Rudolfstetten
Phone +41 56 649 21 21
Fax +41 56 649 21 41
E-mail kuhnke@ferratec.ch
Internet www.ferratec.ch

Taiwan

OARSMEN Corporation
6F - 1, No. 361
Chung Hwa 2nd Road
Kaohsiung City / Taiwan
Phone +886 2 2885 6713
Fax +886 2 2885 6734
E-mail oarsmen@ms24.hinet.net

Tunisia

please see France

Turkey

Else Elektrik Mak. San. Tic. AS
Cihangir mah.
Kargaci sk. No:5
34840 Avclar/ Istanbul
Phone +90 212 422 66 70
Fax +90 212 422 66 79
E-mail sales@else.com.tr
Internet www.else.com.tr

UK

H. Kuhnke Ltd.
21, Abbey Enterprise Centre
Premier Way
Romsey, Hampshire SO51 9AQ
Phone +44 1794 514 445
Fax +44 1794 513 514
E-mail sales@kuhnke.co.uk
Internet www.kuhnke.co.uk

United Arab Emirates

please see Cyprus











USA

Kuhnke Automation, Inc.
P.O. Box 1369
Wayne, N.J. 07474-1369
Phone +1 973 633 0690
Fax +1 973 633 7230
E-mail Kuhnkeusa1@aol.com
Internet www.kuhnkeusa.com











Venezuela

Moeller Somerinca C.A.
Dismerinsa
Edificio Esteban, Piso 2
Calle Vargas, Boleita Norte 1070,
Apartado 76051
1070 Caracas
Phone +58 212 235 27 48
Fax +58 212 238 56 25
E-mail klocmoeller@cantv.net
Internet www.kmsomerinca.com

Contents

	Page	
Relay Universal UF	1	
Relay Universal MF	5	
Relay Universal MF for Current Monitoring	8	
Time Relay Universal 130	10	
Accessories for Relay Universal	13	
Quattro Relay 114	19	
Accessories for Quattro Relay	22	
Miniature Relay 111 A2/H1	25	
Accessories for Relay 111	28	
Industrial Switching Relay I	30	
Industrial Heavy Duty Relay IH	34	
Accessories for Industrial Relay	37	
Relay Contactor 105	38	
Power Relay P	43	
Process Relay 600	46	
Measuring Relay 500	56	

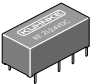
Contents

	Page	
Measuring Relay 1500	63	
High Performance PCB Relay 171	75	
High Performance PCB Relay 107	78	
Accessories for Relays 171/107	81	
High Performance PCB Relay 173	84	
High Performance PCB Relay 174	86	
High Performance PCB Relay 175	88	
High Performance PCB Relay 176	90	
Dual In-Line Relay 178	92	
Dual In-Line Relay RE	94	
Technical Information	97	
Part No. Index	120	



Relay Universal UF2/UF3

- Standard type  / 
- Twin contacts for high contact making reliability
- With LED and protection diode on request

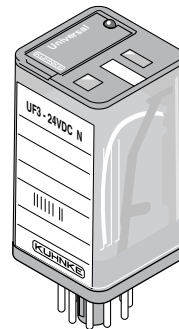

Order Code

Order code	U	F	3	-	24 V	DC	N
Type of relay	U						
Model							
F Plug in type for socket, international 8-pole socket or 11 pole socket resp.		F					
Contact arrangement							
2 C/O			2				
3 C/O			3				
Contact material, type of contact							
- Single contact AgNi (no code letter)				-			
B Single contact AgNi gold-plated				B			
F Twin contacts AgNi				F			
G Twin contacts AgNi gold-plated				G			
Nominal operation coil voltage (see coil data)							
24 V					24 V		
Coil current type							
DC Direct current						DC	
AC Alternating current 50 / 60 Hz						AC	
Version							
N With position indicator, with manual override, without override lever							N
1 With position indicator, with manual override, with override lever							1
Extensions							
- None (no code letter)							-
F Protection diode (on request)							F
L Luminous indicator (on request)							L



Contact Data

	UF2 / UF3			
Contact arrangement	2 or 3 C/O			
Type of contact	Single contact		Twin contact	
Contact material	AgNi	AgNi gold-plated	AgNi	AgNi gold-plated
Nominal contact current	10 A		4 A	
Inrush current	≤ 20 A		≤ 10 A	
Nominal contact voltage	250 VAC / DC		250 VAC	
Max. switching capacity (resistive)	3000 VA		1000 VA	
Min. switching capacity	50 mA / 20 VDC	1 mA / 100 mVDC	20 mA / 10 VDC	1 mA / 100 mVDC

Dimensions, Connection Diagram(s)

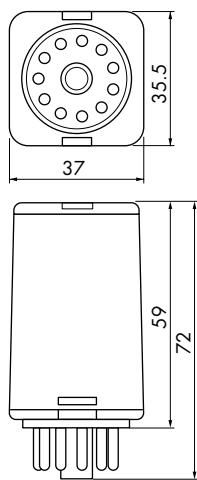

UF2 / UF3

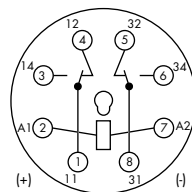

Viewed on connector pins

UF2

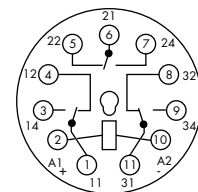

Viewed on connector pins

UF3

General Data

	UF2 / UF3		
Pull-in-time	approx. 12 ms		
Drop-out time	approx. 10 ms		
Bounce time	approx. 5 ms		
Mechanical service life	> 20 x 10 ⁶ switching cycles		
Test voltage			
Coil - contact	2500 VAC		
(C/O) - (C/O)	2500 VAC		
Contact - contact	1500 VAC		
Insulation group VDE 0110b/2.79	C250, B380		
Ambient temperature	-25 °C to +60 °C DC -25 °C to +40 °C AC		
Vibration resistance (30 - 100 Hz)	> 4 g		
Weight	approx. 90 g		
Operating range	DC Class 1 (0.8 - 1.1 U _N)	AC 50 Hz Class 1 (0.8 - 1.1 U _N)	AC 60 Hz Class 2 (0.85 - 1.1 U _N)
Pull-in after coil excitation with U _N at T _U	20 °C	20 °C	20 °C
Drop-out	> 0.05 U _N	> 0.15 U _N	> 0.15 U _N



Coil Data

Coil voltage DC	UF2 / UF3 Nom. operation coil power approx. 1.2 W Inrush current approx. 0.6 W		Coil voltage AC	UF2/UF3 Nom. operation coil power approx. 2.2 / 2.0 VA Inrush current approx. 1.5 x Nominal current		
Nominal voltage (V)	Nominal resistance (Ω)	Nominal current (mA)	Nominal voltage (V)	Nominal resistance (Ω)	Nominal current 50 Hz (mA)	Nominal current 60 Hz (mA)
12	96	125	24	74	107	91
24	384	63	60	474	43	36
60	2400	25	115	1710	23	19
110	7660	14	230	7500	17	10
220	30630	7.2				

Electrical Service Life

Electrical Service Life AC

90 % operating

- resistive load Single contacts
 - · · · · inductive load Single contacts
 - - - resistive load Twin contacts
 - - - inductive load Twin contacts
- cos φ = 0.4 ... 0.7

Switching capacity DC

Below limiting characteristic: service life of contacts

- 1 x 10⁶ switching cycles (90 % operating) resistive load
- 1 contact
- · · · · 2 contacts in series
- - - 3 contacts in series

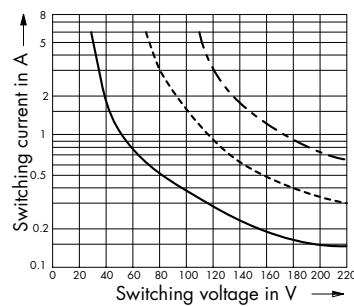
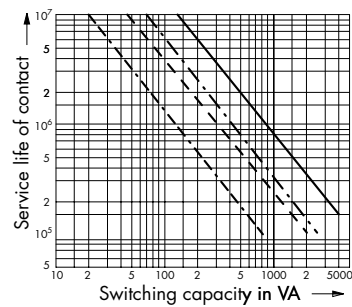



Universal Standard Types in Stock

available from stock in packets of 10 pcs each

DC			AC		
UF2-12VDC1	UF3-12VDC1	UF2G-24VDC1	UF2-24VAC1	UF3-12VAC1	UF3B-230VACN
UF2-24VDC1	UF3-12VDCN	UF3B-24VDC1	UF2-24VAC1L	UF3-24VAC1	UF3F-24VACN
UF2-24VDC1FL	UF3-24VDC1	UF3B-24VDC1FL	UF2-24VACN	UF3-24VAC1L	UF3F-230VAC1
UF2-24VDCN	UF3-24VDC1FL	UF3B-24VDC1L	UF2-110VAC1	UF3-24VACN	UF3F-230VACN
UF2-110VDCN	UF3-24VDC1L	UF3B-24VDCN	UF2-120VAC1	UF3-48VAC1	UF3G-110VAC1
	UF3-24VDCN	UF3F-24VDC1	UF2-230VAC1	UF3-110VAC1	UF3G-230VAC1
	UF3-24VDCNF	UF3F-24VDCN	UF2-230VAC1L	UF3-110VACN	UF3G-230VACN
	UF3-24VDCNFL	UF3F-24VDCNF	UF2-230VACN	UF3-115VAC1L	
	UF3-24VDCNL	UF3F-60VDCN		UF3-120VAC1	
	UF3-48VDC1	UF3F-110VDCN		UF3-230VAC1	
	UF3-48VDCN	UF3G-24VDC1		UF3-230VAC1L	
	UF3-60VDCN	UF3G-24VDC1FL		UF3-230VACN	
	UF3-110VDC1	UF3G-24VDCN		UF3-230VACNL	
	UF3-110VDC1FL	UF3G-24VDCNL			
	UF3-110VDCN	UF3G-60VDCN			
	UF3-125VDCN	UF3G-110VDCN			
	UF3-220VDC1				
	UF3-220VDCN				

Order Specifications for Accessories UF

	UF2	UF3
Socket for		
Screw connection with quick-action fastening / retaining clip	Z392 / Z434 Z395	Z345 / Z441 Z393 / Z434 Z396
Screw connection with quick-action fastening and protection diode		Z345.12 / Z441
Screw connection with quick-action fastening and RC combination		Z345.32 / Z441
Modules for socket Z396 / Z395		
Protection diode for 6 - 220 VDC	Z396.50	Z396.50
Protection / luminous diode for 24 VDC	Z396.52	Z396.52
RC combination for 110 / 230 VAC	Z396.53	Z396.53
Protection module with varistor for 24 VAC	Z396.54	Z396.54
Protection module with varistor for 230 VAC	Z396.55	Z396.55
Luminous indicator 230 VAC	Z396.58	Z396.58
Multi-function time module	Z396.64	Z396.64
Retaining clip	Z441 / Z434	Z441 / Z434



Relay Universal MF

- Standard type 
- Large contact gap, switching voltage therefore 400 VAC

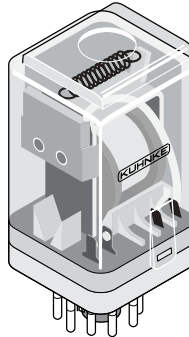

Order Code

Order code	M	F	3	-	24 V	DC
Type of relay	M					
Model						
F Plug in type for socket		F				
Contact arrangement						
2 C/O			2			
3 C/O			3			
Contact material, type of contact						
- Hard silver (no code letter)				-		
C AgCdO				C		
Nominal operation coil voltage (see coil data)						
24 V					24 V	
Coil current type						
DC Direct current						DC
AC Alternating current 50 Hz (60 Hz on request)						AC

Contact Data

	MF2 / MF3
Contact arrangement	2 or 3 C/O
Type of contact	Single contact
Contact material	Hard silver, AgCdO
Nominal contact current	6 A
Inrush current	≤ 20 A
Nominal contact voltage	400 VAC
Max. switching capacity (resistive)	3000 VA
Min. switching capacity	50 mA / 20 VDC



Dimensions, Connection Diagram(s)

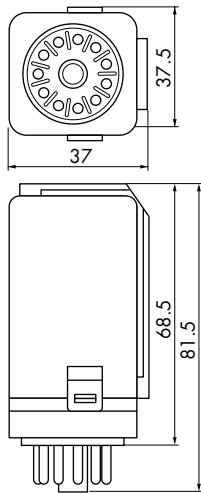

MF2 / MF3

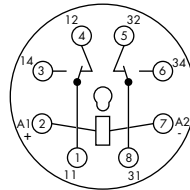

Viewed on connector pins

MF2

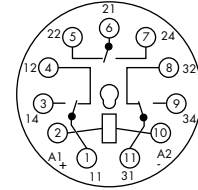

Viewed on connector pins

MF3

General Data

	MF2 / MF3	
Pull-in-time	approx. 15 ms	
Drop-out time	approx. 10 ms	
Bounce time	approx. 10 ms	
Mechanical service life	> 20 x 10 ⁶ switching cycles DC > 10 x 10 ⁶ switching cycles AC	
Test voltage		
Coil - contact	2500 VAC	
(C/O) - (C/O)	2500 VAC	
Contact - contact	1000 VAC	
Insulation group VDE 0110b/2.79	C250, B380	
Ambient temperature	-25 °C to +70 °C	
Vibration resistance (30 - 100 Hz)	> 4 g	
Weight	approx. 120 g	
Operating range	DC Class 1 (0.8 - 1.1 U _N)	AC 50 Hz Class 1 (0.8 - 1.1 U _N)
Pull-in after coil excitation with U _N at T _U	20 °C	20 °C
Drop-out	> 0.05 U _N	> 0.15 U _N



Coil Data

Coil voltage DC			Coil voltage AC, 50 Hz			MF2		MF3	
MF2 / MF3			MF2			MF2		MF3	
Nom. operation coil power appr. 1.5 W Pull-in power appr. 0.7 W			Nom. operation coil power appr. 1.8 VA Inrush current appr. 1.7 x nom. current			Nom. operation coil power appr. 1.8 VA Inrush current appr. 1.7 x nom. current		Nom. operation coil power appr. 3.8 VA Inrush current appr. 1.7 x nom. current	
Nominal voltage (V)	Nominal resistance(Ω)	Nominal current (mA)	Nominal voltage (V)	Nominal resistance (Ω)	Nominal current (mA)	Nominal resistance (Ω)	Nominal current (mA)	Nominal resistance (Ω)	Nominal current (mA)
12	103	120	12	17.9	170	9.25	340		
24	442	54	24	85.2	71	45.2	140		
40	1030	39	42	268	40	127	93		
60	2410	25	60	547	28	268	62		
110	7710	14	110	1910	16	1030	31		
220	29400	7.5	230	7710	8	3890	17		

Electrical Service Life

Electrical Service Life AC

90 % operating
 — resistive load
 - - - - inductive load
 $\cos \varphi = 0.4 \dots 0.7$

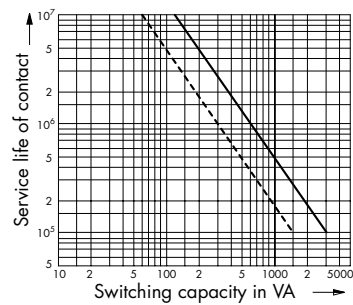

Switching capacity DC

Below limiting characteristic: service life of contacts
 1×10^6 switching cycles (90 % operating)
 resistive load

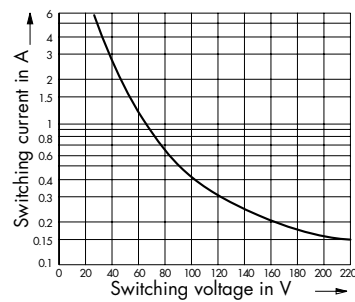



Relay Universal MF2 for Current Monitoring

- Standard type 
- Large contact gap, switching voltage therefore 400 VAC
- Monitoring of DC and AC currents

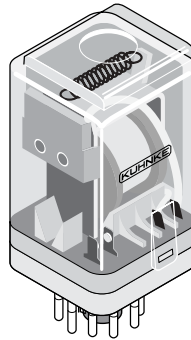

Order Code

Order code	M	F	2	-	0	40
Type of relay	M					
Model						
F Plug-in type with socket		F				
Contact arrangement						
2 C/O			2			
Coil current type						
0 Direct current					0	
1 Alternating current 50 Hz (60 Hz on request)					1	
Coil number (see order specs)						
40						40

Order Specifications

for current relay MF2 for the monitoring of DC filament bulbs and other DC loads

P \ U	6 VDC	12 VDC	24 VDC	60 VDC	110 VDC	115 VDC	220 VDC
10 W	MF2-052	MF2-046	MF2-040	-	-	-	-
25 W	MF2-056	MF2-052	MF2-046	MF2-040	MF2-034	MF2-030	-
40 W	-	MF2-056	MF2-052	MF2-040	MF2-034	MF2-037	MF2-030
60 W	-	-	MF2-052	MF2-046	MF2-040	MF2-040	MF2-034
65 W	-	-	MF2-052	MF2-046	MF2-040	MF2-040	MF2-034
80 W	-	-	MF2-056	MF2-046	MF2-046	MF2-044	MF2-037
100 W	-	-	MF2-056	MF2-052	MF2-046	MF2-046	MF2-040
150 W	-	-	-	MF2-052	MF2-046	MF2-046	MF2-040
200 W	-	-	-	MF2-056	MF2-052	MF2-052	MF2-046

for current relay MF2 for the monitoring of AC filament bulbs and other AC loads

P \ U	6 VAC 50 Hz	12 VAC 50 Hz	24 VAC 50 Hz	60 VAC 50 Hz	110 VAC 50 Hz	115 VAC 50 Hz	230 VAC 50 Hz
10 W	MF2-151	MF2-146	MF2-143	-	-	-	-
25 W	-	MF2-157	MF2-151	MF2-143	MF2-137	MF2-137	MF2-130
40 W	-	MF2-157	MF2-151	MF2-144	MF2-137	MF2-137	MF2-134
60 W	-	-	MF2-157	MF2-151	MF2-144	MF2-144	MF2-137
65 W	-	-	MF2-157	MF2-151	MF2-144	MF2-144	MF2-137
80 W	-	-	MF2-157	MF2-151	MF2-144	MF2-144	MF2-137
100 W	-	-	-	MF2-151	MF2-146	MF2-146	MF2-143
150 W	-	-	-	MF2-157	MF2-151	MF2-151	MF2-144
200 W	-	-	-	MF2-157	MF2-152	MF2-151	MF2-146



Contact Data

	MF2 for current monitoring
Contact arrangement	2 C/O
Type of contact	Single contact
Contact material	Hard silver
Nominal contact current	6 A
Inrush current	≤ 20 A
Nominal contact voltage	400 VAC
Max. switching capacity (resistive)	3000 VA
Min. switching capacity	50 mA / 20 VDC

Dimensions, Connection Diagram(s)

See relay universal MF

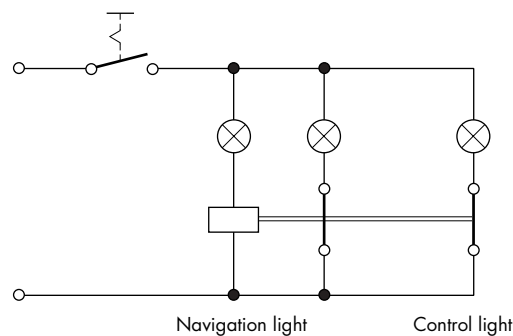

Application
 Example: Navigation lights
 Use as monitoring relay
 in accordance with connection diagram

General Data

	MF2 for current monitoring
Pull-in-time	approx. 15 ms
Drop-out time	approx. 10 ms
Bounce time	approx. 10 ms
Mechanical service life	> 20 x 10 ⁶ switching cycles DC > 10 x 10 ⁶ switching cycles AC
Test voltage	
Coil - contact	2500 VAC
(C/O) - (C/O)	2500 VAC
Contact - contact	1000 VAC
Insulation group VDE 0110b/2.79	C250, B380
Ambient temperature	-25 °C to +40 °C
Vibration resistance (30 - 100 Hz)	> 4 g
Weight	approx. 120 g
Operating range	0.9 - 1.1 I _N
Residual direct current ripple	< 25 %

Order Specifications for Accessories MF

	MF2	MF3
Socket for		
Screw connection with quick-action fastening /retaining clip	Z392 / Z434 Z395	Z345 / Z434 Z393 / Z434 Z396



Time Relay Universal 130

- Time relay for relay universal series
- 2 C/O



Order Code

Order code	130	-	2	-	01	-	2	-	3	-	24 VDC/AC
Type of relay	130										
Contact arrangement											
2 C/O			2								
Function											
01 Pull-in delay					01						
02 Switch-off delay					02						
03 Blinker					03						
06 Switch-on wiper					06						
Connection diagram											
2 1 pole							2				
Nominal time range / Impulse frequency											
3 0.1 - 3 s approx.									3		
30 0.5 - 30 s approx.									30		
180 2.0 - 180 s approx.									180		
600 4.0 - 600 s (on request)									600		
for function 03											
50 5 - 50 pulses/min approx.									50		
200 40 - 200 pulses/min approx.									200		
Nominal voltage											
24 VDC/AC											24 VDC/AC
110 VAC											110 VAC
230 VAC											230 VAC

Contact Data

	130
Contact arrangement	2 C/O
Type of contact	Single contact
Contact material	AgCdO
Nominal contact current	8 A
Inrush current	≤ 15 A
Nominal contact voltage	250 VAC
Max. switching capacity	2000 VA
Min. switching capacity	100 mA / 5 VDC



Dimensions, Connection Diagram(s)

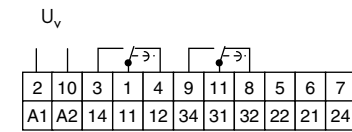
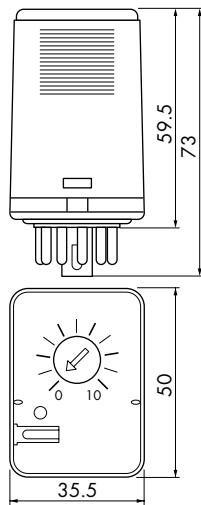

Pull-in delay

01

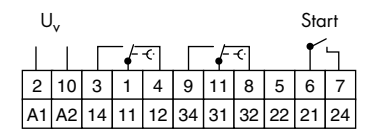

Switch-off delay

02

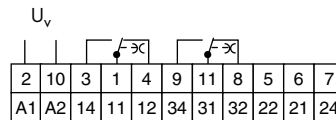

Blinker

03

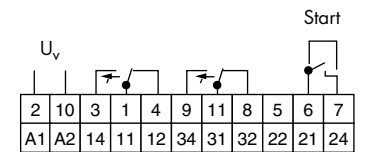

Switch-on wiper

06

General Data

	130
Mechanical service life	> 5 x 10 ⁶ switching cycles
Electrical service life	> 1 x 10 ⁵ switching cycles
Test voltage	
Inputs - contact	2500 VAC
Insulation group VDE 0110b/2.79	C250
Ambient temperature	0 °C to +40 °C
Weight	approx. 60 g
Operating range	DC / AC Class 1 0.8 - 1.1 U _N
Pull-in after coil excitation with U _N at T _U	20 °C
Nominal frequency	40 - 60 Hz
Rated power	0.8 W

Control Circuit

Relay	130 ... 01, 130 ... 03, 130 ... 06	130 ... 02
Contact voltage	Supply voltage	≤ 15 V
Contact current	≤ 150 mA	≤ 15 mA
Contact load	approx. 1 VA	≤ 0.2 W
Input impedance	approx. 180 Ω	1 kΩ
Pulse duration		≤ 70 ms

Order Specifications for Accessories

Relay		130
Socket for	Screw connection with quick-action fastening	Z345
		Z393



Function

Pull-in delay 01

Switching with supply voltage

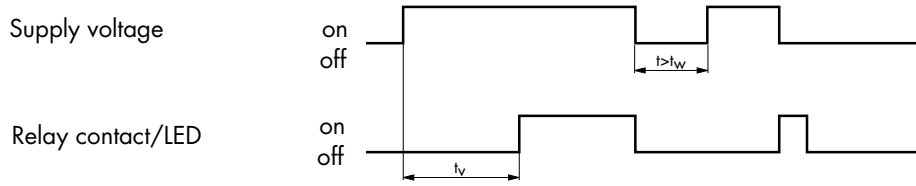

Switch-off delay 02

Switching with start contact

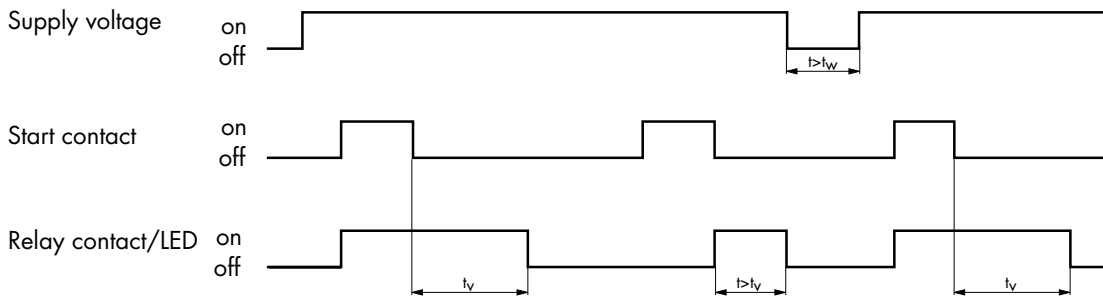

Blinker 03

Switching with supply voltage

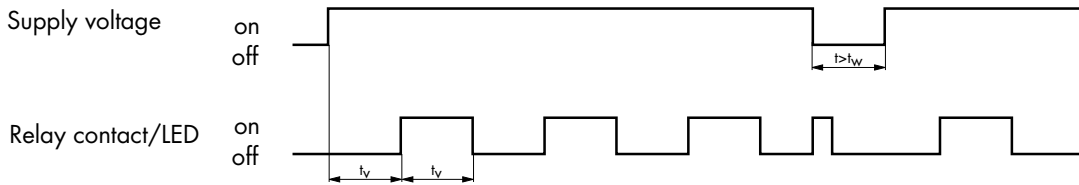

Switch-on wiper 06

Switching with start contact

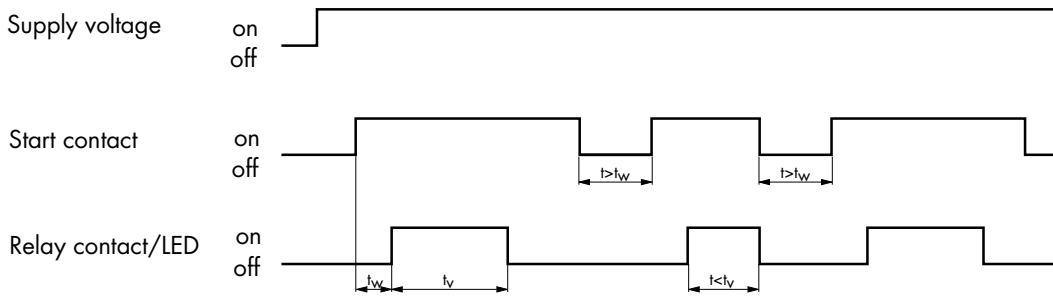

Switching with supply voltage



Socket Z392

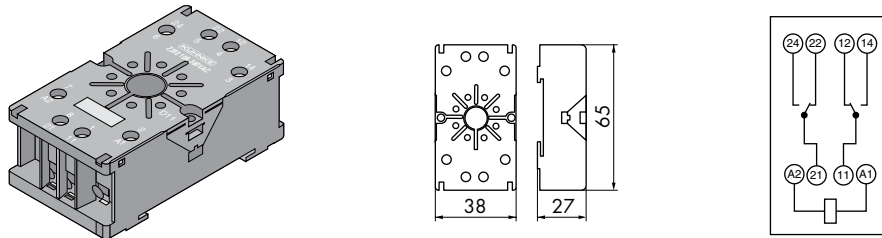

Socket	Z392
Socket design	logical, additional modules not supported
Terminal capacity	
solid conductor	2 x 2.5 mm ²
flexible conductor with ferrule	2 x 2.5 mm ²
Terminal designation	in accordance with EN50005 and IEC67
Mounting	Rail EN50022-35 x 7.5/15 Screw mounting 2 x M3 or central M4
Screw terminals	Head screws metric M3
Torque in accordance with DIN EN 60999	0.5 Nm
Nominal current	10 A
Insulation group VDE 0110b/2.79	C250, B380
Electrical shock protection	in accordance with VBG4 (professional association), VDE 0106 part 100
Weight	63 g
Retaining clip	Z434

Socket Z393

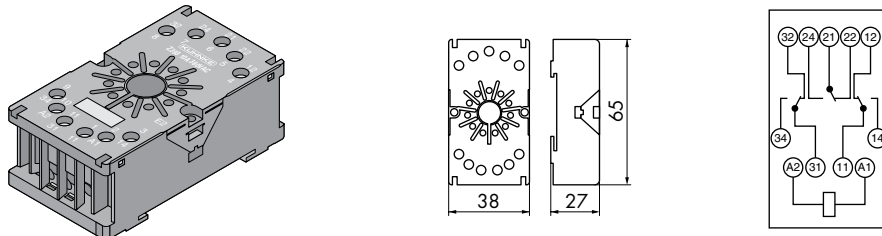

Socket	Z393
Socket design	additional modules not supported
Terminal capacity	
solid conductor	2 x 2.5 mm ²
flexible conductor with ferrule	2 x 2.5 mm ²
Terminal designation	in accordance with EN50005 and IEC67
Mounting	Rail EN50022-35 x 7.5/15 Screw mounting 2 x M3 or central M4
Screw terminals	Head screws metric M3
Torque in accordance with DIN EN 60999	0.5 Nm
Nominal current	10 A
Insulation group VDE 0110b/2.79	C250, B380
Electrical shock protection	in accordance with VBG4 (professional association), VDE 0106 part 100
Weight	63 g
Retaining clip	Z434

Socket Z345

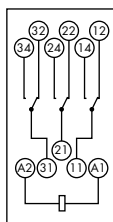
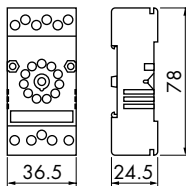
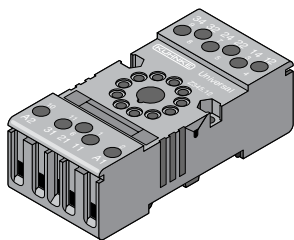

Z345

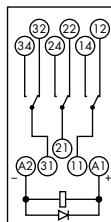

Z345.12

Protection diode up to 220 VDC

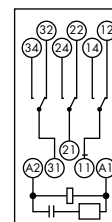

Z345.32

RC-protection unit 110 / 230 VAC

Socket	Z345
Socket design	logical, additional modules not supported
Terminal capacity	
solid conductor	2 x 2.5 mm ²
flexible conductor with ferrule	2 x 2.5 mm ²
Terminal designation	in accordance with EN50005 and IEC67
Mounting	Rail EN50022-35 x 7.5/15 Screw mounting 2 x M3 or central M4
Screw terminals	Head screws metric M2.6
Torque in accordance with DIN EN 60999	0.5 Nm
Nominal current	10 A
Insulation group VDE 0110b/2.79	C250, B380
Electrical shock protection	in accordance with VBG4 (professional association), VDE 0106 part 100
Weight	50 g
Retaining clip	Z441

Socket Z395

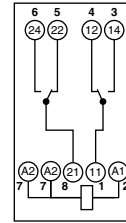
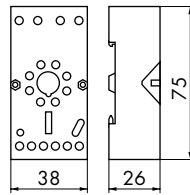
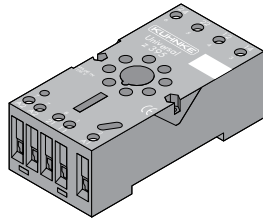

Socket	Z395
Socket design	logical, additional modules supported
Terminal capacity	
solid conductor	2 x 2.5 mm ²
flexible conductor with ferrule	2 x 1.5 mm ²
Terminal designation	in accordance with EN50005 and IEC67
Mounting	Rail EN50022-35 x 7.5/15 Screw mounting 2 x M3 or central M4
Screw terminals	Head screws metric M3
Torque in accordance with DIN EN 60999	0.5 Nm
Nominal current	10 A
Insulation group VDE 0110b/2.79	C250, B380
Electrical shock protection	in accordance with VBG4 (professional association), VDE 0106 part 100
Weight	68 g

Socket Z396

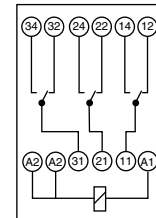
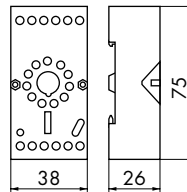
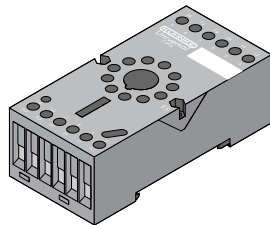

Socket	Z396
Socket design	logical, additional modules supported
Terminal capacity	
solid conductor	2 x 2.5 mm ²
flexible conductor with ferrule	2 x 1.5 mm ²
Terminal designation	in accordance with EN50005 and IEC67
Mounting	Rail EN50022-35 x 7.5/15 Screw mounting 2 x M3 or central M4
Screw terminals	Head screws metric M3
Torque in accordance with DIN EN 60999	0.5 Nm
Nominal current	10 A
Insulation group VDE 0110b/2.79	C250, B380
Electrical shock protection	in accordance with VBG4 (professional association), VDE 0106 part 100
Weight	68 g

Modules for Socket Z395/Z396

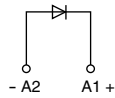
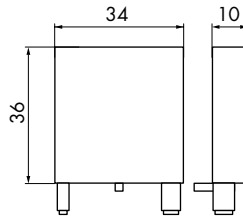
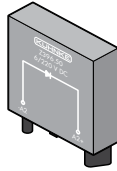

Z396.50
Protection diode

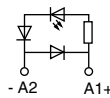

Z396.52
Protection / luminous diode
for 24 VDC



Z396.53
RC-protection unit
for 110 - 240 VAC

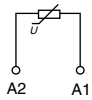

Z396.54
Varistor for 24 VAC



Z396.55
Varistor for 230 VAC

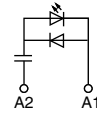

Z396.58
Luminous diode for 230 VAC

Universal Timer Module Z396.64 for Socket Z396

- Timer module for relay universal series
- Multi voltage of 24 - 240 VDC/AC
- Multi-functional with 8 functions
- Multi time range from 50 ms - 240 h

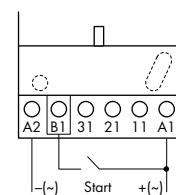
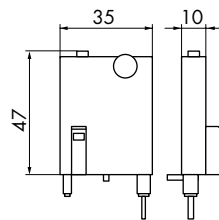
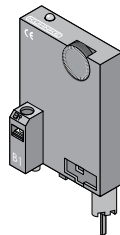

Technical data see pages 17 - 18.

Accessories for Relay Universal

Contact Data

When using relay UF3 and socket Z396

3 change-over contacts (C/O)				
Type of contact	Single contact		Twin contact	
Contact material	AgNi	AgNi gold-plated	AgNi	AgNi gold-plated
Nominal contact current	10 A		4 A	
Inrush current	≤ 20 A		≤ 10 A	
Nominal contact voltage	250 VAC		250 VAC	
Max. switching capacity (resistive)	3000 VA		1000 VA	
Min. switching capacity	50 mA / 20 VDC	1 mA / 100 mVDC	20 mA / 10 VDC	1 mA / 100 mVDC



General Data

Voltage range supply	24 V to 240 VAC, 24 V to 250 VDC -15 % to +10 % in relation to U_N
Voltage range control contact	at 24 V min. 80 % of supply voltage at 230 V min. 95 % of supply voltage
Duty cycle	100 %
Frequency	48 Hz to 63 Hz
Power failure bridging time	max. 10 ms
Recovery time	max. 100 ms at 25 °C, max. 150 ms at 55 °C
Adjustments	Time ranges and functions selectable via DIP switch Time setting via potentiometer
Temperature range	-25 °C to +55 °C
Indicators	Green "Power on" LED Green LED flashes during delay time
Supply voltage terminal	plug-in to socket Z396
Control voltage terminal	Terminal B1

Time Ranges

Time ranges, time range limit	Adjustment range
1 s	0.05 - 1 s
10 s	0.5 - 10 s
1 min	3 s - 60 s
10 min	30 s - 600 s
1 h	3 min - 60 min
10 h	30 min - 600 min
1 day/24 h	1.2 h - 24 h
10 day/240 h	12 h - 240 h

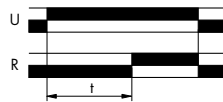
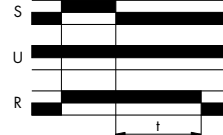
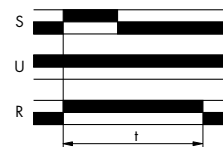
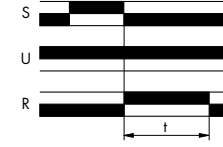
Time Functions

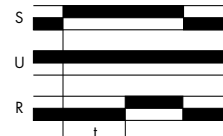
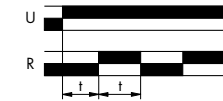
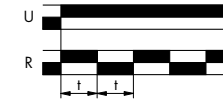
Function	Description of function	Function diagram
E	Switch-on delay Start by switching the supply voltage	
R	Switch-off delay Start with control contact	
Ws	Switch-on wiper Start with control contact	
Wa	Switch-off wiper Start with control contact	
Wu	Switch-on wiper Start by switching the supply voltage	
Es	Switch-on delay Start with control contact	
Bp	Blinker 0 - starting Start by switching the supply voltage	
Bi	Blinker 1 - starting Start by switching the supply voltage	



Quattro Relay 114A4

- Standard type  / 
- With LED and protection diode on request

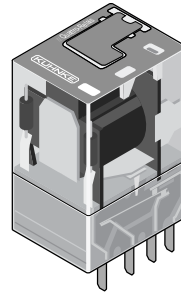

Order Code

Order Code	Quattro Relay	114	A	4	-	24 V	DC	N
Type of relay	Quattro Relay	114						
Model								
A Plug-in type			A					
Contact arrangement								
2 C/O (on request)				2				
4 C/O				4				
Contact material								
- AgNi (no code letter)					-			
B AgNi gold-plated					B			
Nominal operation coil voltage (see coil data)								
24 V						24 V		
Coil current type								
DC Direct current							DC	
AC Alternating current (50 / 60 Hz)							AC	
Versions								
N with position indicator with manual override without override lever								N
1 with position indicator with manual override with override lever								1

Contact Data

	114 A4	
Contact arrangement	4 C/O	
Type of contact	Single contact	
Contact material	AgNi	AgNi gold-plated
Nominal contact current	10 A	
Inrush current	≤ 20 A	
Nominal contact voltage	110 VDC / 250 VAC	
Max. switching capacity (resistive)	144 W / 2000 VA	
Min. switching capacity	10 mA / 5 V	1 mA / 100 mV



Dimensions, Connection Diagram(s)

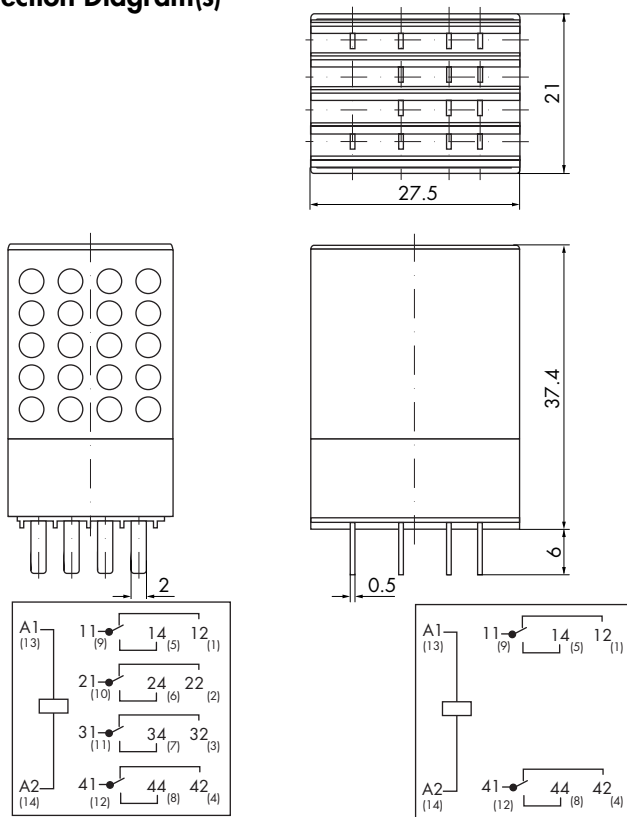

Relay with protection diode	
Standard 114 ... F1	+ to A1 (13) - to A2 (14)
Special 114 ... F	- to A1 (13) + to A2 (14)

Viewed on terminals
114 A4

Viewed on terminals
114 A2 (on request)

General Data

	114 A4	
Pull-in-time	approx. 10 ms	
Drop-out time	approx. 10 ms	
Bounce time	approx. 5 ms	
Mechanical service life	> 20 x 10 ⁶ switching cycles	
Test voltage		
Coil - contact	2500 VAC	
(C/O) - (C/O)	2000 VAC	
Contact - contact	1000 VAC	
Insulation group VDE 0110b/2.79	B250	
Insulation coordination to DIN EN 61810-5/ VDE 0435 Part 140		
Operating voltage	250 V	
Overvoltage category	III	
Pollution degree	3	
Ambient temperature	-40 °C to +60 °C	
Vibration resistance (30 - 100 Hz)	> 2 g N/C > 10 g N/O	
Weight	approx. 33 g	
Operating range	DC Class 1 (0.8 - 1.1 U _N)	AC Class 2 (0.85 - 1.1 U _N)
Pull-in after coil excitation with U _N , nominal current at T _U	60 °C	20 °C
Drop-out	> 0.05 U _N	> 0.15 U _N



Coil Data

Coil voltage DC			114A4 Pull-in power approx. 0.42 W Nom. operation power approx. 1 W			Coil voltage AC		114A4 Nom. operation power appr. 1.2/0.98 VA Inrush current appr. 1.5 x nominal current	
Nominal voltage (V)	Nominal resistance (Ω)	Nominal current (mA)	Nominal voltage (V)	Nominal resistance (Ω)	Nominal current 50 Hz (mA)	Nominal current 60 Hz (mA)			
12	143	84	12	46.5	100	81			
24	576	42	24	177	50	41			
48	2250	21	48	762	25	20			
110	12100	9	115	4570	10	8.5			
			120	4570	11	8.8			
			230	19040	5.2	4.2			

Electrical Service Life

Electrical Service Life AC

90 % operating
 — resistive load
 - - - - - conductive load
 $\cos \varphi = 0.4 \dots 0.7$

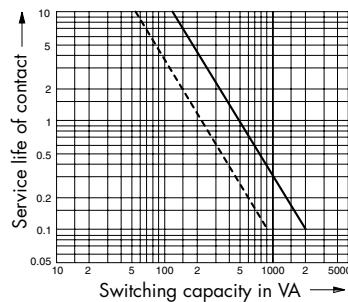

Switching Capability DC

Below limiting characteristic: service life of contacts
 2×10^4 switching cycles (90 % operating)
 resistive load

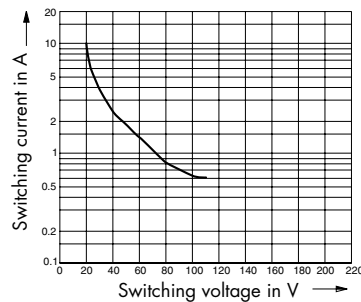

Quattro Relay Standard Types in Stock

available from stock in packs of 10 pcs each

DC		AC	
114 A4-12VDC1	114 A4B-24VDC1	114 A4-12VAC1	114 A4B-230VAC1
114 A4-12VDC1L	114 A4B-24VDCN	114 A4-24VAC1	114 A4B-230VACN
114 A4-12VDCN		114 A4-24VAC1L	
114 A4-24VDC1		114 A4-24VACN	
114 A4-24VDC1F1		114 A4-48VAC1	
114 A4-24VDC1FL		114 A4-115VAC1	
114 A4-24VDC1FL1		114 A4-115VAC1L	
114 A4-24VDC1L		114 A4-115VACN	
114 A4-24VDCN		114 A4-120VAC1	
114 A4-24VDCNF		114 A4-120VAC1L	
114 A4-24VDCNFL		114 A4-230VAC1	
114 A4-24VDCNFL1		114 A4-230VAC1L	
114 A4-48VDC1		114 A4-230VACN	
114 A4-48VDC1L		114 A4-230VACNL	
114 A4-48VDCN			
114 A4-110VDC1			
114 A4-110VDCN			

Order Specifications for Accessories

Relay	114 A4/A2
Socket for screw connection with quick-action fastening, C250	Z366.02
Socket for screw connection with quick-action fastening, C250, safe separation	Z368.02
Socket for screw connection with quick-action fastening incl. retaining spring	Z376.42
Modules for sockets	
Protection diode + at A2	Z318.50
Protection / luminous diode 24 VDC + at A2	Z318.57
Protection / luminous diode 24 VDC + at A1	Z318.51
Protection diode + at A1	Z318.53
Protection module with varistor 24 VAC	Z318.54
Protection module with varistor 230 VAC	Z318.55
Luminous diode for 24 VAC/DC	Z318.52
Luminous diode for 230 VAC	Z318.58
Retaining clip	Z366.80
Socket for printed circuit	Z378
Socket for soldered connection	Z374

Socket Z366.02

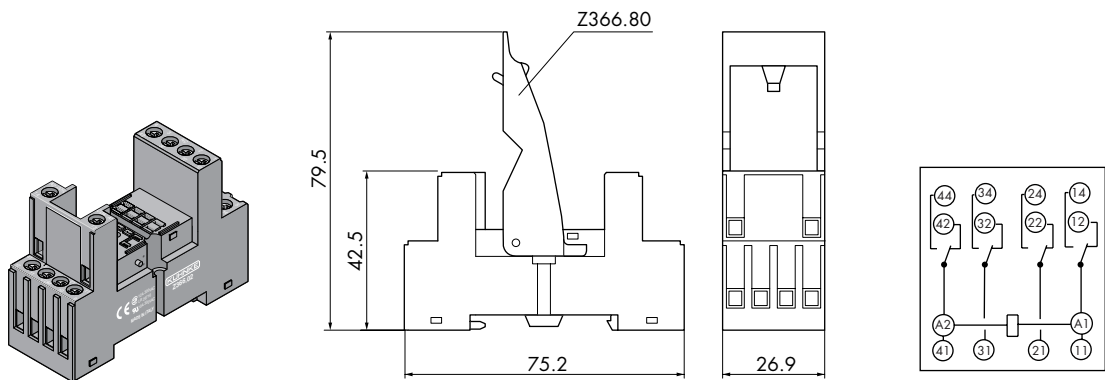

Socket	Z366.02
Socket design	logical
Terminal capacity	
solid conductor	2 x 1.5 mm ²
flexible conductor with ferrule	2 x 1.0 mm ²
Terminal designation	in accordance with DIN 46199 and IEC 67
Mounting	Rail EN50022-35 x 7.5/15 Screw mounting 2 x M3
Screw terminals	Head screws metric M3
Torque in accordance with DIN EN 60999	0.5 Nm
Nominal current	10 A
Insulation group VDE 0110b/2.79	C250
Electrical shock protection	in accordance with VBG4 (professional association), VDE 0106 part 100
Weight	52 g
Retaining clip	Z366.80

Socket Z368.02

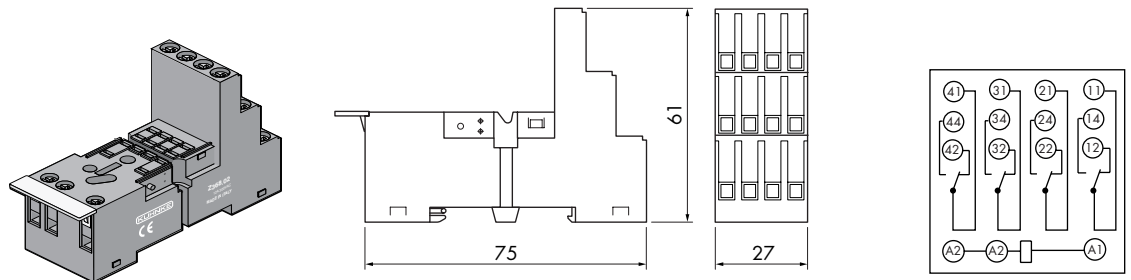

Socket	Z368.02
Socket design	logical, safe separation
Terminal capacity	
solid conductor	2 x 2.5 mm ²
flexible conductor with ferrule	2 x 1.5 mm ²
Terminal designation	in accordance with EN50005 and IEC 67
Mounting	Rail EN50022-35 x 7.5/15 Screw mounting 2 x M3
Screw terminals	Head screws metric M3
Torque in accordance with DIN EN 60999	0.5 Nm
Nominal current	12 A
Insulation group VDE 0110b/2.79	C250
Electrical shock protection	in accordance with VBG4 (professional association), VDE 0106 part 100
Weight	70 g
Retaining clip	Z366.80

Socket Z376.42

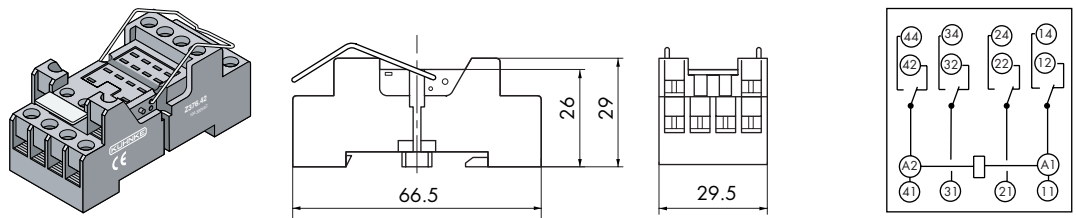

Socket	Z376.42
Socket design	logical, with retaining spring
Terminal capacity	
solid conductor	2 x 1.5 mm ²
flexible conductor with ferrule	2 x 1.5 mm ²
Terminal designation	in accordance with EN50005 and IEC 67
Mounting	Rail EN50022-35 x 7.5/15 Screw mounting 2 x M4
Screw terminals	Head screws metric M3
Torque in accordance with DIN EN 60999	0.5 Nm
Nominal current	12 A
Insulation group VDE 0110b/2.79	B250
Electrical shock protection	in accordance with VBG4 (professional association), VDE 0106 part 100
Weight	49 g
Retaining clip	Z366.80
Retaining spring	enclosed

Modules for Sockets Z366.02, Z368.02, and Z376.42

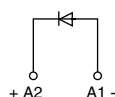
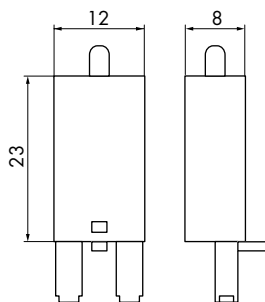
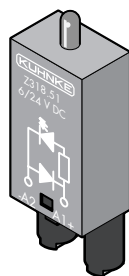

Z318.50

Protection diode + to A2

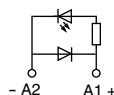

Z318.51

Protection / luminous diode for 6 - 24 VDC + to A1

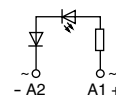

Z318.52

LED for 6 - 24 VAC/DC

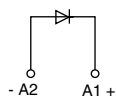

Z318.53

Protection diode + to A1



Z318.54

Varistor for 24 VAC



Z318.55

Varistor for 230 VAC

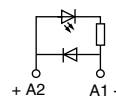

Z318.57

Protection / luminous diode for 6 - 24 VDC + to A2



Z318.58

LED for 110/230 VAC



Miniature Relay 111A2/H1

- Standard type  / 
- With LED and protection diode on request (please note polarity)

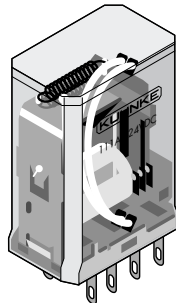

111 A2

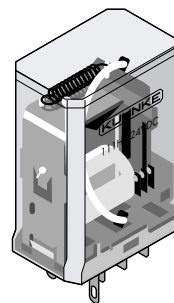

111 H1

Order Code

Order code	111	A	2	-	24 V	DC
Type of relay	111					
Model						
A Plug-in type		A				
H Plug-in type		H				
Contact arrangement						
1 C/O (model H)			1			
2 C/O (model A)			2			
Nominal operation coil voltage (see coil data)						
24 V					24 V	
Coil current type						
DC Direct current						DC
AC Alternating current (50 / 60 Hz)						AC

Contact Data

	111H1	111A2
Contact arrangement	1 C/O	2 C/O
Type of contact	Single contact	
Contact material	AgCdO	Silver gold-plated
Nominal contact current	10 A	3 A
Inrush current	≤ 10 A	≤ 5 A
Nominal contact voltage	250 VAC / DC	250 VAC / DC
Max. switching capacity (resistive)	1540 VA	660 VA
Min. switching capacity	50 mA / 20 VDC	20 mA / 5 VDC



Dimensions, Connection Diagram(s)

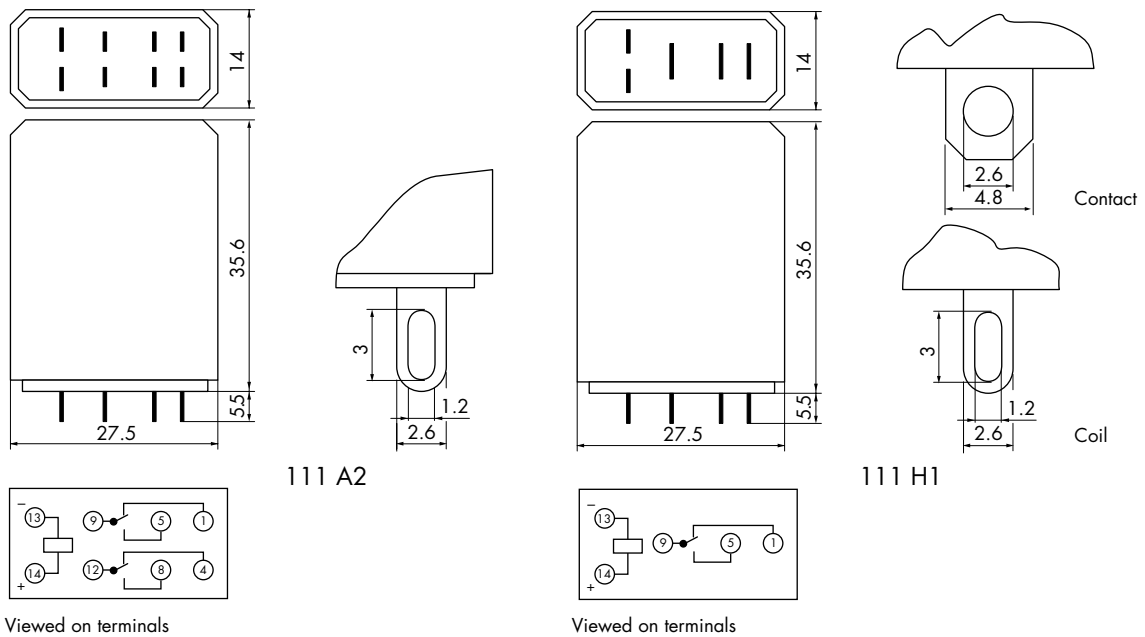

General Data

	111H1	111A2
Pull-in-time	approx. 10 ms	
Drop-out time	approx. 8 ms	
Bounce time	approx. 3 ms	
Mechanical service life	> 20 x 10 ⁶ switching cycles	
Test voltage		
Coil - contact	2000 VAC	1500 VAC
(C/O) - (C/O)		1500 VAC
Contact - contact	1000 VAC	
Insulation group VDE 0110b/2.79	C30, B125, A250	
Ambient temperature	-25 °C to +50 °C	
Vibration resistance (30 - 100 Hz)	> 10 g	
Weight	approx. 20 g	
Operating range	Class 2 (0.85 - 1.1 U _N)	
Pull-in after coil excitation with U _N at T _U	20 °C	
Drop-out	> 0.05 x U _N DC > 0.15 x U _N AC	

Coil Data

Coil voltage DC	111A2/H1 Pull-in power approx. 0.5 W Nom. operation power approx. 0.8 W		Coil voltage AC		111A2/H1 Nom. operation power approx. 0.9/1 VA Inrush current approx. 1.5 x nominal current	
	Nominal voltage (V)	Nominal resistance (Ω)	Nominal current (mA)	Nominal voltage (V)	Nominal resistance (Ω)	Nominal current 50 Hz (mA)
12	188	64	12	76.5	86	75
24	750	32	24	300	42	37
48	2660	18	48	1280	20	18
			115	7210	8.9	7.8



Electrical Service Life

Electrical Service Life AC

90 % operating

— resistive load

- - - inductive load

$\cos \varphi = 0.4 \dots 0.7$

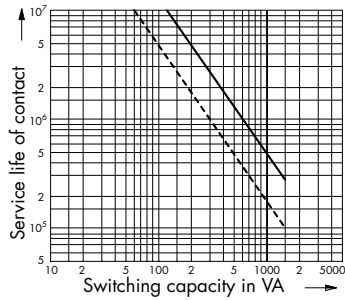

111 H1

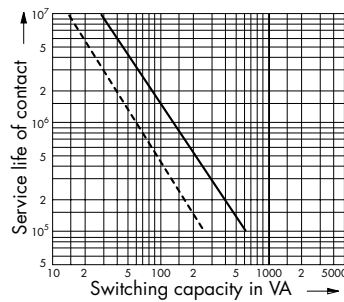

111 A2

Switching Capability DC

Below limiting characteristic: service life of contacts

1×10^6 switching cycles (90 % operating)

resistive load

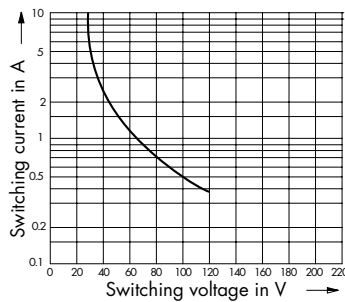

111 H1

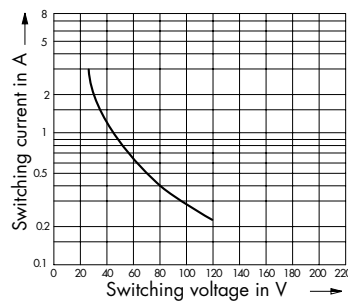

111 A2

Order Specifications for Accessories 111 A2/H1

Relay	111 H1	111 A2
Socket for screw connection with quick-action fastening	Z375.12	Z375.02
printed circuit	Z377.10	Z377
solder connection	Z373.10	Z373
Retaining clip	Z475	Z475

Socket Z375.12

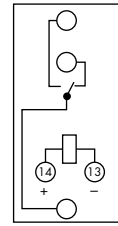
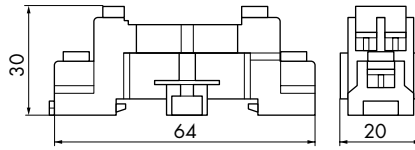
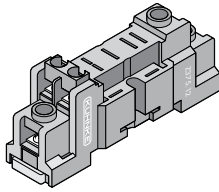

Socket	Z375.12
Socket design	logical
Terminal capacity	
solid conductor	2 x 1.5 mm ²
flexible conductor with ferrule	2 x 1.0 mm ²
Terminal designation	in accordance with EN50005 and IEC 67
Mounting	Rail EN50022-35 x 7.5/15 Screw mounting 2 x M4
Screw terminals	Head screws metric M3
Torque in accordance with DIN EN 60999	0.5 Nm
Nominal current	10 A
Insulation group VDE 0110b/2.79	C380
Electrical shock protection	in accordance with VBG4 (professional association), VDE 0106 part 100
Weight	27 g
Retaining clip	Z475

Socket Z375.02

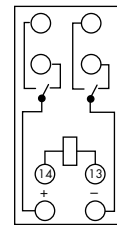
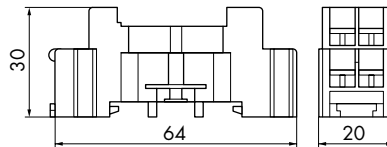
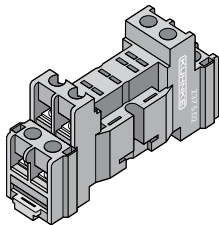

Socket	Z375.02
Socket design	logical
Terminal capacity	
solid conductor	2 x 1.5 mm ²
flexible conductor with ferrule	2 x 1.0 mm ²
Terminal designation	in accordance with DIN 46199 and IEC 67
Mounting	Rail EN50022-35 x 7.5/15 Screw mounting 2 x M4
Screw terminals	Head screws metric M3
Torque in accordance with DIN EN 60999	0.5 Nm
Nominal current	3 A
Insulation group VDE 0110b/2.79	C250
Electrical shock protection	in accordance with VBG4 (professional association), VDE 0106 part 100
Weight	27 g
Retaining clip	Z475

Socket Z377.10

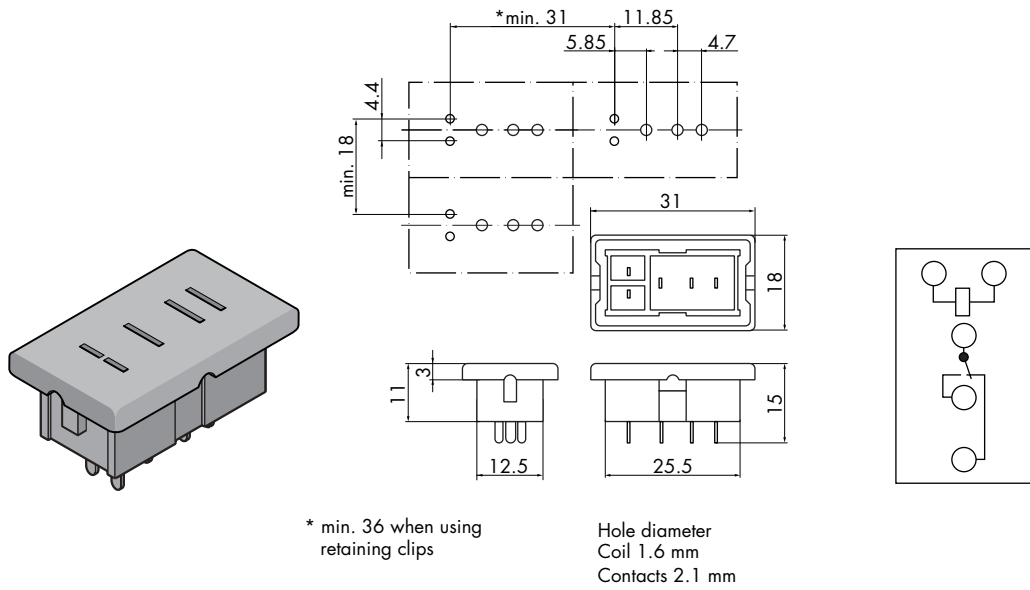

Socket	Z377.10
Terminal	Soldered pins
Mounting	Soldered to circuit board
Insulation group VDE 0110b/2.79	B30, A125
Weight	approx. 6 g
Retaining clip	Z475

Socket Z377

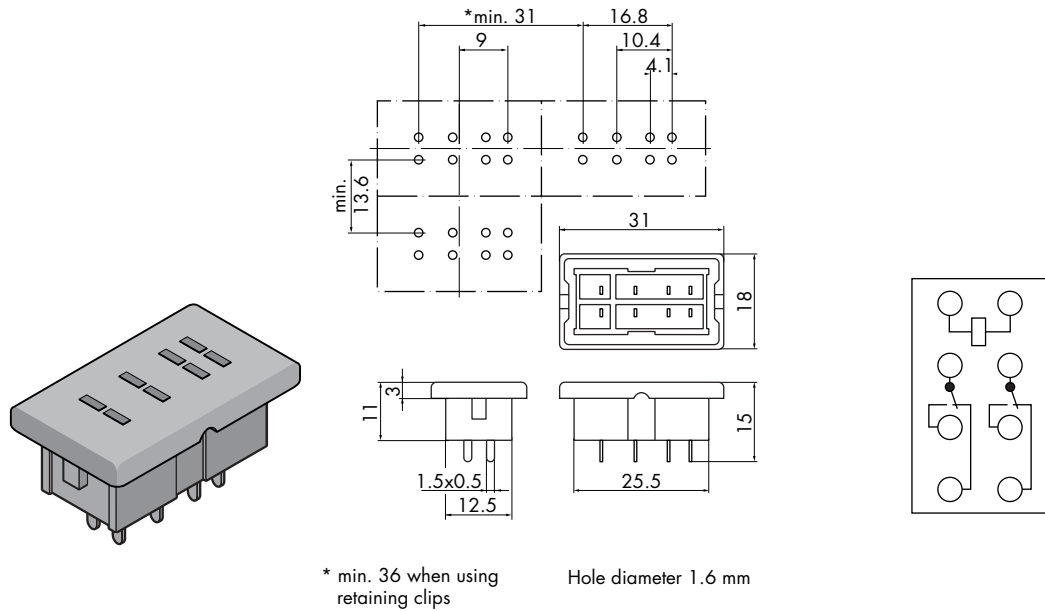

Socket	Z377
Terminal	Soldered pins
Mounting	Soldered to circuit board
Insulation group VDE 0110b/2.79	B30, A125
Weight	approx. 6 g
Retaining clip	Z475



Industrial Switching Relay I

- Standard type , specify in order
- Twin contacts for high contact making reliability
- 2, 4, 6 or 8 C/O possible
- Large contact gap, switching voltage therefore 400 V
- Supplied with blow-out magnet for high DC loads

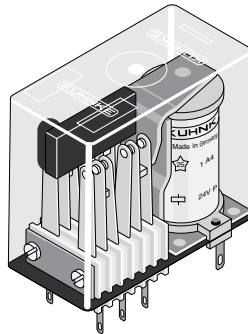

Order Code

Order code	I	A	4		-	24 V	DC	
Type of relay	I							
Model								
A Plug-in type for socket or soldered connection		A						
C For 2.8 mm connector, B-extension required for EN-mounting		C						
G For printed circuit		G						
Contact arrangement								
2 C/O			2					
4 C/O			4					
6 C/O (for DC only)			6					
8 C/O (for DC only)			8					
Contact material, type of contact								
- Hard silver (no code letter)				-				
C AgCdO				C				
F Twin contacts hard silver				F				
G Twin contacts hard silver gold-plated				G				
Nominal operation coil voltage (see coil data)								
24 V						24 V		
Coil current type								
DC Direct current							DC	
AC Alternating current 50 Hz (60 Hz on request) for IA2 and IA4 only							AC	
Extensions								
- None (no code letter)								-
M Blow-out magnet								M
B Quick-action fastening for rail EN50022-35 x 7.5 (combination M/B not for IA2/C2)								B



Contact Data

	I			
Contact arrangement	2, 4, 6, 8 C/O			
Type of contact	Single contact		Twin contact	
Contact material	hard silver	AgCdO	hard silver	hard silver gold-plated
Nominal contact current	6 A		4 A	
Inrush current	≤ 20 A		≤ 10 A	
Nominal contact voltage	400 VAC, 250 V (with 8 C/O)			
Max. switching capacity (resistive)	3000 VA, 2000 VA (with 8 C/O)		1200 VA	
Min. switching capacity	50 mA / 20 VDC	50 mA / 20 VDC	20 mA / 10 VDC	1 mA / 100 mV

Dimensions, Connection Diagram(s)

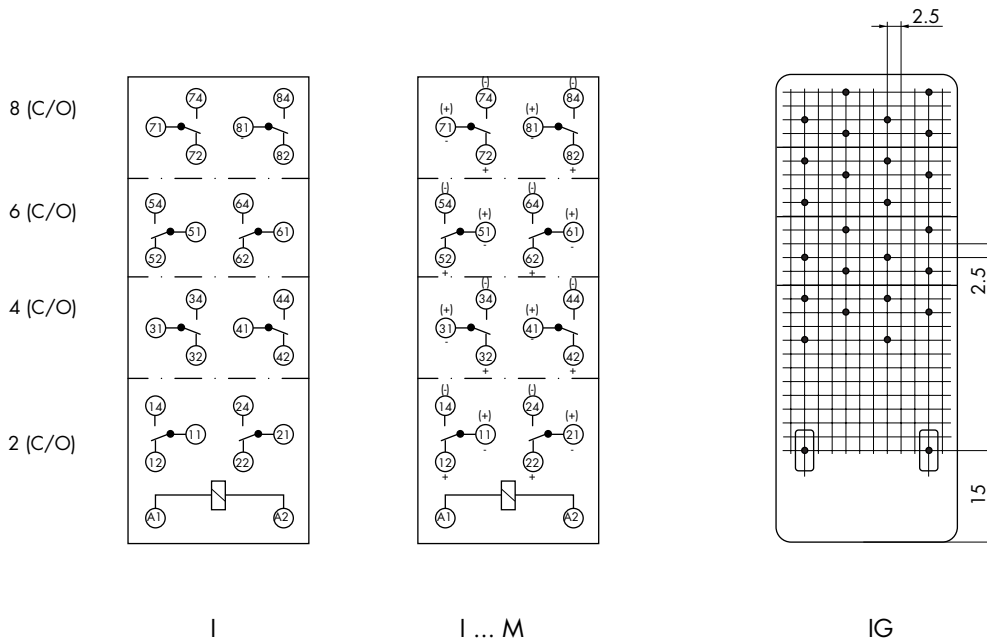
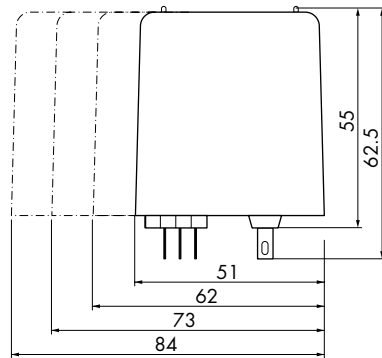
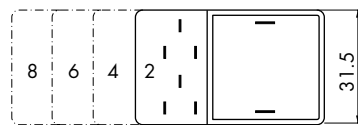



General Data

	I	
Pull-in-time	approx. 15 ms	
Drop-out time	approx. 10 ms	
Bounce time	approx. 6 ms	
Mechanical service life	> 20 x 10 ⁶ switching cycles DC > 15 x 10 ⁶ switching cycles AC	
Test voltage	Coil - contact 2500 VAC (C/O) - (C/O) 2500 VAC Contact - contact 1000 VAC	
Insulation group VDE 0110b/2.79	C250, B380	
Ambient temperature	-25 °C to +60 °C DC -25 °C to +40 °C AC	
Vibration resistance (30 - 100 Hz)	> 2 g	
Weight	approx. 140 g to 180 g	
Operating range	DC Class 1 (0.8 - 1.1 U _N)	AC, 50 Hz Class 1 (0.8 - 1.1 U _N)
Pull-in after coil excitation with U _N at T _U	20 °C	
Drop-out	> 0.05 U _N	> 0.15 U _N

Coil Data

Coil voltage DC*	IA2 Nom. operation coil power appr. 0.9 W Pull-in power appr. 0.5 W		Coil voltage AC, 50 Hz*	IA2 Nom. operation coil power appr. 3.5 VA Inrush current appr. 1.7 x nominal current	
	Nom. resistance (Ω)	Nominal current (mA)		Nom. resistance (Ω)	Nominal current (mA)
12	208	58	12	7.7	250
24	702	34	24	37	100
40	1980	20	42	106	67
60	4030	15	60	208	50
110	12800	8.6	110	853	22
220	48700	4.5	230	3120	13

* Other voltages on request

Coil voltage DC*	IA4 Nom. operation coil power appr. 1.7 W Pull-in power appr. 0.8 W		Coil voltage AC, 50 Hz*	IA4 Nom. operation coil power appr. 5 VA Inrush current appr. 1.7 x nominal current	
	Nom. resistance (Ω)	Nominal current (mA)		Nom. resistance (Ω)	Nominal current (mA)
12	88	140	12	5	420
24	363	66	24	22	210
40	853	47	42	71	110
60	1980	30	60	139	80
110	8010	14	110	458	46
220	30500	7.2	230	2350	21

* Other voltages on request

Coil voltage DC*	IA6 Nom. operation coil power appr. 3.3 W Pull-in power appr. 1.4 W		Coil voltage DC*	IA8 Nom. operation coil power appr. 3.3 W Pull-in power appr. 1.4 W	
	Nom. resistance (Ω)	Nominal current (mA)		Nom. resistance (Ω)	Nominal current (mA)
12	47	260	12	47	260
24	164	150	24	164	150
40	458	87	40	458	87
60	1060	57	60	1060	57
110	4030	27	110	4030	27
220	12800	17	220	12800	17

* Other voltages on request



Electrical Service Life

Electrical Service Life AC

90 % operating

- resistive load
- - - - inductive load
- $\cos \varphi = 0.4 \dots 0.7$

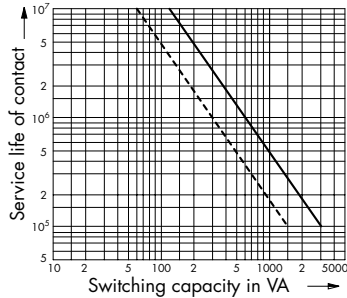

2, 4, 6 C/O

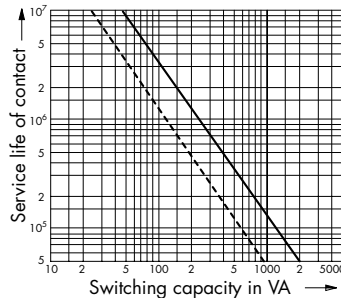

8 C/O

Switching Capability DC

without blow-out magnet

Below limiting characteristic: service life of contacts

1×10^6 switching cycles (90 % operating)

resistive load

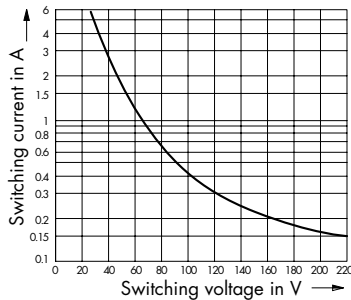

2, 4, 6 C/O

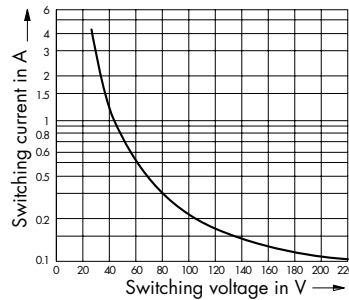

8 C/O

Electrical Service Life DC

with blow-out magnet, resistive load with 2, 4, 6 and 8 C/O

Switching current (A)	Voltage (V)	Service life switching cycles approx.	Voltage (V)	Service life switching cycles approx.	Voltage (V)	Service life switching cycles approx.
1	24	-	110	0.7×10^6	220	0.2×10^6
2		1.5×10^6		0.5×10^6		2.5×10^6
4		0.8×10^6		2.0×10^6		2.5×10^6
6		-		3.0×10^6		0.6×10^6
8*		2.0×10^6		-		0.1×10^6
10*		2.0×10^6		0.1×10^6		
12*		0.3×10^6				

* not admitted for continuous current

Order Specifications for Accessories

Relay	IA2	IA4	IA6	IA8
Socket for screw connection with quick-action fastening	Z382.02			
Retaining clip	Z482			
Mounting bracket	Z582		Z582	
Electrical shock protection for Z382.02, 2 pcs. per socket	Z382.50			



Industrial Heavy Duty Relay IH

- 1 N/O for 16 A
- Long service life of contact at high switching capacity

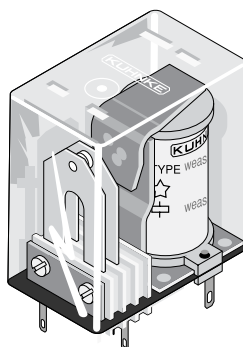

Order Code

Order code	I	H	100	-	24 V	DC	
Type of relay	I						
Model							
H Plug-in type for socket or soldered connection		H					
Contact arrangement							
100 1 N/O			100				
Nominal operation coil voltage (see coil data)							
24 V					24 V		
Coil current type							
DC Direct current						DC	
AC Alternating current 50 Hz (60 Hz on request)						AC	
Extensions							
- None (no code letter)							-
B Quick-action fastening for rail EN50022-35 x 7.5							B

Contact Data

	IH 100
Contact arrangement	1 N/O
Type of contact	Single contact
Contact material	Hard silver
Nominal contact current	16 A
Inrush current	≤ 50 A
Nominal contact voltage	400 VAC / DC
Max. switching capacity (resistive)	4000 VA
Min. switching capacity	50 mA / 20 VDC



Dimensions, Connection Diagram(s)

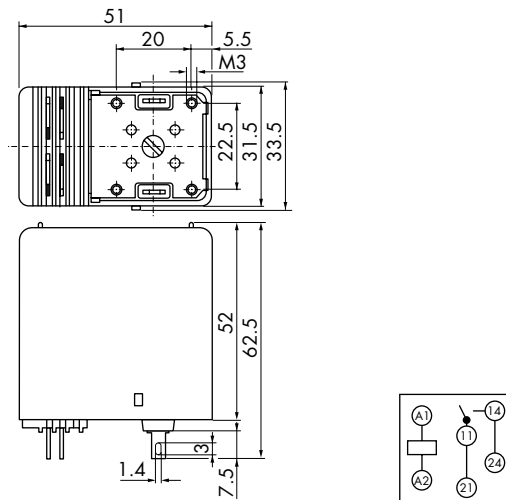

Viewed on terminals

General Data

		IH 100	
Pull-in-time		approx. 15 ms	
Drop-out time		approx. 10 ms	
Bounce time		approx. 8 ms	
Mechanical service life		> 15 x 10 ⁶ switching cycles	
Test voltage		2500 VAC	
Coil - contact		2500 VAC	
Insulation group VDE 0110b/2.79		C250, B380	
Ambient temperature		-25 °C to +75 °C DC -25 °C to +40 °C AC	
Vibration resistance (30 - 100 Hz)		> 4 g	
Weight		approx. 140 g	
Operating range		DC Class 1 (0.8 - 1.1 U _N)	AC, 50 Hz Class 1 (0.8 - 1.1 U _N)
Pull-in after coil excitation with U _N at T _U		20 °C	
Drop-out		> 0.05 U _N	> 0.15 U _N

Coil Data

Coil voltage* DC	IH 100 Nom. operation coil power approx. 0.9 W Pull-in power approx. 0.5 W			Coil voltage* AC, 50 Hz*	IH 100 Nom. operation coil power approx. 5 VA Inrush current approx. 1.7 x nominal current	
	Nominal voltage (V)	Nom. resistance (Ω)	Nominal current (mA)		Nominal voltage (V)	Nom. resistance (Ω)
12	208	58	24	22	210	
24	702	34	230	2350	21	
40	1980	20				

* Other coil voltages on request



Electrical Service Life

Electrical Service Life AC

90 % operating

— resistive load

- - - - inductive load

$\cos \varphi = 0.4 \dots 0.7$

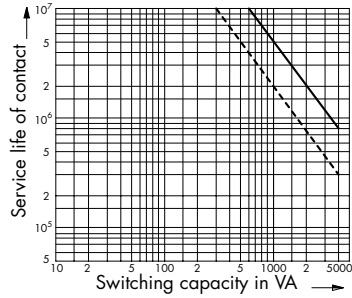

Switching Capability DC

Below limiting characteristic: service life of contacts

1×10^6 switching cycles (90 % operating)

resistive load

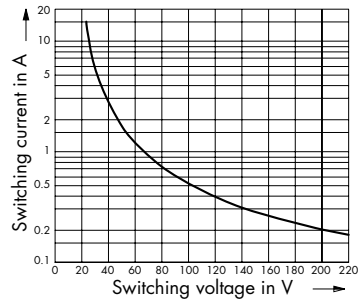

Order Specifications for Accessories

Relay	IH100
Socket for screw connection with quick-action fastening	Z382.02
Retaining clip	Z482
Mounting bracket	Z582
Electrical shock protection	Z382.50

Socket Z382.02

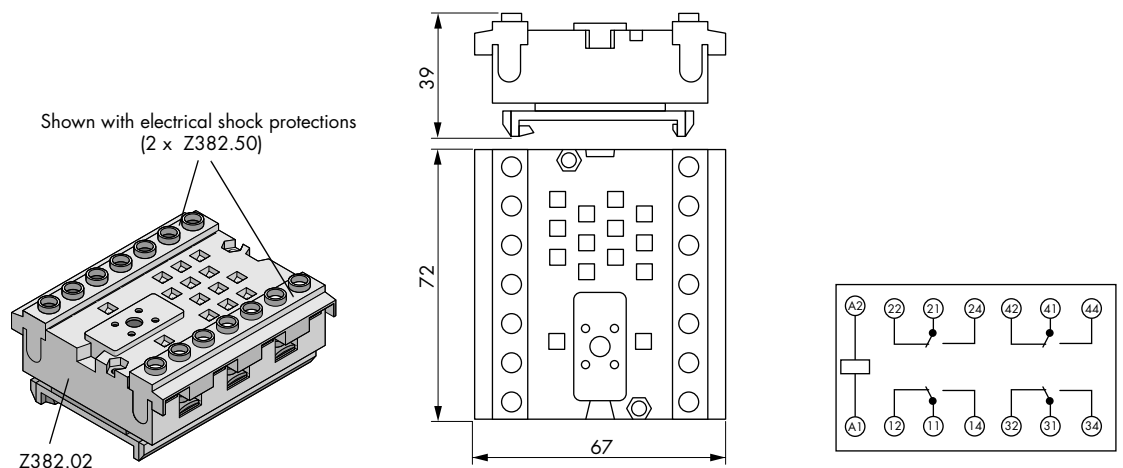

Socket	Z382.02
Socket design	
Terminal capacity solid conductor flexible conductor with ferrule	2 x 2.5 mm ² 2 x 1.5 mm ²
Terminal designation	in accordance with EN50005
Mounting	Rail EN50022-35 x 7.5/15
Screw terminals	Head screws metric M4
Torque in accordance with DIN EN 60999	1.2 Nm
Nominal current	6 A
Insulation group VDE 0110b/2.79	C250
Electrical shock protection	Electrical shock protection optional 2 x Z382.50
Weight	105 g
Retaining clip	Z482

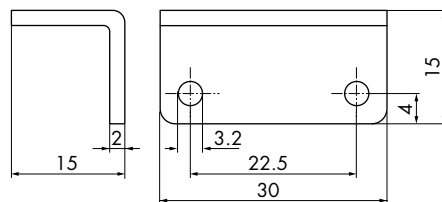

Mounting Bracket Z582



	Z582
Mounting	with screw M3 to relay
Weight	approx. 11 g



Relay-Contactor 105

- Standard type , , 
- Mechanically guided contacts for security controls in accordance with DIN VDE 0113 part 1
- High switching capability through bridge contacts
- High contact making reliability through twin contacts
- Version for printed circuit

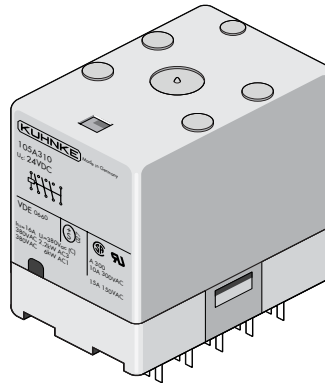

Order Code

Order code	105	A	400		-	24 V	DC	
Type of relay	105							
Model								
A Plug-in type for socket 6.3 mm or 2 x B 2.8 resp. in accordance with DIN 46247		A						
G For printed circuit		G						
Contact arrangement								
400 4 N/O			400					
310 3 N/O, 1 N/C			310					
220 2 N/O, 2 N/C			220					
Contact material, type of contact								
- Hard silver (no code letter)				-				
C AgCdO (model A only)				C				
F Twin contacts hard silver				F				
Nominal operation coil voltage (see coil data)								
24 V					24 V			
Coil current type								
DC Direct current							DC	
AC Alternating current 50 / 60 Hz with bridge rectifier							AC	
Extensions								
- None (no code letter)								-
B Quick-action fastening for rail EN50022-35 x 7.5								B
H Manual override (combination B and H not possible)								H
S Screw mounting								S



Contact Data

		105	
Contact arrangement	4 N/O 3 N/O and 1 N/C 2 N/O and 2 N/C		
Contact arrangement	Single contact	Control contact	
Type of contact	Bridge contact	Bridge contact as twin contact	
Contact material	Hard silver AgCdO	Hard silver	
Nominal contact current	16 A	10 A	
Inrush current	≤ 60 A	≤ 20 A	
Nominal contact voltage	400 VAC / DC		
Max. switching capacity (resistive)	6000 VA	3000 VA	
Min. switching capacity	200 mA / 60 VDC	50 mA / 20 VDC	
Switching capacity	AC1 AC3 DC1 AC4	6 kW / 400 V 2.2 kW / 400 V	3 kW / 400 V 0.75 kW / 400 V 100 W (for security circuit in accordance with professional association) not suitable

Dimensions, Connection Diagram(s)

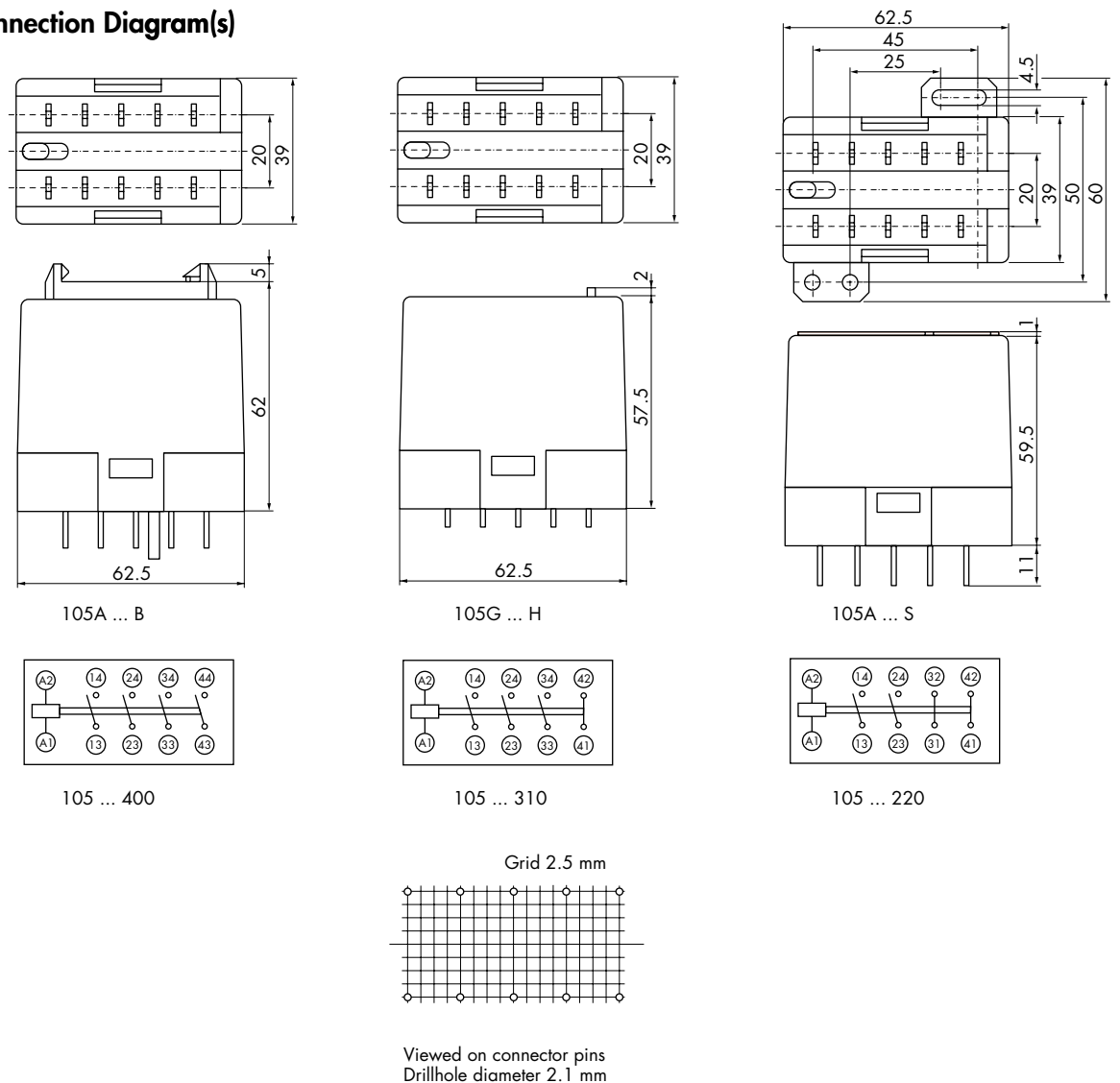



General Data

		105	
Pull-in-time	approx. 25 ms		
Drop-out time	approx. 8 ms DC, approx. 35 ms AC		
Bounce time	approx. 5 ms		
Mechanical service life	> 10 x 10 ⁶ switching cycles		
Test voltage			
Coil - contact	2500 VAC		
Contact - contact	2500 VAC		
Insulation group VDE 0110b/2.79	C380		
Short-circuit protection VDE 0660 part 200	1000 A		
Ambient temperature	-25 °C to +60 °C		
Vibration resistance (30 - 100 Hz)	> 4 g		
Weight	approx. 260 g		
Operating range	DC Class 2 (0.85 - 1.1 U _N)	AC, 50 / 60 Hz Class 2 (0.85 - 1.1 U _N)	
Pull-in after coil excitation with U _N at T _U	35 °C		
Drop-out	> 0.05 U _N	> 0.15 U _N	

Coil Data

Coil voltage DC*	105 Pull-in power approx. 1.3 W Nom. operation coil power approx. 3.6 W		Coil voltage AC*	105 Pull-in power approx. 1.5 VA Nom. operation coil power approx 4.2 VA.	
	Nom. resistance (Ω)	Nominal current (mA)		Nominal voltage (V)	Nom. resistance (Ω)
12	41	290	12	32	340
24	151	160	24	120	180
40	473	85	42	390	97
60	968	62	60	780	69
110	3370	33	110	2710	37
220	13700	16	230	13400	15

* Other voltages on request



Electrical Service Life

Electrical Service Life AC 1

90 % operating
 ——— 400 V
 - - - - 230 V

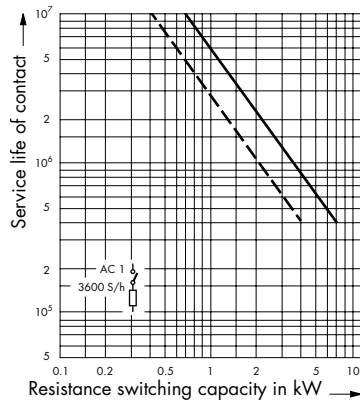

Single contacts

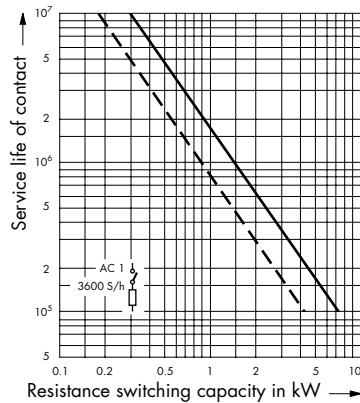

Control contacts

Electrical Service Life AC 3

90 % operating
 ——— 400 V
 - - - - 230 V

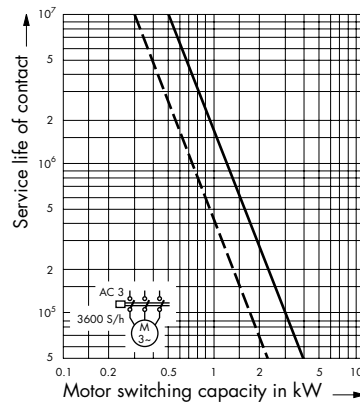

Single contacts

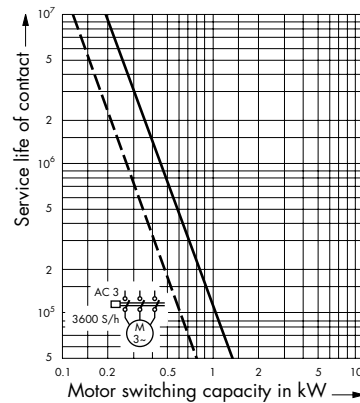

Control contacts

Switching Capability DC 1

90 % operating

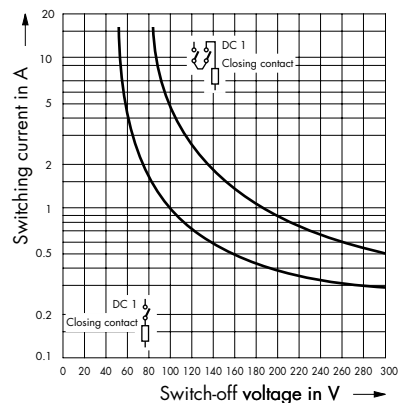

Single contact closing contact

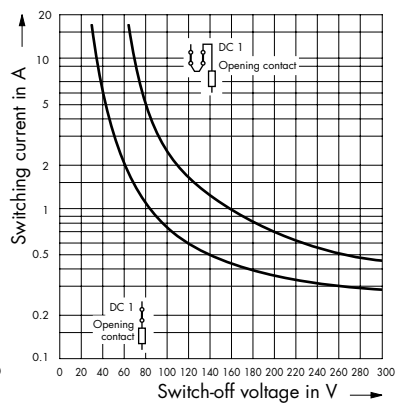

Single contact opening contact



Order Specifications for Accessories

Relay	105
Socket for screw connection with quick-action fastening	Z320.02

Socket Z320.02

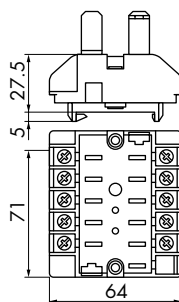
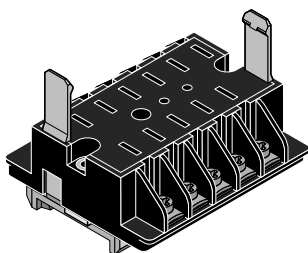

Socket	Z320.02
Terminal capacity solid conductor flexible conductor with ferrule	2 x 2.5 mm ² 2 x 1.5 mm ²
Terminal designation	in accordance with EN50005
Mounting	Rail EN50022-35 x 7.5/15
Screw terminals	Head screws metric M4
Torque in accordance with DIN EN 60999	1.2 Nm
Nominal current	16 A
Insulation group VDE 0110b/2.79	C380
Weight	110 g
Retaining clip	enclosed retaining clips



Power Relay P

- Specify S design in your order
- 1 bridge contact for 50 A
- With blow-out magnet for switching high DC loads
- Auxiliary contact as control contact possible

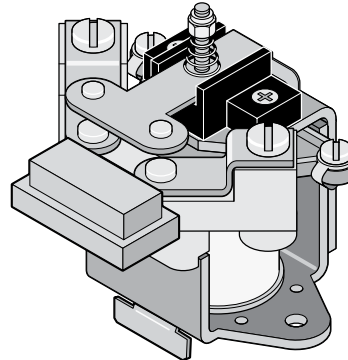

Order Code

Order code	P	A	S	-	24 V	DC	
Type of relay							
Power relay	P						
Contact arrangement							
A 1 N/O		A					
R 1 N/C		R					
Contact material single contact (main contact)							
S Hard silver			S				
C AgCdO (model A only)			C				
W Tungsten			W				
Contact material auxiliary contact							
- Without auxiliary contact (no code letter)				-			
S Hard silver				S			
Nominal operation coil voltage (see coil data)							
24 V					24 V		
Coil current type							
DC Direct current						DC	
AC Alternating current 50 Hz (60 Hz on request)						AC	
Extensions							
- None (no code letter)							-
B Quick-action fastening for rail EN50022-35 x 7.5							B
M Blow-out magnet only with N/O contact							M

Contact Data

	P			
Contact arrangement	Single contact (main contact)			Auxiliary contact
Type of contact	Bridge contact			Single contact
Contact material	Hard silver	AgCdO	Tungsten	Hard silver
Nominal contact current	50 A	50 A	10 A	6 A
Inrush current	≤ 100 A	≤ 200 A	≤ 300 A	≤ 6 A
Nominal contact voltage	400 VAC / DC			250 VAC
Max. switching capacity (resistive)	4000 VA			100 VA
Min. switching capacity	500 mA / 60 VDC		-	50 mA / 20 VDC



Dimensions, Connection Diagram(s)

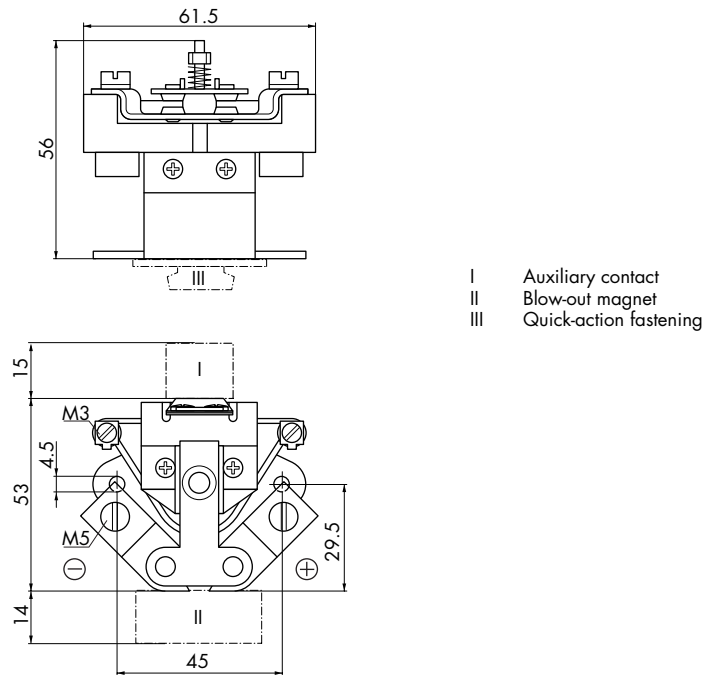

General Data

	P	
Pull-in time	approx. 30 ms	
Drop-out time	approx. 20 ms	
Bounce time	approx. 8 ms	
Mechanical service life	> 5 x 10 ⁶ switching cycles DC > 2 x 10 ⁶ switching cycles AC	
Test voltage		
Coil - contact	2500 VAC	
Contact - frame	2500 VAC	
Auxiliary contact - frame	2000 VAC	
Insulation group VDE 0110b/2.79	C380 single contact (main contact) C125, B250 coil and auxiliary contact	
Ambient temperature	-25 °C to +60 °C DC -25 °C to +40 °C AC	
Vibration resistance (30 - 100 Hz)	> 5 g N/O contact > 2 g N/C contact	
Weight	approx. 220 g	
Operating range	DC Class 1 (0.8 - 1.1 U _N)	AC, 50 Hz Class 1 (0.8 - 1.1 U _N)
Pull-in after coil excitation with U _N at T _U	20 °C	20 °C
Drop-out	> 0.05 U _N	> 0.15 U _N

Coil Data

Coil voltage* DC	P		Coil voltage AC 50 Hz	P	
	Pull-in power approx. 1.3 W Nominal operation coil power approx. 3.0 W			Inrush current approx. 1.4 x nominal current Nominal operation coil power 9.5 VA	
Nominal voltage (V)	Nom. resistance (Ω)	Nominal current (mA)	Nominal voltage (V)	Nom. resistance (Ω)	Nominal current (mA)
12	55	220	12	2.94	680
24	193	120	24	11.2	370
40	528	76	42	35.1	220
60	1250	48	60	64.7	160
110	3670	30	110	245	87
220	15000	15	230	1170	41

*Other voltages on request



Electrical Service Life

Electrical Service Life AC

- 90 % operation
- resistive load
- - - - inductive load
- cos φ = 0.4 ... 0.7

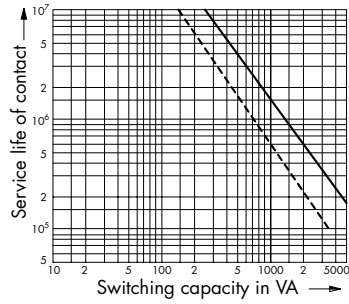

Switching Capability DC

without blow-out magnet

Below limiting characteristic: service life of contacts
 1×10^6 switching cycles (90 % operation)
 resistive load

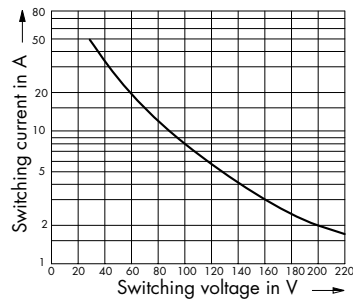

Electrical Service Life DC

with blow-out magnet, resistive load

Switching current (A)	Voltage (V)	Service life switching cycles approx.
2	220	5×10^6
5		5×10^6
10		0.5×10^6

Electrical Service Life AC

Auxiliary contact

Switching capacity (VA)	Service life switching cycles approx.
100	5×10^6



Process Relay Analogue to Digital Converter PZ 610 / PZ 620

- Standard housing, 22.5 mm wide
- Alternatively with relay or transistor output
- CE symbol



Order Code

Order code	PZ	610	-	1	-	230 / 24 VAC
Process relay						
PZ	PZ					
Function						
610 Analogue to digital converter with relay output		610				
620 Analogue to digital converter with transistor output as C/O		620				
Output						
1 C/O				1		
Supply voltage						
24 VDC						24 VDC
230 / 24 VAC						230 / 24 VAC

General Data

	PZ 610 / PZ 620
Display	green LED supply voltage available yellow LED, relay switched on
Insulation class to VDE 0110b/2.79	C250
Test voltage Input - supply - output	3750 VAC
Terminals	Twin tension relief terminals with head screws metric M3
Terminal torque in accordance with DIN EN 60999	0.5 Nm
Terminal capacity solid conductor flexible conductor with ferrule	2 x 2.5 mm ² 2 x 1.5 mm ²
Operating temperature	-20 °C to +55 °C
Storage temperature	-40 °C to +80 °C
Protection in accordance with DIN 40050	IP 20
Mounting	Rail in accordance with EN50022-35 x 7.5/15
Weight	approx. 180 g



Dimensions, Connection Diagram(s), Functional Diagram

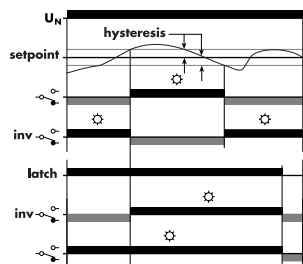
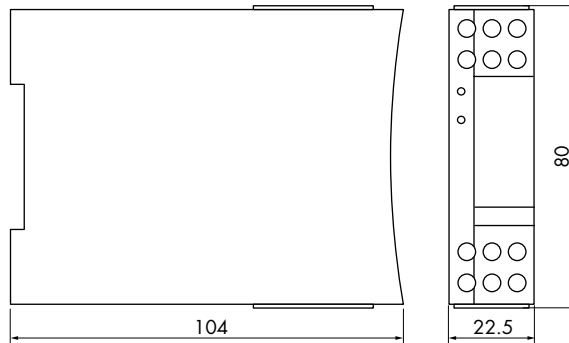

Bridge	Function
F - R	Relay inversion
F - X	Memory function

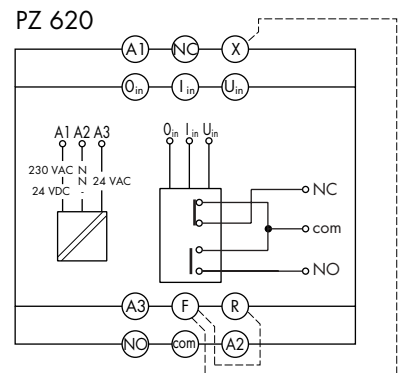
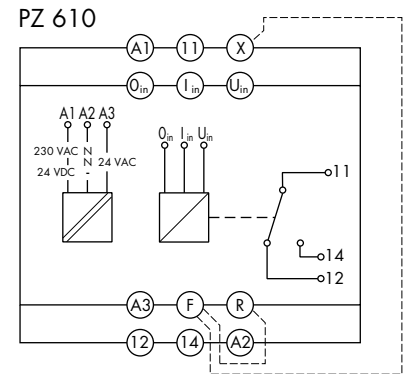

Contact Data Output

	PZ 610	PZ 620
Contact arrangement	1 C/O, relay	1 C/O, transistor
Type of contact	Single contact	-
Contact material	AgNi	-
Nominal contact current	8 A	100 mA
Nominal contact voltage	250 V	±35 VDC / 24 VAC
Max. switching capacity	2000 VA	

Supply Circuit

	PZ 610	PZ 620
Supply voltage	24 VDC (0.85 - 1.15 x U_N) 230 / 24 VAC (0.85 - 1.1 x U_N)	
Line frequency	45 - 65 Hz	
Nominal coil power	AC; 3 VA DC; 2 W	

Signal Input

	PZ 610	PZ 620
Analogue input, select at front panel, adjust via potentiometer	0 - 5 VDC, 0 - 10 VDC, -10 to +10 VDC 0 to 20 mA, 4 to 20 mA	
Impedance	Voltage: 100 kΩ Current: 50 Ω	
Upper frequency limit	30 Hz	
Hysteresis adjustable via front panel	±0.5 to ±20 %	



Process Relay Analogue to Analogue Converter PZ 630

- Standard housing, 22.5 mm wide
- Analogue inputs galvanically separated
- CE symbol



Order Code

Order code	PZ	630	-	2	-	230 VAC
Process relay						
PZ	PZ					
Function						
630 Analogue to analogue converter		630				
Output						
2 Analogue output				2		
Supply voltage						
24 VDC						24 VDC
230 VAC						230 VAC

General Data

	PZ 630
Display	Green LED supply voltage available Yellow LED, input < 5 % of limiting value
Insulation class to VDE 0110b/2.79	C250
Test voltage	3750 VAC
Terminals	Twin tension relief terminals with head screws metric M3
Terminal torque in accordance with DIN EN 60999	0.5 Nm
Terminal capacity solid conductor flexible conductor with ferrule	2 x 2.5 mm ² 2 x 1.5 mm ²
Operating temperature	-20 °C to +55 °C
Storage temperature	-40 °C to +80 °C
Protection in accordance with DIN 40050	IP 20
Mounting	Rail in accordance with EN50022-35 x 7.5/15
Weight	approx. 170 g



Dimensions, Connection Diagram(s)

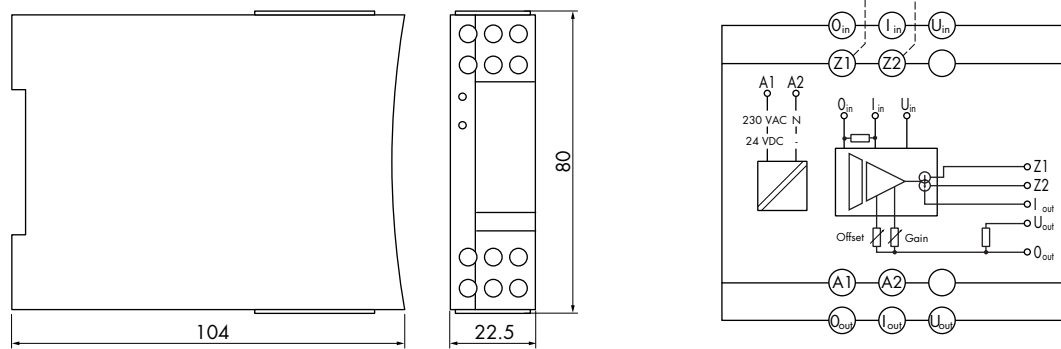

Output Circuit

	Output	Bridge	PZ 630
Output selectable via terminals	$0_{out} - I_{out}$ $0_{out} - I_{out}$ $0_{out} - U_{out}$	- Z1 - Z2 Z1 - Z2 U_{out} and I_{out} bridged	4 - 20 mADC (max. 500 Ω) 0 - 20 mADC (max. 500 Ω) 0 - 10 VDC (int. shunt 500 Ω)
Accuracy of setting			< 1 %
Linearity			< 0.05 % in relation to maximum scale value
Temperature coefficient			0.02 %/°C

Supply Circuit

		PZ 630
Supply voltage	A1(+) - A2(-) A1(L) - A2(N)	24 VDC (0.85 - 1.15 x U_N) 230 VAC (0.85 - 1.1 x U_N)
Line frequency		45 - 65 Hz
Nominal coil power		AC; 3 VA DC; 2 W

Signal Input

		PZ 630
Analogue input, select at front panel	$0_{in} - U_{in}$ $0_{in} - I_{in}$	0 - 5 VDC, 0 - 10 VDC, -10 to +10 VDC 0 to 20 mA, 4 to 20 mA
Impedance		Voltage: 100 k Ω Current: 50 Ω
Upper frequency limit		30 Hz
Offset (zero / span) and amplification adjustable via front panel		± 0.5 %



Process Relay PT-100 with Analogue Output PZ 640

- Standard housing, 22.5 mm wide
- LED indicator for sensor error
- For sensors from -50 °C to 300 °C
- CE symbol



Order Code

Order code	PZ	640	-	2	-	230 VAC
Process relay						
PZ	PZ					
Function						
640 PT-100 Analogue converter		640				
Output						
2 Analogue output				2		
Supply voltage						
24 VDC						24 VDC
230 VAC						230 VAC

General Data

	PZ 640
Display	Green LED supply voltage available Yellow LED, input < 5 % of limiting value
Insulation class to VDE 0110b/2.79	C250
Test voltage	3750 VAC
Terminals	Twin tension relief terminals with head screws metric M3
Terminal torque in accordance with DIN EN 60999	0.5 Nm
Terminal capacity solid conductor flexible conductor with ferrule	2 x 2.5 mm ² 2 x 1.5 mm ²
Operating temperature	-20 °C to +55 °C
Storage temperature	-40 °C to +80 °C
Protection in accordance with DIN 40050	IP 20
Mounting	Rail in accordance with EN50022-35 x 7.5/15
Weight	approx. 170 g



Dimensions, Connection Diagram(s)

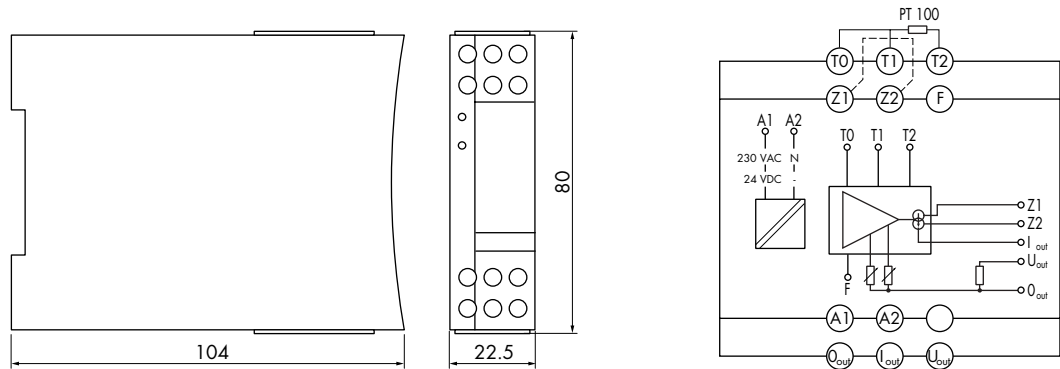

Output Circuit

	Output	Bridge	PZ 640
Output selectable via terminals	$O_{out} - I_{out}$ $O_{out} - U_{out}$ $O_{out} - U_{out}$	- Z1 - Z2 Z1 - Z2	4 - 20 mADC (max. 500 Ω) 0 - 20 mADC (max. 500 Ω) 0 - 10 VDC (max. 5 mA) internal 500 Ω shunt
Accuracy of setting			< 1 %
Linearity			< 0.05 % in relation to maximum scale value
Temperature coefficient			0.02 %/°C

Supply Circuit

		PZ 640
Supply voltage	A1(+) - A2(-) A1(L) - A2(N)	24 VDC (0.85 - 1.15 \times U_N) 230 VAC (0.85 - 1.1 \times U_N)
Line frequency		45 - 65 Hz
Nominal coil power		AC; 3 VA DC; 2 W

Signal Input

		PZ 640
Analogue input, select at front panel. For 2 or 3-wire PT-100 resistors	- F - T2	-50 °C to 300 °C -50 °C to 100 °C



Process Relay Analogue Frequency Converter PZ 650

- Standard housing, 22.5 mm wide
- Connects to PLCs with digital counter inputs
- CE symbol



Order Code

Order code	PZ	650	-	21	-	230
Process relay						
PZ	PZ					
Function						
650 Analogue frequency converter		650				
Output						
21 Analogue output 0 - 50 Hz / 0 - 5 KHz / 0 - 10 KHz				21		
22 Analogue output 0 - 40 Hz / 0 - 4 KHz / 0 - 8 KHz				22		
Supply voltage						
24 VDC						24 VDC
230 VAC						230 VAC

General Data

	PZ 650
Display	Green LED supply voltage available Yellow LED, Input < 5 % of limiting value
Insulation class to VDE 0110b/2.79	C250
Test voltage	3750 VAC
Terminals	Twin tension relief terminals with head screws metric M3
Terminal torque in accordance with DIN EN 60999	0.5 Nm
Terminal capacity solid conductor flexible conductor with ferrule	2 x 2.5 mm ² 2 x 1.5 mm ²
Operating temperature	-20 °C to +55 °C
Storage temperature	-40 °C to +80 °C
Protection in accordance with DIN 40050	IP 20
Mounting	Rail in accordance with EN50022-35 x 7.5/15
Weight	approx. 170 g



Dimensions, Connection Diagram(s)

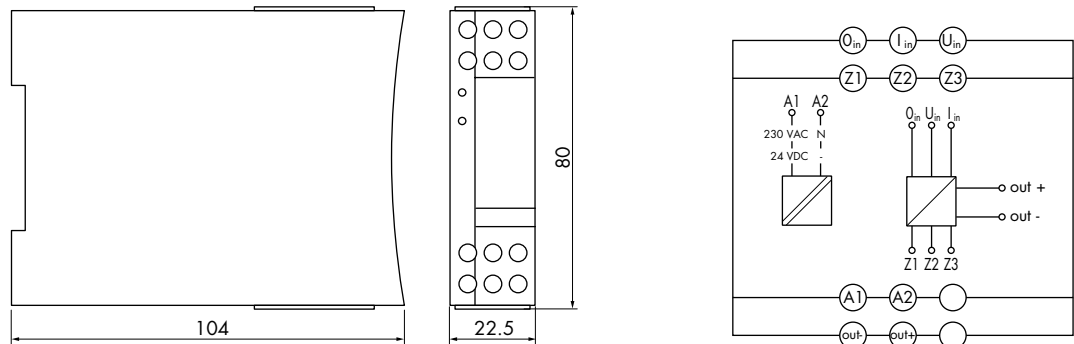

Output Circuit

	Output	Bridge	PZ 650
Output frequency 50 % impulse-to-interval ratio	out + - out -	Z1 - Z2 Z1 - Z3	0 - 8 / 0 - 10 KHz; U_{max} -3.5 V; I_{max} -100 mA 0 - 4 / 0 - 5 KHz; U_{max} -3.5 V; I_{max} -100 mA 0 - 40 / 0 - 50 Hz; U_{max} -3.5 V; I_{max} -100 mA
Switch-on time			50 % (40 - 60 %)
Accuracy of setting			< 1 %
Linearity			< 0.05 % in relation to maximum scale value
Temperature coefficient			0.02 %/°C

The output is capable of controlling both PNP and NPN inputs.
The +/- polarity is to be observed.

Supply Circuit

		PZ 650
Supply voltage	A1(+) - A2(-) A1(L) - A2(N)	24 VDC (0.85 - 1.15 x U_N) 230 VAC (0.85 - 1.1 x U_N)
Line frequency		45 - 65 Hz
Nominal coil power		AC; 3 VA DC; 2 W

Signal Input

		PZ 650
Analogue input, select at front panel Offset (zero / span) and amplification adjustable via front panel	$O_{in} - U_{in}$ $O_{in} - I_{in}$	0 - 5 VDC, 0 - 10 VDC, -10 to +10 VDC 0 to 20 mA, 4 to 20 mA
Impedance		Voltage: 1 M Ω Current: 50 Ω



Process Relay Frequency Analogue Converter PZ 660

- Standard housing, 22.5 mm wide
- CE symbol



Order Code

Order code	PZ	660	-	2	-	230 VAC
Process relay						
PZ	PZ					
Function						
660 Frequency analogue converter		660				
Output						
2 Analogue output				2		
Supply voltage						
24 VDC						24 VDC
230 VAC						230 VAC

General Data

	PZ 660
Display	Green LED supply voltage available Yellow LED, input < 5 % of limiting value
Insulation class to VDE 0110b/2.79	C250
Test voltage	3750 VAC
Terminals	Twin tension relief terminals with head screws metric M3
Terminal torque in accordance with DIN EN 60999	0.5 Nm
Terminal capacity solid conductor flexible conductor with ferrule	2 x 2.5 mm ² 2 x 1.5 mm ²
Operating temperature	-20 °C to +55 °C
Storage temperature	-40 °C to +80 °C
Protection in accordance with DIN 40050	IP 20
Mounting	Rail in accordance with EN50022-35 x 7.5/15
Weight	approx. 170 g



Dimensions, Connection Diagram(s)

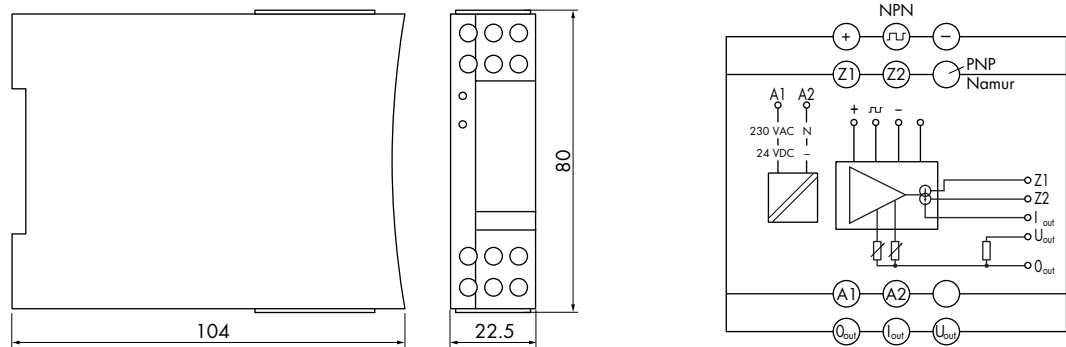

Output Circuit

	Output	Bridge	PZ 660
Output signal selectable via terminals	I_{out} - I_{out} O_{out} - I_{out} O_{out} - U_{out}	- Z1 - Z2 Z1 - Z2	4 - 20 mADC 0 - 20 mADC 0 - 10 VDC (via internal 500 Ω shunt)
Accuracy of setting			< 1 %
Linearity			< 0.05 % in relation to maximum scale value
Temperature coefficient			0.02 %/°C
Offset voltage and amplification selectable via front panel			± 5 %

Supply Circuit

		PZ 660
Supply voltage	A1(+) - A2(-) A1(L) - A2(N)	24 VDC (0.85 - 1.15 x U_N) 230 VAC (0.85 - 1.1 x U_N)
Line frequency		45 - 65 Hz
Nominal coil power		AC; 3 VA DC; 2 W

Signal Input

	PZ 660
Frequency input selectable via front panel	0 - 100 Hz, 0 - 500 Hz, 0 - 1 KHz, 0 - 2 KHz, 0 - 5 KHz

NPN, PNP and Namur signals with a maximum current consumption of 10 mA can be connected.



Single-phase Voltage Monitoring Relay U 510 / U 511

- Standard housing, 22.5 mm wide
- Selectable memory function
- Analogue output for switching point adjustment
- Test voltage 3750 VAC

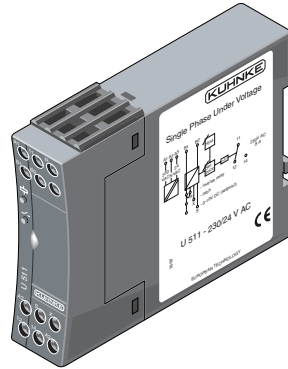

Order Code

Order code	U	510.	1	-	230 / 24 VAC
Single-phase voltage					
U	U				
Monitored variable					
510 Undervoltage		510.			
511 Overvoltage		511.			
Contact arrangement					
1 C/O			1		
Supply voltage					
24 VDC					24 VDC
115/24 VAC					115 / 24 VAC
230/24 VAC					230 / 24 VAC

General Data

	U 510 / U 511
Display	Green LED "Supply On" Red LED error, relay dropped-out
Insulation group VDE 0110b/2.79	C250
Test voltage	3750 VAC
Terminals	Twin tension relief terminals with head screws metric M3
Terminal torque in accordance with DIN EN 60999	0.5 Nm
Terminal capacity	
solid conductor	2 x 2.5 mm ²
flexible conductor with ferrule	2 x 1.5 mm ²
Operating temperature	-20 °C to +55 °C
Storage temperature	-40 °C to +80 °C
Protection in accordance with DIN 40050	IP 20
Mounting	Rail in accordance with EN50022-35 x 7.5/15
Weight	approx. 180 g



Dimensions, Connection Diagram(s), Functional Diagrams

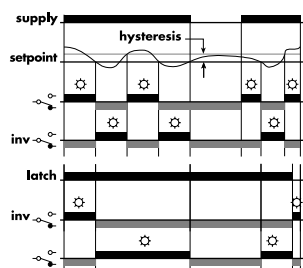
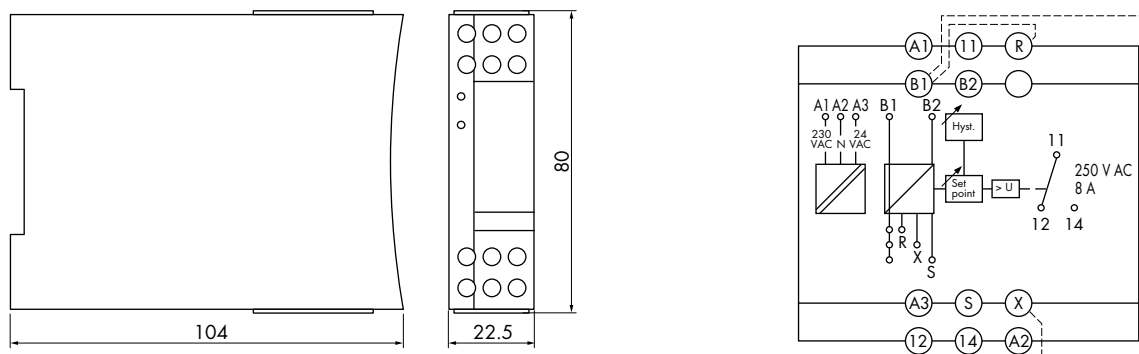

U 510

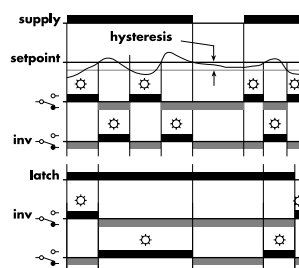

U 511

Bridge	Function
B1 - R	Relay inversion
B1 - X	Latch
B1 - S	Setting analogous to 2 - 10 V

Contact Data

	U 510 / U 511
Contact arrangement	1 C/O
Type of contact	Single contact
Contact material	AgNi, gold-plated
Nominal contact current	8 A
Nominal contact voltage	250 VAC / 24 VDC
Max. switching capacity	2000 VA / 100 W

Auxiliary Circuit

Supply voltage	A1 (+) - A2 (-) A3 - A2 (N) A1 - A2 (N) A1 - A2 (N)	24 VDC 24 VAC (45 - 65 Hz) 115 VAC (45 - 65 Hz) 230 VAC (45 - 65 Hz)
Overload rating		1.15 x U _N continuous
Rated power		DC 2 W AC 3 VA

Monitoring Circuit

	U 510	U 511
Monitored voltage (B1 - B2) to B2 at DC+	1 - 500 VAC / DC in 5 ranges, selectable via "Range" 1 - 5 V / 4 - 20 V / 10 - 50 V / 40 - 200 V / 100 - 500 V	
Input impedance	500 kΩ	
U max	700 VAC	
Drop-out	adjustable in chosen range - dropping voltage	adjustable in chosen range - rising voltage
Pull-in	0.5 - 20 % of chosen range limit, adjustable above drop-out value	0.5 - 20 % of chosen range limit, adjustable below drop-out value
Temperature dependence	≤ 0.05 %/K	
Setting of switching point B1: + on S	2 - 10 V analogous to switching point (drop-out value)	
Latch of bridge B1 - x	If the relay drops out after error, reenergizing is only possible after opening the bridge or interrupting the supply voltage.	



Three-phase Voltage Monitoring Relay UD 517 / UD 532

- Standard housing, 22.5 mm wide
- Selectable memory function
- Test voltage 3750 VAC

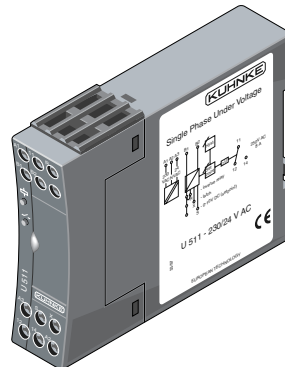

Order Code

Order code	UD	517.	1	-	230 / 400	45 - 65 Hz
Three-phase voltage						
UD	UD					
Monitored variable						
517 Three-phase- undervoltage - overvoltage		517.				
532 Three-phase- undervoltage - asymmetric angle - sequence		532.				
Contact arrangement						
1 C/O			1			
Supply voltage (Voltage: Phase - N / Phase - Phase Supply voltage.measuring voltage)						
230 / 400 VAC (UD532 only)					230 / 400	
230 VAC					230.400	
400 VAC					400.400	
Frequency						
47 - 53 Hz (UD532 only)						47 - 53 Hz
45 - 65 Hz (UD517 only)						45 - 65 Hz

General Data

	UD 517	UD 532
Display	Upper red LED overvoltage Lower red LED undervoltage	Green LED "Supply On" Red LED error, relay dropped-out
Insulation group VDE 0110b/2.79	C250	
Test voltage	3750 VAC	
Terminals	Twin tension relief terminals with head screws metric M3	
Terminal torque in accordance with DIN EN 60999	0.5 Nm	
Terminal capacity		
solid conductor	2 x 2.5 mm ²	
flexible conductor with ferrule	2 x 1.5 mm ²	
Operating temperature	-20 °C to +55 °C	
Storage temperature	-40 °C to +80 °C	
Protection in accordance with DIN 40050	IP 20	
Mounting	Rail in accordance with EN50022-35 x 7.5/15	
Weight	approx. 180 g	



Dimensions, Connection Diagram(s), Functional Diagrams

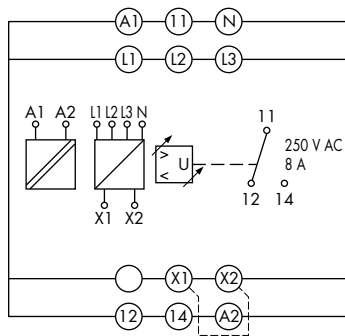
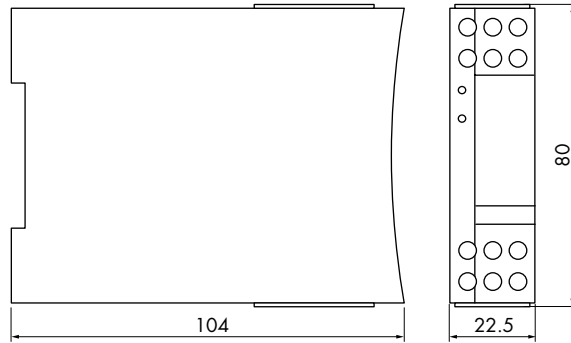

Bridge X1 - X2 = Latch

UD517

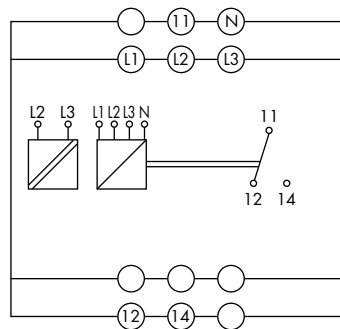

UD532

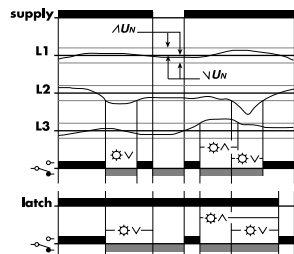

UD517

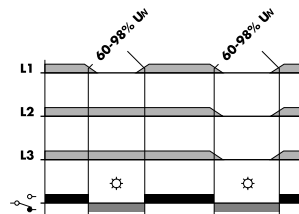

UD532

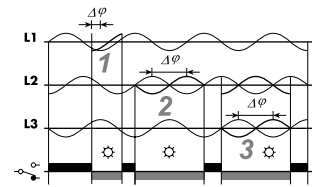

Contact Data

	UD 517 / UD 532
Contact arrangement	1 C/O
Type of contact	Single contact
Contact material	AgNi gold-plated
Nominal contact current	8 A
Nominal contact voltage	250 VAC
Max. switching capacity	2000 VA



Auxiliary Circuit

UD 517	UD 532
to A1 / A2 230 or 400 V 45 to 65 Hz or by bridge to monitoring input	internally connected to monitored voltage L2 / L3

Monitoring Circuit

	UD 517	UD 532
Nominal line voltages	230 / 400 V (N required)	
Nominal line frequency	45 - 65 Hz	47 - 53 Hz
Overload rating	1.2x U_N continuous	
Rated power	3 VA $\cos \varphi \approx 0.7$	
Drop-out	U_{ab} of 1.01 - 1.20 x U_N and 0.80 - 0.99 x U_N adjustable	Nominal voltage selectable between 340 and 460 V. A_s permanently set to 20° Undervoltage adjustable between 0.6 to 0.98 x U_N
Adjustment error	≤ 3 %	
Pull-in	Hysteresis fixed setting at 2 % approx.	fixed setting at 1 % approx.
Memory function	One error	none
Temperature dependence	≤ 0.05 %/K	



Single-phase Current Monitoring Relay I 540 / I 541

- Standard housing, 22.5 mm wide
- Selectable memory function
- Analogue output for setting the switching point
- Test voltage 3750 VAC

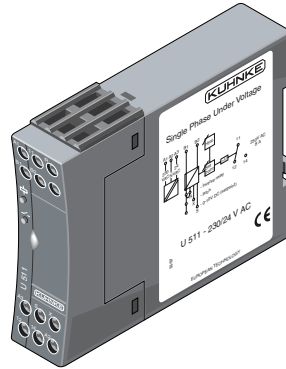

Order Code

Order code	I	540.	1	-	230 / 24 VAC
Single-phase current					
I	I				
Monitored variable					
540 Undercurrent		540.			
541 Overcurrent		541.			
Contact arrangement					
1 C/O			1		
Supply voltage					
24 VDC					24 VDC
115 / 24 VAC					115 / 24 VAC
230 / 24 VAC					230 / 24 VAC

General Data

	I 540 / I 541
Display	Green LED "Supply On" Red LED error, relay dropped-out
Insulation group VDE 0110b/2.79	C250
Test voltage	3750 VAC
Terminals	Twin tension relief terminals with head screws metric M3
Terminal torque in accordance with DIN EN 60999	0.5 Nm
Terminal capacity	
solid conductor	2 x 2.5 mm ²
flexible conductor with ferrule	2 x 1.5 mm ²
Operating temperature	-20 °C to +55 °C
Storage temperature	-40 °C to +80 °C
Protection in accordance with DIN 40050	IP 20
Mounting	Rail in accordance with EN50022-35 x 7.5/15
Weight	approx. 180 g



Dimensions, Connection Diagram(s), Functional Diagrams

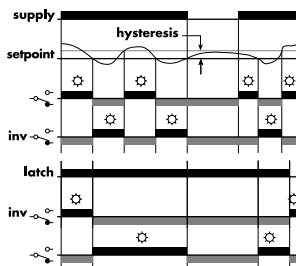
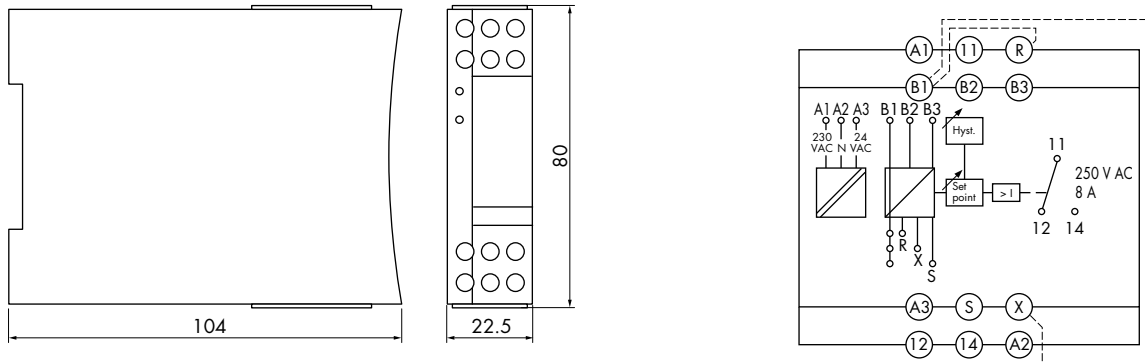

I 540

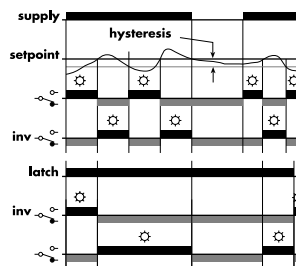

I 541

Bridge	Function
B1 - R	Relay inversion
B1 - X	Latch
B1 - S	Setting analogous to 2 - 10 V

Contact Data

	I 540 / I 541
Contact arrangement	1 C/O
Type of contact	Single contact
Contact material	AgNi, gold-plated
Nominal contact current	8 A
Nominal contact voltage	250 VAC / 24 VDC
Max. switching capacity	2000 VA / 100 W

Auxiliary Circuit

Supply voltage	A1 (+) - A2 (-) A3 - A2 (N) A1 - A2 (N) A1 - A2 (N)	24 VDC 24 VAC (45 - 65 Hz) 115 VAC (45 - 65 Hz) 230 VAC (45 - 65 Hz)
Overload rating		1.15 x U _N continuous
Rated power		DC 2 W AC 3 VA

Monitoring Circuit

	I 540	I 541
Monitored current (B1 - B2 - B3) (B1 - B2) (B1 - B3)		4 mA - 2 A DC/AC in 5 ranges, selectable via "Range" 4 - 20 mA, 10 - 50 mA, 40 - 200 mA 0.1 - 0.5 A, 0.4 - 2 A
Input impedance		50 Ω (B1 - B2), 0.1 Ω (B1 - B3)
I max		0.34 A (B1 - B2), 5 A (B1 - B3)
Drop-out	adjustable in chosen range - dropping current	adjustable in chosen range - rising current
Pull-in	0.5 - 20 % of chosen range limit, adjustable above drop-out value	0.5 - 20 % of chosen range limit, adjustable below drop-out value
Temperature dependence		≤ 0.05 %/K
Setting of switching point B1: 0+ on S		2 - 10 V analogous to switching point (drop-out value)
Latch of bridge B1 - x		If the relay drops out after error, reenergizing is only possible after opening the bridge or interrupting the supply voltage.



Monitoring Relay 1500

Single-phase Voltage Monitoring Relay U 1510

- Standard type GL
- Operating range $-25\text{ }^{\circ}\text{C}$ to $+70\text{ }^{\circ}\text{C}$
- DC and AC undervoltage measuring

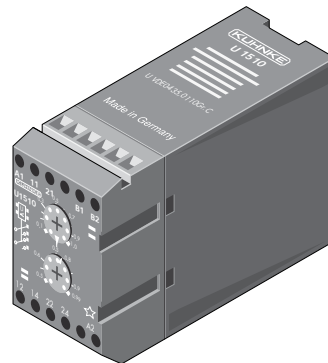

Order Code

Order code	U	1510.	2	-	10 - 100 mV	230 VAC	50 / 60 Hz
Voltage monitoring relay							
U	U						
Monitored variable							
1510 single-phase-undervoltage		1510.					
Contact arrangement							
2 C/O			2				
Monitored voltage range							
10 - 100 mV					10 - 100 mV		
50 - 500 mV					50 - 500 mV		
0.5 - 5 V					0.5 - 5 V		
5 - 50 V					5 - 50 V		
25 - 250 V					25 - 250 V		
50 - 500 V					50 - 500 V		
Supply voltage							
24 VAC						24 VAC	
110 / 115 VAC						110 / 115 VAC	
230 VAC						230 VAC	
240 VAC						240 VAC	
24 VDC* (no frequency stated)						24 VDC	
Frequency (at AC only)							
50 / 60 Hz							50 / 60 Hz

* See page 65 for series resistors for the 24 VDC device (for supply voltages above 24 VDC)

Contact Data

	U 1510
Contact arrangement	2 C/O
Type of contact	Single contact
Contact material	AgCdO
Nominal contact current	5 A
Inrush current	$\leq 5\text{ A}$
Max. switching capacity	1100 VA
Nominal contact voltage	250 VAC



Dimensions, Connection Diagram(s)

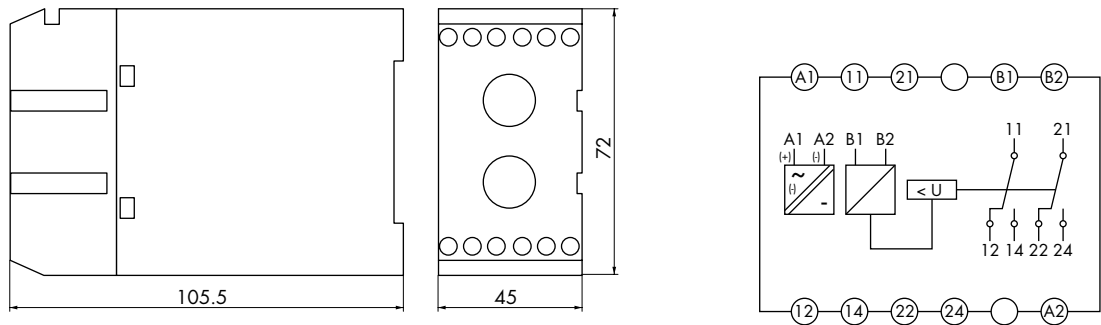

General Data

U 1510	
Display	1 green LED lights if the output relay is pulled up
Insulation group VDE 0110b/2.79	C250
Test voltage Auxiliary circuit - output circuit - monitoring circuit	2500 VAC
Vibration resistance	4 g at 25 - 100 Hz (in accordance with GL)
Terminals	Tension relief terminal with head screws metric M 2.6
Terminal torque	max. 0.6 Nm
Terminal capacity solid conductor	2 x 1.5 mm ²
flexible conductor with ferrule	2 x 1.5 mm ²
Operating temperature	-25 °C to +70 °C
Storage temperature	-25 °C to +85 °C
Protection in accordance with DIN 40050	IP40 Housing IP20 Screws IP10 Clamps
Mounting	Rail in accordance with EN50022-35 x 7.5/15 Screw mounting with mounting plate
Weight	approx. 300 g

Auxiliary Circuit

Nominal line voltages	see order code
Nominal line frequency	50 / 60 Hz if AC devices
Voltage ranges	AC = ± 20 % at 100 % ED +50 % for 10 s 10 % ED DC = 24 VDC +25 %/-10 %
Rated power	2.0 VA cos φ = 0.7



Monitoring Relay 1500

Monitoring Circuit

	U 1510		
Pull-in voltage U_{an} adjustable acc. to the upper scale	Input resistance in $k\Omega$	Continuous overload in V	Overload duration 10 s
10 - 100 mV	2	30	50 V
50 - 500 mV	20	100	140 V
0.5 - 5 V	82.5	200	280 V
5 - 50 V	511	500	700 V
25 - 250 V	1000	750	1000 V
50 - 500 V	1000	750	1000 V
Adjustment error	$\leq 4\%$		
Drop-out voltage U_{ab}	Permanently adjustable between 0.5 and $0.99 \times U_{an}$ acc. to the lower scale.		
Temperature dependence	$\leq 0.01\%/K$		
Variance of switching points under identical conditions	$\leq 0.5\%$		
Monitored value	The arithmetic mean value is measured. The scales are adjusted to sinusoidal AC voltage. If just DC voltages without any harmonic contents are measured, the desired switching point should be multiplied by 0.89 and the result set on the scale.		

Series Resistance for the 24 VDC Device

Supply voltage U_v in VDC	48 VDC	60 VDC	110 VDC	220 VDC
Series resistance R_v in Ω	470	750	1800	3900
Power rating P of R_v in W	1.23	1.7	4.1	9.8
Max. power P of R_v in W	1.92	2.7	6.4	15.4



Three-phase Voltage Monitoring Relay UD1515 / UD1525 / UD1535

- Standard type 
- Operating range -25 °C to +70 °C
- Monitoring of three-phase systems

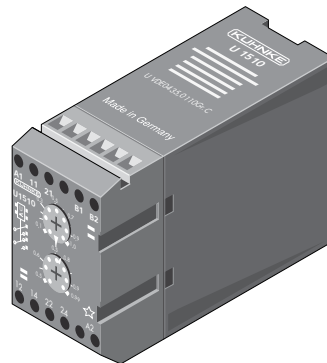

Order Code

Order code	UD	1525.	2	-	230 / 240 V	50 Hz
Three-phase voltage						
UD	UD					
Monitored variable						
1515 Three-phase undervoltage		1515.				
1525 Asymmetric three-phase angle		1525.				
1535 Three-phase sequence		1535.				
Contact arrangement						
2 C/O			2			
Measuring and supply voltage (Voltage: Phase - N / Phase - Phase)						
57 / 100 V					57 / 100 V	
110 / 190 V					110 / 190 V	
127 / 220 V					127 / 220 V	
230 / 400 V					230 / 400 V	
240 / 415 V					240 / 415 V	
290 / 500 V					290 / 500 V	
Frequency						
50 / 60 Hz						50 / 60 Hz
50 Hz (for UD 1525 only)						50 Hz

Contact Data

	UD1515 / UD1525 / UD1535
Contact arrangement	2 C/O
Type of contact	Single contact
Contact material	AgCdO
Nominal contact current	5 A
Inrush current	≤ 5 A
Max. switching capacity	1100 VA
Nominal contact voltage	250 VAC



Dimensions, Connection Diagram(s)

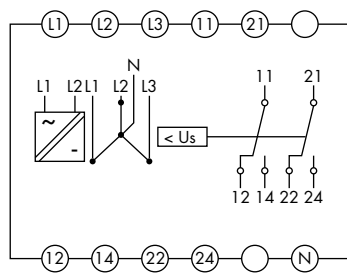
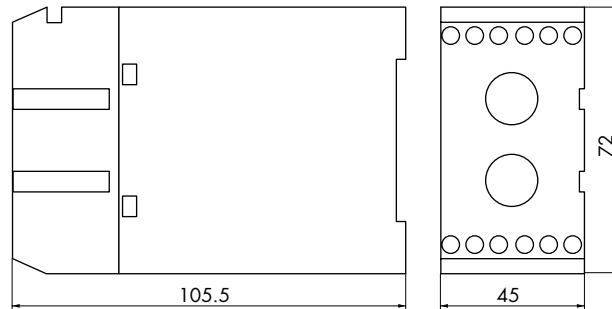

UD1515 / UD1525

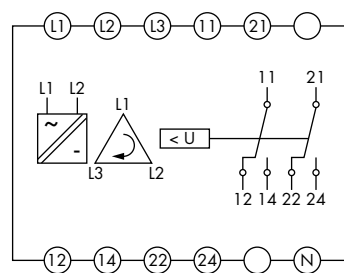

UD1535

General Data

	UD1515 / UD1525 / UD1535
Display	1 green LED lights if the output relay is pulled up
Insulation group VDE 0110b/2.79	C250
Test voltage Monitoring circuit - output circuit	2500 VAC
Vibration resistance	4 g at 25 - 100 Hz (in accordance with GL)
Terminals	Tension relief terminal with head screws metric M 2.6
Terminal torque	max. 0.6 Nm
Terminal capacity solid conductor	2 x 1.5 mm ²
flexible conductor with ferrule	2 x 1.5 mm ²
Operating temperature	-25 °C to +70 °C
Storage temperature	-25 °C to +85 °C
Protection in accordance with DIN 40050	IP40 Housing IP20 Screws IP10 Clamps
Mounting	Rail in accordance with EN50022-35 x 7.5/15 Screw mounting with mounting plate
Weight	approx. 300 g

Auxiliary Circuit

- The supply input is internal connected to the monitoring input (L1 and L2).



Monitoring Circuit

	UD1515	UD1525	UD1535
Nominal line voltages	see order code		
Nominal line frequency	50 / 60 Hz	50 Hz $\pm 0.5\%$	50 / 60 Hz
Overload rating	1.2 x U_N continuous 1.5 x U_N 10 s at 10 % ED		
Rated power	2.4 VA $\cos \varphi = 0.7$		
Monitored value	Voltage reading	Phase angle	Phase sequence
Drop-out voltage	U_{ob} permanently adjustable between 0.7 and 1.0 x U_N acc. to the upper scale	AS permanently adjustable between 3° and 30° asymmetry of angles	
Adjustment error	$\leq 1\%$	$\leq 2.5\%$	
Pull-in voltage	U_{an} permanently adjustable between 1.02 and 1.2 x U_{ob} acc. to the lower scale	fixed setting at 1 % approx.	
Adjustment error	$\leq 2.5\%$		
Variance of switching points at the three phases	$\leq 1\%$		
Temperature dependence	$\leq 0.01\%/K$	$\leq 0.01\%/K$	
Variance of switching points under identical conditions	$\leq 0.5\%$	$\leq 0.5\%$	



Single-phase Current Monitoring Relay I1540

- Standard type GL
- Operating range $-25\text{ }^{\circ}\text{C}$ to $+70\text{ }^{\circ}\text{C}$
- Monitoring of undercurrent for DC and AC voltages

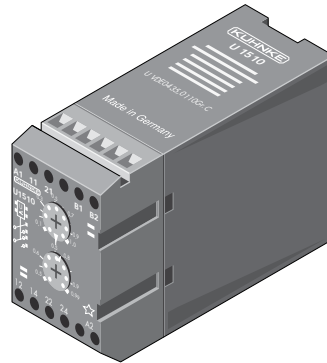

Order Code

Order code	I	1540.	2	-	0.1 - 1 A	24 VAC	50 / 60 Hz
Current monitoring relay							
I	I						
Monitored variable							
1540 Single-phase - undercurrent		1540.					
Contact arrangement							
2 C/O			2				
Monitored current range							
2 - 20 mA					2 - 20 mA		
10 - 100 mA					10 - 100 mA		
50 - 500 mA					50 - 500 mA		
0.1 - 1 A					0.1 - 1 A		
0.5 - 5 A					0.5 - 5 A		
1 - 10 A					1 - 10 A		
Supply voltage							
24 VAC						24 VAC	
110 / 115 VAC						110 / 115 VAC	
230 VAC						230 VAC	
240 VAC						240 VAC	
400 VAC						400 VAC	
24 VDC* (no frequency stated)						24 VDC	
Frequency							
50 / 60 Hz							50 / 60 Hz

* See page 71 for series resistors for the 24 VDC device (for supply voltages above 24 VDC)

Contact Data

	I1540
Contact arrangement	2 C/O
Type of contact	Single contact
Contact material	AgCdO
Nominal contact current	5 A
Inrush current	$\leq 5\text{ A}$
Max. switching capacity	1100 VA
Nominal contact voltage	250 VAC



Dimensions, Connection Diagram(s)

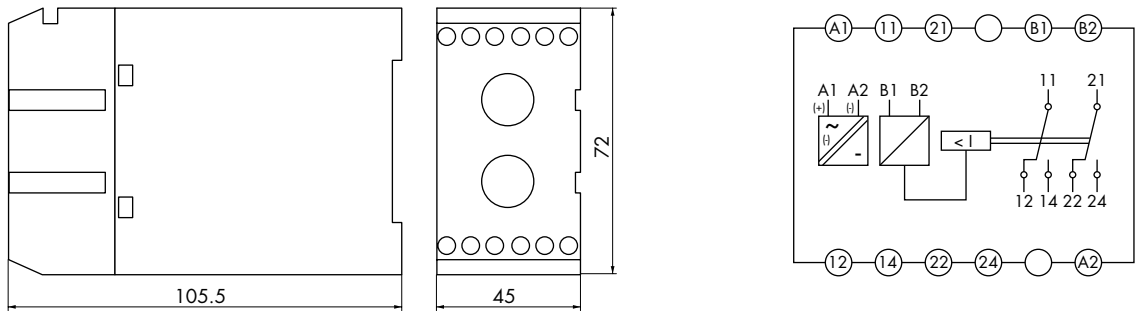

General Data

	I1540
Display	1 green LED lights if the output relay is pulled up
Insulation group VDE 0110b/2.79	C250
Test voltage	2500 VAC
Auxiliary circuit - output circuit - monitoring circuit	
Vibration resistance	4 g at 25 - 100 Hz (in accordance with GL)
Terminals	Tension relief terminal with head screws metric M 2.6
Terminal torque	max. 0.6 Nm
Terminal capacity	
solid conductor	2 x 1.5 mm ²
flexible conductor with ferrule	2 x 1.5 mm ²
Operating temperature	-25 °C to +70 °C
Storage temperature	-25 °C to +85 °C
Protection in accordance with DIN 40050	IP40 Housing IP20 Screws IP10 Clamps
Mounting	Rail in accordance with EN50022-35 x 7.5/15 Screw mounting with mounting plate
Weight	approx. 300 g

Auxiliary Circuit

Nominal line voltages	see order code
Nominal line frequency	50 / 60 Hz if AC devices
Voltage ranges	AC = ± 20 % at 100 % ED +50 % for 10 s 10 %ED DC = 24 VDC +25 %/-10 %
Rated power	2.0 VA cos φ = 0.7



Monitoring Relay 1500

Monitoring Circuit

	I1540		
Pull-in current I_{an} adjustable acc. to the upper scale	Input resistance in Ω	Continuous overload in A	Overload duration 1 s in A
2 - 20 mA	3	0.5	0.63
10 - 100 mA	1	1	1.25
50 - 500 mA	0.25	2	2.5
0.1 - 1 A	0.11	3	3.7
0.5 - 5 A	0.01	10	12.25
1 - 10 A	0.005	15	15
Adjustment error	$\leq 4\%$		
Drop-out current I_{ab}	Permanently adjustable between $0.5 - 0.99 \times I_{an}$ acc. to the lower scale		
Temperature dependence	$\leq 0.01\%/K$		
Variance of switching points under identical conditions	$\leq 0.5\%$		
Monitored value	The arithmetic mean value is measured. The scales are adjusted to sinusoidal AC current. If just DC currents without any harmonic contents are measured, the desired switching point should be multiplied by 0.89 and the result set on the scale.		

Series Resistance for the 24 VDC Device

Supply voltage U_v in VDC	48 VDC	60 VDC	110 VDC	220 VDC
Series resistance R_v in Ω	470	750	1800	3900
Power rating P of R_v in W	1.23	1.7	4.1	9.8
Max. power P of R_v in W	1.92	2.7	6.4	15.4



Frequency Monitoring Relay with Auxiliary Voltage F1570

- Operating range -25 °C to +70 °C
- Monitoring of underfrequency in AC current systems

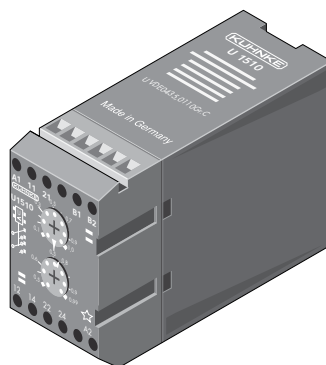

Order Code

Order code	F	1570.	2	-	10 - 30 Hz	24 VAC	50 / 60 Hz
Frequency-monitoring relay							
F	F						
Monitored variable							
1570 underfrequency		1570.					
Contact arrangement							
1 C/O / 1 N/O			2				
Monitored frequency range							
10 - 30 Hz					10 - 30 Hz		
20 - 50 Hz					20 - 50 Hz		
40 - 65 Hz					40 - 65 Hz		
50 - 100 Hz					50 - 100 Hz		
Supply voltage							
24 VAC						24 VAC	
110 / 115 VAC						110 / 115 VAC	
230 VAC						230 VAC	
240 VAC						240 VAC	
400 VAC						400 VAC	
24 VDC* (no frequency stated)						24 VDC	
Frequency							
50 / 60 Hz							50 / 60 Hz

* See page 74 for series resistors for the 24 VDC device (for supply voltages above 24 VDC)

Contact Data

	F1570
Contact arrangement	1 C/O / 1 N/O
Type of contact	Single contact
Contact material	AgCdO
Nominal contact current	5 A
Inrush current	≤ 5 A
Max. switching capacity	1100 VA
Nominal contact voltage	250 VAC



Dimensions, Connection Diagram(s)

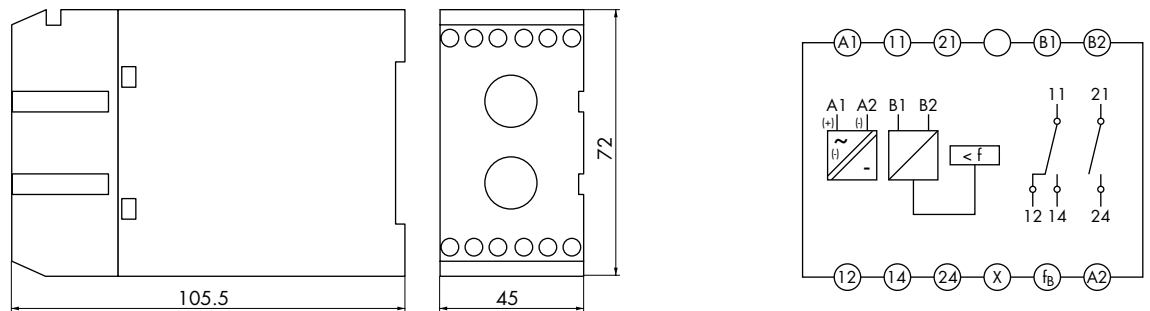

General Data

	F1570
Display	1 green LED lights if the output relay is pulled up
Insulation group VDE 0110b/2.79	C250
Test voltage	2500 VAC
Auxiliary circuit - output circuit - monitoring circuit	
Vibration resistance	4 g at 25 - 100 Hz (in accordance with GI)
Terminals	Tension relief terminal with head screws metric M 2.6
Terminal torque	max. 0.6 Nm
Terminal capacity	
solid conductor	2 x 1.5 mm ²
flexible conductor with ferrule	2 x 1.5 mm ²
Operating temperature	-25 °C to +70 °C
Storage temperature	-25 °C to +85 °C
Protection in accordance with DIN 40050	IP40 Housing IP20 Screws IP10 Clamps
Mounting	Rail EN50022-35 x 7.5/15 Screw mounting with mounting plate
Weight	approx. 300 g

Auxiliary Circuit

Nominal line voltages	see order code
Nominal line frequency	50 / 60 Hz if AC devices
Voltage ranges	AC = ± 20 % at 100 % ED +50 % for 10 s 10 % ED DC = 24 VDC +25 %/-10 %
Rated power	2.0 VA cos φ ≈ 0.7



Monitoring Circuit

	F1570	
Pull-in frequency f_{ab} adjustable acc. to the upper scale	Input resistance in $M\Omega$	Limiting frequency in Hz
10 - 30 Hz	1	120
20 - 50 Hz	1	120
40 - 65 Hz	1	120
50 - 100 Hz	1	120
Adjustment error	$\leq 2.5\%$	
Drop-out frequency f_{an}	Permanently adjustable between 1.01 and $1.1 \times f_{ab}$ acc. to the lower scale	
Temperature dependence	$\leq 0.02\%/K$	
Variance of switching points under identical conditions	$\leq 0.5\%$	
Monitored value ($10 - 500 V_{eff}$)	<ul style="list-style-type: none"> • Operation without bridge x-f: frequencies above the set pull-in value energise the output relay. The output relay is de-energised when the frequency falls below the set drop-out value. • Operation with bridge x-f: the output relay pulls in if the measuring voltage is above 8 V. The output relay remains pulled in if the voltage is applied at a frequency above the set switching point. Other functions same as operation without bridge x-f. 	

Series Resistance for the 24 VDC Device

Supply voltage U_v in VDC	48 VDC	60 VDC	110 VDC	220 VDC
Series resistance R_v in Ω	470	750	1800	3900
Power rating P of R_v in W	1.23	1.7	4.1	9.8
Max. power P of R_v in W	1.92	2.7	6.4	15.4



PCB Relay 171

- Standard type /
- Immunity to flux
- 1 C/O 12/16 A. 2 C/O 8 A
- Insulation group C250

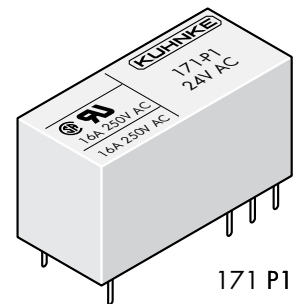
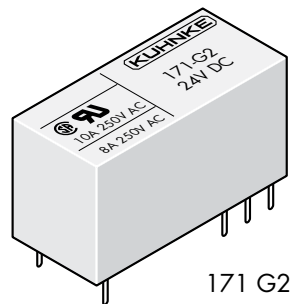
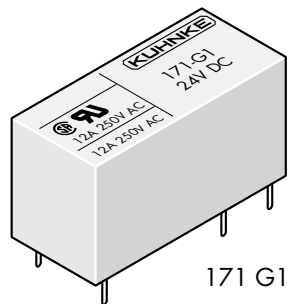

Order Code

Order code	171	G	1	-	24 V	DC
Type of relay	171					
Model						
G For printed circuit		G				
P For printed circuit (16 A)		P				
Contact arrangement						
1 C/O (Model G/P)			1			
2 C/O (Model G)			2			
Nominal operation coil voltage (see coil data)						
24 V					24 V	
Coil current type						
DC Direct current						DC
AC Alternating current						AC

Contact Data

	171G1	171G2	171P1
Contact arrangement	1 C/O	2 C/O	1 C/O
Type of contact	Single contact	Single contact	Single contact
Contact material	AgNi	AgNi	AgNi
Nominal contact current	12 A	8 A	16 A
Inrush current	≤ 15 A	≤ 10 A	≤ 20 A
Nominal contact voltage	150 VDC / 250 VAC	150 VDC / 250 VAC	150 VDC / 400 VAC
Max. switching capacity (resistive)	192 W / 2000 VA	100 W / 1000 VA	240 W / 3000 VA
Min. switching capacity	10 mA / 5 VDC	10 mA / 5 VDC	10 mA / 5 VDC



Dimensions, Connection Diagram(s)

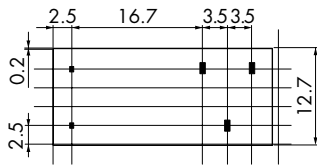

Viewed on relay from below

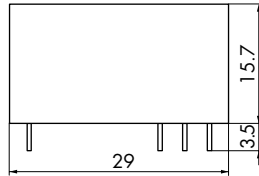

Hole diameter 1.3 mm

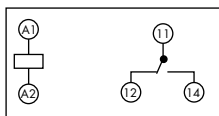

Top view

171 G1

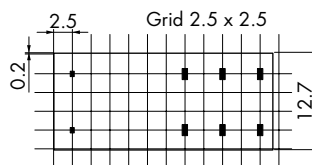

Viewed on relay from below

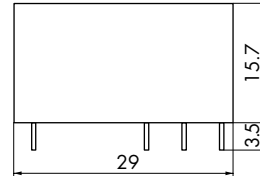

Hole diameter 1.3 mm

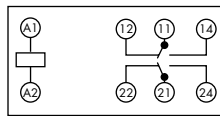

Top view

171 G2

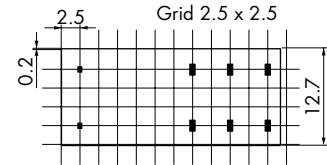

Viewed on relay from below

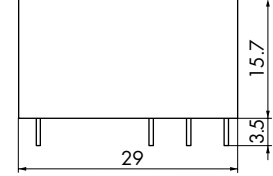

Hole diameter 1.3 mm

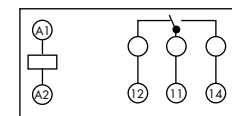

Top view

171 P1

General Data

	171G1	171G2	171P1
Pull-in-time	approx. 10 ms	approx. 10 ms	approx. 10 ms
Drop-out time	approx. 8 ms	approx. 8 ms	approx. 8 ms
Bounce time	approx. 2 ms	approx. 2 ms	approx. 2 ms
Mechanical service life	> 20 x 10 ⁶ switching cycles > 5 x 10 ⁶ switching cycles AC	> 20 x 10 ⁶ switching cycles > 5 x 10 ⁶ switching cycles AC	> 20 x 10 ⁶ switching cycles > 5 x 10 ⁶ switching cycles AC
Test voltage			
Coil - contact (striking distance ≥ 8 mm)	5000 VAC	5000 VAC	5000 VAC
(C/O) - (C/O)		2500 VAC	
Contact - contact	1000 VAC	1000 VAC	1000 VAC
Insulation group VDE 0110b/2.79	C250	C250	C250, B380
Ambient temperature	-40 °C to +75 °C		
Vibration resistance (30 - 100 Hz)	> 4 g		
Weight	approx. 14 g		
Operating range	Class 1 (0.8 - 1.1 U _N)		
Pull-in after coil excitation with U _N at T _U	20 °C		
Drop-out	> 0.05 U _N DC > 0.15 U _N AC		

Coil Data

Coil voltage DC	171G1/G2/P1 Pull-in power approx. 0.2 W Nom. operation coil power approx. 0.4 W			171G1/G2/P1 Nom. operation coil power approx. 50 Hz 0.7 VA Nom. operation coil power approx. 60 Hz 0.6 VA			
	Nominal voltage (V)	Nominal resistance (Ω)	Nominal current (mA)	Nominal voltage (V)	Nominal resist. (Ω)	Nominal current 50 Hz (mA)	Nominal current 60 Hz (mA)
12	360	33	24	350	32	24	
24	1440	17	115	8100	6.6	5.1	
			230	32500	3.3	2.5	



Electrical Service Life

Electrical Service Life AC

90 % operating

— resistive load
 - - - inductive load
 $\cos \varphi = 0.4 \dots 0.7$

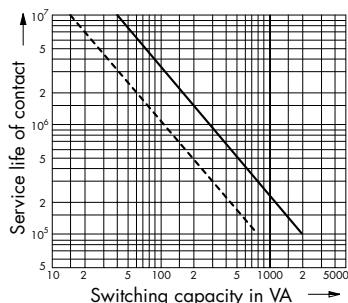

171 G1

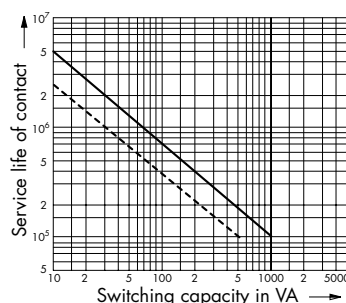

171 G2

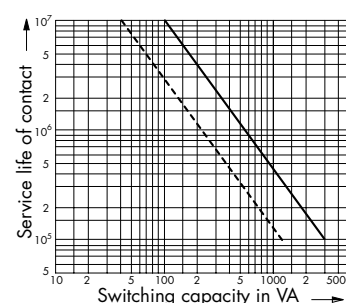

171 P1

Switching Capacity DC

Below limiting characteristic: service life of contacts
 1×10^6 switching cycles (90 % operating)
 resistive load

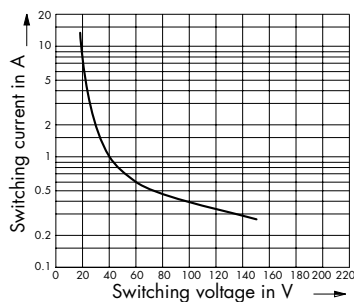

Order Details for Accessories 171

Relay		171 G1	171 G2/P1
Socket for	Screw connection with quick-action fastening	Z318.02 Safe separation	Z319.02
	printed circuit	Z316.01	Z317.01
Modules for socket	Z318.02, Z319.02	Z318.51 Protection/luminous diode 24 VDC	
		Z318.52 Luminous diode 24 VAC/DC	
		Z318.53 Protection diode DC	
		Z318.54 24 VAC with varistor	
		Z318.55 230 VAC with varistor	
	Z318.58 110/230 VAC LED		
Retaining clip	for 171	Z438 for socket Z318.02	Z438 for socket Z319.02



PCB Relay 107

- Standard type /
- Immunity to flux
- 1 C/O 10/16 A, 2 C/O 7 A
- Insulation group C250

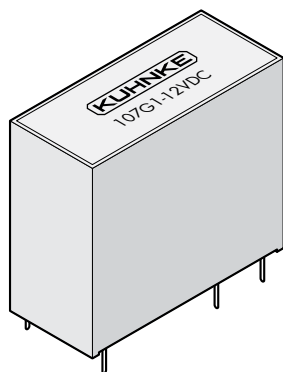

107 G1

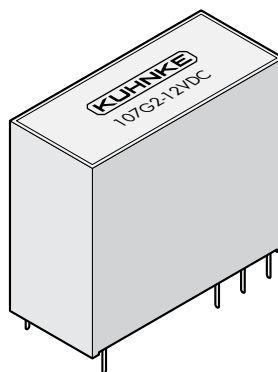

107 G2

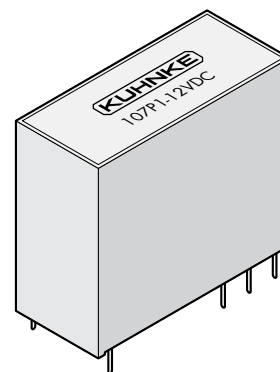

107 P1

Order Code

Order code	107	G	1	-	24 V	DC	E
Type of relay	107						
Model							
G For printed circuit		G					
P For printed circuit (16 A)		P					
Contact arrangement							
1 C/O (Model G/P)			1				
2 C/O (Model G)			2				
Nominal operation coil voltage (see coil data)							
24 V					24 V		
Coil current type							
DC Direct current						DC	
E High resistance coil							E
Extension							
W Washable (on request)							W

Contact Data

	107G1	107G2	107P1
Contact arrangement	1 C/O	2 C/O	1 C/O
Type of contact	Single contact	Single contact	Single contact
Contact material	AgCdO	AgCdO	AgCdO
Nominal contact current	10 A	7 A	16 A
Inrush current	≤ 10 A	≤ 5 A	≤ 16 A
Nominal contact voltage	150 VDC / 250 VAC	150 VDC / 250 VAC	150 VDC / 400 VAC
Max. switching capacity (resistive)	240 W / 2400 VA	120 W / 1200 VA	480 W / 4000 VA
Min. switching capacity	100 mA / 5 VDC	100 mA / 5 VDC	100 mA / 5 VDC



Dimensions, Connection Diagram(s)

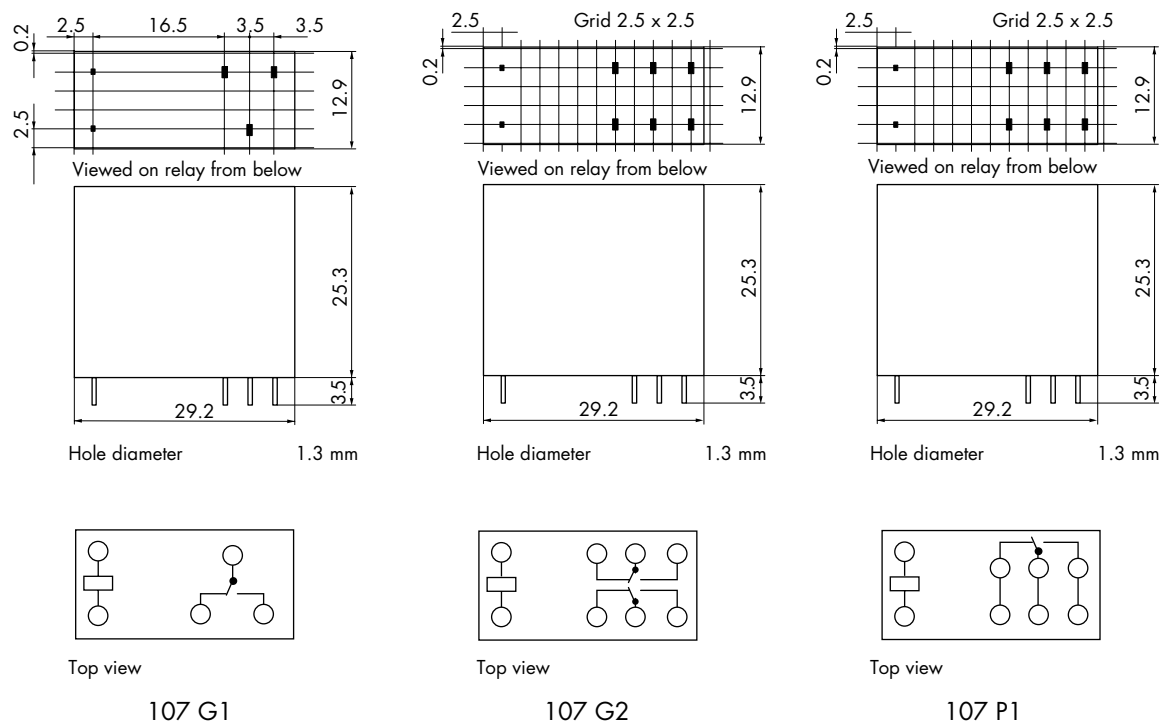

General Data

	107 G1	107 G2	107 P1
Pull-in-time	approx. 10 ms	approx. 10 ms	approx. 20 ms
Drop-out time	approx. 5 ms	approx. 5 ms	approx. 10 ms
Bounce time	approx. 6 ms	approx. 8 ms	approx. 6 ms
Mechanical service life	> 20 x 10 ⁶ switching cycles		
Test voltage			
Coil - contact (striking distance ≥ 8 mm)	4000 VAC	4000 VAC	4000 VAC
(C/O) - (C/O)		2500 VAC	
Contact - contact	1000 VAC	1000 VAC	1000 VAC
Insulation group VDE 0110b/2.79	C250		
Ambient temperature	-5 °C to +70 °C		
Vibration resistance (30 - 100 Hz)	> 4 g		
Weight	approx. 18 g		
Operating range	Class 1 (0.8 - 1.1 U _N)		
Pull-in			
after coil excitation with U _N at T _U	20 °C		
Drop-out	> 0.05 U _N		

Coil Data

Coil voltage	High resistance 107 ... E	
	Nominal operation coil power approx. 0.52 W	
Nominal voltage (V)	Nominal resistance (Ω)	Nominal current (mA)
6	68	88
12	270	44
24	1100	22
48	4400	11



Electrical Service Life

Electrical Service Life AC

90 % operating

- resistive load
- - - inductive load
- $\cos \varphi = 0.4 \dots 0.7$

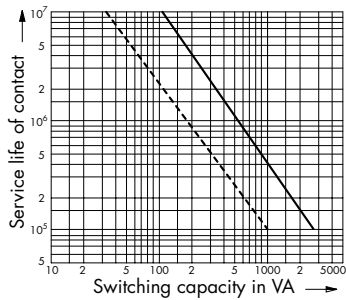

107 G1

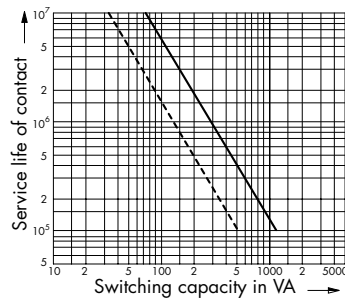

107 G2

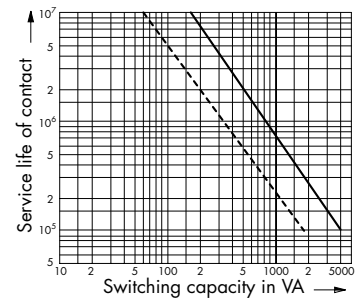

107 P1

Switching Capability DC

Below limiting characteristic: service life of contacts
 1×10^6 switching cycles (90 % operating)
 resistive load

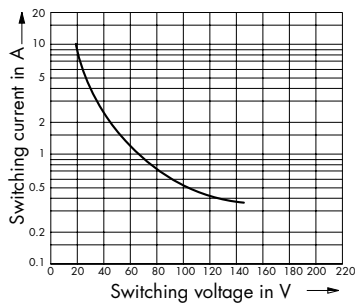

107 G1

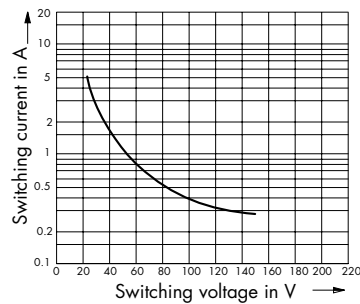

107 G2

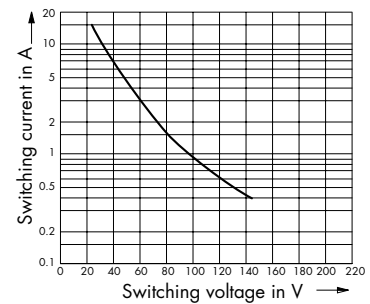

107 P1

Order Details for Accessories 107

Relay		107 G1	107 G2/P1
Socket for	Screw connection with quick-action fastening	Z318.02 Safe separation	Z319.02
	printed circuit	Z316.01	Z317.01
Modules for socket	Z318.02, Z319.02	Z318.51 Protection/luminous diode 24 VDC	Modules as for 107 G1
		Z318.52 Luminous diode 24 VAC/DC	
		Z318.53 Protection diode DC	
		Z318.54 24 VAC with varistor	
		Z318.55 230 VAC with varistor	
		Z318.58 110/230 VAC LED	
Retaining clip		Z421 for socket Z316.01	Z421 for socket Z317.01
Retaining clip	for 107	Z439 for socket Z318.02	Z439 for socket Z319.02

Socket Z316.01

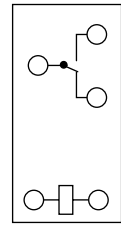
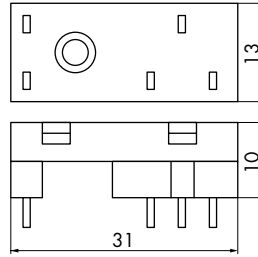
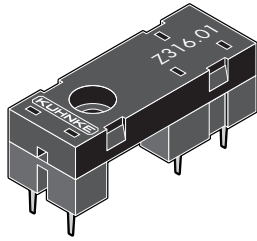

Socket	Z316.01
Socket design	Safe separation
Terminal capacity	Soldered pins
Mounting	PCB mount
Nominal current	12 A
Insulation group VDE 0110b/2.79	C250
Weight	approx. 3.5 g
Retaining spring	Z420 (171 only)

Socket Z317.01

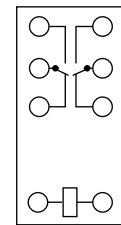
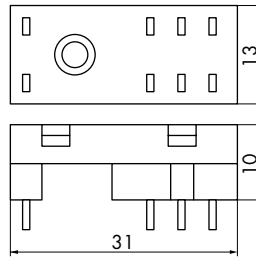
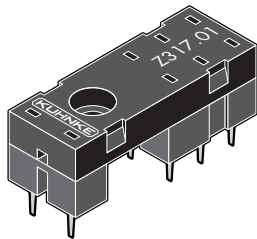

Socket	Z317.01
Socket design	Safe separation
Terminal capacity	Soldered pins
Mounting	PCB mount
Nominal current	12 A
Insulation group VDE 0110b/2.79	C250
Weight	approx. 3.5 g
Retaining spring	Z420 (171 only), Z421 (107 G2/P1 only)

Socket Z318.02

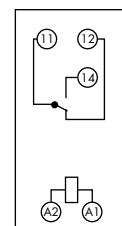
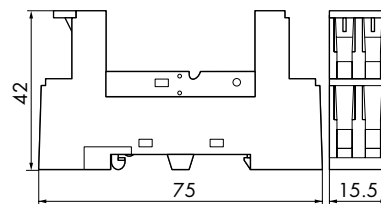
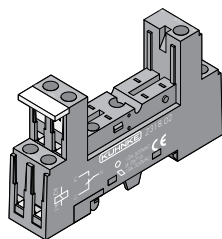

Socket	Z318.02
Socket design	Safe separation, logical, additional modules supported
Terminal capacity	
solid conductor	2 x 2.5 mm ²
flexible conductor with ferrule	2 x 1.5 mm ²
Terminal designation	in accordance with EN50005
Mounting	Rail EN50022-35 x 7.5/15 Screw mounting M3
Screw terminals	Head screws metric M3
Torque in accordance with DIN EN 60999	0.5 Nm
Nominal current	12 A
Insulation group VDE 0110b/2.79	C250, B380
Electrical shock protection	in accordance with VBG4 (professional association), VDE 0106 part 100
Weight	22 g
Eject/retain clip	Z438 for 171 G1

Socket Z319.02

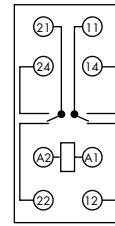
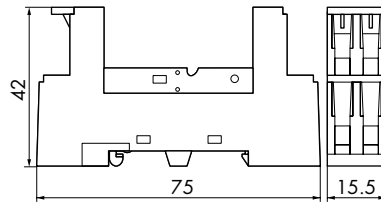
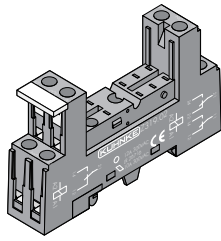

Socket	Z319.02
Socket design	logical, additional modules supported
Terminal capacity	
solid conductor	2 x 2.5 mm ²
flexible conductor with ferrule	2 x 1.5 mm ²
Terminal designation	in accordance with EN50005
Mounting	Rail EN50022-35 x 7.5/15 Screw mounting M3
Screw terminals	Head screws metric M3
Torque in accordance with DIN EN 60999	0.5 Nm
Nominal current	12 A
Insulation group VDE 0110b/2.79	C250, B380
Electrical shock protection	in accordance with VBG4 (professional association), VDE 0106 part 100
Weight	22 g
Eject/retain clip	Z438 for 171, Z439 for 107 G/P1

Socket Z315.02

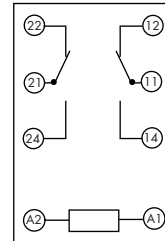
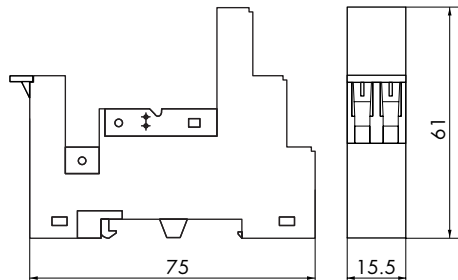
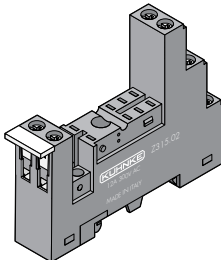

Socket	Z315.02
Socket design	Safe separation, logical, additional modules supported
Terminal capacity	
solid conductor	2 x 2.5 mm ²
flexible conductor with ferrule	2 x 1.5 mm ²
Terminal designation	in accordance with EN50005
Mounting	Rail EN50022-35 x 7.5/15 Screw mounting M3
Screw terminals	Head screws metric M3
Torque in accordance with DIN EN 60999	0.5 Nm
Nominal current	12 A
Insulation group VDE 0110b/2.79	C250, B380
Electrical shock protection	in accordance with VBG4 (professional association), VDE 0106 part 100
Weight	43 g
Eject/retain clip	Z438 for 171, Z439 for 107 G/P1

Modules for Socket Z318.02, Z319.02, and Z315.02

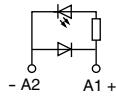
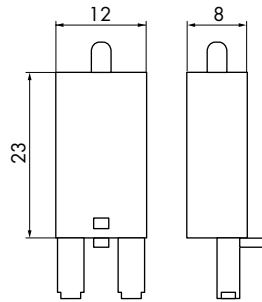
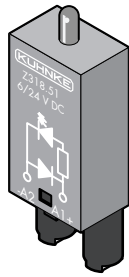

Z318.51

Protection / luminous diode for 6 - 24 VDC

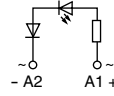

Z318.52

LED for 6 - 24 VAC / DC

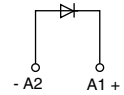

Z318.53

Protection diode

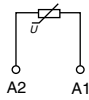

Z318.54

Varistor for 24 VAC

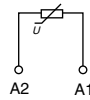

Z318.55

Varistor for 230 VAC

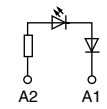

Z318.58

LED for 110 / 230 VAC

Eject/retain Clip Z438 (for Z318.02, Z319.02, and Z315.02 with relay 171)

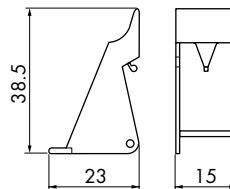
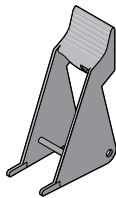

Eject/retain Clip Z439 (for Z318.02, Z319.02, and Z315.02 with relay 107 G2 and 107 P1)

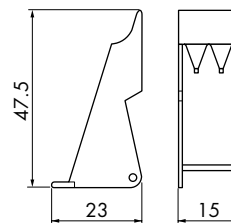
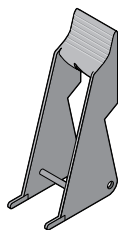



PCB Relay 173

- Standard type /
- Immunity to flux
- 1 C/O 5 A
- Insulation group C250

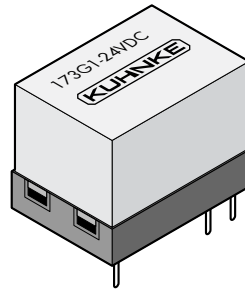

Order Code

Order code	173	G	1	-	24 V	DC
Type of relay	173					
Model						
G For printed circuit		G				
Contact arrangement						
1 C/O			1			
Nominal operation coil voltage (see coil data)						
24 V					24 V	
Coil current type						
DC Direct current						DC

Contact Data

	173G1
Contact arrangement	1 C/O
Type of contact	Single contact
Contact material	AgNi, gold-plated
Nominal contact current	5 A
Inrush current	≤ 5 A
Nominal contact voltage	150 VDC / 250 VAC
Max. switching capacity (resistive)	120 W / 960 VA
Min. switching capacity	10 mA / 5 VDC

Dimensions, Connection Diagram(s)

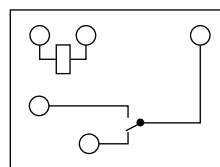
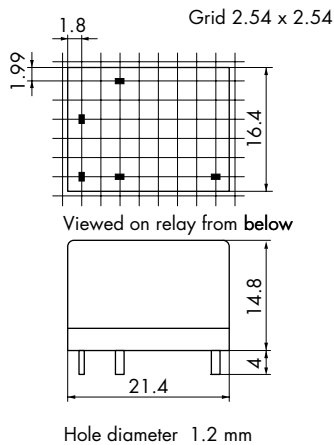

Top view



General Data

173G1	
Pull-in-time	approx. 7 ms
Drop-out time	approx. 4 ms
Bounce time	approx. 2 ms
Mechanical service life	> 20 x 10 ⁶ switching cycles
Test voltage	
Coil - contact	2000 VAC
Contact - contact	750 VAC
Insulation group VDE 0110b/2.79	C250
Ambient temperature	-30 °C to +70 °C
Vibration resistance (30 - 100 Hz)	> 10 g
Weight	approx. 8 g
Operating range	Class 1 (0.8 – 1.1 U _N)
Pull-in after coil excitation with U _N at T _U	20 °C
Drop-out	> 0.05 U _N

Coil Data

Coil voltage DC	Nominal operation coil power approx. 0.45 W Pull-in power approx. 0.22 W	
	Nominal voltage (V)	Nominal resistance (Ω)
5	56	89
12	320	38
24	1280	19

Electrical Service Life

Electrical Service Life AC

90 % operation
 — resistive load
 - - - inductive load
 cos φ = 0.4 ... 0.7

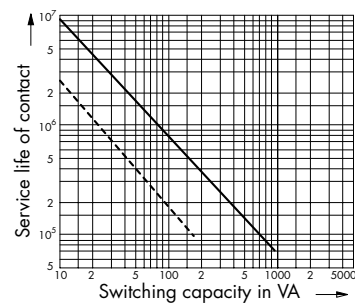

Switching Capability DC

Below limiting characteristics: service life of contacts
 1 x 10⁶ switching cycles (90 % operation)
 resistive load

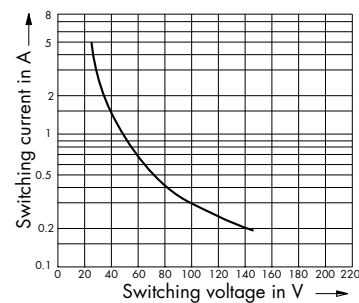



PCB Relay 174

- Standard type /
- Washable
- 1 C/O 10 A/ 400 VAC
- Insulation group C250, B380
- Overall height 12.5 mm

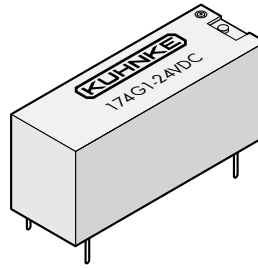

Order Code

Order code	174	G	1	-	24 V	DC
Type of relay	174					
Model						
G For printed circuit		G				
Contact arrangement						
1 C/O			1			
Nominal operation coil voltage (see coil data)						
24 V					24 V	
Coil current type						
DC Direct current						DC

Contact Data

	174G1
Contact arrangement	1 C/O
Type of contact	Single contact
Contact material	AgCdO
Nominal contact current	8 A
Inrush current	≤ 15 A
Nominal contact voltage	150 VDC / 400 VAC
Max. switching capacity (resistive)	192 W / 2000 VA
Min. switching capacity	10 mA / 5 VDC

Dimensions, Connection Diagram(s)

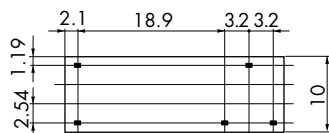

Viewed on relay from below

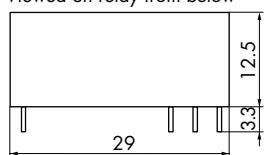

Hole diameter contacts 1.5 mm
Hole diameter coil 1.3 mm

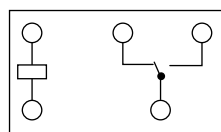

Top view



General Data

174G1	
Pull-in-time	approx. 10 ms
Drop-out time	approx. 5 ms
Bounce time	approx. 2 ms
Mechanical service life	> 20 x 10 ⁶ switching cycles
Test voltage	
Coil - contact	5000 VAC
Contact - contact	1000 VAC
Insulation group VDE 0110b/2.79	C250, B380
Ambient temperature	-40 °C to +70 °C
Vibration resistance (30 - 100 Hz)	> 4 g
Weight	approx. 8 g
Operating range	Class 1 (0.8 - 1.1 U _N)
Pull-in after coil excitation with U _N at T _U	20 °C
Drop-out	> 0.05 U _N

Coil Data

Coil voltage DC	Nominal operation coil power approx. 0.25 W Pull-in power approx. 0.12 W	
	Nominal voltage (V)	Nominal resistance (Ω)
6	164	37
12	620	19
24	2350	10
48	9600	5

Electrical Service Life

Electrical Service Life AC

90 % operation

- resistive load
- - - - inductive load
- cos φ = 0.4 ... 0.7

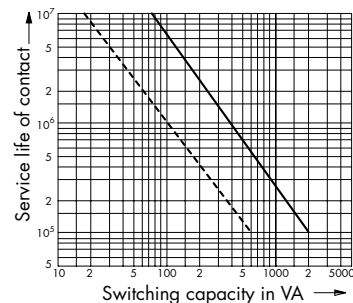

Switching Capability DC

Below limiting characteristics: service life of contacts
1 x 10⁶ switching cycles (90 % operation)
resistive load

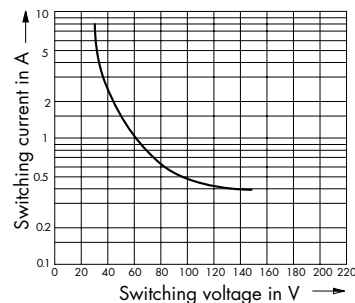



PCB Relay 175

- Standard type /
- Washable
- 1 N/O 5 A
- Insulation group C250

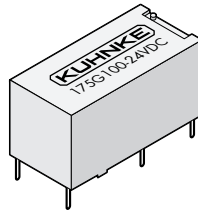

Order Code

Order code	175	G	100	-	24 V	DC
Type of relay	175					
Model						
G For printed circuit		G				
Contact arrangement						
100 1 N/O			100			
Nominal operation coil voltage (see coil data)						
24 V					24 V	
Coil current type						
DC Direct current						DC

Contact Data

	175G100
Contact arrangement	1 N/O
Type of contact	Single contact
Contact material	AgCdO
Nominal contact current	5 A
Inrush current	≤ 5 A
Nominal contact voltage	30 VDC / 250 VAC
Max. switching capacity (resistive)	150 W / 1250 VA
Min. switching capacity	100 mA / 5 VDC

Dimensions, Connection Diagram(s)

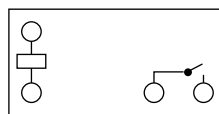
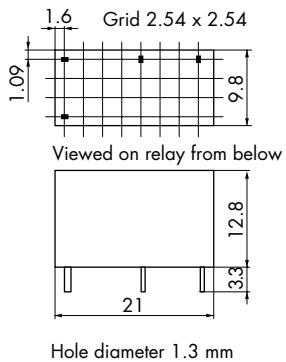

Top view



General Data

	175G100
Pull-in-time	approx. 6 ms
Drop-out time	approx. 3 ms
Bounce time	approx. 1 ms
Mechanical service life	$> 20 \times 10^6$ switching cycles
Test voltage	
Coil - contact	4000 VAC
Insulation group VDE 0110b/2.79	C250
Ambient temperature	-40 °C to +85 °C
Vibration resistance (30 - 100 Hz)	> 10 g
Weight	approx. 5 g
Operating range	Class 1 (0.8 – 1.1 U_N)
Pull-in	
after coil excitation	
with U_N at T_U	20 °C
Drop-out	$> 0.05 U_N$

Coil Data

Coil voltage DC	Nominal operation coil power approx. 0.20 W Pull-in power approx. 0.10 W	
	Nominal voltage (V)	Nominal resistance (Ω)
5	125	40
12	720	17
24	2880	8

Electrical Service Life

Electrical Service Life AC

90 % operation

— resistive load

- - - - inductive load

$\cos \phi = 0.4 \dots 0.7$

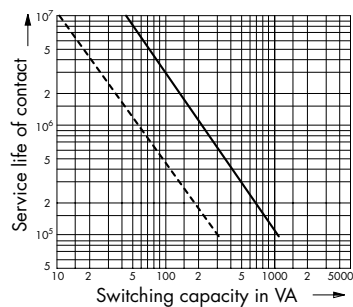

Switching Capability DC

Below limiting characteristics: service life of contacts

1×10^6 switching cycles (90 % operation)

resistive load

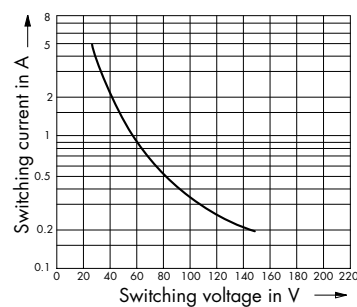



PCB Relay 176

- Standard type /
- Washable
- 1 C/O 5 A
- Insulation group C250

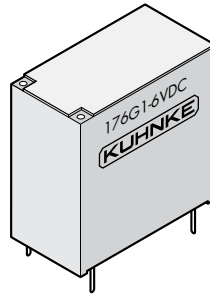

Order Code

Order code	176	G	1	-	24 V	DC
Type of relay	176					
Model						
G For printed circuit		G				
Contact arrangement						
1 C/O			1			
Nominal operation coil voltage (see coil data)						
24 V					24 V	
Coil current type						
DC Direct current						DC

Contact Data

	176G1
Contact arrangement	1 C/O
Type of contact	Single contact
Contact material	AgCdO
Nominal contact current	5 A
Inrush current	≤ 5 A
Nominal contact voltage	150 VDC / 250 VAC
Max. switching capacity (resistive)	120 W / 1250 VA
Min. switching capacity	100 mA / 5 VDC

Dimensions, Connection Diagram(s)

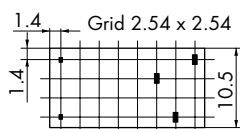

Viewed on relay from below

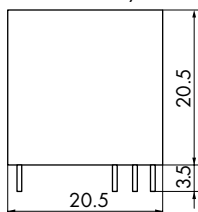

Hole diameter contacts 1.2 mm
Hole diameter coil 1.0 mm

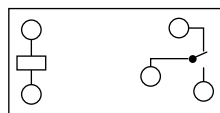

Top view



General Data

	176G1
Pull-in-time	approx. 10 ms
Drop-out time	approx. 5 ms
Bounce time	approx. 8 ms
Mechanical service life	$> 10 \times 10^6$ switching cycles
Test voltage	
Coil - contact	2000 VAC
Contact - contact	750 VAC
Insulation group VDE 0110b/2.79	C250
Ambient temperature	-40 °C to +85°C
Vibration resistance (30 - 100 Hz)	> 10 g
Weight	approx. 8 g
Operating range	Class 1 (0.8 – 1.1 U_N)
Pull-in after coil excitation with U_N at T_U	20 °C
Drop-out	$> 0.05 U_N$

Coil Data

Coil voltage DC	Nominal operation coil power approx. 0.36 W Pull-in power approx. 0.18 W	
	Nominal voltage (V)	Nominal resistance (Ω)
6	100	60
12	400	30
24	1600	15

Electrical Service Life

Electrical Service Life AC

90 % operation
 ——— resistive load
 - - - - inductive load
 $\cos \varphi = 0.4 \dots 0.7$

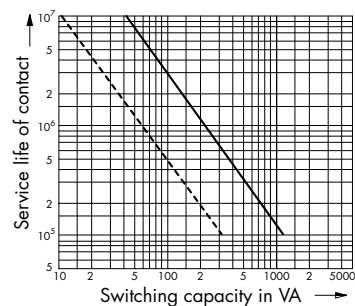

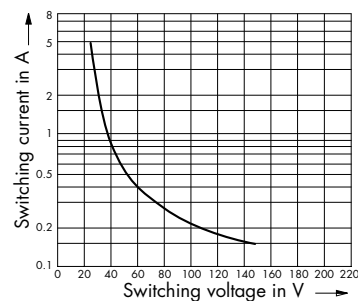

Switching Capability DC

Below limiting characteristics: service life of contacts
 1×10^6 switching cycles (90 % operation)
 resistive load





Dual In-Line Relays 178

- Standard type  / 
- Washable
- Small overall height
- For switching small signals

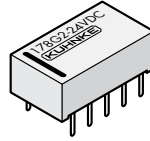

Order Code

Order code	178	G	2	-	24 V	DC
Type of relay	178					
Model						
G For printed circuit		G				
Contact arrangement						
2 C/O			2			
Nominal operation coil voltage (see coil data)						
24 V					24 V	
Coil current type						
DC Direct current						DC

Contact Data

	178G2
Contact arrangement	2 C/O
Type of contact	Twin contact
Contact material	Hard silver, gold-plated
Nominal contact current	2 A
Inrush current	≤ 2 A
Nominal contact voltage	110 VDC / 125 VAC
Max. switching capacity (resistive)	30 W / 62.5 VA
Min. switching capacity	100 μA / 10 mV DC

Dimensions, Connection Diagram(s)

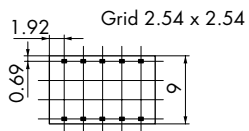

Viewed on relay from below

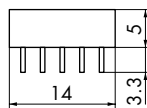

Hole diameter 0.8 mm

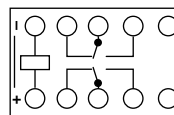

Top view



General Data

	178G2
Pull-in-time	approx. 5 ms
Drop-out time	approx. 4 ms
Bounce time	approx. 1 ms
Mechanical service life	> 20 x 10 ⁶ switching cycles
Test voltage	
Coil - contact	1000 VAC
(C/O) - (C/O)	1000 VAC
Contact - contact	1000 VAC
Capacities	
Contact - contact	approx. 0.5 pF
Coil - contact	approx. 1 pF
Insulation group VDE 0110b/2.79	C30, B125
Ambient temperature	-40 °C to +85 °C
Vibration resistance (30 - 100 Hz)	> 10 g
Weight	approx. 1.5 g
Operating range	Class 1 (0.8 - 1.1 U _N)
Pull-in	
after coil excitation with U _N at T _U	20 °C
Drop-out	> 0.05 U _N

Coil Data

Coil voltage DC	Nominal operation coil power approx. 0.14 - 0.2 W Pull-in power approx. 0.07 - 0.1 W	
Nominal voltage (V)	Nominal resistance (Ω)	Nominal current (mA)
5	178	28
12	1028	12
24	2880	8



Electrical Service Life

(resistive load), 90 % operating

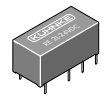
	178G2	
Switching voltage	30 VDC	125 VAC
Switching current	1 A	0.5 A
Electrical service life	0.5 x 10 ⁶ switching cycles	0.2 x 10 ⁶ switching cycles



Dual In-Line Relays RE

- Standard type  / 
- Washable
- High resistance version
- For switching small signals

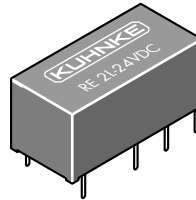

Order Code

Order code	R	E	2	L	-	24 V	DC
Type of relay	R						
Model							
E For printed circuit, high resistance coil		E					
Contact arrangement							
2 C/O			2				
Type of contact							
L Twin contacts				L			
Nominal operation coil voltage (see coil data)							
24 V						24 V	
Coil current type							
DC Direct current							DC

Contact Data

	RE monostable, poled
Contact arrangement	2 C/O
Type of contact	Twin contact
Contact material	Hard silver, gold-plated
Nominal contact current	2 A
Inrush current	≤ 2 A
Nominal contact voltage	120 VDC / AC
Max. switching capacity (resistive)	24 W / 60 VA
Min. switching capacity	100 µA / 10 mVDC

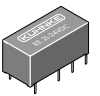

Dimensions, Connection Diagram(s)

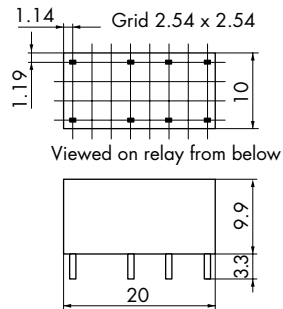

Hole diameter 0.8 mm

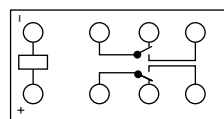

Top view

General Data

	RE monostable, poled
Pull-in-time	approx. 6 ms
Drop-out time	approx. 4 ms
Bounce time	approx. 1 ms
Mechanical service life	> 20 x 10 ⁶ switching cycles
Test voltage	
Coil - contact	1500 VAC
(C/O) - (C/O)	1500 VAC
Contact - contact	1000 VAC
Capacities	
Coil - contact	3 pF
(C/O) - (C/O)	1.5 pF
Contact - contact	2.5 pF
Insulation group VDE 0110b/2.79	A125
Ambient temperature	-40 °C to +70 °C
Vibration resistance (30 - 100 Hz)	> 10 g
Weight	approx. 3.7 g
Operating range	Class 1 (0.8 - 1.1 U _N)
Pull-in	
after coil excitation	
with U _N at T _U	20 °C
Drop-out	> 0.05 U _N

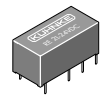

Coil Data

Coil voltage DC	RE monostable, poled Pull-in power approx. 0.1 W Nominal operation coil power approx. 0.2 W	
Nominal voltage (V)	Nominal resistance (Ω)	Nominal current (mA)
5	167	30
12	960	12.5
24	2880	8.3
48	11520	4.2

Electrical Service Life

(resistive load), 90 % operating

	RE monostable, poled
Switching voltage	24 VDC
Switching current	1 A
Electrical service life	0.5×10^6 switching cycles
Switching voltage	120 VAC
Switching current	0.5 A
Electrical service life	0.2×10^6 switching cycles



Table of Contents

1.	Definitions taken from relay regulations	99
1.1	Definitions	99
1.1.1	Coil terms	99
1.1.2	Terms relating to time	99
1.1.3	Contact terms	99
1.2	Reference conditions	99
1.3	Input values	100
1.3.1	Operating range	100
1.3.2	Release	100
1.4	Creepage and clearance distances	100
1.4.1	Insulation groups	100
1.4.2	Insulation coordination	101
1.4.2.1	Surge voltage test	101
1.4.2.2	Netfrequency alternating voltage test	101
1.5	Usage categories	102
1.6	Screw torque	103
2.	Regulations for relay applications	103
2.1	Manufacturer's certificate	103
2.2	Contact protection	103
2.3	Safe separation	103
2.4	Protection by casings	104
2.5	Plant safety	104
2.6	Line voltage harmonisation	104
3.	Selection and application of relays	105
3.1	Extended operating conditions	105
3.1.1	Low temperature	105
3.1.2	High temperature	105
3.1.3	Humidity	105
3.2	Climate application classes	105
3.3	Service life / reliability	106
3.3.1	Mechanical service life	106
3.3.2	Electrical service life	106
3.3.2.1	Inductive loads	108
3.3.2.2	Lamp loads	108
3.3.2.3	Fluorescent lamps	108
3.3.2.4	Capacitors	108
3.4	Protective circuits	109
3.4.1	Protective DC circuit	109
3.4.2	Protective AC and DC circuits	109
3.4.3	RC element circuit	110
3.4.4	Suppressor diode	110
3.4.5	Protective circuits - summary	111
3.5	Contact types and materials	111
3.5.1	Contact types	111
3.5.2.	Contact materials	112
3.5.2.1	Hard silver	112



3.5.2.2	Silver cadmium oxide	112
3.5.2.3	Silver palladium.....	112
3.5.2.4	Silver tin oxide	112
3.5.2.5	Silver nickel.....	112
3.5.2.6	Gold plating 10 µm	113
3.5.2.7	Gold plating 3 µm	113
3.5.2.8	Tungsten	113
3.5.3	Contact resistance.....	113
3.5.3.1	Increased reliability of contact making by	114
3.5.3.2	Measuring conditions	114
3.5.3.3	Evaluation of contact resistances.....	114
3.5.4	Selective list of contact loads	115
3.6	Relay types in terms of housing	115
3.7	Instructions for working up of PCB relays	116
3.7.1	Soldering instructions for sockets.....	116
3.7.2	Production of PCBs for relays.....	116
3.7.3	Fixing relays on the boards	116
3.7.4	Fluxing PCBs and relays	116
3.7.5	Soldering of PCB relays	116
3.7.6	Cleaning of relays after soldering	117
3.8	Relay installation positions	117
3.8.1	Armature positions	117
3.8.2	Orientation of contacts	117
4.	Relays according to German and international regulations.....	118
4.1	Scope of coverage of VDE	118
4.2	Declaration of conformity.....	118
4.3	CE mark	118
4.4	Licences.....	119



1. Definitions taken from relay regulations

1.1 Definitions

1.1.1 Coil terms

Nominal coil voltage is the voltage for which the coil is designed and rated and to which the other characteristic values are related.

Nominal coil current of units with coil winding is the current occurring at nominal voltage and a winding temperature of 20 °C.

Nominal coil resistance is the coil's DC resistance at 20 °C.

Nominal coil power rating is the power consumption at nominal voltage and nominal frequency, if applicable, i.e. the product of nominal voltage and nominal current.

Threshold current (voltage) is the minimum current (voltage) at which the relay positively pulls in.

Pull-in power is the average power consumption of a relay at threshold voltage (winding temperature 20 °C).

Transient current (pick-up current) is the current flowing through an AC winding at nominal voltage when the armature is held in the home position.

Release current is the current at which the relay armature is released.

Maximum permissible voltage is the voltage at which, at the max. ambient temperature, the max. permissible temperature is not exceeded.

1.1.2 Terms relating to time

Response time is the time between applying power to the coil and reaching the operating position (measured without bounce time).

Release time is the time between disconnecting power and leaving the operating position (measured without bounce time).

Bounce time is the time between the first and the complete closing (or opening) of a contact during closing (or opening) processes.

1.1.3 Contact terms

Nominal contact voltage is the voltage for which a contact element is rated to switch under stipulated conditions.

Switching voltage is the voltage applied to the open contact; it must not exceed the nominal contact voltage.

Nominal contact current is the maximum current that a contact can carry continuously under stipulated conditions. DIN EN 61810-1/VDE 0435 Part 201 demands that at least half of a relay's N/O contacts is to be capable of carrying the nominal current.

Switching current is the current actually flowing through the closed contact; it can considerably exceed the nominal contact current for short periods.

Switching capacity is the product of switching voltage and switching current.

1.2 Reference conditions in compliance with DIN EN 61810-1/VDE 0435 Part 201

The standard operating ranges of influencing variables refer to the recommended relay operating ranges.

Influencing variable	Standard operating range
Ambient temperature	-5 to +55 °C
Air pressure	70 to 110 kPa
Relative humidity	see section 3.2, neither condensation nor ice must occur inside the relay housing.
Foreign magnetic induction	15×10^{-4} T in any direction
Position	5° in any direction away from the reference position
Frequency	Reference value +10 %/-6 %
DC ripple	≤ 12 %
DC portion of AC	max. 5 % of peak voltage
Shock and vibration	according to manufacturer's data
Industrial exhausts and other influences	in process by IEC



1.3 Input values in compliance with DIN EN 61810-1/VDE 0435 Part 201

1.3.1 Operating range

Class 1	80 to 110 % of nominal voltage
Class 2	85 to 110 % of nominal voltage

1.3.2 Release

DC relay	> 5 % of nominal voltage > 10 % of the nominal voltage under nominal conditions
AC relay	> 15 % of nominal voltage

1.4 Creepage and clearance distances in compliance with DIN EN 61810-1/VDE 0435 Part 201

Where creepage and clearance distances are concerned, this European standard refers to DIN EN 61810-5/VDE 0435 Part 140. Creepage and clearance distance ratings of electrical relays are currently defined in accordance with VDE 0110 b/ 2.79 as yet.

1.4.1 Insulation groups in acc. with VDE 0110 b/ 2.79

VDE 0110 b/ 2.79 stipulates the minimum insulation distances for operating equipment. According to its use and operating conditions, the equipment is classified by one of the insulation groups below:

Insulation group Ao	includes low-output equipment which is installed in air-conditioned or clean, dry rooms, or is protected by suitable means; minor temperature rise in the case of short circuit.
Insulation group A	includes equipment which is installed in air-conditioned or clean, dry rooms, or is protected by suitable means.
Insulation group B	includes equipment in domestic or commercial rooms, precision engineering workshops, laboratories, test bays, or medical care locations.
Insulation group C	includes equipment primarily for use in industrial, commercial and agricultural environments, unheated storerooms, workshops, boiler houses, or in conjunction with machine tools.
Insulation group D	includes equipment for use in vehicles which are exposed to the effects of conducting brake dust and moisture (condensation, snow) without being enclosed.

The insulation group is to be chosen according to the application. Apart from the insulation group, the operating voltage is to be taken into account.



1.4.2 Insulation coordination in acc. with DIN EN 61810-5/VDE 0435, Part 140

The standard defines the requirements to insulation coordination for the electromechanical switching relays. For the purpose of insulation coordination, the devices due to IEC 60664-1 are classified by the following groups:

Overvoltage category I	covers devices that connect to fixed electrical installations in buildings; measures for the limitation of transient surges are to be provided.
Overvoltage category II	covers devices that connect to fixed electrical installations in buildings (e.g. household appliances, portable tools and similar loads).
Overvoltage category III	covers devices that are components of fixed installations (e.g. distributor boards, power switches, distributors) and devices that can be permanently connected to a fixed installation at any time (e.g. devices for industrial applications, stationary motors).
Overvoltage category IV	covers devices that are intended for use at or near the feeding point of electrical installations in buildings, looking from the main junction box towards the line (e.g. electricity meters, overload switches).

Relays for industrial applications fall under Overvoltage category III.

The 'Pollution degree' defines the contamination, which may reduce the stability or the surface resistance of the insulation.

Pollution degree 1	covers dry and non-conductive contamination without any influence.
Pollution degree 2	covers non-conductive contamination which, due to condensation, may become conductive at times.
Pollution degree 3	covers conductive contamination or dry, non-conductive contamination which will become conductive because condensation is expected.
Pollution degree 4	covers contamination that is always conductive due to conductive dust, rain or snow.

In conjunction with the operating voltage and the relay's overvoltage category results the rated impulse withstand voltage.

1.4.2.1 Surge voltage test in acc. with IEC 60664-1

Test voltage	Impulse withstand voltage due to DIN EN 61810-5/VDE 0435 Part 140 curve shape 1.2/50 μ s
--------------	---

1.4.2.2 Nefrequency alternating voltage test in acc. with IEC 60664-1

Test voltage	AC $2 \times U_N + 1000$ V for 1 min
--------------	--



1.5 Usage categories in acc. with DIN EN 60947-4-1/VDE 0660 Part 102 and DIN EN 60947-5-1/VDE 0660 Part 200

The usage categories listed in DIN EN 60947-4-1/VDE 0660 Part 102 in conjunction with the nominal operating current and the nominal voltage mark the intended use and the load on contactors and motor switches (up to 1000 VAC or 1500 VDC).

Type of current	Usage category	Typical application
Alternating current	AC - 1	non-inductive or low-induction loads, resistance ovens slip ring motors: start, stop squirrel-cage motors: start, stop during operation squirrel-cage motors: start, reverse current braking, reversing, inching control of gas discharge lamps control of filament bulbs control of transformers control of capacitor batteries low-induction loads of household appliances and similar applications motor loads for household appliances control of hermetically enclosed cooling compressor motors with manual reset of overload triggers same as AC-8a, but with automatic reset
	AC - 2	
	AC - 3	
	AC - 4	
	AC - 5a	
	AC - 5b	
	AC - 6a	
	AC - 6b	
	AC - 7a	
	AC - 7b	
AC - 8a		
AC - 8b		
Direct current	DC - 1	non-inductive or low-inductance loads, resistance ovens shunt wound motors: start, reverse current braking, reversing, inching, resistance braking series wound motors: start, reverse current braking, reversing, inching, resistance braking control of filament bulbs
	DC - 3	
	DC - 5	
	DC - 6	

The usage categories listed in DIN EN 60947-5-1/VDE 0660 Part 200 apply to control devices and switching elements for controlling, signal output, locking etc. of switching gear and switching systems (up to 1000 VAC or 600 VDC).

Type of current	Usage category	Typical application
Alternating current	AC - 12	control of resistive and semiconductor loads in the input circuits of opto-couplers control of semiconductor loads with transformer separation control of small electromagnetic loads (max. 72 VA) control of electromagnetic loads (above 72 VA)
	AC - 13	
	AC - 14	
	AC - 15	
Direct current	DC - 12	control of resistive and semiconductor loads in the input circuits of opto-couplers control of solenoids control of electromagnetic loads with economy resistors in the circuit
	DC - 13	
	DC - 14	

The diagram below illustrates the making and breaking currents according to the test conditions of the usage categories.

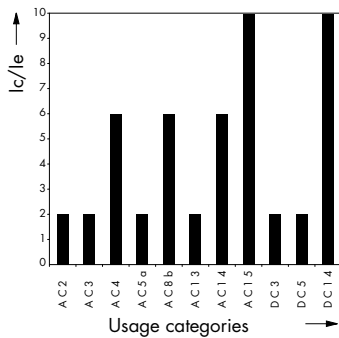

Ic = making-, breaking current
Ie = rated operating current
Ic/Ie = 1 for the usage categories not shown in the diagram



1.6 Screw torque in acc. with DIN EN 60999-1/VDE 0609 Part 1

The standard applies to the terminal points of screw-type terminals for the connection of single copper wires (max. diameter = 240 mm²) or several copper wires of the same diameter (max. 70 mm² per terminal).

The largest nominal diameter defined for the terminal point is used for the torque test. The wires are to be attached to and detached from the terminal point 5 times, using the test torques according to the table below. After the test, the terminal points must show no changes that would influence their use.

Nominal diameter of thread	Test torque / Nm
	Screws of terminal points that are screwed in by means of a screwdriver
Up to and inc. 2.8	0.4
Above 3.0 up to 3.2	0.5
Above 3.2 up to 3.6	0.6
Above 3.6 up to 4.1	1.2
Above 4.1 up to 4.7	1.8
Above 4.7 up to 5.3	2.0
Above 5.3 up to 6.0	2.5
Above 6.0 up to 8.0	3.5
Above 8.0 up to 10.0	4.0

2. Regulations for relay applications

2.1 Manufacturer's certificate (installer's certificate) in acc. with VBG 4 §5, para. 4

VBG4, a regulation issued by the employers' liability insurance association, describes the protective means of plants against accidental contact with electrically conductive parts. This regulation is a statutory obligation for plant operators. Responsibility can be transferred to the installer of the plant. Prior to its first start-up, the plant is to be checked and approved of by a qualified engineer who is to assess all of the protective means against accidental contact. The efficiency of protection can be assured by the installer of the overall system only. The certificate demanded by VBG4 §, para. 4 cannot be provided by component suppliers because the supplier has no influence on the installation and application conditions.

2.2 Contact protection in acc. with DIN VDE 0106 Part 100

VDE 0106 Part 100 is the basis for the design of electrical equipment for nominal voltages up to 1000 V. It describes the means of protection against direct contact during occasional work near exposed and hazardous parts.

The preventive actions listed below can be taken either separately or in any combination to provide the necessary protection:

- design alteration of the equipment
- space between the elements and exposed and hazardous parts
- other protective action (e.g. covers)

2.3 Safe separation in acc. with DIN EN 61140/VDE 0140 Part 1

The standard defines basic requirements among others for the safe separation of circuits of operating equipment in compliance with the relevant regulations.

It applies to equipment for nominal voltages up to 1000 VAC or 1500 VDC resp.

A safe separation of circuits prevents voltage from migrating between adjacent circuits.

Safe separation is achieved by:

- double or reinforced insulation, or
- base insulation and protective shield, or
- the combination of these precautions.



2.4 Protection by casings in acc. with DIN EN 60529/VDE 0470 Part 1

DIN EN 60529 provides system for classifying the degrees of protection of electrical equipment. The degrees of protection specify the protection, defined by standardised test methods, that a casing provides against the penetration of solid foreign particles and water. The degree of protection, or interelement protection, is indicated by means of the IP code (e.g. IP 40). The table below is a brief summary.

Code	IP	Protection of equipment	Personal protection
First number	0	against the penetration of solid foreign particles: (no protection)	against contact with hazardous parts by: (no protection)
	1	≥ 50 mm diameter	back of hand
	2	≥ 12.5 mm diameter	finger
	3	≥ 2.5 mm diameter	tool
	4	≥ 1.0 mm diameter	wire
	5	dust-protected	wire
	6	dust-proof	wire
Second number	0	against the damaging penetration of water: (no protection)	-
	1	vertical drops	
	2	drops (15° inclination)	
	3	spray water	
	4	spray water	
	5	jet of water	
	6	strong water jet	
	7	temporary immersion	
	8	permanent immersion	

2.5 Plant safety

Measures for the prevention of dangerous situations in the case of malfunctions must be taken in plants where the health or the life of humans or major assets depend on the machines' perfect operation.

Detailed requirements are listed in, for example

- DIN EN 60204-1/VDE 0113 Part 1
Electrical equipment of industrial machines
- DIN EN 50178/VDE 0160
Electronic operating equipment of power installations
- DIN VDE 832
Traffic signalling installations
- TRA 200
Technical regulation for lifts

These regulations can be taken as guidelines for applications where comparable requirements of functional safety are to be met, but for which no technical rules have been defined as yet.

2.6 Line voltage harmonisation

At present, the line voltages are being internationally harmonised to 230/400 V in compliance with IEC publication IEC 38 "Standard Voltages".

Therefore, different line voltage ranges apply until the end of the introductory stage in 2002.

Voltage tolerances are +6 %/-10 % of 230/400 V. The corresponding tolerances for the old line voltage of 220/380 V are thus +10 %/-6 %.

Due to the fact that the voltage may suffer another 4 % drop in the consumer's circuitry (after the house connection point), the consuming devices are to be designed for a range between 0.86 and 1.06 of the new rated line voltage.

The relays presented in this catalogue have been designed for the new line voltage. In most cases, the coils didn't have to be modified to adapt the devices to the changeover.



3. Selection and application of relays

3.1 Extended operating conditions

The relays can be used outside of the Standard Operating Conditions described in section 1.2. According to relay regulations, the preferable range of ambient temperatures is between $-5\text{ }^{\circ}\text{C}$ and $+55\text{ }^{\circ}\text{C}$. For extended temperature ranges of individual relays refer to the relays' data sheets. The operating voltage diagram illustrates the relation between operating voltage and ambient temperature (supplied upon request). While the maximum permissible voltage reduces as the temperature rises, the threshold and release voltages increase.

Example (varies with relay type)

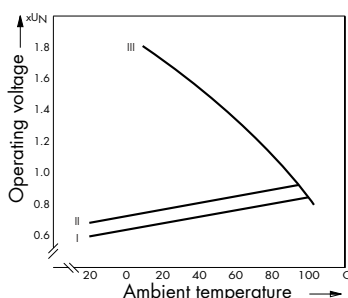

- I. Pull-in excitation (coil not warmed up)
- II. Pull-in excitation (coil warmed up)
- III. Max. permissible voltage, relative to a temperature limit of $120\text{ }^{\circ}\text{C}$, if the duty cycle is 100 %

3.1.1 Low temperature

At low temperatures, the threshold and release voltages are reduced (by approx. $0.4\text{ } \%/K$). Icing up (frost formation) may temporarily lead to malfunctions. **Until now, no damages at temperatures** down to about $-25\text{ }^{\circ}\text{C}$ have been found either in practical use or in laboratory tests.

3.1.2 High temperature

High ambient temperatures and the heat produced by the relay itself have a cumulative effect on insulating materials and metals. Thus, the reaction times of chemical processes double at every increase in temperature by $10\text{ }^{\circ}\text{C}$. The influence is kept at a minimum by a suitable choice of materials (metals, insulants). Some contact materials tend to oxidise at higher temperatures.

3.1.3 Humidity

Humidity reduces the insulating properties of electrical operating equipment and promotes the corrosion of metals. These effects are aggravated by corrosive atmospheres. **More perfectly adapted** materials help to turn the influence of humidity into a comparatively minor problem. We recommend to encase the electrical devices if they are exposed to extreme ambient conditions.

3.2 Climate application classes

The application classes and reliability data for components of communications engineering and electronics are specified in DIN 40040.

The following applies to most of our relays:

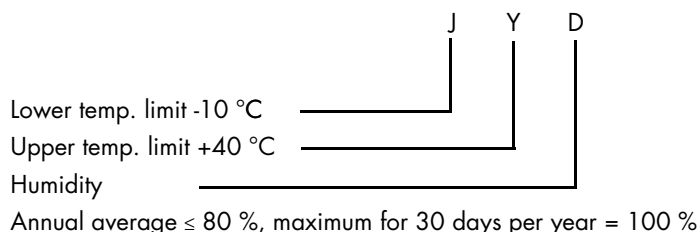



DIN IEC 68 describes the "Environmental Tests for Electrical Engineering". From this compilation, the following tests were chosen and carried out on electrically non-excited devices:

Part 2 – 1	Low temperature, severity -40 °C, 2 h
Part 2 – 2	Dry heat, severity +125 °C, 16 h
Part 2 – 3	Humid heat, constant exposure, severity 40/93, 56 d
Part 2 – 30	Humid heat, cyclic exposure, severity 55 °C, 6 cycles
Part 2 – 14	Rapid temperature change,, severity -40 °C, +125 °C, 3 cycles

The relays can be used in tropical zones.

A high degree of humidity and fast temperature changes may lead to condensation which is to be avoided, e.g. by heating the control cabinet.

3.3 Service life / reliability

The service life of technical equipment is subject to the laws of statistics.

Because of the multitude of influencing factors, service life data can only be given for defined operating conditions.

3.3.1 Mechanical service life

The service life information given for every type of relay has been achieved by 90 % of the relays under the standard conditions listed below.

For this test, current is only applied to the coil. The relay is considered to operate satisfactorily as long as the contacts work properly.

- Switching frequency 10 Hz
- Relative duty cycle 50 %
- Ambient temperature 20 - 35 °C
- Relative humidity 35 - 85 % (no condensation)
- Orientation horizontal mounting surface

3.3.2 Electrical service life

The main influencing factor on a relay's electrical service life is the arc produced when the contact opens and closes. In the case of switching relays, other influences, such as contact friction, contact clearance or the mechanical quality of the contact rivet, can be neglected.

Closing arc

An arc is produced when a contact is activated and reaches the critical field strength.

The arc causes material to evaporate and to create fusible links.

This process is reinforced by the bouncing of the contacts.

Extremely high transient currents may melt material off large portions of the contact surfaces, thus causing the contacts to weld.

Opening arc

When the contact opens,

- the effective contact surface is reduced due to decreasing contact forces
- the current density in the remaining current pathways increases
- the temperature in the remaining current pathway rises up to the melting point
- a fusible link is produced at currents of < 100 A
- at currents of > 100 A, the fusible link evaporises in an explosion-like process and the melted contact material sprays out.
- Smooth, melted off contact areas and bead-shaped contact material depositing around the contact appear on the contact surface.

The circuit is safely separated by

- resistive and capacitive loads in conjunction with small voltages

An arc may be produced by

- resistive and capacitive loads in conjunction with high voltages
- inductive loads



Permanent arcs are mainly produced by DC current.
 Alternating current quenches the arc when the current crosses over the zero point.

The arc is influenced by

- the contact material
- a reduction of the arcing voltage and arcing current
- the speed of the switching elements
- an increased clearance between the arc starting points.
 Influencing factors are the contact gap, a blow-out magnet, or a mechanical widening of the gap. (This is of extreme importance for the switching of DC currents.)

DC switching capacity - resistive loads

The diagram below illustrates the maximum switching capacity at DC voltage.

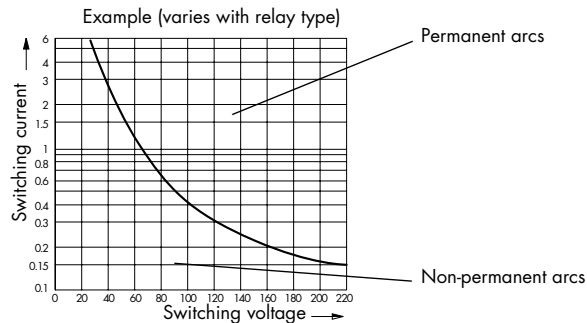

The area below the curve ensures a service life of $\geq 1 \times 10^6$ operating cycles (90 % success of test samples).

Parameters for finding the DC switching capacity

Contact switching voltage	x-axis
Making current = breaking current	y-axis
Switching frequency	3600/h
Duty ratio	25 % cyclic duration factor
Ambient temperature	20 - 35 °C
Relative humidity	35 - 85 % (no condensation)
Orientation	horizontal mounting surface
Contact material	standard material used for the relay
Type of load	resistive

In the case of DC voltage switching, further service life information can only be obtained in conjunction with additional arc-quenching measures. The corresponding DC load can only be specified exactly if the original load is applied.

There are the following differences between the switching of DC loads and AC loads:

- no arc quenching at zero crossing
- depending on the load, the material on the contact migrates from the anode to the cathode
- the contact gap has a greater influence on the service life than in the case of AC switching
- in the case of DC switching, the burn-out buffer on the contacts influences the service life



Electrical service life - AC

As opposed to the switching of DC voltages, AC switching allows a more exact forecast of the contact life due to arc quenching at zero crossing. The diagram below gives an illustration of the relationship between service life and switching capacity. The diagram is a direct reading of the service life to be expected from 90 % of the relays at resistive and inductive loads resp.

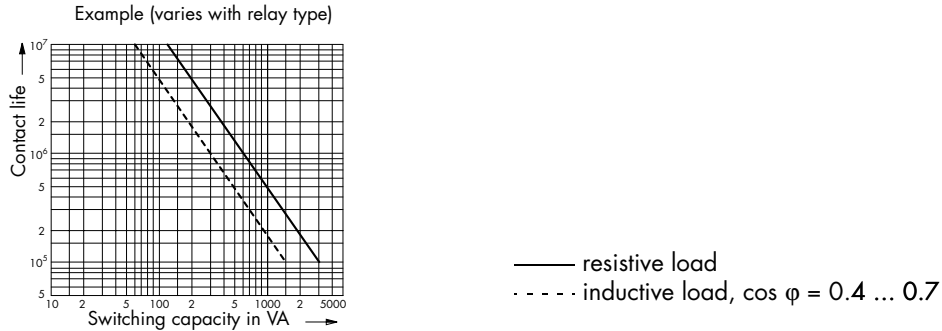

Parameters for finding the AC correct switching capacity curve

Contact switching voltage	230 V / 50 Hz; if other contact voltages are used, the switching capacity is to be adapted in the diagram, e.g. half the capacity for 115 VAC.
	Making current = breaking current
Switching frequency	3600/h
Duty ratio	25 % cyclic duration factor
Ambient temperature	20 - 35 °C
Relative humidity	35 - 85 % (no condensation)
Orientation	horizontal mounting surface
Contact material	standard material used for the relay
Type of load	resistive

The service life information for purely resistive loads can be easily reproduced. In the case of inductive or capacitive loads - especially if combined with DC voltage - the service life can only be reliably specified by doing a switching capacity test under nominal conditions with the original load applied.

3.3.2.1 Inductive loads

Due to the higher making currents and the breaking voltage peak, the service life differs from application to application in the case of inductive loads. The different types of load are classified by a couple of usage categories. The switching behaviour of the relevant types of load is the same as the switching of inductive loads such as motors or transformers.

The usage categories summarise the making and breaking conditions for some inductive loads for both AC and DC switching.

3.3.2.2 Lamp loads

The resistance of cold filament bulbs is only about 5 to 10% of the value measured at operating temperature. The making current is therefore 10 to 20 times higher. A 100 W bulb, for example, has an inrush power of more than 1000 W.

3.3.2.3 Fluorescent lamps

Due to the starting and the building up of high voltage in the ballast (inductor) required for igniting the lamp, the switching of fluorescent lamps produces high making currents.

When the lamp is switched off, the inductor generates high breaking voltage peaks.

Compensating capacitors in the circuit may lead to extremely high making currents at the contact and, thus, to a welding of the contacts.

3.3.2.4 Capacitors

AC circuits in conjunction with inductive loads produce resonances which may lead to increased currents in the case of series resonances and to increased voltages in the case of parallel resonances. The charging and discharging of capacitors with small damping resistances produces high peak currents which may cause the contacts to weld up. This effect mainly occurs when controlling capacitors of power supply units.



3.4 Protective circuits

The purpose of protective circuits is to reduce the load on contacts or electronic units when switching consumers.

The circuits protect the switching elements against the breaking voltage peak of the inductive load.

Protective circuits avoid

- EMC problems
- contact material degradation
- contact material migration
- destruction of insulation by overvoltage
- destruction of electronic components
- radio interference in the electronics by clicking sounds

The circuits below have proved their practical worth.

3.4.1 Protective DC circuit

Free-wheeling diode

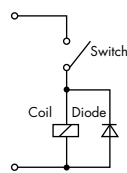

Effect of protective circuit at breaking

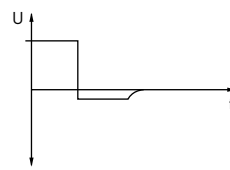

Coil voltage curve

Advantages

- The effect does not depend on the voltage
- Neutral making behaviour
- Breaking voltage peak of 0.7 V (silicon)
- Low costs
- Small

Disadvantages

- The drop-out delay multiplies by 3 to 4
- No polarity safeguard

3.4.2 Protective AC and DC circuits

Varistor circuit

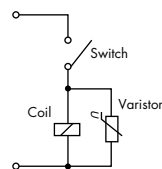

Effect of protective circuit at breaking

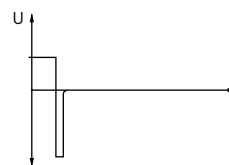

Coil voltage curve

Advantages

- Small
- Applies to AC and DC operation
- Simple adjustment
- The drop-out delay increases only slightly
- Polarity safeguard

Disadvantages

- Comparatively large space required
- Large overvoltages
- Limited switching frequency
- Optimum protection for only one voltage



3.4.3 RC element circuit

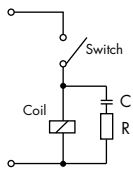

Effect of protective circuit at breaking

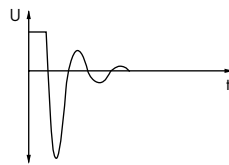

Coil voltage curve

Advantages

- Applies to AC and DC operation
- The drop-out delay increases only slightly
- Polarity safeguard
- Low overvoltage if optimally adjusted

Disadvantages

- Comparatively large space required
- R-C combination to be optimised for the inductive load
- Increased drop-out delay if optimally adjusted
- High making current peaks caused by capacitor
- No protection with small voltages

Equation for easy calculation of protective RC element circuits

$$R \approx 0,5 \frac{\text{Nominal coil voltage}}{\text{Nominal coil current}}$$

$$C \approx \frac{\text{Coil inductance}}{4 \cdot \text{coil resistance}^2}$$

3.4.4 Suppressor diode

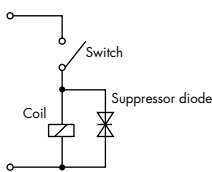

Effect of protective circuit at breaking

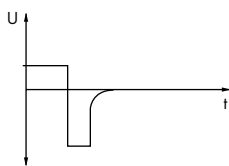

Coil voltage curve

Advantages

- Small
- Applies to AC and DC circuits
- The drop-out delay increases only slightly
- Polarity safeguard
- Simple adjustment
- High degree of protection

Disadvantages

- Limited switching frequency
- Works with only one voltage



3.4.5 Protective circuits - summary

Comparison of breaking voltage peaks of the various protective circuits.

Delays caused by the protective circuits
Type-dependent example for various protective circuits.

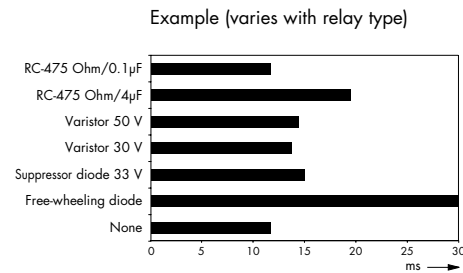
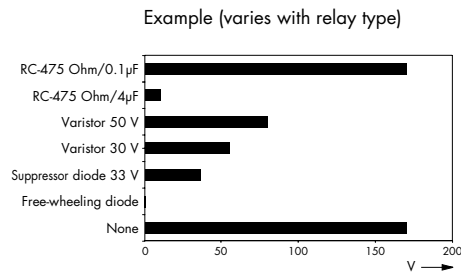

3.5 Contact types and materials

The right choice of contact type (single contact, twin contact, bridge contact) and contact material is the determining factor for service life and reliability of contact switching. The required contact type and material depend on the types of load described above.

3.5.1 Contact types

Single contact

Single contacts are used for switching medium-range loads. A single contact point opens and closes the circuit.

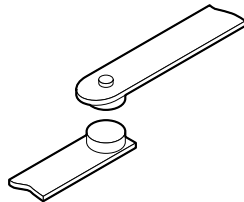

Advantages

- Covers a wide range of applications
- Low contact resistance
- Large number of switching cycles

Twin contact

Twin contacts are used for switching small loads. Two parallel contact blades open and close the circuit.

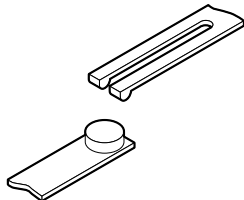

Advantages

- Reliability of contact making significantly increased compared with single contacts
- Constant contact resistance



Bridge contact

Bridge contacts are used for switching heavy loads. Two contact points in series open and close the circuit.

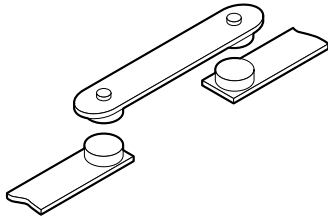

Advantages

- Arc suppression at two points
- Large contact gap

If small loads are to be controlled, the following factors may have a negative impact on the reliability of contact making:

- Long chains of contacts
- Reduced switching frequency (e.g. quiescent current monitoring circuits)
- Dust
- High ambient temperatures
- Increased humidity
- Corrosive gases, etc.

3.5.2. Contact materials

The minimum switching capacity data under normal operating conditions are specified. Please contact one of our representatives in your area or the main factory in Malente, if your applications require operation near the set limits.

3.5.2.1 Hard silver

- Silver contents 97 - 98 %
- Harder than fine silver due to alloy contents of Cu and Ni (2 - 3 %)
- Long contact life
- Alloys tend to oxidise at higher temperatures
- Material for standard applications
- Minimum contact load single contact > 20 V/50 mA
twin contact > 10 V/20 mA

3.5.2.2 Silver cadmium oxide

- Cadmium oxide makes the material more resistant to welding at high making current peaks
- Material erases evenly across the surface
- To be used preferably for high AC loads (strong DC breaking arcs leads to one-sided reduction of cadmium oxide in the contact)
- Minimum contact load > 20 V/50 mA

3.5.2.3 Silver palladium

- Palladium contents increases resistance against sulphurisation
- Highly resistant to corrosion and very hard
- Disadvantage: palladium forms insulating layers on contacts
- Application in atmospheres containing oil or other organic components is reduced to large switching capacities
- Minimum contact load > 20 V/50 mA

3.5.2.4 Silver tin oxide

- Tin oxide makes the material more resistant to welding at high making current peaks
- Very high burn-out resistance at large switching capacities
- Low degree of material migration under DC loads
- Applications with high making and breaking currents
- Minimum contact load > 20 V/50 mA

3.5.2.5 Silver nickel

- High burn-out resistance due to nickel contents
- More resistant to welding at high loads than hard silver
- Alloys tend to oxidise at higher temperatures
- Material for standard applications
- Minimum contact load single contact > 20 V/50 mA
twin contact > 10 V/20 mA



3.5.2.6 Gold plating 10 µm

- Abrasion-proof due to a 10 µm layer of hard gold (removed by contact friction and erosion after approx. 1 million switching cycles in "dry circuits")
- Multi-range contact for the switching of low and higher loads
- Available as single and twin contact
- Twin contact to be used with low contact loads in dusty atmospheres
- Minimum contact load > 1 mA/ 100 mV

3.5.2.7 Gold plating 3 µm

- Non-porous gold plating
- Same properties as 10 µm gold plating, but less durable

3.5.2.8 Tungsten

- High melting point; suitable for switching high making current peaks
- Tungsten forms layers of oxides and corrosion (no precious metal)
- High contact resistance, thus only 25 % of the nominal contact current permissible
- Contact making less reliable with small switching voltages
- Used for lighting, inductive or capacitive loads and high switching frequencies

3.5.3 Contact resistance

Contact resistance R_K is made up of

- Inherent contact resistance (R_D)
- Friction resistance (R_E)
- Contamination resistance (R_F)

$$R_K = R_D + R_E + R_F$$

The inherent resistance

- is calculated on the basis of the contact's geometry, its specific resistance, and the current distribution.

The friction resistance

- is defined as follows (after Holm):

$$R_E = \frac{r_1 + r_2}{2} \sqrt{\frac{H}{P}}$$

H = hardness of the contact material
 r = specific resistance of the pair contacts
 P = contacting force

The friction resistance is influenced by the following variables

- Electrical conductivity of the contact materials
- Thermal conductivity of the materials
- Geometry and surface structure of the contact point
- Contacting force and its effective direction

The contamination resistance may include

- Oxides, sulphides or organic substances
- Influences from the air and the industrial atmosphere
- Gas emission from plastic materials and stranded wires
- Oil, grease, fluxing and cleaning agents
- Contamination by dust, textiles, abrasives etc.

The hardness of these insulating layers can be up to 1000 N/mm², making them impenetrable even at high contacting forces.



3.5.3.1 Increased reliability of contact making by

- applying and switching higher voltages that pass through the contamination (fritting)
- using twin contacts
- using inert gas to encase the contacts
- surface roughnesses up to 20 μm
- specially designed contact shapes
- high friction path
- high contacting force
- cleaning through burning the contamination in the switching arc

3.5.3.2 Measuring conditions

- Standard IEC 255-7 specifies the standard measuring conditions for relay contacts.
- There are the following measuring ranges, depending on the contact and type of contact.
20 mV/10 mA; 100 mV/10 mA; 24 V/100 mA; 24 V/1A
- These measuring conditions can be reproduced everywhere.

Standard, commercially available ohmmeters have undefined measuring voltages and currents. We recommend to set up a quadripole measuring array to exclude the influence of the leads on the results.

3.5.3.3 Evaluation of contact resistances

Contact resistances can only be specified as statistical data. Due to mechanical allowances in the devices, the contact points of the contact elements change with every switching operation. The contact resistance is therefore a stochastic value.



Relays with washproof casing

The coil, the magnetic circuit and the contacts are located in a plastic casing. The casing has an opening that is covered by a piece of film. During the production process, the relay is sufficiently water-tight so that no vapours or cleaning agents can get in. At the end of the production process, the film is pulled off the opening in the casing.

Relays with hermetically sealed casing

The coil, the magnetic circuit and the contacts are enclosed in a hermetically sealed metal casing. Relays of this type are mainly used for the control of small signals.

3.7 Instructions for working up of PCB relays

3.7.1 Soldering instructions for sockets

Sockets should always be soldered on before any relays are mounted on the board.

The soldering process may produce very high temperatures. The maximum limits for the soldering onto circuit boards are $\leq 240\text{ °C}$, $t < 5\text{ s}$, or, if the relay is to be soldered directly to a socket, $\leq 280\text{ °C}$, t approx. 3 s. The materials used for sockets to be print-mounted are highly temperature-resistant. Sockets can be cleaned without any problems.

We do not recommend using ultrasonic cleaning for relays and sockets.

3.7.2 Production of PCBs for relays

The catalogue describes the physical and electrical properties of PCB relays. The following information is supplied for every relay

- drillhole diameter
- grid size
- dimensions
- technical data

The thickness of the circuit board is one of the factors that influence your choice of relay. Our PCB relays have been optimised for 1.6 mm boards. This allows an optimal solder cone to form at the remaining end of the soldering pin. The circuit board material is important for the application rather than for mounting the relays.

The PCB layouts are to be designed such that they comply with the relevant standards. The width of conducting tracks is to be adapted to the current to be carried.

The relays should be located on the board at some distance from high inductive loads (transformers) or hot elements (dissipators). Failure to comply might lead to problems during operation. Another important consideration is to provide means that protect other elements from breaking current peaks produced by the coil.

3.7.3 Fixing relays on the boards

The space between the mounted relays mainly depends on the possibilities of relay placement and the thermal influences on the relays. The relays can be placed in any orientation unless otherwise specified.

If the boards are exposed to particular stress such as shock or vibration, please contact the supplier to ensure the relays' application.

3.7.4 Fluxing PCBs and relays

Don't use aggressive fluxing agents to flux the relays. Only use very little fluxing agent if you are soldering by hand. If you are using a bath for fluxing, make sure that the fluxing agent does not get onto the relay surface. Use encased or wash-proof relays only.

3.7.5 Soldering of PCB relays

There are three different methods of mounting the relays on the circuit board.

1. Manual soldering
2. Automatic wave soldering
3. Soldering in the reflow oven.

1st method: Use a temperature-controlled soldering iron with a max. temperature of 280 °C . The soldering iron should contact the soldering point no longer than 3 s. The fluxing agent should be the least aggressive. The temperature of the solder is to be between 180 °C and 200 °C .



2nd method: Soldering should be done at a maximum temperature of 240 °C which should be applied to the soldering points for no longer than 3 s. The fluxing agent should be the least aggressive. Make sure that the temperature near the relay does not exceed 100 °C during the soldering process.

3rd method: The connectors of relays that are designed for surface mounting in reflow ovens stand off at an angle (SMD). **These relays contain thermally extremely stable plastic materials.**

Relays of this type are hermetically sealed with almost no exception. The temperature curves of these relays depends on the manufacturer's specifications.

3.7.6 Cleaning of relays after soldering

The circuit board should be cleaned as quickly as possible after soldering. The solvent used depends on the fluxing agent manufacturer's specifications. Only hermetically sealed or wash-proof relays can be cleaned in this way. Wash-proof relays have an opening that is covered by a piece of film. This film can be removed after cleaning. Solder-tight relays are not suitable for washing.

3.8 Relay installation positions

All relays presented in this catalogue can be installed in any position and orientation. Please take note of the comments below because they help to improve the system's operational safety and service life if they are taken into account at the planning stage.

3.8.1 Armature positions

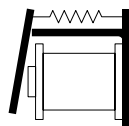

Pict. 1



Pict. 2

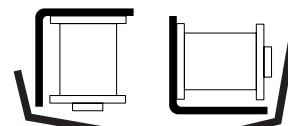

Pict. 3

Pict. 1: **Non-positive and positive connection between armature and yoke (e.g. Universal Relay).**

Pict. 2/3: **Free orientation of armature (e.g. Industrial Relay).**

The ratings apply to installation positions as in Pict. 1 and Pict. 2. They do not vary much.

A free orientation of the armature ensures the longest service life if the armature is located on the yoke's blade (Pict. 2).

There is more variation in response values and increased mechanical wear if the armature lifts off the blade (Pict. 3).

3.8.2 Orientation of contacts

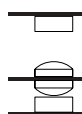

Pict. 1

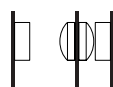

Pict. 2

Pict. 1: The contacts are horizontally arranged.

This orientation may allow

- particles from the ambient atmosphere
- cinders from switching an electrical load
- abrasives from mechanical wear

to deposit on the contacts or strike into the contact surfaces.

This may cause problems with small loads.

Pict. 2: The contacts are vertically arranged.

This orientation almost entirely prevents

- particles from the ambient atmosphere
- cinders from switching an electrical load
- abrasives from mechanical wear

from depositing on the contacts or striking into the contact surfaces.



4. Relays according to German and international regulations

4.1 Scope of coverage of VDE

Relays are described by DIN EN 61810-1/VDE 0435 Part 201 - Electromechanical Relays non specified time. According to VDE 0024, relays are non-marking devices which therefore require no VDE test mark.

4.2 Declaration of conformity

The Kuhnke relays described in this catalogue have been designed and manufactured in compliance with harmonised standards DIN EN 60255-1-00/VDE 0435 Part 201 and DIN EN 61810-1/VDE 0435 Part 201 in accordance with the EC's Low-Voltage Directive (73/23 EEC).

Exception: Miniature Relay 111 A2 (test voltage)

4.3 CE mark

At present, there is no directive that demands a CE mark for switching relays without defined time response characteristics.

EMC Directive

Switching relays without defined time response characteristics (both electromechanical and semiconductor relays) require neither a CE mark nor the manufacturer's declaration of conformity as provided by the EMC Directive. The directive mainly concerns ready-to-use devices. Components that become parts of other devices are incapable of operating on their own.

Machine Directive

The Machine Directive differentiates between machines, parts of machines, and safety components. Relays fit none of these categories. They therefore need not carry a CE mark, and the manufacturer is not obliged to declare their conformity with the provisions of the Machine Directive.

Low-Voltage Directive

This directive concerns electrical equipment, which are installed in other devices, and devices for immediate use. The properties of electrical equipment that integrates into other devices as well as the safety of the final product considerably depend on how the components are installed. This type of equipment therefore requires no CE mark. Examples listed in the directive include basic electromechanical components such as plug-and-socket connectors, relays with PCB connectors and microswitches. These rules also apply to relays with plug-type connectors which are optionally available with PCB connectors. An exception are larger relays in conjunction with sockets that are installed in switching cabinets exclusively.



4.4 Licences

The relays listed below have been tested and approved of by foreign authorities. Some relays differ from the standard design. Please specify the relevant design in your order (e.g. SEV).

Relay type	UL	CSA	SEV	DEMKO	GL
	File Order Code	File Order Code	No. Order Code	Order Code	No. Order Code
178	E 63473 Standard	72763 Standard			
R	E 63473 Standard	35579 Standard			
173	E 41922 Standard	35579 Standard			
174	E 41922 Standard	35579 Standard			
175	E 41922 Standard	35579 Standard			
176	E 41922 Standard	35579 Standard			
171	E 41922 Standard	701713 Standard			
107	E 41922 Standard	35579 Standard			
114 A	E 63473 Standard	47569 Standard			
111 H1 111 A2	E 41922 Standard	70864 Standard			
U	E 41922 Standard	47569 Standard			
M		47569 Standard			
IA, IG	E 41922 IR, IS	47569 Standard	D 9.31/144 IB	ID	
IH			D 9.31/144 IV		
105	E 63473 Standard	47569 Standard	D 9.31/142 SEV		
P			D 9.31/146 SEV		
1500					97078 Standard

Part No. Index

Part No.	Page
105A220 24 VAC	38
105A220 24 VDC	38
105A310 24 VAC	38
105A310 24 VDC	38
105A400 24 VAC	38
105A400 24 VDC	38
105G220 24 VAC	38
105G220 24 VDC	38
105G310 24 VAC	38
105G310 24 VDC	38
105G400 24 VAC	38
105G400 24 VDC	38
107G 1 24VDC E	78
107G 2 24VDC E	78
107P 1 24VDC E	78
111A2 24 VAC	25
111A2 24 VDC	25
111H1 24 VAC	25
111H1 24 VDC	25
114A4 24 VAC 1	19
114A4 24 VAC N	19
114A4 24 VDC 1	19
114A4 24 VDC N	19
114A4 B 24 VDC 1	19
114A4 B 24 VDC N	19
130 2 01 2 180 24 VDC/AC	10
130 2 01 2 3 24 VDC/AC	10
130 2 01 2 30 24 VDC/AC	10
130 2 01 2 600 24 VDC/AC	10
130 2 02 2 180 24 VDC/AC	10
130 2 02 2 3 24 VDC/AC	10
130 2 02 2 30 24 VDC/AC	10
130 2 03 2 200 24 VDC/AC	10
130 2 03 2 50 24 VDC/AC	10
130 2 06 2 3 24 VDC/AC	10
130 2 06 2 30 24 VDC/AC	10
171G 1 24VAC	75
171G 1 24VDC	75
171G 2 24VAC	75
171G 2 24VDC	75
171P 1 24VAC	75
171P 1 24VDC	75
173G 1 24VDC	84
174G 1 24VDC	86
175G 100 24VDC	88
176G 1 24VDC	90
178G 2 24VDC	92
F1570 2 10-30Hz 230VAC 50/60Hz	72
F1570 2 40-65Hz 230VAC 50/60Hz	72
F1570 2 50-100Hz 230VAC 50/60Hz	72
I1540 2 0,1-1A 110/115 50/60Hz	69
I1540 2 0,1-1A 230VAC 50/60Hz	69

Part No.	Page
I1540 2 0,1-1A 24VDC	69
I1540 2 0,5-5A 110/115 50/60Hz	69
I1540 2 0,5-5A 230VAC 50/60Hz	69
I1540 2 0,5-5A 24VAC 50/60Hz	69
I1540 2 0,5-5A 24VDC	69
I1540 2 10-100mA 230VAC 50/60Hz	69
I1540 2 10-100mA 24VDC	69
I1540 2 1-10A 230VAC 50/60Hz	69
I1540 2 1-10A 24VDC	69
I1540 2 2-20mA 230VAC 50/60Hz	69
I1540 2 50-500mA 230VAC 50/60Hz	69
I1540 2 50-500mA 24VDC	69
I540 1 115/24 VAC	61
I540 1 230/24 VAC	61
I540 1 24 VDC	61
I541 1 115/24 VAC	61
I541 1 230/24 VAC	61
I541 1 24 VDC	61
IA2 24 VAC	30
IA2 24 VDC	30
IA4 24 VAC	30
IA4 24 VDC	30
IA6 24 VDC	30
IA8 24 VDC	30
IC2 24 VAC	30
IC2 24 VDC	30
IC4 24 VAC	30
IC4 24 VDC	30
IC6 24 VDC	30
IC8 24 VDC	30
IG2 24 VAC	30
IG2 24 VDC	30
IG4 24 VAC	30
IG4 24 VDC	30
IG6 24 VDC	30
IG8 24 VDC	30
IH100 24 VAC	34
IH100 24 VDC	34
MF2 0 40	8
MF2 1 40	8
MF2 24 VAC	5
MF2 24 VDC	5
MF3 24 VAC	5
MF3 24 VDC	5
PAC 24 VAC	43
PAC 24 VDC	43
PAS 24 VAC	43
PAS 24 VDC	43
PAW 24 VAC	43
PAW 24 VDC	43
PRC 24 VAC	43
PRC 24 VDC	43

Part No.	Page
PRS 24 VAC	43
PRS 24 VDC	43
PRW 24 VAC	43
PRW 24 VDC	43
PZ610 1 230/24 VAC	46
PZ610 1 24 VDC	46
PZ620 1 230/24 VAC	46
PZ620 1 24 VDC	46
PZ630 2 230 VAC	48
PZ630 2 24 VDC	48
PZ640 2 230 VAC	50
PZ640 2 24 VDC	50
PZ650 21 230 VAC	52
PZ650 21 24 VDC	52
PZ650 22 230 VAC	52
PZ650 22 24 VDC	52
PZ660 2 230 VAC	54
PZ660 2 24 VDC	54
RE 2 L 24VDC	94
U1510 2 0,5-5V 110/115VAC 50/60Hz	63
U1510 2 0,5-5V 230VAC 50/60Hz	63
U1510 2 0,5-5V 24VDC	63
U1510 2 10-100mV 230VAC 50/60Hz	63
U1510 2 10-100mV 24VDC	63
U1510 2 25-250V 110/115VAC 50/60Hz	63
U1510 2 25-250V 230VAC 50/60Hz	63
U1510 2 25-250V 24VDC	63
U1510 2 50-500mV 110/115VAC 50/60Hz	63
U1510 2 50-500mV 230VAC 50/60Hz	63
U1510 2 50-500V 110/115VAC 50/60Hz	63
U1510 2 50-500V 230VAC 50/60Hz	63
U1510 2 50-500V 24VDC	63
U1510 2 5-50V 110/115VAC 50/60Hz	63
U1510 2 5-50V 230VAC 50/60Hz	63
U1510 2 5-50V 24VDC	63
U510 1 115/24 VAC	56
U510 1 230/24 VAC	56
U510 1 24 VDC	56
U511 1 115/24 VAC	56
U511 1 230/24 VAC	56
U511 1 24 VDC	56
UD1515 2 110/190V 50/60Hz	66
UD1515 2 127/220V 50/60Hz	66
UD1515 2 230/400V 50/60Hz	66
UD1515 2 290/500V 50/60Hz	66
UD1515 2 57/100V 50/60Hz	66
UD1525 2 110/190V 50Hz	66
UD1525 2 230/400V 50Hz	66
UD1525 2 290/500V 50Hz	66
UD1525 2 57/100V 50Hz	66
UD1535 2 127/220V 50/60Hz	66
UD1535 2 230/400V 50/60Hz	66

Part No. Index

Part No.	Page
UD1535 2 290/500V 50/60Hz	66
UD1535 2 57/100V 50/60Hz	66
UD517 1 230.400 45-64Hz	58
UD517 1 400.400 45-64Hz	58
UD532 1 230/400 47-53Hz	58
UF2 B 24 VAC N	1
UF2 B 24 VDC N	1
UF2 F 24 VAC N	1
UF2 F 24 VDC N	1
UF2 G 24 VAC N	1
UF2 G 24 VDC N	1
UF3 B 24 VAC N	1
UF3 B 24 VDC N	1
UF3 F 24 VAC N	1
UF3 F 24 VDC N	1
UF3 G 24 VAC N	1
UF3 G 24 VDC N	1
Z315.02	82
Z316.01	81
Z317.01	81
Z318.02	81
Z318.50	24
Z318.51	24, 83
Z318.52	24, 83
Z318.53	24, 83
Z318.54	24, 83
Z318.55	24, 83
Z318.57	24
Z318.58	24, 83
Z319.02	82
Z320.02	42
Z345	14
Z345.12	14
Z345.32	14
Z366.02	22
Z366.80	22
Z368.02	23
Z373	27
Z373.10	27
Z374	22
Z375.02	28
Z375.12	28
Z376.42	23
Z377	29
Z377.10	29
Z378	22
Z382.02	37
Z382.50	37
Z392	13
Z393	13
Z395	15
Z396	15

Part No.	Page
Z396.50	16
Z396.52	16
Z396.53	16
Z396.54	16
Z396.55	16
Z396.58	16
Z396.64	16
Z421	80
Z434	4,9
Z438	83
Z439	83
Z441	4
Z475	27
Z482	33, 36
Z582	37

KUHNKE.
IMPULSES FOR
AUTOMATION.



Kuhnke GmbH
Lütjenburger Straße 101
D-23714 Malente, Germany

Phone +49 (0) 4523 40 2-0
Fax +49 (0) 4523 40 22 47
E-mail sales@kuhnke.de
Internet www.kuhnke.com

Customer Service
Phone +49 (0) 4523 40 22 00
Fax +49 (0) 4523 40 22 01
E-mail service@kuhnke.de