

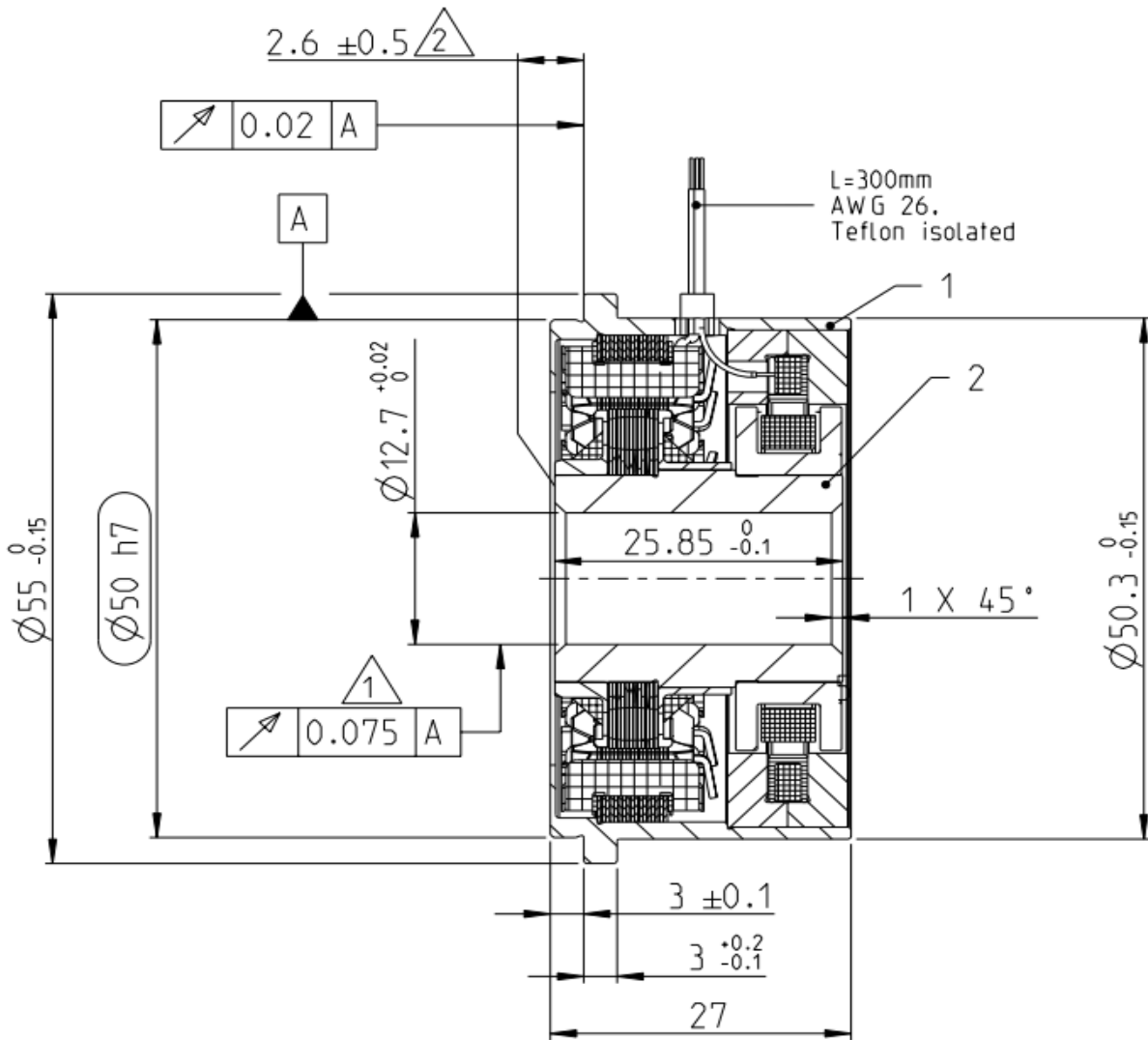

DATA SHEET - HOLLOW SHAFT RESOLVER

| | | | | |
|-------------------------------------|---|--|---|------|
| PN | 2350437-1 | | | |
| Description: | V23401- | T2071-B101 | | |
| Size | 21 | | | |
| Shaft inner diameter [mm] | 12.7 | | | |
| Speed (pair of poles) [p] | 1 | | | |
| Number of poles | 2 | | | |
| Application Specification | | | | |
| Test protocol | Results saved to manufacturing site archives. Available by request | | | |
| Electrical parameters (22°C) | | | | |
| Input voltage [V] | 7 | Based on specified Input voltage and Frequency | Input resistance R1R2 [Ω] | 80 |
| Frequency Typical [kHz] | 10 | | R1R2 tolerance [%] | ± 10 |
| Input current max [mA] | 50 | | Output resistance S1S3 or S2S4 [Ω] | 80 |
| Transformation ratio (rT) | 0.5 | | S1S3 or S2S4 tolerance [%] | ± 10 |
| Transf. ratio tolerance [%] | ± 10 | | | |
| Phase shift min [°] | -10 | | | |
| Phase shift max [°] | 0 | | | |
| Electrical Angular Error max [°] | ± 10 | | | |
| Residual voltage max [mV] | 25 | | | |
| High Voltage test | Voltage: 500V _{AC} (A) | | Measured between: A: Winding R1-R2 and housing Winding S1-S3 and housing Winding S2-S4 and housing | |
| | 250V _{AC} (B) | | | |
| | Time: 1s | | | |
| Isolation test | Voltage: 500V _{DC} (A, B) | | B: Windings S1-S3 and S2-S4 | |
| | Criterion: | R _{isol.} > 50MΩ | | |
| "Zero" setting: | Electrical "0" is when Coils V _{S2-S4} = 0 and V _{S1-S3} are in phase with V _{R1-R2} | | | |
| Transfer function | Looking at Transformation part and turning Rotor clockwise | | | |
| | $V_{S1-S3} = +rT * V_{R1-R2} * \cos(p*\alpha)$ | | | |
| | $V_{S2-S4} = +rT * V_{R1-R2} * \sin(p*\alpha)$ | | | |
| Rotor Inertia | approx. 20g.cm ² | | | |
| Max. Rotational Speed | 20,000 rpm | | | |
| Shock resistance (11ms sine) | 1000 m/s ² | | | |
| Vibration | 200 m/s ² | | | |
| Operating temp. | -55°C...+150°C | | | |



- ① Gesamtschlag im eingebauten Zustand
Concentricity in installed situation
- ② Axialversatz
Axial displacement/offset

| DATE | PN. REV. | DWN | APP | DS. REV. |
|----------|----------|------------|----------|----------|
| | | | | |
| | | | | |
| 22-01-20 | 1 | H.Bernardo | D.Ondrej | 1 |