

Mitsubishi Programmable Controllers
MELSEC-A/QnA (Large Type) Upgrade Catalog



From the MELSEC-A/QnA Series to the
MELSEC-AnS/Q Series

AQ / AnS
QnAS

Offering a Variety of Flexible Upgrade Options!

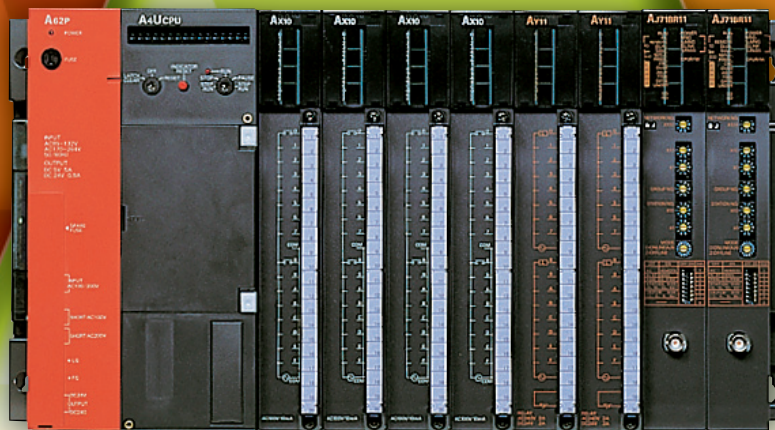

Mitsubishi Electric Corporation Nagoya Works is a factory certified for ISO14001 (standards for environmental management systems) and ISO9001 (standards for quality assurance management systems)



From the MELSEC-A/QnA Series
 → The MELSEC-AnS/Q Series

Offering a Variety of Flexible Upgrade Options!

Technical Bulletin

Large type A Series/Large type QnA Series	Production discontinuation	Technical Bulletin
A/QnA(Large type) ● CPU module ● I/O module ● Special function module ● Data link module (MELSECNET(II)/B module and others)	End of Sep., 2006	T99-0050
A2C Series A2C ● CPU module ● A2C I/O module ● Special function module and others	End of Sep., 2006 End of Sep., 2008	T99-0050 T99-0070
PC interface boards MELSECNET (II) , /B ● MELSECNET(II)/B Interface board	End of Sep., 2008	T99-0049
Small type AnS Series MELSECNET (II) , /B*1 ● Remote I/O module	End of Sep., 2008	T99-0049
MELSECNET/MINI-S3 ● Small type A Series master module ● I/O module	End of Sep., 2008	T99-0070
A0J2(H) Series A0J2 (H) ● CPU module ● Power supply module ● I/O module ● Special function module and others	End of Sep., 2008	T99-0069

*1 : Production of AnS Series master/local station data link modules (A1SJ71AP21, A1SJ71AR21, and A1SJ71AT21B) will be continued.

Replacement Handbooks

Transition from MELSEC-A/QnA (Large Type) Series to Q Series Handbook (Fundamentals) L(NA)-08043ENG-C
Transition from MELSEC-A/QnA (Large Type) Series to Q Series Handbook (Intelligent Function Modules) L(NA)-08046ENG-B
Transition from MELSEC-A/QnA (Large Type) Series to Q Series Handbook (Network Modules) L(NA)-08048ENG-B
Transition from MELSEC-A/QnA (Large Type) Series to Q Series Handbook (Communication Modules) L(NA)-08050ENG-C
Transition from MELSEC-A0J2H Series to Q Series Handbook L(NA)-08060ENG-A
Transition from MELSECNET/MINI-S3, A2C(I/O) to CC-Link Handbook L(NA)-08061ENG-A
Transition from MELSEC-I/OLINK to CC-Link/LT Handbook L(NA)-08062ENG-A
Transition from MELSEC-A/QnA (Large Type) Series to AnS/Q2AS (Small Type) Series Handbook L(NA)-08064ENG-A

Upgrade Options

Reusing existing programs when changing the PLC type.

P3

→ A/QnA → Q Conversion Support Tool

A→Q MELSOFT

Replacing the CPU module with the Q Series model without changing the existing modules.

P7

→ QA65B-E/QA68B-E Extension Base Unit

A→Q

Replacing with the AnS (Small type) module when module additions are required during modifications.

P8

→ A-A1S Module Conversion Adapter (A1ADP-XY: For I/O Module, A1ADP-SP: For Special Function Module)

Modification

Linking the A (Large type) Series and Q Series with MELSECNET (II)/B.

P9

→ AnS (Small type) local station dedicated module
 → MELSECNET (II), MELSECNET/10 gateway set G6KT-NETGW-□□
 → MELSECNET/10 Network Module (Production continues)

Network

Replacing the A0J2 (H) CPU with the Q Series model using existing wiring.

P12

→ A0J2(H) Interface Terminal

A→Q

Replacing MELSECNET/MINI with CC-LINK using existing wiring.

P13

→ MELSECNET/MINI-S3 I/O Module Wiring Conversion Adapter

CC-Link

Replacing with the Q Series base unit without changing existing wiring.

P14

→ Upgrade Tool (Manufactured by Mitsubishi Electric Engineering Co., Ltd.)

A→Q

Additional support

P15

→ Global FA Centers
 → Related Catalog
 → Production Discontinuation Schedule
 → Models to be discontinued
 → Exceptions

Support

NEW

A/QnA → Q Conversion Support Tool

Automatically extracts unconvertible locations by converting (reusing) existing programs!
Also displays the revision method!

**This convenient function simplifies the revision process.
The revision time can be dramatically reduced.**

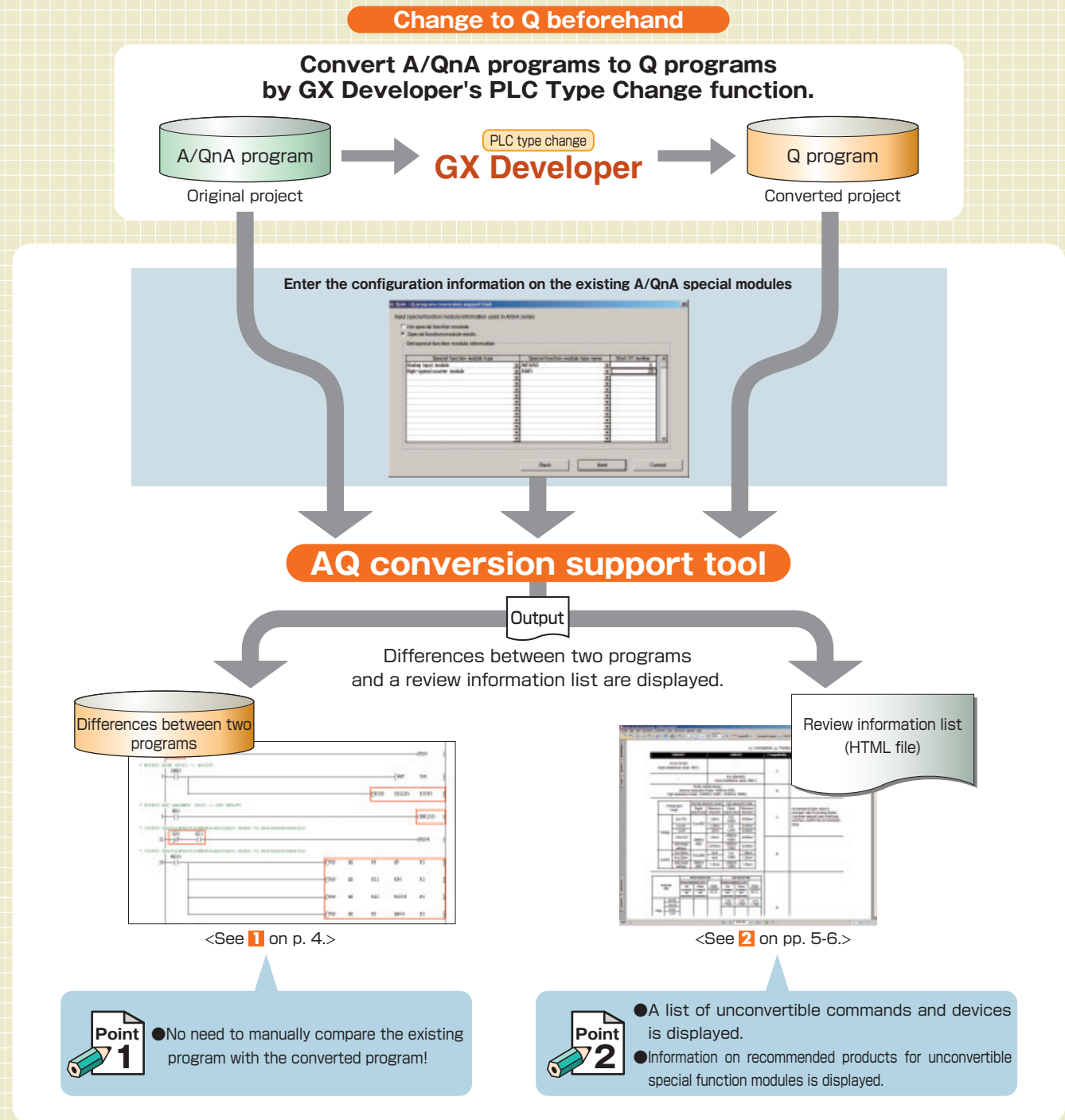

1 Differences between two programs

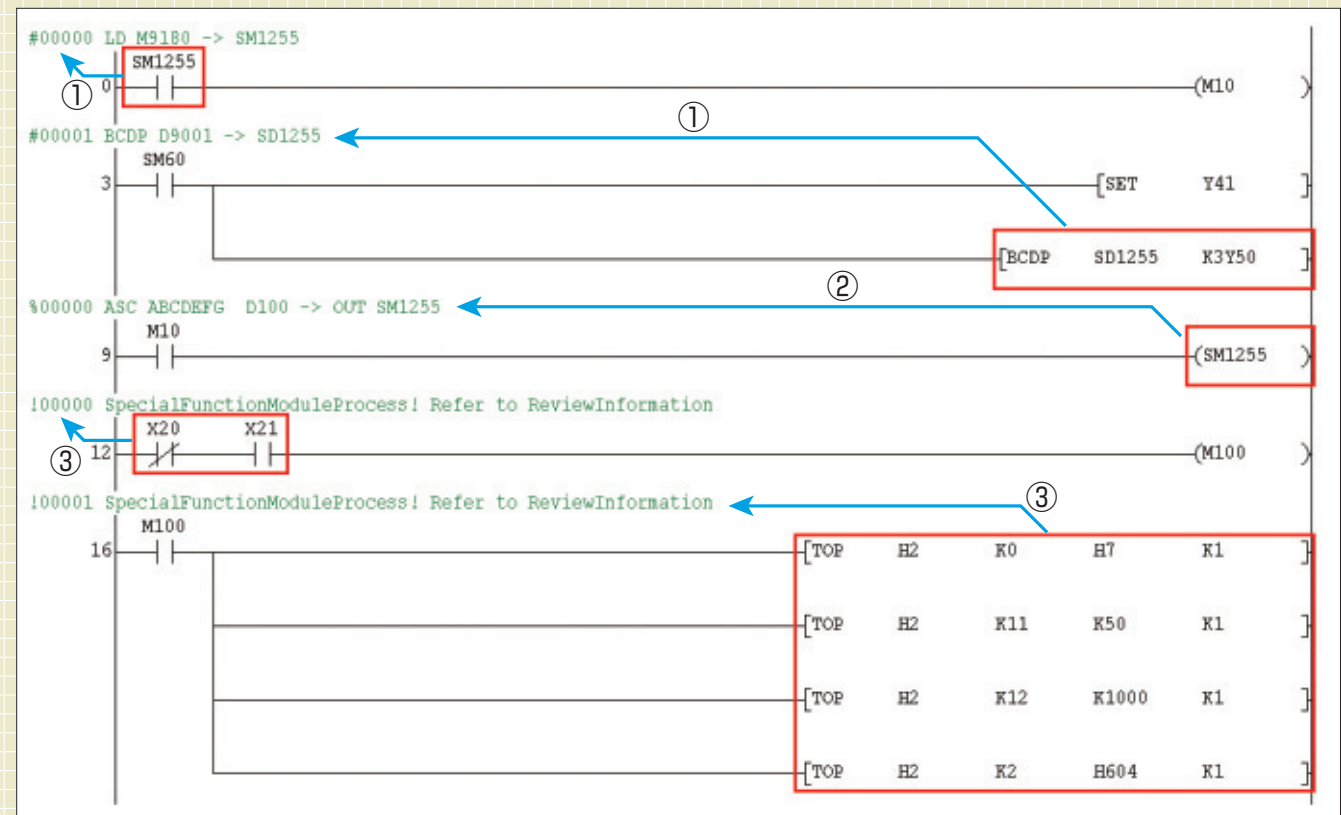

<Image of differences between two programs>

- ① **Statement of unconverted devices** — #
The original device and the converted device are displayed as shown below. The devices contained in the circuit block are displayed one line at a time.
(E.g.) #00001 ANI M9201 → SM1255
("#00001" is a search keyword in the review information list.)
- ② **Statement of unconverted instructions** — %
The original instruction and the converted instruction are displayed as shown below. The instructions contained in the circuit block are displayed one line at a time.
(E.g.) %00001 [LRDP K3 D10 D100 K3] → OUT SM1255
("%00001" is a search keyword in the review information list.)
- ③ **Statement of special function module processes** — !
For the special function module instructions (FROM, DFRO, TO, DTO and instructions using X/Y devices), a message requesting review is displayed.
(E.g.) !00001 SpecialFunctionModuleProcess! Refer to ReviewInformation
("!00001" is a search keyword in the review information list.)

Note: This support tool applies to ladder programs only.

A/QnA → Q Conversion Support tool

2 Review Information List

Detailed information is displayed hierarchically in Internet Explorer. Furthermore, information on differences between two programs and the review list are linked together.

(Example 1) Special function module processes which need to be reviewed

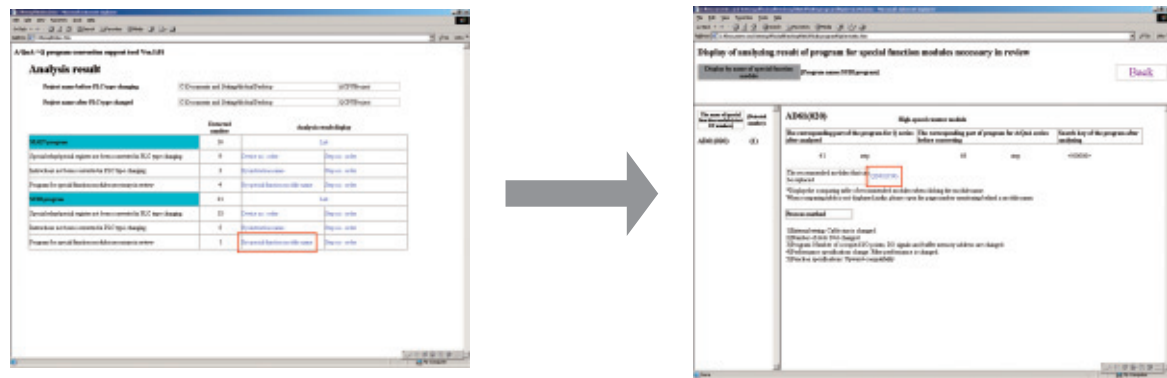

Click "By special function module name" in the "Programs for special function modules necessary in review" row.

Click the recommended module name next to "The recommended modules that can be replaced".

Q66ADV	Q66ADH	Compatibility	Precautions for replacement																																		
-10 to 10V/DC (Input resistance value: 1MΩ)	0 to 20mA/DC (Input resistance value: 250Ω)	A	The voltage/current cannot be mixed for one module.																																		
16-bit, signed binary (Normal resolution mode: -4096 to 4095, High resolution mode: -12288 to 12287, -16384 to 16383)																																					
<table border="1"> <thead> <tr> <th rowspan="2">Analog input range</th> <th colspan="2">Normal resolution mode</th> <th colspan="2">High resolution mode</th> </tr> <tr> <th>Digital output value</th> <th>Maximum resolution</th> <th>Digital output value</th> <th>Maximum resolution</th> </tr> </thead> <tbody> <tr> <td>0 to 10V</td> <td>0 to 4000</td> <td>2.5mV</td> <td>0 to 16000</td> <td>0.625mV</td> </tr> <tr> <td>0 to 5V</td> <td>0 to 2000</td> <td>1.25mV</td> <td>0 to 8000</td> <td>0.3125mV</td> </tr> <tr> <td>1 to 5V</td> <td>0 to 2000</td> <td>1.0mV</td> <td>0 to 12000</td> <td>0.333mV</td> </tr> <tr> <td>-10 to 10V</td> <td>4000 to 8000</td> <td>2.5mV</td> <td>-16000 to 16000</td> <td>0.625mV</td> </tr> <tr> <td>User range settings</td> <td>4000</td> <td>0.375mV</td> <td>-12000 to 12000</td> <td>0.333mV</td> </tr> </tbody> </table>	Analog input range	Normal resolution mode		High resolution mode		Digital output value	Maximum resolution	Digital output value	Maximum resolution	0 to 10V	0 to 4000	2.5mV	0 to 16000	0.625mV	0 to 5V	0 to 2000	1.25mV	0 to 8000	0.3125mV	1 to 5V	0 to 2000	1.0mV	0 to 12000	0.333mV	-10 to 10V	4000 to 8000	2.5mV	-16000 to 16000	0.625mV	User range settings	4000	0.375mV	-12000 to 12000	0.333mV		A	As concept of gain value is changed, refer to [Analog-Digital Converter Module User's Manual] and then, confirm the I/O characteristics.
Analog input range		Normal resolution mode		High resolution mode																																	
	Digital output value	Maximum resolution	Digital output value	Maximum resolution																																	
0 to 10V	0 to 4000	2.5mV	0 to 16000	0.625mV																																	
0 to 5V	0 to 2000	1.25mV	0 to 8000	0.3125mV																																	
1 to 5V	0 to 2000	1.0mV	0 to 12000	0.333mV																																	
-10 to 10V	4000 to 8000	2.5mV	-16000 to 16000	0.625mV																																	
User range settings	4000	0.375mV	-12000 to 12000	0.333mV																																	
<table border="1"> <thead> <tr> <th rowspan="2">Analog output range</th> <th colspan="2">Normal resolution mode</th> <th colspan="2">High resolution mode</th> </tr> <tr> <th>Setpoint temperature (T_{sp})</th> <th>Setpoint temperature (T_{sp})</th> <th>Setpoint temperature (T_{sp})</th> <th>Setpoint temperature (T_{sp})</th> </tr> </thead> <tbody> <tr> <td>0 to 20mA</td> <td>0 to 4000</td> <td>5μA</td> <td>0 to 12000</td> <td>1.66μA</td> </tr> <tr> <td>4 to 20mA</td> <td>4000 to 8000</td> <td>4μA</td> <td>12000 to 16000</td> <td>1.33μA</td> </tr> <tr> <td>User range settings</td> <td>4000</td> <td>1.37μA</td> <td>-12000 to 12000</td> <td>1.33μA</td> </tr> </tbody> </table>	Analog output range	Normal resolution mode		High resolution mode		Setpoint temperature (T _{sp})	Setpoint temperature (T _{sp})	Setpoint temperature (T _{sp})	Setpoint temperature (T _{sp})	0 to 20mA	0 to 4000	5μA	0 to 12000	1.66μA	4 to 20mA	4000 to 8000	4μA	12000 to 16000	1.33μA	User range settings	4000	1.37μA	-12000 to 12000	1.33μA		A											
Analog output range		Normal resolution mode		High resolution mode																																	
	Setpoint temperature (T _{sp})	Setpoint temperature (T _{sp})	Setpoint temperature (T _{sp})	Setpoint temperature (T _{sp})																																	
0 to 20mA	0 to 4000	5μA	0 to 12000	1.66μA																																	
4 to 20mA	4000 to 8000	4μA	12000 to 16000	1.33μA																																	
User range settings	4000	1.37μA	-12000 to 12000	1.33μA																																	
<table border="1"> <thead> <tr> <th rowspan="2">Analog input range</th> <th colspan="2">Normal resolution mode</th> <th colspan="2">High resolution mode</th> </tr> <tr> <th>Setpoint temperature (T_{sp})</th> <th>Setpoint temperature (T_{sp})</th> <th>Setpoint temperature (T_{sp})</th> <th>Setpoint temperature (T_{sp})</th> </tr> </thead> <tbody> <tr> <td>0 to 10V</td> <td>0 to 4000</td> <td>±0.2%</td> <td>0 to 16000</td> <td>±0.2%</td> </tr> <tr> <td>0 to 5V</td> <td>0 to 2000</td> <td>±0.2%</td> <td>0 to 8000</td> <td>±0.2%</td> </tr> <tr> <td>1 to 5V</td> <td>0 to 2000</td> <td>±0.2%</td> <td>0 to 12000</td> <td>±0.2%</td> </tr> </tbody> </table>	Analog input range	Normal resolution mode		High resolution mode		Setpoint temperature (T _{sp})	Setpoint temperature (T _{sp})	Setpoint temperature (T _{sp})	Setpoint temperature (T _{sp})	0 to 10V	0 to 4000	±0.2%	0 to 16000	±0.2%	0 to 5V	0 to 2000	±0.2%	0 to 8000	±0.2%	1 to 5V	0 to 2000	±0.2%	0 to 12000	±0.2%		A											
Analog input range		Normal resolution mode		High resolution mode																																	
	Setpoint temperature (T _{sp})	Setpoint temperature (T _{sp})	Setpoint temperature (T _{sp})	Setpoint temperature (T _{sp})																																	
0 to 10V	0 to 4000	±0.2%	0 to 16000	±0.2%																																	
0 to 5V	0 to 2000	±0.2%	0 to 8000	±0.2%																																	
1 to 5V	0 to 2000	±0.2%	0 to 12000	±0.2%																																	

(Example 2) Special relays and registers which are not converted to the Q program

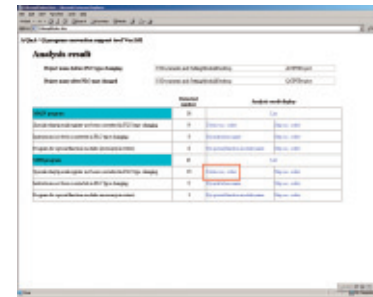

Click "Device no. order" in the "Special relay/special register not been converted in PLC type changing" row.

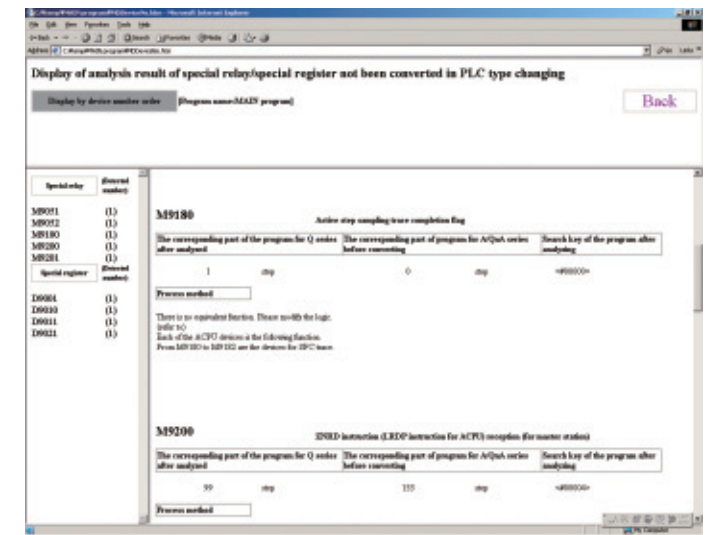

A → Q Conversion Support Tool for Motion Controller

Coming Soon

A support tool for motion controllers, which converts A Series sequence programs into Q Series sequence programs, will be available soon.

1. Displays statements of unconvertible dedicated motion commands

For automatically unconvertible dedicated motion commands such as SVST and CHGA, the original and converted commands are displayed as shown below. The commands contained in the circuit block are displayed one line at a time. [E.g.] %O0001 [SVST J1 KO] → OUT SM1255 ("%O0001" is a search keyword in the review information list.)

2. Displays statements of dedicated motion devices

For dedicated motion devices such as start receipt flag M2001, a message requesting review is displayed.

3. Converts SW3RN-LADDERP format comment files to GX Developer format

For A/QnA Large Type Series

NEW

QA65B-E/QA68B-E Extension Base Unit

Replacing the CPU with a QCPU while using existing modules.

The A (Large type) Series can be replaced with the Q Series step by Step.

●The QA6□B-E type extension base units enable to utilize existing A (large type) Series modules. Just mounting the existing modules on the extension base unit and connecting it to the Q Series, a new system controlled by Q Series CPU can be constructed! Also, the modules can be replaced step by step depending on your needs. As shown in the Step 2, you can have the complete Q Series system configuration eventually.

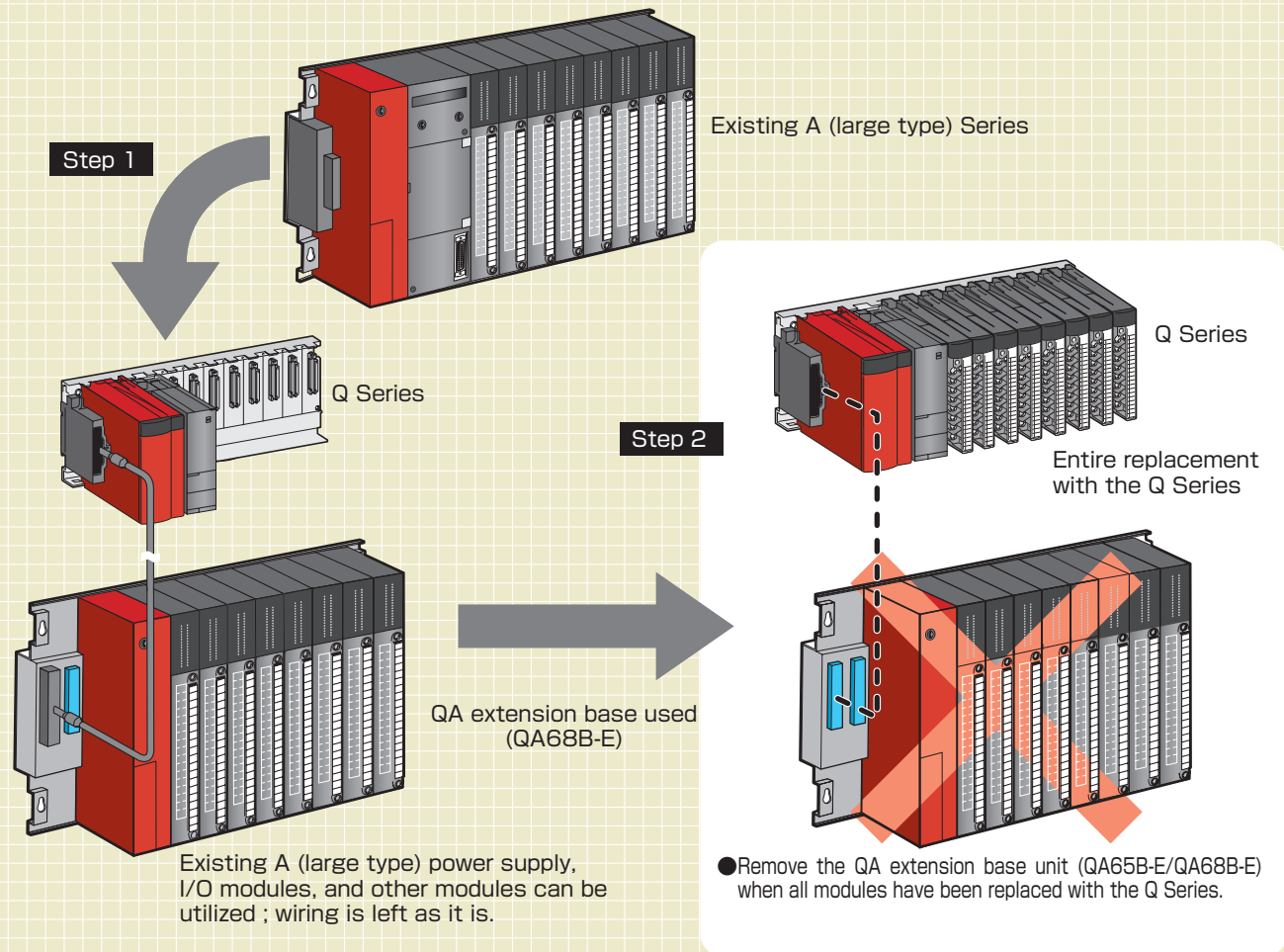

- The QA6□B-E type extension base units are compatible with High-performance CPUs only. Basic model CPUs, Process CPUs, and Redundant CPUs do not have compatibility.
- Please refer to the "QA65B/QA68B Extension Base Unit User's Manual (IB-0800158)" for details of modules that can be mounted on the QA6□B-E type extension base unit.

For AnS/Q2AS Small Type Series **QA1S65B-E/QA1S68B-E Extension Base Unit**

Now Available

- The AnS/Q2AS small type Series modules can also be used by connecting as a QCPU extension base.
- These extension base units can be used with QA65B-E and QA68B-E type units.

For A/QnA Large Type Series

NEW

A-A1S Module Conversion Adapter (A1ADP-XY: For I/O Module, A1ADP-SP: For Special Function Module)

Using small type modules when additional modules are required for A/QnA System modifications.

If only small number of I/O points are to be added, and there are empty slots on the base unit:

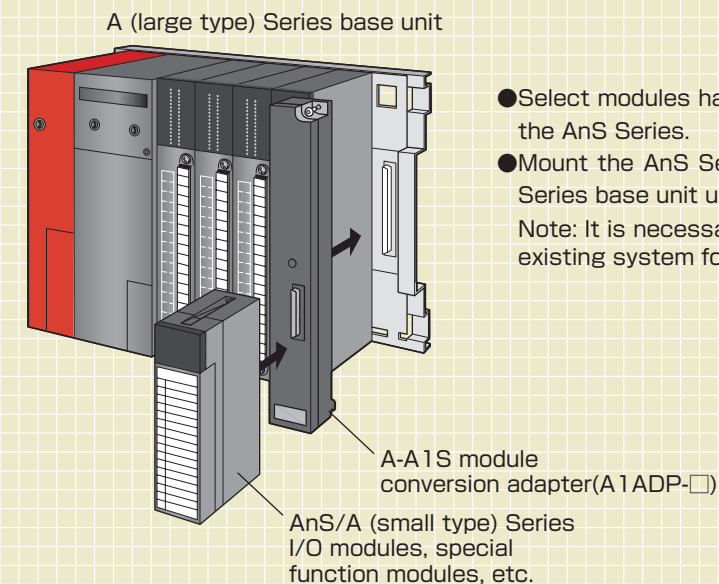

- Select modules having necessary functions for the modifications from the AnS Series.
 - Mount the AnS Series module on an empty slot of the A (large type) Series base unit using the A-A1S module conversion adapter.
- Note: It is necessary to have empty slots and enough I/O points in the existing system for the modifications.

If large number of I/O points are to be added, or there are no empty slots on the base unit:

- Select modules having necessary functions for the modifications from the CC-Link lineup.
- Remove one/or some existing modules from A (large type) Series base unit to mount the AnS Series CC-Link system master/local station modules.
- Mount the AnS Series CC-Link system master/local station module on the empty slot of the A (large type) Series base unit using the A-A1S module conversion adapter.
- To replace functions of the removed modules, add modules on the CC-Link remote I/O.

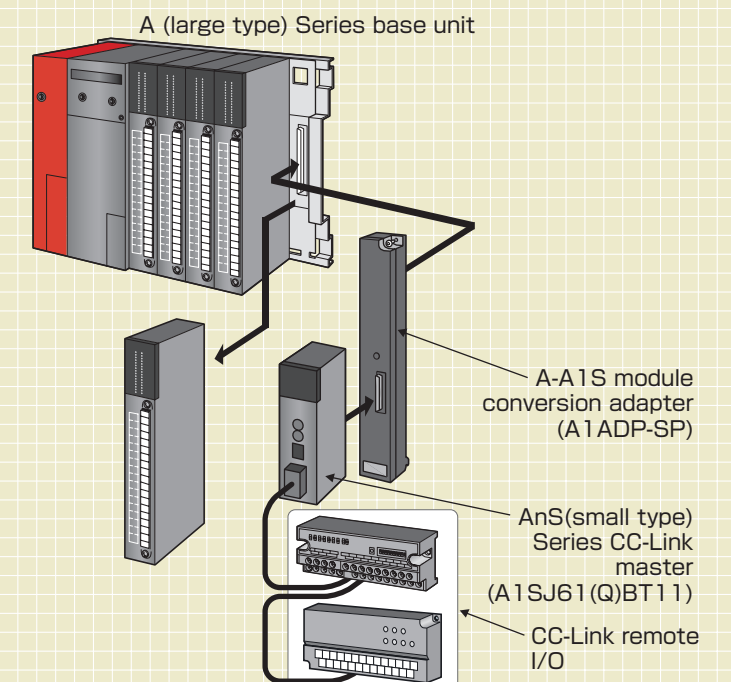

AnS (Small type) local station dedicated module Spring, 2007 Available

Q Series can be added to the existing MELSECNET (II), enabling to share link data.

The Q Series can be added to the existing MELSECNET (II) as a local station.

Mount the AnS local station dedicated module on the Q Series QA1S6□B-E extension base unit to connect to the MELSECNET(II) system.
(The QA1S6□B-E type extension base unit are compatible with High-performance CPUs, Process CPUs, Redundant CPUs do not have compatibility.)

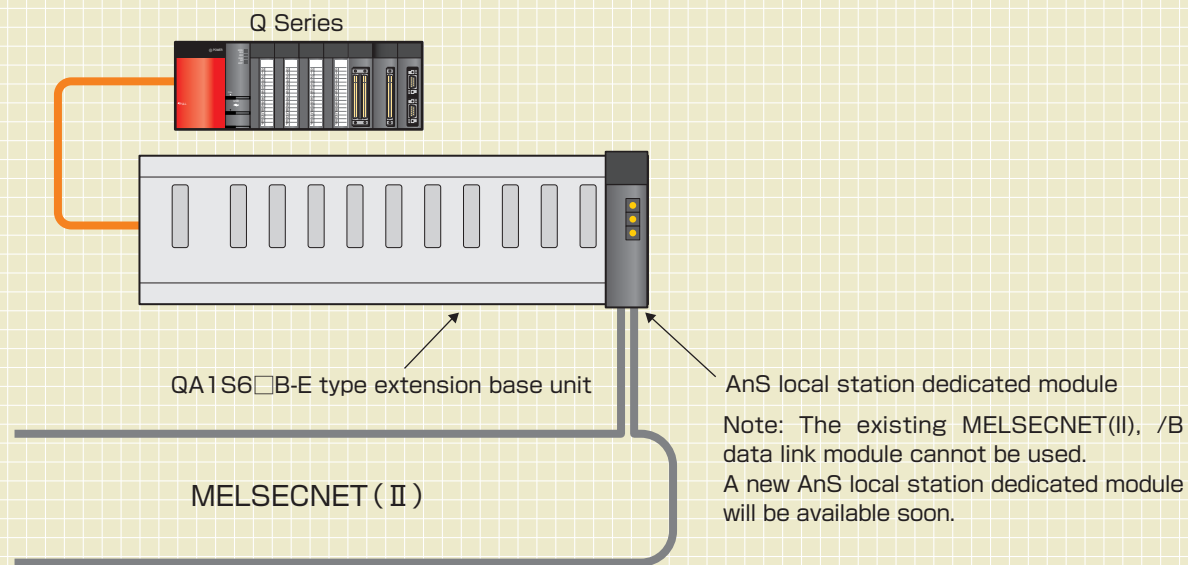

Example of MELSECNET (II) configuration incorporating the Q Series

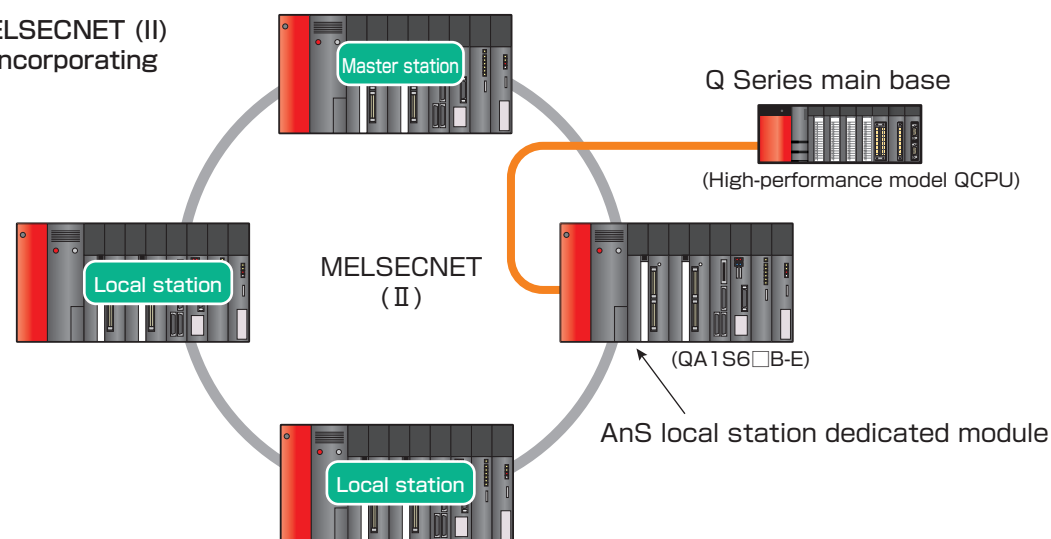

MELSECNET(II), MELSECNET/10 gateway set Q6KT-NETGW-□□ Fall, 2006 Available

Replacing the existing MELSECNET (II) with the Q Series MELSECNET/10 step by step.

Part of the existing MELSECNET (II) can be replaced with the Q Series MELSECNET/10, and data is shared via a gateway station.

(Example) Partial replacement of MELSECNET (II), from A (large type) Series PLCs to Q Series PLCs

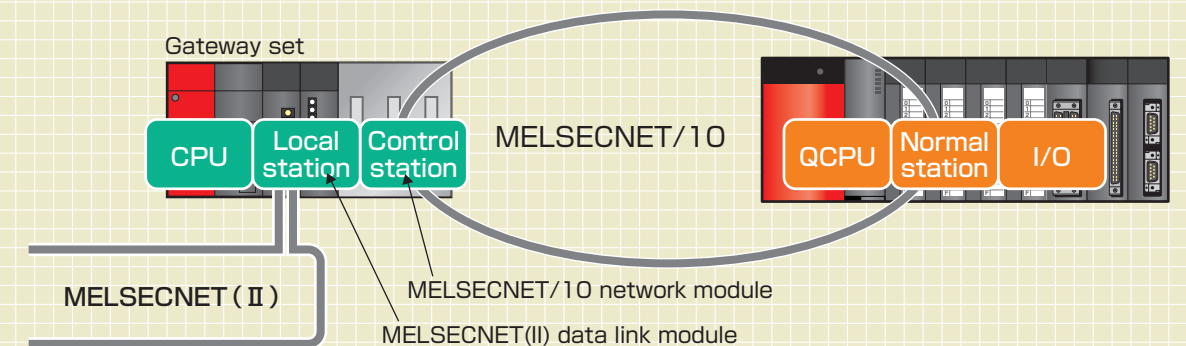

Step-by-step replacement with the Q Series

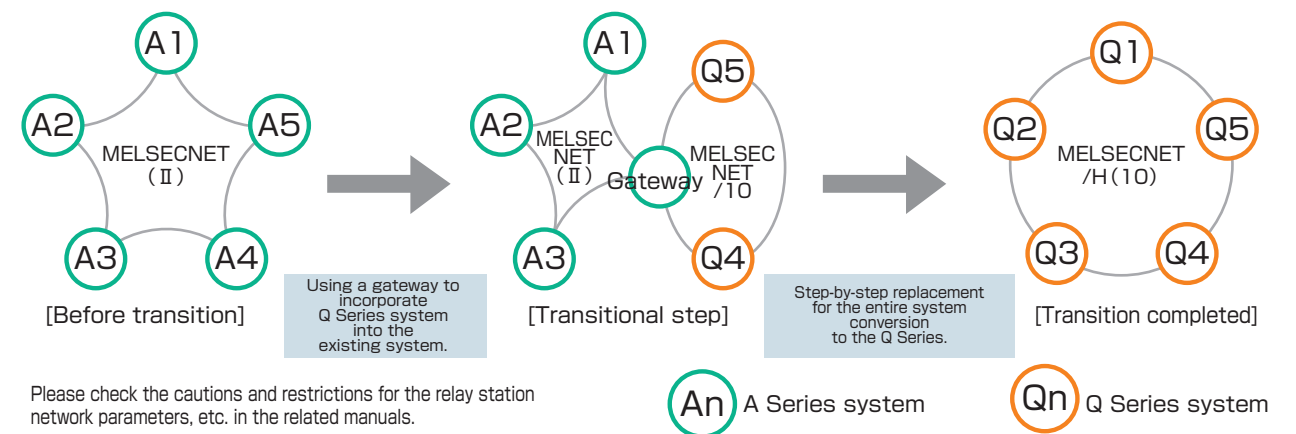

Please check the cautions and restrictions for the relay station network parameters, etc. in the related manuals.

Gateway set model list

Set model name	Main part			NET (II)/B part	NET/10 part
Q6KT-NETGW-SS	A1S35B	A1S61PN	Q2ASCPU	A1SJ71AP21	A1SJ71QLP21
Q6KT-NETGW-GS				A1SJ71AP21-S3	A1SJ71QLP21
Q6KT-NETGW-RS				A1SJ71AR21	A1SJ71QLP21
Q6KT-NETGW-RB				A1SJ71AT21B	A1SJ71QBR11
Q6KT-NETGW-TS					A1SJ71QLP21
Q6KT-NETGW-TB					A1SJ71QBR11

Reading the model name	Q6KT-NETGW-□□ Gateway Set	①	②	① Network type: MELSECNET(II)	② Network type: MELSECNET/10
		S	G	S: SI optical fiber cable (double loop)	S: SI optical fiber cable (double loop)
		R	T	G: GI-50/125 optical fiber cable (double loop)	B: Coaxial cable (bus)
				R: Coaxial cable (double loop)	
				T: Twisted pair cable (bus)	

MELSECNET/10 Network Module (Production continues)

Replacing with the MELSECNET/10 system all at once using existing wiring for MELSECNET (II) system.

Step-by-step transition to the Q Series system, mixing A Series and Q Series systems.

The entire MELSECNET(II) system is replaced with a MELSECNET/10 system while using existing wiring. Then the ACPUs can be replaced with the QCPUs step by step.
 Note: The MELSECNET/B system cannot be replaced because it uses twisted pair cables.

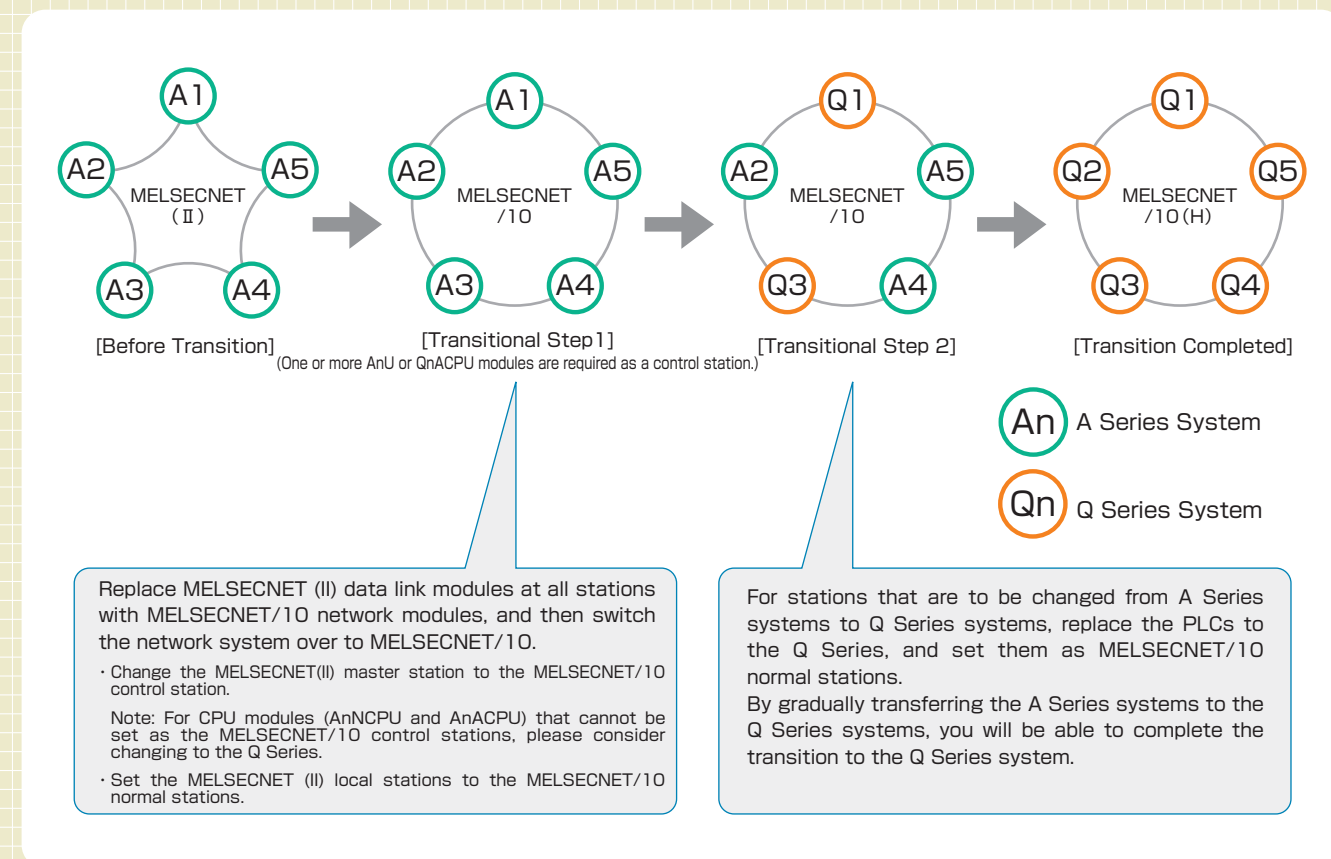

Production of A/QnA (Large type) CPU compatible MELSECNET/10 network modules will be continued. Please refer to the "Additional Support" section on page 15 for details.

Available Soon TBA(To be announced)

A0J2(H) Interface Terminal

Replacing only the CPU module with the QCPU using existing wiring.

■Interface terminal allowing the use of the A0J2(H) Series I/O module wiring
 At the replacement with the Q Series system, existing wiring can be used for the interface terminal without modification.

■Interface terminal
 The interface terminal contains internal relays and has functions for converting DC output to relay output and AC input to DC input. Therefore, it can be replaced in combination with a Q Series FCN connector type DC I/O module. To connect the interface terminal and an alternative module, use a cable for connection between MIL and FCN connectors.

(Example) Replacing A0J2(H) Series I/O module with a "Q Series I/O module and interface terminal".

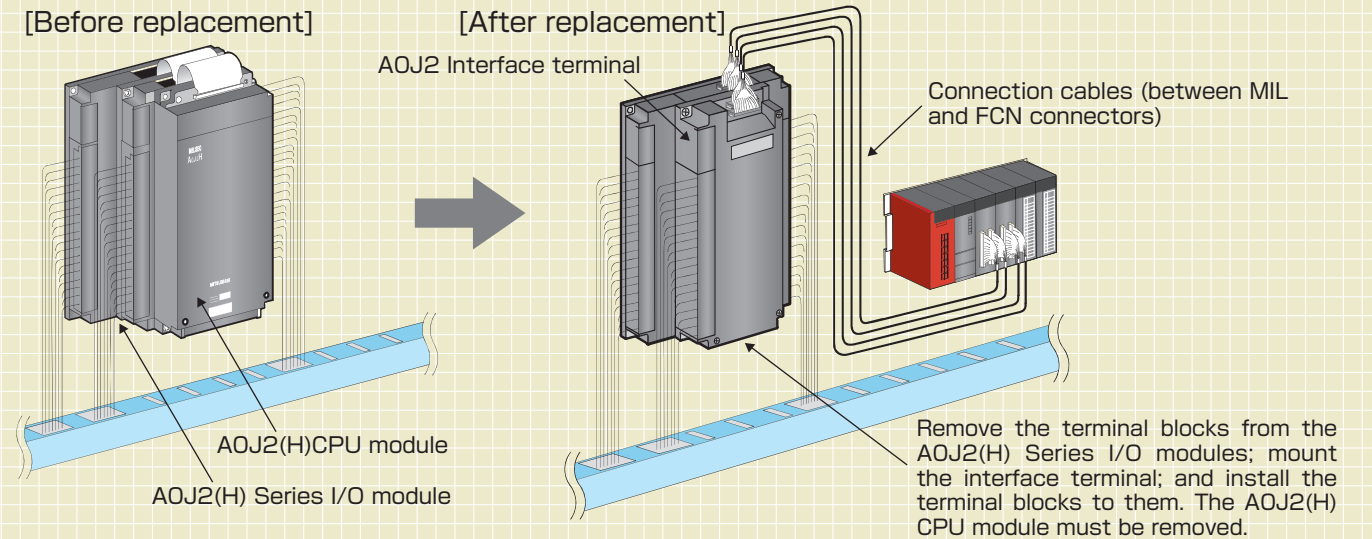

■Replacing with AnS and CC-Link is also possible.
 In addition to the Q Series, it is also possible to replace with the AnS (small type) Series and CC-Link FCN connector type DC I/O module.

Model list

Discontinued model		Alternative model		Discontinued model		Alternative model	
Product	Model	Alternative module	Interface terminal	Product	Model	Alternative module	Interface terminal
Output module	A0J2-E24R	QY41P	24R interface terminal	I/O module	A0J2-E56AR	QX41+QY41P	56AR interface terminal
		AJ65SBTCF1-32T				QH42P	
		A1SY41				AJ65SBTCF1-32D+AJ65SBTCF1-32T	
QX41+QY41P	A1SX41+A1SY41						
QH42P	A1SH42						
A0J2-E28DR	AJ65SBTCF1-32D+AJ65SBTCF1-32T	28DR interface terminal	QX41+QY41P			A0J2-E56DR	
A1SX41+A1SY41	QH42P						
A1SH42	AJ65SBTCF1-32D+AJ65SBTCF1-32T						
QX41+QY41P	A1SX41+A1SY41						
QH42P	A1SH42						
A0J2-E28DT	AJ65SBTCF1-32D+AJ65SBTCF1-32T	28DT interface terminal	QX41+QY41P		A0J2-E56DT		56DT interface terminal
A1SX41+A1SY41	QH42P						
A1SH42	AJ65SBTCF1-32D+AJ65SBTCF1-32T						
QX41+QY41P	A1SX41+A1SY41						
QH42P	A1SH42						
A1SH42							

MELSECNET/MINI-S3 I/O Module Wiring Conversion Adapter

Available Soon TBA(To be announced)

Replacing with the CC-Link system using existing MELSECNET/MINI-S3 I/O wiring.

Install the wiring terminal block on the CC-Link module to eliminate the need for rewiring.

(Example) Replacing AJ35TB2-16D with AJ65BTB2-16D using a 34-pin conversion adapter

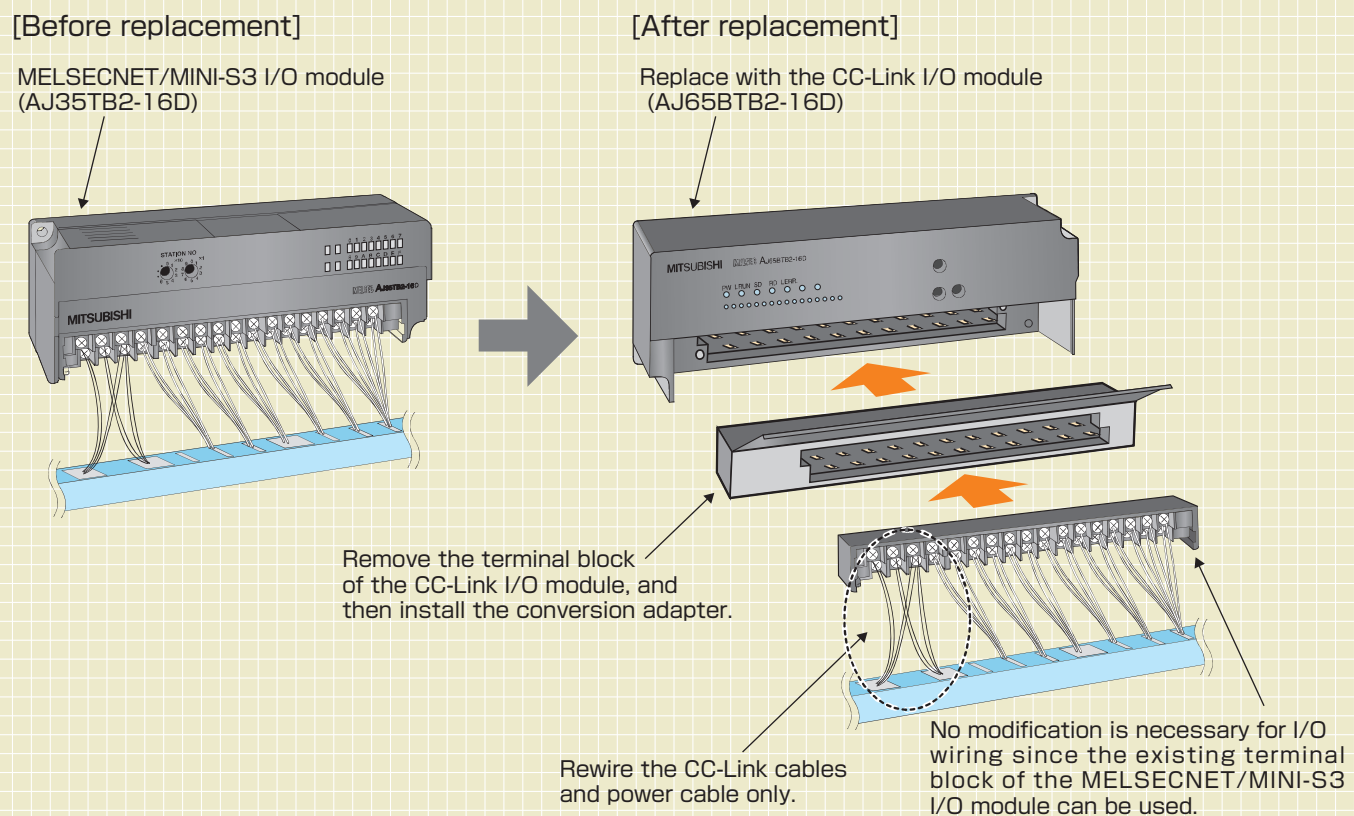

Model list

Discontinued model		Alternative model		Remarks (Restrictions)
Product	Model	Model		
		Alternative module	Conversion adapter	
Input module	AJ35TB1-16D	AJ65BTB1-16D	26-pin conversion adapter*1	*1 The total size is increased due to addition of the adapter to the alternative module. *2 Additional wiring to CTL+(External power supply for output) is required.
	AJ35TB2-16D	AJ65BTB2-16D	34-pin conversion adapter*1	
Output module	AJ35TB1-16T	AJ65BTB1-16T	26-pin conversion adapter *1.*2	

Upgrade Tool

(Manufactured by Mitsubishi Electric Engineering Co., Ltd.)

Replacing with the Q Series base unit using existing wiring.

The upgrade tool consists of two parts: a conversion adapter to connect existing wiring of A (large type) Series I/O modules to Q Series I/O modules; and a base adapter to mount Q Series base unit, including a supporting part to secure the bottom of the conversion adapters.

- Remove the entire A (large type) Series base unit and mount the base adapter in the same position. The existing mounting holes for the A (large type) Series base unit can be used to mount the base adapter, without having to make new installation holes.
- Mount a Q Series base unit on the base adapter.
- Attach the conversion adapters to the Q Series I/O modules.
- Remove the terminal blocks from the existing A(large type) Series I/O modules and mount the terminal blocks on the conversion adapters. (The existing wiring can be used without modification.)

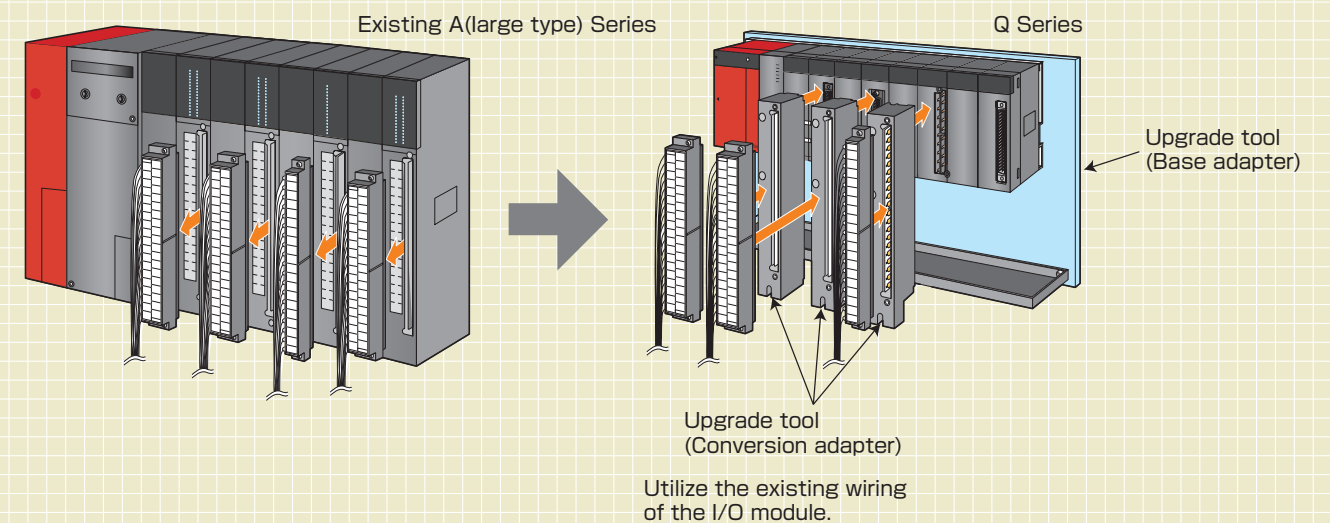

Please refer to the "Related Catalog" under the "Additional support" section on page 16 for details.

Additional Support

Offering a variety of replacement support

Global FA Centers

"Mitsubishi Global FA Centers" are located throughout North America, Europe, and Asia to develop products complying with international standards and to provide attentive services.



North American FA Center
 MITSUBISHI ELECTRIC AUTOMATION, INC.
 500 Corporate Woods Parkway, Vernon Hills, IL60061 U.S.A.
 Telephone +1-847-478-2100/Fax +1-847-478-2396
 Area covered: North America, Mexico



Shanghai FA Center
 MITSUBISHI ELECTRIC AUTOMATION (SHANGHAI)LTD.
 1-3F Block5, 103
 Cao Bao Road, Shanghai 200233, China
 Telephone +86-21-6121-2460/Fax +86-21-6121-2424
 Area covered: China



European FA Center
 MITSUBISHI ELECTRIC EUROPE B.V. GERMAN BRANCH
 (Industrial Automation Division)
 Gothaer Strasse 8, D-40880 Ratingen, Germany
 Telephone +49-2102-486-0/Fax +49-2102-486-7170
 Area covered: Europe



Beijing FA Center
 MITSUBISHI ELECTRIC AUTOMATION (SHANGHAI)LTD.,
 BEIJING OFFICE
 Unit917-918, 9/F Office Tower 1, Hensudon Center, 18
 Jianguomennei Dajie, Dongcheng District, Beijing 100005, China
 Telephone +86-10-6518-8830/Fax +86-10-6518-8030
 Area covered: China



UK FA Center
 MITSUBISHI ELECTRIC EUROPE B.V. UK BRANCH
 (Customer Technology Center)
 Travellers Lane, Hatfield, Hertfordshire, AL10 8XB, UK
 Telephone +44-1707-276100/Fax 44-1707-278992
 Area covered: UK, Ireland



Taipei FA Center
 SETSUYO ENTERPRISE CO.,LTD.
 6F No.105 Wu-Kung 3rd RD, Wu-ku Hsiang, Taipei Hsiene, Taiwan
 Telephone +886-2-2299-2499/Fax +866-2-2299-2509
 Area covered: Taiwan



Korean FA Center
 MITSUBISHI ELECTRIC AUTOMATION KOREA CO.,LTD.
 Dong Seo Game Channel Building 2F,
 660-11 Deungchon-Dong, Kangseo-Ku, Seoul 157-030, Korea
 Telephone +82-2-3660-9607/Fax +82-2-3663-0475
 Area covered: Korea



Taichung FA Center
 SETSUYO ENTERPRISE CO.,LTD.
 7F-7, No.77, Zheng Bei 1 st RD, Taichung City, Taiwan
 Telephone +886-4-2258-1027/Fax +866-4-2252-0967
 Area covered: Taiwan



Hong Kong FA Center
 MITSUBISHI ELECTRIC AUTOMATION (HONG KONG)LTD.
 10/F., Manulife Tower, 169 Electric Road, North Point,
 Hong Kong
 Telephone +852-2887-8870/Fax +852-2887-7984
 Area covered: China



ASEAN FA Center
 MITSUBISHI ELECTRIC ASIA PTE,LTD.
 307 Alexandra Road #05-01/02
 Mitsubishi Electric Building Singapore, 159943
 Telephone +65-6470-2480/Fax +65-6476-7439
 Area covered: Southeast Asia, India



Tianjin FA Center
 MITSUBISHI ELECTRIC AUTOMATION (SHANGHAI)LTD.
 TIANJIN OFFICE
 Room No.909,Great Ocean Building,
 No.200 Shi Zi Lin Avenue,
 He Bei District, Tianjin 300143 China
 Telephone +86-22-26359090/Fax +86-22-26359050
 Area covered: China

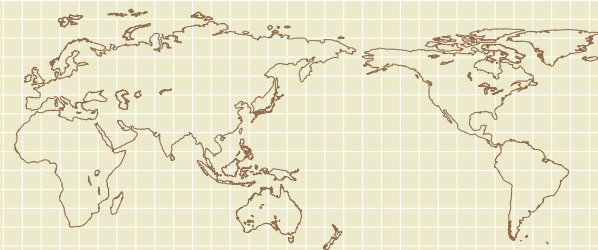

Related Catalog



Upgrade Tool

- Convenient tool for upgrading the MELSEC-A Series to the MELSEC-Q Series
- Easy replacement with the MELSEC-Q Series
 - Greatly reduced time and cost for wiring to I/O modules
 - Existing PLC programs can be reused.
 - Also helpful for upgrading as a total system

Additional Support

Production Discontinuation Schedule

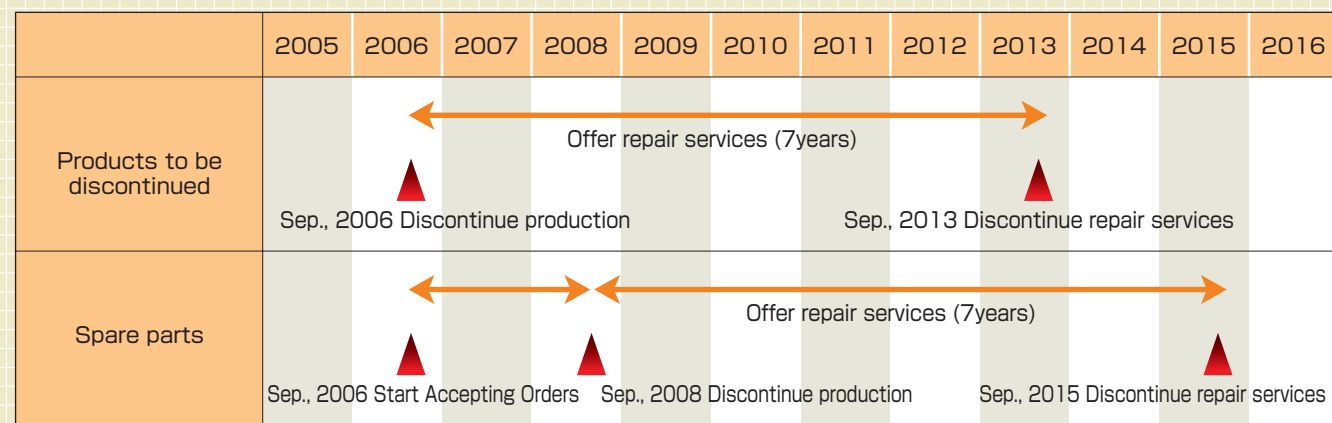

Models to be discontinued

Models to be discontinued			Production discontinuation
Large type A Series/ Large type QnA Series	A/QnA (Large type)	● CPU module ● I/O module ● Special function module ● Data link module (MELSECNET (II), / B module etc.)	End of Sep. 2006
A2C Series	A2C	● CPU module	End of Sep. 2006
		● A2C I/O module ● Special function module etc.	End of Sep. 2008
PC interface boards	MELSECNET (II), /B	● MELSECNET (II), / B interface board	End of Sep. 2008
Small type AnS Series	MELSECNET (II), /B*1	● Remote I/O module	End of Sep. 2008
	MELSECNET/MINI-S3	● AnS (Small type) master module ● I/O module	End of Sep. 2008
AOJ2 (H) Series	AOJ2 (H)	● CPU module ● Power supply module ● I/O module ● Special function module etc.	End of Sep. 2008

*1 : Production of AnS Series master/local station data link modules (A1SJ71AP21, A1SJ71AR21, and A1SJ71AT21B) will be continued.

Exceptions

Models to be continued

Although most of the A/QnA (Large type) Series products are discontinued in September, 2006, production of the following modules will be continued.

Note: In accordance with the continuation of production, model names may be changed.

Power supply module

Product Name	Model Name
A/QnA (Large type) Series power supply module	A61P, A63P, A61RP

If using power supplies other than the above, please purchase spare parts or consider switching over to one of the above models.

MELSECNET/10 network module

Product Name	Model Name	
	Control/Normal Station	Remote I/O Station
A/QnA (Large type) Series MELSECNET/10 network module	AJ71BR11 AJ71LP21 AJ71LP21G AJ71LR21 AJ71QBR11 AJ71QLP21 AJ71QLP21G AJ71QLP21S AJ71QLR21	AJ72BR15 AJ72LP25 AJ72LP25G AJ72LR25 AJ72QBR15 AJ72QLP25 AJ72QLP25G AJ72QLR25

Spare parts

Production of certain models as spare parts will be extended until the end of September, 2008. Please refer to the Technical Bulletin (T99-0050F) for more information.

Note: In accordance with the continuation of production, model names may be changed.

Mitsubishi PLC MELSEC-A/QnA (Large Type) Upgrade Catalog

Precautions for Choosing the Products

This catalog explains the typical features and functions of the Q series PLCs and does not provide restrictions and other information on usage and module combinations. When choosing the products, always check the detailed specifications, restrictions, etc. of the products in the Q series data book. When using the products, always read the user's manuals of the products.

Mitsubishi will not be held liable for damage caused by factors found not to be the cause of Mitsubishi; machine damage or lost profits caused by faults in the Mitsubishi products; damage, secondary damage, accident compensation caused by special factors unpredictable by Mitsubishi; damages to products other than Mitsubishi products; and to other duties.

For safe use

- To use the products given in this catalog properly, always read the "manuals" before starting to use them.
- This product has been manufactured as a general-purpose part for general industries, and has not been designed or manufactured to be incorporated in a device or system used in purposes related to human life.
- Before using the product for special purposes such as nuclear power, electric power, aerospace, medicine or passenger movement vehicles, consult with Mitsubishi.
- This product has been manufactured under strict quality control. However, when installing the product where major accidents or losses could occur if the product fails, install appropriate backup or failsafe functions in the system.

Country/Region	Sales office	Tel/Fax
U.S.A	Mitsubishi Electric Automation Inc. 500 Corporate Woods Parkway Vernon Hills, IL 60061	Tel : +1-847-478-2100 Fax : +1-847-478-2396
Brazil	MELCO-TEC Rep. Com.e Assessoria Tecnica Ltda. Rua Correia Dias, 184, Edificio Paraiso Trade Center-8 andar Paraiso, Sao Paulo, SP Brazil	Tel : +55-11-5908-8331 Fax : +55-11-5574-5296
Germany	Mitsubishi Electric Europe B.V. German Branch Gothaer Strasse 8 D-40880 Ratingen, GERMANY	Tel : +49-2102-486-0 Fax : +49-2102-486-7170
U.K	Mitsubishi Electric Europe B.V. UK Branch Travellers Lane, Hatfield, Herts., AL10 8XB,UK	Tel : +44-1707-276100 Fax : +44-1707-278992
Italy	Mitsubishi Electric Europe B.V. Italian Branch VIALE COLLEONI 7-20041 Agrate Brianza(Milano),Italy	Tel : +39-039-60531 Fax : +39-039-6053312
Spain	Mitsubishi Electric Europe B.V. Spanish Branch Carretera de Rubi 76-80 E-08190 Sant Cugat del Valles(Barcelona), Spain	Tel : +34-93-565-3131 Fax : +34-93-589-2948
France	Mitsubishi Electric Europe B.V. French Branch 25 Boulevard des Bouvets, F-92741 Nanterre Cedex, France	Tel : +33-1-5568-5568 Fax : +33-1-5568-5685
South Africa	Circuit Breaker Industries LTD Private Bag 2016, 1600 Isando, Tripswitch Drive, Elandsfontein Gauteng, South Africa	Tel : +27-11-928-2000 Fax : +27-11-392-2354
Hong Kong	Mitsubishi Electric Automation (Hong Kong) Ltd. 10th Floor, Manulife Tower, 169 Electric Road, North Point, HongKong	Tel : +852-2887-8870 Fax : +852-2887-7984
China	Mitsubishi Electric Automation (Shanghai) Ltd. 4/F Zhi Fu Plazz, No.80 Xin Chang Road, Shanghai 200003 CHINA	Tel : +86-21-6120-0808 Fax : +86-21-6121-2424
Taiwan	Setsuyo Enterprise Co., Ltd. 6F., No.105 Wu-Kung 3rd.RD, Wu-Ku Hsiang, Taipei Hsine, Taiwan	Tel : +886-2-2299-2499 Fax : +886-2-2299-2509
Korea	Mitsubishi Electric Automation Korea Co., Ltd. B1F, 2F, 1480-6, Deungchon-Dong, Kangseo-Ku, Seoul, 157-200, Korea	Tel : +82-2-3660-9552 Fax : +82-2-3664-8372
Singapore	Mitsubishi Electric Asia Pte, Ltd. 307 Alexandra Road #05-01/02, Mitsubishi Electric Bulding Singapore 159943	Tel : +65-6470-2480 Fax : +65-6476-7439
Thailand	F.A.Tech Co., Ltd. 896/19, 20, 21, 22,S.V. City Building, office Tower1, Floor 12 Rama III Rd, Bangpongpan, Yannawa, Bangkok 10120	Tel : +66-2-682-6522 Fax : +66-2-682-6020
Indonesia	Indonesia P.T. Autoteknindo SUMBER MAKMUR Muara Karang Selatan Block A/Utara No.1 Kav. No.11 Kawasan Industri/Pergudangan Jakarta-Utara 14440	Tel : +62-21-663-0833 Fax : +62-21-663-0832
India	Messung Systems Pvt, Ltd. Electronic Sadan NO: III Unit No15, M.I.D.C Bhosari, Pune-411026, India	Tel : +91-20-2712-3130 Fax : +91-20-2712-8180
Australia	Mitsubishi Electric Australia Pty. Ltd. 348 Victoria Road, Rydalmere, N.S.W 2116, Australia	Tel : +61-2-9684-7777 Fax : +61-2-9684-7245

 **MITSUBISHI ELECTRIC CORPORATION**

HEAD OFFICE: TOKYO BUILDING, 2-7-3 MARUNOUCHI, CHIYODA-KU, TOKYO 100-8310, JAPAN
NAGOYA WORKS: 1-14,YADA-MINAMI 5,HIGASHI-KU,NAGOYA,JAPAN

When exported from Japan, this manual does not require application to the Ministry of International Trade and Industry for service transaction permission.