

Softstart

**Dimension drawing**

**PS A18...60**

**PS D75...840**

**PS DH30...720**

5309 716-1 Rev1 Dec-01

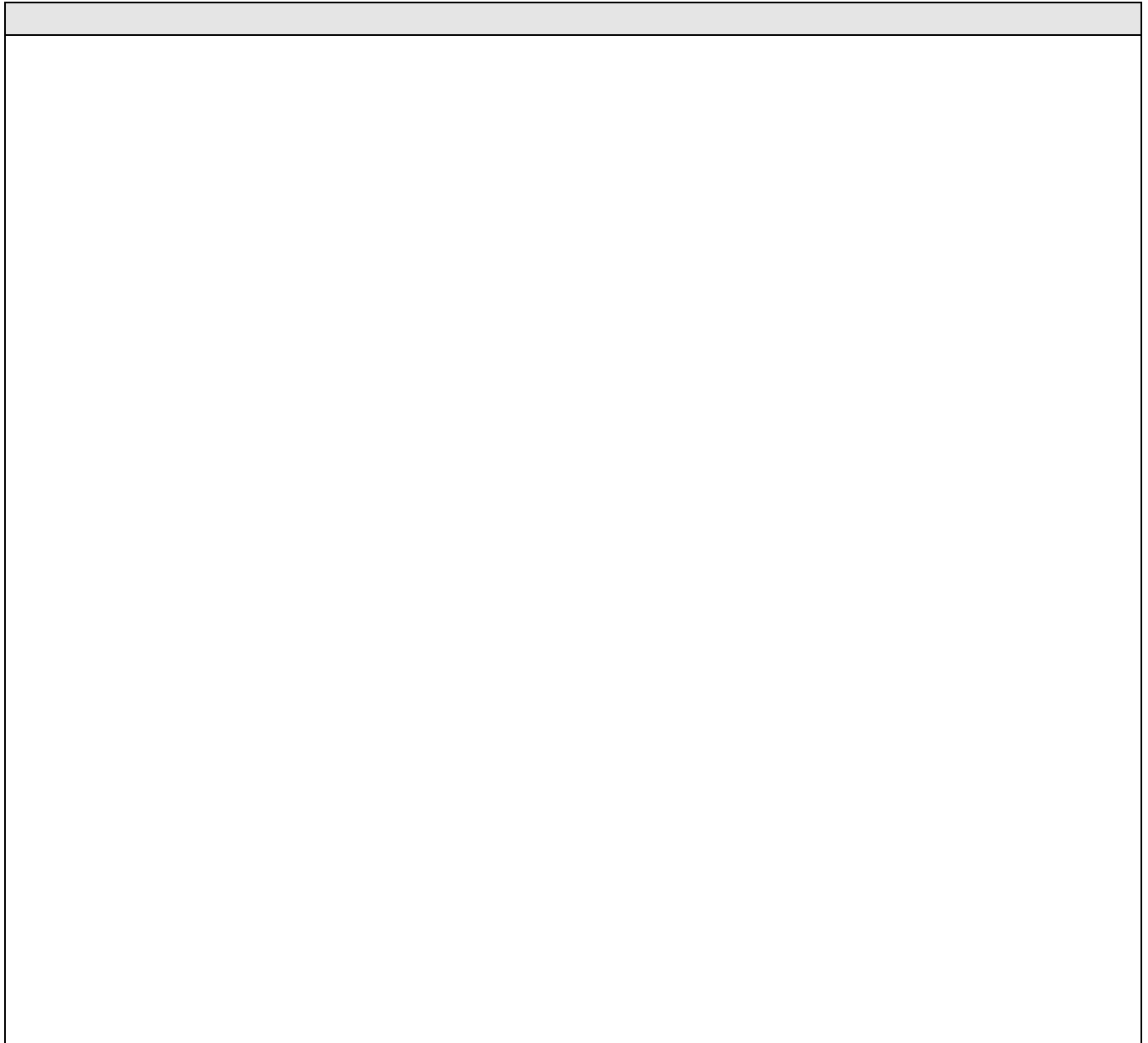

PS A18 ... 60

Rev ind	Revision	Appd	Year	Week
4	Justerad	TP	93	18
2	Text justerad	TP	93	36

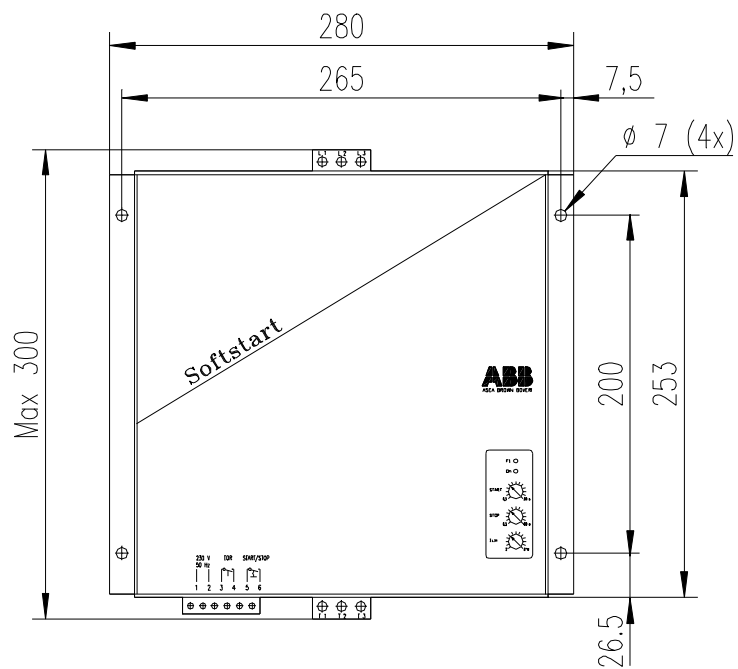
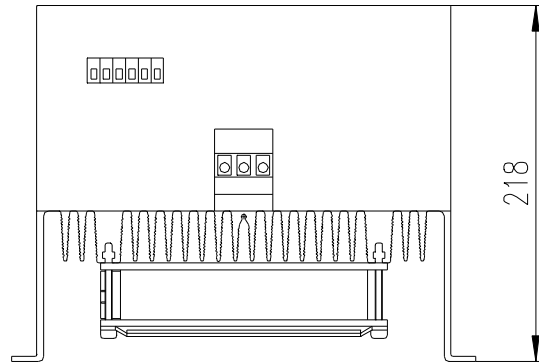

T Persson	P Q	SECRL/BM	Soft starter	
T Persson	921126		Mjukstartare	82
2		2839	Scale 1:4	-
			ISSUED	1

5366 147-1

PS D30 ... 60

Rev ind	Revision	Appd	Year	Week
4	Justerad	TP	93	18

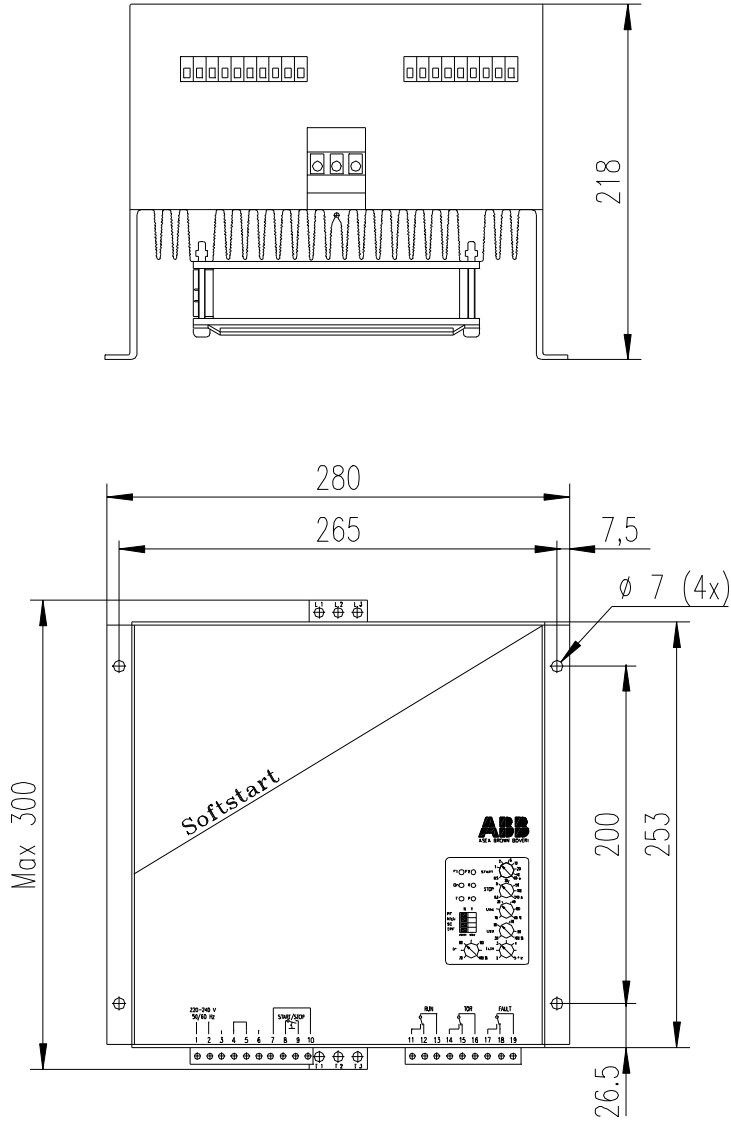

T Persson	P Q	SECRL/BM	Soft starter	
T Persson	921126		Mjukstartare	82
4		2840	Scale 1:4	-
			5366 147-2	1
			ISSUED	

PS D75  
PS DH30 ... 60

Rev ind	Revision	Appd	Year	Week
5	Justerad	TP	93	19
6	M?tt 260 var 200	TP	93	36

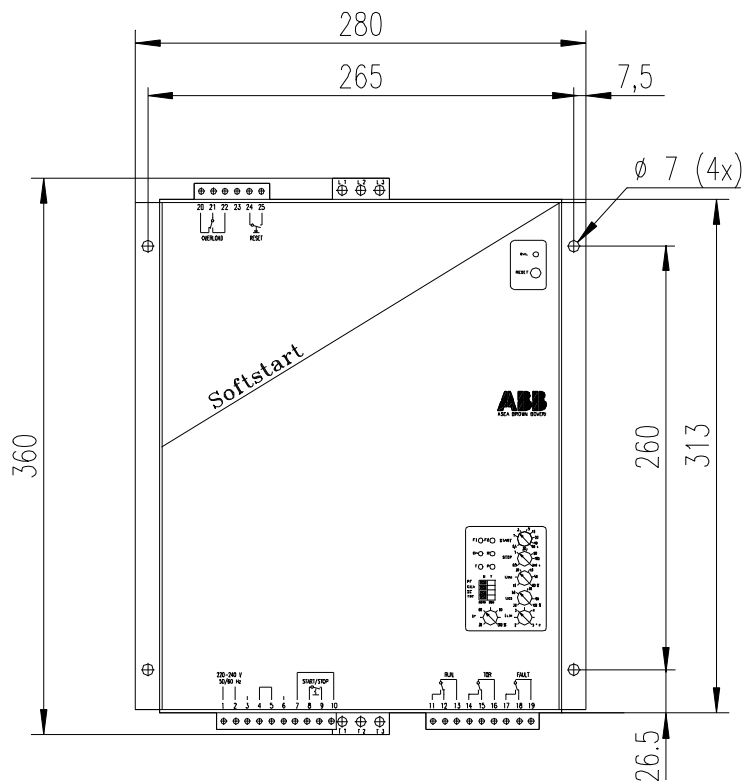
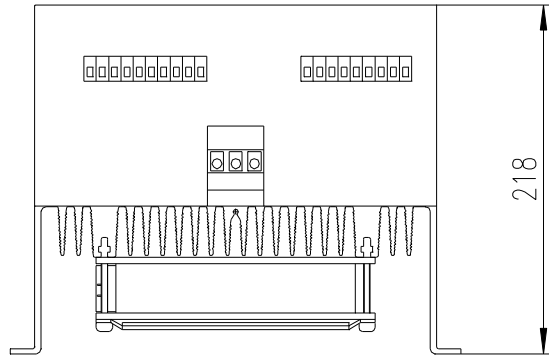

T Persson	P Q	SECRL/BM	Soft starter	
T Persson	921126		Mjukstartare	82
6		2841	Scale 1:4	-
			ISSUED	1

5366 147-3

PS D110 ... 145  
 PS DH75 ... 110

Rev ind	Revision	Appd	Year	Week
5	Justerad	TP	93	19
6	M?tt 260 var 200	TP	93	36

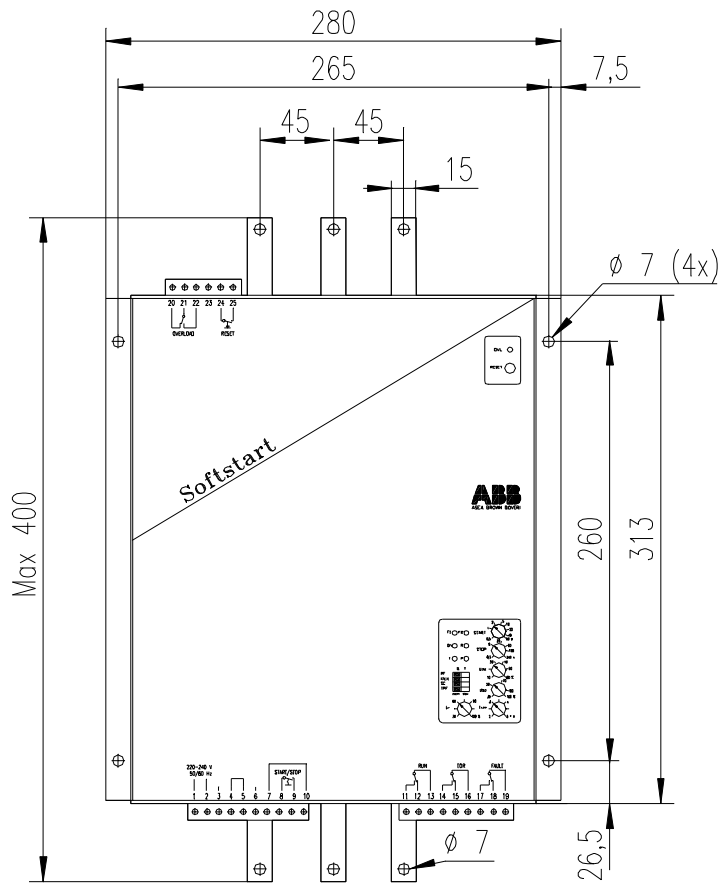
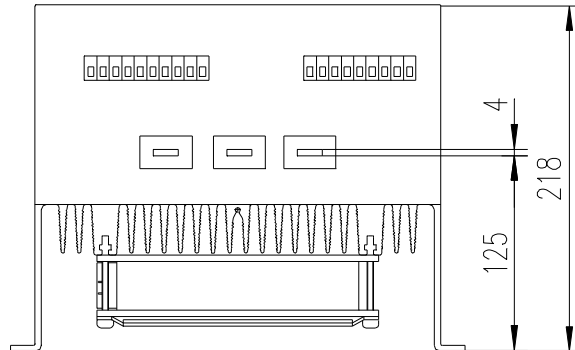



T Persson	<sup>I</sup> P <sup>I</sup> Q	SECRL/BM	Soft starter	
T Persson	921126		Mjukstartare	82
6		2842	Scale 1:4	-
			5366 147-4	1
			ISSUED	

PS D175 ... 300  
 PS DH145 ... 250

Rev ind	Revision	Appd	Year	Week
6	Justerad	TP	93	52
7	Djup 310 var 360	PEA	94	28

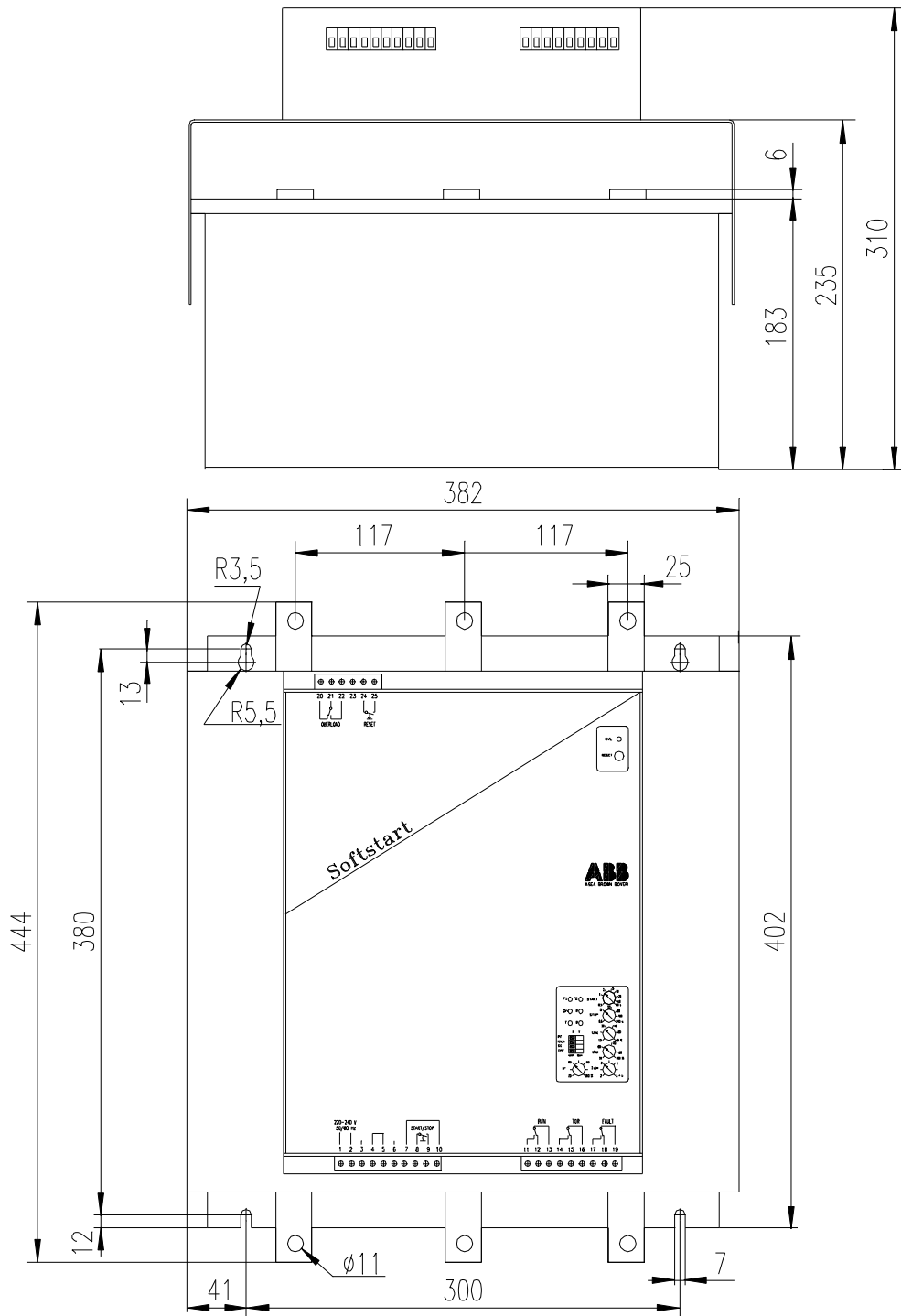
We reserve all rights in this document and in the information contained therein. Reproduction, use or disclosure to third parties without express authority is strictly forbidden. © ABB Control



Prepared T Persson	P Q	Responsible department SECR/L/BM	Title Soft starter	
Approved T Persson	921127	Take over department	Mjukstartare	
Revision 7		2843	Scale 1:4	Document No. 5366 147-5
 ABB Control				Cont. - Sheet 1
ISSUED				

(A4)

PS D370 ... 570  
 PS DH300 ... 470

Rev ind	Revision	Appd	Year	Week
8	Justerad	TP	01	49

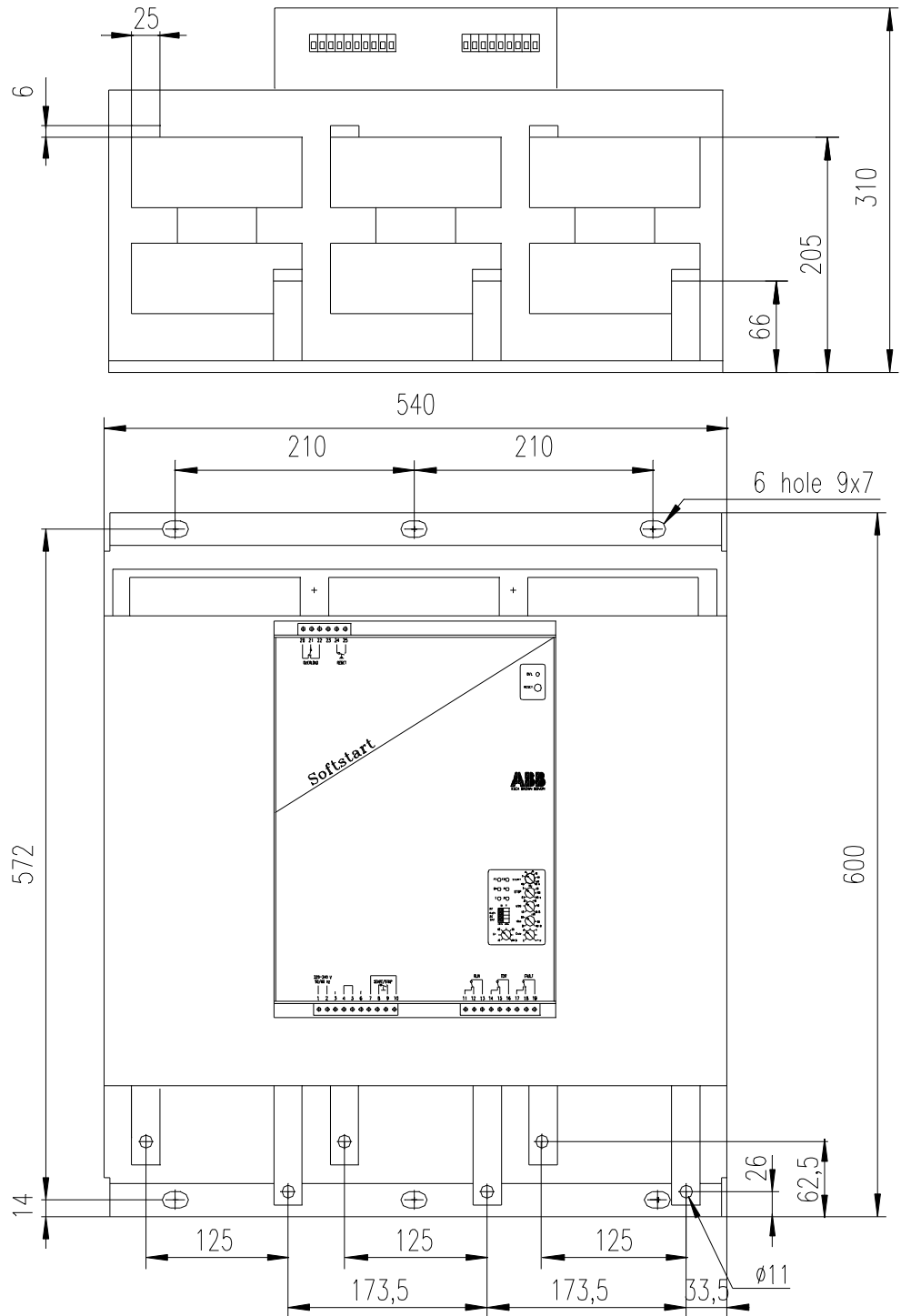

We reserve all rights in this document and in the information contained therein. Reproduction, use or disclosure to third parties without express authority is strictly forbidden. © ABB Control

Prepared T Persson	I P I Q	Responsible department SECRL/BM	Title Soft starter	
Approved T Persson	921127	Take over department	Mjukstartare	Lang. 82
Revision 8		2844	Scale 1:5	Document No. 5366 147-6
ABB Control			ISSUED	Cont. -
				Sheet 1

(A4)

PS D720  
PS DH570

Rev ind	Revision	Appd	Year	Week
1	Justerad	TP	01	49

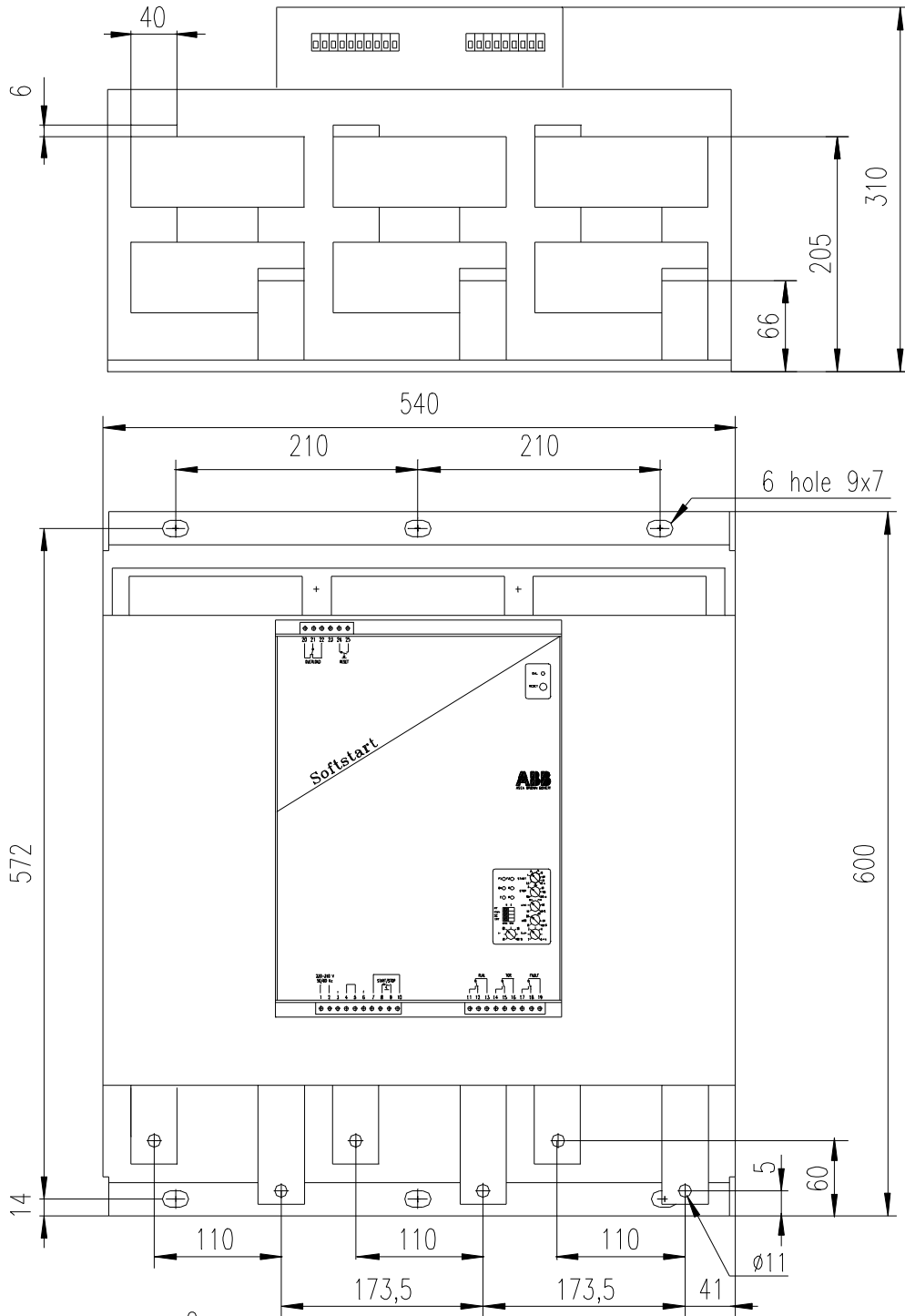

We reserve all rights in this document and in the information contained therein. Reproduction, use or disclosure to third parties without express authority is strictly forbidden. © ABB Control

Prepared T Persson	P Q	Responsible department SECR/L/BM	Title Soft starter	
Approved T Persson	940526	Take over department	Mjukstartare	Lang. 82
Revision 1		3553	Scale 1:5	Cont. -
ABB Control			Document No. <span style="color: green;">5366 147-7</span>	Sheet 1
			ISSUED	

(A4)



PS D840  
PS DH720

Rev ind	Revision	Appd	Year	Week
2	Justerad	TP	01	49

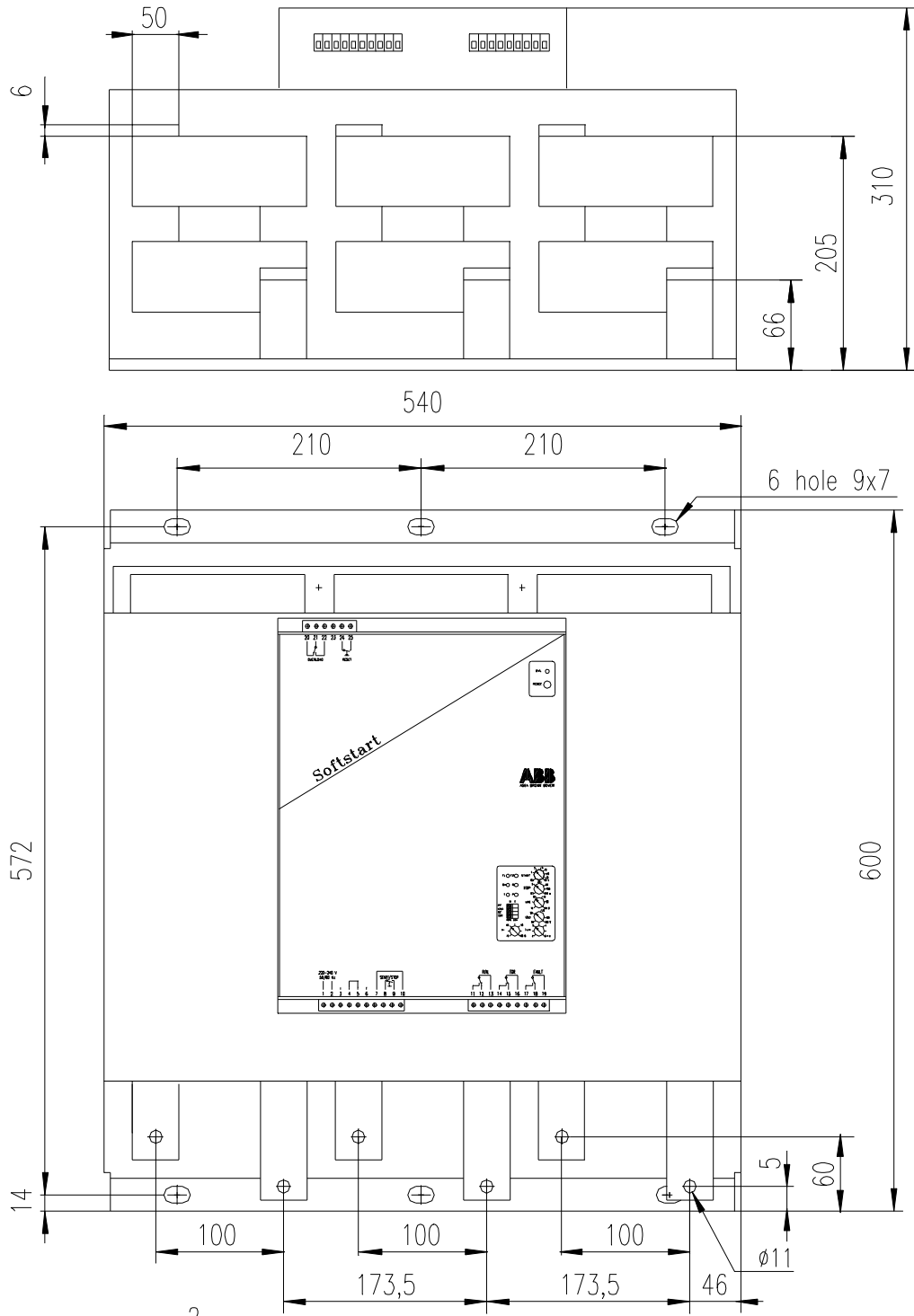

We reserve all rights in this document and in the information contained therein. Reproduction, use or disclosure to third parties without express authority is strictly forbidden. © ABB Control

Prepared I Persson	P Q	Responsible department SECRL/BM	Title Soft starter	
Approved I Persson	940526	Take over department	Mjukstartare	Long. 82
Revision 2		3554	Scale 1:5	Cont. -
ABB Control			Document No. 5366 147-8	Sheet 1
			ISSUED	

(A4)



---

**ABB Automation Technology Products AB, Control**  
S-721 61 Västerås, SWEDEN

Telephone +46 21 32 07 00  
TELEFAX +46 21 12 60 01

53097171.doc