

Equipment for special machines

WF 470
Video Display Module

Description	Edition 08.91
-------------	---------------

--	--

WF 470
Video Display Module

Description

Hardware	2
<hr/>	
Operation	3
<hr/>	
Service	4
<hr/>	
Ordering data and documentation	5
<hr/>	
	6

up to HW Version 6FM1470- ... 25

Edition August 1991

Please note

As it was our aim to provide you with a concise manual for the product in hand, we have refrained from including every single detail about the product types available. It is therefore beyond the scope of this manual to discuss every situation that could arise when commissioning, running and servicing the product.

Should you require additional information, please do not hesitate to contact your nearest Siemens representative.

The contents of this product are not part of an earlier or current agreement, undertaking or contract, nor shall they supersede any such previous arrangements. The obligations of Siemens result from the sales contract in force which also describes the warranty conditions that are valid. The contractual warranty clause is neither extended nor restricted in any way by the contents of this manual.

SIMATIC, SIMODRIVE, SINEC, SINUMERIK, STEP are registered trade marks of Siemens Aktiengesellschaft.

The remaining designations referred to in this manual may be trade marks whose use through third parties for their own purposes may infringe the rights of the owners of the trade mark.

This publication was produced on the Siemens 5800 Office System.

Subject to change without prior notice.

The reproduction, transmission or use of this document or its contents is not permitted without express written authority. Offenders will be liable for damages. All rights, including rights created by patent grant or registration of a utility model or design, are reserved.

© Siemens AG 1994 All Rights Reserved

Contents

	Page
1 Applications	1-1
2 Hardware	2-1
2.1 System configuration	2-1
2.2 WF 470 hardware	2-2
2.3 WF 470 battery back-up buffer	2-5
2.4 Linking the WF 470 to the SIMATIC PLC	2-6
2.4.1 WF 470 configured as a central module	2-6
2.4.2 WF 470 configured as a peripheral module	2-7
2.5 Module location in the SIMATIC rack	2-8
2.5.1 SIMATIC S5-130 WB	2-8
2.5.2 SIMATIC S5-150 S	2-9
2.5.3 SIMATIC S5-115 U	2-10
2.5.4 SIMATIC S5-135 U	2-12
2.5.5 SIMATIC S5-150 U	2-13
2.5.6 SIMATIC S5-155 U	2-14
2.6 Memory addressing	2-15
2.6.1 SIMATIC S5-130 WB	2-15
2.6.2 SIMATIC S5-150 S	2-16
2.6.3 SIMATIC S5-115 U	2-17
2.6.3.1 S5-115U-CPU941	2-17
2.6.3.2 S5-115U-CPU942/943/944	2-17
2.6.4 SIMATIC S5-135 U	2-18
2.6.5 SIMATIC S5-150 U	2-19
2.6.6 SIMATIC S5-155 U	2-20
2.7 External connections	2-21
2.7.1 BAS-(RGB) monitor connections X3, X4, X5	2-22
2.7.2 TTL monitor interface X6	2-23
2.7.3 Serial interface - base board X7	2-25
2.7.4 Serial interface - Extension board X9	2-26
2.7.5 Sockets for memory modules X10, X20, X30	2-27
2.7.6 Bus connector X 1	2-27

2.8	Connection cables	2-28
2.8.1	WF 470 BAS monitor connectors X3, X4, X5	2-28
2.8.2	Connection cable for socket X6	2-29
2.8.3	Connector X7 - programming unit connection	2-30
2.8.4	Connector X9 - Printer connection	2-31
2.8.5	Colour monitor connection	2-32
2.8.6	WF 470 - TTL monitor (sanyo)	2-33
2.8.7	Connection cable WF 470 - PG 675, PG 685 or PG 750 or WF 470 distribution unit	2-34
2.8.8	WF 470 B/C CABLE FOR PT 88/89	2-35
2.8.8.1	V24-Interface	2-35
2.8.8.2	TTY-Interface	2-35
2.9	Peripheral devices	2-36
2.9.1	Operator's panel	2-36
2.9.2	Report printer	2-38
2.9.2.1	V24 interface SAP-S1	2-38
2.9.2.2	TTY interface SAP-S2	2-39
2.9.2.3	Universal interface S22767-B3-A100 - V24	2-39
2.9.2.4	Universal interface S22767-B3-A100 - TTY	2-40
2.9.3	WF 470 picture construction terminal	2-41
3	Operation	3-1
3.1	SIMATIC standard software	3-1
3.1.1	Data link WF 470 - S5	3-2
3.1.1.1	Technical data	3-2
3.1.1.2	Function block parametrisation	3-3
3.1.1.3	Data block "transfer block"	3-4
3.1.2	Keyboard function block WF 470 TAST	3-4
3.1.2.1	Technical data	3-5
3.1.2.2	Function block parameterisation	3-5
3.1.2.3	Keyboard code look-up table DB 201	3-6
3.1.2.4	Valid key code table	3-10
3.1.3	"DAT-IN" Function block	3-11
3.1.3.1	Technical data	3-11
3.1.3.2	Function block parameterisation	3-12
3.1.4	"BILD LIST" picture select function block	3-13
3.1.4.1	Technical data	3-13
3.1.4.2	Function block parameterisation	3-14

3.2	SIMATIC S5 Software options	3-17
3.2.1	Service module	3-17
3.2.2	Logging printout & report printout	3-18
3.2.2.1	Data transfer block	3-18
3.2.2.2	Printout operation mask	3-20
3.2.3	Sequence diagnostics	3-21
3.2.3.1	Introduction	3-21
3.2.3.2	Sequence chain control ABL:KORG (FB 172)	3-24
3.2.3.3	Sequence selection KANW:WF (FB 173)	3-28
3.2.3.4	Sequence selection ABL:KRAY / ABL: KRAN (FB 174 / FB 175)	3-31
3.2.3.5	Programmed example	3-34
3.2.3.6	Programming sequence blocks	3-39
3.2.4	Graph 5 sequence diagnostics	3-42
3.2.4.1	"GRAPH 5 diagnostics option"	3-42
3.2.4.2	SIMATIC S5 software	3-42
4	Service	4-1
4.1	Introduction	4-1
4.2	Commissioning	4-1
4.2.1	Initial inspection	4-1
4.2.2	Commissioning sequence	4-1
4.2.3	Visual checks	4-2
4.2.3.1	Checking the controller and module	4-2
4.2.3.2	Earthing	4-2
4.2.3.3	Cable separation / screening	4-2
4.2.4	Hardware checks	4-3
4.2.4.1	Checking the hardware revision level	4-3
4.2.4.2	Checking the firmware revision level	4-3
4.2.5	Bridge and switch positions WF 470 (6FM1 470- <u>3xx20</u>)	4-4
4.2.5.1	Bridge and switch positions WF 470 (6FM1 470- <u>3xx20</u>) to firmware version V2.0	4-5
4.2.5.2	Bridge and switch positions extension board (6FM1 470- <u>3xx20</u>)	4-6
4.2.6	WF 470 (6FM1 470- <u>3xx20</u>) as a central module	4-7
4.2.6.1	Factory pre-set address E000	4-7
4.2.6.2	Address setting	4-8
4.2.6.3	Example settings	4-8
4.2.7	WF 470 (6FM1 470- <u>3xx20</u>) as a peripheral module	4-9
4.2.8	Next steps in the commissioning sequence	4-11
4.2.9	Fault finding	4-11
4.2.9.1	WF 470 error messages	4-11
4.2.9.2	Analysing the DPR	4-12

5	Appendix	5-1
5.1	Ordering information	5-1
5.1.1	Ordering information WF 470 hardware	5-1
5.1.2	Ordering information WF 470 firmware	5-1
5.1.3	Ordering information WF 470 - SIMATIC software	5-1
5.1.4	Ordering information WF 470 - option software	5-1
5.1.5	Ordering information WF 470 - PG 675 - picture const.	5-2
5.1.6	Ordering information WF 470 - PG 685 - picture const.	5-2
5.1.7	Ordering information WF 470 - PG 750 - picture const	5-2
5.1.8	Ordering information - cables	5-3
5.2	Bibliography	5-5

1 Application

The automation of manufacturing equipment cannot completely prevent disruption to the process caused by faults and breakdowns. The efficiency and profitability of a plant is heavily dependent on its availability. It is therefore essential that faults are quickly and accurately located and then displayed to the relevant personnel, so that machine down time is kept to a minimum.

The WF 470 is a diagnostics and display system designed for this purpose. It is one part of a range of intelligent peripheral modules which may be used in conjunction with SIMATIC S5 programmable controllers. The WF 470 module is directly connected to its colour monitor. The module has its own "on board" micro-processor and memory, allowing it to construct, to store and to display process pictures.

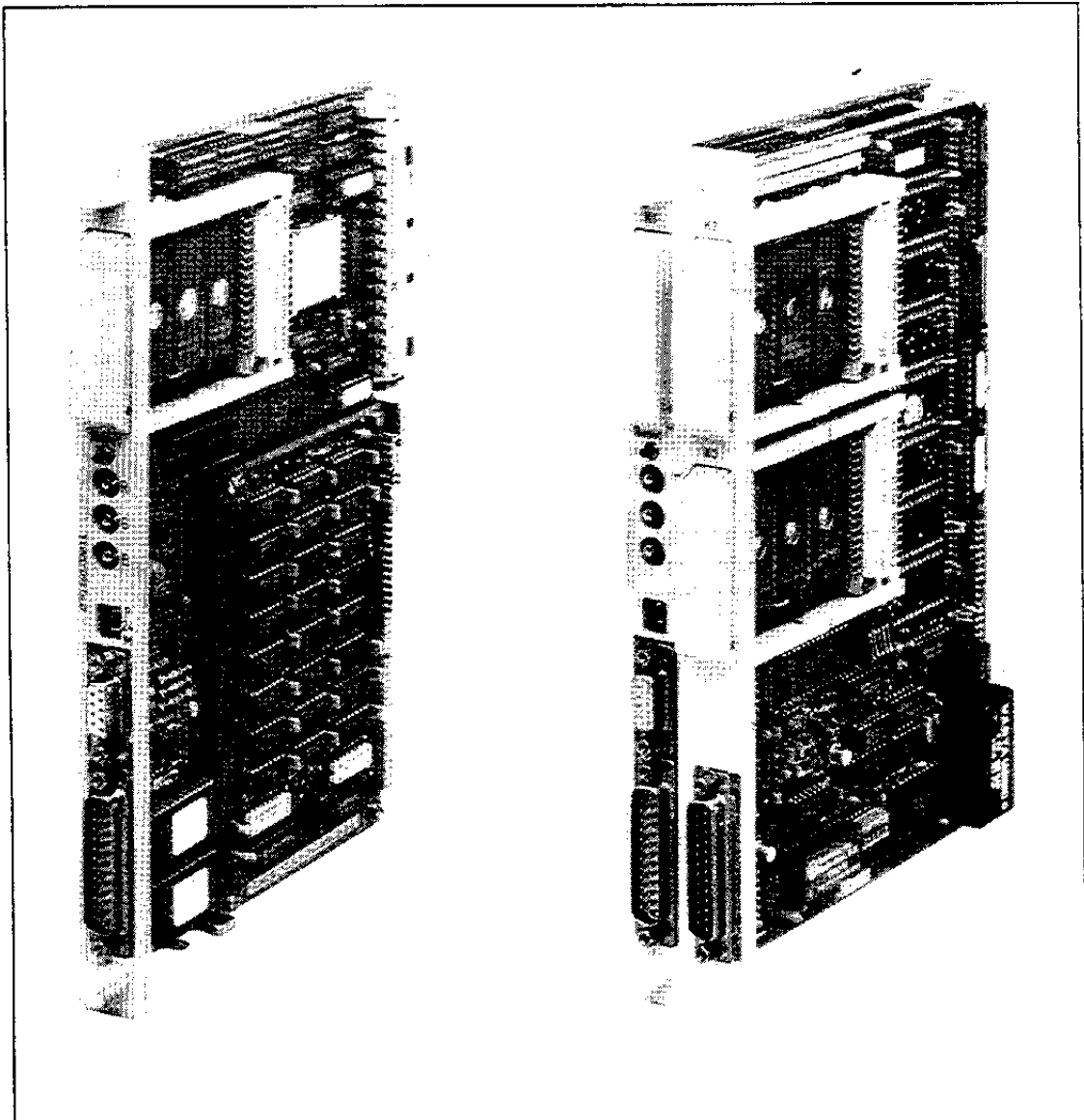

Fig 1.1 WF 470 A.

Fig. 1.2 WF 470B/C Two additional slots for memory submodules, second serial interface port for printer-computer link)

The WF 470 can automatically provide information about the

- Type of fault
- Location of the fault
- Cause of the fault
- Remedy of the fault

The WF 470 has additional options for the display of sequence information and service data. The sequence analyser option is used to monitor and display the condition of the sequence programs' inputs, outputs, and flags etc. in the PLC. The service module allows PLC status information to be displayed without the need to connect a programming unit.

The WF 470 can also simplify the start-up and operation of a machine. The machine start sequence and operating modes can not only be displayed graphically but also in descriptive text. The interaction of the operating personnel with the production machinery is thereby also improved.

Main features of the WF 470:

- The pictures and text fields are constructed using a PG 675, PG 685 or PG 750 programming unit, which provides user-friendly softkey operation with full help texts and prompting.
- The good range of graphical and text functions available permit clear and accurate mimics of the machines and processes to be produced.
- The pictures and texts are stored and controlled by the module, thus releasing the SIMATIC PLC to perform the control task.
- Error messages and status reports can be output directly from the WF 470 module to a printer or supervisory computer.
- Sequence programs running in the PLC can be monitored and their status displayed on the WF 470 screen and printer.

The process mimic pictures and data displays are constructed from the following elements. Each element can be magnified up to a factor of 16 times normal size independently in both the X and Y directions. Eight different fore- and background colours may be used.

- Individual symbols
 - 128 pre-defined symbols
 - 128 further user-definable symbols
 - ASCII character set
- Composite symbols (Any combination of individual symbols)
- Text display windows
 - Static text, the colour is changed by control bits in the PLC
 - Dynamic text with scroll and push-up, displayed only when the control bits are high.

- Variable fields
 - Process data entry
 - Process data entry and display
 - Process data display
 - Comment text
 - date
 - time
- Bar graphs, which allow the following to be defined:
 - size (vertical, horizontal) to pixel resolution
 - Direction of increase
 - Colour zones (up to 8)
 - Width
 - Height

Examples of typical pictures and data displays are produced on the following pages.
The WF 470 Brief Description leaflet contains further colour reproductions of typical WF 470 pictures.

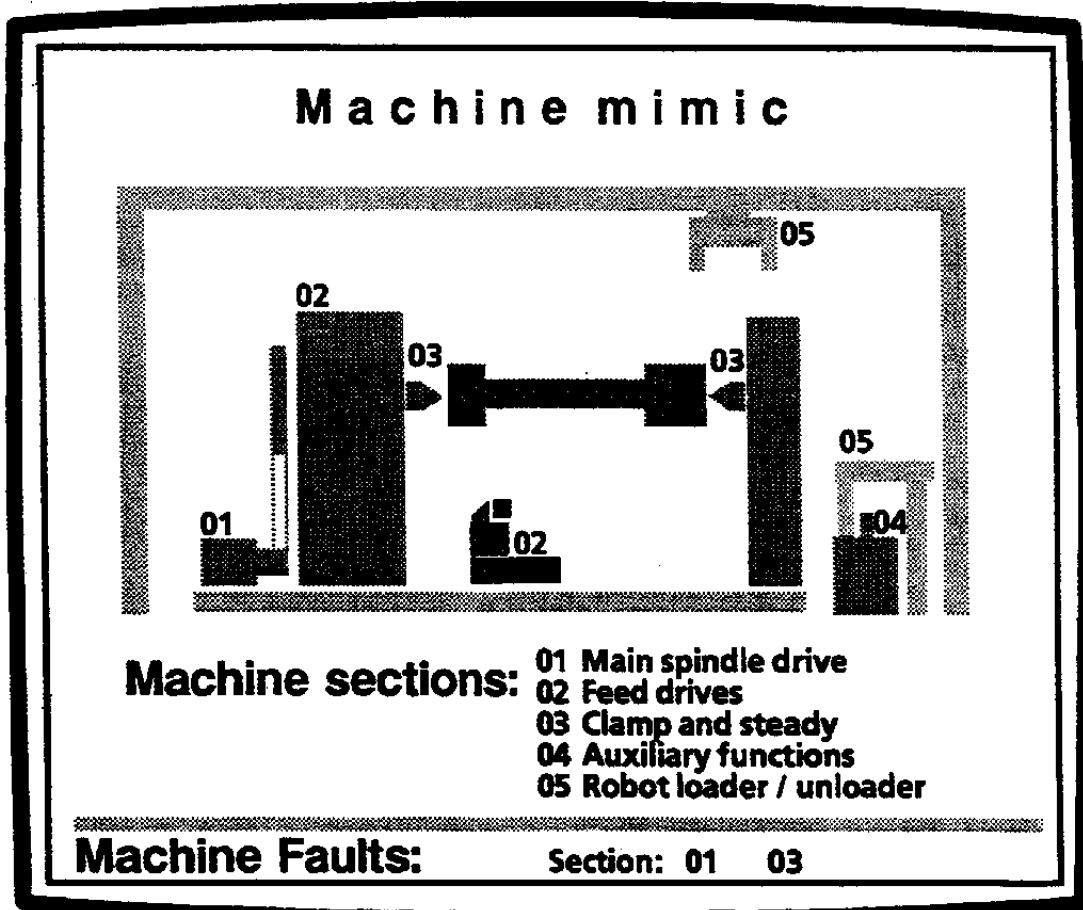

WF 470 Graph 5 Sequencer overview 02.11.87 12:45:46

No	SB-No	State	Function	
17	017	***	Transfer line start up conditions	
18	018	*	Loader arm and manipulator	ST 1
19	019		First cut component side left	ST 2A
20	020	***	First cut component side right	ST 2B
21	021		Drill holes component side left	ST 3A
22	022	*	Drill holes component side right	ST 3A
23	023	***	Fine machining component side left	ST 4A
24	024		Fine machining component side right	ST 4B
25	030		Measuring station - external dimensions	ST 7
26	000			
27	000			
28	000			
29	000			
30	000			
31	000			
32	000			

No * = sequence started and running
 * = sequence not started
 *** = sequence fault

F1 Diagnose	F2 Seq. +1	F3 Seq. -1	F4 Scroll down	F5 Scroll UP	F6 Page +1	F7 Page -1	F8 Index
----------------	---------------	---------------	-------------------	-----------------	---------------	---------------	-------------

WF 470 Graph 5 Diagnostic unit 02.11.87 12:45:46

Faulty sequences: 17 20 23

Automatic Sequencer	17	Transfer line start up sequence
SB-No	017	A 021.7 Oil pressure low
Transition	2	A 021.3 Loading station tool missing
Max. step	067	A 021.4 Indexing pulse not selected
		A 000.3 Coolant on
		A 000.6 Station not empty
Branch Step State		A 000.5 Index
1	007)
2	011	A 021.6 E-stop pressed
3	017	A 021.4 Run-out not selected
4	031	O 021.3 Loading station tool missing
5	34)
6	045	
7	000	
8	000	

F1 Graph 5 Overview	F2 Chain +1	F3 Scroll +1	F4 Scroll -1	F5 Change Mode	F6 Transit +1	F7 Branch +1	F8 Index
------------------------	----------------	-----------------	-----------------	-------------------	------------------	-----------------	-------------

WF 470		Step sequence analysis Overview		02.11.87 12:45:46	
No.	SB	Step	Function		
*01	012	002	Material loader section	01	
02	015	001	Station	01A	
03	019	002	Station	01B	
*04	022	002	Milling	02A	
05	027	004	Drilling station	02B	
06	035	003	Drilling station	03A	
07	043	003	Measurement station	03B	
08	051	002	Rework station	04	
09	058	004	Milling station	05	
10	070	003	Milling machine	6A	
11	079	006	Measurement station	07	
12	085	004	Washing station	08A	
13	094	006	Washing station	08B	
14	103	003	Washing station	08C	
15	120	008	Washing station	08D	
16	000	000	Reserved		

Maximum length of this text is 50 characters

F1 Mimic	F2 Operate	F3 Pic elem.	F4 Print	F5 WF470 Text	F6 Service fct	F7 Analysis	F8 Index
-------------	---------------	-----------------	-------------	------------------	-------------------	----------------	-------------

WF 470		Step sequence analysis Diagnostic unit		02.11.87 12:45:46	
Faulty sequences: 01 04					
No.	SB	Step	Material loader station 01		
*01	012	002	05	Transition conditions not fulfilled 01 - 05	
A 1000.0 E-Stop pressed					
A)					
A 1000.1 Tool missing (E0.1) _____					
A 1000.2 Tool not in tolerance					
O 1000.5 Index					
)					

Maximum length of this text is 50 characters

F1 Mimic	F2 Operate	F3 Pic elem.	F4 Print	F5 WF470 Text	F6 Service fct	F7 Overview	F8 Index
-------------	---------------	-----------------	-------------	------------------	-------------------	----------------	-------------

WF 470 Service module					
CONTROL	n/DL	n+1/DR	HEXA	DEC	
IW 000	0000 0110	1100 0000	06C0	01728	
QW 000	1000 0100	1100 0000	84C0	33984	
FW 100	0000 0001	0000 0000	0100	00256	
C 005	0000 0000	0000 0000	0000	0000	
T 102	0000 0000	0000 0000	0000	0000	100ms
PW 129	1111 1111	1111 1111	FFFF	65535	
DB 030					
DW 001	0000 0000	0000 0001	0001	00001	
DW 002	0000 0000	0000 0101	0005	00005	
DW 003	0100 1000	0010 0000	4820	18464	

WF 470 service module option

1=Input word (IW)	2=Output word (OW)	3=Flag word (MW)
4=Counter (C)	5=Timer (T)	6=Periphery (PW)
7=DB number (DB)	8=DW number (D1)	0=Delete

F1 Mimic	F2 Operate	F3 Pic elem.	F4 Print	F5 Characteris.	F6 Free	F7 Sequence	F8 Index
-------------	---------------	-----------------	-------------	--------------------	------------	----------------	-------------

LOAD AXIS (AXIS 1)	Machine data	
MACHINE DATA INPUT/OUTPUT	⇒ Fault ←	
MD 1 5000	MD 17 0	MD 33 0.200
MD 2 6000	MD 18 1	MD 34 2000
MD 3 .. 30000.00	MD 19 1	MD 35 0.000
MD 4 1	MD 20 0	MD 36 0
MD 5 ... 0	MD 21 2	MD 37 0
MD 6 0	MD 22 1.00	MD 38 0.00
MD 7 1	MD 23 9000	MD 39 0.00
MD 8 100	MD 24 40.000	MD 40 0
MD 9 1	MD 25 0.100	MD 41 0
MD 10... 0	MD 26 26.000	MD 42 0
MD 11... -1000.000	MD 27 0	MD 43 0
MD 12... -1100.000	MD 28 1.111	MD 44 0
MD 13... 2100.000	MD 29 0	MD 45 ... 0.000
MD 14... 2110.000	MD 30 1 0000	MD 46 ... 0.000
MD 15..... 2	MD 31000	
MD 16... 1.000	MD 32 0.100	

WF 726 standard III

MD 49 ... 1

RAM				Axis number: 1			
F1	F2	F3	EEPR/RAM F4	F5	F6	DIAGNOSE F7	RETURN F8

LOAD AXIS (AXIS 1)				Set Up mode			
SET UP MODE				⇒ Fault ⇐			
Reference app speed 1	500000	Zero point offset	500.000				
Reference app speed2	100000	Split-drive offset	0				
Reference app speed3	50000						
Jog speed 1	1000000	TEACH IN:					
Jog speed 2	2000000	Program number	0				
		Block number	0				
MDI:							
G-1 function	0						
G-2 function	0						
X value	0.000	Actual position	0.001				
F rate	0						
				WF 726 standard III			
RAM				Axis number: 1			
ACT.VAL F1	F2	F3	EEPR/RAM F4	F5	TEACH IN F6	DIAGNOSE F7	RETURN F8

AXIS 3				Diagnostics			
SET UP MODE							
Faulty Axes:				Error in Axis 3			
Axis 3				Following error at standstill			
				WF 726 standard III			
				Axis number: 3			
F1	F2	F3	F4	F5	F6	F7	RETURN F8

2 Hardware

2.1 System configuration

The WF 470 module resides in the SIMATIC programmable controller rack and is bus-coupled to the central processor. The following units are connected directly onto the WF 470 module.

- Colour monitor
- Logging printer
- Picture construction system (PG 675/PG 685/PG 750 and printer; only required during picture construction and editing)

The operator keyboard can be connected normally via SIMATIC inputs and outputs and/or serially directly onto the WF 470. The complete configuration is shown below:

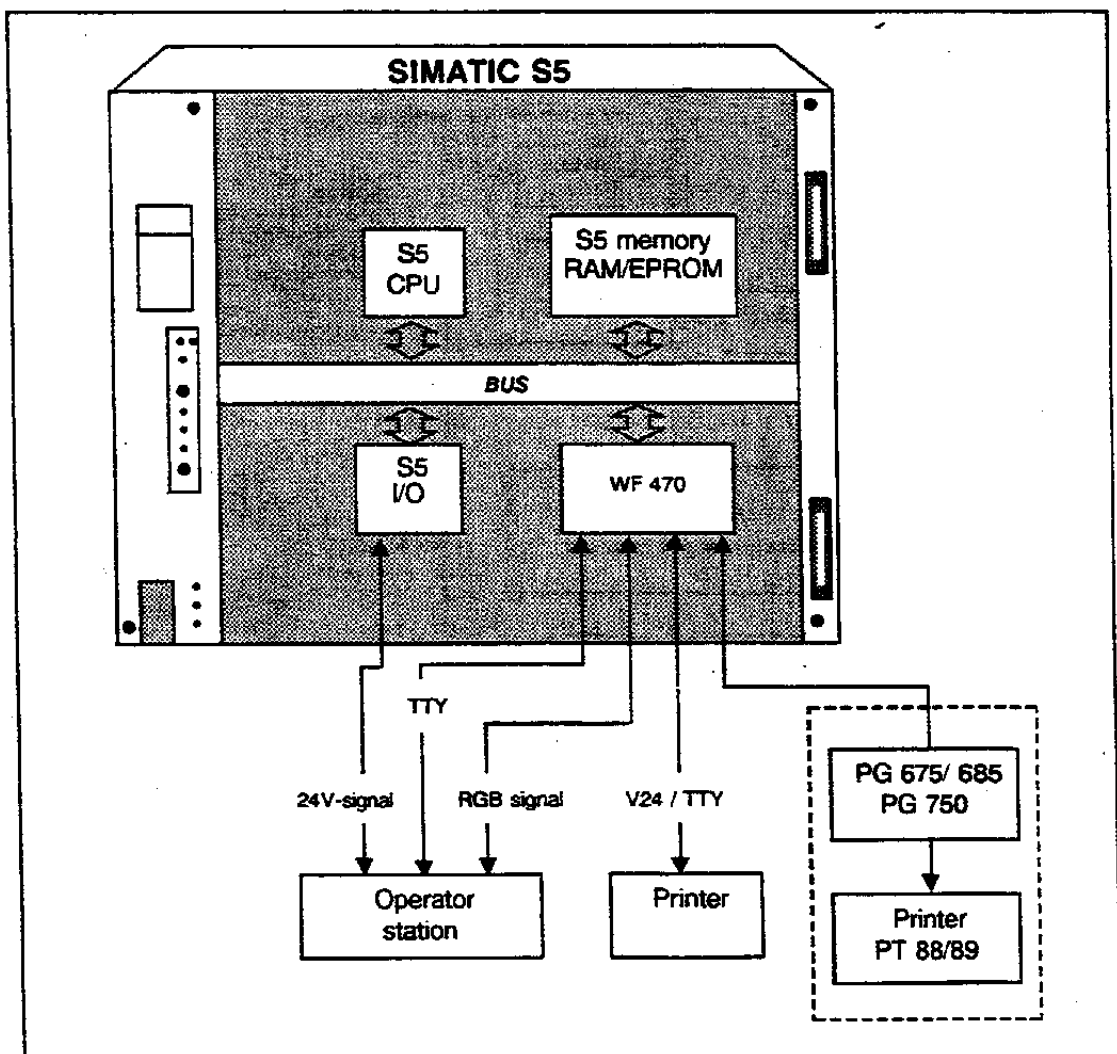

Fig. 2.1 WF 470 system configuration.

2.2 WF 470 hardware

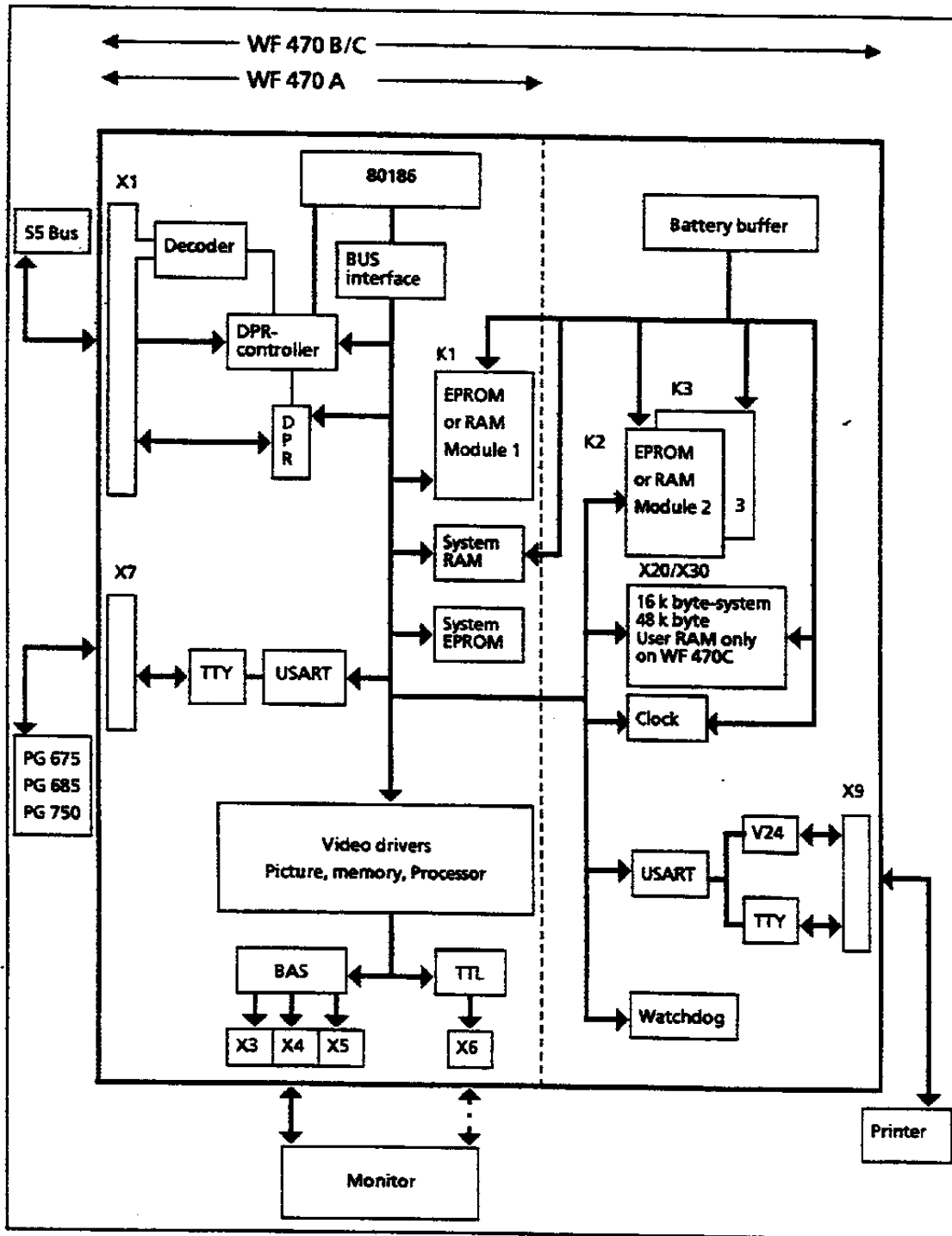

Fig 2.2 WF470 A, WF470 B, WF470 C Hardware block diagram.

When using a WF 470 B, a RAM module should be plugged into the third slot K3. Of this RAM, there will then be 8 Kbyte used by the system. This RAM is not necessary when the WF 470 pictures are simple and do not display a large amount of data, and when the printer function is not going to be used.

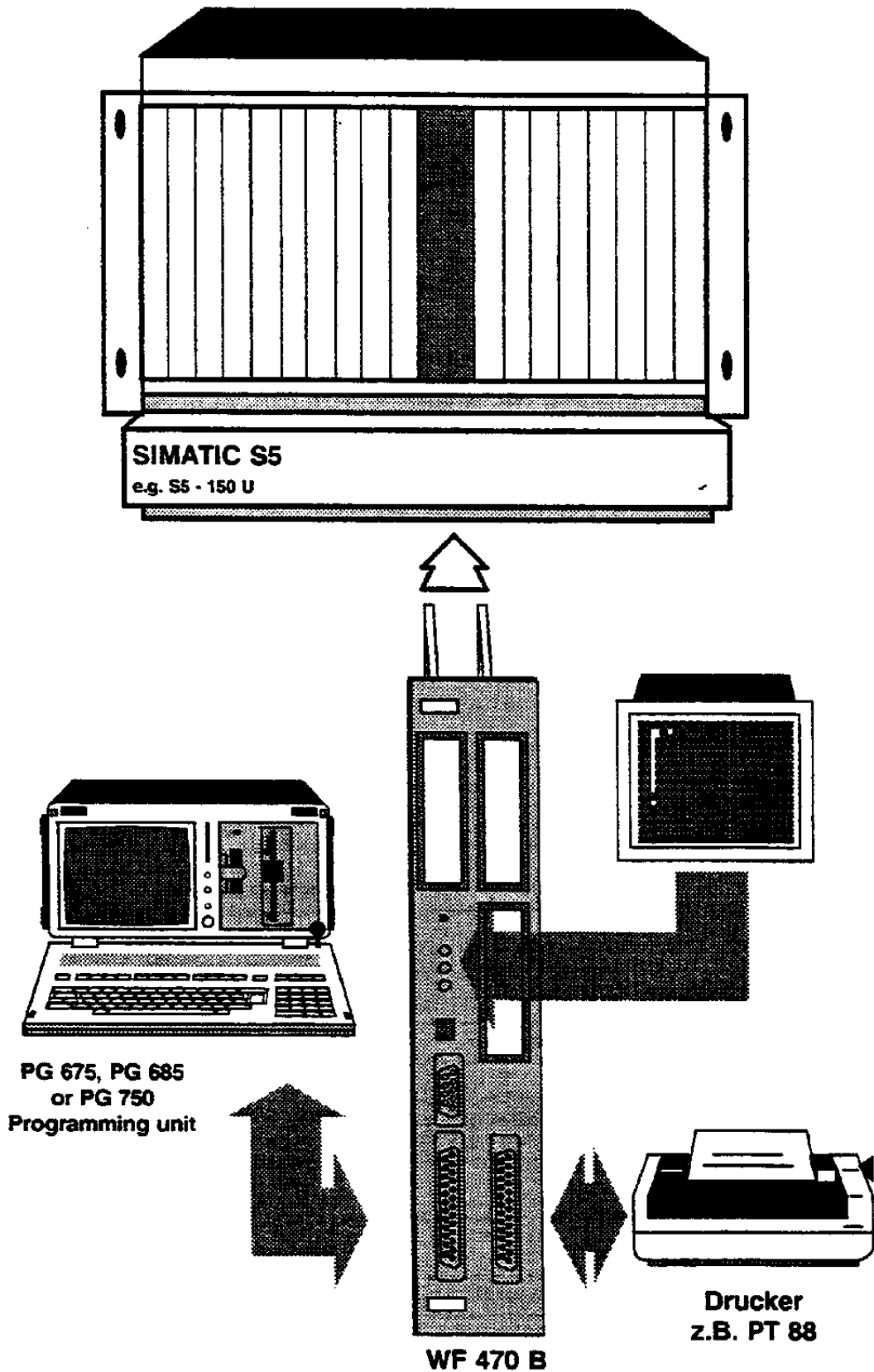

Fig. 2.3 Hardware configuration.

Technical Data

	WF 470 A Monochrome	WF 470 A Colour		
Microprocessor	For picture construction, data processing, hardware interface control			
Operating System	RMOS real time operating system			
Operating System Memory	2 x EPROM 27512 (128 K byte) 16 K byte RAM as internal workspace			
User Memory RAM- or EPROM Module	1 slot memory capacity max. 128 K byte	1 slot memory capacity max. 128 K byte		
Time Generation	Software clock	Software clock		
Interfaces - link to SIMATIC S5 - BAS Outputs - TTL Monitor	Via Dual Port RAM, 256 byte RGB, frame and line synchronisation; Theoretical maximum cable length: 400 m maximum cable length: 2,5 m			
Serial Interface for PG 675, PG 685 and PG 750	X	X		
Serial Interface for printer				
SIMATIC S5 PLC's	115U, 135U, 150U, 155 U, 130W(B)			
Power Supply	Via SIMATIC S5-bus; Power supply 5 V DC			
Current Requirement	2.5 A	2.5 A		
Dimensions	Single slot width	Single slot width		
	WF 470 B Monochrome	WF 470 B Colour	WF 470 C Colour	
Microprocessor	For picture construction, data processing, hardware interface control			
Operating System	RMOS real time operating system			
Operating System Memory	2 x EPROM 27512 (128 Kbyte) 16 Kbyte RAM used as internal workspace			
User Memory RAM- or EPROM- Module	3 slots memory capacity max. 3x128 K byte	3 slots memory capacity max. 3x128 K byte	3 slots memory capacity max. 3x128 K byte and 48 K byte RAM on the module	
Time Generation	Hardware clock	Hardware clock	Hardware clock	
Interfaces - link to SIMATIC S5 - BAS-Output - TTL-Monitor	Via Dual Port RAM, 256 byte RGB, Theoretical maximum cable length:400 m Maximum cable length: 2.5 m			
Serial Interface for PG 675, PG 685 and PG 750	X	X	X	
Serial Interface for printer	X	X	X	
SIMATIC S5 PLC's	115U, 135U, 150U, 155 U, 130W(B)			
Power Supply	Via SIMATIC S5-bus; supply voltage 5 V DC			
Current Requirement	3.0 A	3.0 A	3.0 A	
Dimension	Double slot width	Double slot width	Double slot width	

2.3 WF 470 Battery back-up buffer

The WF 470 A uses the SIMATIC S5 battery to provide the battery back up. The WF 470 B/C allows the user to select how the unit will be buffered (Fig. 2.4):

- Buffered via S5: (S2.1 closed, T-S open)
 - Buffered via S5 and self-buffered (mixed): (S2.1 open, T-S closed)
 - Buffered via S5 and self-buffered (joint): (S2.1 closed, T-S closed)
- This is the setting used in normal applications.

The T-S link is left OPEN when the unit is delivered from the factory, to prevent the battery from being discharged. It must be soldered in before the WF 470 is inserted in the SIMATIC rack.

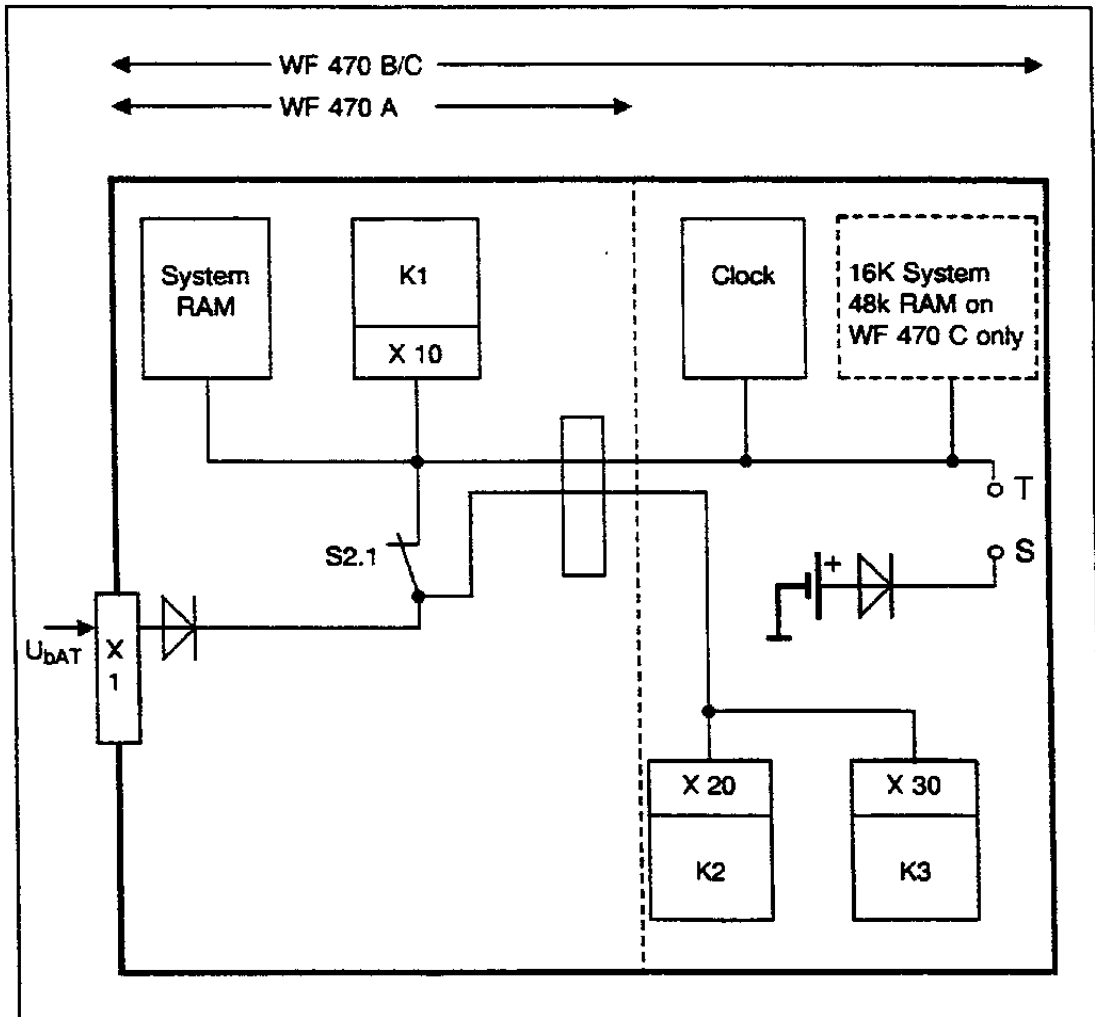

Fig 2.4 Battery back-up WF 470 A and WF 470 B/C.

2.4 Linking the WF 470 to the SIMATIC PLC

The WF 470 can operate as a

- Central unit module
- Peripheral module

The data exchange between the S5 and the WF 470 takes place via a Dual Port Ram on the WF 470 board. The Dual Port Ram acts as a memory which can be accessed from two sides, from the S5 and from the WF 470. The DPR therefore allows both partners to read from and write into the interface memory. A data transfer data block is also created in the PLC to receive data from the WF470 clock for the various option packages (sequence analyser, printer etc.).

The SIMATIC S5 Hardware treats the WF 470 like a memory module, for which the start address and size must be coded.

The module is pre-set with the following memory address and size:

- DPR Address : E000 (56 x 2¹⁰)
- DPR Size: 256 byte

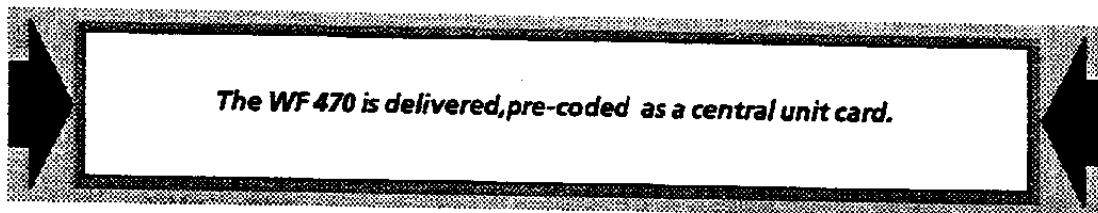

2.4.1 WF 470 configured as a central unit module

When set to this mode, the WF 470 can be installed in the central rack or the extension rack. The extension rack offers the connections for the communication modules (CP connections, according to the SIMATIC catalogue). Prerequisite for this is the coupling of the extension racks via the connections AS304 - AS314.

The locations in the central rack which may be used are described in this manual in section 2.5 .

- DPR - start address: 0 to FF00 (63.75X2¹⁰, see section 2.6)
selectable in 256 byte steps
- DPR - size: 256 byte (fixed setting)

2.4.2 WF 470 configured as a peripheral module

This mode permits the module to be inserted into any peripheral slot in the central rack (see section 2.5). It can also be used in an extension rack, provided it is connected to the central rack in one of the following configurations:

CU	EU	EU	
300	→ 312	→ 312	(Centralised configuration)
301	→ 312	→ 312	(Centralised configuration)
301	→ 310	→ 310	(de-centralised configuration)
	300	→ 312	

Expansion units which are linked via a 302-311 link cannot be used by the WF 470. The expansion unit must be fitted with a fan. The current consumption of the modules in the rack should be checked.

Provided that the above conditions are met, the WF 470 can be installed in any location in the extension unit.

The Dual Port Ram may then be coded into the analogue peripheral area (peripheral bytes 128-255) or in the expanded peripheral area (Q-bytes 0-256).

- DPR - start address: PY 128-255 (analogue section)
OY 0-255 - (Q section)
in steps of the DPR size
- DPR - size: 32/64/128/256 byte

The WF 470 cannot make use of the SIMATIC back-up battery when configured as a peripheral module (The WF 470B / C has its own battery - see section 2.3).

By reducing the size of the DPR, the data transfer time between the S5 and the WF 470 is increased. It is therefore recommended to set the DPR size as large as possible.

The WF 470 is normally configured as a central module.

2.5 Module location in the SIMATIC rack.

2.5.1 SIMATIC S5-130 WB

Power supply: 18 A

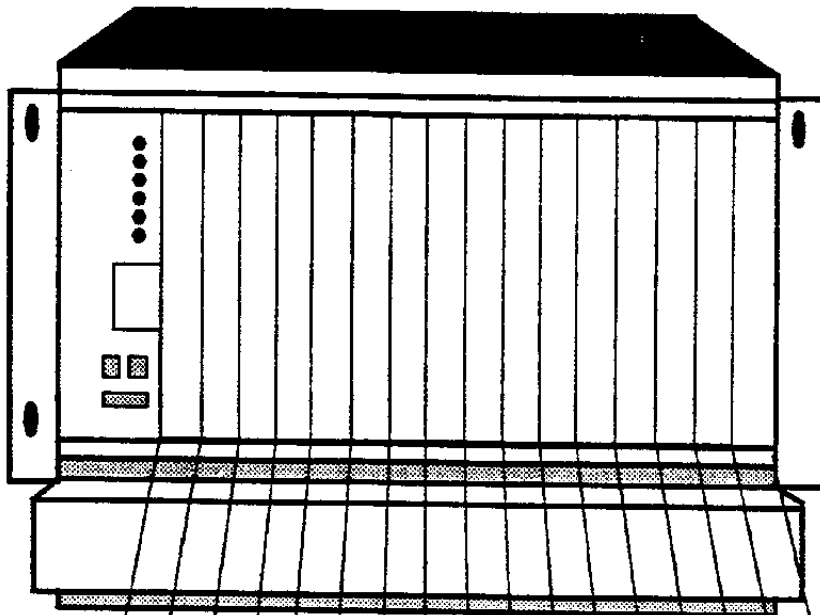

Slot number	27	35	43	51	69	79	89	97	105	113	121	129	137	145	153	163	current consumption (A)/ module
CPU																	5.0 A
Memory 340																	1.2 A
Memory 350																	1.8 A
IF 511																	1.7 A
I/Q																	
WF 460																	2.5 A
WF 463 S																	2.0 A
WF 470 A																	2.5 A
WF 470 B																	3.0 A
WF 470 C																	3.0 A

- 16 bit wide address bus
- 8 bit wide address bus- the WF 470 can only used as a peripheral module here.

2.5.2 SIMATIC S5-150 S

Power Supply: 2 × 18 A

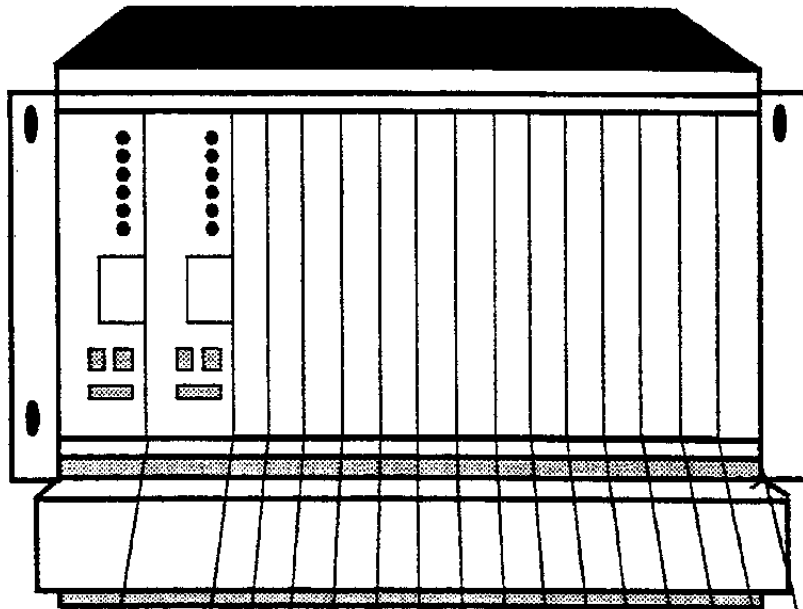

Slot number	51	59	67	75	85	93	101	109	117	127	137	145	153	161	current consumption (A)/ module
CPU															5.0 A
Memory 340															1.2 A
Memory 350															1.8 A
IF 511															1.7 A
WF 460															2.5 A
WF 463 S															2.0 A
WF 470 A															2.5 A
WF 470 B															3.0 A
WF 470 C															3.0 A

These slots are not buffered via the S5 bus.

The WF 470 MUST NOT be used in the central extension rack!

2.5.3 SIMATIC S5-115 U

The WF 470 can only be used under the following conditions:

- CPU 941/942/943/944
- 15 A Power supply fitted
- Fan tray fitted

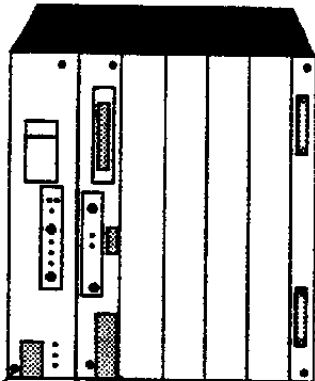

Module code	PS	CPU	0	1	2	3	IM	current consumption (A)/module
-------------	----	-----	---	---	---	---	----	--------------------------------

Central rack CR 700-0

Communications processor								
I/Q analogue/digital								
WF 460								2.5 A
WF 463 S								2.0 A
WF 470 A								2.5 A
WF 470 B + . C								3.0 A

5V current: consumption	CPU	941	1.2 A
		942	0.9 A
		943	0.5 A
		944	

The WF 470 can only be used under the following conditions:

- CPU 941/942/943/944
- 15 A Power supply fitted
- Fan tray fitted

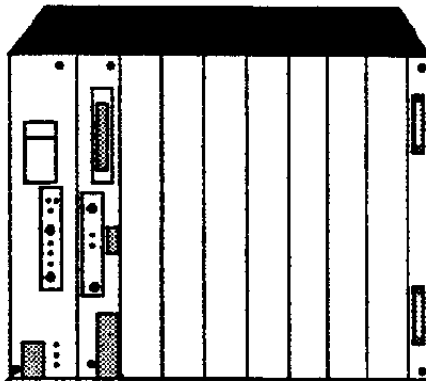

Module code	PS	CPU	0	1	2	3	4	5	6	IM	current consumption (A)/module
-------------	----	-----	---	---	---	---	---	---	---	----	--------------------------------

Central rack CR 700-1

Communications processor											
I/Q analogue/digital											
WF 460											2.5 A
WF 463 S											2.0 A
WF 470 A											2.5 A
WF 470 B u. C											3.0 A

Central rack CR 700-2

Communications processor											
I/Q analogue/digital											
WF 460											2.5 A
WF 463 S											2.0 A
WF 470 A											2.5 A
WF 470 B + . C											3.0 A

2.5.4 SIMATIC S5-135 U

The WF 470 can be used with a CPU 921, 922, or 928.

Power supply: 18A.

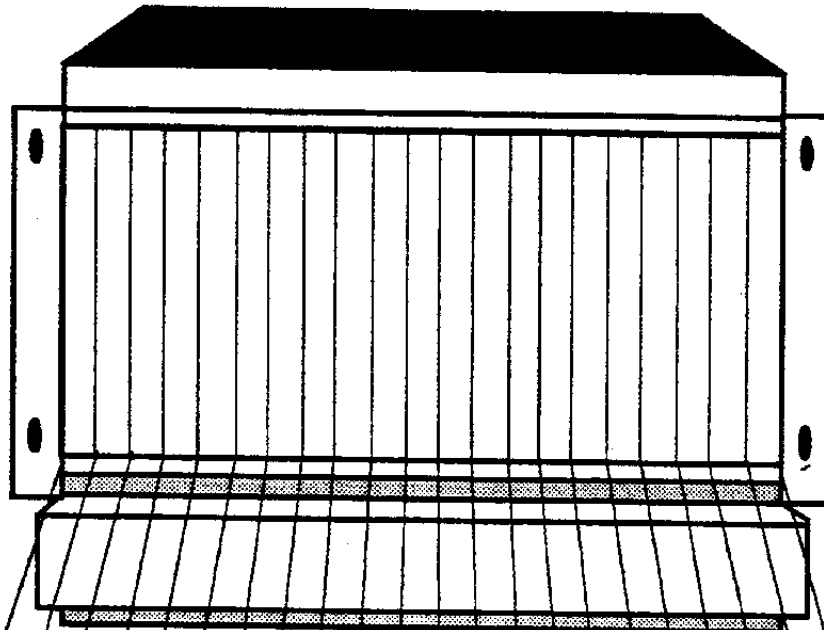

Module code	3	11	19	27	35	43	51	59	67	75	83	91	99	107	115	123	131	139	147	155	163	*	
Co-ordinat. 923 A																							
CPU																							
Communic. processor																							
I/Q																							
WF 460																							2.5 A
WF 463 S																							2.0 A
WF 470 A																							2.5 A
WF 470 B																							3.0 A
WF 470 C																							3.0 A

* Current consumption (A)/ module



16 bit wide address bus

8 bit wide address bus- the WF 470 can only used as a peripheral module here.

2.5.5 SIMATIC S5-150 U

Power Supply: 40 A

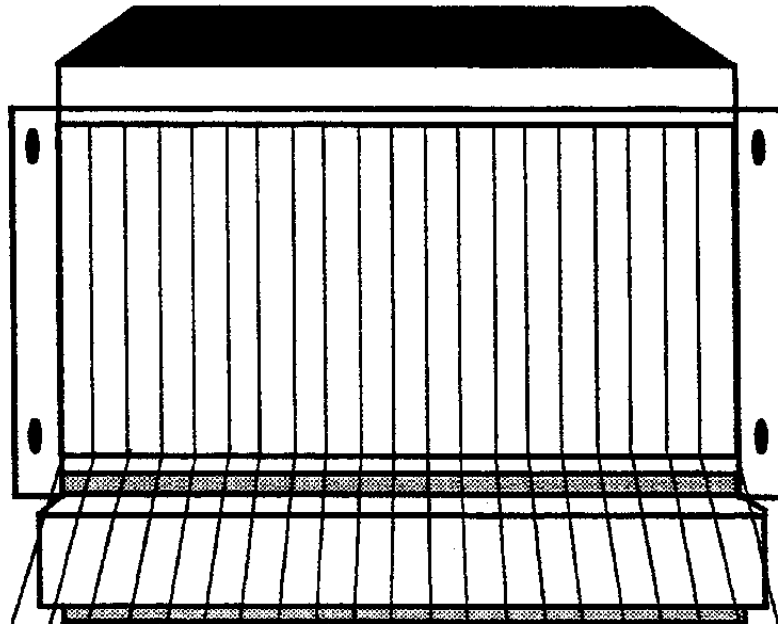

Slot code	3	11	19	27	35	43	51	59	69	79	89	99	107	115	123	131	139	147	155	163	*	
CPU					■	■	■	■														12.7A
Jumpering module 756				■																		
Memory 340/350										■	■	■	■	■								0.5/2
Parity module	■											■	■	■								1.5 A
I/F 511										■	■											1.7 A
Communic. processor	■	■	■										■	■	■	■	■	■	■	■		
WF 460	■	■	■										■	■	■	■	■	■	■	■		2.5 A
WF 463 S	■	■	■										■	■	■	■	■	■	■	■		2.0 A
WF 470 A	■	■	■										■	■	■	■	■	■	■	■		2.5 A
WF 470 B	■	■	■										■	■	■	■	■	■	■	■		3.0 A
WF 470 C	■	■	■										■	■	■	■	■	■	■	■		3.0 A

* Current requirement for each module

■ Only possible when the jumper module 756 is still fitted.

2.5.6 SIMATIC S5-155 U

Power Supply: 40 A

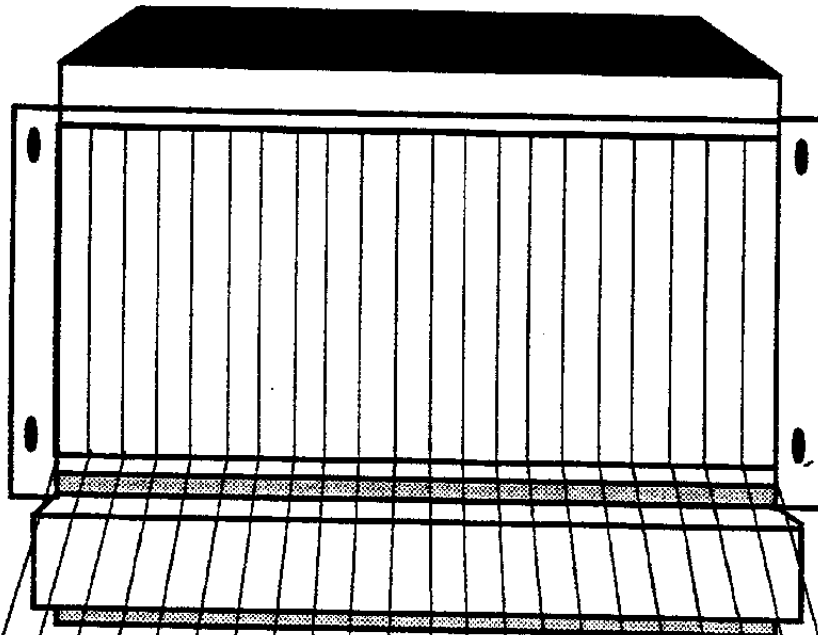



Slot code	3	11	19	27	35	43	51	59	67	75	83	91	99	107	115	123	131	139	147	155	163	*	
CPU 946		■																					
CPU 947			■																				
Memory 355				■																			
Communic. processor					■																		
WF 460						■																	2,5 A
WF 463 S							■																2,0 A
WF 470 A								■															2,5 A
WF 470 B									■														3,0 A
WF 470 C										■													3,0 A

* Current requirement for each module

■ 16 bit wide address bus

2.6 Memory addressing in the SIMATIC S5

-  Permitted addressing range when central module
-  Permitted addressing range when peripheral module

The memory region selected must not be occupied by any other card. The WF range of cards is NOT page addressed.

2.6.1 SIMATIC S5-130 WB

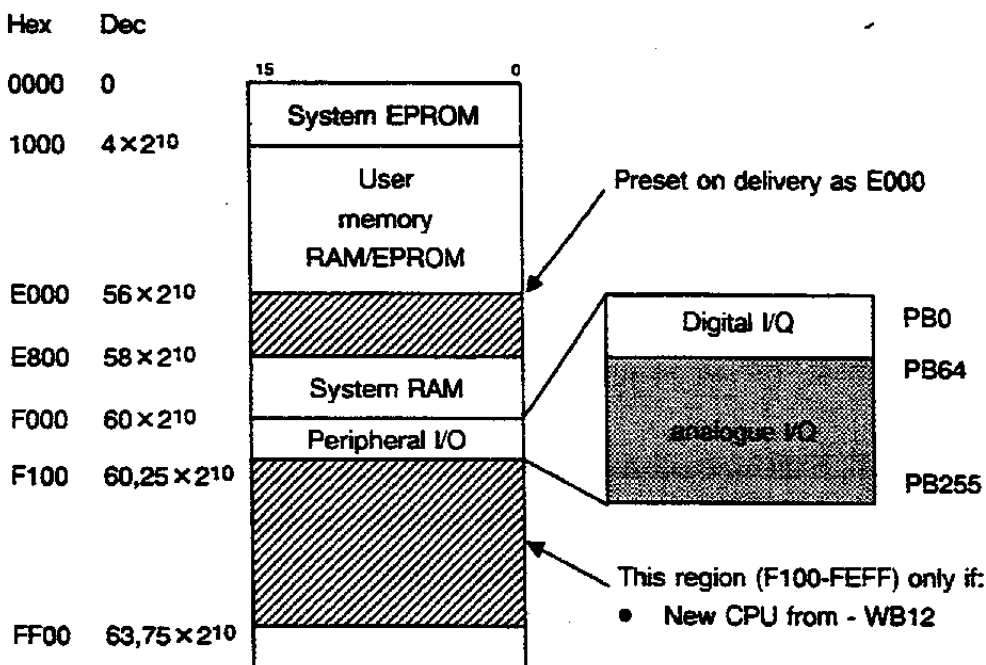

The WF 470 module is normally used with its delivery pre-set address of E000.

2.6.2 SIMATIC S5-150 S

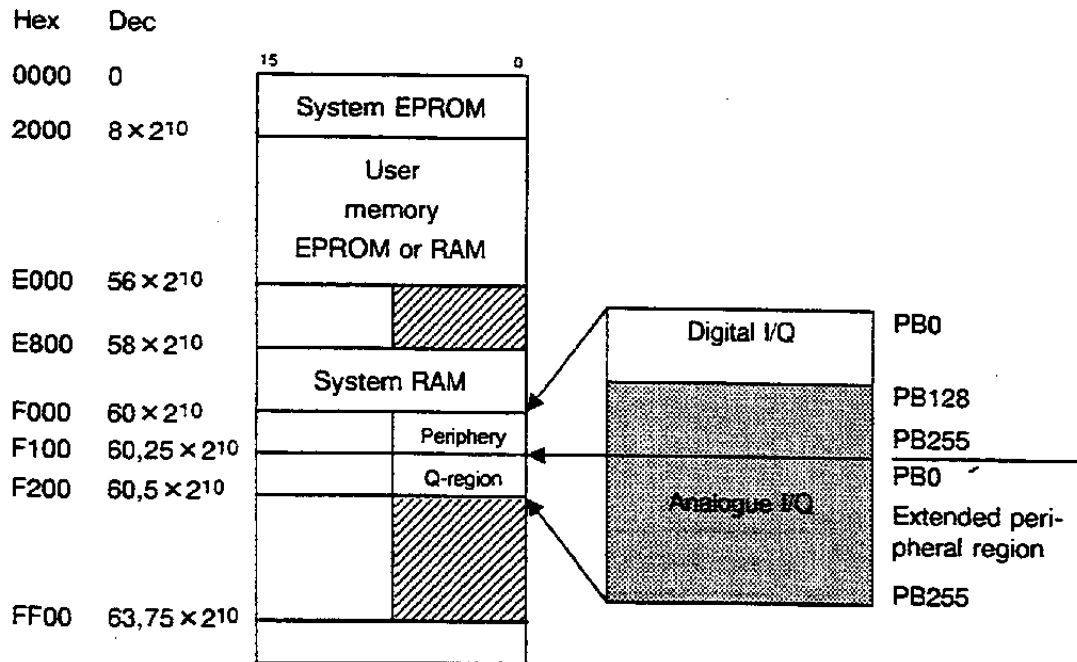

The extended peripheral region is only available for use in an extension rack which is connected to the central rack via a separate ER interface.

The WF 470 module is normally used with its delivery pre-set address of E000.

If the extended peripheral region is not used, the addressing space between F100 and F1FF can be used for the WF 470 configured as a central module.

2.6.3 SIMATIC S5-115 U

2.6.3.1 S5-115U-CPU941

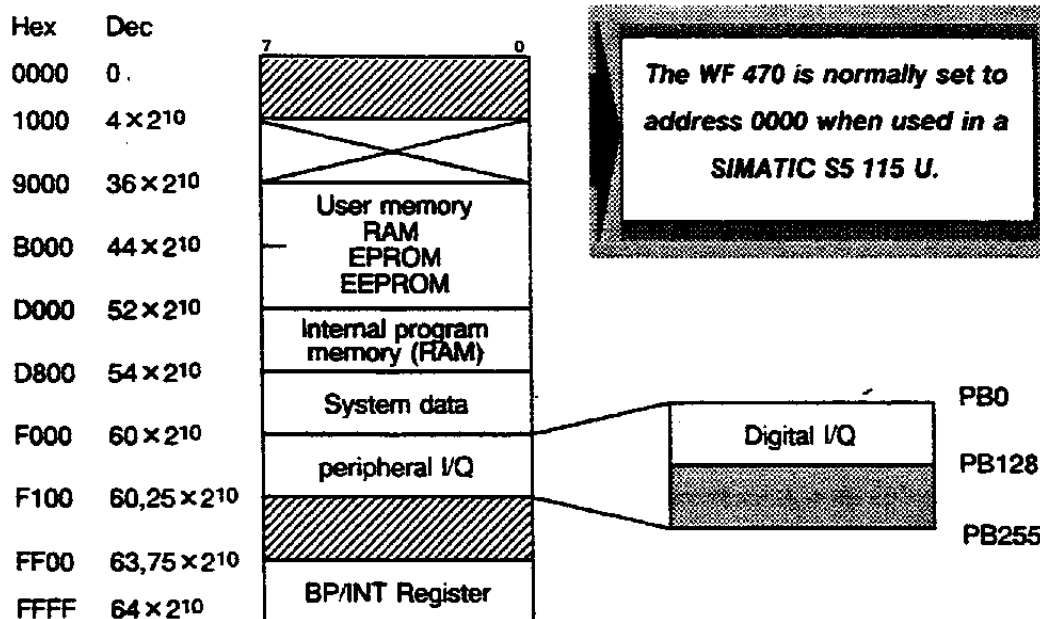

The WF 470 would normally be used with the SIMATIC S5 115U CPUs 942, 943 or 944 because of their faster cycle times.

2.6.3.2 S5-115U-CPU942/943/944

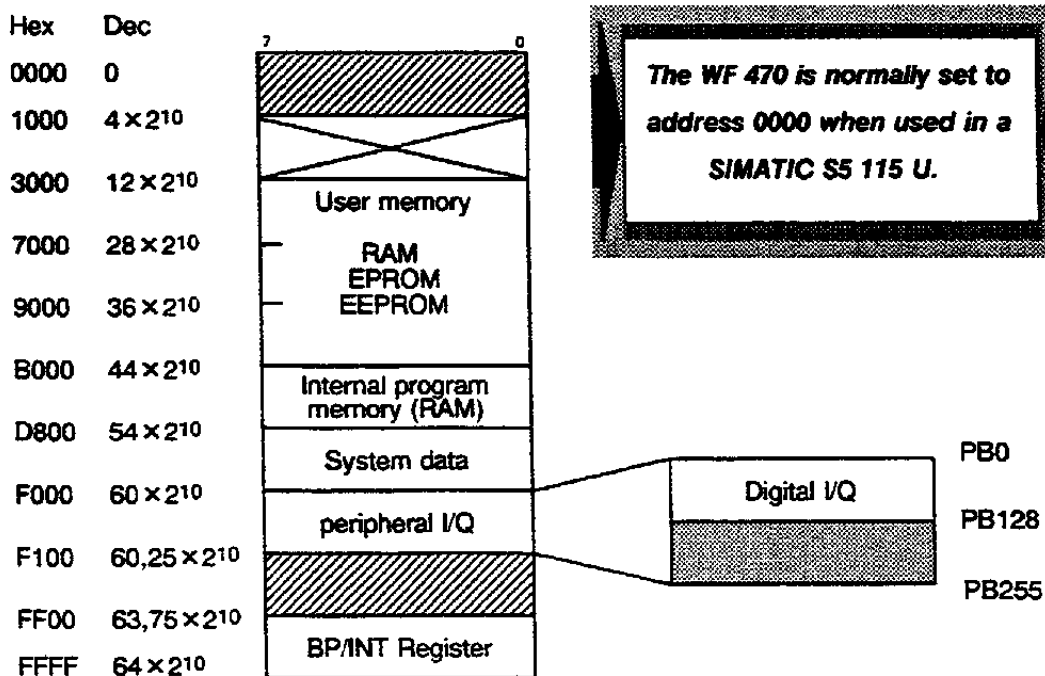

2.6.4 SIMATIC S5-135 U

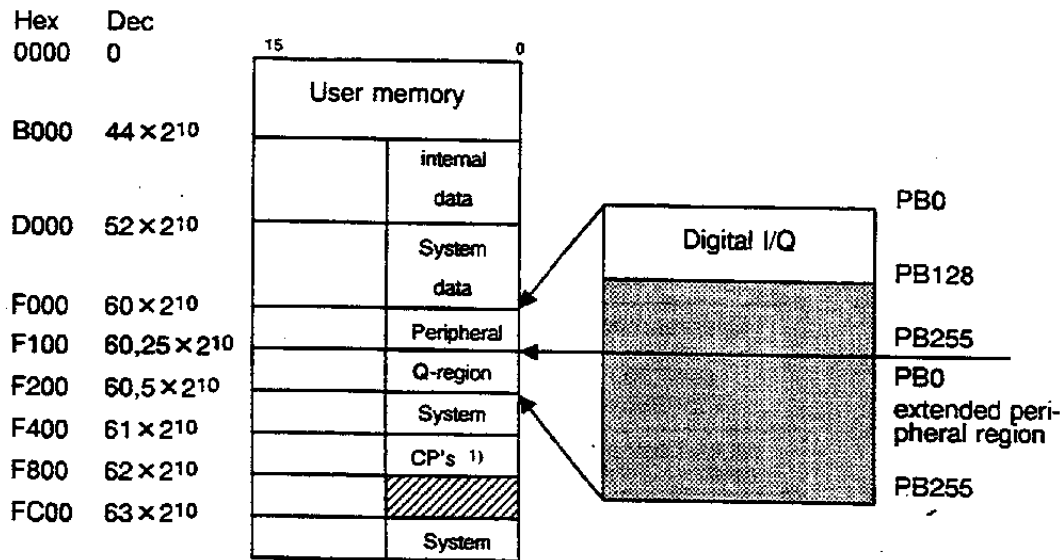

1) If no CP's are being used, this addressing region could also be used by the WF470.

The extended peripheral region is only available for use in an extension rack which is connected to the central rack via a separate ER interface.

If the extended peripheral range is selected, no peripheral modules can be installed in the central rack.

If no extended peripheral region is used, the addressing space between F100 and F1FF can be used for the WF 470 configured as a central module.

The WF 470 module is normally set to address F800.

The WF 470 may only be interfaced in software to ONE of the CPU's if the S5 135U is being used in multiprocessing mode.

2.6.5 SIMATIC S5-150 U

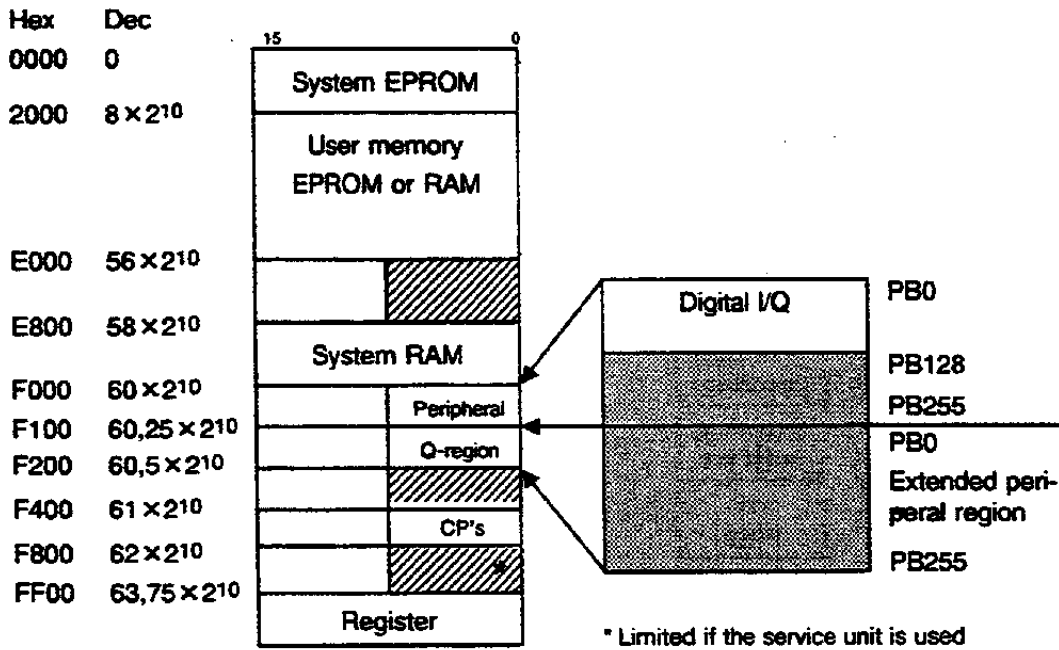

The extended peripheral region is only available for use in an extension rack which is connected to the central rack via a separate ER interface.

If no extended peripheral region is used, the addressing space between F100 and F1FF can be used for the WF 470 configured as a central module.

**The WF 470 module is normally used with its delivery
pre-set address of E000.**

2.6.6 SIMATIC S5-155 U

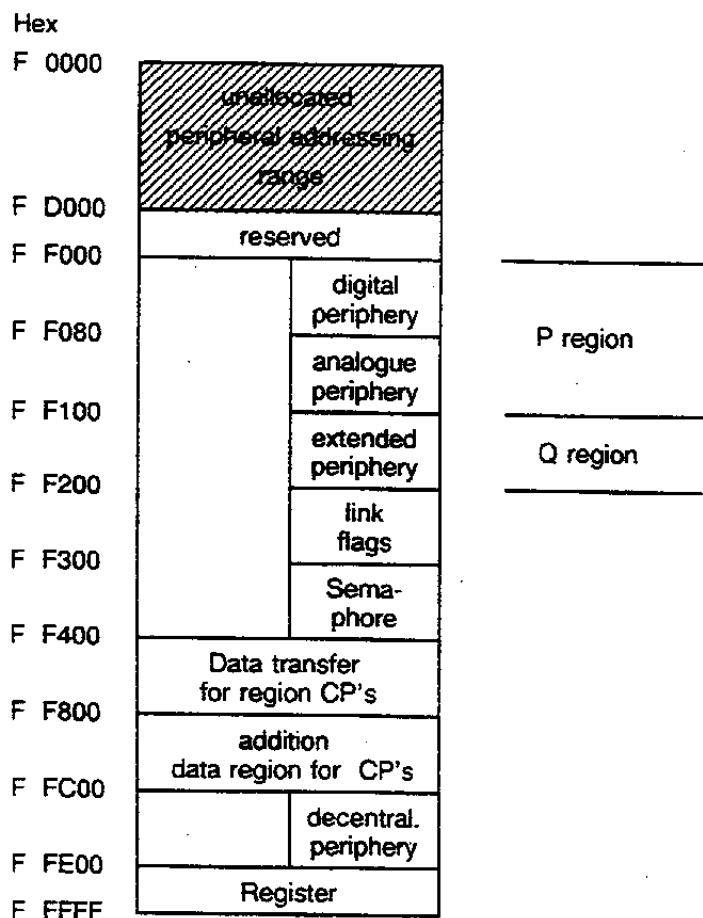

There is an unallocated addressing range of 52 K available for the WF 470. This addressing area shown above extends from F 0000 Hex to F CF00 Hex.

The addresses are in 256 byte steps, corresponding to 100 Hex. The address is set in a similar manner to other SIMATIC S5 controllers, e.g. only the 3rd and 4th digit of the Hex address is set. With the 155U, the 5th digit is automatically set to F. Examples of other address settings can be found in section 4.2.6.2.

Example setting: F 2100

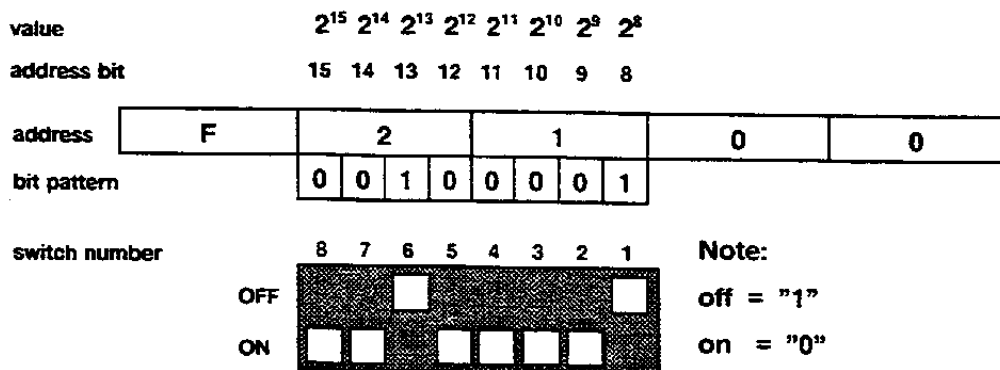

2.7 WF 470 External Connections

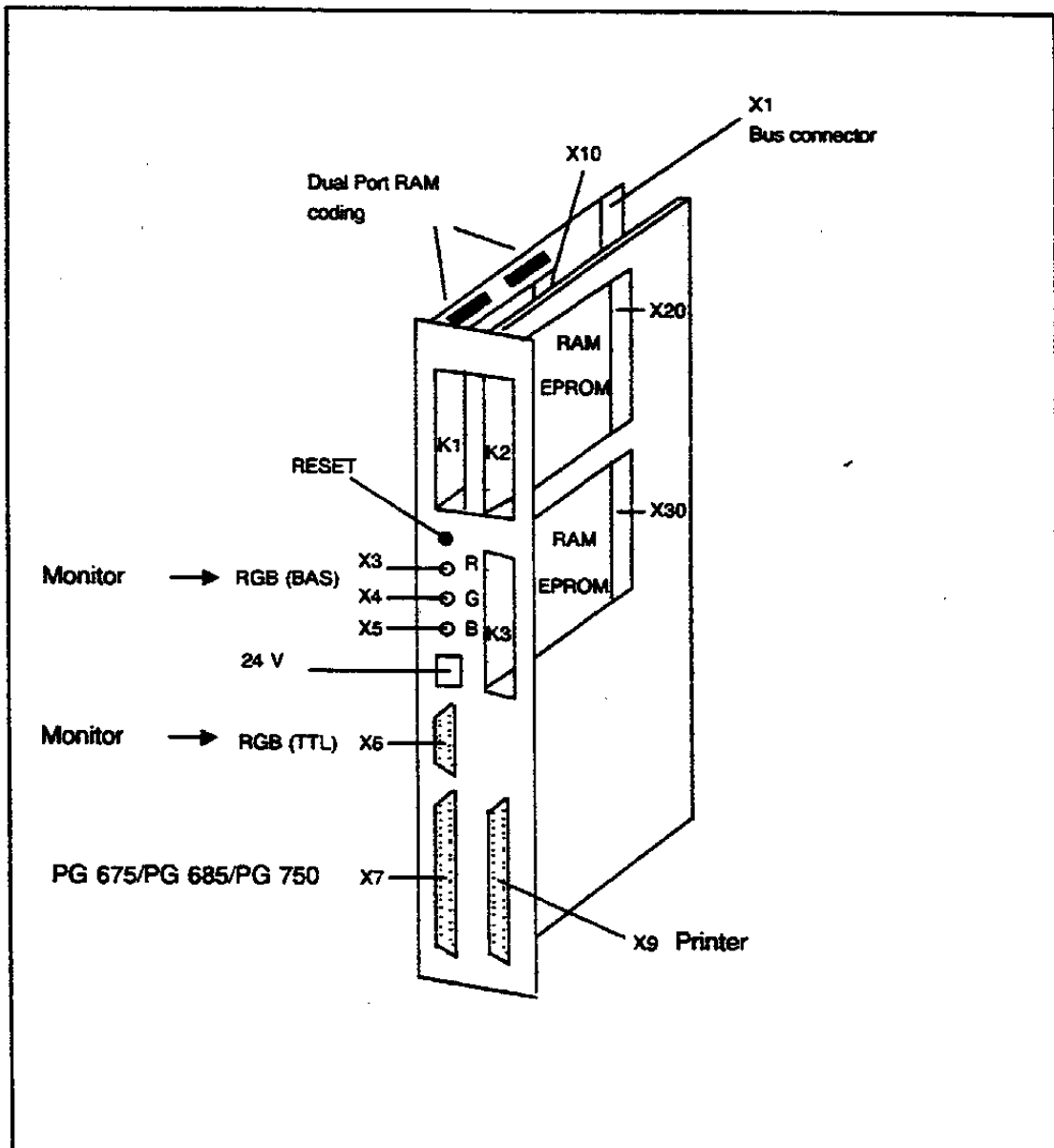

Fig 2.5 WF 470 external connections.

2.7.1 BAS (RGB) Monitor Connections X3, X4, X5

The modulated signal interfaces X3, X4, X5 allow monitors with the following specification to be connected.

- 3 x RGB/BAS signals (1 V_{pp}/75 Ohm) red, green, blue
- Synchronising signal VSYNC and HSYNC on the green channel (Vertical frequency 50Hz, Horizontal frequency 15,625 Hz)

In order to minimise interference pick-up, the cable length should be kept as short as possible. If cables of greater than 60m length are used, care should be taken in the cable routing to avoid potential sources of interference. By feeding in +5V from an external power supply to the TTL monitor D type connector, the picture quality and black level can be improved. It is also important to ensure that the central unit or expansion unit where the WF470 is installed is on the same phase as the monitor.

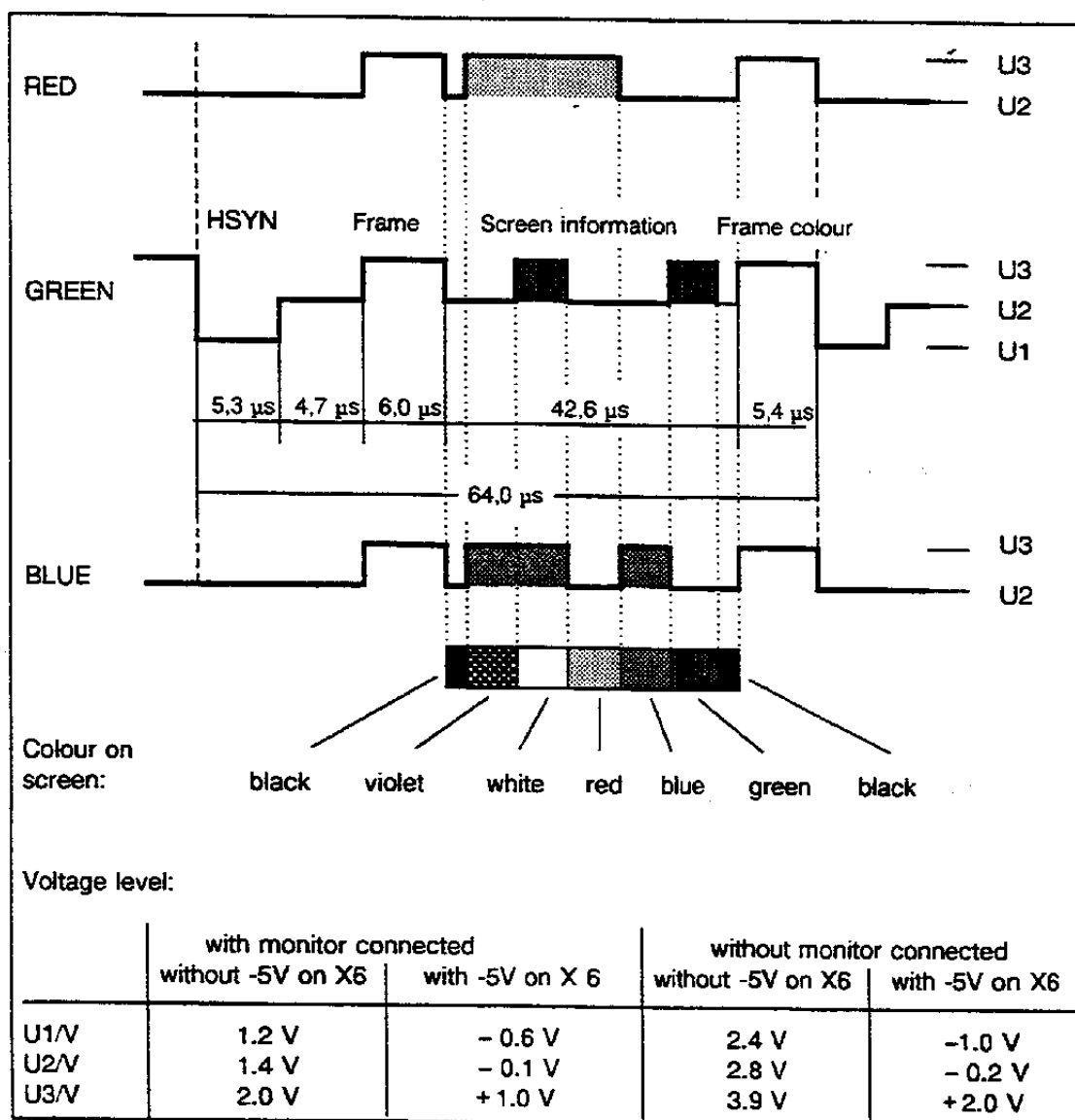
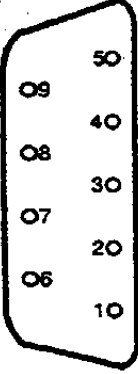

Fig 2.6 RGB/BAS Signal levels.

2.7.2 TTL monitor interface X6

The parallel monitor interface X6 provides signals at the TTL level for "PC" type data monitors.

X6 RGB/TTL 9 pol. D-sub miniature, sockets:

	Signal name	Description	Switching	
	9			
	8	+5V	5V for EL display connection	
	7	CLK	12 MHz pixel pulse for EL display	
	6	HSYNC	Horizontal synchronisation Line synchronisation	open collector 1 kOhm pull up
	5	VSYNC	Vertical synchronisation Frame synchronisation	open collector 1 kOhm pull up
	4	BLUE	Blue channel	open collector 150 Ohm pull up
	3	GREEN	Green channel	open collector 150 Ohm pull up
	2	RED	Red channel	open collector 150 Ohm pull up
	1	0V	0V for TTL-Logik	

***The maximum cable length of 2 meters must not be exceeded.
The standard colours cannot be changed if a TTL monitor is used.
With a monochrome monitor, shading and flashing cannot be used.***

DC/DC converter 24 V / 5 V for the WF 470

Order number: 6FM1 490 8BA00

**This additional feeding is no longer necessary for the new WF 470 modules
(with the last digit of 21 in the order number).**

By feeding in -5V on to socket X6 pin 9, the picture contrast and black level can be improved. The cable screen should only be earthed at one end. The length of the cable between the DC/DC converter and the WF 470 must not exceed 2 meters.

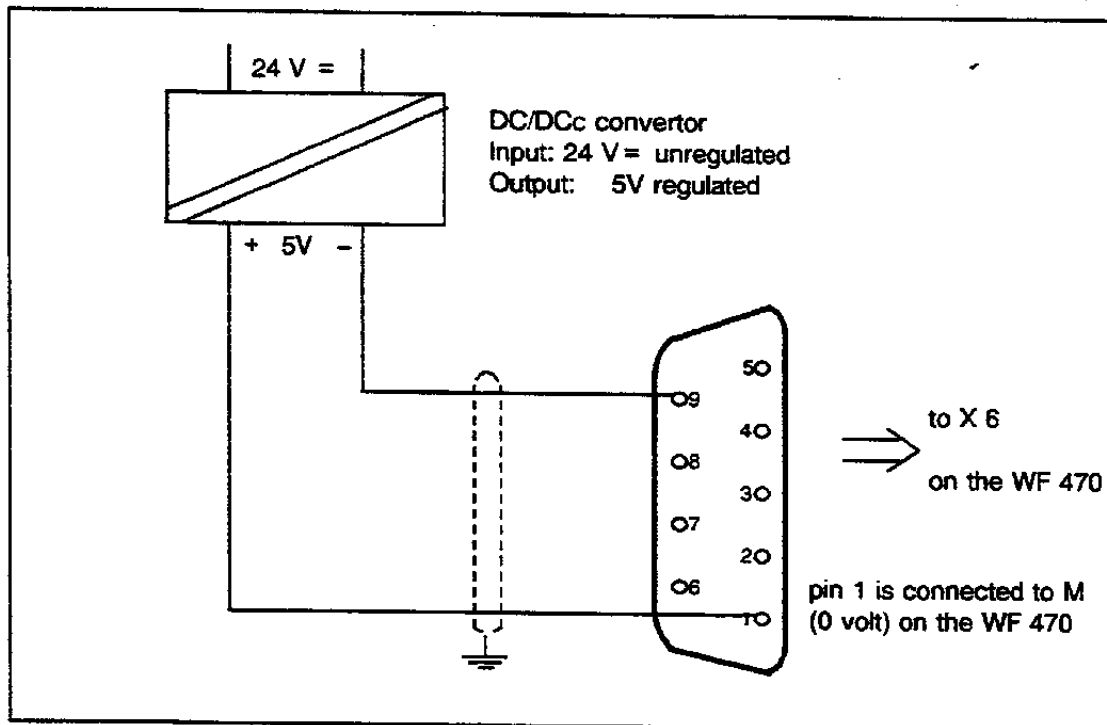

Fig. 2.7 Connection diagram DC/DC converter to WF 470.

2.7.3 Serial Interface - Base Board X7

This is used to connect the PG 675/PG 685/PG 750 for picture construction, or to connect the WS 495/496 operator panel.

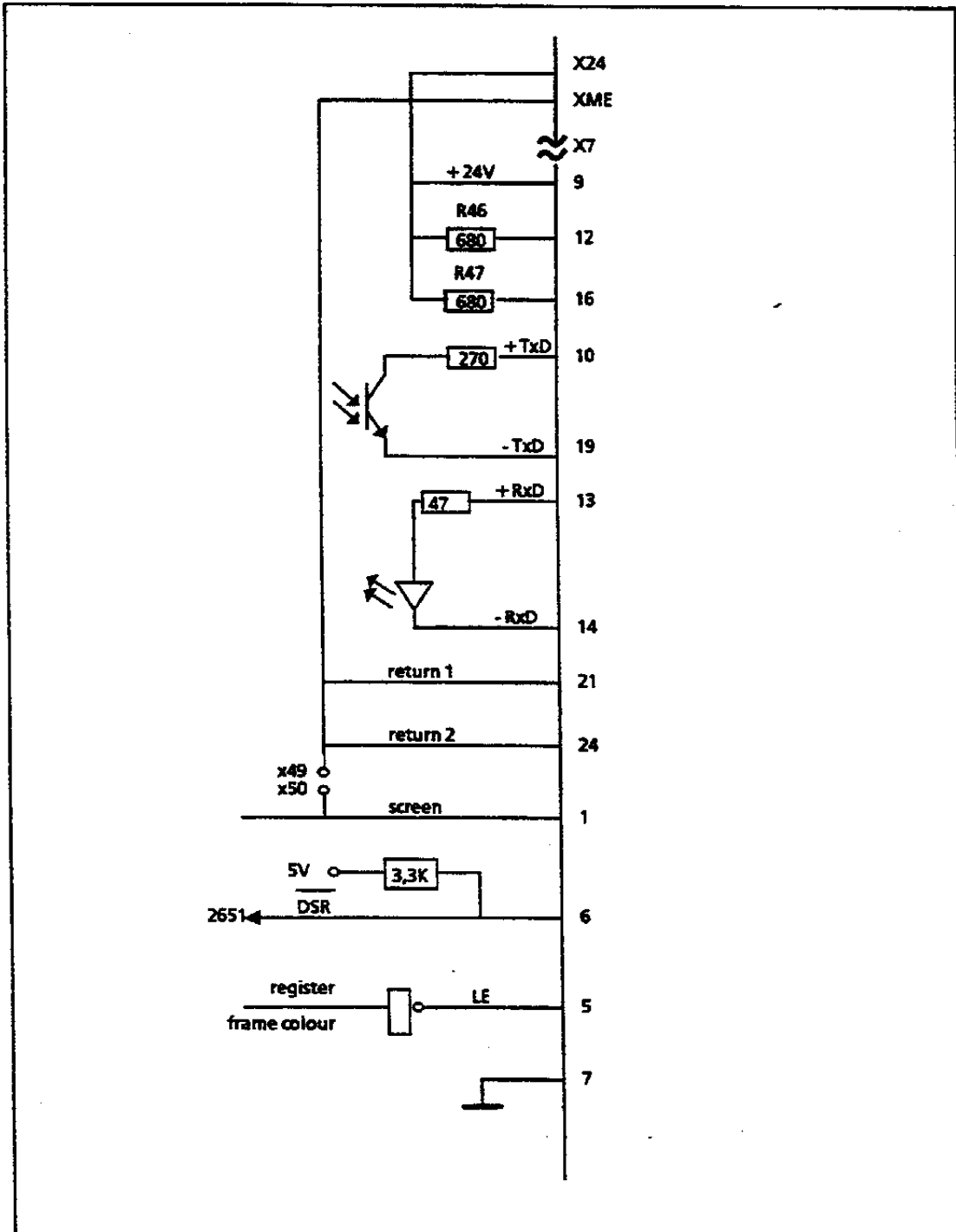

Fig 2.8 Interface X7 (25 pole Cannon, male).

2.7.4 Serial Interface Extension Board X9

This is used to connect the (TTY/V24) printer, I.E. PT88.

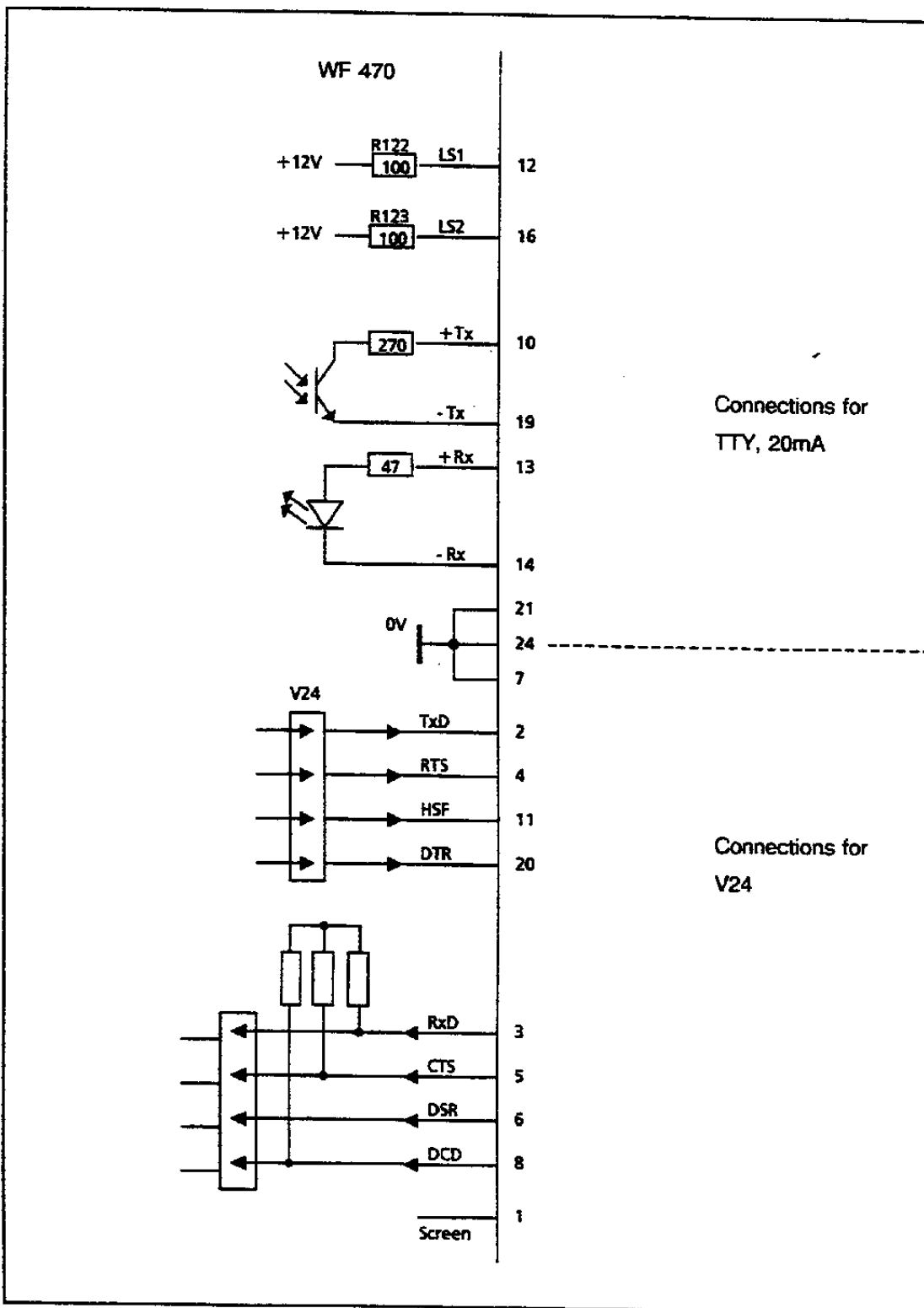

Fig 2.9 Connector X9 (25 pin cannon D type).

2.7.5 Sockets for memory modules X10, X20, X30

The following modules can be plugged into the memory sockets:

RAM	32	kByte	6ES5	377-0AB21
	64	kByte	6ES5	377-0AB31
	128	kByte	6ES5	377-0AB41
EPROM	32	kByte	6ES5	373-0AA41
	64	kByte	6ES5	373-0AA61
	128	kByte	6ES5	373-0AA81

These memory modules will contain the pictures, text etc.

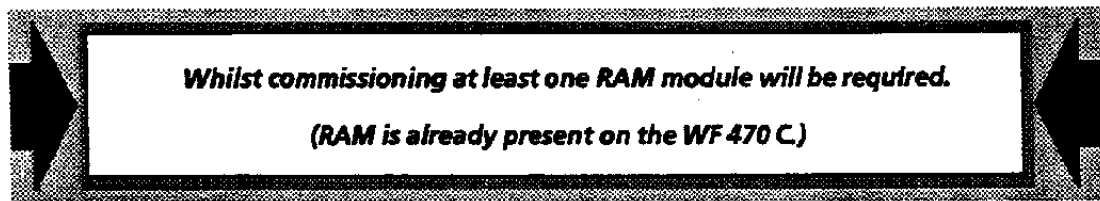

2.7.6 Bus Connector X1

Pin layout:

	d	b	z
2		0V	5 V
4	UBAT	PESP	
6	AB12	AB0	CPKL
8	AB13	AB1	MEMR
10	AB14	AB2	MEMW
12	AB15	AB3	RDY
14			
16		AB5	DB1
18		AB6	DB2
20		AB7	DB3
22		AB8	DB4
24		AB9	DB5
26		AB10	DB6
28	DSI	AB11	DB7
30		BASP	
32		0V	

2.8 Connection cables

2.8.1 Connection cables to sockets X3, X4, X5 - monitor connection

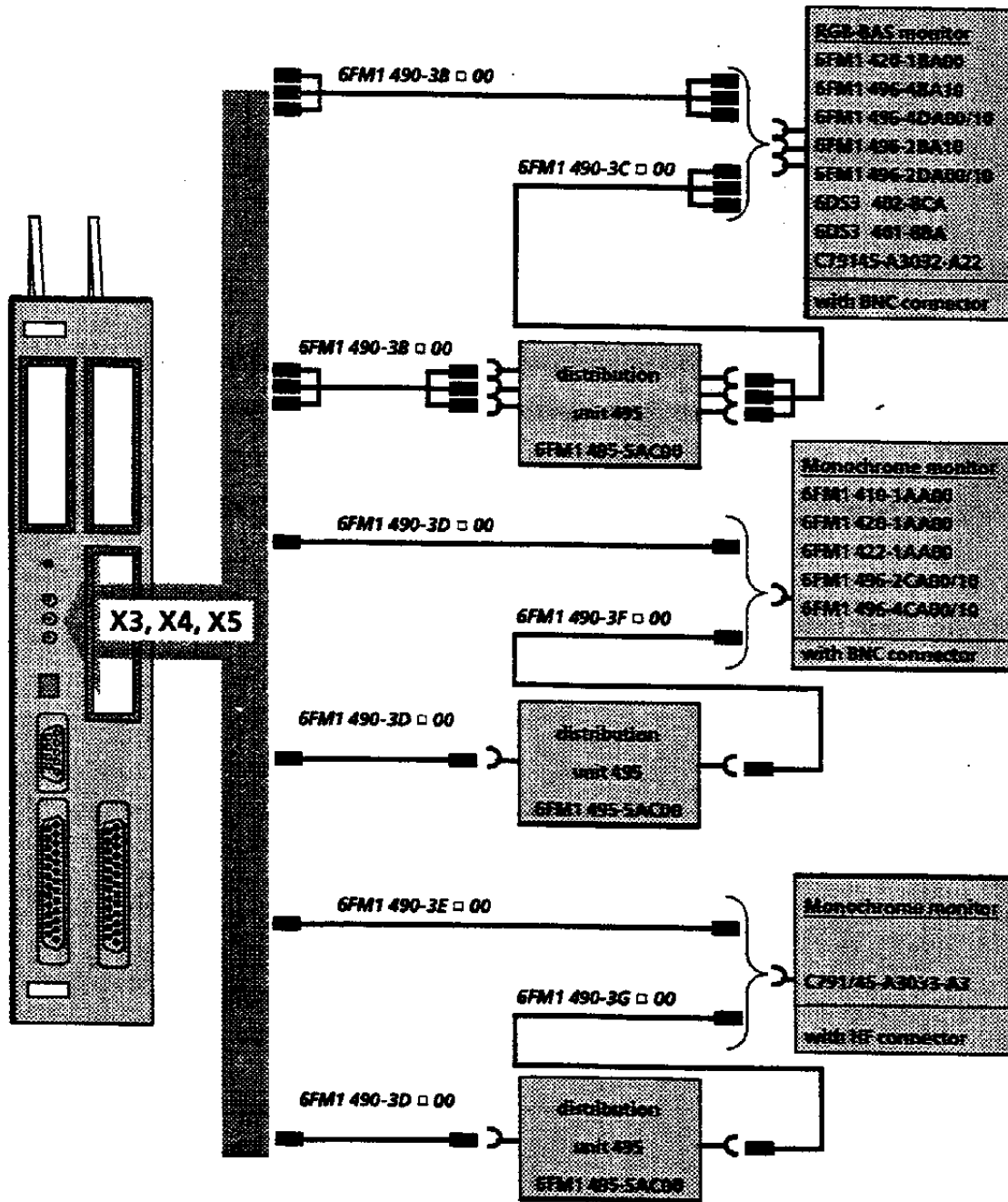

The distribution unit may be used, for example, to connect up to 3 WF 470 modules onto one monitor. Additional information about this unit may be found in the WS 495/496 operator system manual.

6FM1 790-1G □ 00

↑
Specify cable length here

2.8.2 Connection cable for socket X6

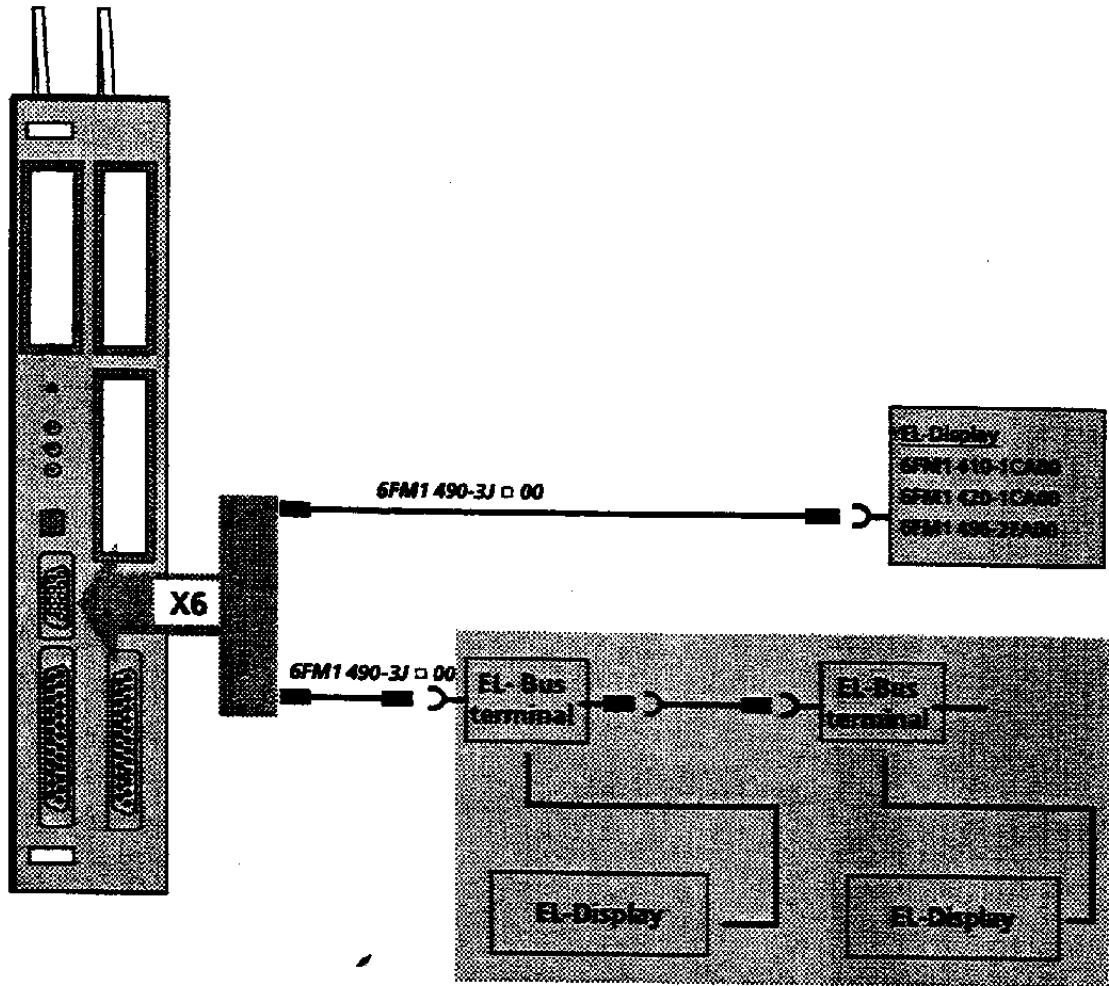

6FM1 790-1G □ 00

↑
Specify cable
length here

2.8.3 Connection cable for socket X7 - programming unit interface

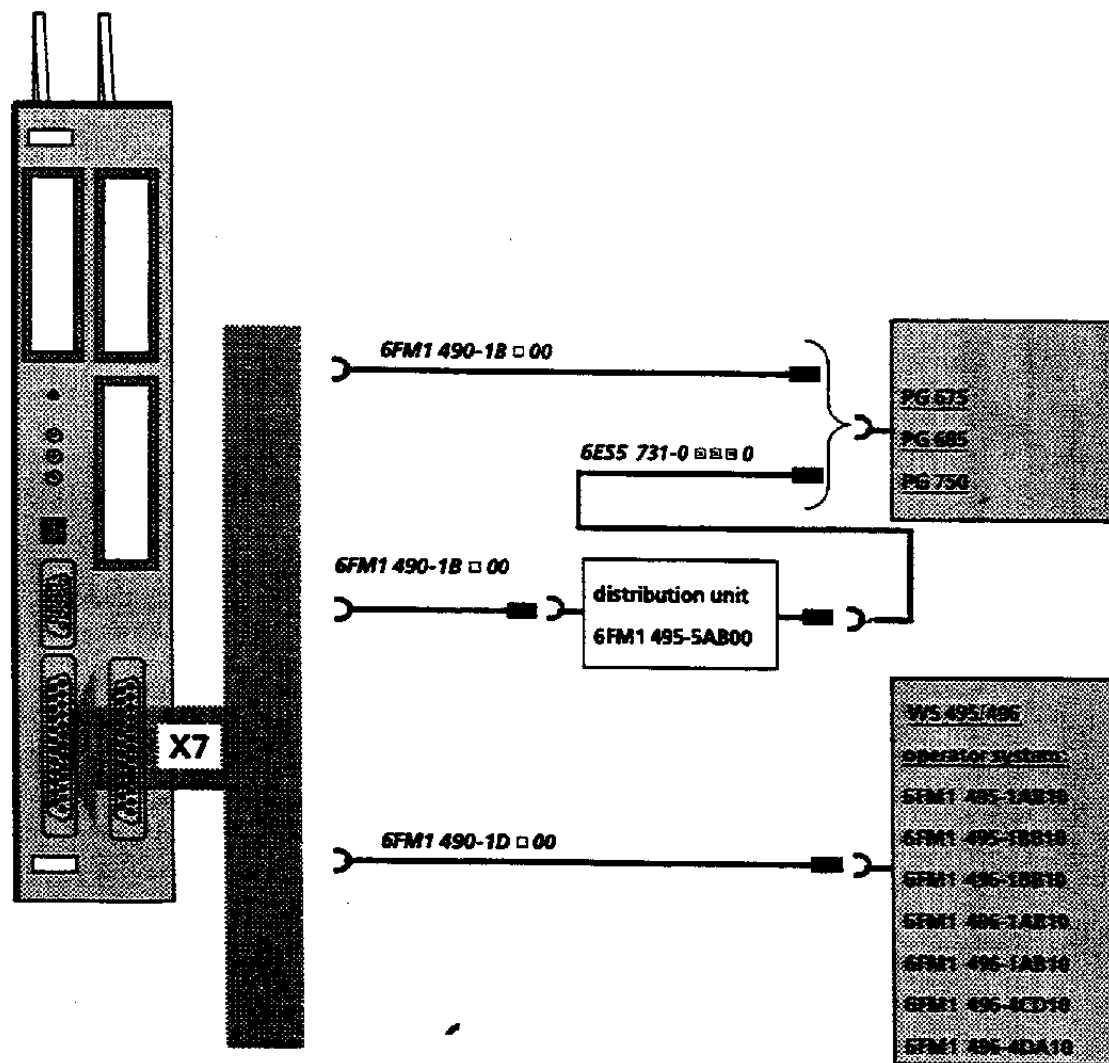

6FM1 790-1G □ 00
 ↑
 Specify cable
 length here

2.8.4 Connection cable for socket X9 - printer interface

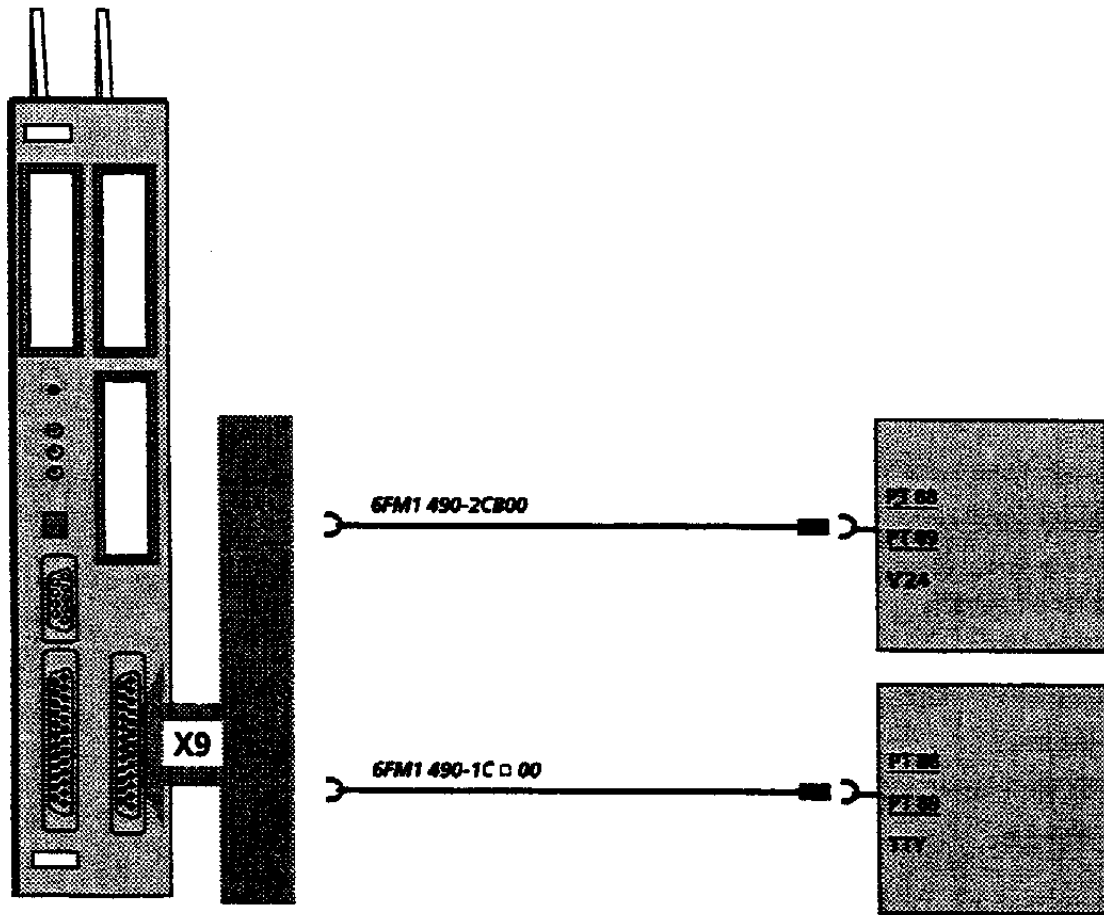

6FM1 790-1G 00
↑
Specify cable length here

2.8.5 Connection Cable WF470 - BAS-colour monitor

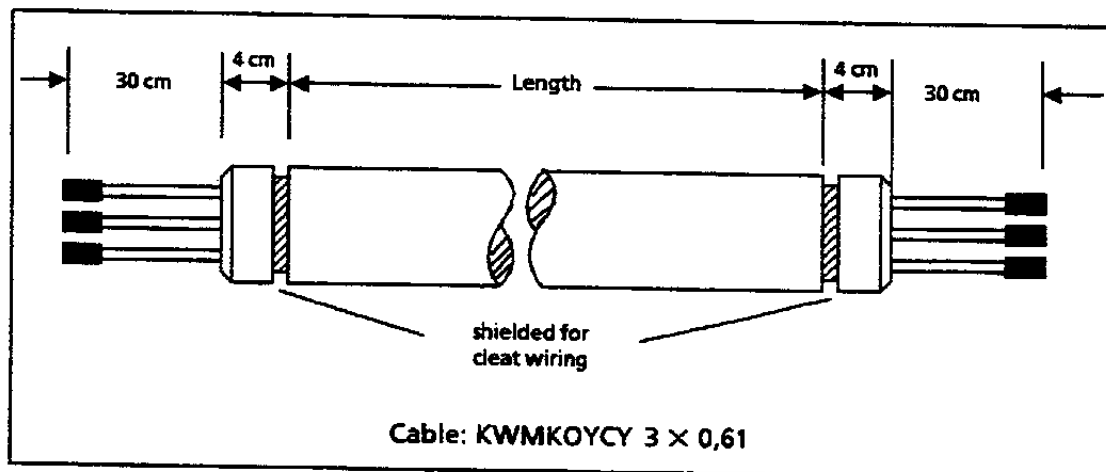

Cable specification:

3 x individual coaxial cables with pvc sheath encased in a polyurethane sheath, with an additional screen

Connector	HF connector or BNC connector		
Temperature range:	- 40° C to 90° C		
Protection:	Against oil and contaminant to VDE 472/804		
Minimum bending radius:	150mm		
Impedance:	20 MHz	6.1	dB/100m
	100 MHz	10.8	dB/100m
	200 MHz	21	dB/100m
	500 MHz	34.2	dB/100m
	1 GHz	48.1	dB/100m

For cable lengths greater than 60m additional measures must be taken to protect against interference. This may include earthing the cable screen at both ends.

The monitor and SIMATIC S5 must be on the same supply phase and at the same earth potential.

It is most important to check that the installation has been performed correctly, since failure to carry out these measures can lead to long term system unreliability.

2.8.6 Connection Cable WF470-TTL Monitor (Sanyo)

Order number: 6FM1 490-3AA00
 Cable length: 2m

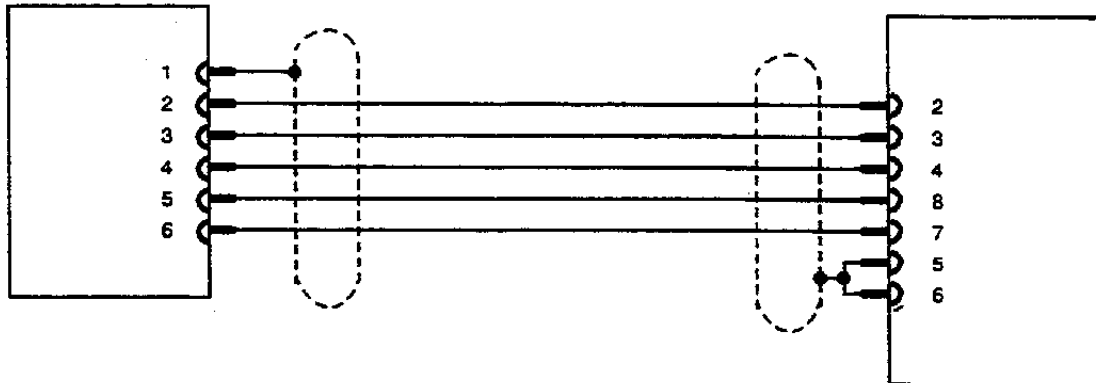

WF 470
 Cannon plug
 9 pole male
 Plug type : Id.-No. 400 220 35
 Cover: Id.-No. 400 329 52

Sanyo monitor CDB 3030 H
 Sanyo WAKW Connector
 8 pole male
 Type CDO 3030 H

2.8.7 Connection cable WF 470 - PG 675 / PG 685 or PG 750 WF 470 distribution unit

Cable order number: 6FM1 490-1B . 00

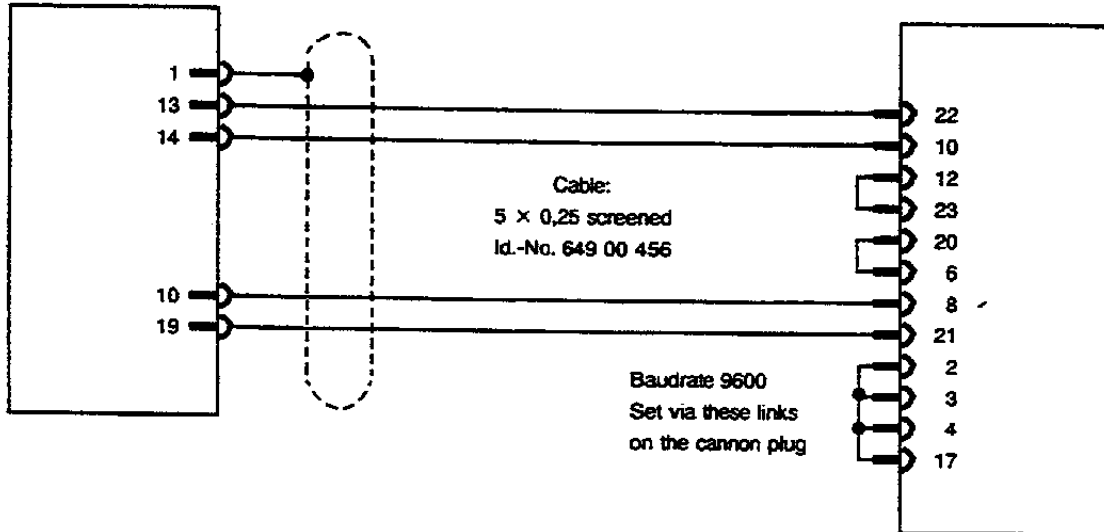

Cannon connector

25pole female
Plug type:
Id.-No. 40022251
Cover:
ID.-No. 40091587
connection side



Cannon connector

25pole male
Plug type:
Id.-No. 40022273
Cover:
ID.-No. 40023443
Clip:
Id.-No. 40023445
connection side

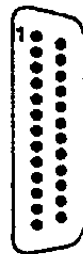

2.8.8 Cable connection for WF 470 B/C - printer PT88/89

2.8.8.1 V24 Interface

Cable order number: 6FM1 490-2CB00

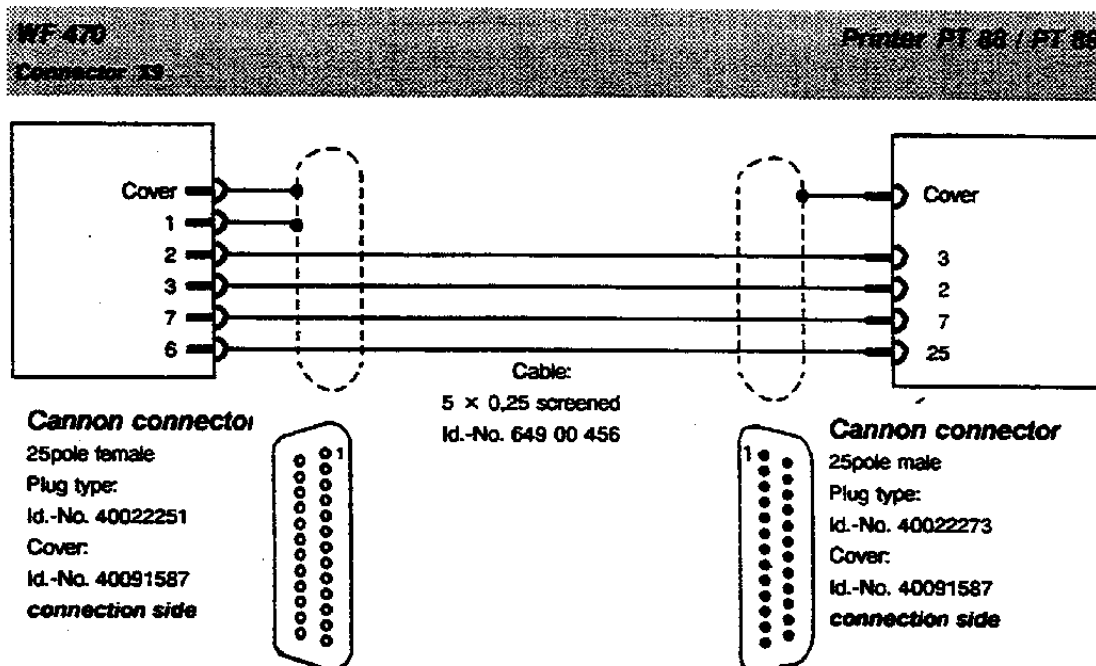

2.8.8.2 TTY Interface

Cable order number: 6FM1 490-1C . 00

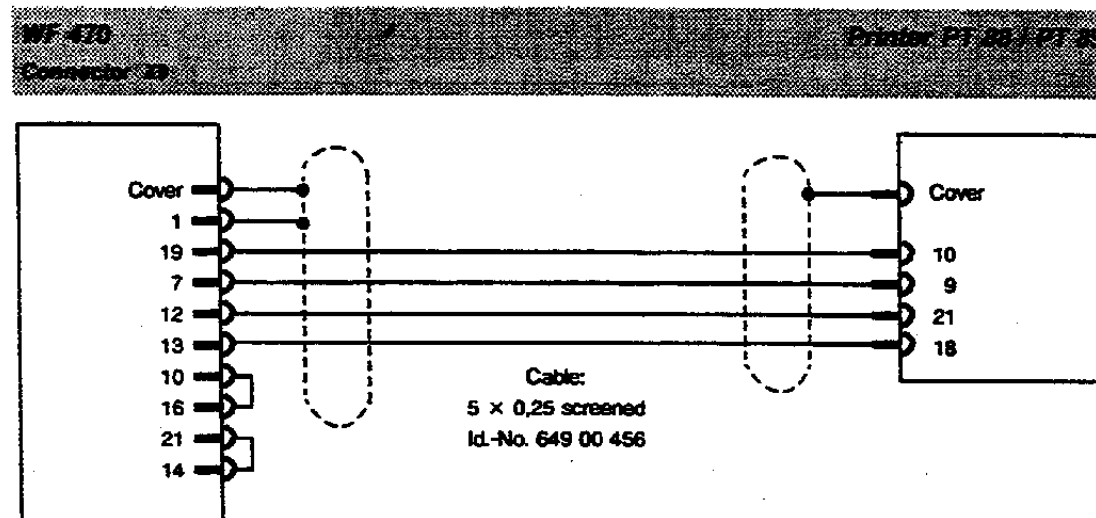

2.9 Peripheral devices

2.9.1 Operator Interface System

2.9.1.1 Operator panel WS 496

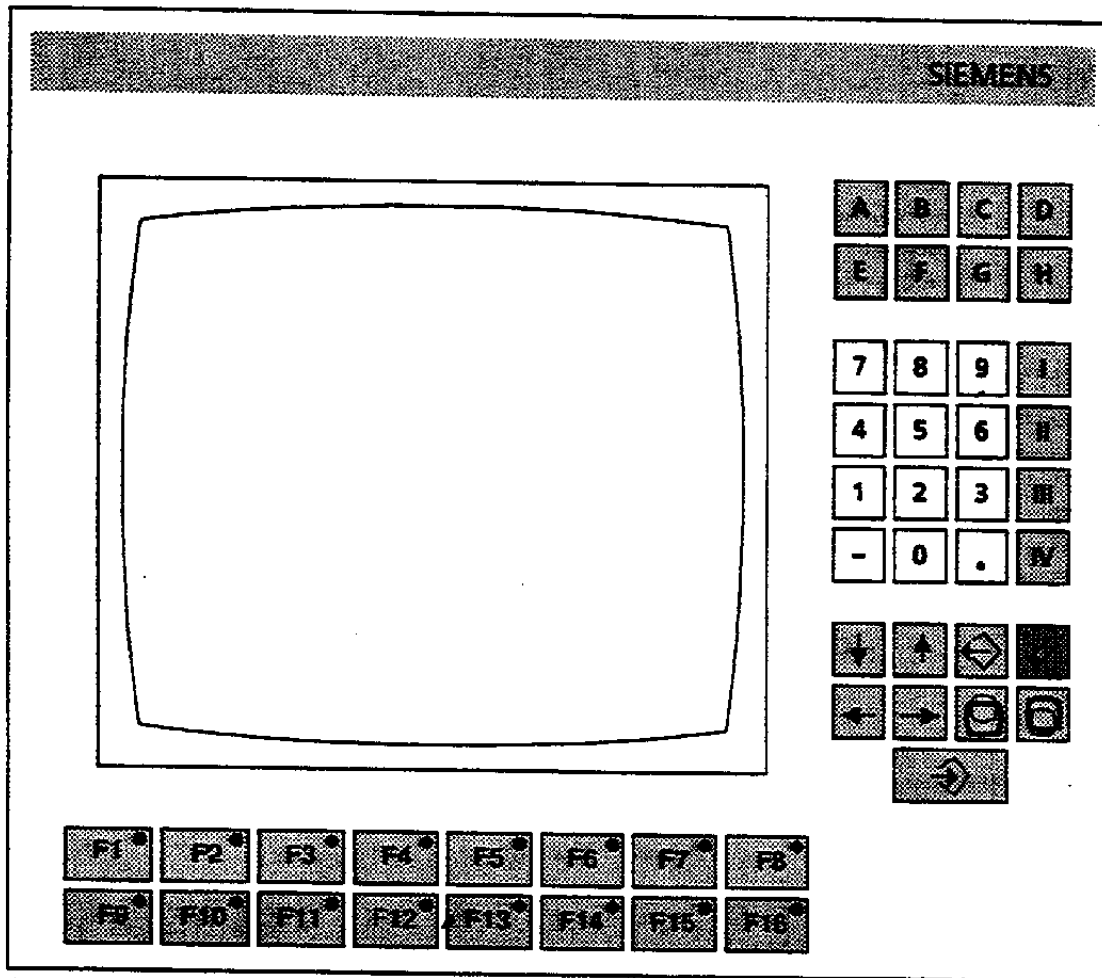

Fig 2.15 WS 400 operator panel.

The operator panel consists of a monitor (either a 14" - colour monitor or a 12" - monochrome monitor) and a surrounding keyboard. The keyboard has the following keys:

- 2 X 8 Function keys (F1 - F16).
- Each function key incorporates a red LED. These are powered by outputs in the PLC and controlled by the application software.
- Alpha keys labeled A to H.
- A complete numeric key pad including decimal point and minus sign.
- Four additional "dedicated function" keys labeled I to IV (for cursor positioning, SW-Reset, Scroll, data input).

Alternatively to the compact operator panel, individual monitors can be used which have the WS 495/ WS 496 keyboard.

Further details can be found in the description "WS 495/ WS 496 Operator system".

2.9.1.2 Operator panels WS 400-10, WS 400-20 and WS 400-22

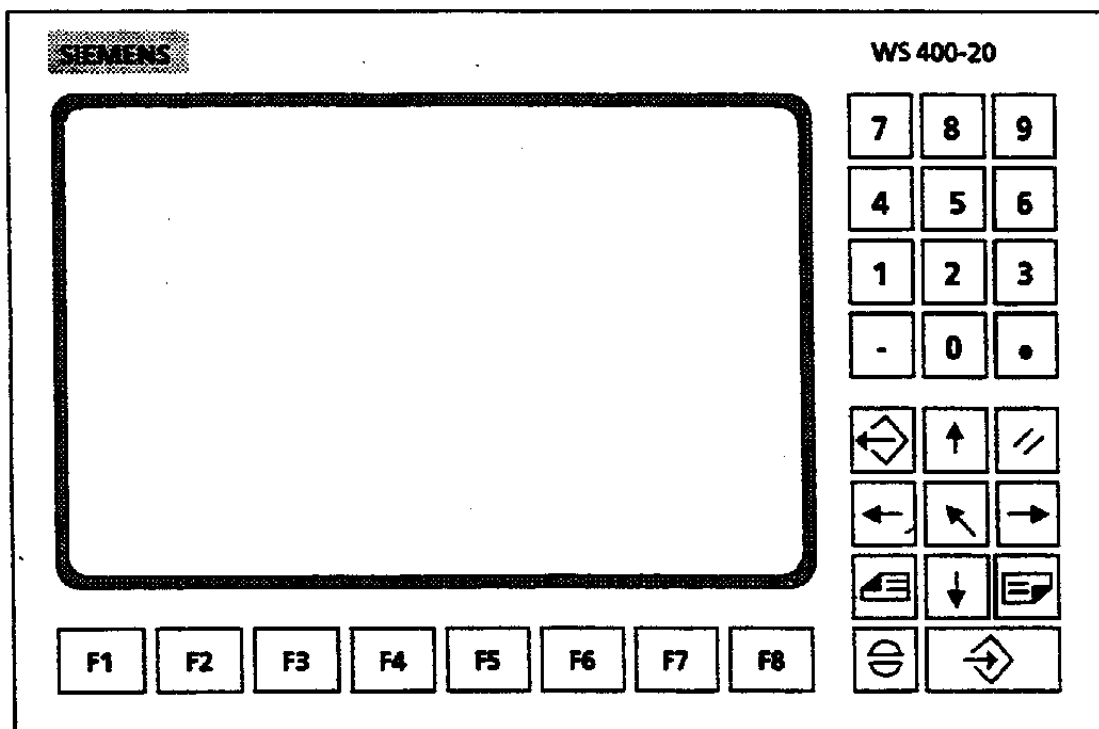

Fig. 2.16 Operator panel WS 400-20

The operator panels have 8 (WS 400-10 und WS 400-20) or 16 (WS 400-22) function keys, a complete numerical field (not for WS 400-10) with decimal point, minus sign and special keys (not for WS 400-10) for cursor positioning, data input, output of the overview mask, delete function, scroll and acknowledgement of faults.

The operator panel WS 400-10 is available with a 9"-Monochrome-Monitor or EL-Display, the WS 400-20 is available with a 09"- Farb- or Monochrome-Monitor or EL-Display, and the WS 400-22 is available with a 9"-Monochrome-Monitor.

Further information can be found in the description for the operator panels.

2.9.2 PT 88 Printer

The WF 470 B/C version 3.0 and above, can be connected to any standard printer with a V 24 or a TTY interface. The printer parameters can be set on the WF 470 using a PG (page 2 of the system data list).

The following settings and cable details are for a PT 88 printer.

Permitted Versions	Order Number
Ink Jet Printer - TTY Interface (20mA with mains cable)	S22761-A88-A048
Ink Jet Printer Interface CCI/TT V24/V28 (RS 232 C) with mains cable	S22761-A88-A029
Needle Printer, TTY Interface 20mA with mains cable	S22761-A88-A047
Needle Printer Interface CCI/TT V24/V28 (RS 232 C) with mains cable	S22761-A88-A049

Technical details are available in the printer manual, order number A22761-A88-A11-1-7635.

If the PT88 is to be used in conjunction with the WF 470 B/C, the switches must be set as follows:

2.9.2.1 V24 interface SAP-S1

DIL switch below the printer head

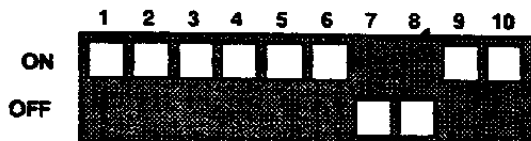

The position of the slide switch is shown in white

Switch S1:

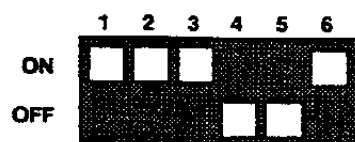

The position of the slide switch is shown in white

Switch S2:

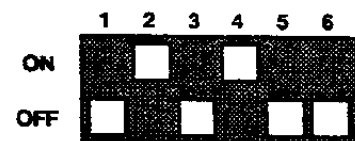

The position of the slide switch is shown in white

2.9.2.2 TTY Interface SAP-S2

DIL switch below the printer head

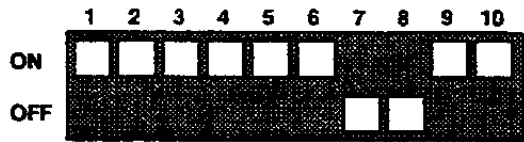

The position of the slide switch is shown in white

Switch S1:

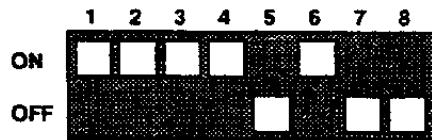

The position of the slide switch is shown in white

Switch S2:

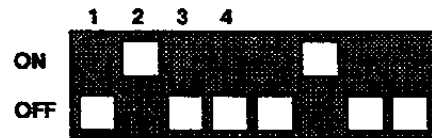

The position of the slide switch is shown in white

2.9.2.3 Universal Interface S22767-B3-A100 - V24

DIL switch below the printer head

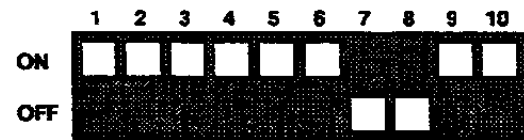

The position of the slide switch is shown in white

Switch S1:

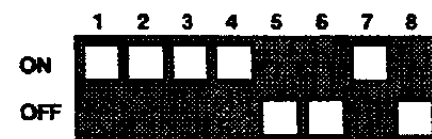

The position of the slide switch is shown in white

Switch S4:



The position of the slide switch is shown in white

Switches S2 and S3 are only used for the TTY interface-see section 2.9.2.4.

2.9.2.4 Universal Interface S22767-B3-A100 - TTY

DIL switch below the printer head

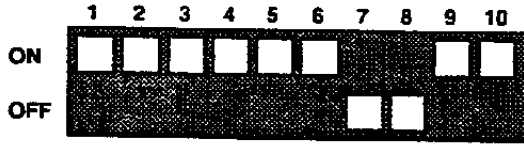

The position of the slide switch is shown in white

Switch S1:

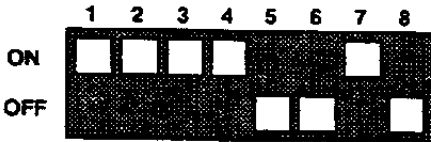

The position of the slide switch is shown in white

Switch S2:

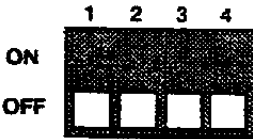

The position of the slide switch is shown in white

Switch S3:

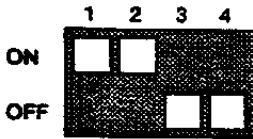

The position of the slide switch is shown in white

Switch S4:



The position of the slide switch is shown in white

2.9.3 WF470 Picture Construction Terminal

The picture construction terminal takes the form of a PG 675 / PG 685 / PG 750 with a specially developed picture construction software package.

This package requires:

- CP/M-86 Operating system 6ES5 875-0CA11
 - WF 470 Picture construction software 6FM1 470-8B□20*)
- } for PG 675
- PCP/M Operating system (contained in S5-DOS)
 - WF 470 Picture construction software 6FM1 470-C□20 *)
- } for PG 685
- PCP/M Operating system (contained in S5-DOS)
 - WF 470 Picture construction software 6FM1 470-D□20 *)
- } for PG 750

*) The letter at the location □ is specifies the language :

- A = German
- E = English
- F = French
- R = Russian

The PG 675 / PG 685 / PG 750 is connected to the WF 470 via a special cable described in section 2.8.3. which is plugged into the PG programming port.

If required, a PT 88 printer connected to the PG printer interface can be used to document the pictures and texts.

3 Operation

3.1 SIMATIC standard software

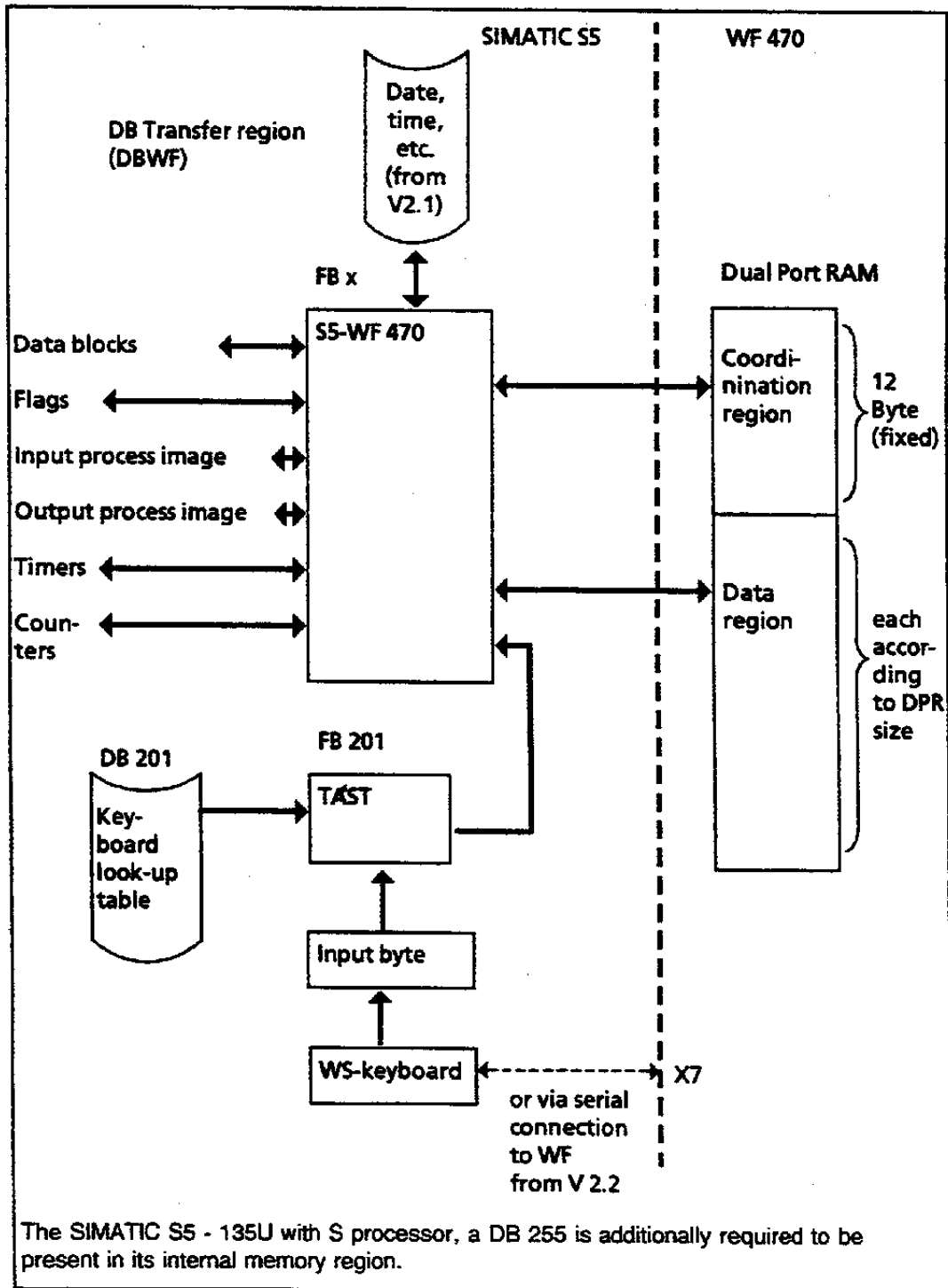

Fig 3.1 S5 standard software

3.1.1 Data Link WF470-S5

The data exchange between the WF 470 and the S5 takes place in a DUAL PORT RAM situated on the WF 470 module.

Communication at the S5 end of the dual port ram is handled by a standard function block. It has access to all data blocks, flags etc. and to the dual port ram.

The WF 470 is in charge of all data exchanges between the 470 and the PLC, and places data requests in the dual port ram in the form of a series of commands. The standard FB recognises these commands, carries them out and responds by returning the requested data or by sending an error number.

For each data exchange, the FB must be processed twice. The maximum amount of data exchanged each time is determined by the size of the dual port ram. The function block must be called unconditionally (JU FB) once every S5 cycle.

3.1.1.1 Technical Data

	S5-130 WB S5-150 K + cent unit	S5-150 K with Peripheral module	S5-150 S S5-150 U	S5-155 U	S5-115 U + CPU 941, 942, 943, 944	S5-135 U + CPU 921	S5-135 U + CPU 922, 928
Block number	FB 255	FB 254	FB 253	FB 248	FB 251 *	FB 252	FB 249
Lib number	E88530-B4132-B	E88530-B4132-B	E88530-B4132-D	E88530-B4136-D	E88530-B4132-A	E88530-B4132-C	E88530-B4132-C
Block name	S5-WF 470	S5-WF 470	S5-WF 470	S5-WF 470	S5-WF 470	S5-WF 470	S5-WF 470
Block size	299 words	294 words	299 words	303 words	256 words	369 words	273 words
Call length	8	8	8	8	8	8	8
Processing time for 122 DW	0.5 to 2.6ms	0.38 to 15.64ms	0.32 to 11.89ms	0.2 to 1.5ms	5.1 to 32ms 1.5 to 20.1ms 0.22 to 11.89ms	1.6 to 1.5ms	1.1 to 3.9ms
Nesting depth	0	0	0	0	0	0	0
Block calls	none	none	none	none	none	none	none
System data	BS 253	BS 253	BS 243	BS 60	none	none	none
Flags used (scratch pad)	FY 236-255	FY 236-255	FY 240-255	FY 234-255	FY 234-255	FY 234-255	FY 234-255
Timers	none	none	none	none	none	none	none
Counters	none	none	none	none	none	none	none
Data blocks	none	none	none	none	none	DB 255 in internal region	none

* The function block number for the SIMATIC S5 115 U must be changed from its standard number of FB251 to another number when it is transferred into the PLC, since FB251 has now been allocated as an integrated function block.

All function and data blocks have standard numbers. They can be changed if required and any unallocated block number used.

3.1.1.2 Function Block Parametrisation

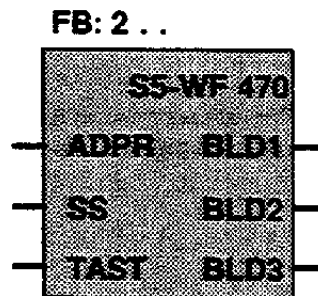

Parameter	Function	Comment	Type	Form	Valid value
ADPR	Start address Dual Port RAM	Hexadecimal coded	D	KH	see Section 4.2
SS	Key switch		I	BI	I 0.0-127.7 F 0.0-199.7 Q 0.0-127.7
TAST	Keyboard byte	From program or FB TAST...	I	BY	FY 0-199
BLD1 BLD2 BLD3	Pic sel 1 Pic sel 2 Pic sel 3	Select picture and picture selected	Q	BY	FY 0-199 QB 0 -127

Please note:

- The TAST-byte must only be written in for one S5 cycle.
The WF 470 acknowledges that the code has been accepted and the function block S5-WF 470 erases the code entered into the byte by writing the value 00 into the TAST byte.
- BLD 1-3 must only be written in for one S5 cycle to select the picture or report printout.
The WF 470 sends the picture code number of the actual picture being displayed back to the PC as an acknowledgement and this is written into BLD 1-3.
- The BLD1-3 can be used to initiate a print out.

3.1.1.3 Data Block "Transfer block (DBWF)"

From firmware version V2.1, the first 20 data words of this block are reserved and hold the information described below. Data words ≥ 20 contain the data for the sequence analyser function if it is being used. (See section 3.2.3.3).

The data block number is specified in the system data list which is programmed using the picture construction system on the PG 675 / PG 685 / PG 750.

	DL	DR	
DW 0			
DW 1		second	The date and time are binary coded. Update is triggered from the TAST byte. (E2/E3)
DW 2		minute	
DW 3		hour	
DW 4		day	
DW 5		month	
DW 6		year	
DW 7	Field type	Field no. in binary	The number of the input field where the cursor is positioned. (E6/E7) (bit 0 to 8)
DW 8	Printer status	Report no..	
DW 9	printer function		This is explained in section 3.2.2 If the serial keyboard is being used, and one of the function keys F1 to F16 is pressed, a corresponding bit will be set in DW 10. If the extended function key module with 24 additional function keys is used, bits in DW11-DW12 will be set. When the key is released, the bit remains high.
DW 10			
DW 11			
DW 12			
DW 13	reserved		
DW 19	reserved		
DW 20	data for the sequence analyser		

3.1.2 Keyboard function block WF 470 TAST

If the keyboard is connected to the SIMATIC S5 via an 8 way 24 volt input module, the keyboard evaluation is performed by a separate function block (FB-TAST) and a keyboard code look-up table. The FB-TAST should be called unconditionally (JU FB TAST) once every PLC cycle.

If the serial keyboard connection is used, FB TAST and DB 201 are not required. The function keys are shown in data word 10 of the DBWF. Attention should be paid to assigning F1-F16 to the bits 0-15 in the data word 10. The bit should not be reset when the key is no longer pressed. Therefore, the function keys cannot be used for the "Jog-mode". When the FB 220 (Bildlist) is used, the DW 10 can be transferred to the parameter FKTS. Example: If FKTS is MW 100, the following must be programmed:

```

A   DB ... Call DBWF
L   DL 101
T   MB 101
L   DR 10
T   MB 100
L   KB 0
T   DW 10

```

} DW 10 to parameter FKTS

} DW 10 set back

3.1.2.1 Technical data

	S5-130 WB S5-150 K + cent unit	S5-150 S S5-150 U	S5-155 U	S5-115 U + CPU 941, 942, 943, 944	S5-135 U + CPU 921, 922, 928
Block number	FB 201 (202)	FB 201 (202)	FB 201 (202)	FB 201 (202)	FB 201 (202)
Lib number	E88530-B4132-B	E88530-B4132-D	E88530-B4136-D	E88530-B4132-A	E88530-B4132-C
Blockname	TAST-130	TAST-150S	TAST-150S	TAST-115	TAST-135
Block length	106 (120) words	106 (120) words	91 words	100 (112) words	106 (120) words
Block size	8	8	8	8	8
Nesting depth	0	0	0	0	0
Block calls	none	none	none	none	none
System data	BS 253	none	none	none	none
Flags used (scratchpad)	FY 248-255 (FY 245-255)	FY 248-255 (FY 245-255)	FY 248-255 (FY 245-255)	FY 248-255 (FY 245-255)	FY 248-255 (FY 245-255)
Timers	none	none	none	none	none
Counters	none	none	none	none	none
Data blocks	see parameter EBOB	see parameter EBDB	see parameter EBDB	see parameter EBDB	see parameter EBDB

All function and data blocks have standard numbers. They can be changed if required and any unallocated block number used.

3.1.2.2 Parameters

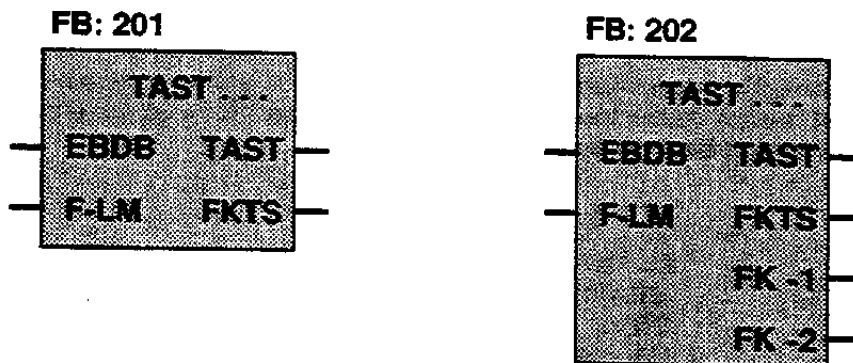

Parameter	Function	Comment	Type	Form	Valid value
EBDB	EB: input byte DB: DBnumber keycode list	EB > 127: no evaluation DB = 0: no evaluation	D	KY	KY = EB, DB IB = 0 - 127 DB = 1 - 255
F-LM	Pulse flag	unused flag or output	I	BI	F 0.0...199.7 Q 0.0...127.7
TAST	Key code	see code look-up table	Q	W	FW 0 - 199 QW 0 - 127
FKTS	Function keys	Each F-key = 1 bit	Q	W	FW 0 - 198 QW 0 - 126
FK -1	Key code extension	only with FB 202	Q	W	FW 0 - 198 QW 0 - 126
FK -2	Key code extension	only with FB 202	Q	BY	FY 0 - 199 QB 0 - 127

The WS 496 operating panel can also have an additional 24 function key user-dedicated custom keyboard. If this custom keyboard is required, FB202 should be used instead of FB201 and the last two parameters on the list specified for the 24 additional function keys. The other parameters are the same as FB 201. If the "Alpha block" keyboard is connected to the panel instead of the custom keyboard, FB201 can be used.

3.1.2.3 Keyboard look-up table - DB 201

The standard keyboard function block FB 201 operates in conjunction with a data block. This data block, DB 201, is a look-up table which contains a data word for each key on the keyboard. The allocation of individual keys to data words comes from each keys' unique code.

When a key on the operator panel is pressed, its key code will be output. This key code signal is connected to the input byte in the PLC, which is specified in the EBDB parameter in the call to FB 201.

For instance, pressing function key F16 starts output of key code 18 Hex (which is 24 in decimal). Data Word 24 in the DB 201 look-up table contains the special code for this key (97F9). In the PLC'S MC5 language this code (97F9) means "S F 249.7". The keyboard function block FB 201 processes this instruction to set the flag, and hence sets the corresponding bit in the flag word allocated to parameter FKTS to indicate which function key has been pressed.

The A key has a key code 22 Hex or 34 decimal. Data word 34 contains the Hex number (0041). The keyboard function block will therefore pass the code 41 to the flag byte allocated to the parameter "TAST". Hex 41 is the ASCII coding for the letter A.

You can easily change the function of any key on the keyboard, by changing the contents of the data word in the look-up table to the required code. The contents of the left byte of the data word tells the function block if it is to output the code to the TAST byte, or set a flag in the FKTS word.

If 00 is in data word left (DL), the right hand part of the data word (DR) is output to the TAST byte.

If the left hand byte (DL) is not 00, the code is processed as a function key or a function key from the customer keyboard. Each of these keys has an auxiliary flag associated with it. Flags F245.0 to 247.7 are used by the user dedicated module and flags F248.0 to F249.7 are for the function keys. The whole data word is then processed as an instruction (in MC-5 code). Only instructions in the range S F 245.0 to S F 249.7 are valid.

Allocation: Keycode - Data word no - contents of word - key

Key code	DW No.	Contents (hex)		Function	Comment	
		DL	DR			
00	00	DL	DR			
		██████				
01	01	90	F8	F1	Flag	FKTS.0 (AF 248.0)
02	02	91	F8	F2	Flag	FKTS.1 (AF 248.1)
03	03	92	F8	F3	Flag	FKTS.2 (AF 248.2)
04	04	93	F8	F4	Flag	FKTS.3 (AF 248.3)
05	05	94	F8	F5	Flag	FKTS.4 (AF 248.4)
06	06	95	F8	F6	Flag	FKTS.5 (AF 248.5)
07	07	96	F8	F7	Flag	FKTS.6 (AF 248.6)
08	08	97	F8	F8	Flag	FKTS.7 (AF 248.7)
09	09	90	F7	customer module	Flag	FK - 2.0 (AF 247.0)
0A	10	91	F7	customer module	Flag	FK - 2.1 (AF 247.1)
0B	11	92	F7	customer module	Flag	FK - 2.2 (AF 247.2)
0C	12	93	F7	customer module	Flag	FK - 2.3 (AF 247.3)
0D	13	94	F7	customer module	Flag	FK - 2.4 (AF 247.4)
0E	14	95	F7	customer module	Flag	FK - 2.5 (AF 247.5)
0F	15	96	F7	customer module	Flag	FK - 2.6 (AF 247.6)
10	16	00	00	unused		
11	17	90	F9	F9	Flag	FKTS-1.0 (AF 249.0)
12	18	91	F9	F10	Flag	FKTS-1.1 (AF 249.1)
13	19	92	F9	F11	Flag	FKTS-1.2 (AF 249.2)
14	20	93	F9	F12	Flag	FKTS-1.3 (AF 249.3)
15	21	94	F9	F13	Flag	FKTS-1.4 (AF 249.4)
16	22	95	F9	F14	Flag	FKTS-1.5 (AF 249.5)
17	23	96	F9	F15	Flag	FKTS-1.6 (AF 249.6)
18	24	97	F9	F16	Flag	FKTS-1.7 (AF 249.7)
19	25	97	F7	customer module	Flag	FK - 2.7 (AF 247.7)
1A	26	00	00	unused		
1B	27	00	00	unused		
1C	28	00	00	unused		
1D	29	00	00	unused		
1E	30	00	00	unused		
1F	31	00	00	unused		

Key code	DW No.	Contents (hex)	Function	Comment
20	32	DL DR 00 00	unused	
21	33	00 25	%	
22	34	00 41	A	
23	35	00 42	B	
24	36	00 43	C	
25	37	00 44	D	
26	38	00 45	E	
27	39	00 46	F	
28	40	00 00		
29	41	00 37	7	
2A	42	00 38	8	
2B	43	00 39	9	
2C	44	00 14	◀	Selection function mask (CTRL T)
2D	45	00 11	//	Software reset (CTRL K)
2E	46	00 00		
2F	47	00 00		
30	48			
31	49	00 47	G	
32	50	00 48	H	
33	51	00 49	I	
34	52	00 4A	J	
35	53	00 4B	K	
36	54	00 4C	L	
37	55	00 4D	M	
38	56	00 00		
39	57	00 34	4	
3A	58	00 35	5	
3B	59	00 36	6	
3C	60	00 90	↓	Cursor down
3D	61	00 8F	↑	Cursor up
3E	62	00 00		
3F	63	00 00		
40	64	00 00		
41	65	00 4E	N	
42	66	00 4F	O	
43	67	00 50	P	
44	68	00 51	Q	
45	69	00 52	R	
46	70	00 53	S	
47	71	00 54	T	
48	72	00 40	@	Select report printout code
49	73	00 31	1	
4A	74	00 32	2	
4B	75	00 33	3	
4C	76	00 92	←	Cursor left
4D	77	00 91	→	Cursor right
4E	78	00 00		
4F	79	00 00		

Key code	DW No.	Contents (hex)	Function	Comment
		DL DR		
50	80	00 00		
51	81	00 55	U	
52	82	00 56	V	
53	83	00 57	W	
54	84	00 58	X	
55	85	00 59	Y	
56	86	00 5A	Z	
57	87	00 2B	+	
58	88	00 23	#	Standard picture code
59	89	00 2D	-	
5A	90	00 30	∅	
5B	91	00 2E		
5C	92	00 8D	⏪	Scroll up
5D	93	00 8C	⏩	Scroll down
5E	94	00 00		
5F	95	00 00		
60	96	00 00		
61	97	00 2F	/	
62	98	00 3A	:	
63	99	00 3D	=	
64	100	00 28	(
65	101	00 29)	
66	102	00 3F	?	
67	103	00 2C	,	
68	104	00 20		SPACE
69	105	00 86	I	Toggle cursor Text/ V-field
6A	106	00 85	II	Next Variable field
6B	107	00 84	III	Previous Variable field
6C	108	00 04	IV	Erase error message
6D	109	00 0A	↵	Line feed
6E	110	00 00		
6F	111	00 00		
70	112	90 F5	customer module	Flag FK-1.0 (AF 245.0)
71	113		customer module	Flag FK-1.1 (AF245.1)
72	114		customer module	Flag FK-1.2 (AF 245.2)
73	115		customer module	Flag FK-1.3 (AF 245.3)
74	116		customer module	Flag FK-1.4 (AF 245.4)
75	117		customer module	Flag FK-1.5 (AF 245.5)
76	118		customer module	Flag FK-1.6 (AF 245.6)
77	119		customer module	Flag FK-1.7 (AF245.7)
78	120		customer module	Flag FK - 1 + 1.0 (AF 246.0)
79	121		customer module	Flag FK - 1 + 1.1 (AF 246.1)
7A	122		customer module	Flag FK - 1 + 1.2 (AF 246.2)
7B	123		customer module	Flag FK - 1 + 1.3 (AF 246.3)
7C	124		customer module	Flag FK - 1 + 1.4 (AF 246.4)
7D	125		customer module	Flag FK - 1 + 1.5 (AF 246.5)
7E	126		customer module	Flag FK - 1 + 1.6 (AF 246.6)
7F	127		customer module	Flag FK - 1 + 1.7 (AF 246.7)

3.1.2.4 Valid keyboard codes for the contents of data word right

Code (Hex)	Description	
00	no key code	
01	CTRL A : Process picture directory	
02	CTRL B : Interrupt field input	
04	CTRL D : Acknowledge error message in mask	
0A	LF : Terminate entry	
11	CTRL K : SW Reset	
14	CTRL T: Select function mask	
20 . 7F	} Full ASCII character set including rub-out	
84		Previous field in list
85		Next field in list
86	Toggle between text window - V field	
8C	Directory scroll up	
8D	Directory scroll up	
8F	Cursor up/Text window scroll up	
90	Cursor down/Text window scroll up	
91	Cursor right	
92	Cursor left	
AF	Cursor to next field left	
B0	Cursor to next field right	
DF	Force screen bright	
E0	Force screen dark	
E1	Special function (must not be used)	
E2	READ CLOCK (time / data from WF into DB) from V2.1	
E3	SET CLOCK (time / data from DB to WF) from V2.1	
E4	Start printer function (from V 2.2)	
E5	Stop printer function (from V 3.0)	
E6	Read cursor position in DB (from V 2.2)	
E7	Read cursor position in DB (from V 2.2)	
E8	Activate transfer function in DW 9 (from V 3.0)	
E9	Activate input field cursor positioning (from V 3.0)	
F0 . FF	} Error 100 Error text in the message line on the screen which can be initiated by the application program	
		Error 115

3.1.3 "DAT-IN" Function block

The DAT-IN function block can be used to tell the applications program that data has been entered from the WF 470. The program is informed that a data entry has been made, and the destination of the data (Data block, Data word) is passed to the application program for processing. This information is present for one S5 cycle.

The function block should be called unconditionally (JU FB) once per cycle, if possible after the S5 - WF 470 function block.

3.1.3.1 Technical data

	S5-130 WB S5-150 K + cent unit	S5-150 S S5-150 U	S5-155 U	S5-115 U + CPU 941, 942, 943, 944	S5-135 U + CPU 921, 922, 928
Block number	FB 240	FB 240	FB 240	FB 240	FB 240
Lib number	E88530-B4132-B	E88530-B4132-D	E88530-B4136-D	E88530-B4132-A	E88530-B4132-C
Block name	DAT-IN	DAT-IN	DAT-IN	DAT-IN	DAT-IN
Block size	42 words	42 words	48 words	42 words	47 words
Call length	7	7	7	7	7
Nesting depth	0	0	0	0	0
Block calls	none	none	none	none	none
System data	none	none	none	none	none
Flags used (scratchpad)	FY 240-255	FY 240-255	FY 240-255	FY 240-255	FY 240-255
Timers	none	none	none	none	none
Counters	none	none	none	none	none
Data blocks	none	none	none	none	none

3.1.3.2 Parameterisation

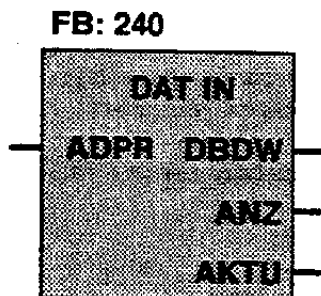

Parameter	Function	Comment	Type	Form	Valid value
ADPR	Start address Dual Port RAM	hexadecimal coded	D	KH	see section 4.1.3
DBDW	Data block Data word	destination of data	Q	W	FW 0 - 198 QW 0 - 126
ANZ	Number	Number of words transferred	Q	BY	FY 0 - 199 QB 0 - 127
AKTU	New data available		Q	BI	F 0.0 - 199.7 Q 0.0 - 127.7

The AKTU bit will remain high for at least 1 S5 cycle.

The values in parameters DBDW and ANZ are changed each time a new value is transferred from the WF 470 to the PLC.

3.1.4 Picture selection function block Bildlist.

FB 220 Bildlist is designed to perform:

- Picture selection from function keys, of up to 169 pictures
- Calling of different function blocks according to which picture is currently displayed
- Transfer to the WF 470 of special key codes via the TAST byte
- Transfer of signals via flags to the picture specific function block

3.1.4.1 Technical data

	SS-130 WB SS-150 K + cent unit	SS-150 S SS-150 U	SS-155 U	SS-115 U + CPU 941, 942, 943, 944	SS-135 U + CPU 921	SS-135 U + CPU 922, 928
Block number	FB 220	FB 220	FB 220	FB 220	FB 220	FB 221
Lib number	E88530-B4132-B	E88530-B4132-D	E88530-B4136-D	E88530-B4132-A	E88530-B4132-C	E88530-B4132-C
Block name	BILDLIST	BILDLIST	BILDLIST	BILDLIST	BILDLIST	BILDLIST
Block size	391 words	376 words	385 words	435 words	377 words	378 words
Call length	10	10	10	10	10	10
Nesting depth	1	1	1	1	1	1
System data	none	none	none	none	none	none
Flags used	FY 240-255	FY 240-255	FY 240-255	FY 240-255	FY 240-255	FY 240-255
Blocks called	FB in pic list	FB in pic list	FB in pic list	FB in pic list	FB in pic list	FB in pic list
Timers	none	none	none	none	none	none
Counters	none	none	none	none	none	none
Data blocks	see parameter	see parameter	see parameter	see parameter	see parameter	see parameter

3.1.4.2 Function block parameterisation

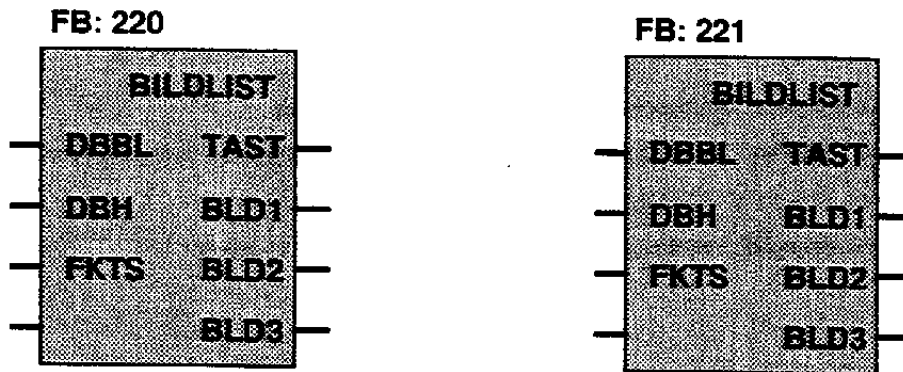

Parameter	Function	Comment	Type	Form	Valid value
DBBL	Picture list data block number	DBBL can be stored in EPROM Each picture requires 12 data words	B	-	DB No.2 - 255
DBH	Scratchpad data block	Must be in RAM Data words 0-14 are used by FB 220	B	-	DB No.2 - 255
FKTS	Binary codes from the function keys (from FB "TAST")	Must be the same word that is specified in the FB TAST parameter	I	-	FW 0 ... 198
BLD1 BLD2 BLD3	Picture code 1 Picture code 2 Picture code 3	Parameter to select WF 470 picture number. Must be the same as FB S5 - WF 470 parameters	Q	BY	FY 0 ... 199
TAST	Key code to the WF 470	Must be the same as parameter TAST on FB S5 - WF 470 and FB TAST	Q	BY	FY 0 ... FY 199

Function block FB 220 operates in conjunction with the data block DBBL. This data block must be created and set up by the user. The data block number is freely selectable and is specified via the parameter DBBL.

The maximum length of data blocks is limited by the programming unit to approx. 2000 words or sufficient for 169 pictures.

The control information required by FB 220, for each picture which can be selected, occupies 12 data words.

The layout of this control information in the data block is shown below. Each "block" of information must start at a data word number which can be divided by 12, for instance:

Block 0 = DW 0 to DW 11
 Block 1 = DW 12 to DW 23
 etc.

DW-No			Data Format
0	free	BLD1	KS
1	BLD2	BLD3	KS
2		Pic. Spec. FB No.	KY
3	Specify pic. selection or TAST code		KM
4	F1 pic. No./Tast code	F2 pic. No./Tast code	KY
5	F3 pic. No./Tast code	F4 pic. No./Tast code	KY
6	F5 pic. No./Tast code	F6 pic. No./Tast code	KY
7	F7 pic. No./Tast code	F8 pic. No./Tast code	KY
8	F9 pic. No./Tast code	F10 pic. No./Tast code	KY
9	F11 pic. No./Tast code	F12 pic. No./Tast code	KY
10	F13 pic. No./Tast code	F14 pic. No./Tast code	KY
11	F15 pic. No./Tast code	F16 pic. No./Tast code	KY

DW 0 and DW 1:

These data words specify the picture number to which the control information belongs.

DW 2:

This data word contains the number of the function block which is to be called when this picture is on the screen. If it contains 0, no function block will be called. (The function block called cannot have parameters.)

DW 3:

The 16 bits in DW 3 are allocated to the 16 function keys. Bit 0 belongs to F1, Bit 1 - F2 etc. If bit 1 in DW 3 is high, then the value contained in the corresponding data byte will be output as a TAST code. For instance if the data byte contained "E4 Hex", then pressing F1 would start the printer function.

DW 4 to DW 11:

These data bytes are used to specify which picture is called when one of the function keys F1 to F16 is pressed. This is done by entering the block number of the required picture in the corresponding byte.

If a function key is not used, a dummy value of 255, or its own block number can be entered.

If a value of 254 is entered, when the function key is pressed, the previously displayed picture will be automatically re-selected.

Flags - Passed to the picture specific FB.

FB 220 passes flags to the function block called when a particular picture is on the screen. These are as follows:

F 247.1 - Pulse flag - on picture change, for one FB scan

F 247.3 - Pulse flag - on picture change, on the last FB scan

F 247.7 - If flag 247.7 is set to 1 by the picture specific FB, then picture change by FB 220 will be inhibited.

FW 250 The function key bits are set as pulse flags in this flag word, and can be evaluated by the picture specific FB. F 251.0 = F1, F250.7 = F16 etc.

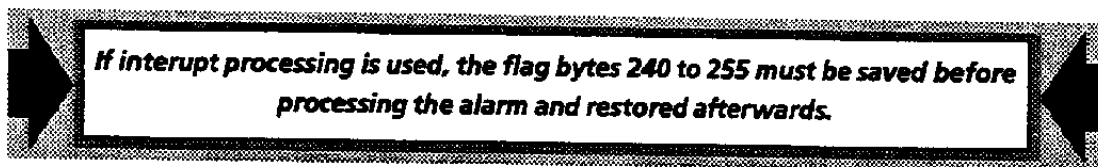
**Auxiliary data block DBH:**

The auxiliary data block DBH should be created by the user. It is used by FB 220 for scratchpad data, and must therefore be in RAM.

If a specific picture is required to be displayed on start-up (warm restart or cold restart of the PLC), a program should be called from OB20-22 which overwrites DW 2 to 7 and DW 10 to 14 with KH 0000, and DW 1 with KH 0001. The picture number which is specified in block 0 will then be automatically called. DW 8 and 9 are used by the standard III software for the WF 725/WF 726.

Search

If a picture is not selected by FB 220 but called directly from the WF 470 picture selection mask or from another FB, the function block searches for the picture number in the DBBL data block and then behaves as normal.

If the selected picture number does not appear in DBBL, the first picture block is selected, and the function key allocation in this block will be used.

3.2 S5 Software Options

The software options (service module, printer, graph 5 and sequence diagnostics) are supplied on a separate disk. With picture construction versions up to V 2.1, the required options must be transferred to the picture construction disk F00 using PIP, and then loaded into the WF 470 memory. When using a PG 675 with picture construction software versions V 2.3 and above, the option software should be transferred to the picture data disk.

When using a PG 685, the option should be transferred to the hard disk. Each option is self-contained, and operates independently.

The standard pictures used by these options can have softkey legends allocated to them by entering the required texts into the special text group # SK. Each option picture has a specific text list:

TG Code: T#SK TG Name: softkey text

Code: Name

N000	Softkeytext	Schrittketten	=	Sequence analyser text
N001	Softkeytext	Service module	=	Service module text
N002	Softkeytext	Graph5 Bild 1	=	Graph5 picture 1
N003	Softkeytext	Graph5 Bild 2	=	Graph5 picture 2
N004	Softkeytext	SchrKett Bild 1	=	Sequence analyser pic. 1
N005	Softkeytext	SchrKett Bild 2	=	Sequence analyser pic. 2
N006	S5-Meldetext		=	S5 error texts.

The text group is supplied with the picture construction software disk and should be transferred to the application data disk. The COPY TG function *MUST* be used to do this, and *NOT* the CPM PIP command.

The structure of these lists must not be changed. The existing text can be overwritten with the required text for each function key. Lists which are not required may be erased. The field "DB No." in the list is not used in this context, the data block number entered here need not be present in the PLC.

3.2.1 Service module

The service module is a firmware option which can be loaded into the WF 470, no additional software is required in the SIMATIC S5 for its operation.

The service module allows the operator to display the status of inputs, outputs, flags, peripheral and data words together with timer and counter values. These are displayed in three formats; as a bit pattern, as a hexadecimal and as a decimal number. An example display is shown at the top of page 1-6.

Values can also be changed or 'forced' when the keyswitch parameter bit S5 in the S5 - WF 470 function block is set to "1".

The service module is displayed in the WF 470 as a normal picture. When loaded, it appears in the picture directory with the special code number #02.

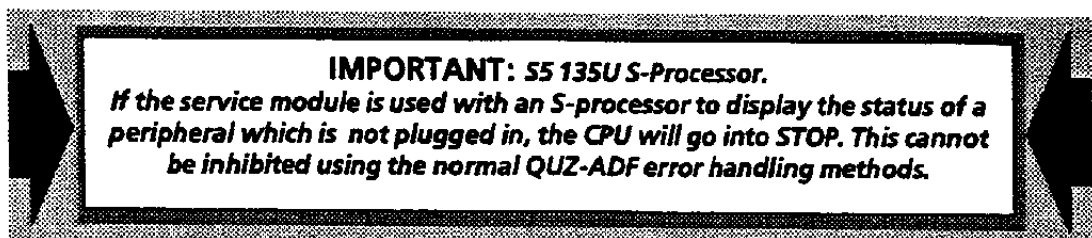

3.2.2 Printer function

This firmware option enables the WF 470 printer port to be used. No additional S5 software is required for its operation. Report pages which have been generated and loaded into the WF 470 will be displayed in the printout directory. A printout is initiated in the same way as a picture selected, e.g. by writing the printout number into the S5 - WF 470 function block's BLD1, 2, 3 bytes.

3.2.2.1 "Transfer block" data block

The first twenty words of the transfer block data block are used to hold the information described below: (from WF 470 V2.1).

The data block number is specified using the PG 675/685 in picture construction mode via the "system data list".

	DL	DR	
DW 1		second	} The date and time are binary coded. Update is triggered from the TAST byte (E2/E3).
DW 2		minute	
DW 3		hour	
DW 4		day	
DW 5		month	
DW 6		year	
DW 7	Field type	Field No. in decimal	} The number and code of the input field where the cursor is / is to be re-positioned. (E6/E7) (bit 0 to 8).
DW 8	Printer status	printout number	
DW 9	Printout function		

Data word 8 - printer function status

- bit 00 to 05 Number of the report being printed
- bit 08 Output to printer active
- bit 09 Requested printout not present
- bit 10 Printer not connected (bit is set after 20 sec wait)
- bit 11 not used
- bit 12 event log not activated
- bit 13 Printer function not started
- bit 14 Printer function not loaded into WF 470
- bit 15 Event message buffer has room for less than 50 messages.

When the status is present, the associated bit will be high.

Data word 9 - printer control word

Data word 9 in the data transfer data block contains the following control information:

- Bit 00 to 07 Number of the report to be printed out (in binary)
Bit 8 + 9 binary coded output mode:
0 + 0 No printer output
1 + 0 Output of the report printout and event log
1 + 1 Output of only the event log
0 + 1 Output of only the report printouts
- Bit 10 Not used
Bit 11 Not used
Bit 12 Inhibit error message output
Bit 13 Stop the printer function
Bit 14 Not used
Bit 15 Erase the event log buffer memory

These functions only become effective after code E8 Hex is entered in the TAST byte.

The above functions are carried out when the control bits are high. The opposite function is carried out when the bit is low. For instance, if bit 13 is low "0", and E8 Hex is entered in the TAST byte, the printer function will be switched OFF.

The normal printer control functions still operate if control word 9 is also being used, i.e. a report can still be initiated via the BLD 1, 2, 3 bytes and the printer control mask will still function, etc.

The only exception to this is erasing and resetting the message buffer using RESET.

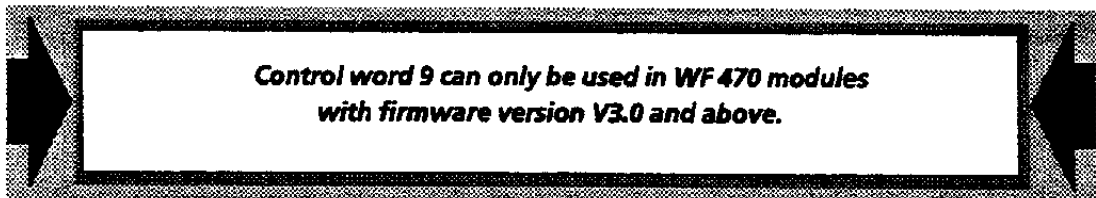

3.2.2.2 WF 470 Printout control mask.

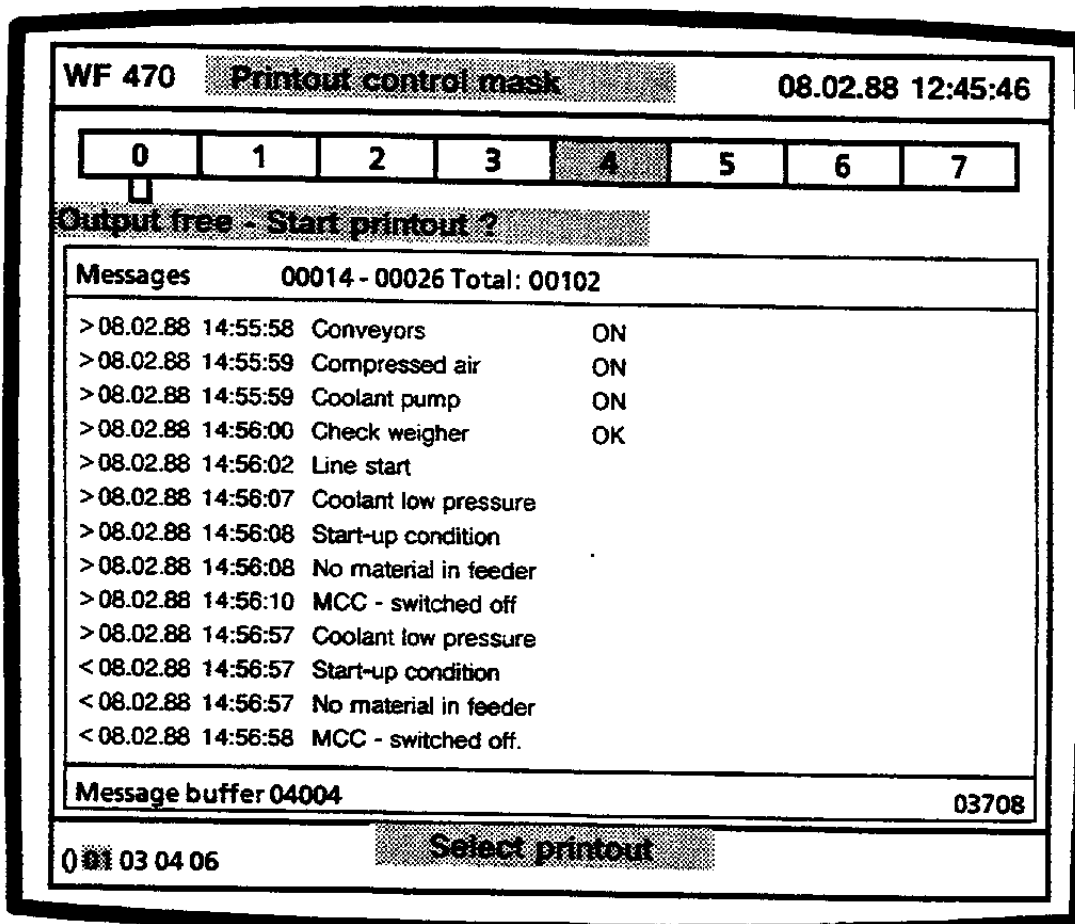

The printout control mask shown above is selected from the overview mask, or it can be called directly using its picture code #9A.

The display at the top of the page shows the condition of the 8 printer status bits. If the status bit number is entered on the operator keyboard, the text for this status bit will be displayed.

The enter key can be used to start the selected report printout.

The line shown at the bottom of the screen displays a list of the report printouts which are present on the WF 470. The cursor right/left key can be used to select a particular report number. The display field in the center of the picture will then display any messages which are awaiting printout with this report number. The number of messages awaiting printout is shown numerically and as a bar graph.

A report printout can be initiated from this page. To do this, select the report number using the left/right cursor keys, enter the number 0 to select the "printer output free" status text, and then press the ENTER key.

3.2.3 Sequence diagnostics

The sequence diagnostics option version 3.0 and above is supplied as two pictures, one showing an overview of the sequences, and the second providing detailed fault diagnostics. (An example picture is shown on page 1-5). This now means that the sequence step texts and error texts can be up to 50 characters in length.

The overview page has the code #05, and the diagnostics the code #06. The picture directory does **NOT** show these picture numbers, but shows picture #01 to be in line with previous versions.

Softkey legends for these pages can be entered in the text group #SK, text list 004 and 005.

3.2.3.1 Introduction

The sequence diagnostic package can be used in the following PLC'S:

- SIMATIC S5 - 130 W(B)
- SIMATIC S5 - 135U with 928 processor
- SIMATIC S5 - 150S
- SIMATIC S5 - 150U
- SIMATIC S5 - 115, CPU 942/943/944
- SIMATIC S5 - 155U

The sequence diagnostics cannot be used with:

- SIMATIC S5 - 135U - with S or R processor
- SIMATIC S5 - 115, CPU 941

A sequence control cascade is a control scheme with a chain of individual steps which are activated one after another. The change over from one step in the chain to another is controlled by the transition conditions. These could be for example the operation of a limit switch or the completion of a delay time.

The individual steps in a sequence are programmed in the SIMATIC S5 controller in sequence blocks (SB) or in program blocks (PB). Each step in the sequence requires an individual SB or PB. In any one program cycle, only one sequence/program block per sequence chain will be activated. The processing of this block will be terminated and processing of the next block in the chain will be started when the transition conditions have been met (see Fig 3.2).

Monitor timers with different time values can be programmed in FB 72 for each SB or PB. As the transition conditions are met for a particular step, the timer is re-triggered. If a transition is not made to the next step in the sequence before this timer has expired, the function block flags an error and this is annunciated on the WF470 screen. The sequence can be re-started when the fault is corrected.

Function block FB172 (sequence control) monitors the mode of operation of the sequence and hence controls the correct processing of the sequence. Information for each sequence chain (sequence block numbers, step numbers etc.) is held in a buffer data block called the "INTERFACE" DB. Up to 16 sequence chains can be linked to a sequence group, and a total of 4 sequence groups is permitted ($16 \times 4 = 64$ sequence chains).

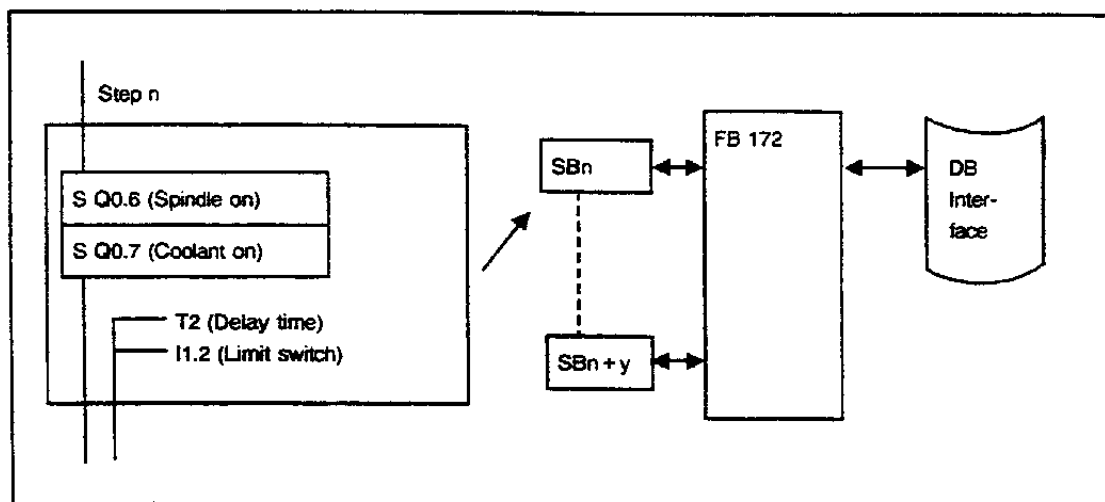

Fig 3.2 Sequence step example.

If a transition condition is not fulfilled, the "criterion analysis", "sequence chain selector" and "S5-WF470" function blocks operate to display the error in the sequence analysis picture.

- The criterion analyser (FB174 and FB175) determine which transition condition has not been fulfilled in the current sequence block. The unfulfilled condition is transferred, in bit form with its corresponding MC5 code, to the "Criterion analyser" data block.
- This information and the data from the "INTERFACE" data block are transferred to the data block "sequence data" by the "sequence chain selection" function block (FB 173).
- The "S5-WF470" function block transfers this data to the WF 470 where it is displayed together with the corresponding error text.

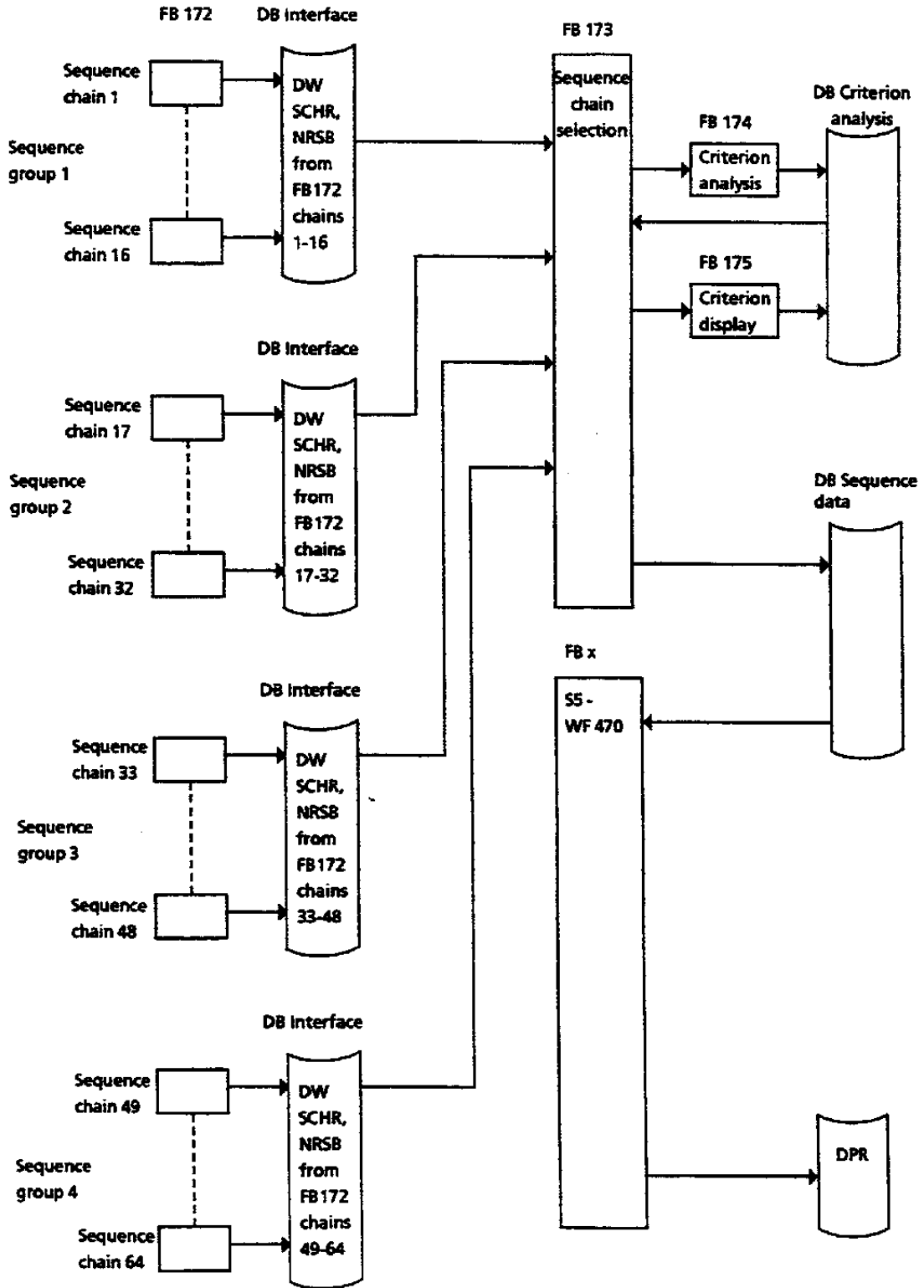

Fig 3.3 Sequence diagnostics

3.2.3.2 Sequence chain control "ABL:KORG"(FB172)

The ABL:KORG function block (FB 172) controls the processing of a sequence chain. Each chain can consist of a maximum of 255 steps (= 255 SB/PB's). Each sequence group requires an associated data block to be programmed. In order for the sequence to operate correctly, the program/sequence blocks must be programmed in a specific format (see 3.2.3.6).

Technical data

	S5-130 WB S5-150 K + cent unit	S5-150 S S5-150 U	S5-155 U	S5-115 U + CPU 942, 943 and 944	S5-135 U + CPU 928
Block number	FB 172	FB 172	FB 172	FB 172	FB 172
Lib number	E88530-B4132 B	E88530 B4132-D	E88530 B4136-D	E88530 B4132-A	E88530 B4132-C
Block name	ABL:KORG	ABL:KORG	ABL:KORG	ABL:KORG	ABL:KORG
Block size	223 words	225 words	225 words	244 words	225 words
Processing time	app. 1 ms	app. 1 ms	app. 1 ms	app. 1 ms	app. 1 ms
Call length	19	19	19	19	19
Nesting depth	1	1	1	1	1
System data	none	none	none	none	none
Flags used	FY 240-255	FY 240-255	FY 240-255	FY 240-255	FY 240-255
Block called	Associated SB or PB	Associated SB or PB	Associated SB or PB	Associated SB or PB	Associated SB or PB
Timers	none	none	none	none	none
Counters	none	none	none	none	none
Data block interface for parameter SCHR, NRSB, KDAT	DB must be called before the FB call	DB must be called before the FB call	DB must be called before the FB call	DB must be called before the FB call	DB must be called before the FB call

Explanation of input/ output parameters:

Parameter	Function	Comment	Type	Form	Valid value
BETR	Operation mode selection Automatic / Manual	"1" = Automatic "0" = Manual	I	BI	I 0.0 - 127.7 F 0.0 - 199.7
STRT	Start sequence in Auto and Man ; Increment forward in Man (signal change from "0" to "1")		I	BI	I 0.0 - 127.7 F 0.0 - 199.7
TIPP	Inching mode, step enabling with STRT (signal change from "0" to "1")		I	BI	I 0.0 - 127.7 F 0.0 - 199.7
EINR	Set up mode	Command output Only selected step is processed	I	BI	I 0.0 - 127.7 F 0.0 - 199.7
SCHD	Pre-selection of a step number	A step can be selected both in automatic and manual mode	I	BY	IB 0 - 127 FY 0 - 199
SCHS	selected step number		I	BI	I 0.0 - 127.7 F 0.0 - 199.7
RSET	Resetting the sequencer		I	BI	I 0.0 - 127.7 F 0.0 - 199.7
PBSB	Selection of sequence blocks or program blocks	Either SBs or PBs can be used for a sequencer	D	KC	KC = PB or SB
SBAE	Number of the first and last sequence/ programm block		D	KY	KY = 1, 2 - 254, 255
TWA	Specify the delay timer	TWA can be started and interrogated as required in the SB	T	-	T 1 - 127
TUE	Specify the monitoring timer	TUE is automatically started on transition from one step to the next. The time set applies to each step in the sequencer	T	-	T 1 - 127
KUE	Time value for TUE		D	KT	KT = 0.0 - 999.3
SCHR	Current step number output	SCHR is Binary coded	Q	BY DR	S DB Interface DR
NRSB	Current sequence block number output		Q	BY	S DB Interface DL
STO	Fault	Continuous signal	Q	BI	Q 0.0 - 127.7 F 0.0 - 199.7
ISTO	Fault	dynamic (Pulse for 1 cycle)	Q	BI	Q 0.0 - 127.7 F 0.0 - 199.7
KDAT	Sequence data		Q	W	S-DB Interface

"Interface DB "

The values placed in the SCHR, NRSB and KDAT parameters by FB172 are required by the WF 470 to produce the error display picture. Therefore these parameters must be entered accordingly to a pre-defined format which the WF 470 is expecting. Each block has 32 data words allocated to it.

This data block is parameterised via the QKBx parameter in FB KANW: WF (FB 173).

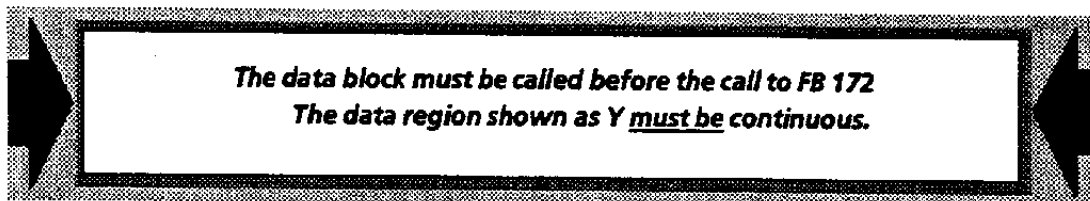

DW

y	NRSB /FB 172	SCHR / FB 172	chain 1 from sequence group
y+1	NRSB /FB 172	SCHR / FB 172	chain 2 from sequence group
y+2	NRSB /FB 172	SCHR / FB 172	chain 3 from sequence group
y+3	NRSB /FB 172	SCHR / FB 172	chain 4 from sequence group
y+4	NRSB /FB 172	SCHR / FB 172	chain 5 from sequence group
y+5	NRSB /FB 172	SCHR / FB 172	chain 6 from sequence group
y+6	NRSB /FB 172	SCHR / FB 172	chain 7 from sequence group
y+7	NRSB /FB 172	SCHR / FB 172	chain 8 from sequence group
y+8	NRSB /FB 172	SCHR / FB 172	chain 9 from sequence group
y+9	NRSB /FB 172	SCHR / FB 172	chain 10 from sequence group
y+10	NRSB /FB 172	SCHR / FB 172	chain 11 from sequence group
y+11	NRSB /FB 172	SCHR / FB 172	chain 12 from sequence group
y+12	NRSB /FB 172	SCHR / FB 172	chain 13 from sequence group
y+13	NRSB /FB 172	SCHR / FB 172	chain 14 from sequence group
y+14	NRSB /FB 172	SCHR / FB 172	chain 15 from sequence group
y+15	NRSB /FB 172	SCHR / FB 172	chain 16 from sequence group
y+16	Parameter	KDAT	chain 1 from sequence group
y+17	Parameter	KDAT	chain 2 from sequence group
y+18	Parameter	KDAT	chain 3 from sequence group
y+19	Parameter	KDAT	chain 4 from sequence group
y+20	Parameter	KDAT	chain 5 from sequence group
y+21	Parameter	KDAT	chain 6 from sequence group
y+22	Parameter	KDAT	chain 7 from sequence group
y+23	Parameter	KDAT	chain 8 from sequence group
y+24	Parameter	KDAT	chain 9 from sequence group
y+25	Parameter	KDAT	chain 10 from sequence group
y+26	Parameter	KDAT	chain 11 from sequence group
y+27	Parameter	KDAT	chain 12 from sequence group
y+28	Parameter	KDAT	chain 13 from sequence group
y+29	Parameter	KDAT	chain 14 from sequence group
y+30	Parameter	KDAT	chain 15 from sequence group
y+31	Parameter	KDAT	chain 16 from sequence group

3.2.3.3 Sequence chain selection for the WF470 "KANW: WF" (FB 173 of FB 183)

The function block "KANW: WF" administers a maximum of 4 sequence chain groups each containing up to 16 sequence chains, to produce a diagnostic display on the WF 470. The control of the sequences themselves is performed by FB172.

The link between the individual steps and the FB KANW*WF is formed by up to 4 "INTERFACE" data blocks parameterised at QKBx. The FB KAN: The first chain which has an error detected in it is caused by the WF 470 to be automatically displayed on the screen. If no error exists the first 16 sequence chains are displayed on the screen.

Technical data

	S5-130 WB S5-150 K + cent unit	S5-150 S S5-150 U *	S5-155 U	S5-115 U + CPU 942, 943 and 944	S5-135 U + CPU 928
Block number	FB 173	FB 173 / FB 183	FB 183	FB 173	FB 183 in prep.
Lib number	E88530-B4132 B	E88530 B4132-D	E88530 B4136-D	E88530 B4132-A	E88530 B4132-C
Block name	KANW:WF	KANW:WF	KANW:WF	KANW:WF	KANW:WF
Block size	265 words	258 words	288 words	267 words	250 words
Processing time	app. 2 - 10 ms	app. 1 - 5 ms	app. 1 - 5 ms	app. 2 - 10 ms. app. 1 - 5 ms	app. 2 - 10 ms
Time call	20	20	20	20	20
Nesting depth	1	1	1	1	1
System data	SD 253	none	none	none	none
Flags used	FY 240-255	FY 240-255	FY 240-255	FY 240-255	FY 240-255
Blocks called	none	none	none	none	none
Timers	none	none	none	none	none
Counters	none	none	none	none	none
Data blocks	see parameter	see parameter	see parameter	see parameter	see parameter

- * The SIMATIC S5 150U program can be expanded to handle a total of 64 criteria by using FB 183, 184 and 185. These function blocks are used in place of FB 173, 174 and 175. This is only possible using sequence diagnostics package version 3.0 and above.

The SIMATIC S5 155U is only supplied with FB 183, FB 184 and FB 185.

Parameter

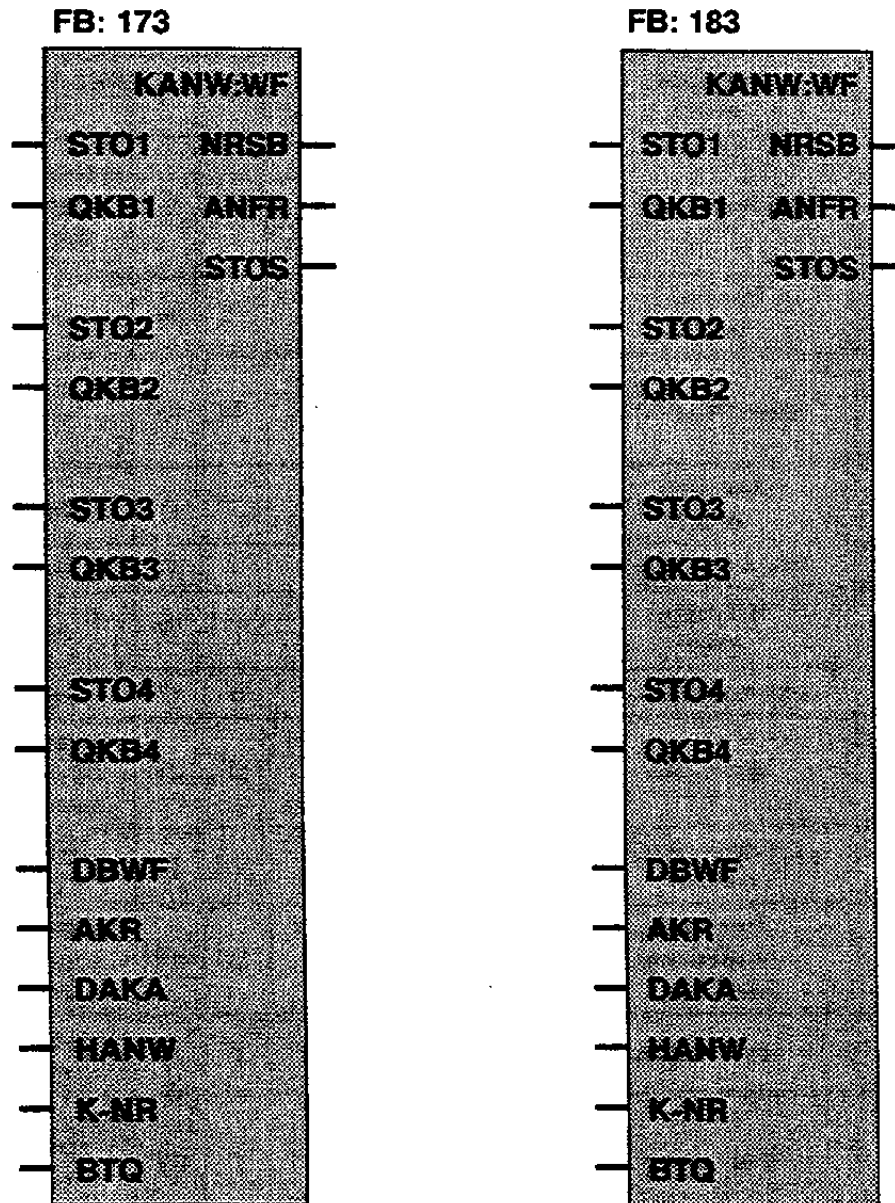

If the number of sequence chains is not longer than 16, then only one data block is required for the interface. This data block is specified via the parameter QKB1. In this case the parameters QKB2 and QKB3 can be parameterised with 0,0. This code informs the function block that sequence chains 16 to 64 are not present.

Explanation of input and output parameters:

Parameter	Function	Comment	Type	Form	Valid value
STO1	Error output group 1	Bit 0 = STO for chain 1 Bit 15 = STO for chain 16	I	W	FW 0-198 QW 0-127 DW 1-255
QKB1	Source seq. group 1	left byte DB No. interface right byte DW No. Seq. Block QKB1 must be present	D	KY	KY = DB no., DW no. DB no. 1-255 DW no. 1-239
STO2	Error output group 2	see STO1 (Chains 17-32)	I	W	see STO1
QKB2	Source seq. group 2	left byte DB No. interface right byte DW No. no DB present: KY = 0,0	D	KY	see QKB1
STO3	Error output group 3	see STO1 (Chains 33-48)	I	W	see STO1
QKB3	Source seq. group 3	see QKB2	D	KY	see QKB1
STO4	Error output group 4	see STO1 (Chains 49-64)	I	W	see STO1
QKB4	Source seq. group 4	see QKB2	D	KY	see QKB1
DBWF	DB Seq. data	left byte DB No. right byte DW No 56 words used	D	KY	KY = DB no., DW no. DB no. 1-255 DW no. 20-199
AKR	Current criteria in DB KA		I	BI	I/Q 0.0-127.7 F 0.0-199.7
DBKA	Data block criteria analysis and display	Parameterisation of DB Criteria display	D	KY	KY = DB no., DW no. DB no. 1-255 DW no. 8
HANW	Manual selection	HANW = 1 man sel ON HANW = 0 man sel OFF	I	BI	I/Q 0.0 - 127.7 F 0.0 - 199.7
K-NR	Chain number	HANW chain number in binary	I	BY	IB/QB 0 - 127 FY 0 - 199
BTQ	Error acknowledge		I	BI	I/Q 0.0 - 127.7 F 0.0 - 199.7
NRSB	No. SB/PB for analysis	SB No. and internal information for FB 174	Q	W	FW 0 - 198 DW 1 - 255
ANFR	Enable bit criteria analysis		Q	BI	Q 0.0 - 127.7 F 0.0 - 199.7
STOS	Error output collective signal	group error	Q	BI	F 0.0 - 199.7

If the sequence blocks are being used (and therefore the DB interface is not present) the parameter QKBX should be parameterised as KY = 0,0. The parameters STOx can then be parameterised with a flag word number > 200.

DBWF (Sequence Data):

The "sequence data" in this data block is used to store the data for the function block KAW:WF (FB173 of FB 183) for sequence data display. This data is 56 words long and must be entered in a pre-determined sequence (see below). The last two data words are reserved for internal use by FB 173/183. KANW:WF.

The DB number can be freely selected, but must correspond to the value parameterised in FB KAN:WF (FB 173/183) under parameter DBWF. The "SEQUENCE DATA" data block must be loaded in RAM and if desired, can be part of another data block.

FB 173 - FB 175

DW	SB/PB-number	Step number
n+0		
n+15	SB/PB-number	Step number
n+16	Interrupted chain (1 = interrupt)	
n+17		
n+18	Bit 0 = chain 1, Bit 15 = chain 16	
n+19	(4 words for 4 x 16 chains)	
n+20	Code SB/PB	Seq. chain -No.
n+21	unfulfilled	
n+22	step on conditions	
n+23	MC5 - code for the unfulfilled	
to	condition (maximum 32)	
n+54		
n+55	internal use	
n+56		

FB 183 - FB 185

DW	SB/PB-number	Step number
chain 1 n+0		
chain 16 n+15	SB/PB-number	Step number
n+16	Interrupted chain (1 = interrupt)	
n+17		
n+18	Bit 0 = chain 1, Bit 15 = chain 16	

**3.2.3.4 Criteria analysis "ABL:KRAY", "ABL:KRAN"
(FB 174, FB 175 or FB184/FB185)**

The ABL:KRAY function block finds the transition conditions in a program/sequence block. The block where the transition conditions are checked is determined by the value placed in KANW:WF (FB 173/183) parameter NRSB/ANFR.

The following instructions are recognised as transition conditions.

AI, AQ, AF, AT, AC, A(, O(,)
 UNI, UNQ, UNF, UNT, UNC
 OI, OQ, OF, OT, OC, O
 ONI, ONQ, ONF, ONT, ONC

The transition conditions are transferred into Data block KA, and each unfulfilled condition is indicated by setting a bit in the output of ABL:KRAN parameter KR1 and KR2.

Up to 32 or 64 transition conditions can be checked per sequence.

Technical data

	S5-130 WB S5-150 K + cent unit	S5-150 S S5-150 U*	S5-155 U	S5-115 U + CPU 942, 943 and 944	S5-135 U + CPU 928
Block number	FB 174	FB 174 / FB 184	FB 184	FB 174	FB 184 i.V.
Lib number	E88530 B4132 B	E88530 B4132-D	E88530 B4136-D	E88530 B4132-A	E88530 B4132-C
Block name	ABL:KRAY	ABL:KRAY	ABL:KRAY	ABL:KRAY	ABL:KRAY
Block size	354 words	350 / 392 words	410 words	357 words	350 words
Processing time	app. 6 - 15 ms	app. 1 - 10 ms	app. 1 - 5 ms	app. 6 - 15 ms app. 1 - 10 ms	app. 2 - 12 ms
Call length	6	6	6	6	6
Nesting depth	1	1	1	1	1
System data	none	none	none	none	none
Flags used	FY 238-255	FY 238-255	FY 238-255	FY 238-255	FY 238-255
Blocks called	none	none	none	none	none
Timers	none	none	none	none	none
Counters	none	none	none	none	none
Data blocks	DB KA, DW 0 - 72	DB KA, DW 0 - 72 / 106	DB KA, DW 0 - 106	DB KA, DW 0 - 72	DB KA, DW 0 - 106

* The SIMATIC S5 150 U can be expanded to 64 criteria using FB183 to FB 185. This requires WF 470 version 3.0 firmware.

Parameterisation



Explanation of input and output parameters:

Parameter	Function	Comment	Type	Form	Valid value
NRSB	Seq. group number (or PB number)	Block to be investigated	I	W	FW 0 - 254
NRAB	Criteria display block	N°. of the FB ABL:KRAY is set as parameter	D	KY	KF + 175 or KF + 185
ZAKU	Number of criteria exceeded	more than 32 criteria in step	Q	BI	F 0.0 - 199.7 Q 0.0 - 127.7

Technical data

	S5-130 WB S5-150 K + cent unit	S5-150 S S5-150 U*	S5-155 U	S5-115 U + CPU 942, 943 and 944	S5-135 U + CPU 928
Block number	FB 175	FB 175 / FB 185	FB 185	FB 175	FB 185 i.P.
Lib number	E88530-B4132 B	E88530 B4132-D	E88530 B4136-D	E88530 B4132-A	E88530 B4132-C
Block name	ABL:KРАН	ABL:KРАН	ABL:KРАН	ABL:KРАН	ABL:KРАН
Block size	207 words	207 / 324 words	324 words	207 words	324 words
Call length	7	7	7	7	7
Nesting depth	1	1	1	1	1
Processing time	app. 3 ms	app. 1.5 ms	app. 1 ms	app. 3 ms app. 1.5 ms	app. 2.5 ms
Flags used	FY 248-255	FY 248-255	FY 248-255	FY 248-255	FY 248-255
Blocks called	none	none	none	none	none
Timers	none	none	none	none	none
Counters	none	none	none	none	none
Data blocks	DB KA	DB KA	DB KA	DB KA	DB KA

Parameterisation

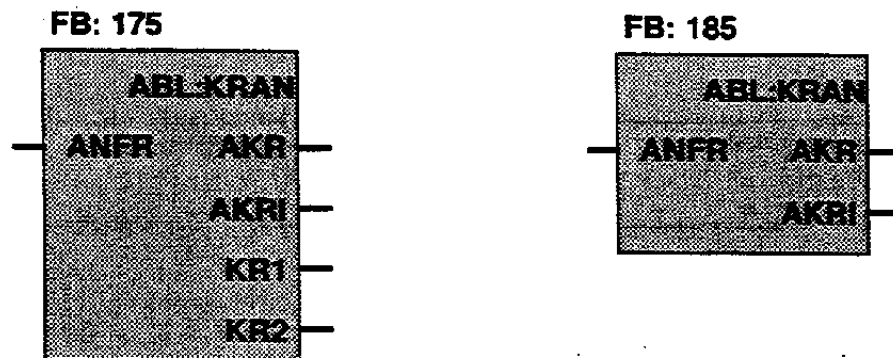

Explanation of input and output parameters:

Parameter	Function	Comment	Type	Form	Valid value
ANFR	Criteria outputs for display and eval. enabled	Signal comes from FB KANW:WF (FB 172)	I	BI	F 0.0 - 199.7 Q 0.0 - 127.7
AKR	The actual criteria are in DB and enabled	Continuous enable signal	Q	BI	F 0.0 - 255.7 Q 0.0 - 127.7
AKRI	As AKR except pulse	Impuse enable signal	Q	BI	as AKR
KR1*	Criteria output 1	Unfulfilled transition conditions 1 - 16	Q	W	DW 8
KR2*	Criteria output 2	Unfulfilled transition conditions 17 - 32	Q	W	DW 9

* = The parameters KR1 and KR2 are missing for the FB 185.

The parameter AKRI is not used by the WF 470 and so can be parameterised with an unused flag, i.e. F 255.7.

The unfulfilled transition conditions are transferred into the function block ABL:KRA itself. For this reason this function block must be loaded in RAM.

DB KA (Criteria analysis):

Function blocks "criteria analysis" and "criteria display" (FB174/175) or (FB184/185) place the MC5 code for the unfulfilled conditions in data block KA. The information is then transferred to the sequence data block by the function block KANW:WF (FB173/FB183).

FB 175

DW		
	0	Register for FB 174/175
	1	For internal data from FB 174/175
	7	
	8	Unfulfilled transition conditions
	10	MC5-code for the found transition code
	41	
	72	Internal data for FB 174/175

FB 185

DW		
	0	Register for FB 184/185
	1	For internal data from FB 1184/185
	7	
	8	Unfulfilled transition conditions
	11	MC5-code for the found transition code
	65	
	106	Internal data for FB 184/185

3.2.3.5 Programmed Example

In the following example the sequence blocks themselves are not programmed. This example shows how the diagnostic function blocks are to be programmed and when the corresponding data blocks should be called.

The calls to FB 172 in the following example are for the fourth and seventh sequence chains. The parameters STO1 and QKB1 in FB 173 and the parameters SCHR, NRSB, STO and KOAT in FB 172 are interdependent.

In the example, STO1 in FB 173 is parameterised as FW 110. STO in FB 172 uses the flags F 110.3 and 110.6, ie. the fourth and seventh bits of FW 110. FB 173 - QKB1 is parameterised as 110,10 (DB 110, DW 10). This is the start of the data block for NRSB, SCHR and KDAT. By setting DL/DR 13 and DL/DR 16 in the NRSB/SCHR parameter of FB 172, the fourth and seventh data words in this block are addressed.

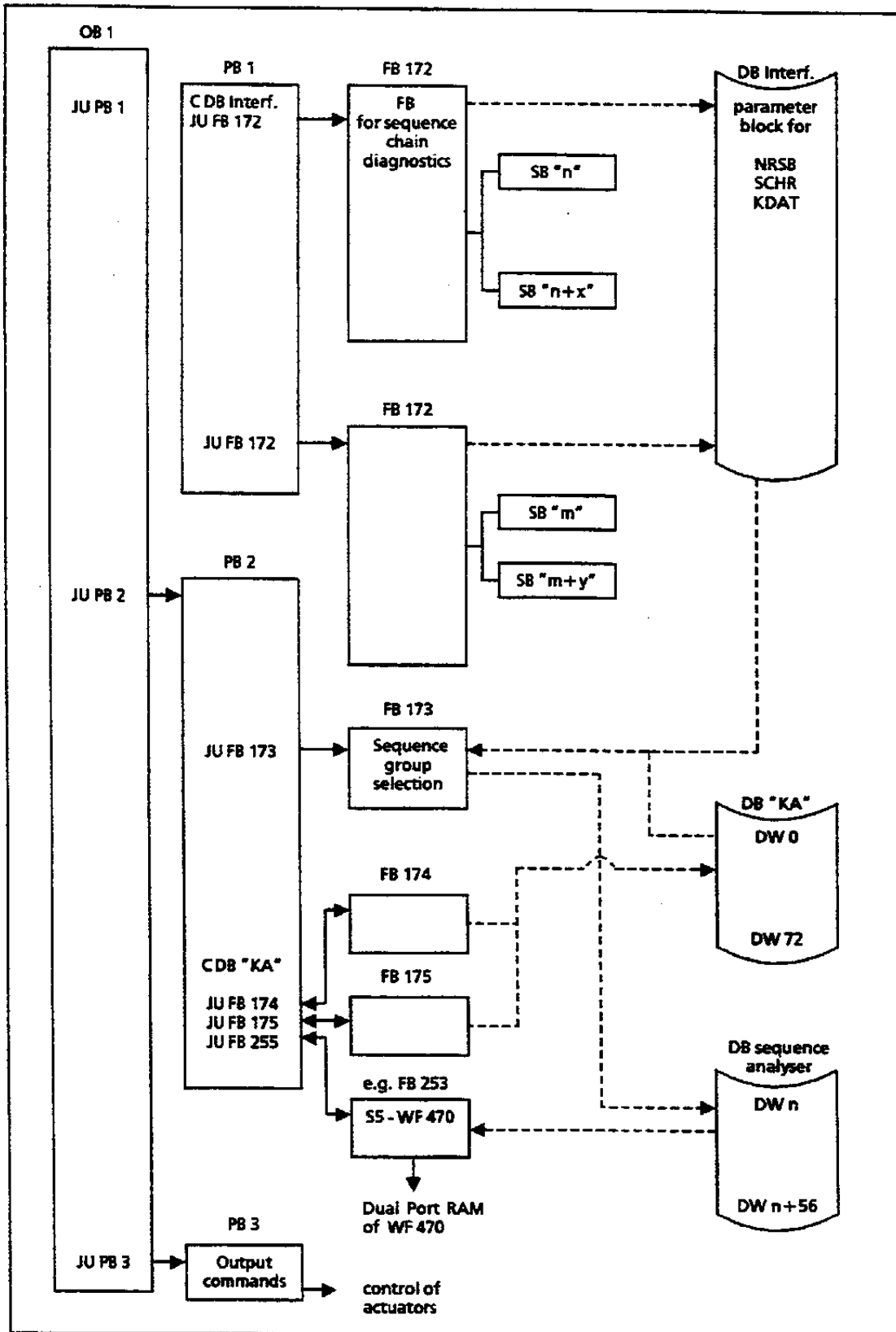
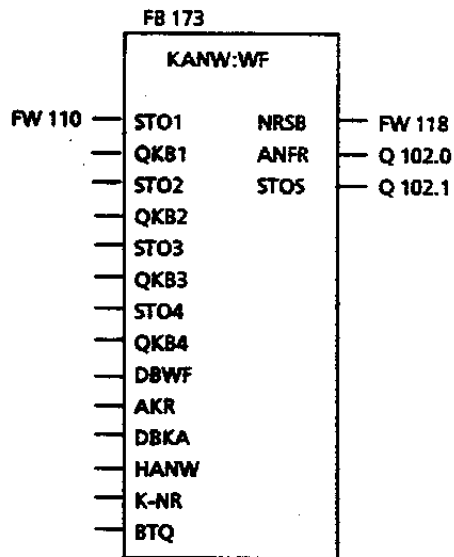
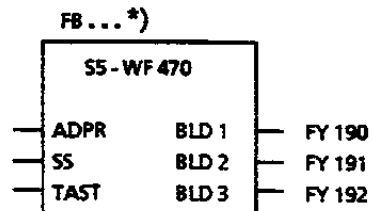
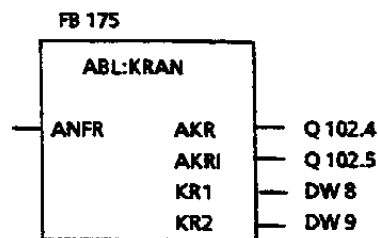
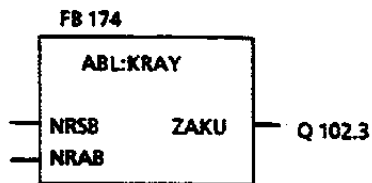

Fig. 3.4 Program structure

PB 2
Segment 1
:
:
:



Call DB criteria analysis



...*) FB Number depends on the SIMATIC PLC type being used.

Fig. 3.6 Call and parameterisation of FB 173, FB 174, FB 175 and FB 255.

PB 3

Segment 1

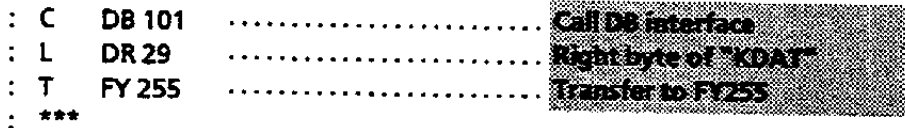

Segment 2

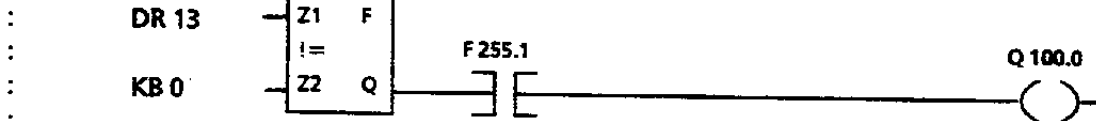

Segment 3

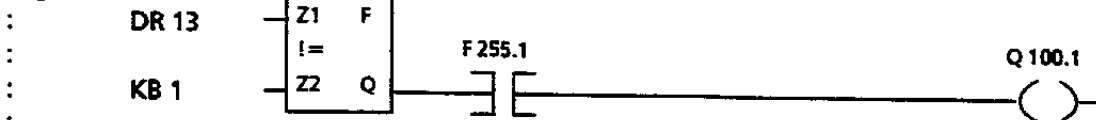

Segment 4

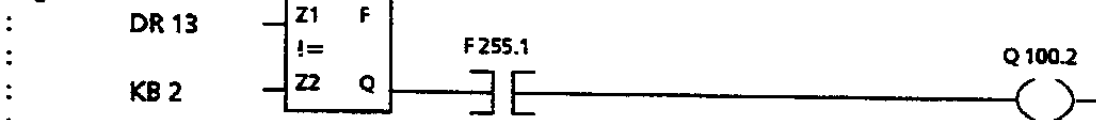

Segment 5

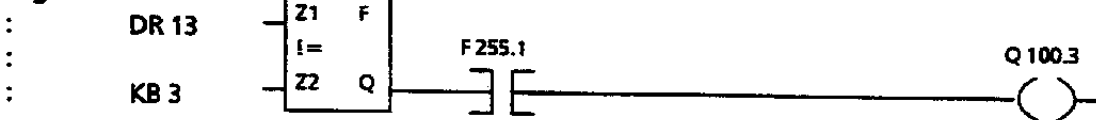

Segment 6



Segment 7



Segment 8

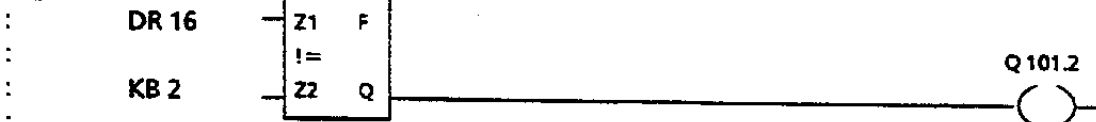

Segment 9



Segment 10

: BE

Fig 3.7 Output commands.

3.2.3.6 Programming Sequence Blocks

Sequence blocks can be programmed with the logic for both the automatic and manual (Hand) modes of operation. In both cases any faults will be annunciated on the WF 470 screen. The manual modes use flags F240.4, F240.5. The automatic and increment modes use flags F240.6, F240.7.

These flags are used by the sequence control function block (FB172). This function block processes the code in the sequence blocks differently according to which mode has been selected. The FB controls the transition from one sequence block to the next and operates the diagnostics if an error occurs.

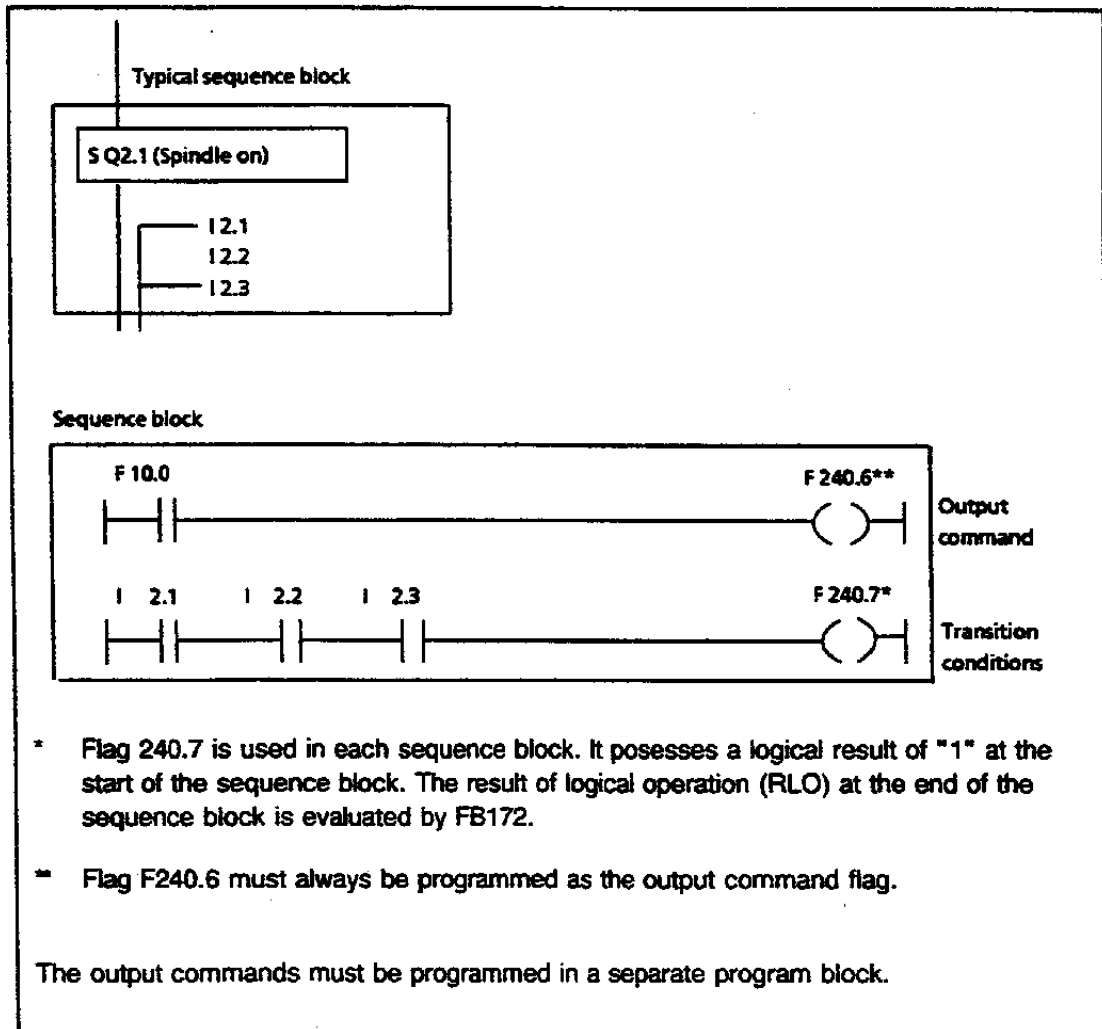

Fig. 3.8 Example 1 : Sequence utilising AUTOMATIC mode only

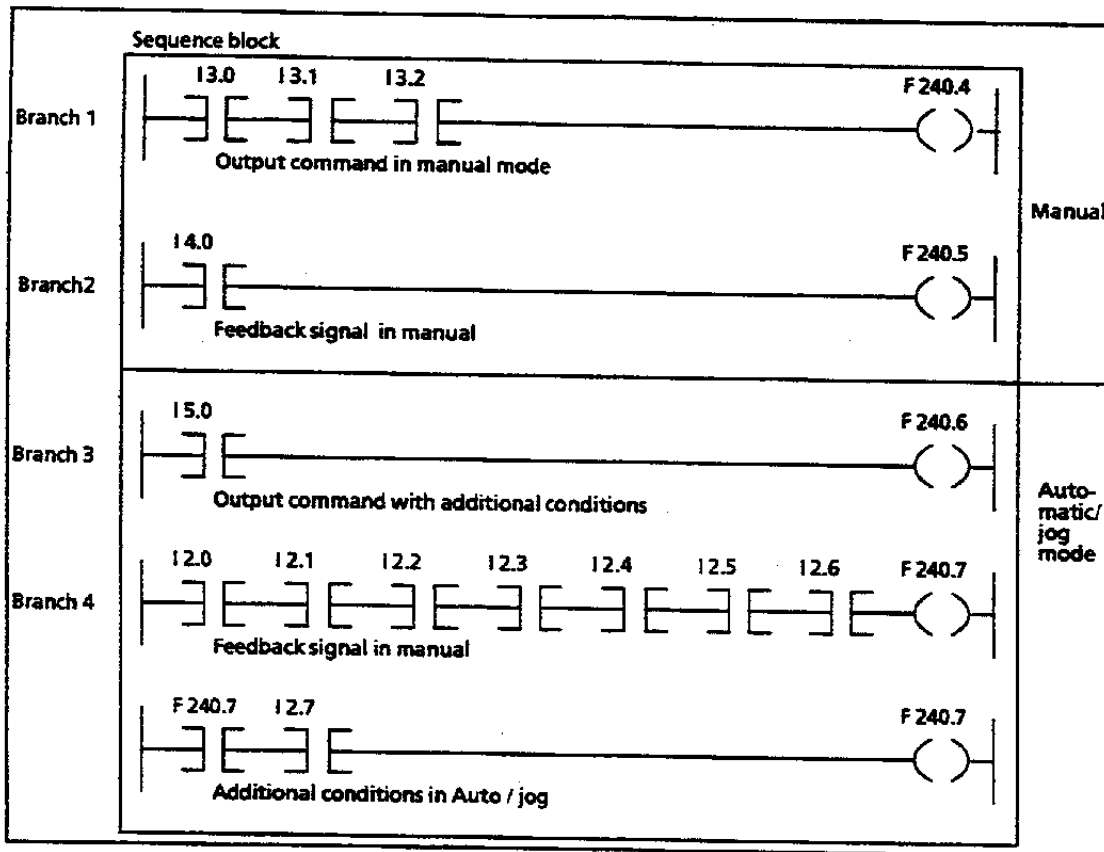

Fig. 3.9 Example 2: Sequence chain for automatic/increment and manual operation

- Up to 32 or 64 conditions can be programmed in each branch. Since ladder diagram representation only allows 7 contacts in a rung, the additional conditions must be entered in a separate rung, preceeded by a continuation flag (see the example in branch 4). For OR-combinations, the nestings are used like conditions. The diagnosis blocks can only process one nesting level.
- If there are no conditions in a particular branch e.g. F240.6, F240.7 will be evaluated. This flag always has the condition "1" at the start of a sequence block except during the first scan of the sequence block.
- If a delay time is required, this timer should be started at the start of the sequence block with F240.7 (switch on supply). The evaluation of the timer can take place in the following branches (e.g. branch F240.7).
- Each step is monitored by a monitor timer. The length of this monitor time and the timer is programmed as a parameter in the function block. Every time a transition occurs and a new block is processed, this timer is automatically re-triggered. The time value is entered in FB 172 parameter KUE, and is the same for all steps.

It is however possible to change the monitor time during the sequence. To do this, the new time value should be loaded into the timer parameterised as TUE at the start of the sequence block. If the timer is called in the step with an RLO = 0, then the monitor timer will be switched off for this step.

- Branches for flags F 240.6 and F 240.7 must be present. Branches 1 and 2 need only be programmed if manual mode is to be used.

- The output commands must be programmed in a separate block. The current step number should be compared with the required step number, and if equal, the appropriate outputs should be switched (see example in fig. 3.7).

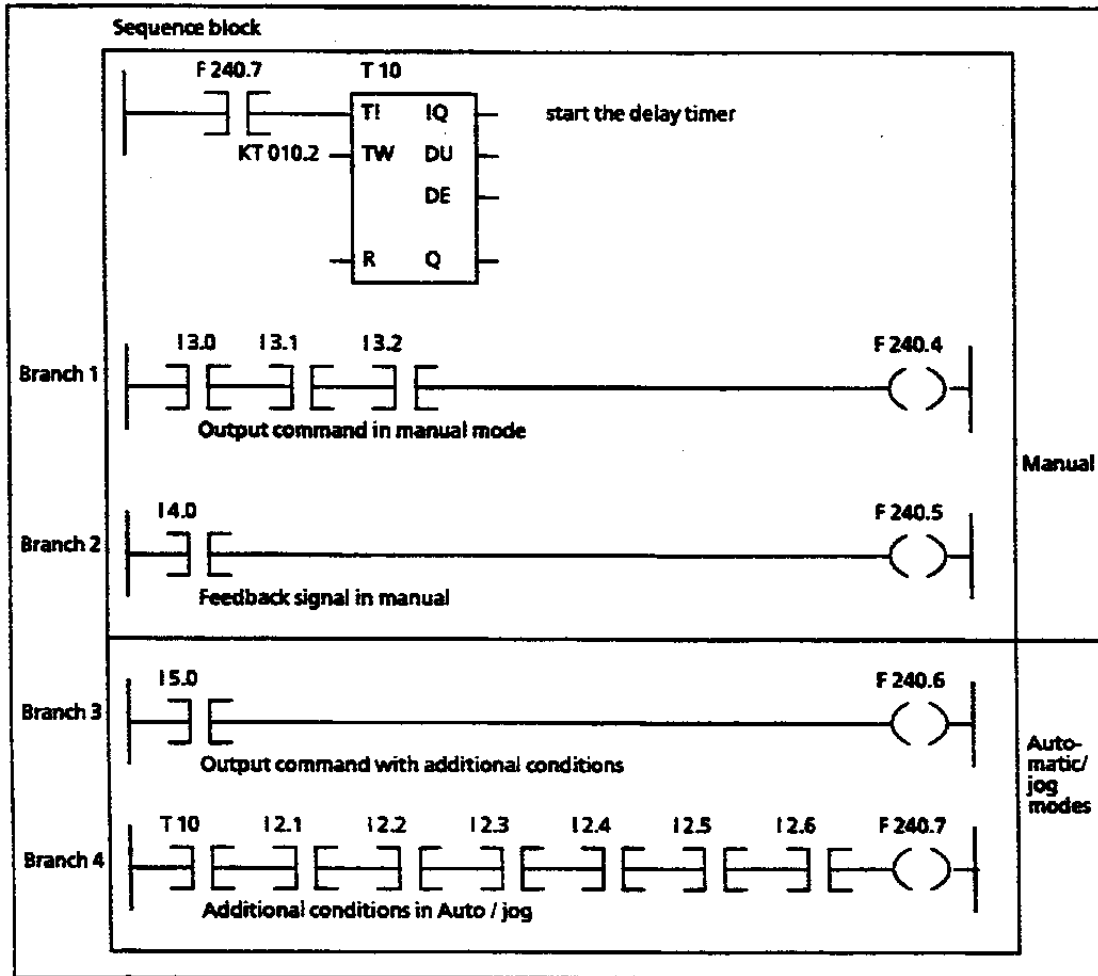

Fig.3.10 Example 3 Step with delay timer

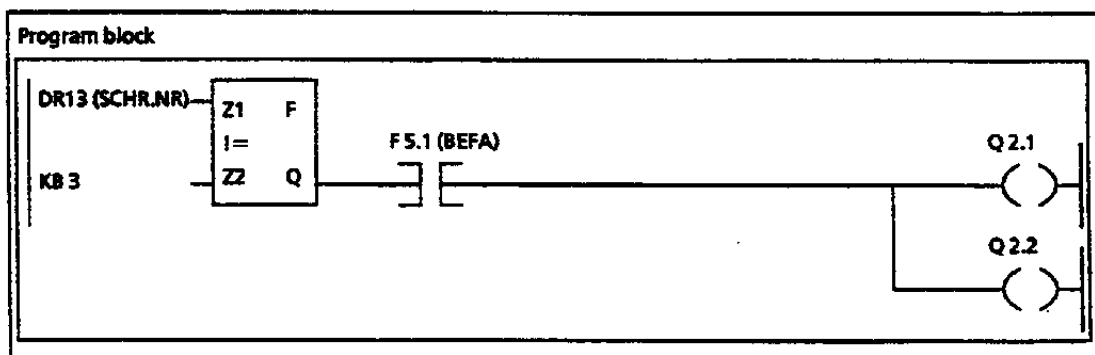

Fig 3.11 Example 4 Output command

3.2.4 WF 470 Sequence diagnostics using GRAPH5

3.2.4.1 GRAPH5 sequence diagnostics option

The GRAPH5 diagnostics option, order No. 6FM1470 7EA30, can be loaded into the WF 470 using a PG. The picture construction software must be V2.3 or above for the PG 675 and V3.0 or above for the PG 685.

The option should be loaded onto the hard disk with the command PIP B: = A:CGR5.SYS, or if PG 675 is used, it should be loaded onto the application data disk.

The option consists of two pictures:

The main picture shows an overview of the sequences, and the status of the steps.

- a) sequence running : green text, no attribute
- b) sequence switched off : yellow text, attribute *
- c) sequence with fault : white text, attribute ***
- d) sequence selected for diagnostics : line highlighted in blue.

The second picture is used for the sequence diagnostics. The unfulfilled step-on-conditions, the number of the sequence being diagnosed, and if used, the parallel branch are displayed.

The fault texts are entered in a similar manner to the standard sequence diagnostics, by entering the function mask and the number of the sequence to be diagnosed.

These two pictures can be selected using their picture codes #03 and #04. (The picture directory will only contain code #03.)

3.2.4.2 SIMATIC S5 software

The SIMATIC software disk 6FM1 470 6AD10 Version V1.3 from 11/87 contains several additional blocks i.e. SB0, SB2, SB3, FB 76, FB 77, FB 79.

The GRAPH5 software for the programming unit, and the sequence function block FB 70 and FB 71 must be ordered separately.

The new blocks are for the diagnostics of the GRAPH5 program. The GRAPH5 program software contains sequence blocks SB0, SB2 and SB3. These should be replaced by those supplied with the WF 470 function block as they contain additional functions required for the diagnostics program. In addition, the user should generate three data blocks, the data block numbers can be freely selected:

Data block DBKA:

This data block must be generated to at least DW 120 (minimum length:125), and should be called before FB 76 and FB 77.

Data block DBWF:

This block must be the same block which has been specified in the WF 470 system data mask. All of the information required by the WF 470 for the GRAPH5 diagnostics is placed in this data block by FB 79.

The block must be generated to a least DW 146 inclusive, if DW 20 is parameterised as the first word to be used.

Technical data

	S5-130 WB S5-150 K + cent unit	S5-150 U	S5-155 U	S5-115 U + CPU 943 and 944	S5-135 U + CPU 928
Block number	not available	FB 76	FB 76	FB 76	FB 76
Block name		ABL:KRAY	ABL:KRAY	ABL:KRAY	ABL:KRAY
Block size		375 words	375 words	375 words	375 words
Call length		5	5	5	5
Processing time		1 - 5 ms	1 - 5 ms	1 - 5 ms	1 - 5 ms
Blocks called		none	none	none	none
Flags used		FY 200-254	FY 200-254	FY 200-254	FY 200-254
Timers		none	none	none	none
counters		none	none	none	none
Data blocks		none	none	none	none

Parameterisation

FB: 76

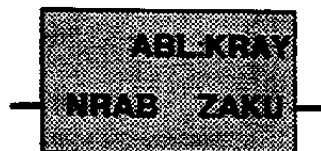

Parameter	Function	Comment	Type	Form	Valid value
NRAB	Criteria display block	No. of FB77	I	D	KF + 77
ZAKU	Number of criteria exceeded	Set to 1 if more than 64 criteria	Q	BI	F.0.0-F199.7 Q.0.0-Q127.7

Technical data

	S5-130 WB S5-150 K + cent unit	S5-150 U	S5-155 U	S5-115 U + CPU 943 and 944	S5-135 U + CPU 928
Block number	not available	FB 77	FB 77	FB 77	FB 77
Block name		ABL:KLAN	ABL:KLAN	ABL:KLAN	ABL:KLAN
Block size		318 words	318 words	318 words	318 words
Call length		3	3	3	3
Processing time		app. 2 ms	app. 2 ms	app. 2 ms	app. 2 ms
Blocks called		none	none	none	none
Flags used		FY 200-254	FY 200-254	FY 200-254	FY 200-254
Timers		none	none	none	none
Counters		none	none	none	none
Data blocks		none	none	none	none

Parameterisation

FB: 77

ABL:KLAN

**FB 77 must be
loaded in RAM**

Technical data

	S5-130 WB S5-150 K + cent unit	S5-150 U	S5-155 U	S5-115 U + CPU 943 and 944	S5-135 U + CPU 928
Block number	not available	FB 79	FB 79	FB 79	FB 79
Block name		UEBER	UEBER	UEBER	UEBER
Block size		1298 words	1298 words	1298 words	1298 words
Call length		8	8	8	8
Processing time		1 - 5 ms	1 - 5 ms	1 - 5 ms	1 - 5 ms
Blocks called		none	none	none	none
Flags used		FY 200-254	FY 200-254	FY 200-254	FY 200-254
Timers		none	none	none	none
Counters		none	none	none	none
Data blocks		none	none	none	none

FB: 79

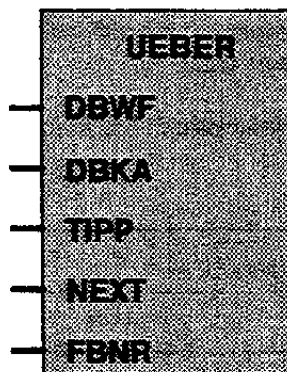

Parameter	Function	Comment	Type	Form	Valid value
DBWF	WF 470 interface	DB no., DW no. for Data block DBWF	D	KY	001, 020 to 255, 100
DBKA	DB for criteria analysis		B		DB001 to DB255
TIPP	Next alternative branch	Next alternative branch for diagnostics, on positive edge	I	BI	I 0.0 - 127.7 F 0.0 - 199.7 Q 0.0-127.7
NEXT	Next parallel branch	Next parallel branch for diagnostics, on positive edge	I	BI	I 0.0 - 127.7 F 0.0 - 199.7 Q 0.0-127.7
FBNR		A1 if using FB70-FB71 A2 if using FB72-FB73	D	KC	A1, A2

Example of block calls:

Segment 1

```

0000 : C DB100
0001 : JU FB76
0002 NAME : ABL: KRAY
0003 NRAB : KF + 77
0004 ZAKU : F 100.0
0005 :
0006 : JU FB77
0007 NAME : ABL: KRAN
0008 :
0009 : JU FB79
000A NAME : UEBER
000B DBWF : KY101,20
000C DBKA : DB100
000D TIPP : F 100.1
000E NEXT : F 100.2
000F FBNR : KS A1
0010 :
0011 : BE

```

Data block DBWF

The data block number for DBWF is specified in the WF 470 system data list. The first 20 data words of this block are reserved for other data.

The GRAPHS data can start from DW 20 onwards. The first word chosen is indicated by the letter n:

DW No			
n + 0	16	Sequence running	1
n + 1	32		17
n + 2	48		33
n + 3	64		49
n + 4	16	Sequence stopped	1
n + 5	32		17
n + 6	48		33
n + 7	64		49
n + 8	SB-No.	Chain- No.	
n + 9	FF = Auto; 00 = Man.		
n + 10	Branch No.	Step No.	
n + 11	Total Number of steps	AKT/TRAN	
n + 12	Branch No. 1	Branch No. 2	
n + 13	Branch No. 3	Branch No. 4	
n + 14	Branch No. 5	Branch No. 6	
n + 15	Branch No. 7	Branch No. 8	
n + 16	Branch No. 1	Branch No. 2	
n + 17	Branch No. 3	Branch No. 4	
n + 18	Branch No. 5	Branch No. 6	
n + 19	Branch No. 7	Branch No. 8	
n + 20	16		1
n + 21	32		17
n + 22	48		33
n + 23	64		49

1 = sequence running
0 = sequence stopped

1 = sequence running
0 = sequence stopped

Sequence block number running sequence no.
FF = valid/FF = Auto.
Auto. 0 = manual

Display branch

0 = error in an action
1- 8 = Transition

Current step number for branch 1-8 of displayed chain for simultaneous branches

Number of the step in error for branches 1-8 in the displayed chain

Bit-coded status for the 64 possible step on conditions
1 = condition missing

DW-No		
n + 24	MC5-Code	
bis		
n + 87	MC5-Code	
n + 88	Reserved	
n + 89	Branch No.	OLD step number
n + 90	Sequence block No. 1	Sequence block No. 33
n + 91	Sequence block No. 2	Sequence block No. 34
n + 92	Sequence block No. 3	Sequence block No. 35
n + 93	Sequence block No. 4	Sequence block No. 36
n + 94	Sequence block No. 5	Sequence block No. 37
bis		
n + 119	Sequence block No. 30	Sequence block No. 62
n + 120	Sequence block No. 31	Sequence block No. 63
n + 121	Sequence block No. 32	Sequence block No. 64
n + 122	Reserved	
n + 123	Pointer to SB list	
n + 124	DW n + 0	DW n + 4
n + 125	bit pointer	
n + 126	page flag	

Data words n + 0 to n + 7, n + 10 to n + 87 are written to by FB 79.

Data words n + 8, n + 90 to n + 121 are written to by the WF 470.

DW n + 8 tells the WF 470 which sequence blocks are to be diagnosed. In the automatic mode, only sequence blocks which are stopped due to an error can be selected for diagnostics.

A sequence is determined to be stopped in error when no step on has taken place after the monitor time has expired. If no monitor time has been programmed, no diagnostics will be performed on that step.

Transition T1 cannot be displayed in automatic mode because it is not possible to program a monitor time in step 0.

Automatic mode is indicated by the code KH 00FF in DW n + 9. This data word should be set by the application program. If DW n + 9 contains KH 0000, any sequence can be selected for diagnostics display. Any missing step-on conditions or operations in the sequence part of the program can be monitored during normal operation. This enables the user to monitor the progress of the sequence and check its operation.

The WF 470 writes the first 32 sequence block numbers in the data words n + 90 to n + 121 (to the left, and all other numbers to the right). Data words n + 122 to 126 are used as scratchpad for FB 79.

To summarise - what does the user need to program?

- 1) Write the control program in GRAPH5.
- 2) Call and parameterise function blocks FB 76, FB 77 and FB 79, generate data blocks DBKA and DBWF, replace the existing SB0, SB2, SB3 with the WF 470 versions.
- 3) Enter KH 0000 or KH 00FF in DW 9 for manual or automatic mode.
- 4) Install the CGR5 option in the WF 470.
- 5) Enter the DBWF data block and data word number in the WF 470 system data list.
- 6) Enter the function text for the sequence.
- 7) Program the picture selection for the GRAPH5 pictures #03 and #04 either in the applications program or via FB 220.
- 8) The pictures can then be operated from the keys on the operator keyboard.

Key codes

next line up	8F	Hex cursor up
next line down	90	Hex cursor down
scroll up	8D	Hex scroll up
scroll down	8C	Hex scroll down
next sequence	91	Hex cursor right
previous sequence	92	Hex cursor left

Picture 2 can be selected by pressing the letter B, and picture 1 can be re-selected by pressing A.

Limitations

- 1) Diagnostics can be performed on a maximum of 64 sequences.
- 2) For each action/transition, a maximum of 8 bracketed instructions can be programmed in each individual bracket level.
- 3) For each action/transition, one result with 64 criteria (i.e. control conditions for the action program, transition conditions for the transition program) can be diagnosed. The result must be generated at the end of the conditions. This means for example, that an "intermediate result" in the chain of logic cannot be used to turn outputs on and off. It is permitted to use an auxiliary flag to transmit the result of logic operation from one branch to the next, in order to break a long chain into shorter segments.
- 4) The code in the action and transition programs can contain any instruction from the basic instruction set, with the following limitations:

The following are INVALID: S5115U STS, TAK JR, STP
S5150U/S STS, TAK, JR, STP, STW, UBE, LKG, JOS
SIM, LIM, ON Dxy.3 (xy = 10 to 17)

4 Service

4.1 Introduction

Details of the hardware settings for early versions of the WF 470 are not contained in this manual. The settings shown here are for hardware versions with the order numbers 6FM1 470 3XX20.

Details of early versions with the order number 3XX10 can be found in the old WF 470 manual order No. E80850-J62-X-A2-7600.

4.2 Commissioning

4.2.1 Visual inspection

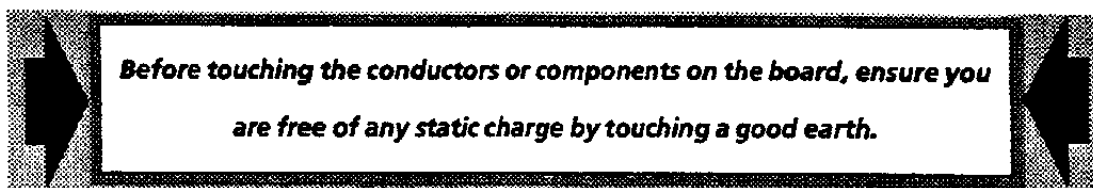

Articles manufactured from plastic generate very high static fields. This applies especially to nylon carpets and plastic soled shoes. The integrated circuits and other devices used in these modules are sensitive to static discharge. It is important that anti-static precautions are observed when dealing with electronic devices.

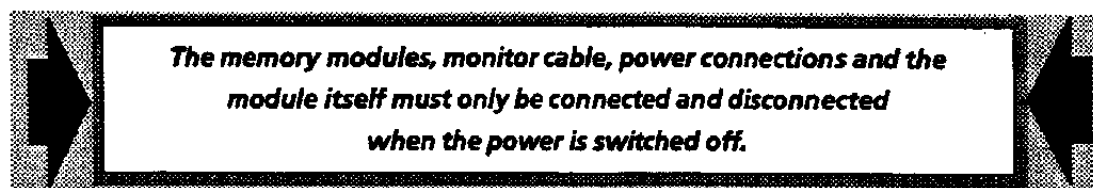

4.2.2 Starting Commissioning

- The following will be required:
 - WF470 module
 - Ram memory module 377 (not required for the WF 470 C)
 - Monitor
 - Operator keyboard
 - PG 675 / PG 685 / PG 750
 - The corresponding connection cables for the above units
 - Software disks for the PG (CCP/M or PCP/M, picture construction software)
 - The SIMATIC S5 function blocks
 - Any optional software required

- The PLC must be wired up and tested
- The WF 470 must be connected to the peripheral units
- The earthing of the PLC must be correct

4.2.3 Visual inspection:

4.2.3.1 Checking the hardware

- Check the unit for transport damage
- Check that the printed circuit boards are the current hardware and firmware level
- Check that all the integrated circuits are firmly in their holders
- Check that all cable connections are correctly made

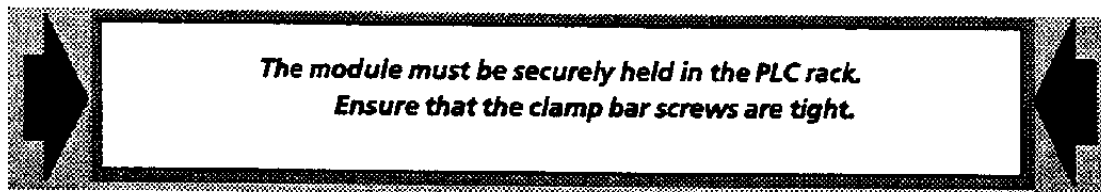

4.2.3.2 Earthing

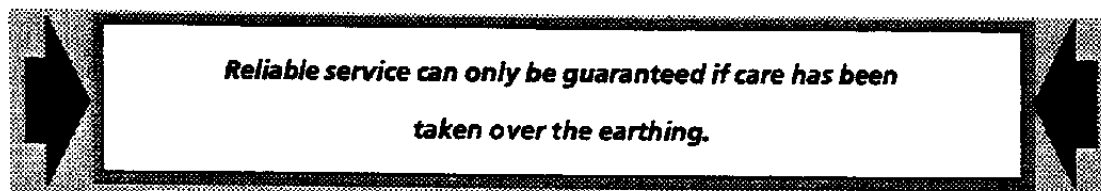

The earth cable must be correctly installed and be of adequate cross sectional area.

4.2.3.3 Cable separation/screening

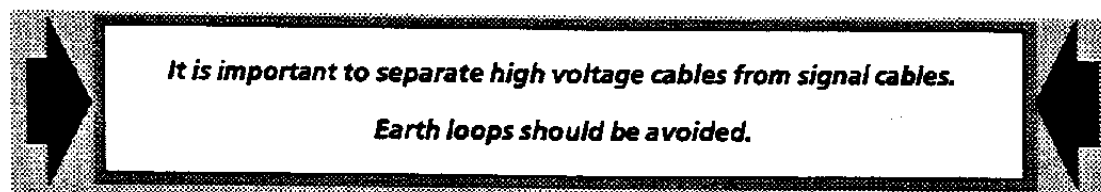

Unscreened or inadequately earthed cables result in interference signals being generated in the cables. It is important to ensure that video cables are run separately from other cables. The monitor must be supplied from the same phase as the central/extension unit housing the WF 470 module.

The outer screen of all cables connected to the WF 470 should be connected to the Mext 0 Volt connection on the control cubicle.

4.2.4 Hardware Checks

4.2.4.1 Checking the hardware revision level

This is shown on the sticker beside the backplane connector. The actual version level is indicated by the last cross.

4.2.4.2 Checking the software version level

WF 470

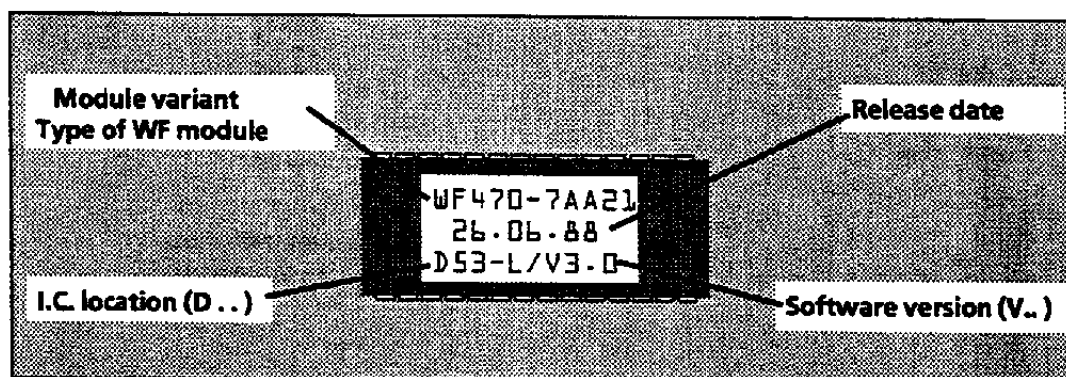
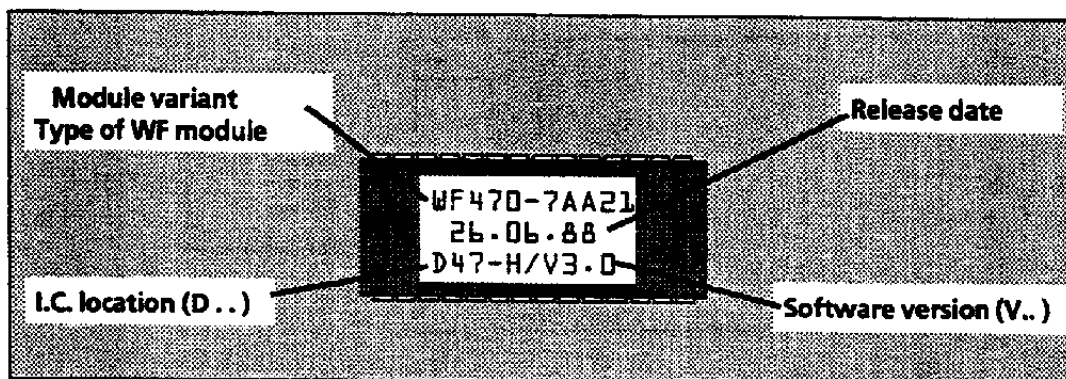

- The firmware version is shown on the labels attached to the EPROMS.

The EPROM module locations D47 and D53 are shown in fig. 4.1 and 4.2.

The software revision level is also shown on the WF 470 system mask, and the WF 470 B/C shows the software level on a sticker on the side of the unit.

4.2.5 Bridge and Switch Positions WF 470 (6FM1 470-3xx20)

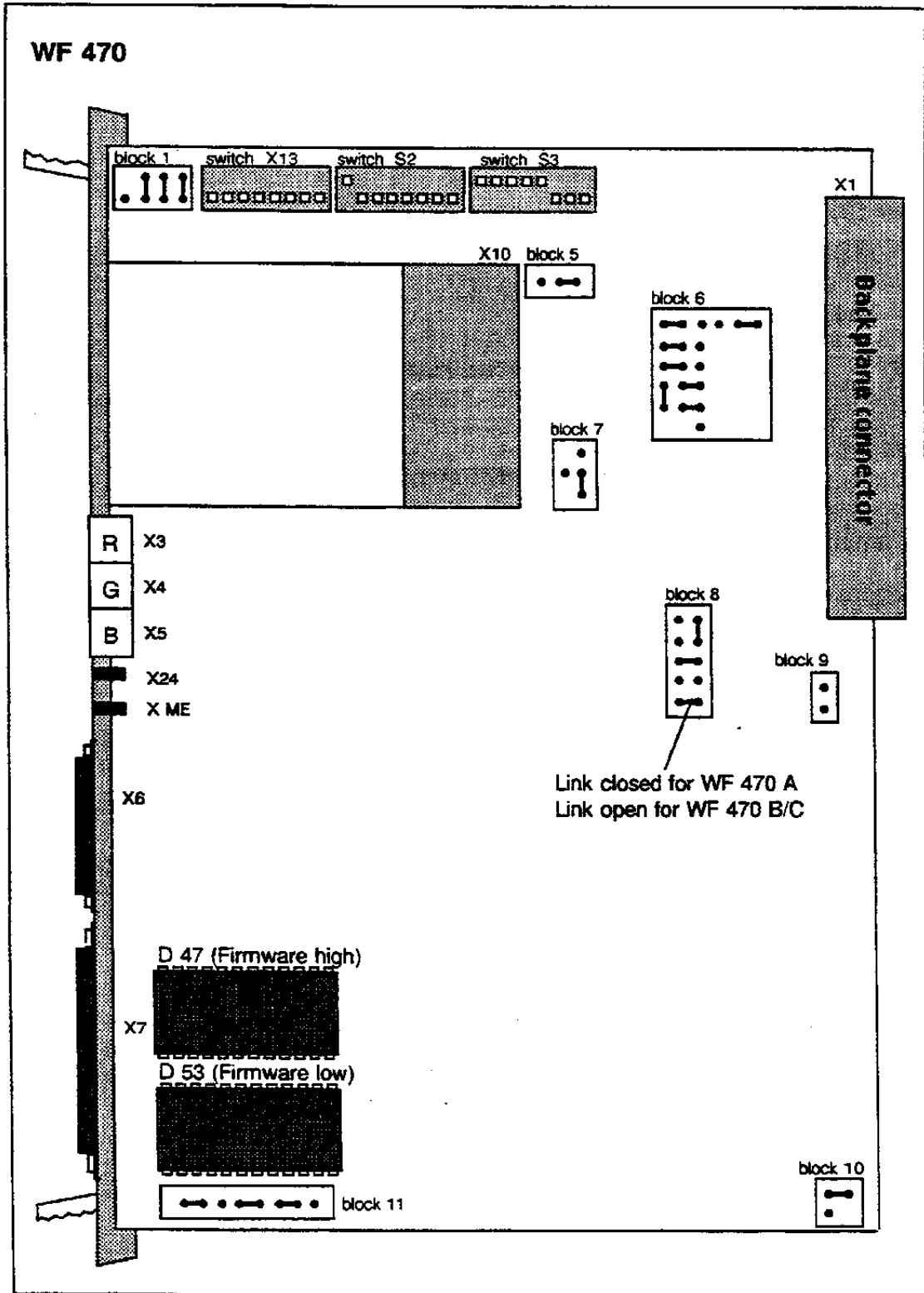

Fig. 4.1 Bridge and Switch positions for the WF 470 base board

Functions (see fig 4.1) :

Switch X 13	: Start address DPR when peripheral module enable of the DPR
Switch S 2.1	: S5 buffer supply (fixed setting)
Switch S 2.2 - 2.8	: memory segment address (fixed setting)
S S 3	: Start address DPR when central module
X1	: Bus connector
X3-X5	: RGB-BAS monitor connector
X6	: RGB-TTL monitor connector
X7	: serial interface for PG
X10	: Memory module socket
X24, XME	: Connections for voltage supply for active interfaces
Link block 1	: DPR size when WF 470 is a peripheral module
Link block 5	: enable memory segment addressing (Fixed setting)
Link block 6	: DPR size for memory segment addressing segment addressing (ON/OFF)
Link block 7	: addressing type (S5/MMC216)(Fixed setting)
Link block 8	: mode (central module/peripheral) hardware acknowledge (signal RDY) (Fixed) picture format (Fixed setting) module type (WF470 A or WF 470 B/C)
Link block 9	: Fixed setting
Link block 10	: Picture format (Fixed setting)
Link block 11	: EPROM type (Fixed setting) DPR size (Fixed setting)

4.2.5.1 Bridge and switch positions WF 470 (6FM1 470-3xx20), Up to firmware version V2.0

In order to incorporate additional features on the WF 470, the size of the EPROM modules has been increased. From V 2.1, two EPROMs type 27512 are now used. The setting of the links on link block 11 shown in Fig 4.2 is for these new EPROMs.

If versions V2.0 or below are to be used, the link block must be set as shown below:



Link block 11

4.2.5.2 Function of the bridging links on the WF 470 extension board (6FM1 470-3xx20)

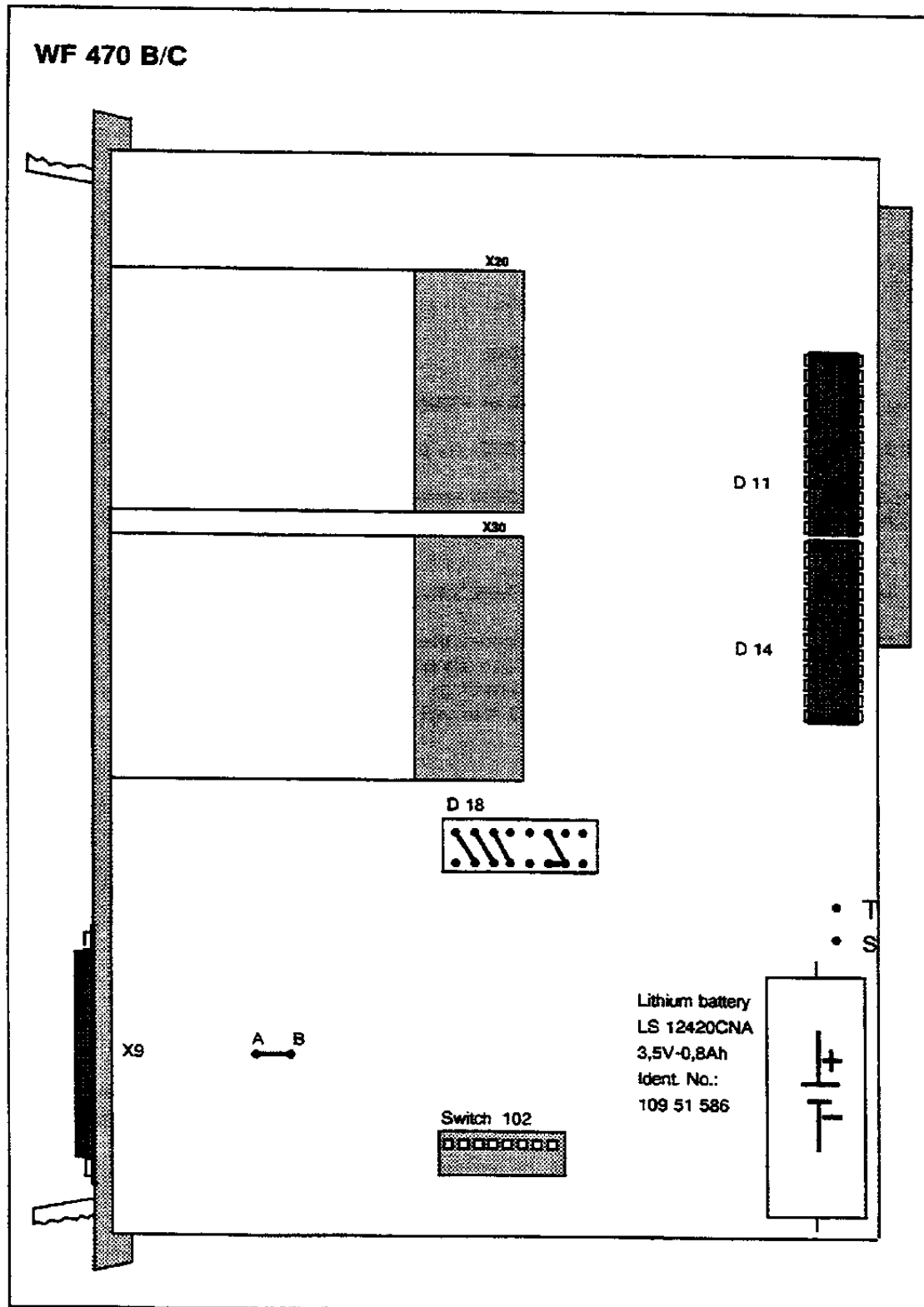

Fig. 4.2 Switch settings on the WF 470 B/C extension board.

Details of settings for fig 4.2:

D 18	:	RAM coding (fixed setting)
S102	:	Switch currently not used (all switches OFF)
X5V	:	+5V supply (test point)
X0V	:	0V supply (test point)
X9	:	Serial interface
X20, X30	:	Sockets for memory modules
T-S	:	Battery buffer on (bridge inserted)
A-B	:	Watchdog active

*) PAL = Programmable array logic
 This is a type of PROM used for address setting.
 PAL D 11 controls the module slot X 20
 PAL D 14 controls the module slot X 30

4.2.6 WF 470 (6FM1 470-3xx20) configured as central module

If the WF 470 is to be used as a central module, it must be fitted in one of the locations described in section 2.5.

The Dual Port Ram size is fixed as 256 byte. Its factory pre-set coding is set on link block 1 and 6.

The start address of the dual port ram depends on the type of central processor unit being used (see section 2.6). If the factory pre-settings cannot be used, the start address can be changed in steps of 256 byte. This is done by altering the settings on switch S3 on the base board.

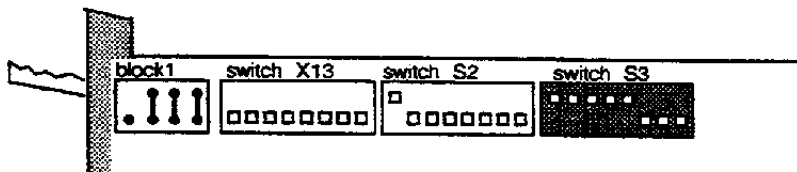
**4.2.6.1 Factory pre-set address: E000**

Switch No.	1	2	3	4	5	6	7	8	Note:
ON	<input type="checkbox"/>	<input type="checkbox"/>	<input type="checkbox"/>	<input type="checkbox"/>	<input type="checkbox"/>	<input type="checkbox"/>	<input type="checkbox"/>	<input type="checkbox"/>	The actual position of the plastic switch lever is shown in white.
OFF	<input type="checkbox"/>	<input type="checkbox"/>	<input type="checkbox"/>	<input type="checkbox"/>	<input type="checkbox"/>	<input type="checkbox"/>	<input type="checkbox"/>	on = "0"	
Address bit	8	9	10	11	12	13	14	15	off = "1"

4.2.6.2 Setting the address

The setting of the address switch is easier to understand when the board is turned upside-down so that the switches are at the bottom of the board as shown:

When the switch is up (off) this sets a 1 condition.
 When the switch is down (on) this sets a 0 condition.

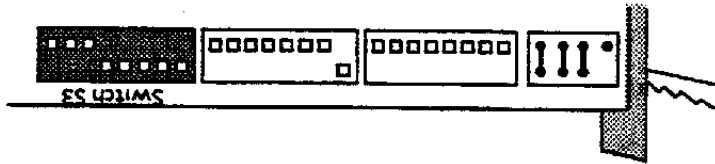

Value	2^{15}	2^{14}	2^{13}	2^{12}	2^{11}	2^{10}	2^9	2^8
Address bit	15	14	13	12	11	10	9	8

Address	E				0			
Bit pattern	1	1	1	0	0	0	0	0

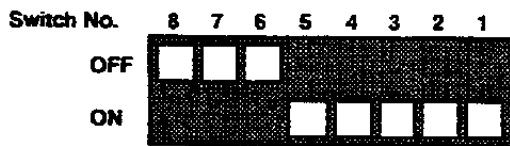

Note: The actual position of the plastic switch lever is shown in white
 off = "1"
 on = "0"

4.2.6.3 Example settings:

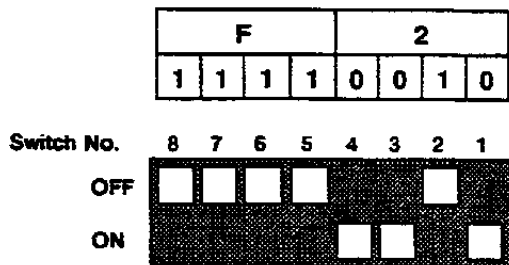
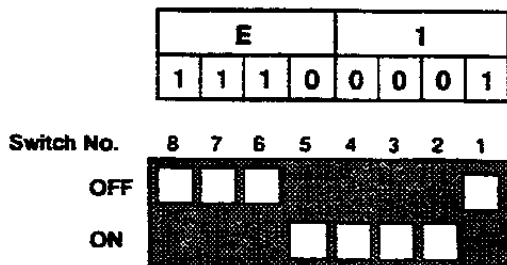

All switches not shown remain in their as delivered settings, see fig. 4.1 and 4.2.

4.2.7 WF 470 (6FM1 470-3xx20) configured as a peripheral module

If the WF 470 is to be used as a peripheral module it must be fitted in one of the locations described in section 2.4.2 or 2.5. The WF 470 module is *NOT* usually configured as a peripheral module since this limits the number of analogue cards which can be used, and the data transfer operates more slowly. The WF 470 should only be used in this mode if it is not possible to use it as a central module.

The Dual Port Ram size must be set on link block 1 to 32, 64, 128 or 256 byte.

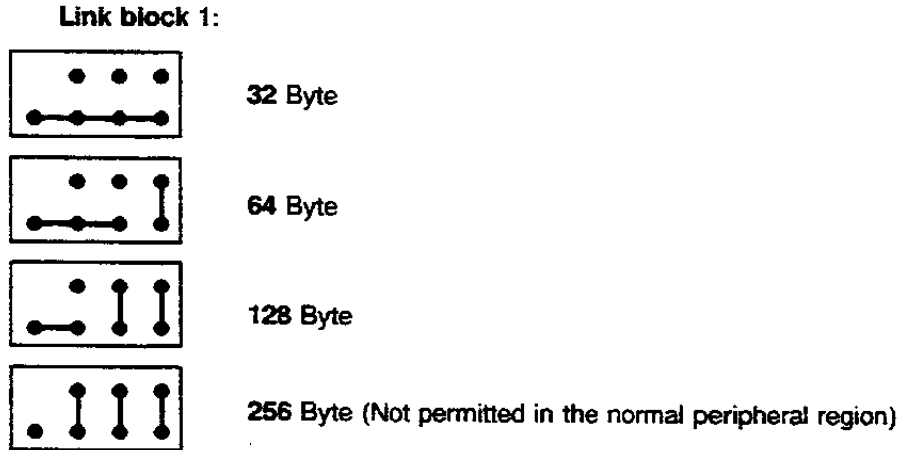

The switch X13 is used to set the start address of the peripheral region and to enable the DPR.

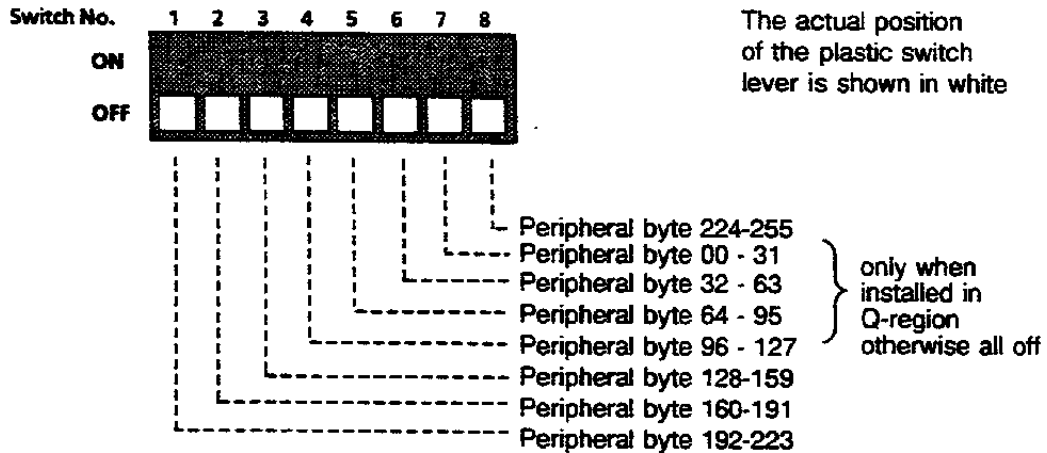

For example:

DPR from PB 192 to PB 255 (DPR size: 64 byte, DPR-start address F0C0)

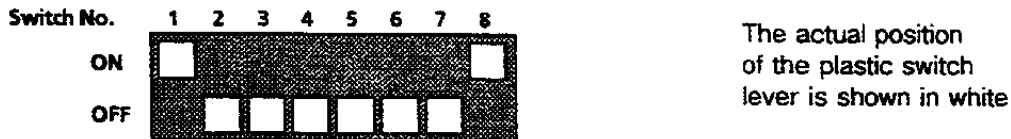

Link block 8 must be used to switch the PESP signal onto the board.

Link block 8:

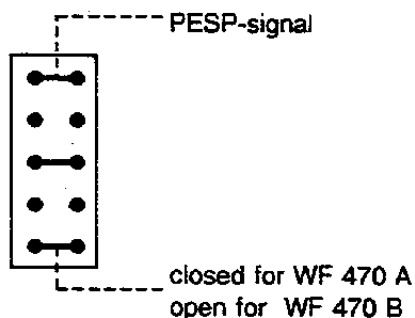

All other bridges and switches links should be in the factory pre-set condition.

WARNING:

- The selected DPR region must not be in the peripheral region with process image.
- The dual port ram start address can only be set in steps of the DPR size (link block 1)

The DPR addresses can have the following settings:

Start address		DPR Size				Comment
PB	Absolute	256	128	64	32	
0	F000	x	x	x	x	Only in extended peripheral region
32	F020				x	
64	F040			x	x	Only S5-130WB peripheral region
96	F060				x	
128	F080		x	x	x	All controllers (analogue region)
160	F0A0				x	
192	F0C0			x	x	
224	F0E0				x	

4.2.8 Powering up the SIMATIC and Commissioning Sequence

- Fit the WF 470 in the correct location with the power switched off.
- Fit a RAM module into location K1 in the WF 470 (only necessary for the WF 470 A and B).
- Connect the peripheral units
- Switch on the controller, monitor and programming unit
- Erase the controller memory
- Load the standard software into the PC
- Call the standard software from OB1 and parameterise according to section 3.1
- Press the RESET button on the front of the WF 470 and set the time and date via the keyboard
- Connect the PG 675/85 to the WF 470 using the correct cable.
- Load the operating system and start the picture construction software
- Load the completed pictures or commence picture construction (see programming instructions)

4.2.9 Fault Finding

The majority of errors are picked up by the WF 470 and displayed as an error number and text at the bottom of the WF 470 screen. Should an error occur and the checks detailed in the commissioning instructions have been made, the information in the following pages should enable the fault to be located.

The first step in the fault location sequence is to determine if the fault lies on the side of the SIMATIC or the side of the WF 470. This can be determined by analysing the dual port ram, which is the interface between the SIMATIC and the WF 470 (Refer to section 4.2.2).

However, before this it should be checked that the module is correctly addressed for the PLC to which it is connected. The standard software must be correctly parameterised and called. The PC must be in run-operation in order for the dual port ram to function correctly. The best check that everything is functioning is to press a key on the operator keyboard (e.g. the reset key) and check that the WF 470 responds correctly.

If the WF 470 does not respond correctly or the PLC goes into stop, the module addressing or the parameterisation or version of the standard software must be incorrect.

4.2.9.1 WF 470 error messages

Error No.	Cause
01	Superfluous control information
02	Control information missing
03	Direct and indirect symbol control programmed
04	System RAM too small
06	invalid memory sector specified
07	invalid data request via DPR (DB missing)
08	Acknowledgement delay from S5 (S5 not processing the DPR)
09	Symbol list missing
10	Selected picture missing
11	Symbol positioned outside picture boundary
12	Composite symbol outside picture boundary
13	Text group missing for selected picture
14	System data list missing
15	Printer option not loaded
16	Print element not present
17	Printer message triggered from more than 3 DBs

- 18 RAM memory too small
- 20 System RAM acquisition error → Try erasing the RAM in slot 3
- 21 System RAM response error → Try erasing the RAM in slot 3
- 22 Hardware configuration error
- 23 Sequence analyser option not loaded
- 24 Service module not loaded
- 25 Printer output
- 100 } Error messages
- to } from the
- 115 } application program

4.2.9.2 Analysing the DPR

The data exchange between the S5 and WF 470 is controlled by the co-ordination section of the dual port ram (byte 0-11). The standard software (FB S5 - WF470) produces an image of the co-ordination section of the DPR in the scratch pad flags 240-251. The flags can be checked in status, if the instructions L FW 240 - L FW 250 are written in segment 4 after the TNW 5 instruction in the case of the S5 150U, or the TNB 5 instruction in the S5 135 U and 115U.

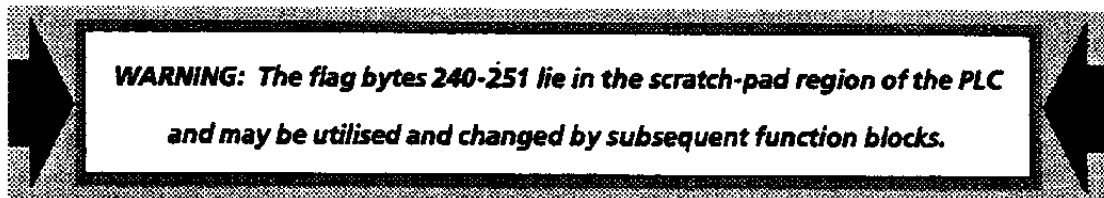

Configuration of the DUAL PORT RAM:

FW 240	Data code	DB Number	0 / 1	DPR bytes
FW 242	Start parameter		2 / 3	
FW 244	Data quantity/region	Keyboard byte	4 / 5	
FW 246	S5 acknowledgement	WF acknowledgement	6 / 7	
FW 248	Picture No. 1	Picture No. 2	8 / 9	
FW 250	Picture No. 3	Status byte	10 / 11	

Functions:

- **Data code (DPR byte 0 / FB 240):**

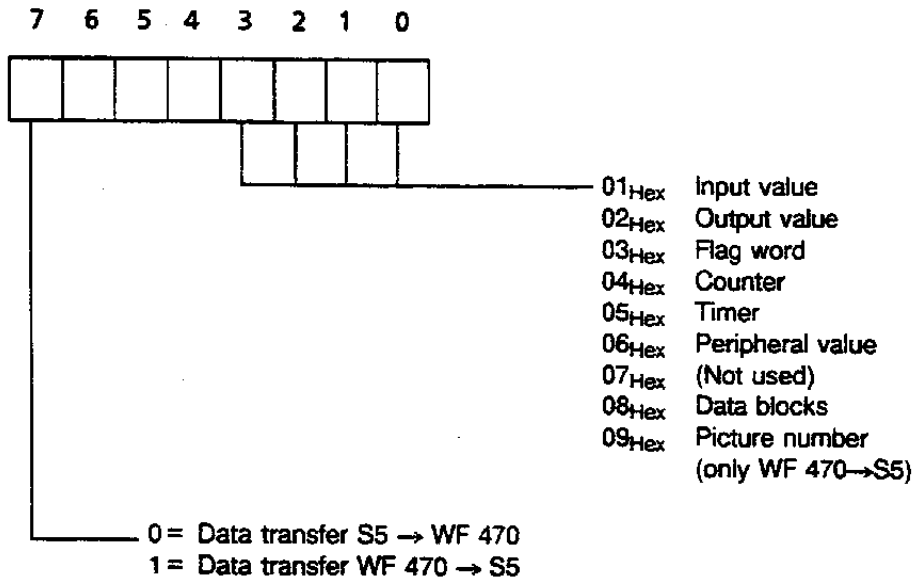

- **Data block number (DPR byte 1 / FB 241):**

Valid in connection with data codes 08 Hex to 88Hex (transfer of data blocks). Value range 1 .. 255.

- **Start parameter (DPR byte 2 + 3 / FW 242):**

Provides the address from which the data is to be transferred (i.e. for a DB or from which DW).

The interpretation depends on the DPR byte 0/FB240.

- **Amount of data (DPR byte 4 / FB244):**

This information depends on:

- The effective length of the DPR
- The permitted size (see DPR byte 1/2)

- **Keyboard byte (DPR byte 5 / FW 245 / Parameter TAST in FB)::**

This byte transfers characters from the keyboard.

• **Coordination byte (DPR byte 6and7 / FW246):**

These bytes control the request and acknowledgement of the transferred data. Each bit in one byte has a corresponding bit in the other. One partner (SIMATIC S5 / WF 470) may only access its corresponding bit, the other may then only read the data (exception: reset during operation via the WF 470). When one partner recognises that the state of a bit has been changed by the other partner, it acknowledges this by changing its corresponding bit to the same state.

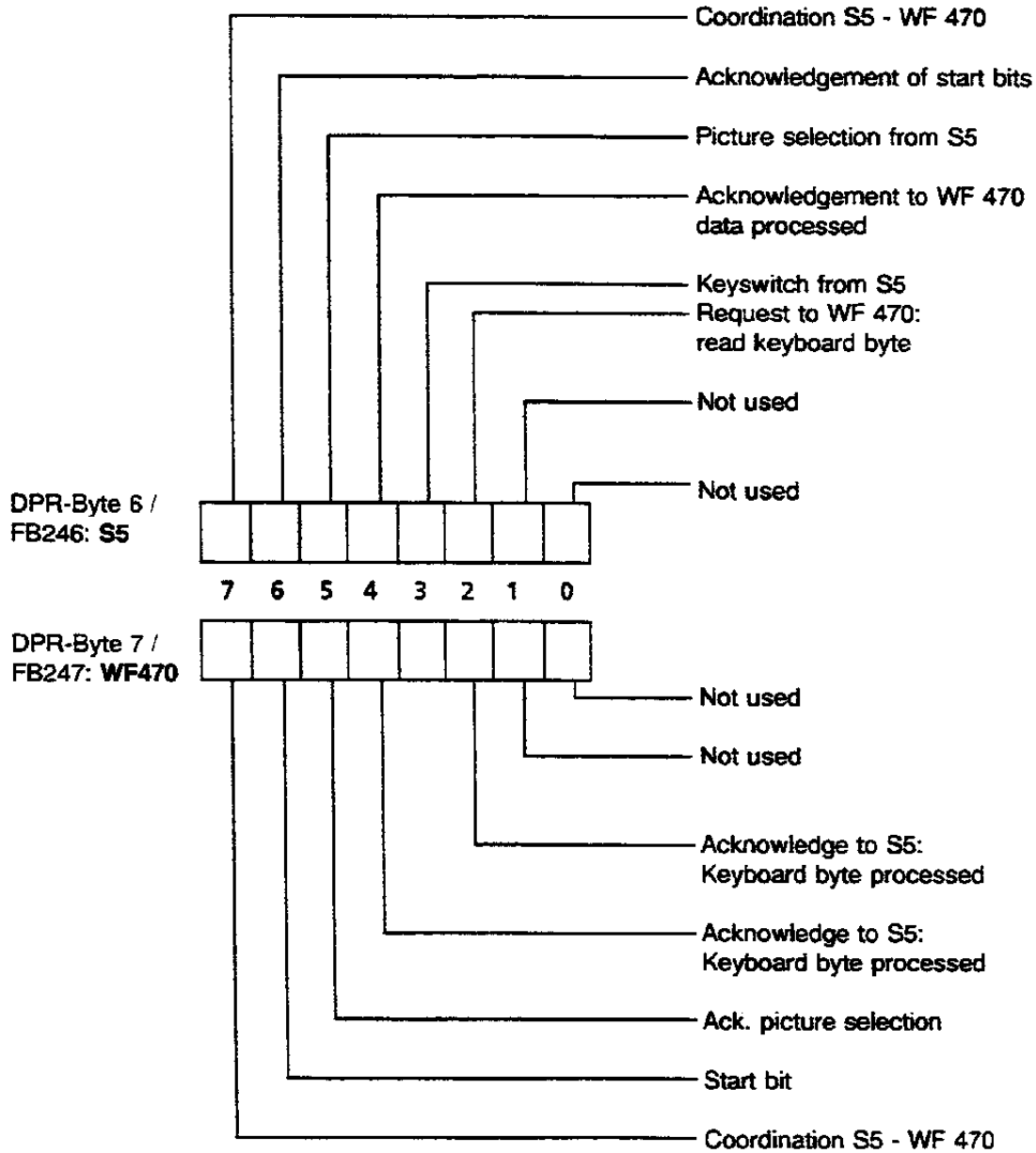

Coordination bits x.7 Coordination and start up bit. Set by WF 470 on power up; acknowledged in byte 6 by the S5.

Picture selection bit x.5 In conjunction with Byte 8 to 10, this bit is used for direct picture selection from the SIMATIC S5.

- **Picture number (DPR 8 to 10, FB 248 to 250)**

This corresponds to the parameter BLD 1-3 in the S5 WF 470 function block. Direct picture selection from the S5, or returning the picture number.

- **Status (DPR byte 11 / FB 251)**

A transfer request bit must be sent before an acknowledgement (and in all cases by the slave).

Status	Function
--------	----------

0	Transfer without display complete
	For a send task: Data valid
	For a receive task: Data accepted

0FE _{Hex}	Data request invalid Data not available
--------------------	--

0FD _{Hex}	Invalid location request
--------------------	--------------------------

0FC _{Hex}	Invalid picture number (Picture number request from S5)
--------------------	--

The initiative for the data exchange between the WF 470 and the SIMATIC S5 normally comes from the WF 470. For example, a data block is required, so the module places the code 08 Hex in Byte 0 in the dual part ram, and the number of the data block required in byte 1, the start data word number in bytes 2 and 3, and the number of words in byte 4. Bit 4 in byte 7 is then set to 1.

On receipt of this request, the S5 - WF 470 function block in the PLC then writes the contents of the required data block in the DPR starting from byte 12, and acknowledges this by setting bit 4 in byte 6 to 1. The data is then loaded into the WF 470 which acknowledges by setting the request bit in byte 7 back to 0.

The SIMATIC S5 acknowledges from its side by resetting bit 4 in byte 6 to 0. The WF 470 can now enter a new data request.

The SIMATIC S6 only has the initiative in a data exchange in picture selection or when data is entered in the TAST byte.

5 Appendix

5.1 Ordering information

5.1.1 Ordering information for the WF 470 hardware

WF 470 Hardware	Order Number
WF 470 A colour graphics	6FM1 470-3AA21
WF 470 B colour graphics	6FM1 470-3BA21
WF 470 C colour graphics	6FM1 470-3CA21
WF 470 A monochrome graphics	6FM1 470-4AA21
WF 470 B monochrome graphics	6FM1 470-4BA21

The WF 470 module is only delivered in "low-power" versions now. It is compatible to the earlier version in all respects.

5.1.2 Ordering information for WF 470 firmware upgrade

WF 470 Firmware	Order Number
1 Set EPROM 2x27512	6FM1 470-7AA21

5.1.3 Ordering information for WF 470 - SIMATIC software

WF 470 - SIMATIC Software	Order Number	
	5 $\frac{1}{2}$ " floppy disk	3 $\frac{1}{2}$ " floppy disk
FB 130 W WF 470	6FM1 470-6AB10	—
FB 150S/U WF 470	6FM1 470-6AD10	6FM1 470-6AD50
FB 115 U WF 470	6FM1 470-6UA10	6FM1 470-6UA50
FB 135 U WF 470	6FM1 470-6UB10	6FM1 470-6UB50
FB 155 U WF 470	6FM1 470-6UC10	6FM1 470-6UC50

5.1.4 Ordering information for WF 470 option software

WF 470 - Option Software	Order Number	
	5 $\frac{1}{2}$ " floppy disk	3 $\frac{1}{2}$ " floppy disk
Service module for WF 470	6FM1 470-7EA10	6FM1 470-7EA50
Sequence diagnostics for WF 470 DIMOS	6FM1 470-7EA20	6FM1 470-7EB50
Sequence diagnostics for WF 470 Graph 5	6FM1 470-7EA30	6FM1 470-7EC50
B/C Printer report and event log system for WF 470	6FM1 470-7EA40	6FM1 470-7ED50

5.1.5 Ordering information for WF 470 - PG 675 picture construction

WF 470 - PG 675 Picture Constr.-software	Order Number
PG 675 WF 470 German	6FM1 470-8BA20
PG 675 WF 470 English	6FM1 470-8BE20
PG 675 WF 470 French	6FM1 470-8BF20
PG 675 WF 470 Cyrillic	6FM1 470-8BR20

5.1.6 Ordering information for WF 470 - PG 685 picture construction

WF 470 - PG 685 Picture Constr.-software -	Order Number
PG 685 WF 470 German	6FM1 470-8CA20
PG 685 WF 470 English	6FM1 470-8CE20
PG 685 WF 470 French	6FM1 470-8CF20
PG 685 WF 470 Cyrillic	6FM1 470-8CR20
PG 685 ZULI WF Conversation program: Allocation list ⇒ sequence list	6FM1 470-8CU00

5.1.7 Ordering information for WF 470 - PG 750 picture construction

WF 470 - PG 750 Picture Constr.-software -	Order Number	
	5¼" floppy disk	3½" floppy disk
PG 750 WF 470 German	6FM1 470-8DA20	6FM1 470-8DA50
PG 750 WF 470 English	6FM1 470-8DE20	6FM1 470-8DE50
PG 750 WF 470 French	6FM1 470-8DF20	6FM1 470-8DF50

The PG 750 software can be run on a PC 16-20 or PC 32-05 from version V4.4. There is no general release for AT-compatible PC's!

5.1.8 Ordering information for cables

Connection cable	max. Standard length	Order Number
From WF 470 X3, X4, X5 to RGB-BAS colour monitor or to distribution unit length 2 m length 5 m length 10 m length 18 m length 25 m length 35 m length 50 m length 60 m Special lengths (specify length)	60 m	6FM1 490-3BA00 6FM1 490-3BB00 6FM1 490-3BC00 6FM1 490-3BD00 6FM1 490-3BE00 6FM1 490-3BF00 6FM1 490-3BG00 6FM1 490-3BH00 6FM1 490-3BZ00
From distribution unit to RGB-BAS colour monitor length 2 m length 5 m length 10 m length 18 m length 25 m length 35 m Special lengths (specify length)	35m	6FM1 490-3CA00 6FM1 490-3CB00 6FM1 490-3CC00 6FM1 490-3CD00 6FM1 490-3CE00 6FM1 490-3CF00 6FM1 490-3CZ00
From WF 470 X4 to Monochrome monitor or to distribution unit length 2 m length 5 m length 10 m length 18 m length 25 m length 35 m length 50 m length 60 m Special lengths (specify length)	60 m	6FM1 490-3DA00 6FM1 490-3DB00 6FM1 490-3DC00 6FM1 490-3DD00 6FM1 490-3DE00 6FM1 490-3DF00 6FM1 490-3DG00 6FM1 490-3DH00 6FM1 490-3DZ00
From WF 470 X4 to desk monitor C79 145-A3033-A3 length 2 m length 5 m length 10 m length 18 m length 25 m length 35 m length 50 m length 60 m Special lengths (specify length)	60 m	6FM1 490-3EA00 6FM1 490-3EB00 6FM1 490-3EC00 6FM1 490-3ED00 6FM1 490-3EE00 6FM1 490-3EG00 6FM1 490-3EH00 6FM1 490-3EZ00

Connection cable	max. Standard length	Order Number
From distribution unit to Monochrome monitor length 2 m length 5 m length 10 m length 18 m length 25 m length 35 m length 50 m length 60 m Special lengths (specify length)	60 m	6FM1 490-3FA00 6FM1 490-3FB00 6FM1 490-3FC00 6FM1 490-3FD00 6FM1 490-3FE00 6FM1 490-3FF00 6FM1 490-3FG00 6FM1 490-3FH00 6FM1 490-3FZ00
From distribution unit to desk monitor C79 145-A3033-A3 length 2 m length 5 m length 10 m length 18 m length 25 m length 35 m length 50 m length 60 m Special lengths (specify length)	60 m	6FM1 490-3GA00 6FM1 490-3GB00 6FM1 490-3GC00 6FM1 490-3GD00 6FM1 490-3GE00 6FM1 490-3GF00 6FM1 490-3GG00 6FM1 490-3GH00 6FM1 490-3GZ00
From WF 470 X6 to RGB-TTL monitor length 2 m	2 m	6FM1 490-3AA00
From WF 470 X7 to PG 675 / PG 685 or to distribution unit length 2 m length 5 m length 10 m length 18 m length 25 m length 35 m Special lengths (specify length)	35 m	6FM1 490-1BA00 6FM1 490-1BB00 6FM1 490-1BC00 6FM1 490-1BD00 6FM1 490-1BE00 6FM1 490-1BF00 6FM1 490-1BZ00
From distribution unit to PG 675 / PG 685 / PG 750		6ESS5 731-0 . . . 0 see catalogue ST 54.1

Connection cable	max. Standard length	Order Number
From WF 470 X7 to compact operator station or to operation keyboard WS 495/ 496 length 2 m length 5 m length 10 m length 18 m length 25 m length 35 m length 50 m length 60 m Special lengths (specify length)	60 m	6FM1 490-1DA00 6FM1 490-1DB00 6FM1 490-1DC00 6FM1 490-1DD00 6FM1 490-1DE00 6FM1 490-1DF00 6FM1 490-1DG00 6FM1 490-1DH00 6FM1 490-1DZ00
From WF 470 X9 to PT 88 / PT 89 TTY length 2 m length 5 m length 10 m length 18 m length 25 m length 35 m Special lengths (specify length)	35 m	6FM1 490-1CA00 6FM1 490-1CB00 6FM1 490-1CC00 6FM1 490-1CD00 6FM1 490-1CE00 6FM1 490-1CF00 6FM1 490-1CZ00
From WF 470 X9 to PT 88 / PT 89 V24 length 5 m	5 m	6FM1 490-2CB00

5.2 Bibliography

- | | | |
|-----|---|------------------------------------|
| /1/ | WF 470 Video display module
Short description | Order Number 6ZB5 440-0FV02-0BA0 |
| /2/ | WF 470 Video display module
Short description | Order Number 6ZB5 440-0FH02-0AA0 |
| /3/ | WF 495/WS 496 op station
Description | Order Number E80850-J160-X-A2-7600 |
| /4/ | WS 463 S External data memory
Short Description | Order Number E80850-J115-X-A2-7600 |
| /5/ | WF 463 S External data memory
Description | Order Number 6ZB5 440-0JG02-0BA0 |
| /6/ | WS 400-10/WS 400-20 Operator panels
Short description
(in preperation) | Order Number 6ZB5 440-0AK02-0BA0 |
| /7/ | WS 400-10/WS 400-20 Operator panels
Description | Order Number 6ZB5 440-0AR02-0BA1 |

Siemens AG

AUT V240
Postfach3180

D-91050 Erlangen

Fed. Rep. of Germany

Suggestions

Corrections

For Publication/Manual:

Equipment for special machines

WF 470

Display Module

Description

Order-No.: 6ZB5 440-0JF02-0BA5

Edition: August 1991

From:

Name _____

Company/Dept. _____

Address _____

Telephone / _____

If you find any printing errors when reading this publication, please let us know, using this form. We also welcome any suggestions to improve the manual.

Suggestions and/or corrections

Equipment
for
Special
Machines

WF 470

Manual

Siemens AG
Automation Group
Automation Systems
for Machine Tools, Robots
and Special-Purpose Machines
P.O. Box 3180, D-91050 Erlangen
Federal Republic of Germany

© Siemens AG 1994 All Rights Reserved
Subject to change without prior notice
570.093.300106

Siemens Aktiengesellschaft

Order No. 6ZB5 440-0JF02-0BA5
Printed in the Fed. Rep. of Germany
(3003) RGWE/540093 BS 12940.1 (4620)



Progress
in Automation.
Siemens