

# 59630 Sensor with Integral Float Actuator

RoHS

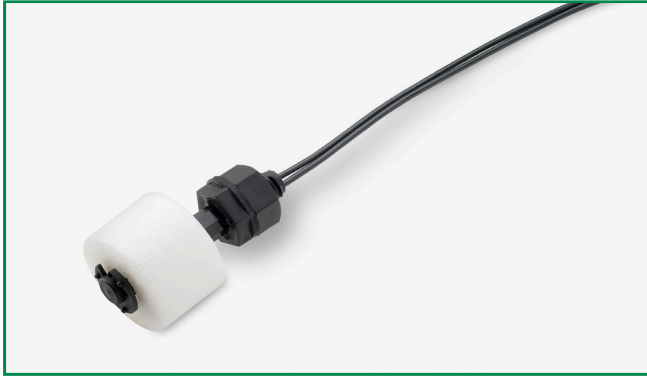

## Description

The 59630 is a reed level sensor with integral float actuator and an M8 x 1.25mm pitch thread with a choice of normally open, normally open high voltage, normally closed or change over contacts. It is capable of switching up to 265Vac/300Vdc at 10VA. It is ideally suited to liquid and air conditioning condensate and industrial process control applications.

## Features

- Sensor with integral blown polypropylene float, with integral magnet
- Sensor operates when float rises from end stop position
- Choice of contacts
- Choice of connector and cable length options

## Dimensions

Dimensions in mm (inch)

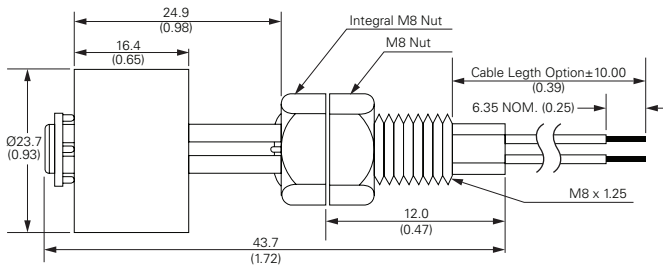

## Benefits

- Hermetically sealed, magnetically operated contacts continue to operate long after optical and other technologies fail due to contamination
- No standby power required
- Simple installation with M8 thread and nut

## Applications

- Liquid level control
- Air conditioning systems
- Industrial Process Control

Schematics	Switch Type
Black Black	1 and 2
Black Blue White	3
Black Black	4

# 59630 Sensor with Integral Float Actuator

## Electrical Ratings

Contact Type			Normally Open	Normally Open High Voltage	Change Over	Normally Closed
Switch Type			1	2	3	4
Contact Rating <sup>1</sup>		VA/Watt - max.	10	10	5	10
Voltage <sup>4</sup>	Switching <sup>2</sup>	Vdc - max.	200	300	175	200
	Breakdown <sup>3</sup>	Vac - max.	140	265	120	120
		Vdc - min.	250	400	200	250
Current <sup>4</sup>	Switching <sup>2</sup>	Adc - max.	0.5	0.4	0.25	0.5
	Carry	Aac - max.	0.35	0.30	0.18	0.18
		Adc - max.	1.2	1.4	1.5	1.2
Resistance <sup>5</sup>	Contact, Initial Insulation	Ω - max.	0.2	0.2	0.2	0.2
		Ω - min.	10 <sup>10</sup>	10 <sup>10</sup>	10 <sup>9</sup>	10 <sup>10</sup>
Capacitance	Contact	pF - typ.	0.3	0.2	0.3	0.3
Temperature	Operating	°C	-40 to +105	-20 to +105	-40 to +105	-40 to +105

## Product Characteristics

Operate Time <sup>6</sup>		ms - max.	1.0	1.0	3.0	3.0
Release Time <sup>6</sup>		ms - max.	1.0	1.0	3.0	3.0
Shock <sup>7</sup>	11ms ½ sine	G - max.	100	100	50	50
Vibration <sup>7</sup>	50-2000 Hz	G - max.	30	30	30	30

**Notes:**

- Contact rating - Product of the switching voltage and current should never exceed the wattage rating. Contact Littelfuse for additional load/life information.
- When switching inductive and/or capacitive loads, the effects of transient voltages and/or currents should be considered. Refer to Application Notes AN108A and AN107 for details.
- Breakdown Voltage - per MIL-STD-202, Method 301.
- Electrical Load Life Expectancy - Contact Littelfuse with voltage, current values along with type of load.
- This resistance value is for 300mm wire length. Resistance varies based on wire length.
- Operate (including bounce)/Release Time - per EIA/NARM RS-421-A, diode suppressed coil (Coil II).
- Shock and Vibration - per EIA/NARM RS-421-A and MIL-STD-202.
- For custom modifications to the wire length or size, or adding a special connector, please contact Littelfuse.

## Activation

Using sensor with float magnet orientated is illustrated

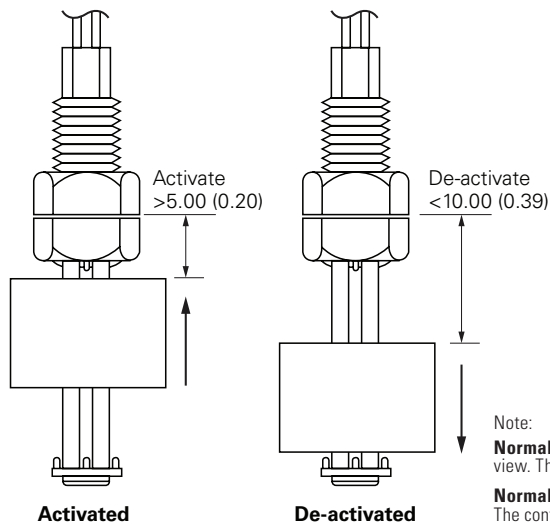

**Note:**

**Normally Open:** contacts are open when float is down as shown in the De-activate view. The contacts close when float is in upward position as shown on the left view.



**Normally Closed:** Contacts are closed when the float is in the down position. The contacts open when float is in the upward position as shown in the left view.

# 59630 Sensor with Integral Float Actuator

## Cable Length Specification

Cable Type: 24 AWG 7/32 PVC 105°C UL1430/UL1569	
Select Option	Cable Length mm (inch)
02	300 (11.81)

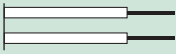
## Termination Specification

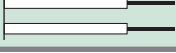
Termination Options		
Select Option	Description (Two-wire versions illustrated)	
A	Tinned leads (6.4±0.76)mm	
D	AMP MTE Connector 2.5mm pitch, 104257-1	
F	Untinned leads (6.4±0.76)mm	

## Part Numbering System

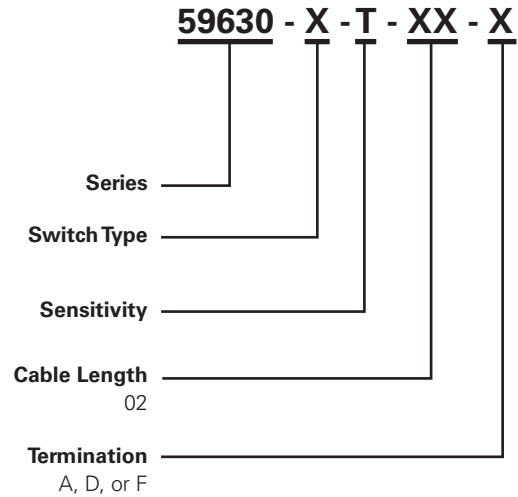

## Packaging

Packaging Option	Packaging Specification	Quantity	Quantity & Packaging Code	Taping Width
Bulk	Bulk	500	N/A	N/A