

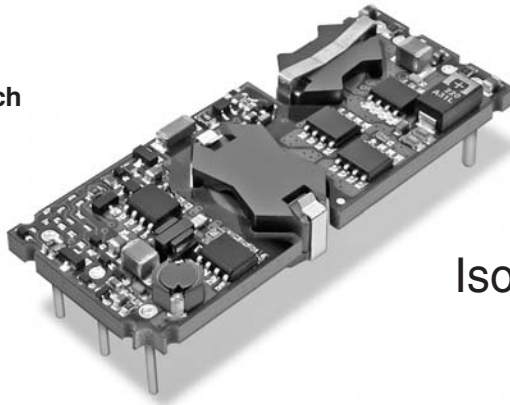

Lead-free
construction/attach

Single Output ULE 20A Models

Isolated, High-Density, Eighth-Brick
2-30 Amp, DC/DC Converters



Features

- New 1/8-brick package, 1/4-brick pinout in through-hole or SMT version
- 0.89 x 2.22 x 0.36 in. (22.6 x 56.4 x 9.1mm)
- Output current: 2-30 Amps
- Output voltages: 1.2V to 24V
- Input voltage: 12V, 24V and 48V nominal
- Interleaved, synchronous-rectifier topology delivers:
 - Outstanding efficiency (to 90.5%)
 - Low noise (50-70mVp-p)
 - Stable no-load operation
 - No output reverse conduction
- Excellent thermal performance
- On/off control, trim and sense pins
- Fully isolated (2250Vdc BASIC)
- Fully I/O protected; Thermal shutdown
- UL/EN/IEC60950 certification requested
- Lead-free construction/attach

DATEL's new ULE Series "Eighth-Brick" DC/DC Converters are high-current isolated power converters designed for use in high-density system boards. Measuring just 0.89 x 2.22 x 0.36 inches (22.6 x 56.4 x 9.1mm), these open-frame, low-profile E-bricks fit the industry-standard quarter-brick footprint. Now you can "cut-and-paste" the layout from your last Q-brick design to save time and save 44% board space (1.86 square inches versus 3.3) in the process.

From a 9-18V, 18-36V or 36-75V input, ULE's deliver 1.2 to 24 Volt outputs with current up to 30 Amps. They employ an interleaved, synchronous-rectifier topology that exploits 100% of their duty cycle. They simultaneously achieve high efficiency (to 90.5%), low noise (50-70mVp-p), tight line/load regulation ($\pm 0.25\%$), and quick step response (150 μ sec).

An open-frame design, high efficiency, low-on-resistance FET's, and planar magnetics embedded in heavy-copper pc boards all contribute to impressive thermal derating. The ULE's feature set includes high isolation (2250Vdc, 48V models), input pi filters, input undervoltage shutdown, output overvoltage protection, current limiting, short-circuit protection, and thermal shutdown. The standard footprint carries Vout trim, on/off control, and sense pins (sense pins are not available on 12V models).

All ULE E-Bricks are designed to meet the BASIC-insulation requirements of UL/EN/IEC60950, and all "D48" models (36-75V input ranges) will carry the CE mark. Safety certifications, EMC compliance testing and qualification testing (including HALT) are currently in progress. Contact DATEL for latest updates.

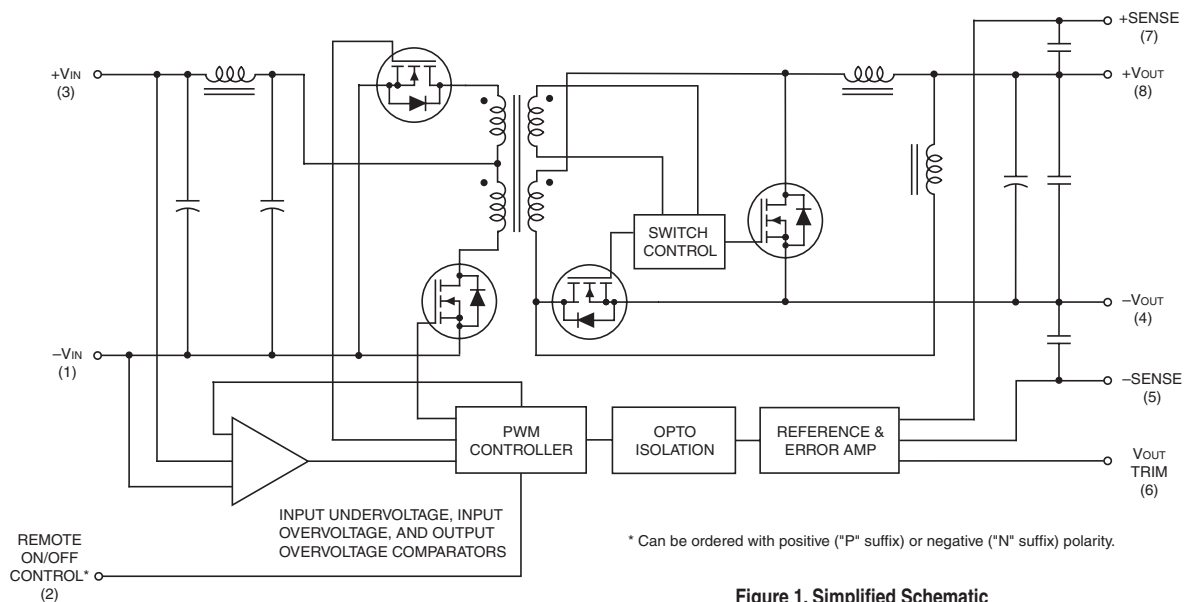

Figure 1. Simplified Schematic

Performance Specifications and Ordering Guide ^①

PRELIMINARY

Model ^②	Output						Input					Package (Case, Pinout)
	V _{OUT} (Volts)	I _{OUT} (Amps)	R/N (mVp-p) ^③		Regulation (Max.)		V _{IN} Nom. (Volts)	Range (Volts)	I _{IN} ^⑤ (mA/A)	Efficiency		
			Typ.	Max.	Line	Load ^④				Min.	Typ.	
ULE-1.2/30-D48 ^⑥	1.2	30	TBD	TBD	±0.25%	±0.25%	48	36-75	TBD	TBD	TBD	C56, C52, P32
ULE-1.5/20-D48 ^⑥	1.5	20	50	100	±0.25%	±0.25%	48	36-75	50/0.7	85%	87%	C56, C52, P32
ULE-1.8/20-D24 ^⑥	1.8	20	40	80	±0.25%	±0.25%	24	18-36	40/1.74	84.5%	86%	C56, C52, P32
ULE-1.8/20-D48	1.8	20	40	80	±0.25%	±0.25%	48	36-75	40/0.9	84.5%	86%	C56, C52, P32
ULE-2.5/20-D24	2.5	20	50	100	±0.25%	±0.25%	24	18-36	55/2.4	TBD	87%	C56, C52, P32
ULE-2.5/20-D48	2.5	20	50	100	±0.25%	±0.25%	48	36-75	50/1.2	86.5%	88%	C56, C52, P32
ULE-3.3/20-D12 ^⑥	3.3	20 ^⑧	60	100	±0.25%	±0.25%	12	9-18 ^⑦	100/6.15	89%	89.5%	C56, C52, P32
ULE-3.3/20-D24 ^⑥	3.3	20	50	100	±0.25%	±0.25%	24	18-36	60/3.1	87%	89%	C56, C52, P32
ULE-3.3/20-D48	3.3	20	50	100	±0.25%	±0.25%	48	36-75	50/1.6	87%	89%	C56, C52, P32
ULE-5/10-D12 ^⑥	5	10	50	100	±0.25%	±0.25%	12	9-18	160/4.7	87%	89%	C56, C52, P32
ULE-5/12-D24	5	12	50	100	±0.25%	±0.25%	24	18-36 ^⑦	50/2.3	87.5%	90%	C56, C52, P32
ULE-5/12-D48	5	12	50	100	±0.25%	±0.25%	48	36-75	50/1.4	88.5%	90.5%	C56, C52, P32
ULE-12/4.2-D24 ^⑥	12	4.2	50	100	±0.1%	±0.1%	24	18-36 ^⑦	55/2.36	86.5%	89%	C56, C52, P32
ULE-12/4.2-D48 ^⑥	12	5	70	140	±0.25%	±0.25%	48	36-75	55/1.2	86.5%	89%	C56, C52, P32
ULE-24/2-D48 ^⑥	24	2	100	TBD	±0.125%	±0.25%	48	36-75	45/1.06	93%	94%	C56, C52, P32

- ① Typical at T_A = +25°C under nominal line voltage and full-load conditions, unless otherwise noted. All models are tested and specified with external output capacitors (1µF multi-layer ceramic in parallel with 10µF tantalum).
- ② Add "N" or "P" to the part number for Remote Control Polarity. See Part Number Structure.
- ③ Ripple/Noise (R/N) is tested/specified over a 20MHz bandwidth.
- ④ Devices have no minimum-load requirements and will regulate under no-load conditions.

- Regulation specifications describe the output voltage deviation as the line voltage or load is varied from its nominal/midpoint value to either extreme. (Load step = 50%.)
- ⑤ Nominal line voltage, no load/full load conditions.
- ⑥ Contact DATEL for availability.
- ⑦ Half load output is 18V_{IN} minimum. Full load output is 20V_{IN} minimum.
- ⑧ Maximum output current is 18 Amps with 9-10V input voltage on ULE-3.3/20-D12.

MECHANICAL SPECIFICATIONS

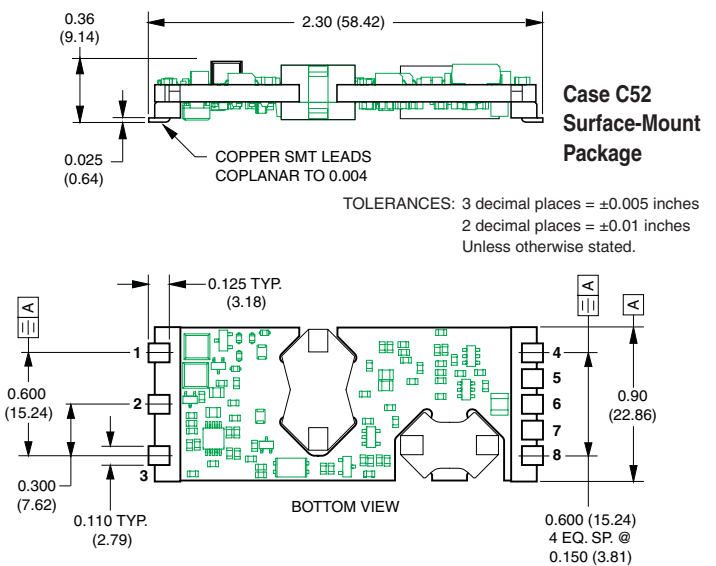
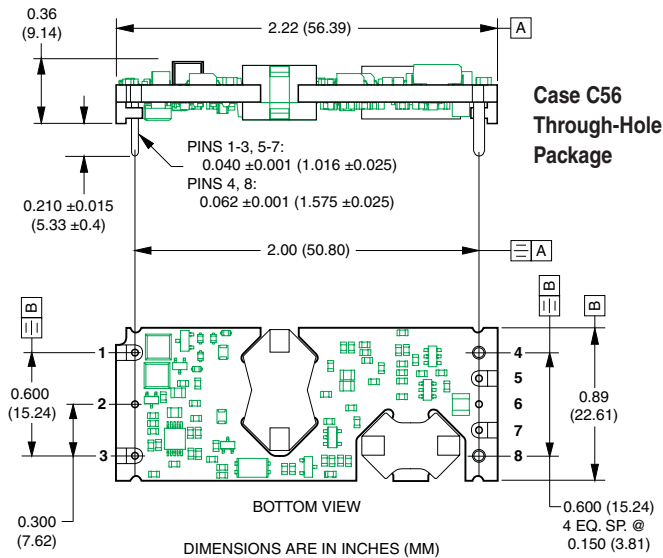

I/O Connections	
Pin	Function P32
1	-Input
2	On/Off Control *
3	+Input
4	-Output
5	-Sense **
6	Output Trim
7	+Sense **
8	+Output

* The Remote On/Off can be provided with either positive (P suffix) or negative (N suffix) polarity.
** 12V models do not include sense inputs.

PART NUMBER STRUCTURE

U L E - 1.2 / 30 - D48 N M Lx - C

Output Configuration:
U = Unipolar/Single

Eighth-Brick Package

Nominal Output Voltage:
1.2/1.5/1.8/2.5/3.3/5/12/24 Volts

Maximum Rated Output
Current in Amps

Input Voltage Range:
D12 = 10-18 Volts (12V nominal)
D24 = 18-36 Volts (24V nominal)
D48 = 36-75 Volts (48V nominal)

RoHS-6 compliant*

Pin Length Option: *Through-hole packages only*
(100 pcs. minimum quantity)
L1 Pin length 0.110 ± 0.010 inches (2.79 ± 0.25mm)
L2 Pin length 0.145 ± 0.010 inches (3.68 ± 0.25mm)

Surface-Mount Package
Contact DATEL for availability

Remote On/Off Control Polarity:
Add "P" for positive polarity (pin 2 open = converter on)
Add "N" for negative polarity (pin 2 open = converter off)

* Contact C&D Technologies (DateL) for availability.

Note:
Not all model number combinations are available. Contact DATEL.

Performance/Functional Specifications

Typical @ T_A = +25°C under nominal line voltage, 300 lfm airflow for extended operation and full-load conditions, unless noted. ①

Input	
Input Voltage Range:	
D12 Models	9-18 Volts (12V nominal) ⑤
D24 Models	18-36 Volts (24V nominal)
D48 Models	36-75 Volts (48V nominal)
Start-Up Threshold:	
D12 Models	8-8.5 Volts
D24 Models	17 Volts
D48 Models	31-36 Volts
Undervoltage Shutdown:	
D12 Models	7-8 Volts
D24 Models	16 Volts
D48 Models	32.5-34.5 Volts
Input Current:	
Normal Operating Conditions	See Ordering Guide
Standby Mode (Off, Under Voltage)	1-8mA (model dependent)
Output Short-Circuit Condition	40-250mA (model dependent)
Low Line Voltage (V _{IN} = V _{MIN}):	
ULE-1.8/20-D24, -D48	2.33 Amps, 1.08 Amps
ULE-2.5/20-D48	1.50 Amps
ULE-3.3/20-D12, -D24	7.37 Amps
ULE-3.3/20-D48	2.05 Amps
ULE-5/12-D24, -D48	3.31 Amps, 1.82 Amps
ULE-12/4.2-D24, -D48	3.15 Amps, 1.57 Amps
ULE-24/2-D48	1.42 Amps
Input Reflected Ripple Current ②	10-25mA _{p-p} (model dependent)
Input Filter Type	LC type
Overshoot Protection	None
Reverse-Polarity Protection ③	None
No-load Input Current	16-125mA (model dependent)
Remote On/Off Control: ⑤	
Positive Logic ("P" suffix models)	OFF = ground pin or +0.8 V max. ON = open pin or +3.5 to +13.5V max.
Negative Logic ("N" suffix models)	ON = ground pin or +0.8 V max. OFF = open pin or +3.5 to +13.5V max.
Remote Control On/Off Current	1mA pull-down
Sense Input Range ⑥	+10% of V _{OUT}
Output	
Total Output Power (V _{OUT} x I _{OUT} must not exceed maximum power):	
ULE-1.2/30-D48	TBD
ULE-1.8/20-D24, -D48	36.36 Watts
ULE-2.5/12-D24, -D48	50.50 Watts
ULE-3.3/20-D12, -D24, -D48	66.83 Watts
ULE-5/10-D12	50 Watts
ULE-5/12-D24	60 Watts
ULE-5/12-D48	60.75 Watts
ULE-12/4.2-D24, -D48	50.4 Watts
ULE-24/2-D48	48 Watts
Voltage Output Accuracy (50% load):	
Initial	±1.25% (except ±1.5% 1.2V and 1.8V)
Temperature Coefficient	0.02% of V _{OUT} per °C
Minimum Loading ①	No minimum load
Ripple/Noise (20MHz bandwidth)	See Ordering Guide
Line/Load Regulation	See Ordering Guide
Efficiency	See Ordering Guide
V_{OUT} Trim Range	-15% to +10% (-20% on 1.2V)
Isolation Voltage , input/output:	
D12 and D24 models	2000 Vdc min.
D48 models	2250 Vdc min.
Isolation Safety Rating	Basic
Isolation Resistance	100MΩ
Isolation Capacitance	470-1750pF (model dependent)

Current Limit Inception (98% of V _{OUT}):	
ULE-1.2/30-D48	TBD
ULE-3.3/20-D12	24 Amps
ULE-5/12-D24	16 Amps
ULE-5/12-D48	18 Amps
ULE-12/4.2-D24, -D48	6.25 Amps
20 Amp models	26 Amps
ULE-24/2-D48	3.5 Amps
Short Circuit Detection	See Note 6
Short Circuit Protection Method	Hiccup with autorecovery, see Tech Notes
Short Circuit Current	0.3-5 Amps (model dependent)
Short Circuit Duration	Continuous, output shorted to ground
Overshoot Protection:	Method: magnetic feedback
ULE-1.8/30-D48	3Vdc
ULE-2.5/20-D48	3Vdc
ULE-3.3/20-D12, -D48	3.96Vdc
ULE-5/12-D24	6Vdc
ULE-5/12-D48	6.4Vdc
ULE-12/4.2-D24, -D48	14Vdc
ULE-24/2-D48	3.96Vdc
Capacitive Load (ESR = 0.02Ω maximum)	10,000μF typical 15,000μF maximum (except ULE-12/4.2-D24 which is 2000μF typical) ULE-24/2-D48 is 470μF

Dynamic Characteristics

Dynamic Load Response: (50-75-50% load step)	50-250μSec, model dependent.
Start-Up Time: On/Off or V _{IN} on to V _{OUT}	50-160mSec for V _{OUT} = nominal
Switching Frequency:	
ULE-1.2/30-D48	340kHz ±40kHz
ULE-1.8/20-D24, -D48	340kHz ±10%
ULE-2.5/20-D48	400kHz ±10%
ULE-3.3/20-D12	310kHz ±10%
ULE-3.3/20-D24, -D48	365kHz ±10%
ULE-5/10-D12	450kHz ±10%
ULE-5/12-D24	450kHz ±10%
ULE-5/12-D48	450kHz ±10%
ULE-12/4.2-D24, -D48	400kHz ±10%
ULE-24/2-D48	200kHz

Environmental

Calculated MTBF ④	TBD Hours
Operating Temperature Range (Ambient) No derating, natural convection	-40 to +60 to +75°C, model dependent, see derating curves
With derating	See derating curves
Storage Temperature Range	-55 to +125°C
Thermal Protection/Shutdown	110-120°C
Altitude	0 to 10,000 feet
Relative Humidity	10% to 90%, non-condensing

Physical

Outline Dimensions	See Mechanical Specifications
Pin Material (Through-hole model)	Round copper with tin-lead plate over nickel underplate
Weight	1.55 ounces, 44 grams
Flammability Rating	UL94V-0
Electromagnetic Interference (User may need external filter)	FCC Part 15, EN55022, (conducted or radiated) Class B
Safety	UL/cUL 60950 CSA-C22.2 No.234 IEC/EN 60950

Performance/Functional Specifications footnotes (continued)

- ① All models are tested and specified with external 22μF tantalum input capacitor and 10μF/1μF tantalum/ceramic output capacitors. These capacitors are necessary for our test equipment and may not be required to achieve specified performance in your applications. Models are stable and regulate within spec under no-load conditions. Airflow is 300 lfm for extended operation.
- ② Input Ripple Current is tested and specified over a 5-20MHz bandwidth. Input filtering is $C_{IN} = 33\mu F$, $C_{BUS} = 220\mu F$, $L_{BUS} = 12\mu H$.
- ③ Current limit inception is given at either cold start-up or after warm-up.
- ④ Mean Time Before Failure is calculated using the Telcordia (Belcore) SR-332 Method 1, Case 3, ground fixed conditions, $T_{CASE} = +25^{\circ}C$, full load, natural air convection.
- ⑤ Maximum output current is 18 Amps with 9-10V input voltage on ULE-3.3/20-D12.
- ⑥ The On/Off Control may be driven with open-collector logic or by applying appropriate external voltages referenced to Common. The On/Off Control Input should use either an open collector/open drain transistor or logic gate which does not exceed +VIN.
- ⑦ Short circuit shutdown begins when the output voltage degrades approximately 2% from the selected setting.
- ⑧ Note that Maximum Power Derating curves indicate an average current at nominal input voltage. At higher temperatures and/or lower airflow, the DC/DC converter will tolerate brief full current outputs if the total RMS current over time does not exceed the Derating curve.
- ⑨ The user must install an external fuse in series with the input to protect against reverse polarity. See Input Fusing.
- ⑩ 12 Volt models do not include Sense inputs.

Absolute Maximum Ratings

Input Voltage:	
Continuous:	
12 Volt input models	18 Volts
24 Volt input models	36 Volts
48 Volt input models	75 Volts
Transient (100 mSec. Max.)	
12 Volt input models	25 Volts
24 Volt input models	50 Volts
48 Volt input models	100 Volts
On/Off Control (pin 2)	+VIN
Input Reverse Polarity Protection	5 Amps, 10 sec. max.
Output Overvoltage Protection	Magnetic feedback. See note (7).
Output Current *	Current-limited. Devices can withstand sustained short circuit without damage.
Storage Temperature	-55 to +125°C.
Lead Temperature	+300°C, 10 seconds max. Refer to solder profile.

These are stress ratings. Exposure of devices to any of these conditions may adversely affect long-term reliability. Proper operation under conditions other than those listed in the Performance/Functional Specifications Table is not implied.

* The outputs are not intended to sink appreciable current. If the outputs are forced to sink excessive current, damage may result.

TECHNICAL NOTES

Input Fusing

Certain applications and/or safety agencies may require the installation of fuses at the inputs of power conversion components. Fuses should also be used if the possibility of sustained, non-current-limited, input-voltage polarity reversals exist. For DATEL ULE 24-60 Watt DC/DC Converters, you should use slow-blow type fuses, installed in the ungrounded input supply line, with values no greater than the following.

Model	Fuse Values
12 Volt Input	10 Amps
24 Volt input	5 Amps
48 Volt Input	4 Amps

All relevant national and international safety standards and regulations must be observed by the installer. For system safety agency approvals, the converters must be installed in compliance with the requirements of the end-use safety standard, e.g. IEC/EN/UL60950.

Input Undervoltage Shutdown and Start-Up Threshold

Under normal start-up conditions, devices will not begin to regulate until the ramping-up input voltage exceeds the Start-Up Threshold Voltage. Once operating, devices will not turn off until the input voltage drops below the Undervoltage Shutdown limit. Subsequent re-start will not occur until the input is brought back up to the Start-Up Threshold. This built in hysteresis prevents any unstable on/off situations from occurring at a single input voltage.

Start-Up Time

The VIN to VOUT Start-Up Time is the interval of time between the point at which the ramping input voltage crosses the Start-Up Threshold and the fully loaded output voltage enters and remains within its specified accuracy band. Actual measured times will vary with input source impedance, external input/output capacitance, and load. The ULE Series implements a soft start circuit that limits the duty cycle of its PWM controller at power up, thereby limiting the input inrush current.

The On/Off Control to VOUT start-up time assumes the converter has its nominal input voltage applied but is turned off via the On/Off Control pin. The specification defines the interval between the point at which the converter is turned on and the fully loaded output voltage enters and remains within its specified accuracy band. Similar to the VIN to VOUT start-up, the On/Off Control to VOUT start-up time is also governed by the internal soft start circuitry and external load capacitance.

The difference in start up time from VIN to VOUT and from On/Off Control to VOUT is therefore insignificant.

Input Source Impedance

ULE converters must be driven from a low ac-impedance input source. The DC/DC's performance and stability can be compromised by the use of highly inductive source impedances. The input circuit shown in Figure 2 is a practical solution that can be used to minimize the effects of inductance in the input traces. For optimum performance, components should be mounted close to the DC/DC converter. If the application has a high source impedance, low VIN models can benefit of increased external input capacitance.

I/O Filtering, Input Ripple Current, and Output Noise

All models in the ULE 24-60 Watt DC/DC Converters are tested/specified for input reflected ripple current and output noise using the specified external input/output components/circuits and layout as shown in the following two figures.

External input capacitors (CIN in Figure 2) serve primarily as energy-storage elements, minimizing line voltage variations caused by transient IR drops in conductors from backplane to the DC/DC. Input caps should be selected for bulk capacitance (at appropriate frequencies), low ESR, and high rms-ripple-current ratings. The switching nature of DC/DC converters requires that dc voltage sources have low ac impedance as highly inductive source impedance can affect system stability. In Figure 2, CBUS and LBUS simulate a typical dc voltage bus. Your specific system configuration may necessitate additional considerations.

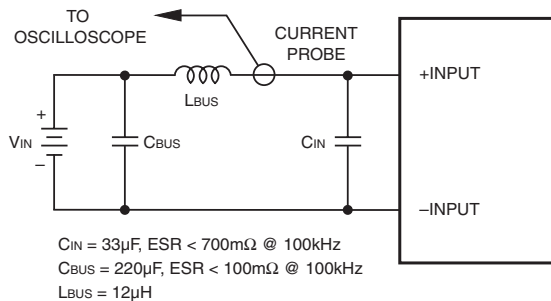

Figure 2. Measuring Input Ripple Current

In critical applications, output ripple/noise (also referred to as periodic and random deviations or PARD) may be reduced below specified limits using filtering techniques, the simplest of which is the installation of additional external output capacitors. These output caps function as true filter elements and should be selected for bulk capacitance, low ESR and appropriate frequency response. All external capacitors should have appropriate voltage ratings and be located as close to the converter as possible. Temperature variations for all relevant parameters should also be taken carefully into consideration.

The most effective combination of external I/O capacitors will be a function of line voltage and source impedance, as well as particular load and layout conditions. Our Applications Engineers can recommend potential solutions and discuss the possibility of our modifying a given device's internal filtering to meet your specific requirements. Contact our Applications Engineering Group for additional details.

In Figure 3, the two copper strips simulate real-world pcb impedances between the power supply and its load. In order to minimize measurement errors, scope measurements should be made using BNC connectors, or the probe ground should be less than 1/2 inch and soldered directly to the fixture.

Floating Outputs

Since these are isolated DC/DC converters, their outputs are "floating" with respect to their input. Designers will normally use the -Output (pin 4) as the ground/return of the load circuit. You can, however, use the +Output (pin 8) as ground/return to effectively reverse the output polarity.

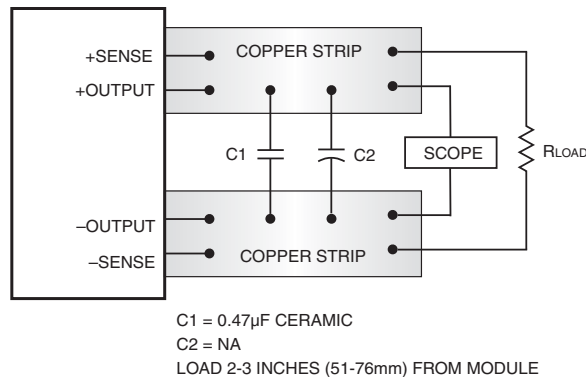

NOTE: 12V MODELS DO NOT INCLUDE SENSE INPUTS

Figure 3. Measuring Output Ripple/Noise (PARD)

Minimum Output Loading Requirements

ULE converters employ a synchronous-rectifier design topology and all models regulate within spec and are stable under no-load to full load conditions. Operation under no-load conditions however might slightly increase the output ripple and noise.

Thermal Shutdown

These ULE converters are equipped with thermal-shutdown circuitry. If environmental conditions cause the internal temperature of the DC/DC converter to rise above the designed operating temperature, a precision temperature sensor will power down the unit. When the internal temperature decreases below the threshold of the temperature sensor, the unit will self start. See Performance/Functional Specifications.

Output Overvoltage Protection

ULE output voltages are monitored for an overvoltage condition via magnetic feedback. The signal is coupled to the primary side and if the output voltage rises to a level which could be damaging to the load, the sensing circuitry will power down the PWM controller causing the output voltages to decrease. Following a time-out period the PWM will restart, causing the output voltages to ramp to their appropriate values. If the fault condition persists, and the output voltages again climb to excessive levels, the overvoltage circuitry will initiate another shutdown cycle. This on/off cycling is referred to as "hiccup" mode.

Contact DATEL for an optional output overvoltage monitor circuit using a comparator which is optically coupled to the primary side thus allowing tighter and more precise control.

Current Limiting

As soon as the output current increases to 10% to 50% above its rated value, the DC/DC converter will go into a current-limiting mode. In this condition, the output voltage will decrease proportionately with increases in output current, thereby maintaining somewhat constant power dissipation. This is commonly referred to as power limiting. Current limit inception is defined as the point at which the full-power output voltage falls below the specified tolerance. See Performance/Functional Specifications. If the load current, being drawn from the converter, is significant enough, the unit will go into a short circuit condition as specified under "Performance."

Short Circuit Condition

When a converter is in current-limit mode, the output voltage will drop as the output current demand increases. If the output voltage drops too low, the magnetically coupled voltage used to develop primary side voltages will also drop, thereby shutting down the PWM controller. Following a time-out period, the PWM will restart causing the output voltages to begin ramping to their appropriate values. If the short-circuit condition persists, another shutdown cycle will be initiated. This on/off cycling is referred to as "hiccup" mode. The hiccup cycling reduces the average output current, thereby preventing internal temperatures from rising to excessive levels. The ULE is capable of enduring an indefinite short circuit output condition.

FEATURES AND OPTIONS

On/Off Control

The input-side, remote On/Off Control function can be ordered to operate with either polarity:

Standard models are equipped with Positive-polarity ("P" part-number suffix) and these devices are enabled when the On/Off Control is left open (or is pulled high, applying +13V to +15V with respect to -Input) as per Figure 4. Positive-polarity devices are disabled when the On/Off Control is pulled low (0 to 0.8V with respect to -Input).

Optional Negative-polarity devices ("N" suffix) are off when the On/Off Control is open (or pulled high, applying +3.5V to +15V), and on when the On/Off Control is pulled low (0 to 0.8V) with respect to -VIN as shown in Figure 5.

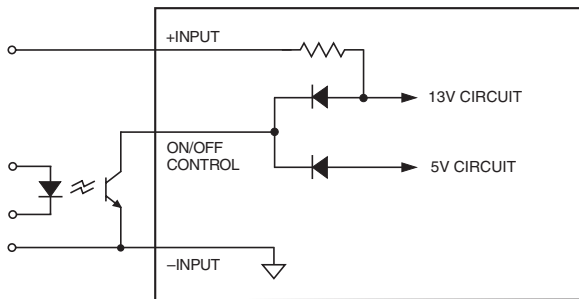

Figure 4. Driving the Positive Polarity On/Off Control Pin

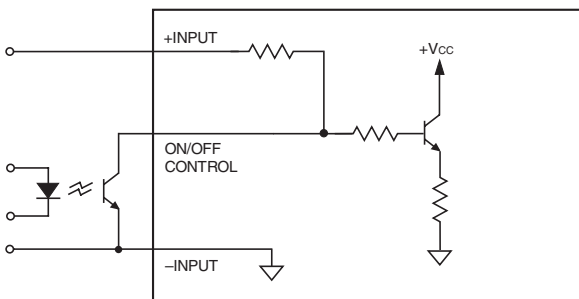

Figure 5. Driving the Negative Polarity On/Off Control Pin

Dynamic control of the remote on/off function is facilitated with a mechanical relay or an open-collector/open-drain drive circuit (optically isolated if appropriate). The drive circuit should be able to sink appropriate current (see Performance Specs) when activated and withstand appropriate voltage when deactivated. Applying an external voltage to the On/Off Control when no input power is applied to the converter can cause permanent damage to the converter.

Trimming Output Voltage

ULE converters have a trim capability that allows users to adjust the output voltages -15% to +10% of V_{OUT}. Adjustments to the output voltages can be accomplished via a trim pot (Figure 6) or a single fixed resistor as shown in Figures 7 and 8. A single fixed resistor can increase or decrease the output voltage depending on its connection. The resistor should be located close to the converter and have a TCR less than 100ppm/°C to minimize sensitivity to changes in temperature. If the trim function is not used, leave the trim pin floating.

A single resistor connected from the Trim to the +Output, or +Sense where applicable, will increase the output voltage in this configuration. A resistor connected from the Trim to the -Output, or -Sense where applicable, will decrease the output voltage in this configuration.

Trim adjustments greater than the specified ±5% can have an adverse affect on the converter's performance and are not recommended. Excessive voltage differences between V_{OUT} and Sense, in conjunction with trim adjustment of the output voltage, can cause the overvoltage protection circuitry to activate (see Performance Specifications for overvoltage limits). Power derating is based on maximum output current and voltage at the converter's output pins. Use of trim and sense functions can cause output voltages to increase, thereby increasing output power beyond the converter's specified rating or cause output voltages to climb into the output overvoltage region. Therefore:

$$(V_{OUT \text{ at pins}}) \times (I_{OUT}) \leq \text{rated output power}$$

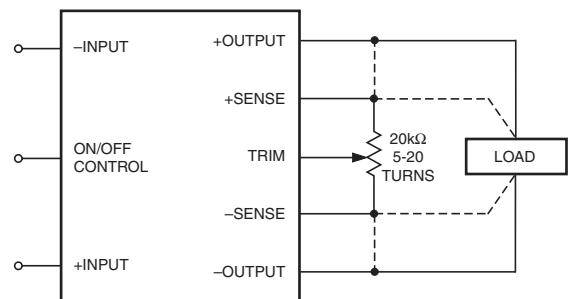
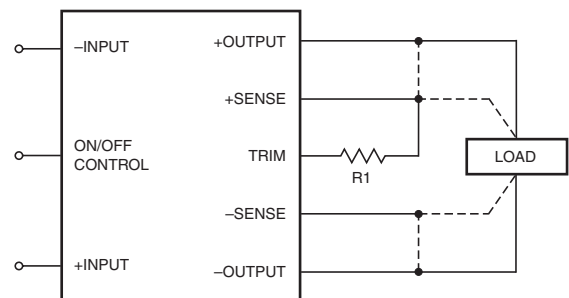
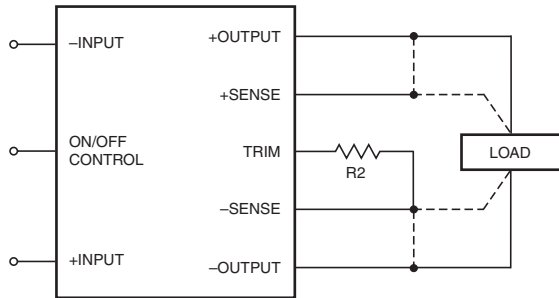

Figure 6. Trim Connections Using A Trimpot



NOTE: 12V MODELS DO NOT INCLUDE SENSE INPUTS

Figure 7. Trim Connections To Increase Output Voltages Using a Fixed Resistor



NOTE: 12V MODELS DO NOT INCLUDE SENSE INPUTS

Figure 8. Trim Connections To Decrease Output Voltages

Trim Equations

Trim Up	Trim Down
1.2 Volt Output	
$R_{T_UP} (k\Omega) = \frac{10.2(V_O - 0.6)}{V_O - 1.2} - 10.2$	$R_{T_DOWN} (k\Omega) = \frac{6.12}{1.2 - V_O} - 10.2$
1.5 Volt Output	
$R_{T_UP} (k\Omega) = \frac{6.23(V_O - 1.226)}{V_O - 1.5} - 10.2$	$R_{T_DOWN} (k\Omega) = \frac{7.64}{1.5 - V_O} - 10.2$
1.8 Volt Output	
$R_{T_UP} (k\Omega) = \frac{7.44(V_O - 1.226)}{V_O - 1.8} - 10.2$	$R_{T_DOWN} (k\Omega) = \frac{9.12}{1.8 - V_O} - 10.2$
2 Volt Output	
$R_{T_UP} (k\Omega) = \frac{8.28(V_O - 1.226)}{V_O - 2} - 10.2$	$R_{T_DOWN} (k\Omega) = \frac{10.15}{2 - V_O} - 10.2$
2.5 Volt Output	
$R_{T_UP} (k\Omega) = \frac{10(V_O - 1.226)}{V_O - 2.5} - 10.2$	$R_{T_DOWN} (k\Omega) = \frac{12.26}{2.5 - V_O} - 10.2$
3.3 Volt Output	
$R_{T_UP} (k\Omega) = \frac{13.3(V_O - 1.226)}{V_O - 3.3} - 10.2$	$R_{T_DOWN} (k\Omega) = \frac{16.31}{3.3 - V_O} - 10.2$
5 Volt Output	
$R_{T_UP} (k\Omega) = \frac{20.4(V_O - 1.226)}{V_O - 5} - 10.2$	$R_{T_DOWN} (k\Omega) = \frac{25.01}{5 - V_O} - 10.2$
12 Volt Output	
$R_{T_UP} (k\Omega) = \frac{49.6(V_O - 1.226)}{V_O - 12} - 10.2$	$R_{T_DOWN} (k\Omega) = \frac{60.45}{12 - V_O} - 10.2$

Note: Resistor values are in kΩ. Adjustment accuracy is subject to resistor tolerances and factory-adjusted output accuracy. V_O = desired output voltage.

Remote Sense Note: The Sense and V_{OUT} lines are internally connected through low value resistors. Nevertheless, if the sense function is not used for remote regulation the user should connect the +Sense to +V_{OUT} and -Sense to -V_{OUT} at the DC/DC converter pins.

ULE series converters have a sense feature to provide point of use regulation, thereby overcoming moderate IR drops in pcb conductors or cabling. The remote sense lines carry very little current and therefore require minimal cross-sectional-area conductors. The sense lines are used by the feedback control-loop to regulate the output. As such, they are not low impedance points and must be treated with care in layouts and cabling. Sense lines on a pcb should be run adjacent to dc signals, preferably ground. In cables and discrete wiring applications, twisted pair or other techniques should be implemented.

ULE series converters will compensate for drops between the output voltage at the DC/DC and the sense voltage at the DC/DC provided that:

$$[V_{OUT(+)} - V_{OUT(-)}] - [Sense(+) - Sense(-)] \leq 5\% V_{OUT}$$

Output overvoltage protection is monitored at the output voltage pin, not the Sense pin. Therefore, excessive voltage differences between V_{OUT} and Sense in conjunction with trim adjustment of the output voltage can cause the overvoltage protection circuitry to activate (see Performance Specifica-

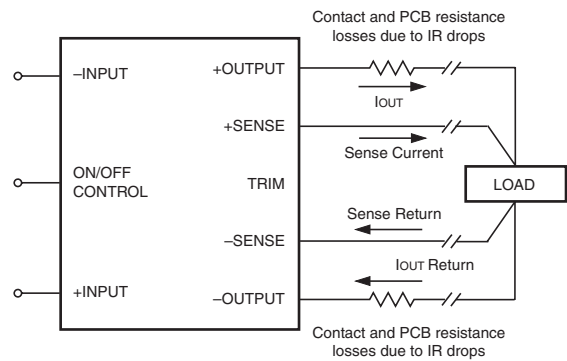

NOTE: 12V MODELS DO NOT INCLUDE SENSE INPUTS

Figure 9. Remote Sense Circuit Configuration

tions for overvoltage limits). Power derating is based on maximum output current and voltage at the converter's output pins. Use of trim and sense functions can cause output voltages to increase thereby increasing output power beyond the ULE's specified rating or cause output voltages to climb into the output overvoltage region. Also, the use of Trim Up and Sense combined may not exceed +10% of V_{OUT}. Therefore, the designer must ensure:

$$(V_{OUT \text{ at pins}}) \times (I_{OUT}) \leq \text{rated output power}$$

Typical Performance Curves

ULE-1.5/20-D48 Maximum Current Temperature Derating
($V_{IN} = 48V$, air flow direction is transverse)

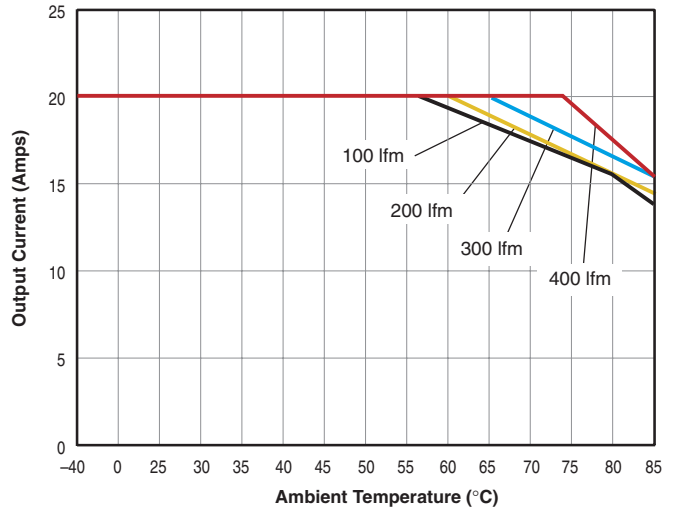

ULE-1.8/20-D48 Efficiency vs. Line Voltage and Load Current @ +25°C

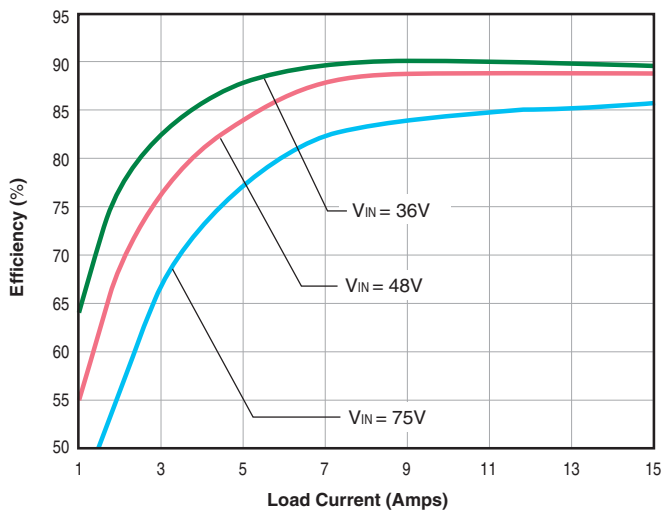

ULE-1.8/20-D48 Maximum Current Temperature Derating
($V_{IN} = 48V$, air flow direction is transverse)

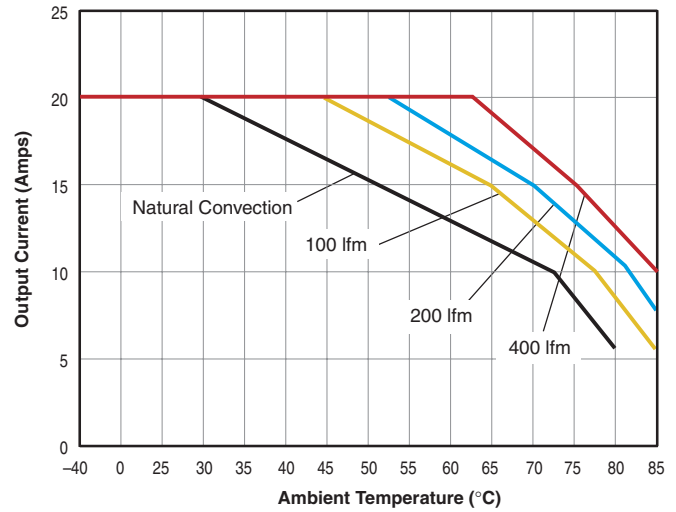

ULE-2.5/20-D48 Efficiency vs. Line Voltage and Load Current @ +25°C

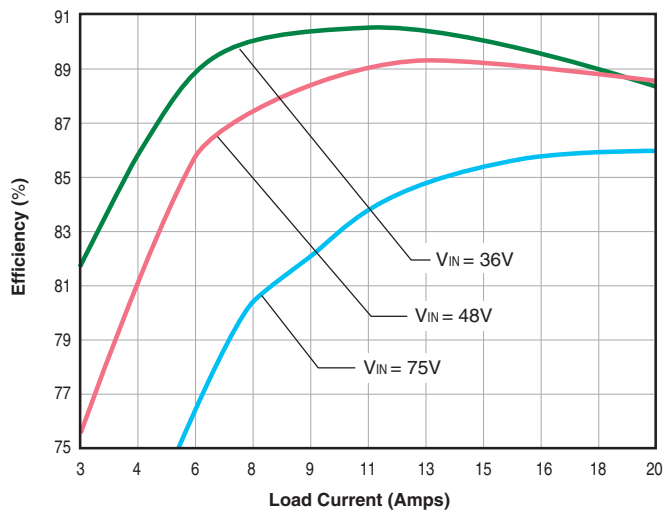

ULE-2.5/20-D48 Maximum Current Temperature Derating
($V_{IN} = 48V$, air flow direction is transverse)

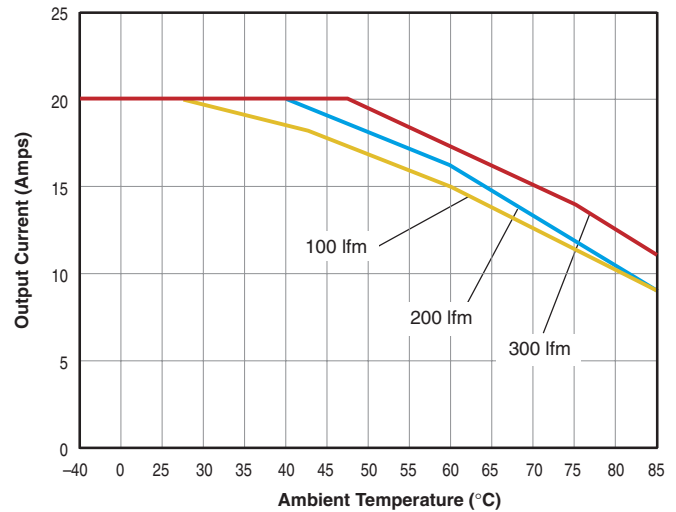

Typical Performance Curves

ULE-3.3/20-D12
Efficiency vs. Line Voltage and Load Current @ +25°C

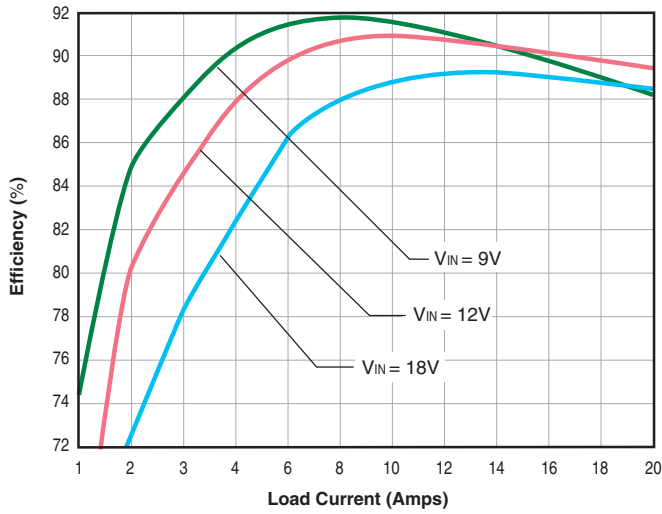

ULE-3.3/20-D12 Maximum Current Temperature Derating
(VIN = 12V, air flow direction is transverse)

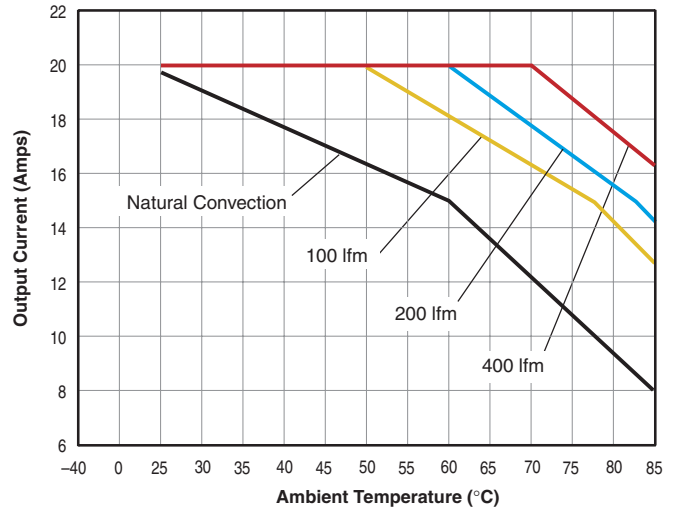

ULE-3.3/20-D24
Efficiency vs. Line Voltage and Load Current @ +25°C

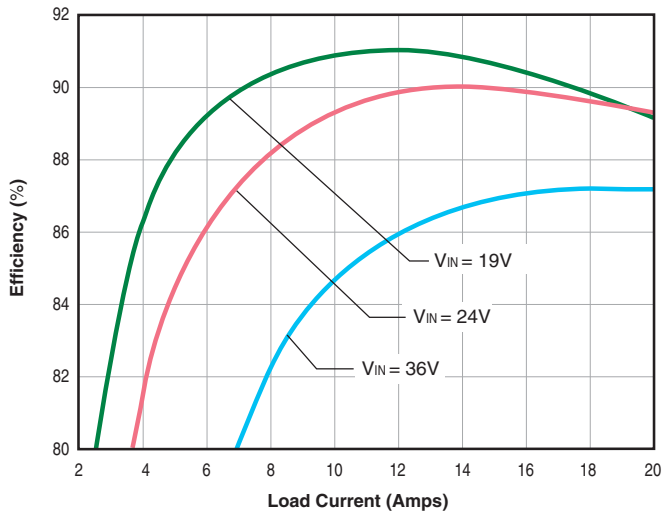

ULE-3.3/20-D24 Maximum Current Temperature Derating
(VIN = 24V, air flow direction is transverse)

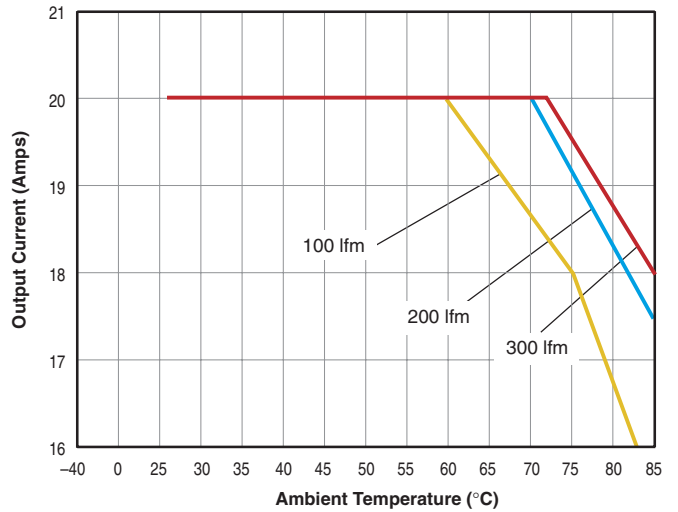

ULE-3.3/20-D48
Efficiency vs. Line Voltage and Load Current @ +25°C

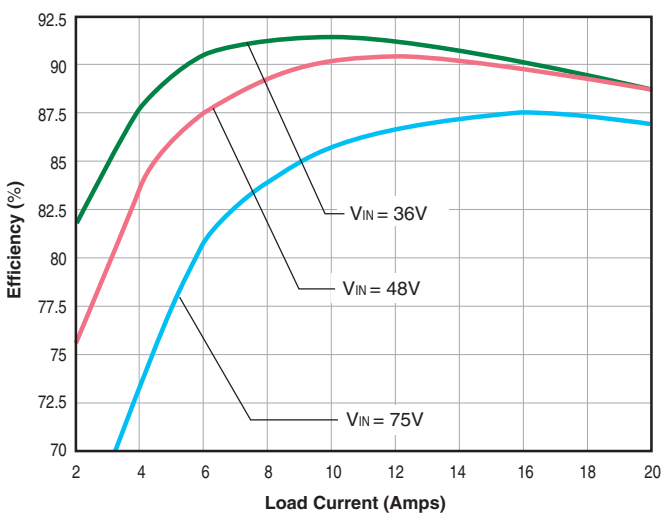

ULE-3.3/20-D48 Maximum Current Temperature Derating
(VIN = 48V, air flow direction is transverse)

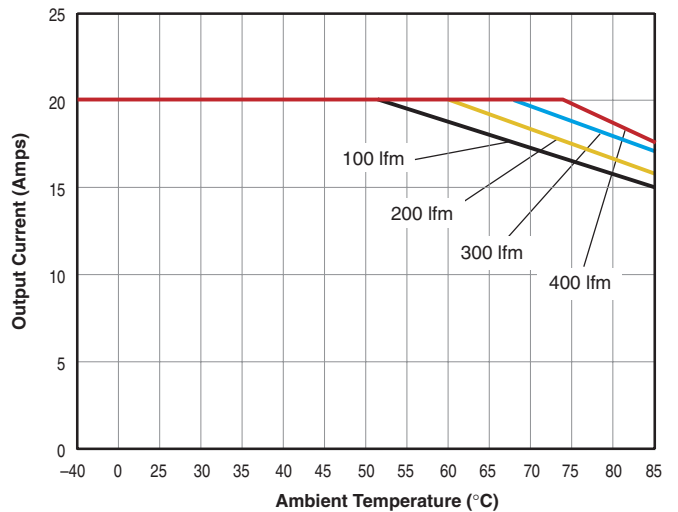

Typical Performance Curves

UHP-28.2/12-D48
Efficiency vs. Line Voltage and Load Current @ +25°C

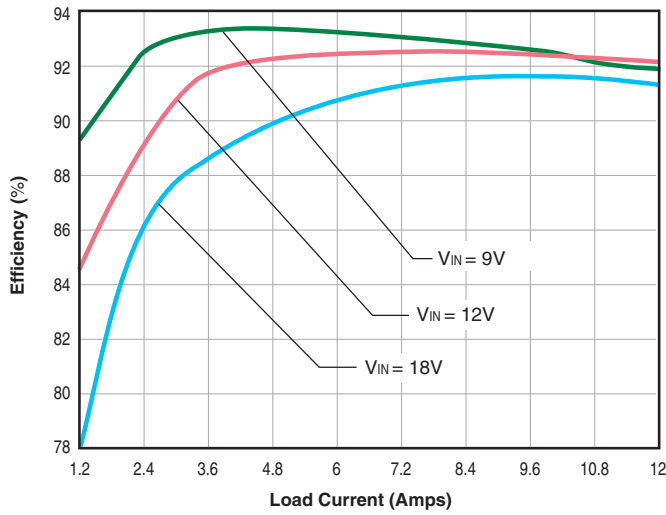

ULE-5/10-D12 Maximum Current Temperature Derating
(VIN = 12V, air flow direction is transverse)

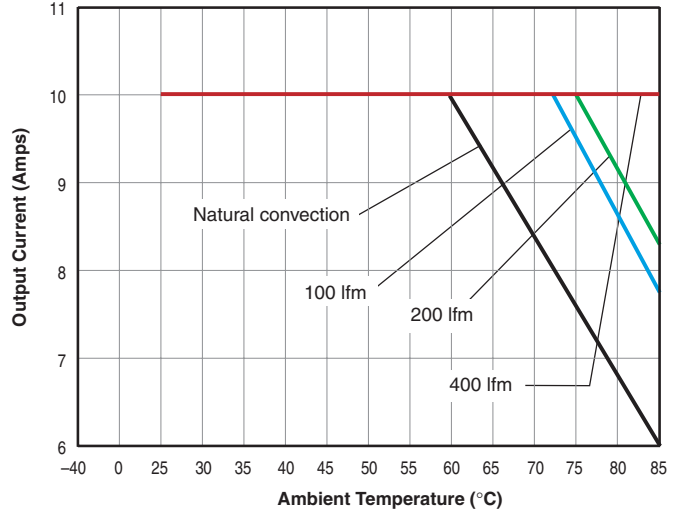

ULE-5/12-D24
Efficiency vs. Line Voltage and Load Current @ +25°C

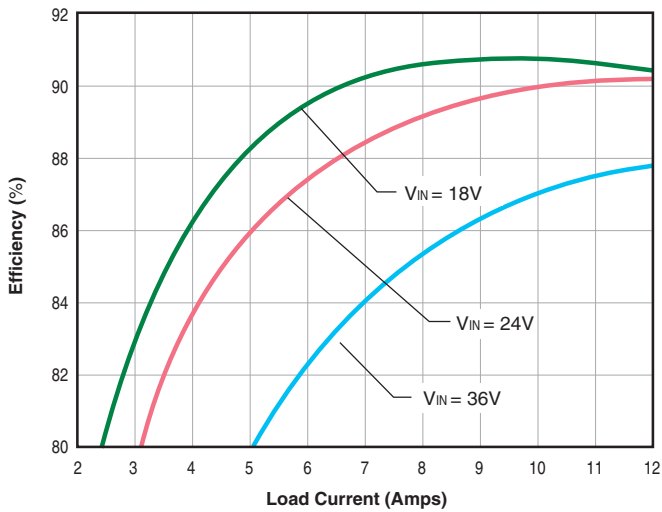

ULE-5/12-D24 Maximum Current Temperature Derating
(VIN = 24V, air flow direction from input to output)

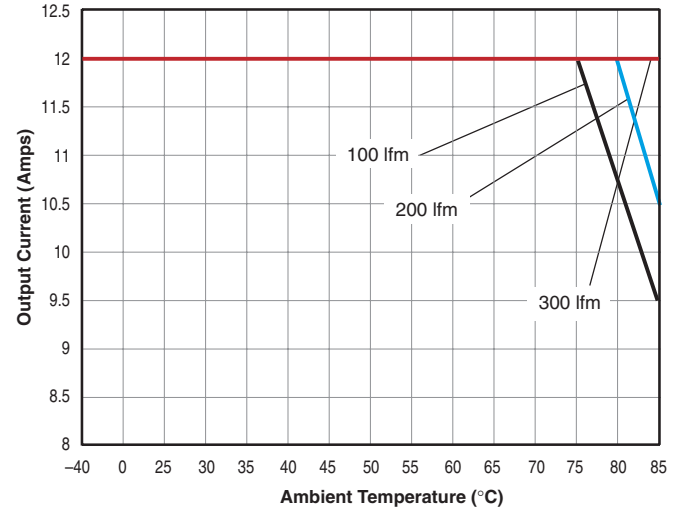

ULE-5/12-D48
Efficiency vs. Line Voltage and Load Current @ +25°C

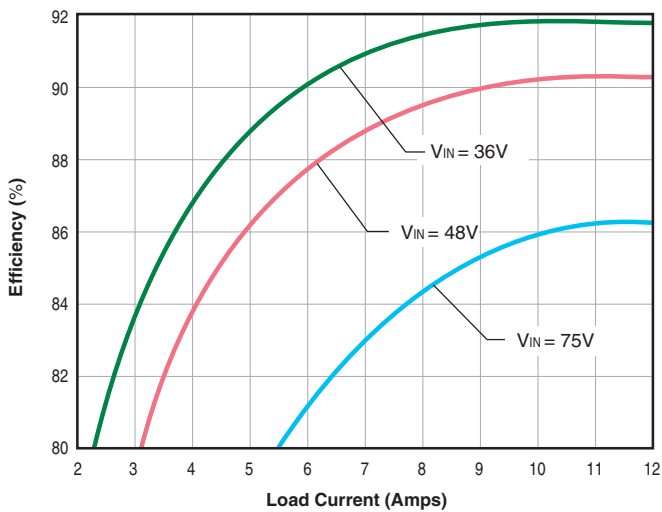

ULE-5/12-D48 Maximum Current Temperature Derating
(VIN = 48V, air flow direction from input to output)

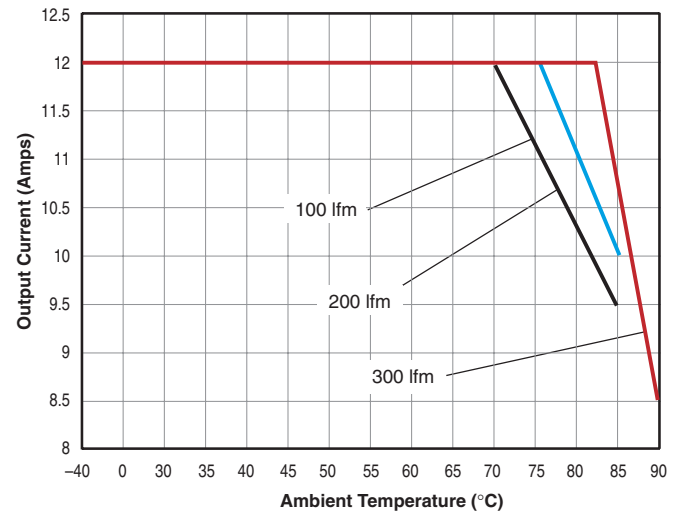

Typical Performance Curves

ULE-12/4.2-D48
Efficiency vs. Line Voltage and Load Current @ +25°C

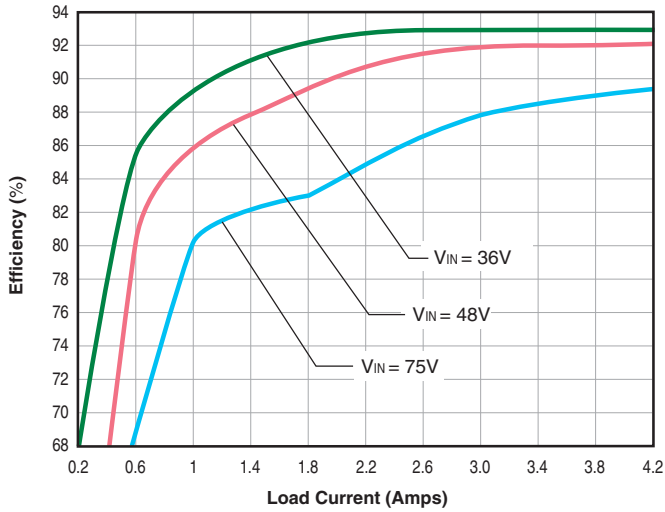

ULE-1.5/20-D48 Power Dissipation vs. Load Current @ +25°C

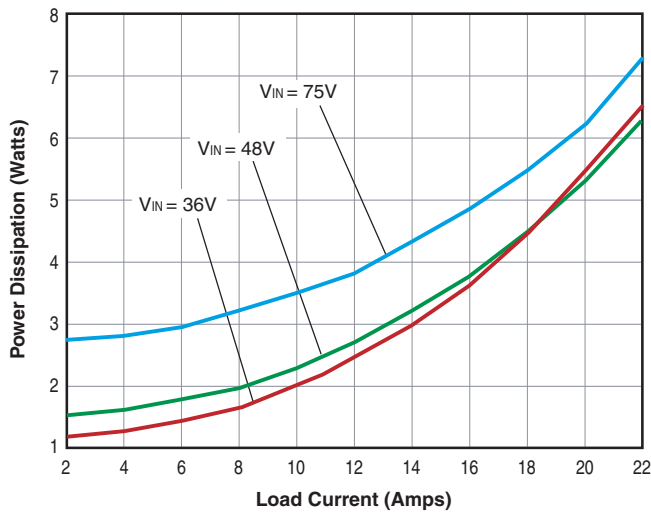

ULE-1.8/20-D48 Power Dissipation vs. Load Current @ +25°C

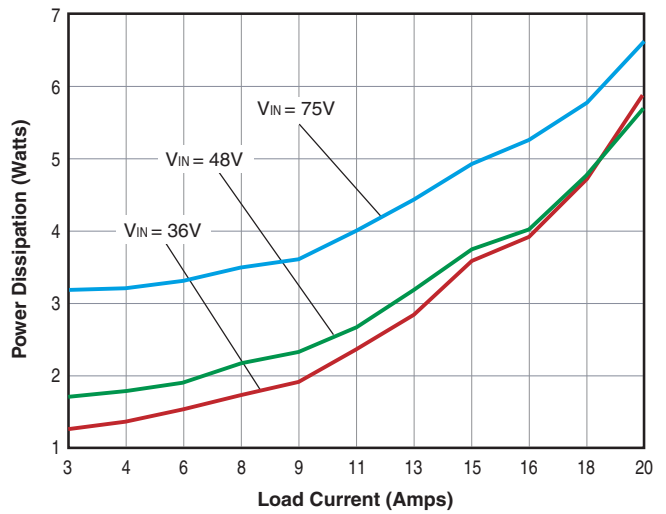

ULE-2.5/20-D48 Power Dissipation vs. Load Current @ +25°C

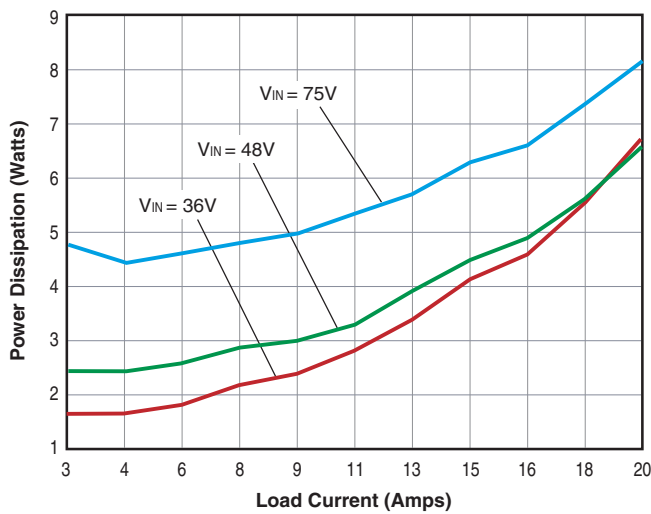

ULE-3.3/20-D24 Power Dissipation vs. Load Current @ +25°C

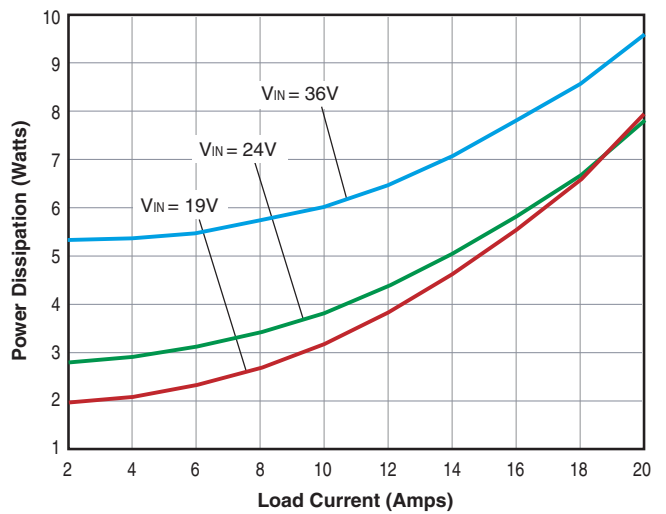

Typical Performance Curves

ULE-3.3/20-D12 Power Dissipation vs. Load Current @ +25°C

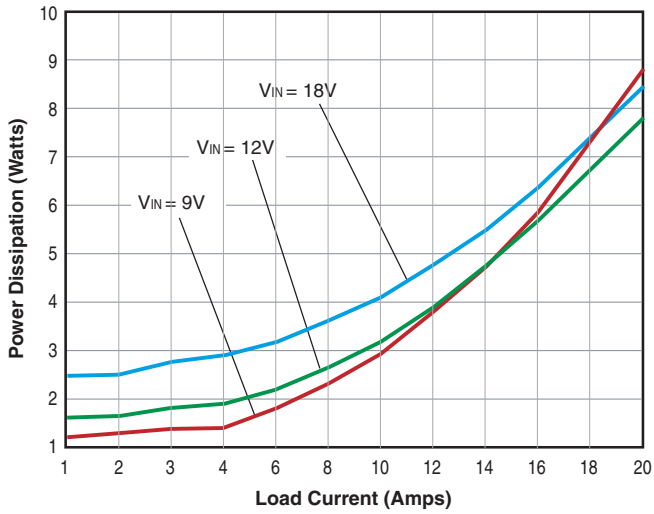

ULE-3.3/20-D48 Power Dissipation vs. Load Current @ +25°C

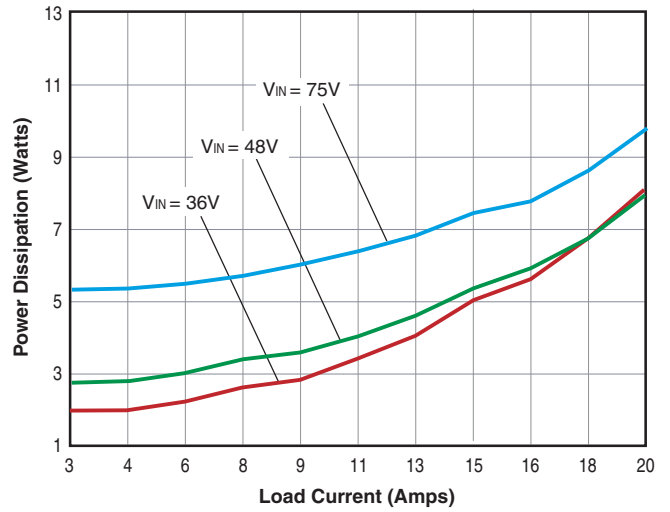

ULE-5/10-D12 Power Dissipation vs. Load Current @ +25°C

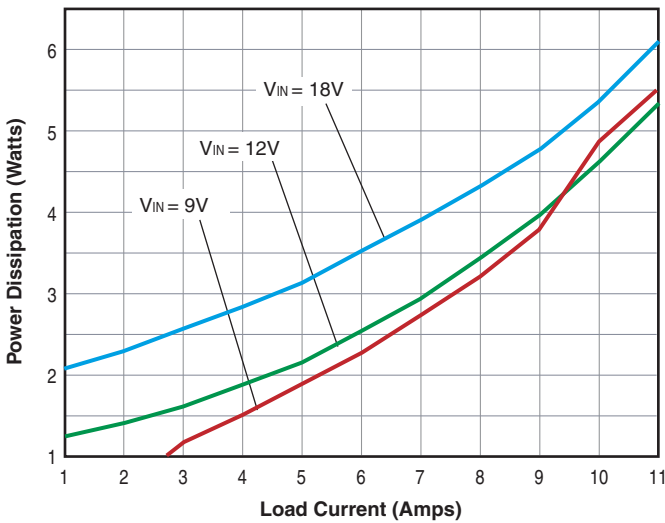

ULE-5/12-D48 Power Dissipation vs. Load Current @ +25°C

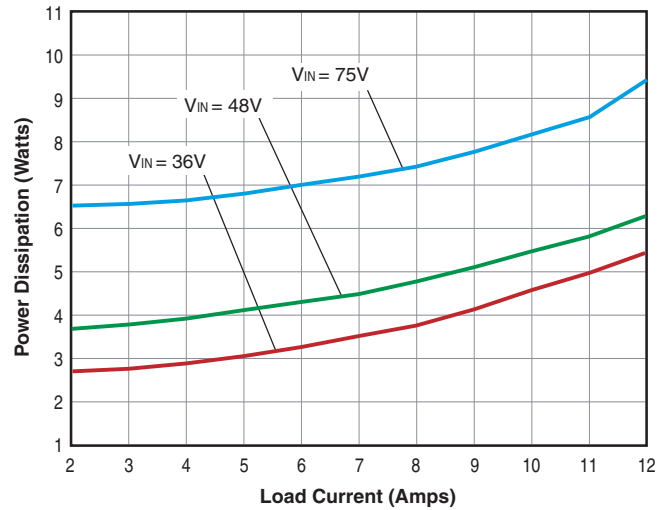

ULE-12/4.2-D48 Power Dissipation vs. Load Current @ +25°C

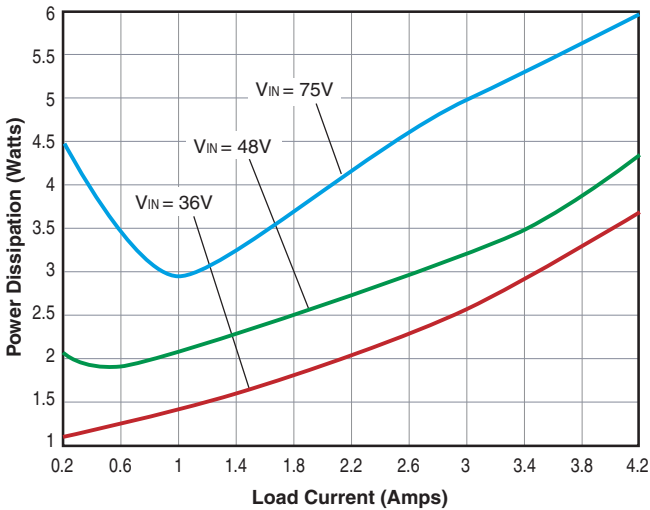

Surface-Mount Package ("M" suffix)

DATEL's ULE series SMT DC/DC converters are the only higher-power DC/DC's that can be automatically "pick-and-placed" using standard vacuum-pickup equipment and subsequently reflowed using high-temperature, lead-free solder.

Virtually all SMT DC/DC's today are unprotected "open-frame" devices assembled by their vendors with high-temperature solder (usually Sn96.5/Ag3.5 with a melting point +221°C) so that you may attach them to your board using low-temperature solder (usually Sn63/Pb37 with a melting point of +183°C). Conceptually straightforward, this "stepped" solder approach has its limitations . . . and is clearly out of step with an industry trending toward the broad use of lead-free solders. Users need to experiment and develop reflow profiles that ensure the components on their DC/DC never exceed 215-216°C. If those components get too hot, "double-reflow" could compromise the reliability of their solder joints. Virtually all these devices demand you "cool down" the Sn63 profile you are likely using today.

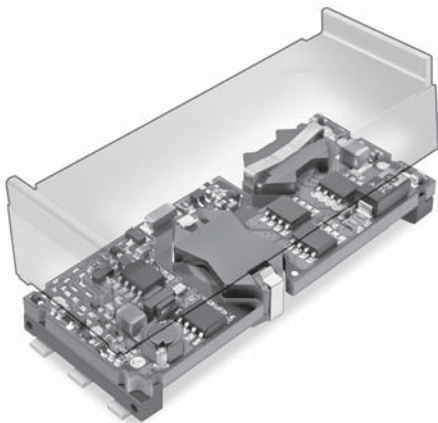

Figure 10. ULE SMT DC/DC With Disposable Heat Shield

DATEL is not exempted from the Laws of Physics. And we do not have magic solders no one else has. We do have a simple and practical, straightforward approach that works. We assemble our SMT DC/DC's on a thermally-stable plastic lead-frame (nylon 46, UL94V-0 flammability rated) using a high temperature lead-free solder. In addition, the ULE is transitioning to RoHS (Reduction of Hazardous Substances) construction and SAC 305 RoHS-approved solder. The lead-frame ensures coplanarity (to within 0.004 in.) of the unit's tin-plated (150 microinches) copper leads and also supports a removable heat shield.

The disposable heat shield, with a cutaway exposing the package leads, provides thermal insulation to internal components during reflow and doubles as the vacuum pick-up location. The insulation properties of the heat shield are so effective that temperature differentials as high as 50°C develop inside-to-outside the shield. Oven temperature profiles with peaks of 250-260°C and dwell times exceeding 2 minutes above 221°C are easily achieved. DATEL's new-generation SMT units are shipped in stackable, JEDEC-style plastic tray.

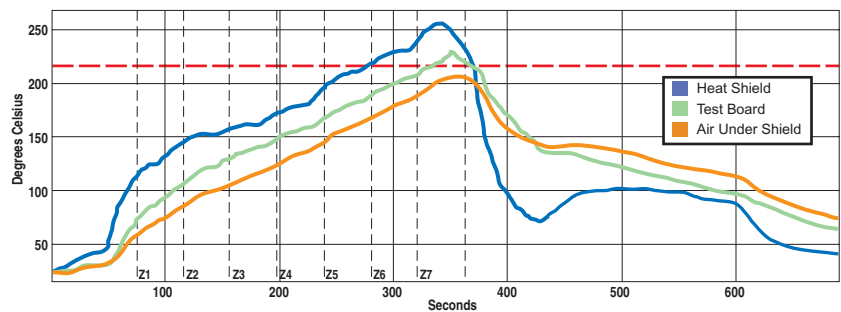

Figure 11. Recommended Solder Profile
(When The Heat-shield Temperature Exceeds +250°C, The Air Within Is 50°C Cooler)

Automated Assembly Production Notes

DATEL's new high-efficiency DC/DC converters are designed for modern surface-mount technology (SMT) automated assembly using screened solder paste, "pick and place" component positioning and forced hot air reflow oven soldering. If you are new to SMT techniques and have a volume application, these features save time, cost and improve manufacturing efficiency. DATEL's DC/DC assembly operations themselves make extensive use of such techniques.

Even if you have previous SMT experience, you should read the sections below on solder reflow profiles and heat shields. This information is not intended to replace the documentation for your SMT system. We assume that you are already experienced with all the components of your SMT system.

This section will discuss several SMT issues, including:

- I/O Mechanical Configuration
- Part Handling and Supply
- Printed Circuit Board (pcb) Mounting
- Soldering using Reflow Technology
- Temperature Profiling
- Heat Shields and Removal

Mechanical Configuration of Input/Output Connections

These new converters are supplied either using traditional through-hole pins or SMT leads. (Note that some models are offered only with lead mounting). The pin options insert into plated-through holes in the host pcb. Be aware that some heat dissipation is carried off by either the pins or leads. The Derating Curves assume that some additional pad area is available on your host pcb to absorb the heat.

The lead option uses either short tabs in "gullwing" style or standoff leads under the converter. The gullwing leads typically are copper alloy with 150 microinches of tin plating. Solder paste (typically 0.008" to 0.009" thick) is applied to the host pcb using a solder mask pressure screening technique and the board is heated and cooled long enough for the solder to reflow and adhere to both the host pads and the converter's mounting leads.

After such mounting, the entire mechanical mounting load is carried by the solder. Obviously the converters must be accurately positioned all during the solder reflow period. Where solder surface tension is sufficient to force tiny components into position, these larger converters may not move and must be accurately positioned by your SMT system.

Part Handling and Supply

SMT eighth- and quarter-brick DC/DC converters (plus installed heat shields if used) are supplied in JEDEC-standard 5.35" by 12.4" waffle trays which are compatible with the feeders on industry-standard pick-and-place machines.

Since the converters are larger and heavier than many other components, make sure your system can reliably remove the units from their trays, move them to the host pcb and accurately position them. The plastic heat shield (see below) doubles as a vacuum pickup area.

Solder Balls

ULE converters are thoroughly inspected according to military standard J-STD-001B for the presence of solder balls. The specification allows small solder balls as long as they are rigidly attached and do not compromise the spacing and clearance requirements needed to maintain electrical isolation.

Post Reflow Procedures

After successful solder reflow, be sure to completely clean and dry your assembled boards using a recommended wash solution and dryer. Failure to remove all flux may cause long term deterioration of on-board conductors and components. And, traces of contaminants which are not removed may reduce isolation voltages or risk a safety hazard. Be aware that low remaining concentrations of flux or other assembly compounds can be very difficult to detect by eye.

Pick and Place pcb Mounting

The main issues here are pad area, orientation, positioning accuracy, vacuum pickup and coplanarity. DATEL recommends that pcb pads to interface with the DC/DC converter should be sized as shown in the diagram below. The pads footprint accommodates the positioning accuracy of your SMT equipment and manufactured tolerances of the DC/DC mounting leads.

Orientation: When loaded into JEDEC trays, the converters are oriented in the same direction. See the diagram below. For the ULE series, a notch is placed on the top of the case (on the removal tabs) to indicate the pin 1 position. You should visually inspect the tray to be sure of this orientation.

Most pick-and-place automatic assembly systems use a camera which must be trained to recognize the orientation of the converter before it is assembled onto the host PC board. This "training" locates and identifies prominent, dimensionally stable landmarks such as the board corners or fiducial marks.

On the bottom of the converter, the ULE series include optical fiducial marks viewable by your SMT imaging system. Observing from the bottom, your SMT imaging camera should find these marks to identify the converter and verify pin 1. On most pick-and-place systems, during head transit, the imaging system will automatically fine tune the end mounting position of the converter using image comparisons from these fiducials or other reference marks you have chosen.

The fiducial marks are placed fairly close together because many imaging systems have a one inch or less observing area since most SMT parts are considerably smaller than these converters. You may prefer to train your imaging system to use a corner of the converter or an I/O lead.

The fiducial marks will remain identical within any date code lot of converters.

In the remote possibility that the fiducials may have changed position with a PC board revision, you should not mix different date lots on any one production assembly session. In addition, to avoid non-recognition or misplacement of the converter, retrain your imaging system at the beginning of each series of assembly sessions. There may be tiny variations in the absolute position from unit to unit.

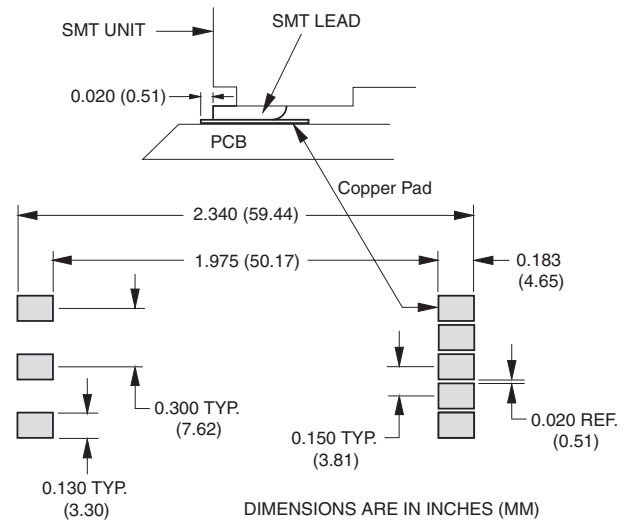

Figure 12. Recommended SMT Mounting Pad Dimensions

If you use a camera above the pcb after placement on the solder paste, do not rely on the inkjet marking on the heat shield to verify proper orientation. Use the pin 1 notch instead.

Coplanarity: DATEL manufactures these converters with very flat mounting leads (see coplanarity specs) however your host pcb must also be flat for a successful mounting. Be aware of possible warping of the pcb under heat gradients and/or humidity conditions. The solder paste will tolerate a small amount of mismatch and will tend to "wet" the entire pad area by capillary action if the temperatures are correct.

Vacuum Pickup: Select the vacuum collet on your SMT placement system for the weight and size of the DC/DC converter. Note that units with heatsinks are slightly heavier. Tests at DATEL have shown that excellent acceleration and transit head speed are available for these converters if the collet size is proper and the vacuum is sufficient. When positioning the vacuum collet, use the geometric center of the heat shield as the pickup area since the center of gravity is very close.

Soldering

Reflow technology works well for small parts. However, larger components such as these DC/DC's with higher thermal mass may require additional reflow time (but not enough to disturb smaller parts also being reflowed concurrently with the DC/DC). When this is combined with higher temperature lead-free solders (or solders with reduced heavy metals), there is increased risk of reheating components inside the DC/DC enough so that they either change positions (and possibly stop functioning) or the components are damaged by the heat.

For these reasons, DATEL developed disposable heat shields using high temperature plastic. The DC/DC is installed and reflowed with the shield in place. After successful reflow and cooling, and before washing, the heat shield should be removed.

Temperature Profiling

We wish to ramp the temperature up and down to successfully reflow the solder without heat damage. Each reflow oven, humidity conditions, solder paste type, oven feed rate, and the number of heat zones all require a different profile. Therefore you may have to experiment.

Since these converters are constructed using high temperature solders, there will be no heat problems on your host pcb using traditional solder with 63% lead and 37% tin with a melting point of +183°C. Device lead temperature must remain below 230°C for less than 75 seconds, assuming that the heat shield is in place. DATEL uses a 216°C melt lead-free tin/silver/copper alloy to assemble these converters.

There are several lead-free solders suitable for your host pcb depending on your SMT system and whatever local certification and environmental regulations you must observe. Contact DATEL if you need specific advice.

Heat Shield

Careful thermocouple testing has shown that the interior of the DC/DC under the heat shield is tens of degrees cooler than the outside ambient temperature for typical reflow profiles. This protects internal components and limits the amount of reflow where it is not desired. The heat shield also includes marking for product identification and a date/lot code.

On ULE models, the heat shield is attached to the converter using molded plastic pins on the heat shield interior which insert into recessed dimples in the pinframe. An extra molded pin on the heat shield at the pin 1 location (and corresponding notch on the pcb) can only be installed one way properly on the pinframe. If the shield accidentally comes loose, it may be reinstalled by aligning the pins and dimples.

To remove the shield from the converter, after successful mounting and cooling, squeeze the heat shield ears inward toward the converter body and pull the shield upwards. Discard or recycle the shield. If you are using a flux wash cycle, remove the heat shield before washing to avoid coming loose inside the washer..

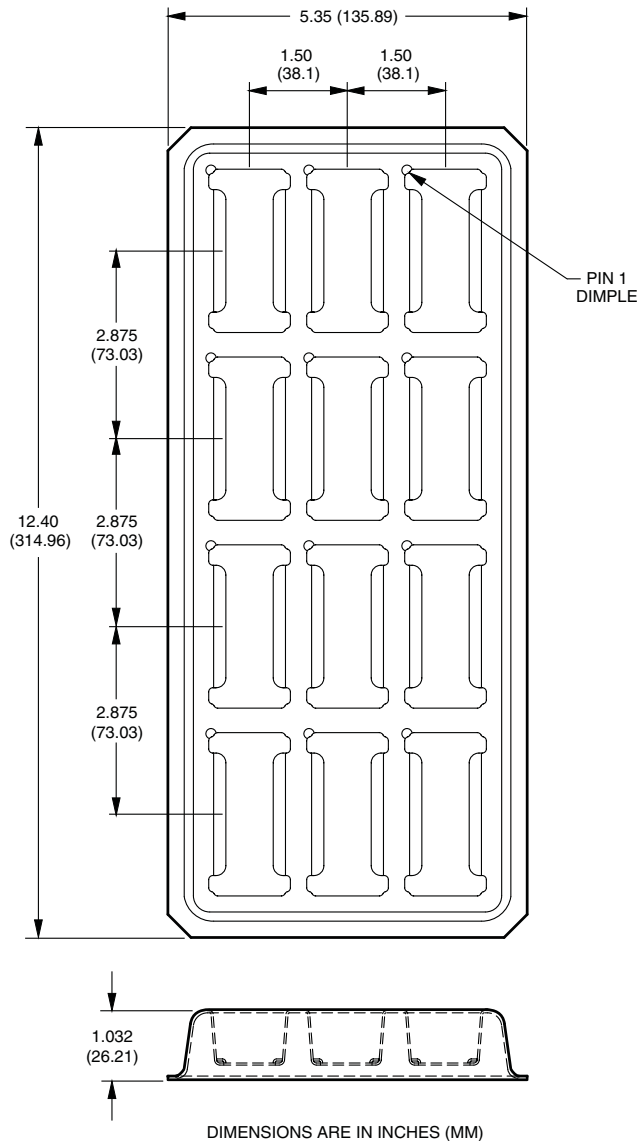

Figure 13. Shipping Tray



C&D Technologies (DATEL), Inc.
 11 Cabot Boulevard, Mansfield, MA 02048-1151 U.S.A.
 Tel: (508) 339-3000 (800) 233-2765 Fax: (508) 339-6356
www.cd4power.com Email: **sales@cdtechno.com**
ISO 9001 REGISTERED

DS-0515A 04/19/06

C&D Technologies (NCL), Ltd. Milton Keynes, United Kingdom, Tel: 44 (0) 1908 615232
 Internet: www.cd4power.com E-mail: ped.ltd@cdtechno.com

C&D Technologies (DATEL) S.A.R.L. Montigny Le Bretonneux, France Tel: 01-34-60-01-01
 Internet: www.cd4power.com E-mail: ped.sarl@cdtechno.com

C&D Technologies (DATEL) GmbH München, Germany Tel: 89-544334-0
 Internet: www.cd4power.com E-mail: ped.gmbh@cdtechno.com

C&D Technologies KK Tokyo, Japan Tel: 3-3779-1031, Osaka Tel: 6-6354-2025
 Int.: www.cd4power.jp Email: sales_tokyo@cdtechno.com, sales_osaka@cdtechno.com

China Shanghai, People's Republic of China Tel: 86-50273678
 Internet: www.cd4power.com E-mail: shanghai@cdtechno.com

C&D Technologies (DATEL), Inc. makes no representation that the use of its products in the circuits described herein, or the use of other technical information contained herein, will not infringe upon existing or future patent rights. The descriptions contained herein do not imply the granting of licenses to make, use, or sell equipment constructed in accordance therewith. Specifications are subject to change without notice. The DATEL logo is a registered trademark of C&D Technologies, Inc..