

Planning Guide 05/2003 Edition

simodrive

AC Servomotors  
1FT5  
SIMODRIVE 611

**SIEMENS**



# SIEMENS

## SIMODRIVE 611

### AC Servomotors 1FT5

#### Planning Guide

**Motor Description** **1**

**Technical Data and  
Characteristics** **2**

**Motor Components  
(Options)** **3**

**Dimension Drawings** **4**

**References**

**Index**

# SIMODRIVE® Documentation

## Printing history

Brief details of this edition and previous editions are listed below.

The status of each edition is shown by the code in the "Remarks" column.

*Status code in the "Remarks" column:*

- A . . . . . New documentation
- B . . . . . Unrevised reprint with new Order No.
- C . . . . . Revised edition with new status

If factual changes have been made on the page since the last edition, this is indicated by a new edition coding in the header on that page.

Edition	Order No. for 1FK6	Remark
05.03	6SN1197-0AD01-0BP0	A

This Manual is included in the documentation available on CD-ROM (**DOCONCD**)

Edition	Order No.	Remark
09.03	6FC5 298-7CA00-0BG3	C

## Trademarks

SIMATIC®, SIMATIC HMI®, SIMATIC NET®, SIROTEC®, SINUMERIK®, SIMODRIVE®, MASTERDRIVES® and MOTION-CONNECT® are registered trademarks of Siemens AG. Other names in this publication might be trademarks whose use by a third party for his own purposes may violate the rights of the registered holder.

For more information refer to the Internet under:  
<http://www.ad.siemens.de/sinumerik>

This publication was produced with Interleaf V 7

The reproduction, transmission or use of this document or its contents is not permitted without express written authority. Offenders will be liable for damages. All rights, including rights created by patent grant or registration of a utility model or design, are reserved.

© Siemens AG 2003. All rights reserved.

Other functions not described in this documentation might be executable in the control. This does not, however, represent an obligation to supply such functions with a new control or when servicing.

We have checked that the contents of this document correspond to the hardware and software described. Nonetheless, differences might exist and therefore we cannot guarantee that they are completely identical. The information contained in this document is reviewed regularly and any necessary changes will be included in the next edition. We welcome suggestions for improvement.

Subject to change without prior notice.

# Foreword

## Information on SIMODRIVE documentation

This document is part of the Technical Customer Documentation which has been developed for the SIMODRIVE system. All of the documents are available individually. You can obtain the complete list of documentation encompassing all Advertising Brochures, Catalogs, Overviews, Short Descriptions, Operating Instructions and Technical Descriptions with Order No., ordering address and price from your local Siemens office.

For reasons of transparency, this document does not include detailed information about all of the product types. Further, it cannot take into account every conceivable installation, operation or service/maintenance situation.

We would also like to point-out that the contents of this document are neither part of nor modify any prior or existing agreement, commitment or contractual relationship. The sales contract contains the entire obligation of Siemens. The warranty contained in the contract between the parties is the sole warranty of Siemens. Any statements contained herein neither create new warranties nor modify the existing warranty.

## Structure of the documentation for 1FK and 1FT motors

The complete Planning Guide for 1FK and 1FT motors can be ordered as hard copy.

Table Foreword-1 Planning Guide with General Section and 1FK and 1FT motors

Title	Order No. (MLFB)	Language
1FK and 1FT AC Servomotors	6SN1197-0AC20-0AP0	German
1FK and 1FT AC Servomotors	6SN1197-0AC20-0BP0	English

The General Section and the individual motor series are also available separately.

Table Foreword-2 Planning Guide, individual sections

Title	Order No. (MLFB)	Language
AC Servomotors, General Section	6SN1197-0AD07-0AP0	German
AC Servomotors, 1FK7 Motor Section	6SN1197-0AD06-0AP0	German
AC Servomotors, 1FK6 Motor Section	6SN1197-0AD05-0AP0	German
AC Servomotors, 1FT6 Motor Section	6SN1197-0AD02-0AP0	German
AC Servomotors, 1FT5 Motor Section	6SN1197-0AD01-0AP0	German

## Hotline

If you have any questions, please contact the following Hotline:

A&D Technical Support Tel.: +49 (180) 5050–222  
Fax: +49 (180) 5050–223  
eMail: [adsupport@siemens.com](mailto:adsupport@siemens.com)

If you have any questions regarding the documentation (suggestions, corrections) then please send a fax to the following number:

+49 (9131) 98–2176

Fax form: Refer to the feedback sheet at the end of the document

## Definition of qualified personnel

For the purpose of this document and warning information on the product itself, "Qualified personnel" are those who are familiar with the installation, mounting, start-up and operation of the equipment and are appropriately qualified and trained for the function which they perform.

- Trained and authorized to energize/de-energize, circuits and equipment in accordance with established safety procedures.
- Trained in the proper care and use of protective equipment in accordance with established safety procedures.
- Trained in rendering first aid.

## Explanation of the symbols

The following danger and warning concept is used in this document:



---

### Danger

This symbol is always used if death, severe personal injury or substantial material damage **will** result if proper precautions are not taken.

---



---

### Warning

This symbol is always used if death, severe personal injury or substantial material damage **can** result if proper precautions are not taken.

---



---

### Caution

This symbol is always used if minor personal injury or material damage **can** result if proper precautions are not taken.

---

---

### Caution

The warning note (without a warning triangle) means that material damage **can** occur if proper precautions are not taken.

---

---

### Notice

This warning note indicates that an undesirable result or an undesirable status **can** occur if the appropriate information is not observed.

---

---

### Note

In the sense of this document there is a possible advantage/benefit if the note text is observed.

---

## Danger and warning information

---



### Danger

- It is not permissible to commission the equipment until it has been clearly identified that the machine, in which the described components are to be installed, is in full compliance with the specifications in Directive 98/37/EC.
  - Only appropriately qualified personnel may commission SIMODRIVE units and AC motors.
  - This personnel must take into account the technical customer documentation belonging to the product and be knowledgeable and observe the specified information and instructions on the hazard and warning labels.
  - When electrical equipment and motors are operated, the associated electrical circuits are at hazardous voltage levels.
  - When the machine or system is operated, hazardous axis movements can occur.
  - All of the work carried-out in the electrical machine or system must be carried-out with it in a no-voltage condition.
  - SIMODRIVE drive units are designed for operation on low-ohmic, grounded line supplies (TN line supplies).
- 



### Warning

- The successful and safe operation of this equipment and motors is dependent on proper transport, storage, installation and mounting as well as careful operator control, service and maintenance.
  - For special versions of the drive units and motors, information and data in the catalogs and quotations additionally apply.
  - In addition to the information and instructions on hazards and warnings in the technical customer documentation supplied, the applicable national, local and machine/system-specific regulations and requirements must be carefully taken into consideration.
- 



### Caution

- The motors can have surface temperatures of over +80° C.
  - This is the reason that it is not permissible that temperature-sensitive parts and components – e.g. cables or electrical components – are in contact with the motor or fastened to the motor.
  - When connecting and routing connecting cables, the following must be carefully observed:
    - they may not be damaged
    - they may not be strained, and
    - they may not be able to be touched by rotating components.
-



**Caution**

- SIMODRIVE drive units with AC motors are subject to a voltage test, in compliance with EN 50178 as part of a routine test. While the electrical equipment of industrial machines is being subject to a voltage test in compliance with EN 60204-1, Section 19.4, all of the SIMODRIVE equipment connections must be disconnected/withdrawn in order to avoid damaging the SIMODRIVE equipment.
  - Motors should be connected-up according to the circuit diagram supplied. It is not permissible to directly connect the motors to the three-phase line supply. Motors will be destroyed if they are connected directly to the three-phase line supply.
- 

**Note**

- SIMODRIVE equipment with AC motors fulfill, in the operational state and in dry operating areas, the Low-Voltage Directive 73/23/EEC.
  - SIMODRIVE equipment with AC motors fulfill, in the configurations which are specified in the associated EC Declaration of Conformity, the EMC Directive 89/336/EEC.
-

## ESDS information and instructions

---



### Caution

**ElectroStatic Discharge Sensitive devices (ESDS)** are individual components, integrated circuits or boards which can be damaged by electrostatic fields or electrostatic discharge.

Handling ESDS boards:

- The human body, working area and packaging should be well grounded when handling ESDS components!
  - Electronic components may only be touched by people in ESDS areas with conductive flooring if
    - they are grounded through an ESDS wrist strap
    - they are wearing ESDS shoes or ESDS shoe grounding strips.
  - Electronic boards should only be touched when absolutely necessary.
  - Electronic boards may not come into contact with synthetic materials and clothing manufactured out of man-made fibers.
  - Electronic boards may only be placed down on conductive surfaces (table with ESDS surface, conductive ESDS foam rubber, ESDS packing bag, ESDS transport containers).
  - Electronic boards may not be brought close to data terminals, monitors or television sets (minimum clearance to screen > 10 cm).
  - Measuring work may only be carried out on the electronic boards if
    - the measuring device is grounded (e.g. via the protective conductor) or
    - for floating measuring equipment, the probe is briefly discharged before making measurements (e.g. a bare control housing is touched).
-

# Table of Contents 1FT5

<b>1</b>	<b>Motor Description</b> .....	<b>1FT5/1-13</b>
1.1	Features and technical data .....	1FT5/1-13
1.2	Order designation .....	1FT5/1-14
1.2.1	Order designation, standard types .....	1FT5/1-14
1.2.2	Order designation, core types .....	1FT5/1-16
1.3	Technical version, 1FT5 motors .....	1FT5/1-18
1.4	Functions and expanded functions .....	1FT5/1-23
1.5	Cooling .....	1FT5/1-29
1.6	Electrical connections .....	1FT5/1-31
1.7	Drive-out coupling .....	1FT5/1-33
<b>2</b>	<b>Technical Data and Characteristics</b> .....	<b>1FT5/2-35</b>
2.1	Speed-torque diagrams .....	1FT5/2-35
2.1.1	Standard motors .....	1FT5/2-36
2.1.2	Short motors .....	1FT5/2-64
2.2	Cantilever force diagrams .....	1FT5/2-70
2.2.1	Standard motors .....	1FT5/2-71
2.2.2	Short motors .....	1FT5/2-74
2.3	Axial forces .....	1FT5/2-75
<b>3</b>	<b>Motor Components (Options)</b> .....	<b>1FT5/3-77</b>
3.1	Thermal motor protection .....	1FT5/3-77
3.2	Encoders .....	1FT5/3-79
3.2.1	Tachogenerator system .....	1FT5/3-80
3.2.2	ROD 320.005 incremental encoders .....	1FT5/3-81
3.2.3	ROD 426 incremental encoder .....	1FT5/3-83
3.2.4	Mounting encoders with synchronous flange .....	1FT5/3-86
3.3	Holding brake .....	1FT5/3-87
3.4	Working brake (option C00) .....	1FT5/3-88
3.5	Gearbox .....	1FT5/3-89
3.5.1	1-stage planetary gearbox .....	1FT5/3-89
3.5.2	2-stage planetary gearbox .....	1FT5/3-91
<b>4</b>	<b>Dimension Drawings</b> .....	<b>1FT5/4-95</b>
<b>5</b>	<b>References</b> .....	<b>1FT5/A-121</b>
<b>6</b>	<b>Index</b> .....	<b>Index-125</b>





# Motor Description

## 1.1 Features and technical data

### Applications

The 1FT5 series has been developed for use on different types of machine tools.

In conjunction with the SIMODRIVE 611 analog drive converter system, the motors are admirably suited for

- Feed drives for lathes and milling machines
- Machining centers
- Grinding and special-purpose machines
- Robots and handling equipment
- Woodworking

The 1FT5 series can be directly mounted onto feed spindles and onto gearboxes with toothed wheels or toothed belts.

### Features

Depending on the shaft height, the 1FT5 series has stall torques from 0.9 up to 185 Nm at rated speeds from 1200 to 6000 RPM. The motors have a high overload capacity over the complete speed control range.

### Standards, Regulations

The appropriate Standards, Regulations are directly assigned to the functional requirements.

## 1.2 Order designation

## 1.2 Order designation

## Structure of the order designation

The order designation comprises a combination of digits and letters. It is subdivided into four hyphenated blocks.

The first block has seven positions and designates the machine type. Additional features are coded in the second block. The third and fourth blocks are provided for additional data.

## 1.2.1 Order designation, standard types

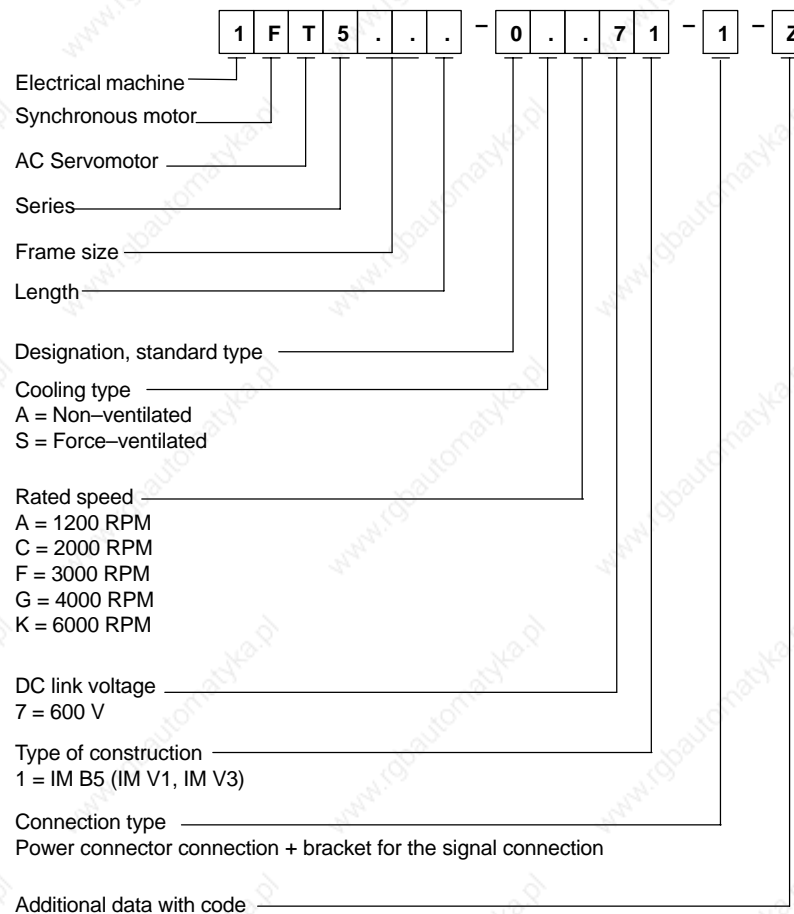

## Supplementary data for standard types and options

Plain text data	Brief designation
Degree of protection IP 67 (not for force-ventilated motors) <sup>7)</sup> IP 68 (not for force-ventilated motors) <sup>7)</sup>	<b>K93</b> <b>M24</b>
Second rating plate (this is standard for core types)	<b>K31</b>
Connector outlet direction <sup>1)</sup> Cable entry from the drive end	<b>K83</b> <sup>4) 7) 11)</sup>
Cable entry from the non-drive end	<b>K84</b> <sup>4) 7)</sup>
rotated through 180° (with respect to the Standard)	<b>K85</b> <sup>7)</sup>
Radial shaft sealing acc. to DIN 3760	<b>K18</b>
Shaft end: Smooth shaft	<b>K42</b>
Vibration severity (ISO 2373) Severity R (reduced) 600 to 1800 RPM ≤ 0.71 mm/s >1800 to 3600 RPM ≤ 1.12 mm/s	<b>K01</b>
Shaft and flange precision, tolerance R acc. to DIN 42955	<b>K04</b>
Motor with mounted pulse encoder <sup>9)</sup> 5000 pulses/revolutions <sup>7)</sup> 2500 pulses/revolutions <sup>7)</sup> 2000 pulses/revolutions <sup>7)</sup> 1000 pulses/revolutions <sup>7)</sup>	<b>H28</b> <b>H27</b> <b>H26</b> <b>H22</b>
The motor is prepared for mounting an encoder (incremental or absolute) with synchronous flange <sup>2) 7) 11)</sup>	<b>G51</b>
Motor with mounted ROD 320 pulse encoder <sup>3) 6)</sup> 5000 pulses/revolutions <sup>7)</sup> 2500 pulses/revolutions <sup>7)</sup> 2000 pulses/revolutions <sup>7)</sup> 1250 pulses/revolutions <sup>7)</sup>	<b>H04</b> <b>G44</b> <b>G42</b> <b>H01</b>
Holding brake (integrated) <sup>8)</sup>	<b>G45</b>
Motor with mounted planetary gear <sup>10) 11)</sup>	<b>V□□</b>
Working brake; mounted <sup>4) 11)</sup>	<b>C00</b>
Prepared with a retrofit kit for mounting an encoder (G51) with mounting instructions <sup>5)</sup>	EWN: 519.4033804: 1FT5034 to 1FT5036 519.4033803: 1FT5042 to 1FT5046 519.4033801: 1FT5062 to 1FT5066 519.4033802: 1FT5072 to 1FT5108

- 1) Standard version corresponding to the dimension drawings
- 2) For 1FT503□, 1FT504□ absolute value encoder mounting, only on request; not for force-ventilated motors
- 3) For 1FT503□, 1FT504□ not possible; not for force-ventilated motors
- 4) For 1FT503□, 1FT504□ and 1FT506□ not possible
- 5) Only available ex-stock up to 2 motors per motor version
- 6) Limiting frequency: 300 kHz; motors may only be designed for a winding temperature rise  $\Delta T=60$  K. Cannot be combined with an axial connector outlet at the non-drive end.
- 7) Options mutually exclude one another
- 8) For motors with brake, axial forces are not permissible in operation
- 9) Pulse encoder with axial cable outlet
- 10) Only vibration severity stage N can be guaranteed for the motor and gearbox unit
- 11) Not possible for short motors

1.2 Order designation

1.2.2 Order designation, core types

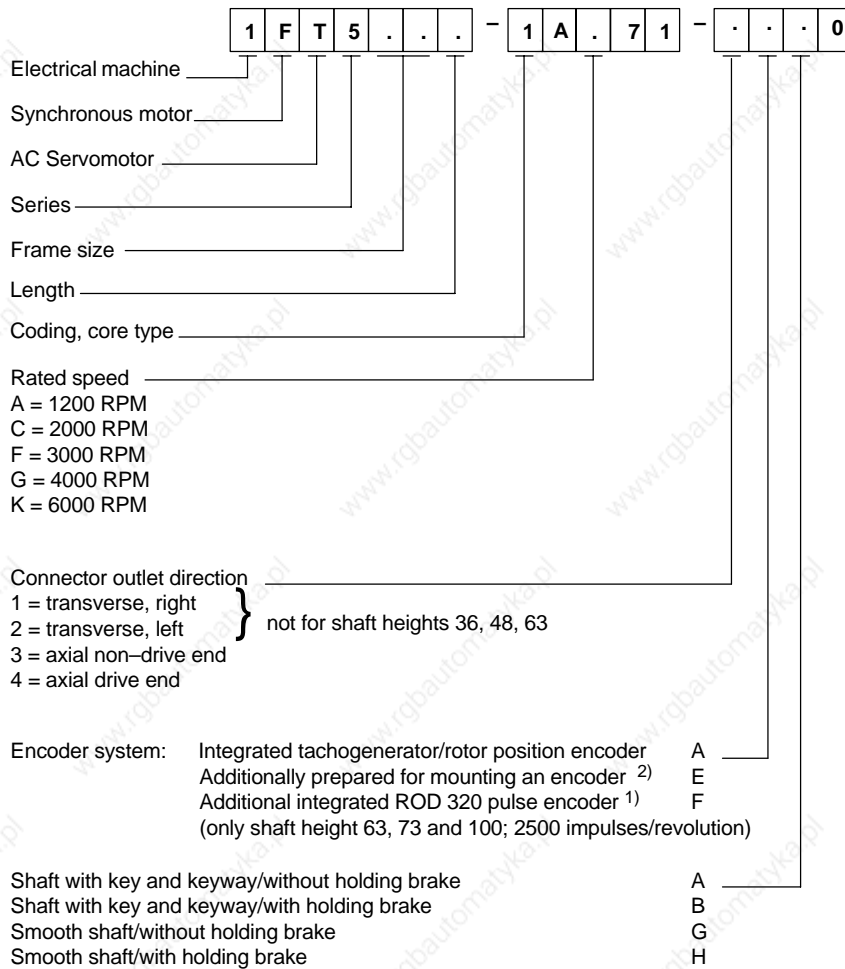



**Ordering example**

When ordering a 1FT5 AC servomotor with options, it is necessary to specify the ordering code "-Z" and in addition the short designation. For core types, the last ordering block is appropriately supplemented.

**The following is required:**

An AC servomotor

- To connect to a SIMODRIVE 611 drive converter with a 600 V DC link voltage
- Rated voltage, 3000 RPM
- Stall torque, 33 Nm at  $\Delta T = 100$  K
- Type of construction: IM B5 (IM V1, IM V3)
- Connection type: Power connectors for motors/brake, signal connector for the encoder system
- With integrated holding brake
- With mounted ROD 426 pulse encoder (1000 pulses/revolution)

**The following should be ordered:**

1FT5 AC servomotor  
 $n_N = 3000$  RPM,  
 $M_0 = 33$  Nm at  $\Delta T = 100$  K

Special version:

- Integrated holding brake
- Mounted ROD 426 pulse encoder

**Order No.:**

**1FT5102-0AF71-1-Z**

Codes

**G45**

**H22**

**Order No., core type:**

**1FT5102-1AF71-1EB0**

(the same motor but only prepared for mounting an encoder)

## 1.3 Technical version, 1FT5 motors

**1.3 Technical version, 1FT5 motors**

Table 1-1 Features of 1FT5 standard motors

Technical features	Version
Motor type	Permanent-magnet synchronous AC servomotor
Type of construction (acc. to EN 60034-7; IEC 60034-7)	IM B5 (IM V1, IM V3); option, refer to Table 1-2
Degree of protection (acc. to EN 60034-5; IEC 60034-5)	IP 64, option, refer to Table 1-2
Cooling (acc. to EN 60034-6; IEC 60034-6)	Non-ventilated; options, refer to Table 1-2
Thermal motor protection (acc. to IEC and EN 60034-11)	PTC in the stator winding
Shaft end (acc. to DIN 748-3; IEC 60072-1)	Cylindrical; with keyway and with key; tolerance zone k6; Option, refer to Table 1-2
Rating plate	A second rating plate is provided for core types
Radial eccentricity, concentricity and axial eccentricity (acc. to DIN 42955; IEC 60072-1)	Tolerance N (normal); options, refer to Table 1-2
Vibration severity (acc. to EN 60034-14; IEC 60034-14)	Stage N (normal); options, refer to Table 1-2
Balancing (acc. to IEC and EN 60034-14)	Full-key balancing
Bearings	Deep-groove ball bearings with (permanent lubrication) bearing lifetime > 20000 h Locating bearing on the drive end
Stator winding insulation (acc. to EN 60034-1; IEC 60034-1)	Temperature rise class F for a winding temperature rise of $\Delta T = 100$ K for an ambient temperature of 40 °C. For ambient temperatures > 40 °C, the power must be reduced (de-rated) (refer to the documentation "General Section").
Installation altitude (acc. to IEC and EN 60034-1)	$\leq 1000$ m above sea level, otherwise power de-rating (VDE0530) 2000 m factor 0.94 2500 m factor 0.9 (refer to the documentation "General Section")
Magnetic materials	Rare earth materials
Electrical connection	Connector for power and encoder signals <ul style="list-style-type: none"> <li>Connector outlet direction can be selected</li> </ul>
Encoder system	Integrated analog tachometer <ul style="list-style-type: none"> <li>Speed sensing</li> </ul> Magnetic elements or Hall sensors <ul style="list-style-type: none"> <li>Rotor position sensing</li> </ul>

## 1.3 Technical version, 1FT5 motors

## Options

Table 1-2 Options

Technical feature	Version
Degree of protection (acc. to EN 60034-5; IEC 60034-5)	IP 67, IP 68 (only non-ventilated)
Cooling	Forced cooling
Shaft end (according to DIN 748-3; IEC 60072-1)	Cylindrical without keyway (DIN 6885); tolerance zone k6
Radial eccentricity, concentricity, axial eccentricity (DIN 42955; IEC 60072-1)	Tolerance R
Vibration severity (acc. to EN 60034-14; IEC 60034-14)	Stage R
Mounted/integrated components	<ul style="list-style-type: none"> <li>• Fail-safe holding brake; supply voltage 24V ± 10% (acc. to DIN 0580 7/79)</li> <li>• Working brake (shaft height 71, shaft height 100 and shaft height 132)</li> <li>• Integrated pulse encoder (shaft height 63 to shaft height 132)</li> <li>• Mounted pulse encoder</li> <li>• Prepared for mounting an encoder</li> <li>• Mounted planetary gearbox</li> </ul>

## 1.3 Technical version, 1FT5 motors

## Technical data

Core types have a grey background. **100 K** values are specified in the table.

Table 1-3 Technical data of standard 1FT5 motors

$n_N$ [RPM]	$M_0$ [Nm]	$M_N$ [Nm]	Motor type 1FT5–	Motor current $I_0$ [A]	Rated drive converter current [A]	$P_{calc}$ [kW]	Connec- tor size	Cross section <sup>1)</sup> [mm <sup>2</sup> ]	Cable type <sup>4)</sup> 6FX□002–	
1200	33	31	102–□AA71	12.5	12.5	3.9	2	4x2.5	5□A02–1□□□	
	45	40	104–□AA71	17	25	5.0	2	4x2.5	5□A02–1□□□	
	55	47	106–0AA71	20.5	25	5.9	2	4x2.5	5□A02–1□□□	
	68	55	108–0AA71	25.5	<sup>3)</sup> 25	6.9	2	4x2.5	5□A02–1□□□	
	75	55	132–0AA71	28	40	6.9	2	4x4	5□A12–1□□□	
	90	65	134–0AA71	33.5	40	8.2	2	4x4	5□A12–1□□□	
	105	82	136–0AA71	39	40	10.3	2	4x6	5□A22–1□□□	
	130	100	138–0AA71	48.5	80	12.6	3	4x16	5□A23–1□□□	
	95	85	132–0SA71	35	40	10.7	2	4x6	5□A22–1□□□	
	120	115	134–0SA71	45	80	14.5	2	4x10	5□A32–1□□□	
	145	135	136–0SA71	54	80	17.0	3	4x16	5□A23–1□□□	
	185	170	138–0SA71	69	80	21.4	3	4x16	5□A23–1□□□	
	2000	2.6	2.4	062–□AC71	1.6	4	0.5	1	4x1.5	5□A01–1□□□
		5.5	4.7	064–□AC71	3.3	4	1.0	1	4x1.5	5□A01–1□□□
8		6.7	066–□AC71	4.9	7.5	1.4	1	4x1.5	5□A01–1□□□	
12		9.5	072–□AC71	7.3	7.5	2.0	1	4x1.5	5□A01–1□□□	
18		14	074–□AC71	11	12.5	2.9	1	4x1.5	5□A01–1□□□	
22		18.5	076–□AC71	13.5	25	3.9	1	4x1.5	5□A01–1□□□	
33		29	102–□AC71	20.5	25	6.1	2	4x2.5	5□A02–1□□□	
45		35	104–□AC71	27.5	40	7.3	2	4x4	5□A12–1□□□	
55		39	106–□AC71	33	40	8.2	2	4x4	5□A12–1□□□	
68		42.5	108–□AC71	40	40	8.9	2	4x6	5□A22–1□□□	
75		45	132–0AC71	44	80	9.4	3	4x10	5□A13–1□□□	
90		50	134–0AC71	56	80	10.5	3	4x16	5□A23–1□□□	
105		60	136–0AC71	59	80	12.6	3	4x16	5□A23–1□□□	
95		80	132–0SC71	56	80	16.8	3	4x16	5□A23–1□□□	
120	110	134–0SC71	75	80	23.0	3	4x16	5□A23–1□□□		
145	130	136–0SC71	81	<sup>3)</sup> 80	27.2	3	4x25	5□A33–1□□□		
3000	1	1	042–□AF71	1.1	4	0.3	1	4x1.5	5□A01–1□□□	
	2	1.9	044–□AF71	2.1	4	0.6	1	4x1.5	5□A01–1□□□	
	3.7	3.4	046–□AF71	3.9	4	1.1	1	4x1.5	5□A01–1□□□	
	2.6	2.3	062–□AF71	2.4	4	0.7	1	4x1.5	5□A01–1□□□	
	5.5	4.3	064–□AF71	5.0	7.5	1.4	1	4x1.5	5□A01–1□□□	
	8	6.1	066–□AF71	7.3	7.5	1.9	1	4x1.5	5□A01–1□□□	
	12	8.5	072–□AF71	11	12.5	2.7	1	4x1.5	5□A01–1□□□	
	18	12.5	074–□AF71	17	25	3.9	1	4x1.5	5□A01–1□□□	
	22	16.5	076–□AF71	20	25	5.2	2	4x2.5	5□A02–1□□□	
	33	25	102–□AF71	31	40	7.9	2	4x4	5□A12–1□□□	
	45	29	104–0AF71	41.5	<sup>3)</sup> 40	9.1	2	4x6	5□A22–1□□□	
	55	28	106–0AF71	52	80	8.8	3	4x16	5□A23–1□□□	
	68	20	108–0AF71	62.5	80	6.3	3	4x16	5□A23–1□□□	
	75	30	132–0AF71	59	80	23.6	3	4x16	5□A23–1□□□	
	40	36	102–0SF71	37	40	11.3	2	4x6	5□A22–1□□□	
	58	45	104–0SF71	53	80	14.3	3	4x16	5□A23–1□□□	
	70	58	106–0SF71	66	80	18.2	3	4x16	5□A23–1□□□	
95	75	132–0SF71	75	80	29.8	3	4x16	5□A23–1□□□		

## 1.3 Technical version, 1FT5 motors

Table 1-3 Technical data of standard 1FT5 motors, continued

$n_N$ [RPM]	$M_0$ [Nm]	$M_N$ [Nm]	Motor type 1FT5–	Motor current $I_0$ [A]	Rated drive converter current [A]	$P_{calc}$ [kW]	Conne- ctor size	Cross section <sup>1)</sup> [mm <sup>2</sup> ]	Cable type <sup>4)</sup> 6FX□002–	
4000	2.6	2.2	062–□AG71	3.2	4	0.9	1	4x1.5	5□A01–1□□□	
	5.5	3.8	064–□AG71	6.7	7.5	1.6	1	4x1.5	5□A01–1□□□	
	8	5.5	066–□AG71	9.6	12.5	2.3	1	4x1.5	5□A01–1□□□	
	12	7.5	072–0AG71	14.4	25	3.1	1	4x1.5	5□A01–1□□□	
	18	11	074–0AG71	21.5	25	4.6	2	4x2.5	5□A11–1□□□	
	22	13	076–0AG71	26.0	<sup>3)</sup> 25	5.4	2	4x4	5□A12–1□□□	
	33	10	102–0AG71	38.5	40	4.2	2	4x6	5□A22–1□□□	
	20.5	17	074–0SG71	24.5	25	7.1	2	4x2.5	5□A11–1□□□	
	26	21	076–0SG71	31.0	40	8.8	2	4x4	5□A12–1□□□	
	40	32	102–0SG71	46.5	40	13.4	3	4x16	5□A23–1□□□	
	6000	0.9	0.76	034–□AK71	1.6	4	0.5	1	4x1.5	5□A01–1□□□
		1.3	1.0	036–□AK71	2.3	4	0.6	1	4x1.5	5□A01–1□□□
1.0		0.9	042–□AK71	1.7	4	0.56	1	4x1.5	5□A01–1□□□	
2.0		1.65	044–0AK71	3.4	4	1.0	1	4x1.5	5□A01–1□□□	
3.7		2.7	046–□AK71	6.3	7.5	1.7	1	4x1.5	5□A01–1□□□	
2.6		2.1	062–0AK71	4.6	7.5	1.3	1	4x1.5	5□A01–1□□□	
5.5		3.0	064–0AK71	9.8	12.5	1.9	1	4x1.5	5□A01–1□□□	
8		4.2	066–0AK71	14.5	25	2.6	1	4x1.5	5□A01–1□□□	
12		5.0	072–0AK71	21.0	25	3.1	2	4x2.5	5□A11–1□□□	
18		7.0	074–0AK71	32.0	40	4.4	2	4x4	5□A12–1□□□	
22		4.0	076–0AK71	39.0	40	2.5	2	4x6	5□A22–1□□□	
20.5		12	074–0SK71	36.0	40	7.5	2	4x6	5□A22–1□□□	
26		15	076–0SK71	46.0	<sup>3)</sup> 40	9.4	3	4x16	5□A23–1□□□	

1 Core type  
0 No core type

**without brake cable:** without overall shield  
with overall shield  
**with brake cable:** without overall shield  
with overall shield

A  
C  
B  
D

Calculating the power

$$P_{calc} [kW] = \frac{M_N \times n}{9550} \quad \begin{matrix} M [Nm] \\ n [RPM] \end{matrix}$$

Lengths <sup>2)</sup>  
(examples)      5 m    AF  
                         10 m    BA  
                         15 m    BF  
                         18 m    BJ  
                         25 m    CF

Cables are not included in the scope of supply of the motors – they must be separately ordered.

- 1) Designed for  $I_{0rms} = I_{0[100k]} \times \sqrt{2/3}$ ; ambient temp. 40 °C; PVC-insulated cable; brake connection 2x1 mm<sup>2</sup>.
- 2) Cables are supplied by the meter; refer to the "General Section" of the documentation for the length code
- 3) With the specified power module, the motor cannot be fully utilized acc. to the 100 K winding temperature rise.
- 4) 6FX8–002 = MOTION-CONNECT 800  
6FX5–002 = MOTION-CONNECT 500  
Technical data, refer to Catalog NC Z

1.3 Technical version, 1FT5 motors

Table 1-4 Technical data of short 1FT5 motors

$n_N$ [RPM]	$M_0$ [Nm]	$M_N$ [Nm]	Motor type 1FT5–	Motor current $I_0$ [A]	Rated drive converter current [A]	$P_{calc}$ [kW]	Conne- ctor size	Cross section <sup>1)</sup> [mm <sup>2</sup> ]	Cable type <sup>4)</sup> 6FX□002–
2000	3.5	3.1	070–0AC71	3.1	4	0.65	1	4x1.5	5□A01–1□□□
	5.5	5	071–0AC71	5.2	4	1.0	1	4x1.5	5□A01–1□□□
	9	8	073–0AC71	8.2	7.5	1.7	1	4x1.5	5□A01–1□□□
	13	12	100–0AC71	12.0	12.5	2.5	2	4x2.5	5□A02–1□□□
	19	17	101–0AC71	18.0	12.5	3.6	2	4x2.5	5□A02–1□□□
	25	22.5	103–0AC71	23.0	25	4.7	2	4x2.5	5□A02–1□□□
3000	3.5	3.0	070–0AF71	3.1	4	0.94	1	4x1.5	5□A01–1□□□
	5.5	4.8	071–0AF71	5.2	7.5	1.5	1	4x1.5	5□A01–1□□□
	9	7.2	073–0AF71	8.2	12.5	2.3	1	4x1.5	5□A01–1□□□
	13	11	100–0AF71	12.0	12.5	3.5	2	4x2.5	5□A02–1□□□
	19	15	101–0AF71	18.0	25	4.7	2	4x2.5	5□A02–1□□□
	25	20	103–0AF71	23.0	25	6.3	2	4x2.5	5□A02–1□□□

**without brake cable:** without overall shield A  
with overall shield C  
**with brake cable:** without overall shield B  
with overall shield D

Calculating the power

$$P_{calc} [kW] = \frac{M_N \times n}{9550} \quad \begin{matrix} M [Nm] \\ n [RPM] \end{matrix}$$

Lengths <sup>2)</sup>  
(examples)      5 m    AF  
                         10 m   BA  
                         15 m   BF  
                         18 m   BJ  
                         25 m   CF

Cables are not included in the scope of supply of the motors – they must be separately ordered.

- 1) Designed for  $I_{0rms} = I_{0[100k]} \times \sqrt{2/3}$ ; ambient temp. 40 °C; PVC–insulated cable; brake connection 2x1 mm<sup>2</sup>.
- 2) Cables are supplied by the meter; refer to the "General Section" of the documentation for the length code
- 3) With the specified power module, the motor cannot be fully utilized acc. to the 100 K winding temperature rise.
- 4) 6FX8–002 = MOTION-CONNECT 800  
6FX5–002 = MOTION-CONNECT 500  
Technical data, refer to Catalog NC Z

## 1.4 Functions and expanded functions

### Armature short-circuit braking

For a definition refer to the "General Section" of the documentation.

#### Brake resistors

An optimum braking time is achieved by appropriately dimensioning the braking resistors. The braking torques which are obtained are also listed in the tables. The data applies for braking from the rated speed. If the motor brakes from another speed, then the braking time **cannot** be linearly reduced. However, longer braking times cannot occur.

The resistor rating must be coordinated with the particular  $I^2t$  load capacity, refer to the documentation "General Section".

Table 1-5 Resistor braking for 1FT5 motors, shaft heights 36 and 48

Motor type	External braking resistor $R_{opt}$ [ $\Omega$ ]	Average braking torque $M_{br rms}$ [Nm]	Max. braking torque $M_{br max}$ [Nm]	RMS braking current $I_{br rms}$ [A]
1FT5034-□AK71	– 4.7	1.5 1.5	1.9	4.1 3.9
1FT5036-□AK71	– 4.7	2.3 2.4	3.0	6.6 6.2
1FT5042-□AF71	–	1.8	2.3	2.7
1FT5042-□AK71	– 7.8	1.7 1.8	2.3	4.8 4.5
1FT5044-□AF71	–	3.6	4.5	6.0
1FT5044-0AK71	2.8 – 5.9	3.7 2.9 3.6	4.5	5.8 10.0 9.2
1FT5046-□AF71	–	6.9	9.4	12.8
1FT5046-□AK71	2.7 – 3.4	7.6 4.9 7.2	9.1	11.9 20.6 18.6

## 1.4 Functions and expanded functions

Table 1-6 Resistor braking for 1FT5 motors, shaft height 63

Motor type	External braking resistor $R_{opt}$ [ $\Omega$ ]	Average braking torque $M_{br rms}$ [Nm]	Max. braking torque $M_{br max}$ [Nm]	RMS braking current $I_{br rms}$ [A]
1FT5062-□AC71	–	2.5	3.4	2.9
1FT5062-□AF71	–	2.8	3.5	4.1
1FT5062-□AG71	–	1.9	3.4	6.0
1FT5062-0AK71	10.0	2.8	3.5	5.4
	–	1.6		9.1
1FT5062-0AK71	6.8	2.8	7.6	8.1
	–	4.9		6.4
	–	4.1		9.7
	–	3.5		13.3
1FT5064-□AG71	4.7	6.1	7.6	11.9
1FT5064-0AK71	–	2.8	7.6	19.6
	3.9	6.1		17.6
1FT5066-□AC71	–	7.0	11.5	9.8
1FT5066-□AF71	5.6	9.2	11.3	8.9
	–	5.4		14.6
1FT5066-□AG71	3.9	8.9	11.5	13.1
	–	4.9		20.1
1FT5066-0AK71	3.3	9.2	11.2	18.0
	–	3.7		28.8
1FT5066-0AK71	2.7	9.0		25.8

Table 1-7 Resistor braking for 1FT5 motors, shaft height 71

Motor type	External braking resistor $R_{opt}$ [ $\Omega$ ]	Average braking torque $M_{br rms}$ [Nm]	Max. braking torque $M_{br max}$ [Nm]	RMS braking current $I_{br rms}$ [A]
1FT5072-□AC71	–	7.7	12.5	10.8
1FT5072-□AF71	4.7	10.0	12.5	9.8
	–	6.5		16.5
1FT5072-0AG71	3.9	10.1	12.6	14.7
	–	5.6		22.0
1FT5072-0AK71	3.3	10.3	12.4	19.5
	–	4.0		30.5
1FT5072-0AK71	2.7	9.8		27.0
1FT5074-□AC71	–	12.3	21.9	19.0
1FT5074-□AF71	2.7	17.6	22.0	17.0
	–	10.0		29.5
1FT5074-0AG71	2.2	18.0	21.7	26.5
	–	8.1		36.5
1FT5074-0AK71	3.9	17.0	22.2	32.5
	–	7.0		59.0
1FT5074-0AK71	2.2	18.0		52.5



## 1.4 Functions and expanded functions

Table 1-7 Resistor braking for 1FT5 motors, shaft height 71

Motor type	External braking resistor $R_{opt}$ [ $\Omega$ ]	Average braking torque $M_{br rms}$ [Nm]	Max. braking torque $M_{br max}$ [Nm]	RMS braking current $I_{br rms}$ [A]
1FT5076-□AC71	–	16.8	31.4	27.5
	2.2	25.5		24.5
1FT5076-□AF71	–	13.4	31.4	40.5
	1.5	25.0		36.5
1FT5076-0AG71	–	11.5	31.6	54.5
	1.2	25.5		48.5
1FT5076-0AK71	–	8.9	31.6	80.0
	1.0	25.5		71.5

Table 1-8 Resistor braking for 1FT5 motors, shaft height 100

Motor type	External braking resistor $R_{opt}$ [ $\Omega$ ]	Average braking torque $M_{br rms}$ [Nm]	Max. braking torque $M_{br max}$ [Nm]	RMS braking current $I_{br rms}$ [A]
1FT5102-□AA71	–	34.0	56.5	29.5
	1.8	45.5		26.5
1FT5102-□AC71	–	25.5	56.4	48.5
	1.2	45.0		43.5
1FT5102-□AF71	–	20.5	56.6	75.5
	0.82	45.5		67.5
1FT5102-0AG71	–	18.0	56.4	94.5
	0.82	45.0		84.5
1FT5104-□AA71	–	49.0	82.0	44.0
	1.2	67.5		39.5
1FT5104-□AC71	–	37.0	82.5	73.0
	0.82	68.0		65.5
1FT5104-0AF71	–	27.5	81.5	105.0
	0.68	66.0		94.0
1FT5106-0AA71	–	59.5	105.0	56.5
	1.0	87.0		51.0
1FT5106-□AC71	–	43.0	104.0	89.0
	0.68	84.0		80.0
1FT5106-0AF71	–	33.0	103.0	136.0
	0.47	82.0		122.0
1FT5108-0AA71	–	73.0	126.0	71.0
	0.82	102.0		64.5
1FT5108-□AC71	–	51.0	123.0	105.0
	0.56	100.0		93.0
1FT5108-0AF71	–	43.0	125.0	167.0
	0.39	101.0		149.0

## 1.4 Functions and expanded functions

Table 1-9 Resistor braking for 1FT5 motors, shaft height 132 <sup>1)</sup>

Motor type	External braking resistor $R_{opt}$ [ $\Omega$ ]	Average braking torque $M_{br rms}$ [Nm]	Max. braking torque $M_{br max}$ [Nm]	RMS braking current $I_{br rms}$ [A]
1FT5132-0AA71	–	61.5	123.0	65.0
1FT5132-0AC71	1.0	98.5	128.0	58.0
1FT5132-0AF71	–	51.0	124.0	114.0
	0.56	101.0		103.0
	–	35.5		140.0
	0.56	100.0		125.0
1FT5134-0AA71	–	77.0	160.0	86.5
1FT5134-0AC71	0.68	131.0	156.0	77.5
	–	54.5		137.0
	0.47	124.0		123.0
1FT5136-0AA71	–	94.0	206.0	109.0
1FT5136-0AC71	0.56	166.0	204.0	98.5
	–	68.0		163.0
	0.47	164.0		146.0
1FT5138-0AA71	–	107.0	245.0	130.0
	0.47	197.0		117.0

Table 1-10 Resistor braking for 1FT5 motors, shaft heights 71 and 100 (force-ventilated)

Motor type	External braking resistor $R_{opt}$ [ $\Omega$ ]	Average braking torque $M_{br rms}$ [Nm]	Max. braking torque $M_{br max}$ [Nm]	RMS braking current $I_{br rms}$ [A]
1FT5074-0SG71	–	8.1	21.7	36.5
1FT5074-0SK71	3.9	17.0	22.2	32.5
	–	7.0		59.0
	2.2	18.0		52.5
1FT5076-0SG71	–	11.5	31.6	54.5
1FT5076-0SK71	1.2	25.5	31.6	48.5
	–	8.9		80.0
	1.1	25.5		71.5
1FT5102-0SF71	–	20.5	56.6	75.5
1FT5102-0SG71	0.82	45.5	56.4	67.5
	–	18.0		94.5
	0.82	45.0		84.5
1FT5104-0SF71	–	27.5	81.5	105.0
	0.68	66.0		94.0
1FT5106-0SF71	–	33.0	103.0	136.0
	0.47	82.0		122.0

- 1) When utilized acc. to  $M_0$  (100 K) a series resistor must be used in order to prevent partial de-magnetization. The additional braking resistor can be eliminated when utilized acc. to  $M_0$  (60 K).

## 1.4 Functions and expanded functions

Table 1-11 Resistor braking for 1FT5 motors, shaft height 132 (force ventilated)<sup>1)</sup>

Motor type	External braking resistor $R_{opt}$ [ $\Omega$ ]	Average braking torque $M_{br rms}$ [Nm]	Max. braking torque $M_{br max}$ [Nm]	RMS braking current $I_{br rms}$ [A]
1FT5132-0SA71	–	61.5	123.0	65.0
1FT5132-0SC71	1.0	98.5	128.0	58.0
1FT5132-0SF71	–	51.0	124.0	114.0
	0.56	101.0		103.0
	–	35.5		140.0
	0.56	100.0		125.0
1FT5134-0SA71	–	77.0	160.0	86.5
1FT5134-0SC71	0.68	131.0	156.0	77.5
	–	54.5		137.0
	0.47	124.0		123.0
1FT5136-0SA71	–	94.0	206.0	109.0
1FT5136-0SC71	0.56	166.0	204.0	98.5
	–	68.0		163.0
	0.47	164.0		146.0
1FT5138-0SA71	–	107.0	245.0	130.0
	0.47	197.0		117.0

1) When utilized acc. to  $M_0$  (100 K) a series resistor must be used in order to prevent partial de-magnetization. The additional braking resistor can be eliminated when utilized acc. to  $M_0$  (60 K).

## 1.4 Functions and expanded functions

Table 1-12 Resistor braking for 1FT5 motors, shaft heights 71 and 100 (short motors)

Motor type	External braking resistor $R_{opt}$ [ $\Omega$ ]	Average braking torque $M_{br rms}$ [Nm]	Max. braking torque $M_{br max}$ [Nm]	RMS braking current $I_{br rms}$ [A]
1FT5070-0AC71	–	2.8	3.7	3.0
1FT5070-0AF71	–	2.4	3.6	4.4
1FT5071-0AC71	–	4.3	6.3	5.5
1FT5071-0AF71	–	3.8	6.4	8.5
1FT5073-0AC71	– 4.7	7.2 9.1	11.3	9.7 8.8
1FT5073-0AF71	– 3.9	5.9 9.1	11.3	14.7 13.3
1FT5100-0AC71	– 3.3	10.0 14.5	18.1	15.8 14.3
1FT5100-0AF71	– 2.7	8.0 14.5	18.0	23.8 21.4
1FT5101-0AC71	– 2.2	15.0 24.0	29.0	26.0 23.5
1FT5101-0AF71	– 1.5	11.9 23.5	28.7	39.0 34.5
1FT5103-0AC71	– 1.5	21.0 34.0	42.4	38.0 34.0
1FT5103-0AF71	– 1.2	16.0 34.5	42.7	56.5 50.5

## 1.5 Cooling

The different cooling types (non-ventilated and force-ventilated) are described in the "General Section" documentation.

### Forced ventilation

Degree of protection: IP 54 (acc. to EN 60529). IP 67 cannot be fulfilled. It is not permissible that the hot discharged air is drawn-in again.

The separately-driven fan can be retrofitted. However, the following measures must be carefully observed. For shaft height 100, only a Siemens-authorized workshop may do the retrofit work.

In some cases, the motors have larger power connectors as a result of the higher torques and the associated higher phase currents.

Shaft heights 71, 100 and 132 differ as follows:

- **Shaft heights 100 and 132:** Air flow direction from the drive end to non-drive end

Air is drawn-in from the non-drive end through the corners of the extruded profile housing using a mounted radial fan.

The modified dimensions can be taken from the dimension drawings.

Connection system:	Terminal box
Supply voltage:	3-ph. 400/460 V AC, 50/60 Hz
Maximum current:	0.4 A
Weight of the cooling assembly:	approx. 5.6 kg

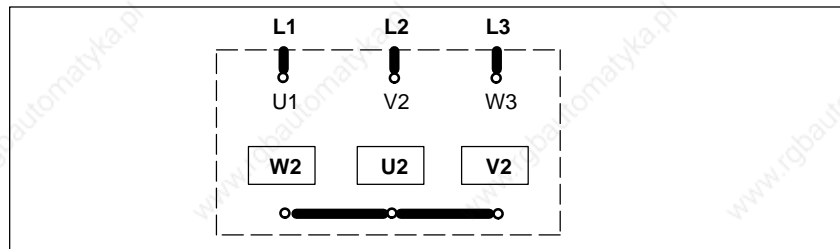

Fig. 1-1 Fan connection for shaft heights 100/132

- **Shaft height 71:** Air flow direction from the non-drive end to drive end

When the direction of the air flow is reversed, the torque yield is reduced by approx. 20 %.

Mechanical changes to the motor with respect to non-ventilated versions:

- The power connector is set about 12 mm higher.
- A sheet metal envelope is located over the motor frame from the non-drive end side. The axial fan is mounted in this sheet metal envelope. As a result of the recesses in the sheet metal envelope at the connectors, at these locations, the motor is only partially cooled with air (three-sided cooling).
- The motor dimensions can be taken from the dimension drawings.

## 1.5 Cooling

Connection system:: Connector <sup>1)</sup>, 6FX2003-0CA10  
 Supply voltage: 1-ph. 230/260 V AC, 50/60 Hz  
 Maximum current: 0.3 A  
 Weight of the fan assembly: approx. 4.8 kg

Connector assignment:

Fan connection (AH 71)

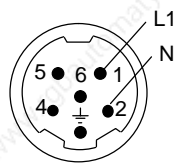

### Minimum clearance between mounted components and the air discharge opening

The following minimum clearance to customer-specific mounted components and the air discharge opening must be maintained:

Table 1-13 Minimum clearance to customer-specific components

Shaft height [mm]	Minimum clearance [mm]
71	20
100	30
132	60

1) Power connector, Size 1

## 1.6 Electrical connections

The motors have been designed to be connected to a 600 V DC link voltage with an impressed squarewave current. Together with the analog SIMODRIVE 611 drive unit, these motors form a complete drive system.

For DC link voltages which differ from 600 V (max. 700 V), the voltage limiting characteristic is shifted as described in the "General Section" documentation.

---

### Note

When a drive converter is, for example, connected to a 480 V line supply, then DC link voltages > 600 V are obtained. The following restriction then applies: Shaft heights 36, 48, 63, 71 may only be utilized according to  $\Delta T=60$  K limit values.

---



---

### Warning

The motors are not suitable for connecting directly to the line supply.

---

1.6 Electrical connections

Connection assignment, power and signal connectors

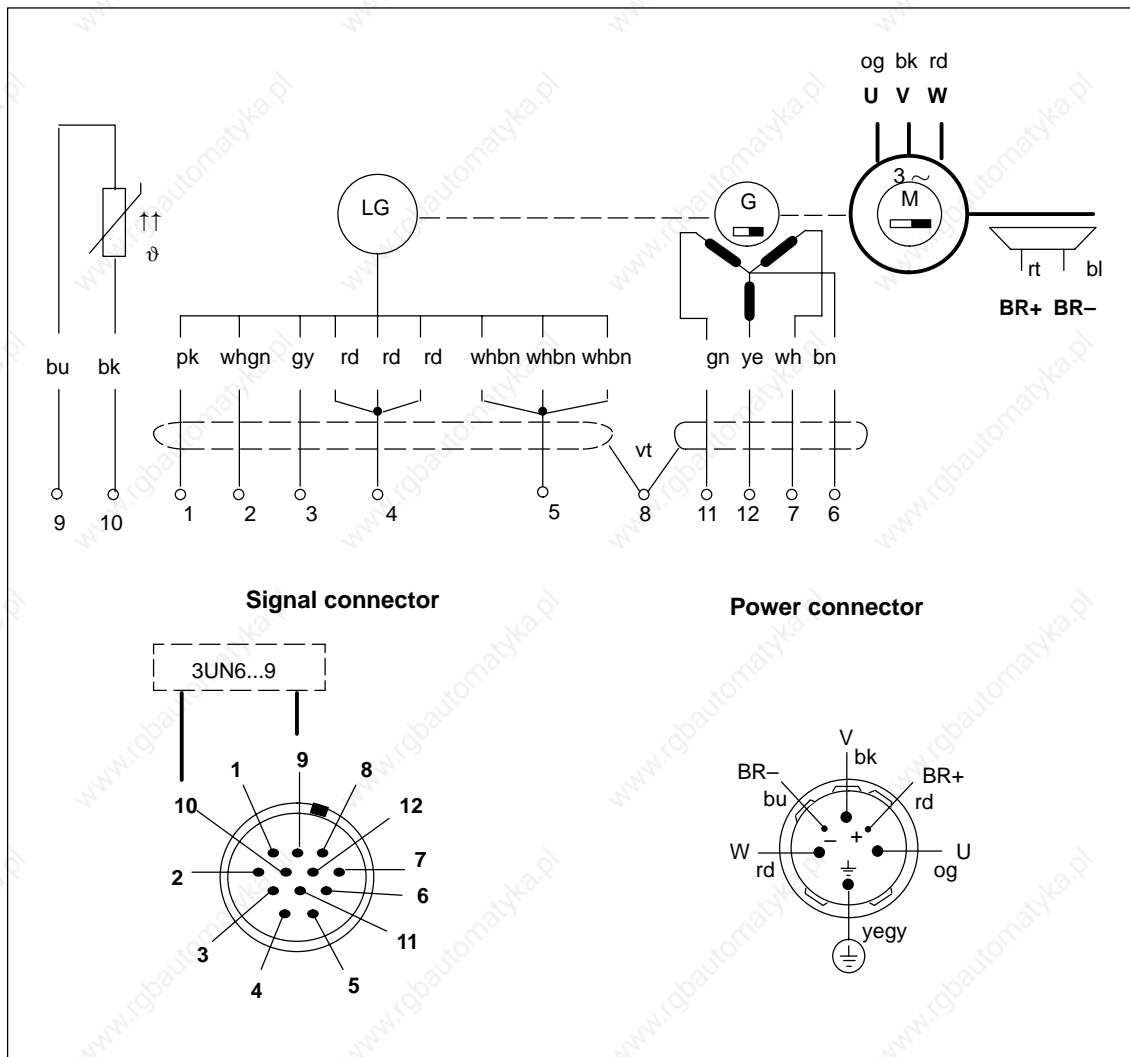

Fig. 1-2 Connection assignment: Power, brake, tachogenerator, encoder and temperature sensor



## 1.7 Drive-out coupling

For the ordering address, refer to the documentation "General Section" or the Internet [www.ktr.com](http://www.ktr.com)

Table 1-14 Assignment of the drive-out couplings to the motors

Shaft height	Rotex GS Type	Torques which can be transferred with 98 Sh-A-GS pinion	
		T <sub>KN</sub> [Nm]	T <sub>Kmax</sub> [Nm]
63	24/28	60	120
71	28/32	160	320
100	38/45	325	650

It may be necessary to use other pinions (e.g. Shore hardness 80 SH-A). This must be optimally harmonized together with the mounted mechanical system.



### Warning

**The accelerating torque may not exceed the clamping torque of the coupling!**



1.7 Drive-out coupling

Space for your notes

---

---

---

---

---

---

---

---

---

---

---

---

---

---

---

---

---

---

---

---

---

---

---

---

## Technical Data and Characteristics

### 2.1 Speed–torque diagrams

---

**Note**

- DC link voltages > 600 V occur when the motors are fed from drive converters connected to 480 V line supplies. The following restrictions apply:
    - Shaft heights 36, 48, 63 and 71 may only be utilized to  $\Delta T = 60$  K.
    - Shaft heights 100 and 132 may still be utilized to  $\Delta T = 100$  K.
  - For a description of the shift of the voltage limiting characteristics, refer to the documentation "General Section".
  - The specified thermal S3 limits are referred to  $\Delta T = 100$  K.
- 

---

**Note**

For 1FT5 motors, the rotor moment of inertia is specified without tachometer.

---

2.1 Speed–torque diagrams

2.1.1 Standard motors

Table 2-1 Standard 1FT5034 motor

1FT5034				
Technical data	Code	Units	–□AK71	
<b>Engineering data</b>				
Rated speed	$n_N$	RPM	6000	
Rated torque (100 K)	$M_N$ (100 K)	Nm	0.76	
Rated current	$I_N$	A	1.5	
Standstill torque (60 K)	$M_0$ (60 K)	Nm	0.7	
Standstill torque (100 K)	$M_0$ (100 K)	Nm	0.9	
Standstill current (60 K)	$I_0$ (60 K)	A	1.2	
Standstill current (100 K)	$I_0$ (100 K)	A	1.6	
Moment of inertia (with brake)	$J_{mot}$	$10^{-4}$ kgm <sup>2</sup>	0.74	
Moment of inertia (without brake)	$J_{mot}$	$10^{-4}$ kgm <sup>2</sup>	0.67	
<b>Limiting data</b>				
Maximum speed	$n_{max}$	RPM	9000	
Maximum torque	$M_{max}$	Nm	3.6	
Max. current	$I_{max}$	A	6.5	
Limiting torque	$M_{limit}$	Nm	1.4	
<b>Physical constants</b>				
Torque constant	$k_T$	Nm/A	0.58	
Voltage constant	$k_E$	V/1000 RPM	70	
Winding resistance	$R_{str}$	Ohm	16.3	
Rotating field inductance	$L_D$	mH	21.8	
Electrical time constant	$T_{el}$	ms	1.3	
Mechanical time constant	$T_{mech}$	ms	6.5	
Thermal time constant	$T_{th}$	min	40	
Weight (with brake)	$m$	kg	2.6	
Weight (without brake)	$m$	kg	2.4	

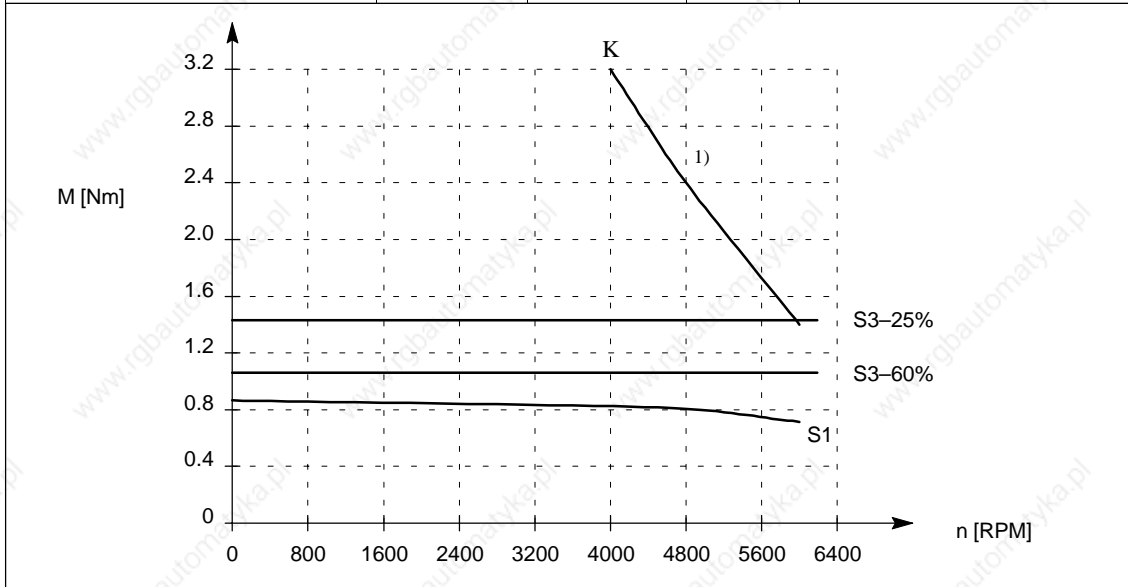

Fig. 2-1 Speed–torque diagram, 1FT5034

1) applies for a 600 V DC link voltage

## 2.1 Speed–torque diagrams

Table 2-2 Standard 1FT5036 motor

1FT5036				
Technical data	Code	Units	–□AK71	
<b>Engineering data</b>				
Rated speed	$n_N$	RPM	6000	
Rated torque (100 K)	$M_N$ (100 K)	Nm	1.0	
Rated current	$I_N$	A	2.0	
Standstill torque (60 K)	$M_0$ (60 K)	Nm	1.0	
Standstill torque (100 K)	$M_0$ (100 K)	Nm	1.3	
Standstill current (60 K)	$I_0$ (60 K)	A	1.7	
Standstill current (100 K)	$I_0$ (100 K)	A	2.3	
Moment of inertia (with brake)	$J_{mot}$	$10^{-4}$ kgm <sup>2</sup>	1.03	
Moment of inertia (without brake)	$J_{mot}$	$10^{-4}$ kgm <sup>2</sup>	0.96	
<b>Limiting data</b>				
Maximum speed	$n_{max}$	RPM	9000	
Maximum torque	$M_{max}$	Nm	5.2	
Max. current	$I_{max}$	A	9.5	
Limiting torque	$M_{limit}$	Nm	2.5	
<b>Physical constants</b>				
Torque constant	$k_T$	Nm/A	0.58	
Voltage constant	$k_E$	V/1000 RPM	70	
Winding resistance	$R_{ph.}$	Ohm	8.6	
Rotating field inductance	$L_D$	mH	13.7	
Electrical time constant	$T_{el}$	ms	1.5	
Mechanical time constant	$T_{mech}$	ms	4.9	
Thermal time constant	$T_{th}$	min	45	
Weight (with brake)	$m$	kg	3.3	
Weight (without brake)	$m$	kg	3.1	

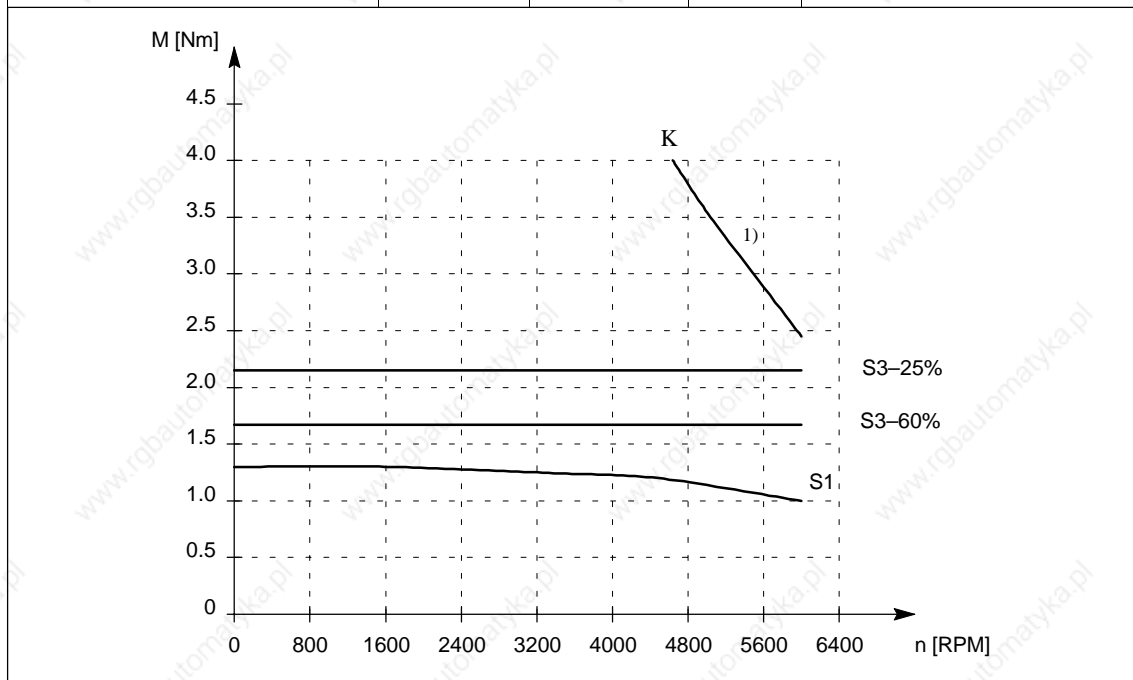

Fig. 2-2 Speed–torque diagram, 1FT5036

1) applies for a 600 V DC link voltage

2.1 Speed–torque diagrams

Table 2-3 Standard 1FT5042 motor

1FT5042					
Technical data	Code	Units	–0AF71	–□AK71	
<b>Engineering data</b>					
Rated speed	$n_N$	RPM	3000	6000	
Rated torque (100 K)	$M_N$ (100 K)	Nm	1.0	0.9	
Rated current	$I_N$	A	1.1	1.6	
Standstill torque (60 K)	$M_0$ (60 K)	Nm	0.75	0.75	
Standstill torque (100 K)	$M_0$ (100 K)	Nm	1.0	1.0	
Standstill current (60 K)	$I_0$ (60 K)	A	0.8	1.3	
Standstill current (100 K)	$I_0$ (100 K)	A	1.1	1.7	
Moment of inertia (with brake)	$J_{mot}$	$10^{-4}$ kgm <sup>2</sup>	2.11	2.11	
Moment of inertia (without brake)	$J_{mot}$	$10^{-4}$ kgm <sup>2</sup>	1.73	1.73	
<b>Limiting data</b>					
Maximum speed	$n_{max}$	RPM	5500	8300	
Maximum torque	$M_{max}$	Nm	4.0	4.0	
Max. current	$I_{max}$	A	4.5	7.0	
Limiting torque	$M_{limit}$	Nm	2.5	1.9	
<b>Physical constants</b>					
Torque constant	$k_T$	Nm/A	0.95	0.60	
Voltage constant	$k_E$	V/1000 RPM	115	75	
Winding resistance	$R_{ph.}$	Ohm	28.2	11.8	
Rotating field inductance	$L_D$	mH	48.4	20.3	
Electrical time constant	$T_{el}$	ms	1.7	1.7	
Mechanical time constant	$T_{mech}$	ms	11.0	11.0	
Thermal time constant	$T_{th}$	min	40	40	
Weight (with brake)	$m$	kg	3.5	3.5	
Weight (without brake)	$m$	kg	3.2	3.2	

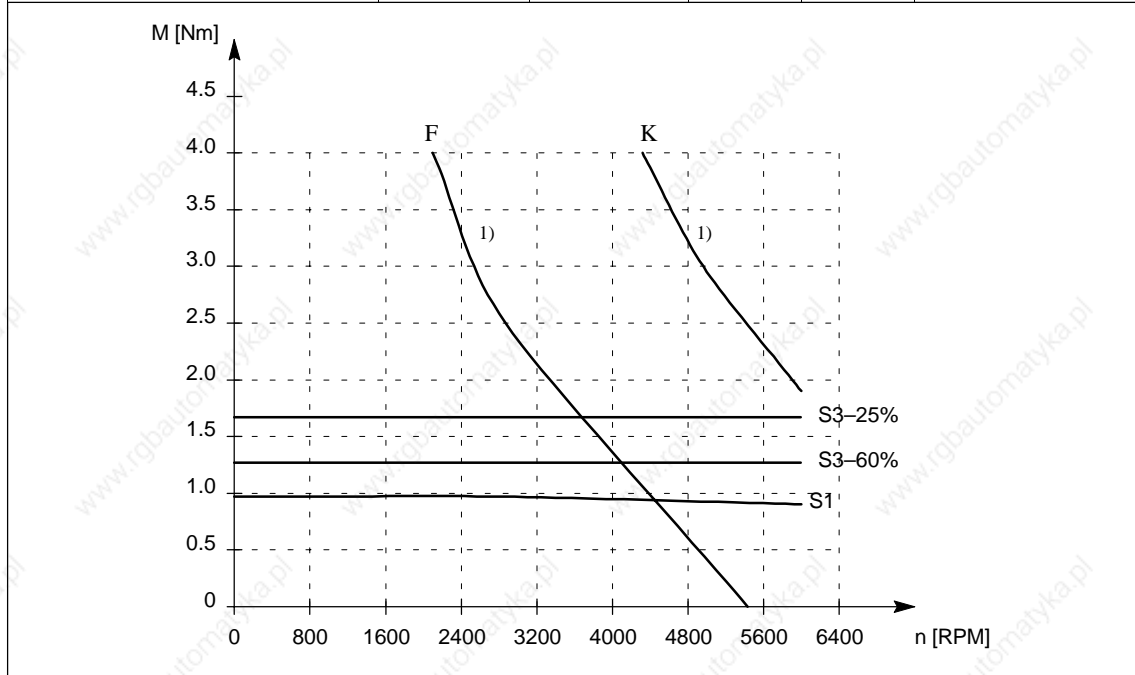

Fig. 2-3 Speed–torque diagram, 1FT5042

1) applies for a 600 V DC link voltage

## 2.1 Speed–torque diagrams

Table 2-4 Standard 1FT5044 motor

1FT5044					
Technical data	Code	Units	–□AF71	–□AK71	
<b>Engineering data</b>					
Rated speed	$n_N$	RPM	3000	6000	
Rated torque (100 K)	$M_N$ (100 K)	Nm	1.9	1.65	
Rated current	$I_N$	A	2.2	3.0	
Standstill torque (60 K)	$M_0$ (60 K)	Nm	1.5	1.5	
Standstill torque (100 K)	$M_0$ (100 K)	Nm	2.0	2.0	
Standstill current (60 K)	$I_0$ (60 K)	A	1.6	2.5	
Standstill current (100 K)	$I_0$ (100 K)	A	2.1	3.4	
Moment of inertia (with brake)	$J_{mot}$	$10^{-4}$ kgm <sup>2</sup>	3.14	3.14	
Moment of inertia (without brake)	$J_{mot}$	$10^{-4}$ kgm <sup>2</sup>	2.8	2.8	
<b>Limiting data</b>					
Maximum speed	$n_{max}$	RPM	5500	8300	
Maximum torque	$M_{max}$	Nm	8.0	8.0	
Max. current	$I_{max}$	A	8.5	14.0	
Limiting torque	$M_{limit}$	Nm	5.0	3.6	
<b>Physical constants</b>					
Torque constant	$k_T$	Nm/A	0.95	0.60	
Voltage constant	$k_E$	V/1000 RPM	115	72	
Winding resistance	$R_{ph.}$	Ohm	9.0	3.4	
Rotating field inductance	$L_D$	mH	24.2	9.5	
Electrical time constant	$T_{el}$	ms	2.8	2.8	
Mechanical time constant	$T_{mech}$	ms	5.4	5.4	
Thermal time constant	$T_{th}$	min	45	45	
Weight (with brake)	$m$	kg	4.5	4.5	
Weight (without brake)	$m$	kg	4.2	4.2	

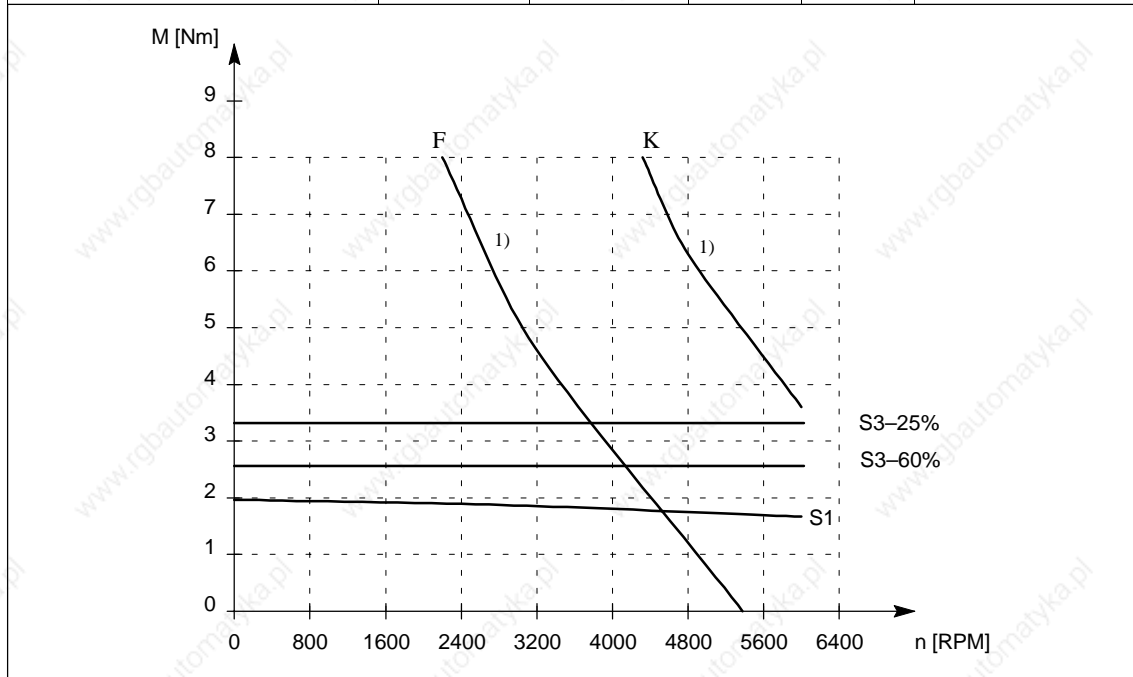

Fig. 2-4 Speed–torque diagram, 1FT5044

1) applies for a 600 V DC link voltage

2.1 Speed–torque diagrams

Table 2-5 Standard 1FT5046 motor

1FT5046					
Technical data	Code	Units	–□AF71	–□AK71	
<b>Engineering data</b>					
Rated speed	$n_N$	RPM	3000	6000	
Rated torque (100 K)	$M_N$ (100 K)	Nm	3.4	2.7	
Rated current	$I_N$	A	3.9	5.1	
Standstill torque (60 K)	$M_0$ (60 K)	Nm	2.8	2.8	
Standstill torque (100 K)	$M_0$ (100 K)	Nm	3.7	3.7	
Standstill current (60 K)	$I_0$ (60 K)	A	3.0	4.8	
Standstill current (100 K)	$I_0$ (100 K)	A	3.9	6.3	
Moment of inertia (with brake)	$J_{mot}$	$10^{-4}$ kgm <sup>2</sup>	5.31	5.31	
Moment of inertia (without brake)	$J_{mot}$	$10^{-4}$ kgm <sup>2</sup>	4.93	4.93	
<b>Limiting data</b>					
Maximum speed	$n_{max}$	RPM	5500	8300	
Maximum torque	$M_{max}$	Nm	14.8	14.8	
Max. current	$I_{max}$	A	16.0	26.0	
Limiting torque	$M_{limit}$	Nm	8.0	6.0	
<b>Physical constants</b>					
Torque constant	$k_T$	Nm/A	0.95	0.59	
Voltage constant	$k_E$	V/1000 RPM	115	71	
Winding resistance	$R_{ph.}$	Ohm	3.1	1.2	
Rotating field inductance	$L_D$	mH	11.7	4.6	
Electrical time constant	$T_{el}$	ms	3.8	3.8	
Mechanical time constant	$T_{mech}$	ms	3.4	3.4	
Thermal time constant	$T_{th}$	min	50	50	
Weight (with brake)	$m$	kg	6.7	6.7	
Weight (without brake)	$m$	kg	6.4	6.4	

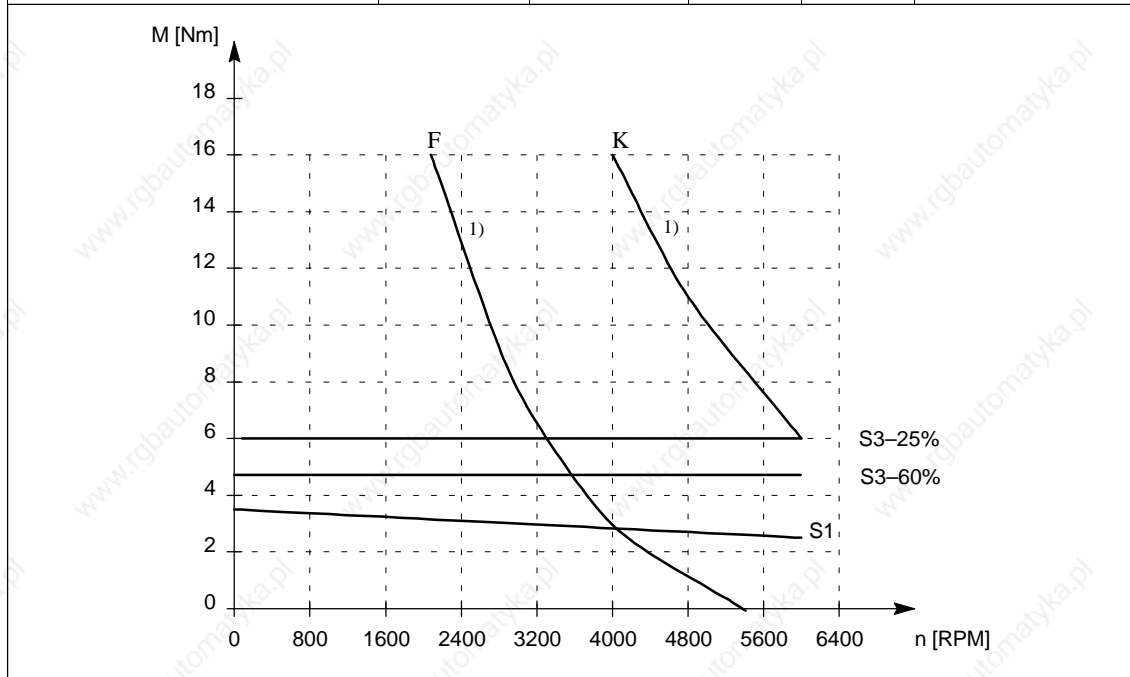

Fig. 2-5 Speed–torque diagram, 1FT5046

1) applies for a 600 V DC link voltage



## 2.1 Speed–torque diagrams

Table 2-6 Standard 1FT5062 motor

1FT5062						
Technical data	Code	Units	–□AC71	–□AF71	–□AG71	–□AK71
<b>Engineering data</b>						
Rated speed	$n_N$	RPM	2000	3000	4000	6000
Rated torque (100 K)	$M_N$ (100 K)	Nm	2.4	2.3	2.2	2.1
Rated current	$I_N$	A	1.6	2.3	2.9	4.1
Standstill torque (60 K)	$M_0$ (60 K)	Nm	2.2	2.2	2.2	2.2
Standstill torque (100 K)	$M_0$ (100 K)	Nm	2.6	2.6	2.6	2.6
Standstill current (60 K)	$I_0$ (60 K)	A	1.3	2.0	2.7	3.9
Standstill current (100 K)	$I_0$ (100 K)	A	1.6	2.4	3.2	4.6
Moment of inertia (with brake)	$J_{mot}$	$10^{-4}$ kgm <sup>2</sup>	5.76	5.76	5.76	5.76
Moment of inertia (without brake)	$J_{mot}$	$10^{-4}$ kgm <sup>2</sup>	4.7	4.7	4.7	4.7
<b>Limiting data</b>						
Maximum speed	$n_{max}$	RPM	3200	4800	6400	8600
Maximum torque	$M_{max}$	Nm	10.4	10.4	10.4	10.4
Max. current	$I_{max}$	A	6.6	10.0	13.5	20.0
Limiting torque	$M_{limit}$	Nm	5.0	5.0	4.9	4.8
<b>Physical constants</b>						
Torque constant	$k_T$	Nm/A	1.65	1.10	0.82	0.56
Voltage constant	$k_E$	V/1000 RPM	187	125	93	62
Winding resistance	$R_{ph.}$	Ohm	15.1	7.1	3.8	1.7
Rotating field inductance	$L_D$	mH	85.3	38.1	21.0	9.3
Electrical time constant	$T_{el}$	ms	5.6	5.6	5.6	5.6
Mechanical time constant	$T_{mech}$	ms	6.3	6.3	6.3	6.3
Thermal time constant	$T_{th}$	min	25	25	25	25
Weight (with brake)	$m$	kg	7.5	7.5	7.5	7.5
Weight (without brake)	$m$	kg	6.5	6.5	6.5	6.5

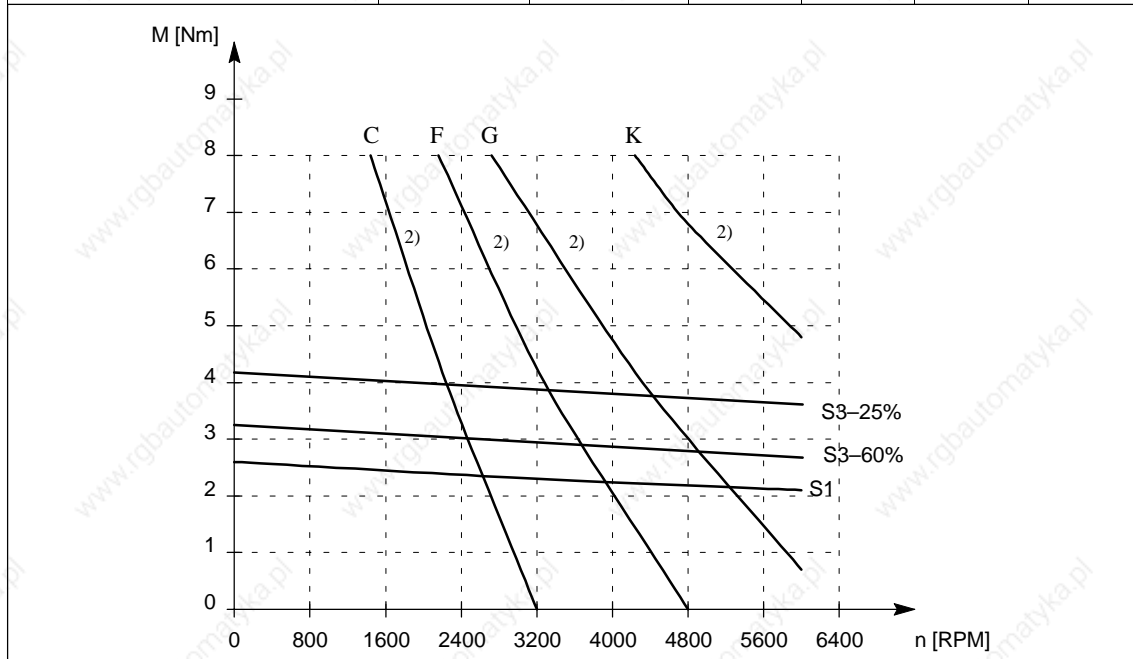

Fig. 2-6 Speed–torque diagram, 1FT5062

2) applies for a 600 V DC link voltage

2.1 Speed-torque diagrams

Table 2-7 Standard 1FT5064 motor

1FT5064						
Technical data	Code	Units	-□AC71	-□AF71	-□AG71	-□AK71
<b>Engineering data</b>						
Rated speed	$n_N$	RPM	2000	3000	4000	6000
Rated torque (100 K)	$M_N$ (100 K)	Nm	4.7	4.3	3.8	3.0
Rated current	$I_N$	A	3.1	4.2	5.1	5.9
Standstill torque (60 K)	$M_0$ (60 K)	Nm	4.5	4.5	4.5	4.5
Standstill torque (100 K)	$M_0$ (100 K)	Nm	5.5	5.5	5.5	5.5
Standstill current (60 K)	$I_0$ (60 K)	A	2.7	4.1	5.5	8.0
Standstill current (100 K)	$I_0$ (100 K)	A	3.3	5.0	6.7	9.8
Moment of inertia (with brake)	$J_{mot}$	$10^{-4}$ kgm <sup>2</sup>	9.36	9.36	9.36	9.36
Moment of inertia (without brake)	$J_{mot}$	$10^{-4}$ kgm <sup>2</sup>	8.3	8.3	8.3	8.3
<b>Limiting data</b>						
Maximum speed	$n_{max}$	RPM	3200	4800	6400	8600
Maximum torque	$M_{max}$	Nm	22	22	22	22
Max. current	$I_{max}$	A	14.0	20.0	29.0	42.0
Limiting torque	$M_{limit}$	Nm	10.0	10.0	9.8	9.6
<b>Physical constants</b>						
Torque constant	$k_T$	Nm/A	1.65	1.10	0.82	0.56
Voltage constant	$k_E$	V/1000 RPM	187	125	93	63
Winding resistance	$R_{ph.}$	Ohm	5.0	2.2	1.2	0.56
Rotating field inductance	$L_D$	mH	39.3	17.5	9.5	4.4
Electrical time constant	$T_{el}$	ms	7.5	7.5	7.5	7.5
Mechanical time constant	$T_{mech}$	ms	3.0	3.0	3.0	3.0
Thermal time constant	$T_{th}$	min	30	30	30	30
Weight (with brake)	$m$	kg	9.5	9.5	9.5	9.5
Weight (without brake)	$m$	kg	8.5	8.5	8.5	8.5

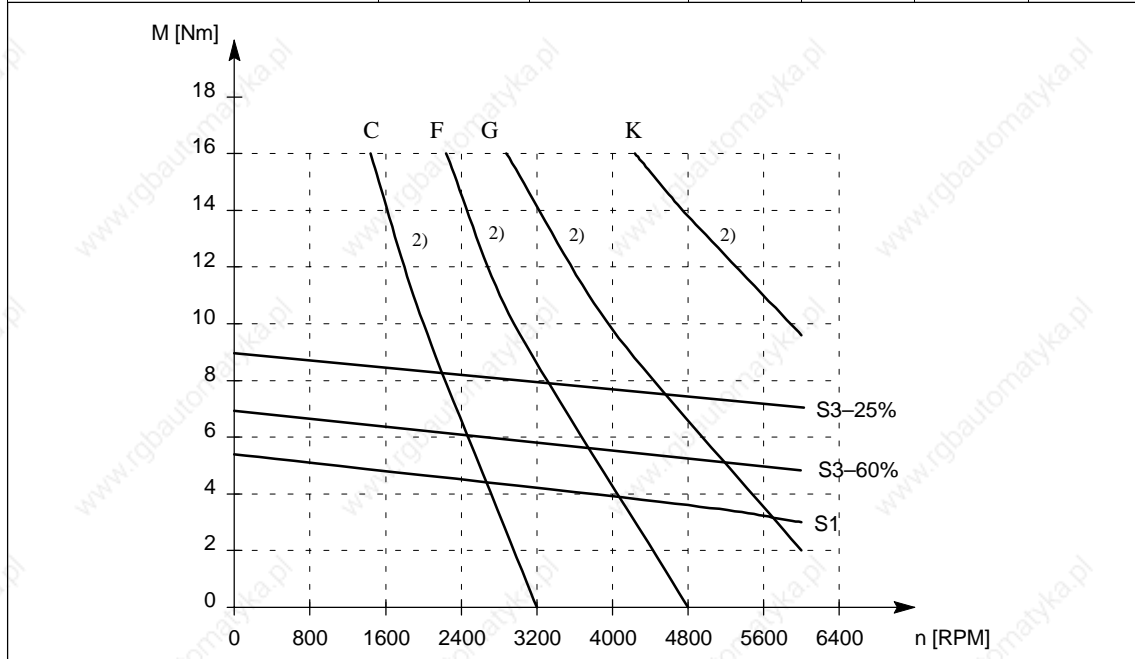

Fig. 2-7 Speed-torque diagram, 1FT5064

2) applies for a 600 V DC link voltage

## 2.1 Speed–torque diagrams

Table 2-8 Standard 1FT5066 motor

1FT5066						
Technical data	Code	Units	–□AC71	–□AF71	–□AG71	–□AK71
<b>Engineering data</b>						
Rated speed	$n_N$	RPM	2000	3000	4000	6000
Rated torque (100 K)	$M_N$ (100 K)	Nm	6.7	6.1	5.5	4.2
Rated current	$I_N$	A	4.4	6.1	7.3	8.3
Standstill torque (60 K)	$M_0$ (60 K)	Nm	6.5	6.5	6.5	6.5
Standstill torque (100 K)	$M_0$ (100 K)	Nm	8.0	8.0	8.0	8.0
Standstill current (60 K)	$I_0$ (60 K)	A	3.9	6.0	7.9	11.6
Standstill current (100 K)	$I_0$ (100 K)	A	4.9	7.3	9.6	14.5
Moment of inertia (with brake)	$J_{mot}$	$10^{-4}$ kgm <sup>2</sup>	12.86	12.86	12.86	12.86
Moment of inertia (without brake)	$J_{mot}$	$10^{-4}$ kgm <sup>2</sup>	11.8	11.8	11.8	11.8
<b>Limiting data</b>						
Maximum speed	$n_{max}$	RPM	3200	4900	6400	8600
Maximum torque	$M_{max}$	Nm	32	32	32	32
Max. current	$I_{max}$	A	20.0	31.0	41.0	61.0
Limiting torque	$M_{limit}$	Nm	14.8	14.8	14.8	14.4
<b>Physical constants</b>						
Torque constant	$k_T$	Nm/A	1.65	1.09	0.82	0.56
Voltage constant	$k_E$	V/1000 RPM	187	123	93	63
Winding resistance	$R_{ph.}$	Ohm	2.8	1.2	0.68	0.37
Rotating field inductance	$L_D$	mH	25.6	11.4	6.3	3.4
Electrical time constant	$T_{el}$	ms	9.2	9.2	9.2	9.2
Mechanical time constant	$T_{mech}$	ms	2.4	2.4	2.4	2.4
Thermal time constant	$T_{th}$	min	35	35	35	35
Weight (with brake)	$m$	kg	11.5	11.5	11.5	11.5
Weight (without brake)	$m$	kg	10.5	10.5	10.5	10.5

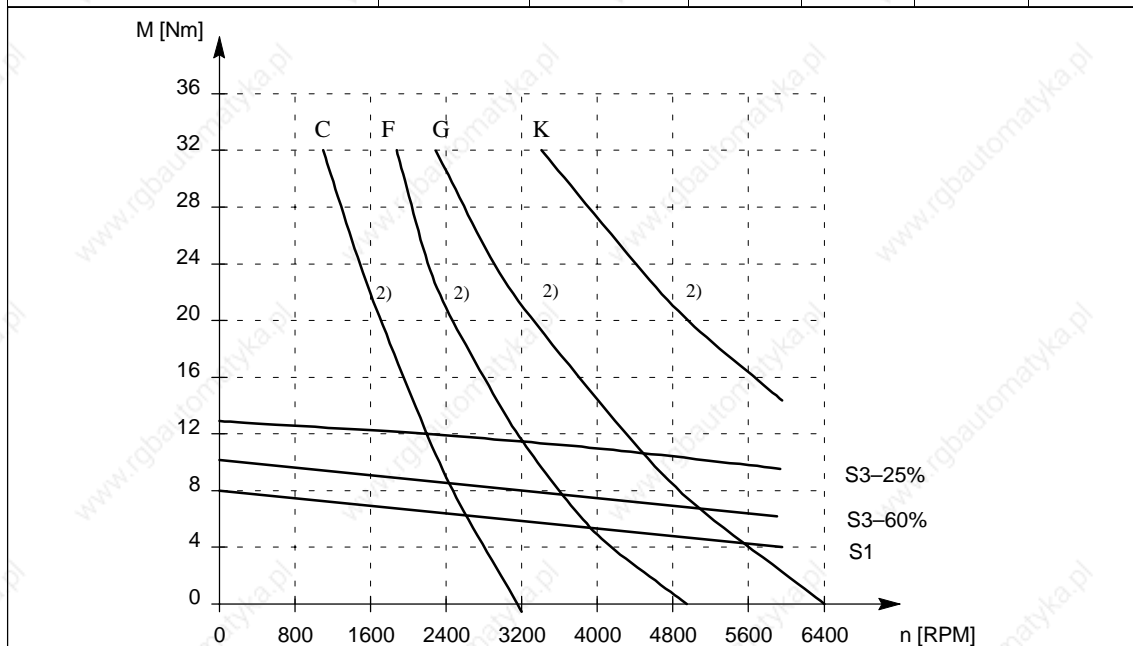

Fig. 2-8 Speed–torque diagram, 1FT5066

2) applies for a 600 V DC link voltage

2.1 Speed–torque diagrams

Table 2-9 Standard 1FT5072 motor

1FT5072						
Technical data	Code	Units	–□AC71	–□AF71	–□AG71	–□AK71
<b>Engineering data</b>						
Rated speed	$n_N$	RPM	2000	3000	4000	6000
Rated torque (100 K)	$M_N$ (100 K)	Nm	9.5	8.5	7.5	5.0
Rated current	$I_N$	A	6.3	8.4	9.8	9.9
Standstill torque (60 K)	$M_0$ (60 K)	Nm	10.0	10.0	10.0	10.0
Standstill torque (100 K)	$M_0$ (100 K)	Nm	12.0	12.0	12.0	12.0
Standstill current (60 K)	$I_0$ (60 K)	A	6.1	9.1	12.0	17.5
Standstill current (100 K)	$I_0$ (100 K)	A	7.3	11.0	14.5	21.0
Moment of inertia (with brake)	$J_{mot}$	$10^{-4}$ kgm <sup>2</sup>	30.3	30.3	30.3	30.3
Moment of inertia (without brake)	$J_{mot}$	$10^{-4}$ kgm <sup>2</sup>	22.8	22.8	22.8	22.8
<b>Limiting data</b>						
Maximum speed	$n_{max}$	RPM	3200	4800	6300	7000
Maximum torque	$M_{max}$	Nm	40	40	40	40
Max. current	$I_{max}$	A	29.0	43.0	60.0	89.0
Limiting torque	$M_{limit}$	Nm	15.0	16.0	18.0	16.0
<b>Physical constants</b>						
Torque constant	$k_T$	Nm/A	1.64	1.10	0.84	0.57
Voltage constant	$k_E$	V/1000 RPM	186	124	95	65
Winding resistance	$R_{ph.}$	Ohm	2.6	1.2	0.63	0.32
Rotating field inductance	$L_D$	mH	23.2	10.3	5.7	2.9
Electrical time constant	$T_{el}$	ms	11	11	11	11
Mechanical time constant	$T_{mech}$	ms	4.4	4.4	4.4	4.4
Thermal time constant	$T_{th}$	min	35	35	35	35
Weight (with brake)	$m$	kg	15	15	15	15
Weight (without brake)	$m$	kg	13.5	13.5	13.5	13.5

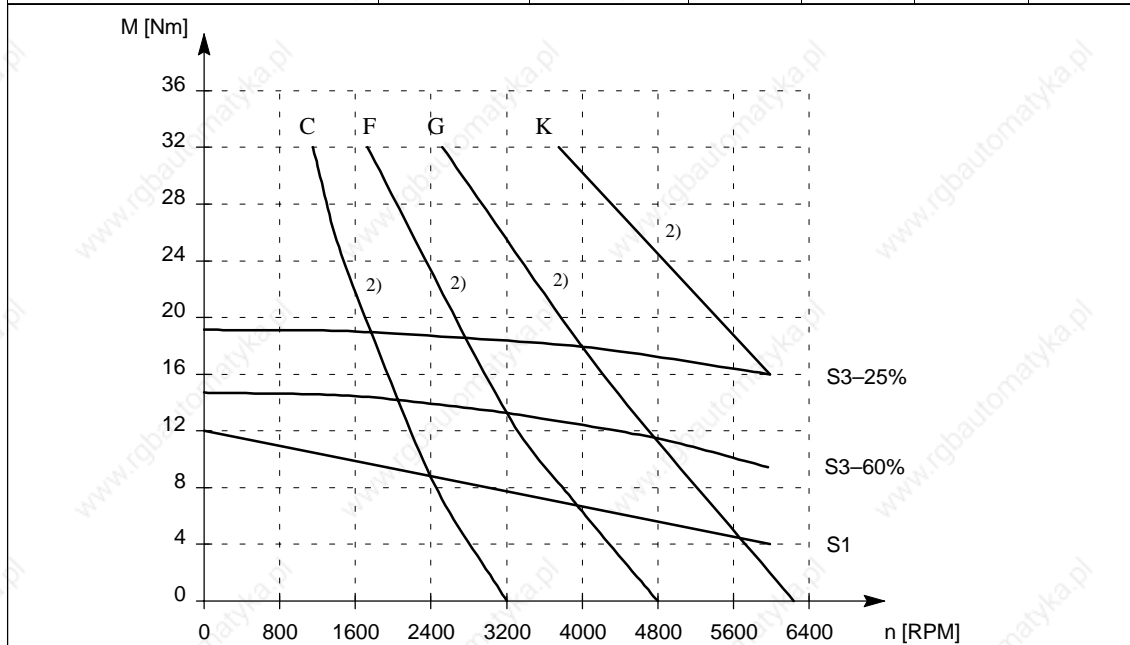

Fig. 2-9 Speed–torque diagram, 1FT5072

2) applies for a 600 V DC link voltage

## 2.1 Speed–torque diagrams

Table 2-10 Standard 1FT5074 motor

1FT5074						
Technical data	Code	Units	–□AC71	–□AF71	–□AG71	–□AK71
<b>Engineering data</b>						
Rated speed	$n_N$	RPM	2000	3000	4000	6000
Rated torque (100 K)	$M_N$ (100 K)	Nm	14.0	12.5	11.0	7.0
Rated current	$I_N$	A	9.3	13.0	14.0	14.1
Standstill torque (60 K)	$M_0$ (60 K)	Nm	14.0	14.0	14.0	14.0
Standstill torque (100 K)	$M_0$ (100 K)	Nm	18.0	18.0	18.0	18.0
Standstill current (60 K)	$I_0$ (60 K)	A	8.5	13.0	16.5	25.0
Standstill current (100 K)	$I_0$ (100 K)	A	11.0	17.0	21.5	32.0
Moment of inertia (with brake)	$J_{mot}$	$10^{-4}$ kgm <sup>2</sup>	44.2	44.2	44.2	44.2
Moment of inertia (without brake)	$J_{mot}$	$10^{-4}$ kgm <sup>2</sup>	36.7	36.7	36.7	36.7
<b>Limiting data</b>						
Maximum speed	$n_{max}$	RPM	3200	4900	6200	7000
Maximum torque	$M_{max}$	Nm	56	56	56	56
Max. current	$I_{max}$	A	45.0	67.0	90.0	104.0
Limiting torque	$M_{limit}$	Nm	24.0	24.5	24.5	22.5
<b>Physical constants</b>						
Torque constant	$k_T$	Nm/A	1.64	1.08	0.85	0.57
Voltage constant	$k_E$	V/1000 RPM	186	122	96	65
Winding resistance	$R_{ph.}$	Ohm	1.2	0.52	0.33	0.14
Rotating field inductance	$L_D$	mH	13.2	5.6	3.6	1.5
Electrical time constant	$T_{el}$	ms	11	11	11	11
Mechanical time constant	$T_{mech}$	ms	3.3	3.3	3.3	3.3
Thermal time constant	$T_{th}$	min	40	40	40	40
Weight (with brake)	$m$	kg	18.5	18.5	18.5	18.5
Weight (without brake)	$m$	kg	17.2	17.2	17.2	17.2

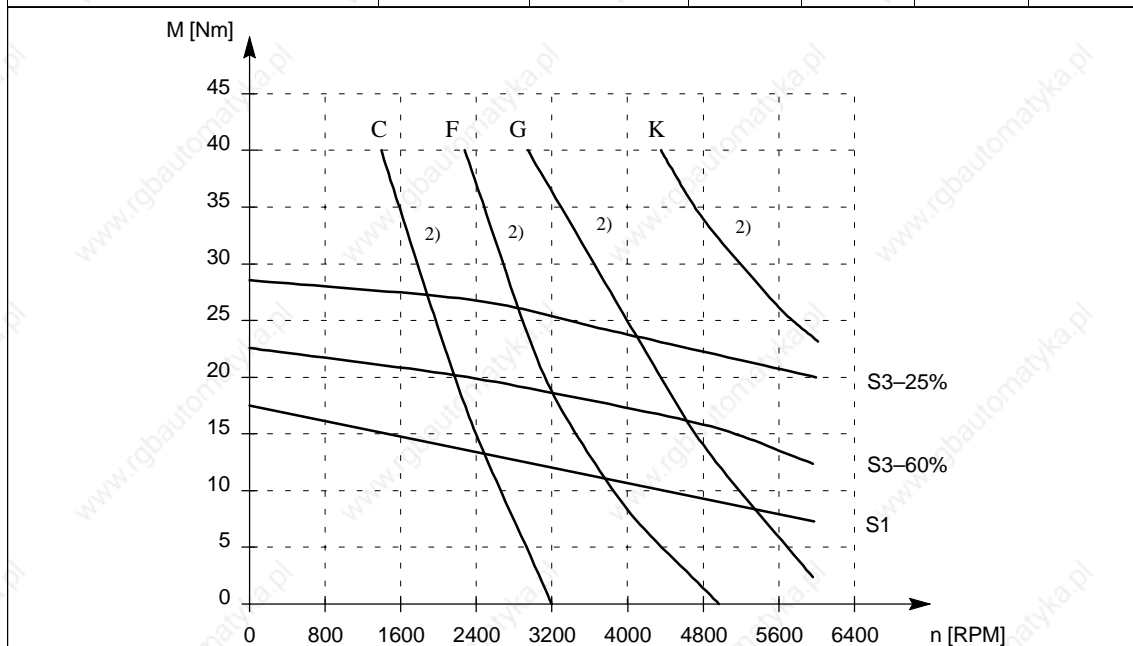

Fig. 2-10 Speed–torque diagram, 1FT5074

2) applies for a 600 V DC link voltage

2.1 Speed–torque diagrams

Table 2-11 Standard 1FT5076 motor

1FT5076						
Technical data	Code	Units	–□AC71	–□AF71	–□AG71	–□AK71
<b>Engineering data</b>						
Rated speed	$n_N$	RPM	2000	3000	4000	6000
Rated torque (100 K)	$M_N$ (100 K)	Nm	18.5	16.5	13.0	4.0
Rated current	$I_N$	A	12.0	16.0	17.0	9.0
Standstill torque (60 K)	$M_0$ (60 K)	Nm	18.0	18.0	18.0	18.0
Standstill torque (100 K)	$M_0$ (100 K)	Nm	22.0	22.0	22.0	22.0
Standstill current (60 K)	$I_0$ (60 K)	A	11.5	16.5	21.5	32.0
Standstill current (100 K)	$I_0$ (100 K)	A	13.5	20.0	26.0	39.0
Moment of inertia (with brake)	$J_{mot}$	$10^{-4}$ kgm <sup>2</sup>	58.4	58.4	58.4	58.4
Moment of inertia (without brake)	$J_{mot}$	$10^{-4}$ kgm <sup>2</sup>	50.9	50.9	50.9	50.9
<b>Limiting data</b>						
Maximum speed	$n_{max}$	RPM	3200	4800	6200	7000
Maximum torque	$M_{max}$	Nm	72	72	72	72
Max. current	$I_{max}$	A	52.0	78.0	110	163
Limiting torque	$M_{limit}$	Nm	39.0	38.0	36.0	36.0
<b>Physical constants</b>						
Torque constant	$k_T$	Nm/A	1.63	1.10	0.85	0.57
Voltage constant	$k_E$	V/1000 RPM	185	125	96	65
Winding resistance	$R_{ph.}$	Ohm	0.75	0.35	0.20	0.093
Rotating field inductance	$L_D$	mH	9.1	4.2	2.4	1.1
Electrical time constant	$T_{el}$	ms	12	12	12	12
Mechanical time constant	$T_{mech}$	ms	2.8	2.8	2.8	2.8
Thermal time constant	$T_{th}$	min	45	45	45	45
Weight (with brake)	$m$	kg	22.5	22.5	22.5	22.5
Weight (without brake)	$m$	kg	21	21	21	21

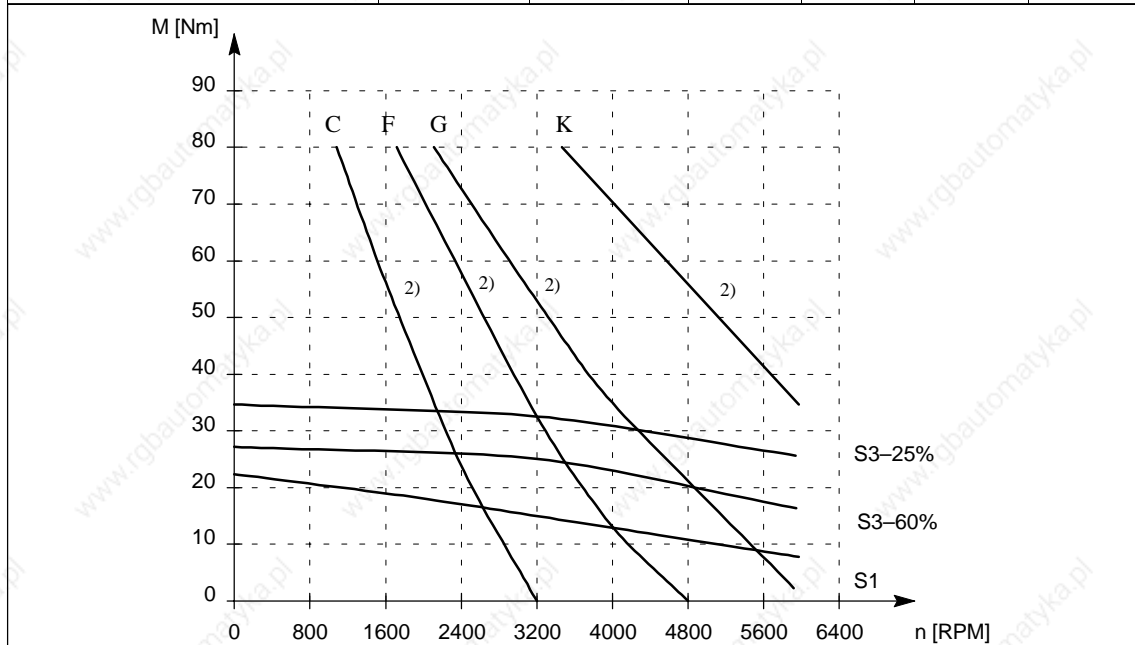

Fig. 2-11 Speed–torque diagram, 1FT5076

2) applies for a 600 V DC link voltage

## 2.1 Speed–torque diagrams

Table 2-12 Standard 1FT5102 motor

1FT5102						
Technical data	Code	Units	–□AA71	–□AC71	–□AF71	–0AG71
<b>Engineering data</b>						
Rated speed	$n_N$	RPM	1200	2000	3000	4000
Rated torque (100 K)	$M_N$ (100 K)	Nm	31.0	29.0	25.0	10.0
Rated current	$I_N$	A	12.0	19.0	25.0	13.0
Standstill torque (60 K)	$M_0$ (60 K)	Nm	27.0	27.0	27.0	27.0
Standstill torque (100 K)	$M_0$ (100 K)	Nm	33.0	33.0	33.0	33.0
Standstill current (60 K)	$I_0$ (60 K)	A	9.9	16.5	25.0	31.5
Standstill current (100 K)	$I_0$ (100 K)	A	12.5	20.5	31.0	38.5
Moment of inertia (with brake)	$J_{mot}$	$10^{-4}$ kgm <sup>2</sup>	151	151	151	151
Moment of inertia (without brake)	$J_{mot}$	$10^{-4}$ kgm <sup>2</sup>	136	136	136	136
<b>Limiting data</b>						
Maximum speed	$n_{max}$	RPM	1900	3200	4900	6200
Maximum torque	$M_{max}$	Nm	108	108	108	108
Max. current	$I_{max}$	A	47.0	80.0	120.0	164.0
Limiting torque	$M_{limit}$	Nm	52.0	57.0	57.0	45.0
<b>Physical constants</b>						
Torque constant	$k_T$	Nm/A	2.74	1.64	1.08	0.86
Voltage constant	$k_E$	V/1000 RPM	310	186	122	97
Winding resistance	$R_{ph}$	Ohm	0.9	0.33	0.14	0.097
Rotating field inductance	$L_D$	mH	14.2	5.2	2.2	1.4
Electrical time constant	$T_{el}$	ms	16	16	16	16
Mechanical time constant	$T_{mech}$	ms	3.3	3.3	3.3	3.3
Thermal time constant	$T_{th}$	min	45	45	45	45
Weight (with brake)	$m$	kg	36	36	36	36
Weight (without brake)	$m$	kg	31	31	31	31

Fig. 2-12 Speed–torque diagram, 1FT5102

1) applies for a 600 V DC link voltage

2.1 Speed–torque diagrams

Table 2-13 Standard 1FT5104 motor

1FT5104						
Technical data	Code	Units	–□AA71	–□AC71	–0AF71	
<b>Engineering data</b>						
Rated speed	$n_N$	RPM	1200	2000	3000	
Rated torque (100 K)	$M_N$ (100 K)	Nm	40.0	35.0	29.0	
Rated current	$I_N$	A	16.0	23.0	29.0	
Standstill torque (60 K)	$M_0$ (60 K)	Nm	37.0	37.0	37.0	
Standstill torque (100 K)	$M_0$ (100 K)	Nm	45.0	45.0	45.0	
Standstill current (60 K)	$I_0$ (60 K)	A	14.0	22.5	34.0	
Standstill current (100 K)	$I_0$ (100 K)	A	17.0	27.5	41.5	
Moment of inertia (with brake)	$J_{mot}$	$10^{-4}$ kgm <sup>2</sup>	210	210	210	
Moment of inertia (without brake)	$J_{mot}$	$10^{-4}$ kgm <sup>2</sup>	185	185	185	
<b>Limiting data</b>						
Maximum speed	$n_{max}$	RPM	1900	3200	4800	
Maximum torque	$M_{max}$	Nm	148	148	148	
Max. current	$I_{max}$	A	64.0	110.0	164.0	
Limiting torque	$M_{limit}$	Nm	80.0	78.0	80.0	
<b>Physical constants</b>						
Torque constant	$k_T$	Nm/A	2.72	1.66	1.09	
Voltage constant	$k_E$	V/1000 RPM	308	188	123	
Winding resistance	$R_{ph.}$	Ohm	0.56	0.2	0.095	
Rotating field inductance	$L_D$	mH	9.5	3.5	1.7	
Electrical time constant	$T_{el}$	ms	18	18	18	
Mechanical time constant	$T_{mech}$	ms	2.8	2.8	2.8	
Thermal time constant	$T_{th}$	min	50	50	50	
Weight (with brake)	$m$	kg	43	43	43	
Weight (without brake)	$m$	kg	39	39	39	

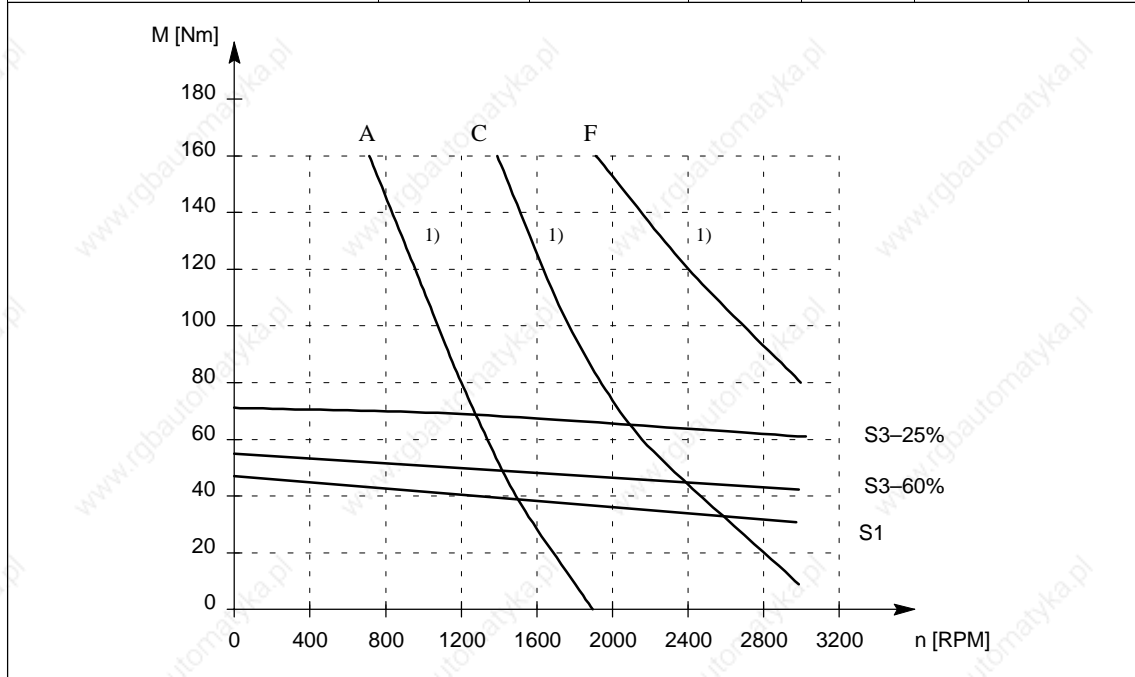

Fig. 2-13 Speed–torque diagram, 1FT5104

1) applies for a 600 V DC link voltage



## 2.1 Speed–torque diagrams

Table 2-14 Standard 1FT5106 motor

1FT5106						
Technical data	Code	Units	–0AA71	–□AC71	–0AF71	
<b>Engineering data</b>						
Rated speed	$n_N$	RPM	1200	2000	3000	
Rated torque (100 K)	$M_N$ (100 K)	Nm	47.0	39.0	28.0	
Rated current	$I_N$	A	19.0	25.0	29.0	
Standstill torque (60 K)	$M_0$ (60 K)	Nm	45.0	45.0	45.0	
Standstill torque (100 K)	$M_0$ (100 K)	Nm	55.0	55.0	55.0	
Standstill current (60 K)	$I_0$ (60 K)	A	17.0	26.8	42.5	
Standstill current (100 K)	$I_0$ (100 K)	A	20.5	33.0	52.0	
Moment of inertia (with brake)	$J_{mot}$	$10^{-4}$ kgm <sup>2</sup>	264	264	264	
Moment of inertia (without brake)	$J_{mot}$	$10^{-4}$ kgm <sup>2</sup>	239	239	239	
<b>Limiting data</b>						
Maximum speed	$n_{max}$	RPM	1900	3200	5000	
Maximum torque	$M_{max}$	Nm	180	180	180	
Max. current	$I_{max}$	A	80.0	130.0	200.0	
Limiting torque	$M_{limit}$	Nm	90.0	98.0	102.0	
<b>Physical constants</b>						
Torque constant	$k_T$	Nm/A	2.72	1.68	1.06	
Voltage constant	$k_E$	V/1000 RPM	308	190	120	
Winding resistance	$R_{ph.}$	Ohm	0.39	0.15	0.066	
Rotating field inductance	$L_D$	mH	7.4	2.9	1.2	
Electrical time constant	$T_{el}$	ms	19	19	19	
Mechanical time constant	$T_{mech}$	ms	2.5	2.5	2.5	
Thermal time constant	$T_{th}$	min	50	50	50	
Weight (with brake)	$m$	kg	49	49	49	
Weight (without brake)	$m$	kg	45	45	45	

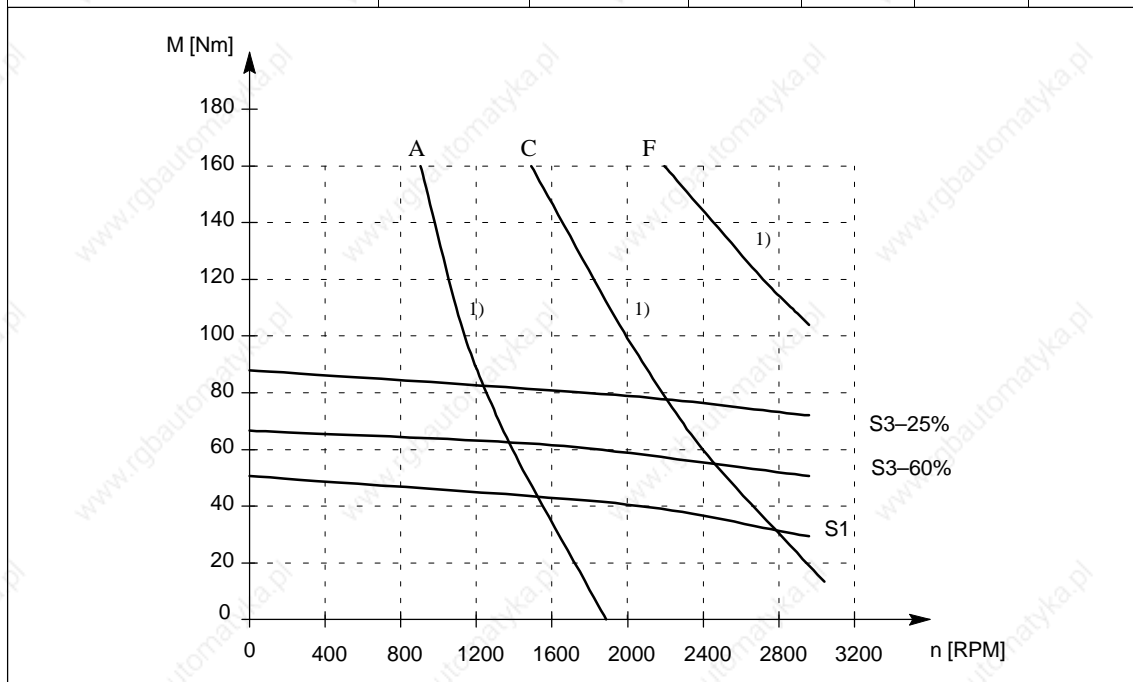

Fig. 2-14 Speed–torque diagram, 1FT5106

1) applies for a 600 V DC link voltage

2.1 Speed–torque diagrams

Table 2-15 Standard 1FT5108 motor

1FT5108						
Technical data	Code	Units	–0AA71	–□AC71	–0AF71	
<b>Engineering data</b>						
Rated speed	$n_N$	RPM	1200	2000	3000	
Rated torque (100 K)	$M_N$ (100 K)	Nm	55.0	42.5	20.0	
Rated current	$I_N$	A	22.0	27.0	21.0	
Standstill torque (60 K)	$M_0$ (60 K)	Nm	55.0	55.0	55.0	
Standstill torque (100 K)	$M_0$ (100 K)	Nm	68.0	68.0	68.0	
Standstill current (60 K)	$I_0$ (60 K)	A	20.5	32.5	50.5	
Standstill current (100 K)	$I_0$ (100 K)	A	25.5	40.0	62.5	
Moment of inertia (with brake)	$J_{mot}$	$10^{-4}$ kgm <sup>2</sup>	315	315	315	
Moment of inertia (without brake)	$J_{mot}$	$10^{-4}$ kgm <sup>2</sup>	290	290	290	
<b>Limiting data</b>						
Maximum speed	$n_{max}$	RPM	2000	3100	4900	
Maximum torque	$M_{max}$	Nm	220	220	220	
Max. current	$I_{max}$	A	95.0	164.0	247.0	
Limiting torque	$M_{limit}$	Nm	120.0	120.0	125.0	
<b>Physical constants</b>						
Torque constant	$k_T$	Nm/A	2.70	1.70	1.09	
Voltage constant	$k_E$	V/1000 RPM	306	192	123	
Winding resistance	$R_{ph.}$	Ohm	0.29	0.13	0.054	
Rotating field inductance	$L_D$	mH	5.8	2.5	1.0	
Electrical time constant	$T_{el}$	ms	19	19	19	
Mechanical time constant	$T_{mech}$	ms	2.4	2.4	2.4	
Thermal time constant	$T_{th}$	min	55	55	55	
Weight (with brake)	$m$	kg	55	55	55	
Weight (without brake)	$m$	kg	51	51	51	

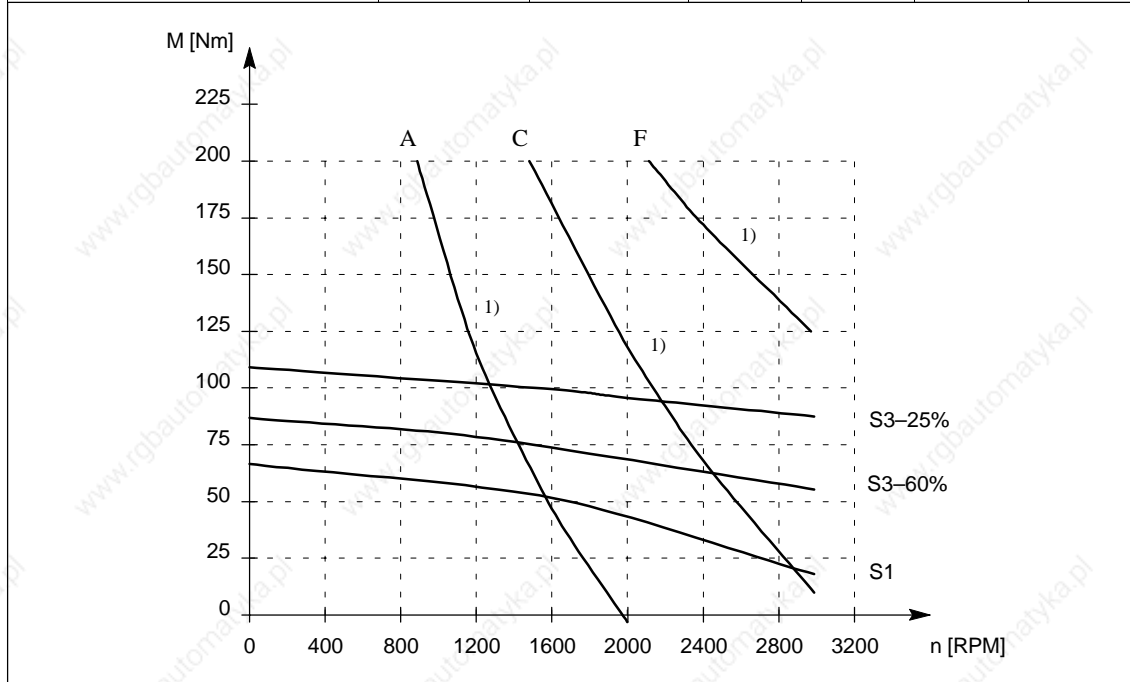

Fig. 2-15 Speed–torque diagram, 1FT5108

1) applies for a 600 V DC link voltage

## 2.1 Speed–torque diagrams

Table 2-16 Standard 1FT5132 motor

1FT5132						
Technical data	Code	Units	–0AA71	–0AC71	–0AF71	
<b>Engineering data</b>						
Rated speed	$n_N$	RPM	1200	2000	3000	
Rated torque (100 K)	$M_N$ (100 K)	Nm	55.0	45.0	30.0	
Rated current	$I_N$	A	22.0	29.0	27.0	
Standstill torque (60 K)	$M_0$ (60 K)	Nm	60.0	60.0	60.0	
Standstill torque (100 K)	$M_0$ (100 K)	Nm	75.0	75.0	75.0	
Standstill current (60 K)	$I_0$ (60 K)	A	22.5	35.5	47.5	
Standstill current (100 K)	$I_0$ (100 K)	A	28.0	44.0	59.0	
Moment of inertia (with brake)	$J_{mot}$	$10^{-4}$ kgm <sup>2</sup>	539	539	539	
Moment of inertia (without brake)	$J_{mot}$	$10^{-4}$ kgm <sup>2</sup>	464	464	464	
<b>Limiting data</b>						
Maximum speed	$n_{max}$	RPM	2000	3100	3200	
Maximum torque	$M_{max}$	Nm	240	240	240	
Max. current	$I_{max}$	A	112.0	186.0	236.0	
Limiting torque	$M_{limit}$	Nm	129.0	115.0	112.0	
<b>Physical constants</b>						
Torque constant	$k_T$	Nm/A	2.70	1.71	1.27	
Voltage constant	$k_E$	V/1000 RPM	306	194	144	
Winding resistance	$R_{ph.}$	Ohm	0.28	0.10	0.062	
Rotating field inductance	$L_D$	mH	6.4	2.3	1.4	
Electrical time constant	$T_{el}$	ms	23	23	23	
Mechanical time constant	$T_{mech}$	ms	3.3	3.3	3.3	
Thermal time constant	$T_{th}$	min	80	80	80	
Weight (with brake)	$m$	kg	82	82	82	
Weight (without brake)	$m$	kg	75	75	75	

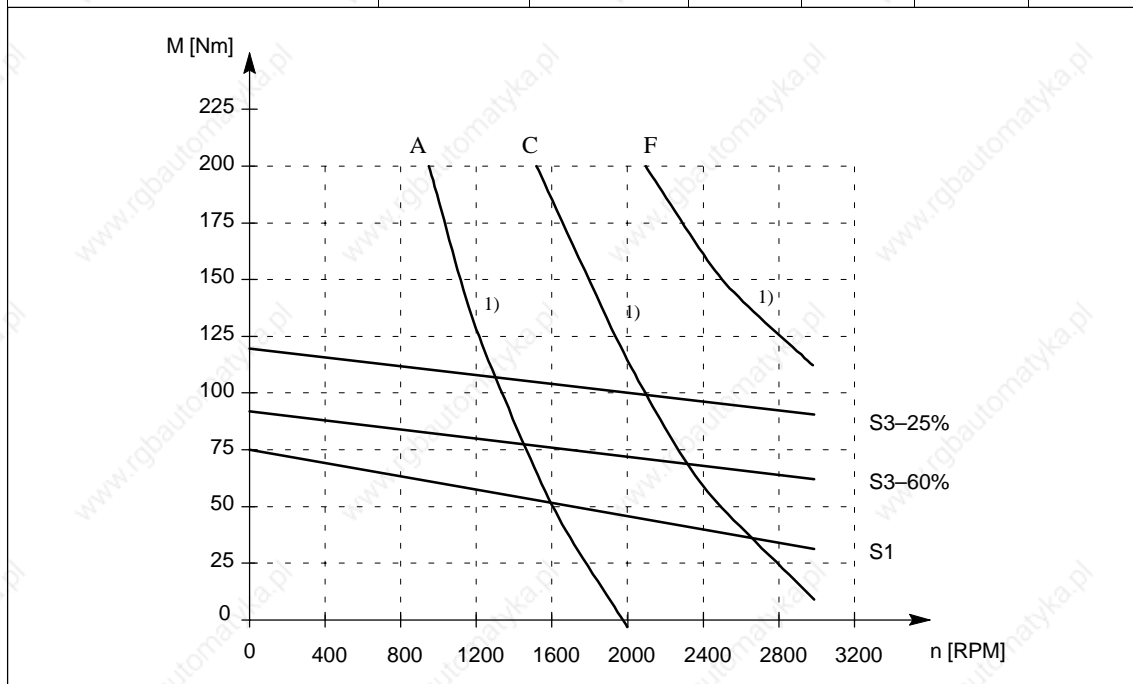

Fig. 2-16 Speed–torque diagram, 1FT5132

1) applies for a 600 V DC link voltage

2.1 Speed–torque diagrams

Table 2-17 Standard 1FT5134 motor

1FT5134					
Technical data	Code	Units	–0AA71	–0AC71	
<b>Engineering data</b>					
Rated speed	$n_N$	RPM	1200	2000	
Rated torque (100 K)	$M_N$ (100 K)	Nm	65.0	50.0	
Rated current	$I_N$	A	26.0	34.0	
Standstill torque (60 K)	$M_0$ (60 K)	Nm	75.0	75.0	
Standstill torque (100 K)	$M_0$ (100 K)	Nm	90.0	90.0	
Standstill current (60 K)	$I_0$ (60 K)	A	28.0	47.0	
Standstill current (100 K)	$I_0$ (100 K)	A	33.5	56.0	
Moment of inertia (with brake)	$J_{mot}$	$10^{-4}$ kgm <sup>2</sup>	665	665	
Moment of inertia (without brake)	$J_{mot}$	$10^{-4}$ kgm <sup>2</sup>	590	590	
<b>Limiting data</b>					
Maximum speed	$n_{max}$	RPM	2000	3200	
Maximum torque	$M_{max}$	Nm	300	300	
Max. current	$I_{max}$	A	134.0	222.0	
Limiting torque	$M_{limit}$	Nm	164.0	156.0	
<b>Physical constants</b>					
Torque constant	$k_T$	Nm/A	2.70	1.61	
Voltage constant	$k_E$	V/1000 RPM	306	182	
Winding resistance	$R_{ph.}$	Ohm	0.19	0.073	
Rotating field inductance	$L_D$	mH	4.8	1.8	
Electrical time constant	$T_{el}$	ms	25	25	
Mechanical time constant	$T_{mech}$	ms	3.1	3.1	
Thermal time constant	$T_{th}$	min	85	85	
Weight (with brake)	$m$	kg	102	102	
Weight (without brake)	$m$	kg	95	95	

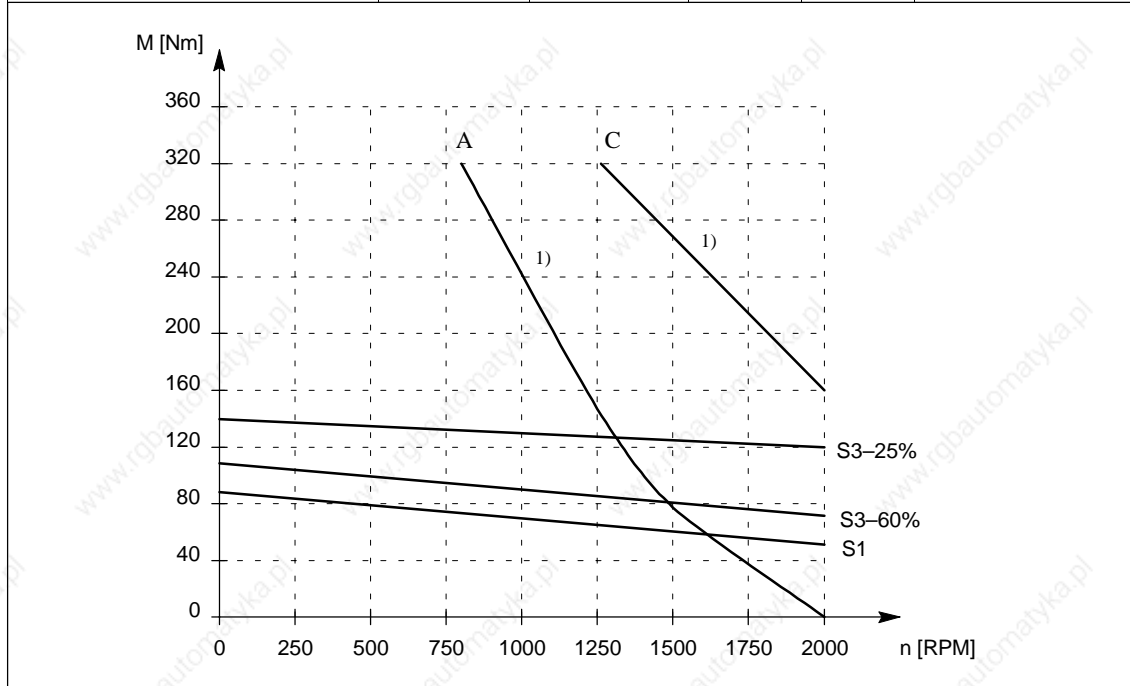

Fig. 2-17 Speed–torque diagram, 1FT5134

1) applies for a 600 V DC link voltage

## 2.1 Speed–torque diagrams

Table 2-18 Standard 1FT5136 motor

1FT5136					
Technical data	Code	Units	–0AA71	–0AC71	
<b>Engineering data</b>					
Rated speed	$n_N$	RPM	1200	2000	
Rated torque (100 K)	$M_N$ (100 K)	Nm	82.0	60.0	
Rated current	$I_N$	A	33.0	37.0	
Standstill torque (60 K)	$M_0$ (60 K)	Nm	85.0	85.0	
Standstill torque (100 K)	$M_0$ (100 K)	Nm	105.0	105.0	
Standstill current (60 K)	$I_0$ (60 K)	A	31.5	47.5	
Standstill current (100 K)	$I_0$ (100 K)	A	39.0	59.0	
Moment of inertia (with brake)	$J_{mot}$	$10^{-4}$ kgm <sup>2</sup>	791	791	
Moment of inertia (without brake)	$J_{mot}$	$10^{-4}$ kgm <sup>2</sup>	716	716	
<b>Limiting data</b>					
Maximum speed	$n_{max}$	RPM	1900	2900	
Maximum torque	$M_{max}$	Nm	340	340	
Max. current	$I_{max}$	A	156.0	234.0	
Limiting torque	$M_{limit}$	Nm	180.0	170.0	
<b>Physical constants</b>					
Torque constant	$k_T$	Nm/A	2.70	1.79	
Voltage constant	$k_E$	V/1000 RPM	306	203	
Winding resistance	$R_{ph.}$	Ohm	0.14	0.063	
Rotating field inductance	$L_D$	mH	3.8	1.7	
Electrical time constant	$T_{el}$	ms	27	27	
Mechanical time constant	$T_{mech}$	ms	2.8	2.8	
Thermal time constant	$T_{th}$	min	90	90	
Weight (with brake)	$m$	kg	122	122	
Weight (without brake)	$m$	kg	115	115	

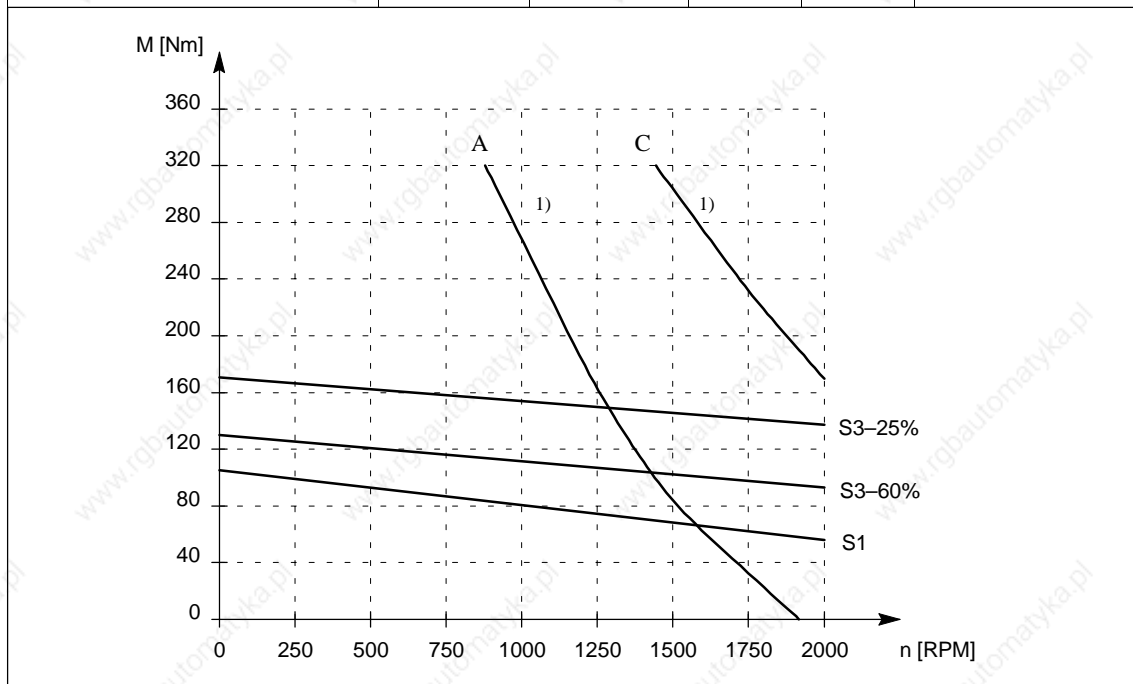

Fig. 2-18 Speed–torque diagram, 1FT5136

1) applies for a 600 V DC link voltage

2.1 Speed–torque diagrams

Table 2-19 Standard 1FT5138 motor

1FT5138				
Technical data	Code	Units	-0AA71	
<b>Engineering data</b>				
Rated speed	$n_N$	RPM	1200	
Rated torque (100 K)	$M_N$ (100 K)	Nm	100.0	
Rated current	$I_N$	A	40.0	
Standstill torque (60 K)	$M_0$ (60 K)	Nm	105.0	
Standstill torque (100 K)	$M_0$ (100 K)	Nm	130.0	
Standstill current (60 K)	$I_0$ (60 K)	A	39.0	
Standstill current (100 K)	$I_0$ (100 K)	A	48.5	
Moment of inertia (with brake)	$J_{mot}$	$10^{-4}$ kgm <sup>2</sup>	980	
Moment of inertia (without brake)	$J_{mot}$	$10^{-4}$ kgm <sup>2</sup>	905	
<b>Limiting data</b>				
Maximum speed	$n_{max}$	RPM	2000	
Maximum torque	$M_{max}$	Nm	420	
Max. current	$I_{max}$	A	194.0	
Limiting torque	$M_{limit}$	Nm	220.0	
<b>Physical constants</b>				
Torque constant	$k_T$	Nm/A	2.70	
Voltage constant	$k_E$	V/1000 RPM	306	
Winding resistance	$R_{ph.}$	Ohm	0.11	
Rotating field inductance	$L_D$	mH	3.2	
Electrical time constant	$T_{el}$	ms	29	
Mechanical time constant	$T_{mech}$	ms	2.7	
Thermal time constant	$T_{th}$	min	100	
Weight (with brake)	$m$	kg	152	
Weight (without brake)	$m$	kg	145	

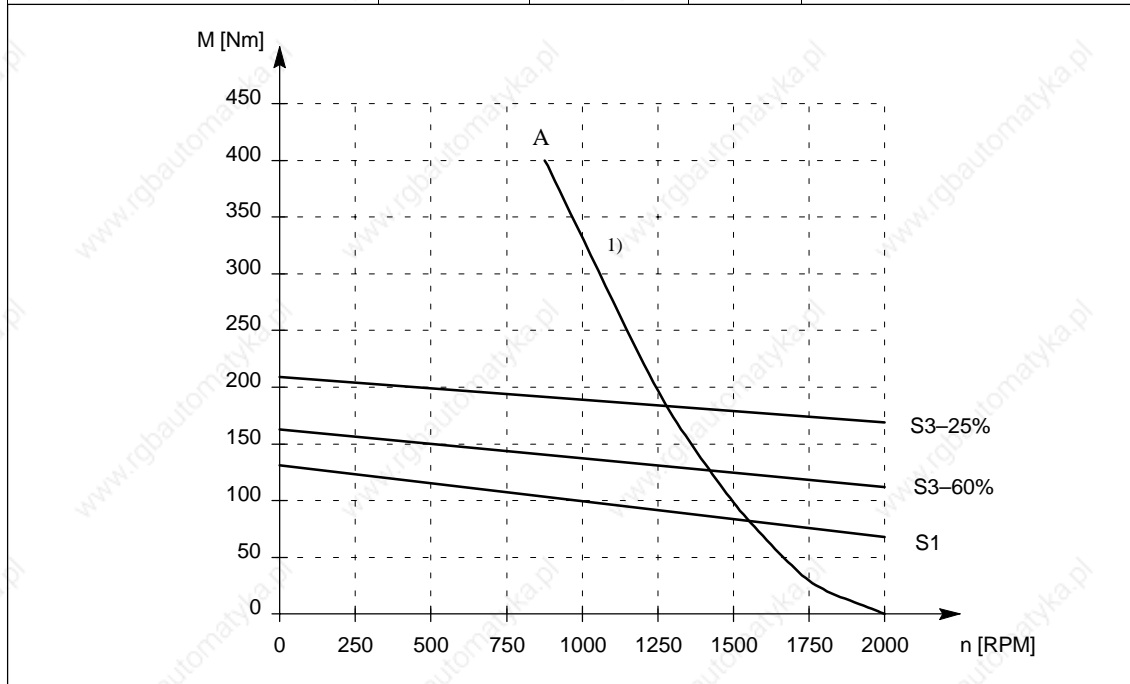

Fig. 2-19 Speed–torque diagram, 1FT5138

1) applies for a 600 V DC link voltage

## 2.1 Speed–torque diagrams

Table 2-20 Standard 1FT5074 motor, force ventilated

1FT5074					
Technical data	Code	Units	–0SG71	–0SK71	
<b>Engineering data</b>					
Rated speed	$n_N$	RPM	4000	6000	
Rated torque (100 K)	$M_N$ (100 K)	Nm	17.0	12.0	
Rated current	$I_N$	A	22.0	23.0	
Standstill torque (60 K)	$M_0$ (60 K)	Nm	16.0	16.0	
Standstill torque (100 K)	$M_0$ (100 K)	Nm	20.5	20.5	
Standstill current (60 K)	$I_0$ (60 K)	A	19.0	28.0	
Standstill current (100 K)	$I_0$ (100 K)	A	24.5	36.0	
Moment of inertia (with brake)	$J_{mot}$	$10^{-4}$ kgm <sup>2</sup>	44.2	44.2	
Moment of inertia (without brake)	$J_{mot}$	$10^{-4}$ kgm <sup>2</sup>	36.7	36.7	
<b>Limiting data</b>					
Maximum speed	$n_{max}$	RPM	6200	7000	
Maximum torque	$M_{max}$	Nm	56	56	
Max. current	$I_{max}$	A	90.0	104.0	
Limiting torque	$M_{limit}$	Nm	24.5	22.5	
<b>Physical constants</b>					
Torque constant	$k_T$	Nm/A	0.85	0.57	
Voltage constant	$k_E$	V/1000 RPM	96	65	
Winding resistance	$R_{ph.}$	Ohm	0.33	0.14	
Rotating field inductance	$L_D$	mH	3.6	1.5	
Electrical time constant	$T_{el}$	ms	11	11	
Mechanical time constant	$T_{mech}$	ms	3.0	3.0	
Thermal time constant	$T_{th}$	min	40	40	
Weight (with brake)	$m$	kg	23.5	23.5	
Weight (without brake)	$m$	kg	22	22	

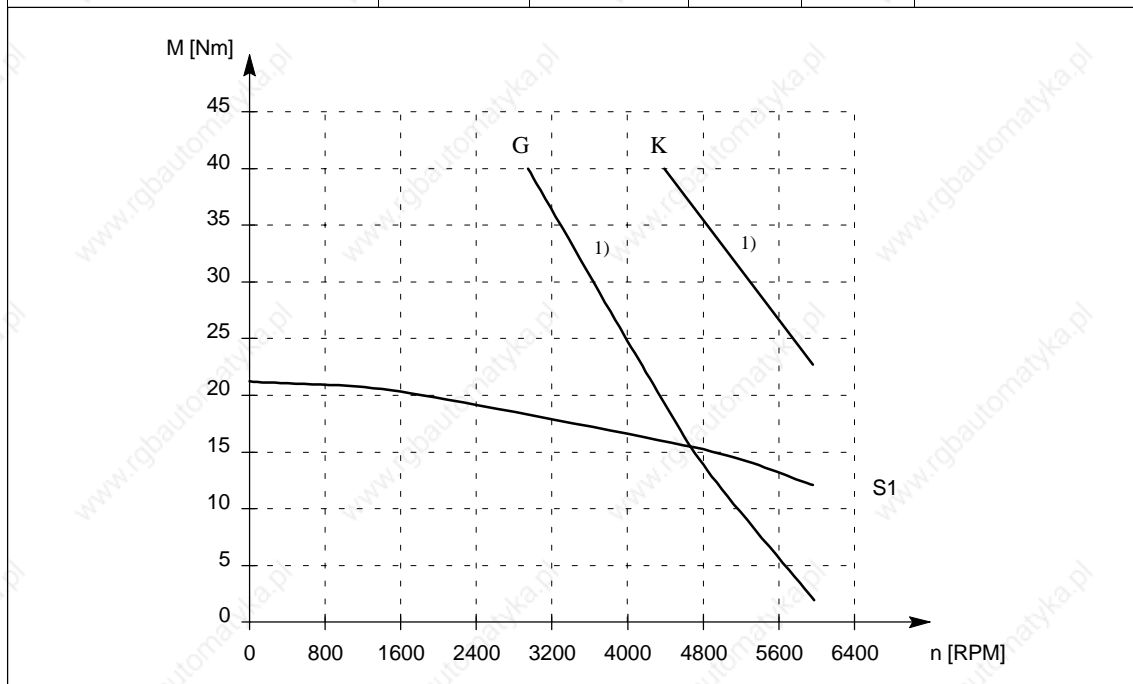

Fig. 2-20 Speed–torque diagram, 1FT5074, force ventilated

1) applies for a 600 V DC link voltage

2.1 Speed–torque diagrams

Table 2-21 Standard 1FT5076 motor, force ventilated

1FT5076					
Technical data	Code	Units	–0SG71	–0SK71	
Engineering data					
Rated speed	$n_N$	RPM	4000	6000	
Rated torque (100 K)	$M_N$ (100 K)	Nm	21.0	15.0	
Rated current	$I_N$	A	27.0	29.0	
Standstill torque (60 K)	$M_0$ (60 K)	Nm	20.5	20.5	
Standstill torque (100 K)	$M_0$ (100 K)	Nm	26.0	26.0	
Standstill current (60 K)	$I_0$ (60 K)	A	24.5	36.0	
Standstill current (100 K)	$I_0$ (100 K)	A	31.0	46.0	
Moment of inertia (with brake)	$J_{mot}$	$10^{-4}$ kgm <sup>2</sup>	58.4	58.4	
Moment of inertia (without brake)	$J_{mot}$	$10^{-4}$ kgm <sup>2</sup>	50.9	50.9	
Limiting data					
Maximum speed	$n_{max}$	RPM	6200	7000	
Maximum torque	$M_{max}$	Nm	72	72	
Max. current	$I_{max}$	A	110.0	163.0	
Limiting torque	$M_{limit}$	Nm	36.0	36.0	
Physical constants					
Torque constant	$k_T$	Nm/A	0.85	0.57	
Voltage constant	$k_E$	V/1000 RPM	96	65	
Winding resistance	$R_{ph.}$	Ohm	0.20	0.093	
Rotating field inductance	$L_D$	mH	2.4	1.1	
Electrical time constant	$T_{el}$	ms	12	12	
Mechanical time constant	$T_{mech}$	ms	2.9	2.9	
Thermal time constant	$T_{th}$	min	45	45	
Weight (with brake)	$m$	kg	27.5	27.5	
Weight (without brake)	$m$	kg	26	26	

Fig. 2-21 Speed–torque diagram, 1FT5076, force ventilated

1) applies for a 600 V DC link voltage



## 2.1 Speed–torque diagrams

Table 2-22 Standard 1FT5102 motor, force ventilated

1FT5102					
Technical data	Code	Units	–0SF71	–0SG71	
<b>Engineering data</b>					
Rated speed	$n_N$	RPM	3000	4000	
Rated torque (100 K)	$M_N$ (100 K)	Nm	36.0	32.0	
Rated current	$I_N$	A	36.0	40.0	
Standstill torque (60 K)	$M_0$ (60 K)	Nm	34.0	34.0	
Standstill torque (100 K)	$M_0$ (100 K)	Nm	40.0	40.0	
Standstill current (60 K)	$I_0$ (60 K)	A	31.5	39.5	
Standstill current (100 K)	$I_0$ (100 K)	A	37.0	46.5	
Moment of inertia (with brake)	$J_{mot}$	$10^{-4}$ kgm <sup>2</sup>	161	161	
Moment of inertia (without brake)	$J_{mot}$	$10^{-4}$ kgm <sup>2</sup>	136	136	
<b>Limiting data</b>					
Maximum speed	$n_{max}$	RPM	4900	6200	
Maximum torque	$M_{max}$	Nm	108	108	
Max. current	$I_{max}$	A	120.0	164.0	
Limiting torque	$M_{limit}$	Nm	57.0	45.0	
<b>Physical constants</b>					
Torque constant	$k_T$	Nm/A	1.08	0.86	
Voltage constant	$k_E$	V/1000 RPM	122	97	
Winding resistance	$R_{ph.}$	Ohm	0.14	0.097	
Rotating field inductance	$L_D$	mH	2.2	1.4	
Electrical time constant	$T_{el}$	ms	16	16	
Mechanical time constant	$T_{mech}$	ms	3.5	3.5	
Thermal time constant	$T_{th}$	min	45	45	
Weight (with brake)	$m$	kg	39	39	
Weight (without brake)	$m$	kg	35	35	

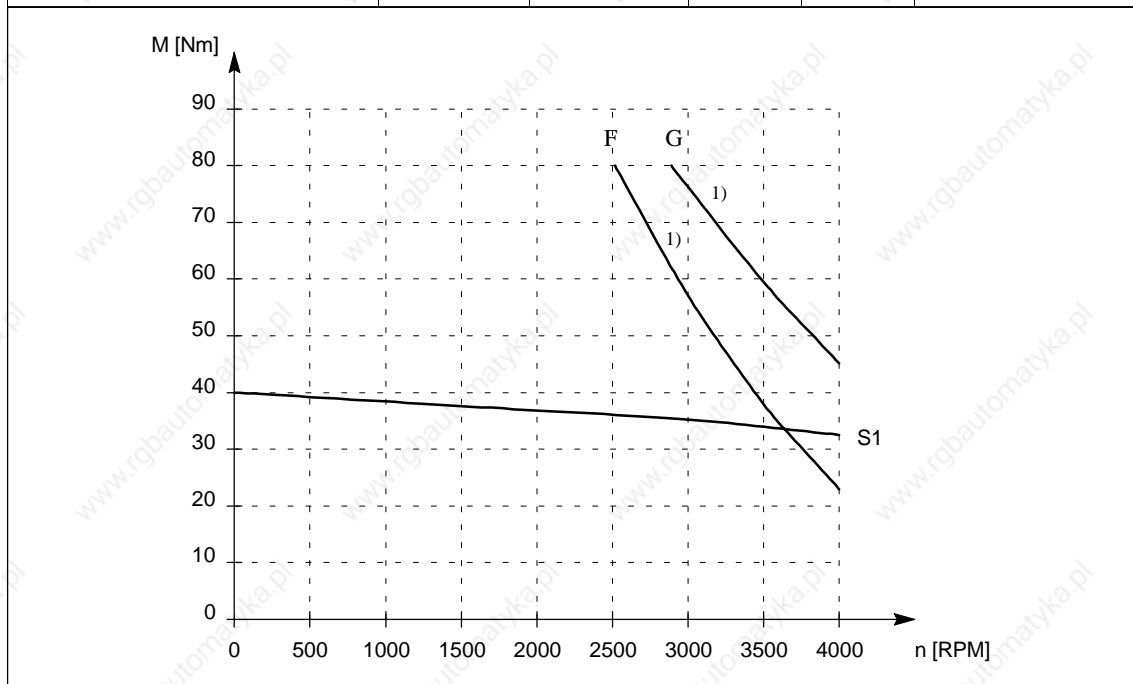

Fig. 2-22 Speed–torque diagram, 1FT5102, force ventilated

1) applies for a 600 V DC link voltage

2.1 Speed–torque diagrams

Table 2-23 Standard 1FT5104 motor, force ventilated

1FT5104				
Technical data	Code	Units	–□SF71	
<b>Engineering data</b>				
Rated speed	$n_N$	RPM	3000	
Rated torque (100 K)	$M_N$ (100 K)	Nm	45.0	
Rated current	$I_N$	A	45.0	
Standstill torque (60 K)	$M_0$ (60 K)	Nm	48.0	
Standstill torque (100 K)	$M_0$ (100 K)	Nm	58.0	
Standstill current (60 K)	$I_0$ (60 K)	A	44.0	
Standstill current (100 K)	$I_0$ (100 K)	A	53.0	
Moment of inertia (with brake)	$J_{mot}$	$10^{-4}$ kgm <sup>2</sup>	210	
Moment of inertia (without brake)	$J_{mot}$	$10^{-4}$ kgm <sup>2</sup>	185	
<b>Limiting data</b>				
Maximum speed	$n_{max}$	RPM	4800	
Maximum torque	$M_{max}$	Nm	148	
Max. current	$I_{max}$	A	164.0	
Limiting torque	$M_{limit}$	Nm	80.0	
<b>Physical constants</b>				
Torque constant	$k_T$	Nm/A	1.09	
Voltage constant	$k_E$	V/1000 RPM	123	
Winding resistance	$R_{ph.}$	Ohm	0.095	
Rotating field inductance	$L_D$	mH	1.7	
Electrical time constant	$T_{el}$	ms	18	
Mechanical time constant	$T_{mech}$	ms	3.0	
Thermal time constant	$T_{th}$	min	50	
Weight (with brake)	$m$	kg	47	
Weight (without brake)	$m$	kg	43	

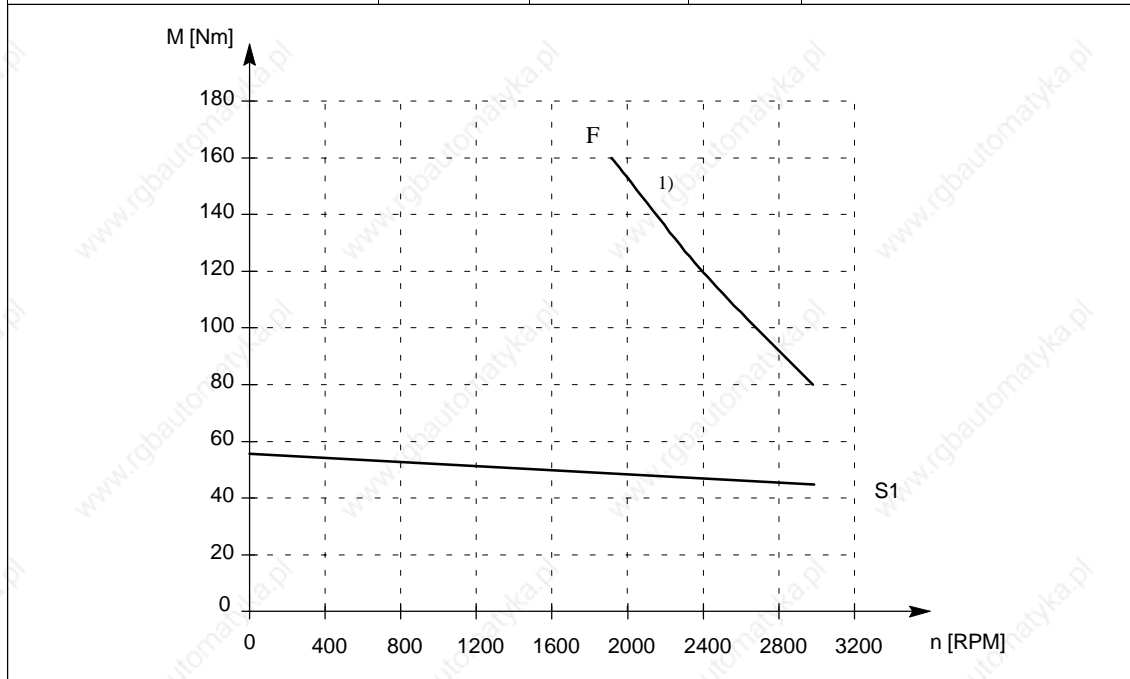

Fig. 2-23 Speed–torque diagram, 1FT5104, force ventilated

1) applies for a 600 V DC link voltage

## 2.1 Speed–torque diagrams

Table 2-24 Standard 1FT5106 motor, force ventilated

1FT5106				
Technical data	Code	Units	–□SF71	
<b>Engineering data</b>				
Rated speed	$n_N$	RPM	3000	
Rated torque (100 K)	$M_N$ (100 K)	Nm	58.0	
Rated current	$I_N$	A	59.0	
Standstill torque (60 K)	$M_0$ (60 K)	Nm	57.0	
Standstill torque (100 K)	$M_0$ (100 K)	Nm	70.0	
Standstill current (60 K)	$I_0$ (60 K)	A	54.0	
Standstill current (100 K)	$I_0$ (100 K)	A	66.0	
Moment of inertia (with brake)	$J_{mot}$	$10^{-4}$ kgm <sup>2</sup>	264	
Moment of inertia (without brake)	$J_{mot}$	$10^{-4}$ kgm <sup>2</sup>	239	
<b>Limiting data</b>				
Maximum speed	$n_{max}$	RPM	5000	
Maximum torque	$M_{max}$	Nm	180	
Max. current	$I_{max}$	A	200.0	
Limiting torque	$M_{limit}$	Nm	102.0	
<b>Physical constants</b>				
Torque constant	$k_T$	Nm/A	1.06	
Voltage constant	$k_E$	V/1000 RPM	120	
Winding resistance	$R_{ph.}$	Ohm	0.066	
Rotating field inductance	$L_D$	mH	1.2	
Electrical time constant	$T_{el}$	ms	19	
Mechanical time constant	$T_{mech}$	ms	2.8	
Thermal time constant	$T_{th}$	min	50	
Weight (with brake)	$m$	kg	53	
Weight (without brake)	$m$	kg	49	

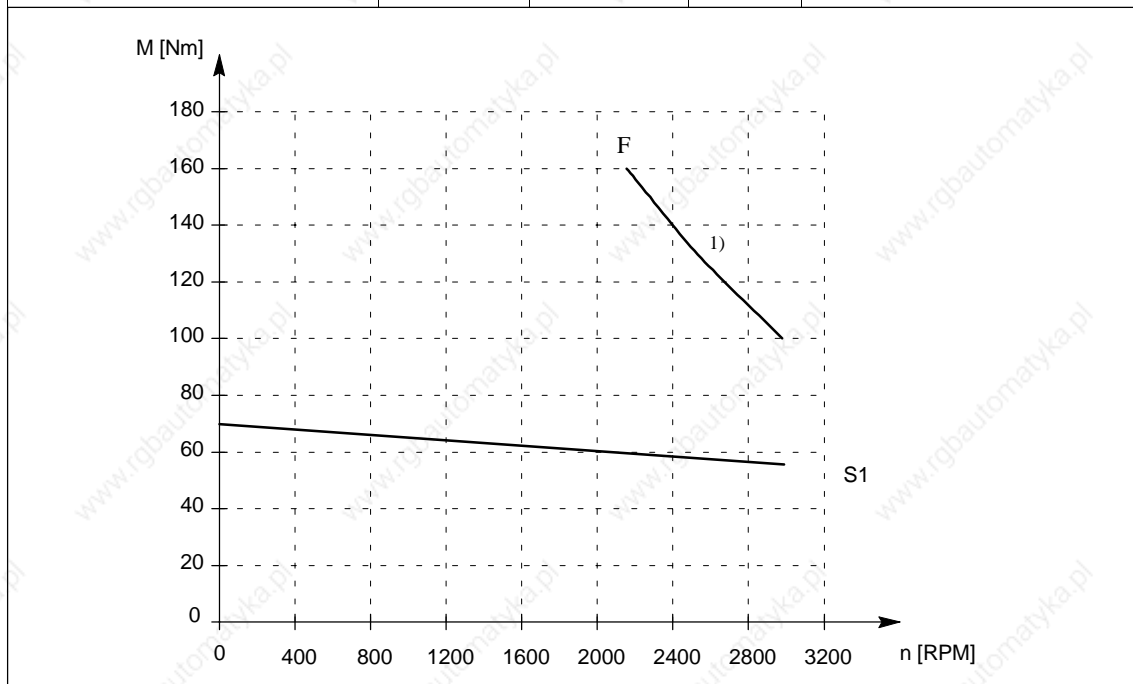

Fig. 2-24 Speed–torque diagram, 1FT5106, force ventilated

1) applies for a 600 V DC link voltage

2.1 Speed–torque diagrams

Table 2-25 Standard 1FT5132 motor, force ventilated

1FT5132						
Technical data	Code	Units	–0SA71	–0SC71	–0SF71	
<b>Engineering data</b>						
Rated speed	$n_N$	RPM	1200	2000	3000	
Rated torque (100 K)	$M_N$ (100 K)	Nm	85.0	80.0	75.0	
Rated current	$I_N$	A	34.0	50.0	64.0	
Standstill torque (60 K)	$M_0$ (60 K)	Nm	70.0	70.0	70.0	
Standstill torque (100 K)	$M_0$ (100 K)	Nm	95.0	95.0	95.0	
Standstill current (60 K)	$I_0$ (60 K)	A	26.0	41.0	55.5	
Standstill current (100 K)	$I_0$ (100 K)	A	35.0	56.0	75.0	
Moment of inertia (with brake)	$J_{mot}$	$10^{-4}$ kgm <sup>2</sup>	539	539	539	
Moment of inertia (without brake)	$J_{mot}$	$10^{-4}$ kgm <sup>2</sup>	464	464	464	
<b>Limiting data</b>						
Maximum speed	$n_{max}$	RPM	1900	3000	3200	
Maximum torque	$M_{max}$	Nm	240	240	240	
Max. current	$I_{max}$	A	112.0	186.0	236.0	
Limiting torque	$M_{limit}$	Nm	129.0	115.0	110.0	
<b>Physical constants</b>						
Torque constant	$k_T$	Nm/A	2.70	1.71	1.27	
Voltage constant	$k_E$	V/1000 RPM	306	194	144	
Winding resistance	$R_{ph.}$	Ohm	0.28	0.10	0.062	
Rotating field inductance	$L_D$	mH	6.4	2.3	1.4	
Electrical time constant	$T_{el}$	ms	23	23	23	
Mechanical time constant	$T_{mech}$	ms	3.5	3.5	3.5	
Thermal time constant	$T_{th}$	min	80	80	80	
Weight (with brake)	$m$	kg	87	87	87	
Weight (without brake)	$m$	kg	80	80	80	

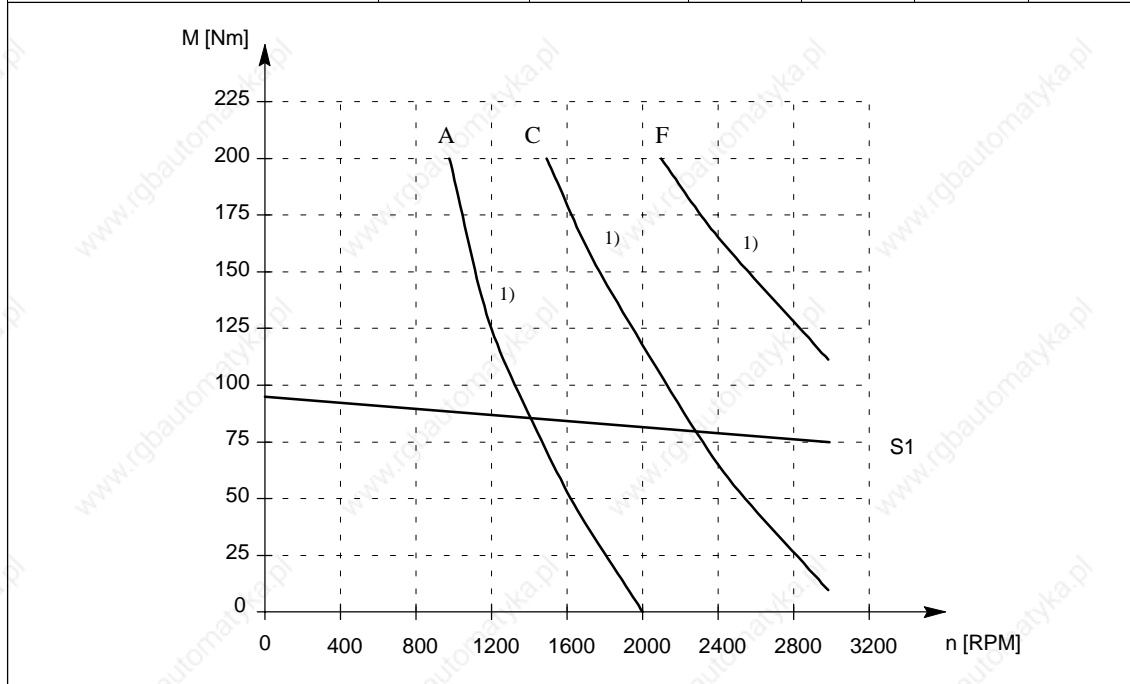

Fig. 2-25 Speed–torque diagram, 1FT5132, force ventilated

1) applies for a 600 V DC link voltage

## 2.1 Speed–torque diagrams

Table 2-26 Standard 1FT5134 motor, force ventilated

1FT5134					
Technical data	Code	Units	–0SA71	–0SC71	
<b>Engineering data</b>					
Rated speed	$n_N$	RPM	1200	2000	
Rated torque (100 K)	$M_N$ (100 K)	Nm	115.0	110.0	
Rated current	$I_N$	A	46.0	74.0	
Standstill torque (60 K)	$M_0$ (60 K)	Nm	90.0	90.0	
Standstill torque (100 K)	$M_0$ (100 K)	Nm	120.0	120.0	
Standstill current (60 K)	$I_0$ (60 K)	A	34.0	56.0	
Standstill current (100 K)	$I_0$ (100 K)	A	45.0	75.0	
Moment of inertia (with brake)	$J_{mot}$	$10^{-4}$ kgm <sup>2</sup>	665	665	
Moment of inertia (without brake)	$J_{mot}$	$10^{-4}$ kgm <sup>2</sup>	590	590	
<b>Limiting data</b>					
Maximum speed	$n_{max}$	RPM	1900	3200	
Maximum torque	$M_{max}$	Nm	300	300	
Max. current	$I_{max}$	A	134.0	222.0	
Limiting torque	$M_{limit}$	Nm	164.0	156.0	
<b>Physical constants</b>					
Torque constant	$k_T$	Nm/A	2.70	1.61	
Voltage constant	$k_E$	V/1000 RPM	306	182	
Winding resistance	$R_{ph.}$	Ohm	0.19	0.073	
Rotating field inductance	$L_D$	mH	4.8	1.8	
Electrical time constant	$T_{el}$	ms	25	25	
Mechanical time constant	$T_{mech}$	ms	3.2	3.2	
Thermal time constant	$T_{th}$	min	85	85	
Weight (with brake)	$m$	kg	107	107	
Weight (without brake)	$m$	kg	100	100	

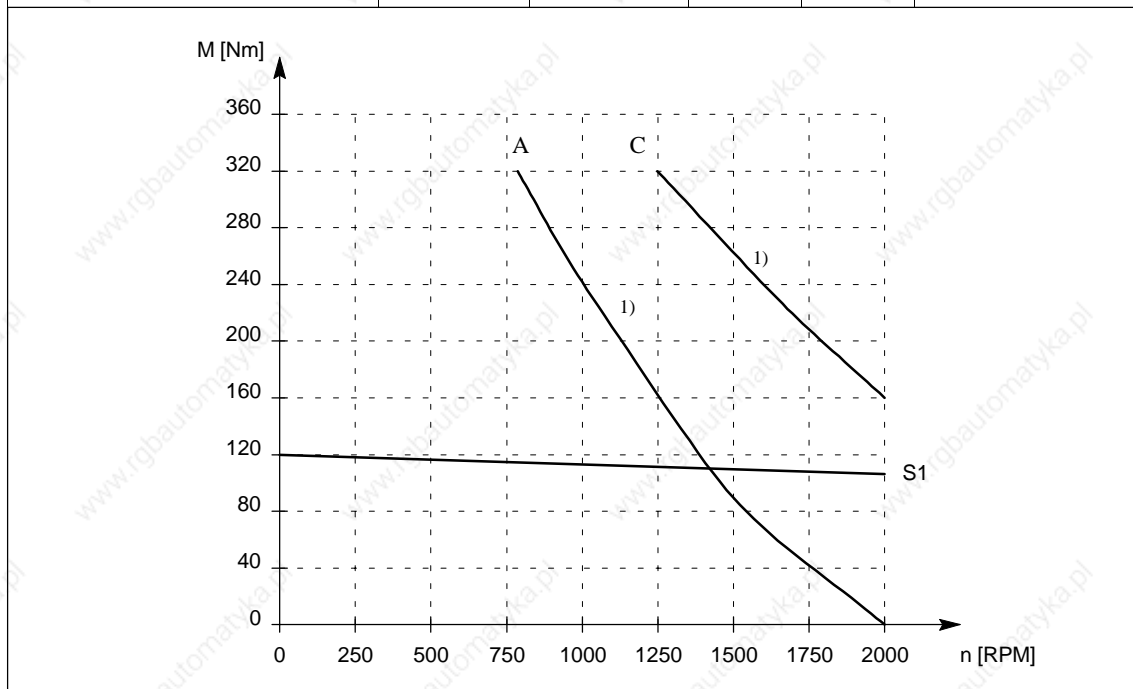

Fig. 2-26 Speed–torque diagram, 1FT5134, force ventilated

1) applies for a 600 V DC link voltage

2.1 Speed–torque diagrams

Table 2-27 Standard 1FT5136 motor, force ventilated

1FT5136					
Technical data	Code	Units	–0SA71	–0SC71	
<b>Engineering data</b>					
Rated speed	$n_N$	RPM	1200	2000	
Rated torque (100 K)	$M_N$ (100 K)	Nm	135.0	130.0	
Rated current	$I_N$	A	54.0	78.0	
Standstill torque (60 K)	$M_0$ (60 K)	Nm	110.0	110.0	
Standstill torque (100 K)	$M_0$ (100 K)	Nm	145.0	145.0	
Standstill current (60 K)	$I_0$ (60 K)	A	41.0	61.5	
Standstill current (100 K)	$I_0$ (100 K)	A	54.0	81.0	
Moment of inertia (with brake)	$J_{mot}$	$10^{-4}$ kgm <sup>2</sup>	791	791	
Moment of inertia (without brake)	$J_{mot}$	$10^{-4}$ kgm <sup>2</sup>	716	716	
<b>Limiting data</b>					
Maximum speed	$n_{max}$	RPM	1900	2900	
Maximum torque	$M_{max}$	Nm	340	340	
Max. current	$I_{max}$	A	156.0	234.0	
Limiting torque	$M_{limit}$	Nm	180.0	170.0	
<b>Physical constants</b>					
Torque constant	$k_T$	Nm/A	2.70	1.79	
Voltage constant	$k_E$	V/1000 RPM	306	203	
Winding resistance	$R_{ph.}$	Ohm	0.14	0.063	
Rotating field inductance	$L_D$	mH	3.8	1.7	
Electrical time constant	$T_{el}$	ms	27	27	
Mechanical time constant	$T_{mech}$	ms	2.8	2.8	
Thermal time constant	$T_{th}$	min	90	90	
Weight (with brake)	$m$	kg	127	127	
Weight (without brake)	$m$	kg	120	120	

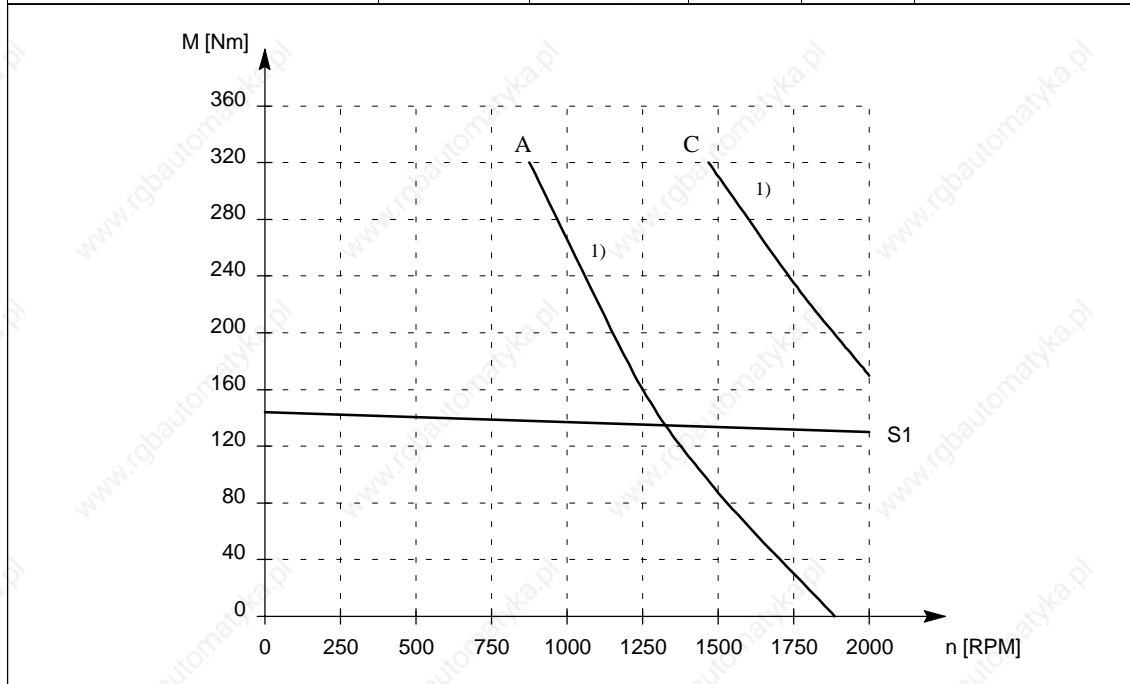

Fig. 2-27 Speed–torque diagram, 1FT5136, force ventilated

1) applies for a 600 V DC link voltage

## 2.1 Speed–torque diagrams

Table 2-28 Standard 1FT5138 motor, force ventilated

1FT5138				
Technical data	Code	Units	-0SA71	
<b>Engineering data</b>				
Rated speed	$n_N$	RPM	1200	
Rated torque (100 K)	$M_N$ (100 K)	Nm	170.0	
Rated current	$I_N$	A	67.0	
Standstill torque (60 K)	$M_0$ (60 K)	Nm	140.0	
Standstill torque (100 K)	$M_0$ (100 K)	Nm	185.0	
Standstill current (60 K)	$I_0$ (60 K)	A	52.0	
Standstill current (100 K)	$I_0$ (100 K)	A	69.0	
Moment of inertia (with brake)	$J_{mot}$	$10^{-4}$ kgm <sup>2</sup>	980	
Moment of inertia (without brake)	$J_{mot}$	$10^{-4}$ kgm <sup>2</sup>	905	
<b>Limiting data</b>				
Maximum speed	$n_{max}$	RPM	1900	
Maximum torque	$M_{max}$	Nm	420	
Max. current	$I_{max}$	A	194.0	
Limiting torque	$M_{limit}$	Nm	220.0	
<b>Physical constants</b>				
Torque constant	$k_T$	Nm/A	2.70	
Voltage constant	$k_E$	V/1000 RPM	306	
Winding resistance	$R_{ph.}$	Ohm	0.11	
Rotating field inductance	$L_D$	mH	3.2	
Electrical time constant	$T_{el}$	ms	29	
Mechanical time constant	$T_{mech}$	ms	2.7	
Thermal time constant	$T_{th}$	min	100	
Weight (with brake)	$m$	kg	157	
Weight (without brake)	$m$	kg	150	

Fig. 2-28 Speed–torque diagram, 1FT5138, force ventilated

1) applies for a 600 V DC link voltage

2.1 Speed-torque diagrams

2.1.2 Short motors

Table 2-29 Short motor 1FT5070

1FT5070					
Technical data	Code	Units	-0AC71	-0AF71	
Engineering data					
Rated speed	$n_N$	RPM	2000	3000	
Rated torque (100 K)	$M_N$ (100 K)	Nm	3.1	3.0	
Rated current	$I_N$	A	2.0	2.8	
Standstill torque (60 K)	$M_0$ (60 K)	Nm	3.0	3.0	
Standstill torque (100 K)	$M_0$ (100 K)	Nm	3.5	3.5	
Standstill current (60 K)	$I_0$ (60 K)	A	1.8	2.6	
Standstill current (100 K)	$I_0$ (100 K)	A	2.1	3.1	
Moment of inertia (with brake)	$J_{mot}$	$10^{-4}$ kgm <sup>2</sup>	16.5	16.5	
Moment of inertia (without brake)	$J_{mot}$	$10^{-4}$ kgm <sup>2</sup>	9.0	9.0	
Limiting data					
Maximum speed	$n_{max}$	RPM	3000	4600	
Maximum torque	$M_{max}$	Nm	12	12	
Max. current	$I_{max}$	A	8.0	12.0	
Limiting torque	$M_{limit}$	Nm	6.0	6.0	
Physical constants					
Torque constant	$k_T$	Nm/A	1.72	1.15	
Voltage constant	$k_E$	V/1000 RPM	195	130	
Winding resistance	$R_{ph.}$	Ohm	16.35	7.86	
Rotating field inductance	$L_D$	mH	85.2	39.1	
Electrical time constant	$T_{el}$	ms	5.3	5.3	
Mechanical time constant	$T_{mech}$	ms	10.2	10.2	
Thermal time constant	$T_{th}$	min	25	25	
Weight (with brake)	$m$	kg	9.0	9.0	
Weight (without brake)	$m$	kg	7.5	7.5	

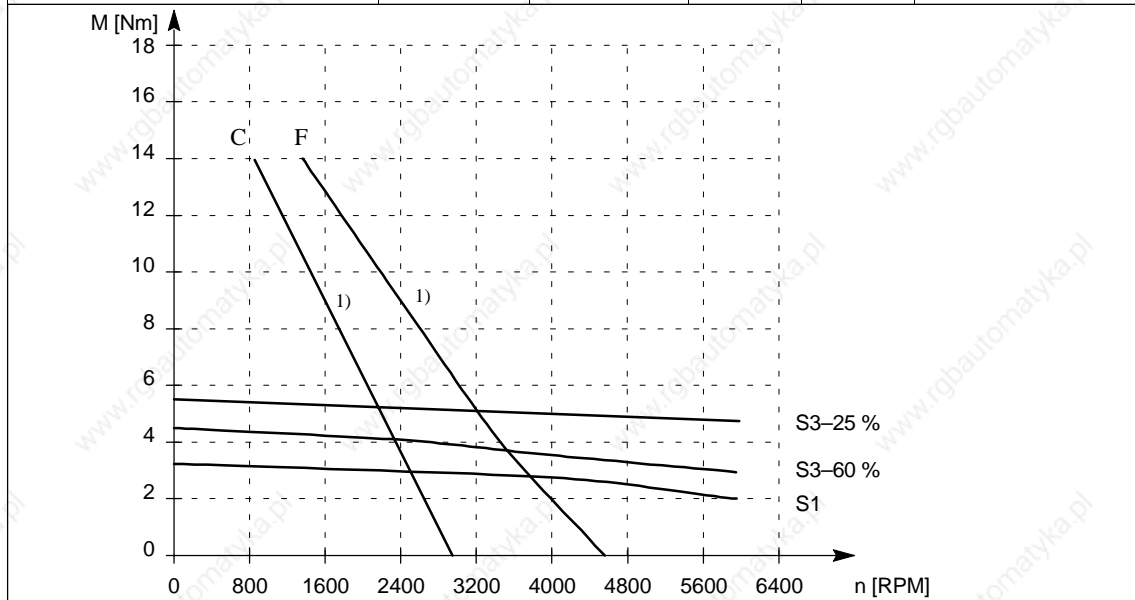

Fig. 2-29 Speed-torque diagram, 1FT5070

1) applies for a 600 V DC link voltage



## 2.1 Speed–torque diagrams

Table 2-30 Short motor 1FT5071

1FT5071					
Technical data	Code	Units	–0AC71	–0AF71	
Engineering data					
Rated speed	$n_N$	RPM	2000	3000	
Rated torque (100 K)	$M_N$ (100 K)	Nm	5.0	4.8	
Rated current	$I_N$	A	3.4	5.0	
Standstill torque (60 K)	$M_0$ (60 K)	Nm	4.5	4.5	
Standstill torque (100 K)	$M_0$ (100 K)	Nm	5.5	5.5	
Standstill current (60 K)	$I_0$ (60 K)	A	2.9	4.3	
Standstill current (100 K)	$I_0$ (100 K)	A	3.5	5.2	
Moment of inertia (with brake)	$J_{mot}$	$10^{-4}$ kgm <sup>2</sup>	20.5	20.5	
Moment of inertia (without brake)	$J_{mot}$	$10^{-4}$ kgm <sup>2</sup>	13	13	
Limiting data					
Maximum speed	$n_{max}$	RPM	3300	5000	
Maximum torque	$M_{max}$	Nm	18	18	
Max. current	$I_{max}$	A	13.0	21.0	
Limiting torque	$M_{limit}$	Nm	8.0	8.0	
Physical constants					
Torque constant	$k_T$	Nm/A	1.59	1.06	
Voltage constant	$k_E$	V/1000 RPM	180	120	
Winding resistance	$R_{ph.}$	Ohm	6.44	2.90	
Rotating field inductance	$L_D$	mH	43.8	18.9	
Electrical time constant	$T_{el}$	ms	6.8	6.8	
Mechanical time constant	$T_{mech}$	ms	6.7	6.7	
Thermal time constant	$T_{th}$	min	30	30	
Weight (with brake)	$m$	kg	10	10	
Weight (without brake)	$m$	kg	8.5	8.5	

Fig. 2-30 Speed–torque diagram, 1FT5071

1) applies for a 600 V DC link voltage

2.1 Speed–torque diagrams

Table 2-31 Short motor 1FT5073

1FT5073					
Technical data	Code	Units	–0AC71	–0AF71	
<b>Engineering data</b>					
Rated speed	$n_N$	RPM	2000	3000	
Rated torque (100 K)	$M_N$ (100 K)	Nm	8.0	7.2	
Rated current	$I_N$	A	5.3	7.2	
Standstill torque (60 K)	$M_0$ (60 K)	Nm	7.0	7.0	
Standstill torque (100 K)	$M_0$ (100 K)	Nm	9.0	9.0	
Standstill current (60 K)	$I_0$ (60 K)	A	4.3	6.4	
Standstill current (100 K)	$I_0$ (100 K)	A	5.5	8.2	
Moment of inertia (with brake)	$J_{mot}$	$10^{-4}$ kgm <sup>2</sup>	27.5	27.5	
Moment of inertia (without brake)	$J_{mot}$	$10^{-4}$ kgm <sup>2</sup>	20	20	
<b>Limiting data</b>					
Maximum speed	$n_{max}$	RPM	3200	4800	
Maximum torque	$M_{max}$	Nm	28	28	
Max. current	$I_{max}$	A	21.0	32.0	
Limiting torque	$M_{limit}$	Nm	15.2	15.4	
<b>Physical constants</b>					
Torque constant	$k_T$	Nm/A	1.64	1.1	
Voltage constant	$k_E$	V/1000 RPM	186	124	
Winding resistance	$R_{ph.}$	Ohm	3.06	1.35	
Rotating field inductance	$L_D$	mH	25.7	11.4	
Electrical time constant	$T_{el}$	ms	8.5	8.5	
Mechanical time constant	$T_{mech}$	ms	4.5	4.5	
Thermal time constant	$T_{th}$	min	35	35	
Weight (with brake)	$m$	kg	12	12	
Weight (without brake)	$m$	kg	10.5	10.5	

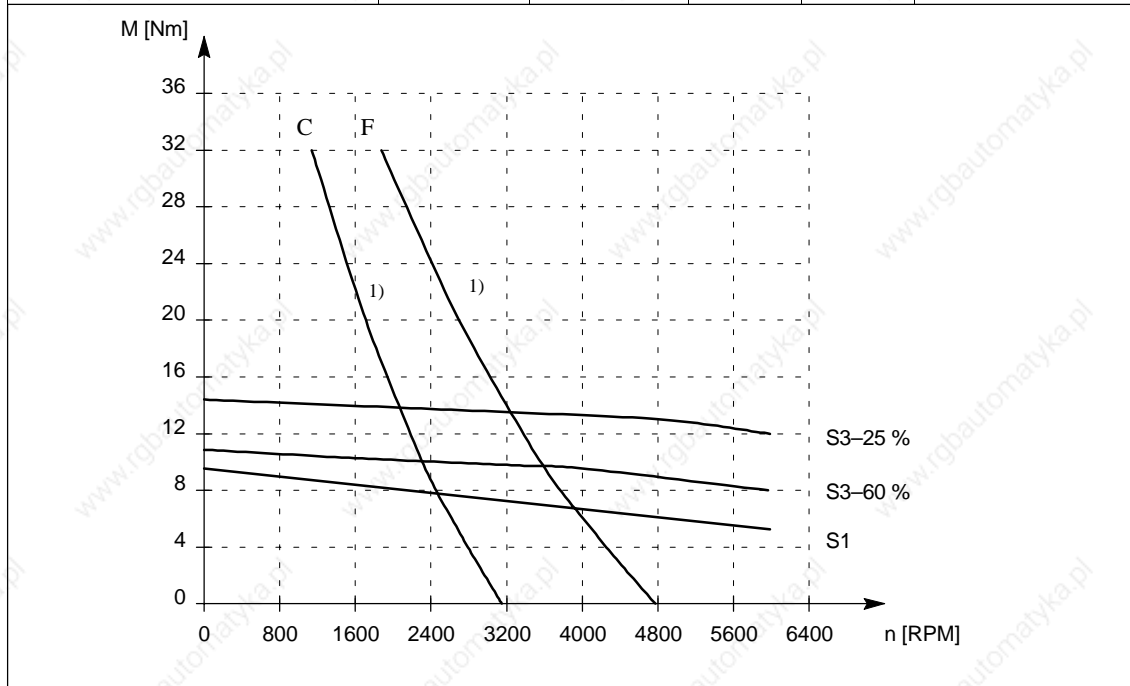

Fig. 2-31 Speed–torque diagram, 1FT5073

1) applies for a 600 V DC link voltage

## 2.1 Speed–torque diagrams

Table 2-32 Short motor 1FT5100

1FT5100					
Technical data	Code	Units	–0AC71	–0AF71	
<b>Engineering data</b>					
Rated speed	$n_N$	RPM	2000	3000	
Rated torque (100 K)	$M_N$ (100 K)	Nm	12.0	11.0	
Rated current	$I_N$	A	7.9	11.0	
Standstill torque (60 K)	$M_0$ (60 K)	Nm	10.0	10.0	
Standstill torque (100 K)	$M_0$ (100 K)	Nm	13.0	13.0	
Standstill current (60 K)	$I_0$ (60 K)	A	6.2	9.2	
Standstill current (100 K)	$I_0$ (100 K)	A	8.0	12.0	
Moment of inertia (with brake)	$J_{mot}$	$10^{-4}$ kgm <sup>2</sup>	84	84	
Moment of inertia (without brake)	$J_{mot}$	$10^{-4}$ kgm <sup>2</sup>	59	59	
<b>Limiting data</b>					
Maximum speed	$n_{max}$	RPM	3200	4800	
Maximum torque	$M_{max}$	Nm	40	40	
Max. current	$I_{max}$	A	32.0	47.0	
Limiting torque	$M_{limit}$	Nm	19.5	20.0	
<b>Physical constants</b>					
Torque constant	$k_T$	Nm/A	1.63	1.09	
Voltage constant	$k_E$	V/1000 RPM	185	123	
Winding resistance	$R_{ph.}$	Ohm	1.4	0.62	
Rotating field inductance	$L_D$	mH	15.7	7.0	
Electrical time constant	$T_{el}$	ms	11	11	
Mechanical time constant	$T_{mech}$	ms	6.2	6.2	
Thermal time constant	$T_{th}$	min	35	35	
Weight (with brake)	$m$	kg	19.5	19.5	
Weight (without brake)	$m$	kg	15.5	15.5	

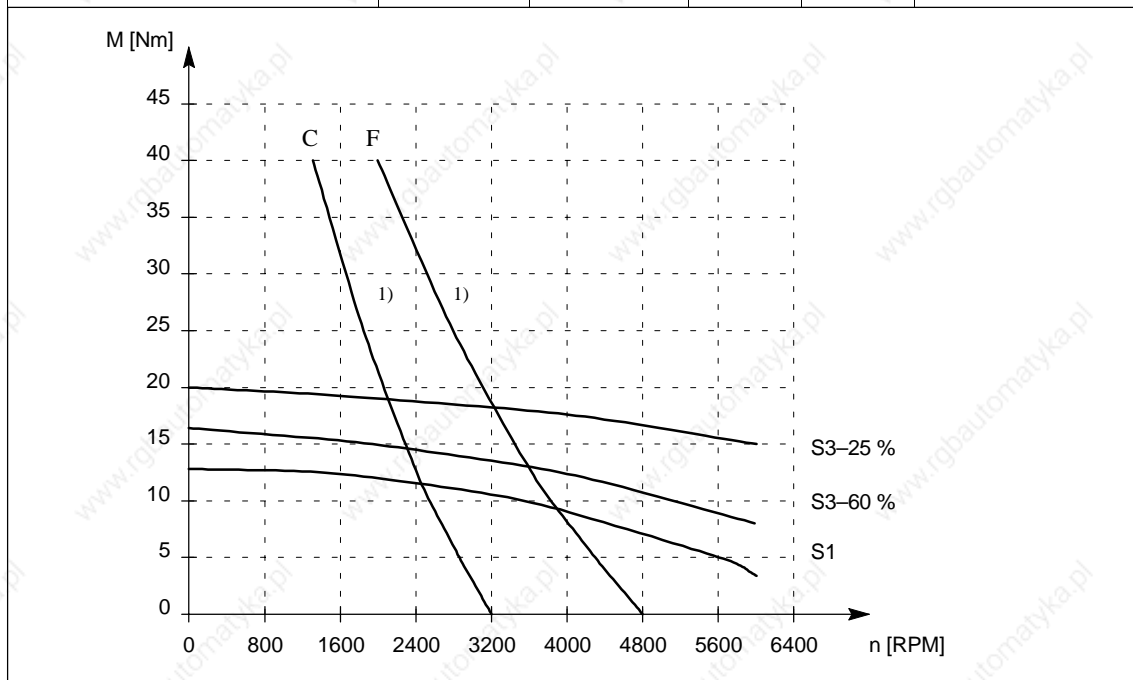

Fig. 2-32 Speed–torque diagram, 1FT5100

1) applies for a 600 V DC link voltage

2.1 Speed–torque diagrams

Table 2-33 Short motor 1FT5101

1FT5101					
Technical data	Code	Units	–0AC71	–0AF71	
<b>Engineering data</b>					
Rated speed	$n_N$	RPM	2000	3000	
Rated torque (100 K)	$M_N$ (100 K)	Nm	17.0	15.0	
Rated current	$I_N$	A	11.0	15.0	
Standstill torque (60 K)	$M_0$ (60 K)	Nm	15.0	15.0	
Standstill torque (100 K)	$M_0$ (100 K)	Nm	19.0	19.0	
Standstill current (60 K)	$I_0$ (60 K)	A	9.4	14.5	
Standstill current (100 K)	$I_0$ (100 K)	A	12.0	18.0	
Moment of inertia (with brake)	$J_{mot}$	$10^{-4}$ kgm <sup>2</sup>	110	110	
Moment of inertia (without brake)	$J_{mot}$	$10^{-4}$ kgm <sup>2</sup>	85	85	
<b>Limiting data</b>					
Maximum speed	$n_{max}$	RPM	2700	4200	
Maximum torque	$M_{max}$	Nm	60	60	
Max. current	$I_{max}$	A	46.0	66.0	
Limiting torque	$M_{limit}$	Nm	32.0	35.0	
<b>Physical constants</b>					
Torque constant	$k_T$	Nm/A	1.61	1.06	
Voltage constant	$k_E$	V/1000 RPM	182	120	
Winding resistance	$R_{ph.}$	Ohm	0.71	0.33	
Rotating field inductance	$L_D$	mH	9.4	4.2	
Electrical time constant	$T_{el}$	ms	14	14	
Mechanical time constant	$T_{mech}$	ms	4.8	4.8	
Thermal time constant	$T_{th}$	min	40	40	
Weight (with brake)	$m$	kg	23	23	
Weight (without brake)	$m$	kg	19	19	

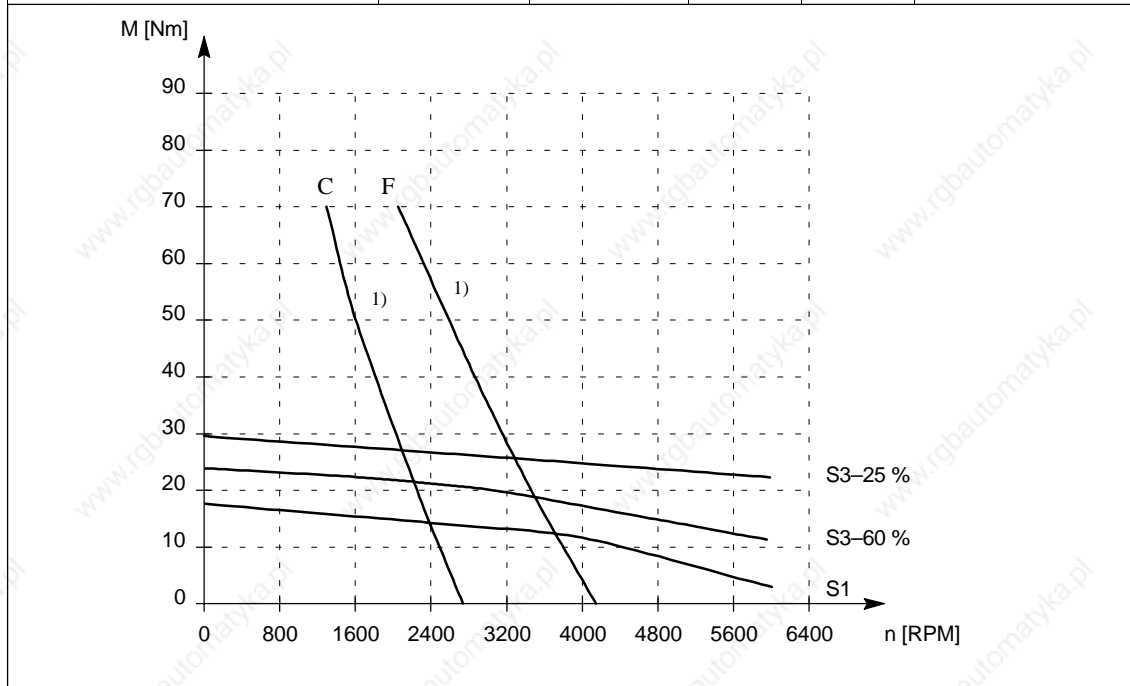

Fig. 2-33 Speed–torque diagram, 1FT5101

1) applies for a 600 V DC link voltage

## 2.1 Speed–torque diagrams

Table 2-34 Short motor 1FT5103

1FT5103					
Technical data	Code	Units	–0AC71	–0AF71	
<b>Engineering data</b>					
Rated speed	$n_N$	RPM	2000	3000	
Rated torque (100 K)	$M_N$ (100 K)	Nm	22.5	20.0	
Rated current	$I_N$	A	15.0	20.0	
Standstill torque (60 K)	$M_0$ (60 K)	Nm	19.0	19.0	
Standstill torque (100 K)	$M_0$ (100 K)	Nm	25.0	25.0	
Standstill current (60 K)	$I_0$ (60 K)	A	12.0	17.5	
Standstill current (100 K)	$I_0$ (100 K)	A	16.0	23.0	
Moment of inertia (with brake)	$J_{mot}$	$10^{-4}$ kgm <sup>2</sup>	195	195	
Moment of inertia (without brake)	$J_{mot}$	$10^{-4}$ kgm <sup>2</sup>	110	110	
<b>Limiting data</b>					
Maximum speed	$n_{max}$	RPM	2700	4200	
Maximum torque	$M_{max}$	Nm	76	76	
Max. current	$I_{max}$	A	62.0	93.0	
Limiting torque	$M_{limit}$	Nm	45.0	45.0	
<b>Physical constants</b>					
Torque constant	$k_T$	Nm/A	1.60	1.10	
Voltage constant	$k_E$	V/1000 RPM	181	124	
Winding resistance	$R_{ph.}$	Ohm	0.47	0.20	
Rotating field inductance	$L_D$	mH	6.5	3.0	
Electrical time constant	$T_{el}$	ms	17	17	
Mechanical time constant	$T_{mech}$	ms	3.8	3.8	
Thermal time constant	$T_{th}$	min	45	45	
Weight (with brake)	$m$	kg	26	26	
Weight (without brake)	$m$	kg	22	22	

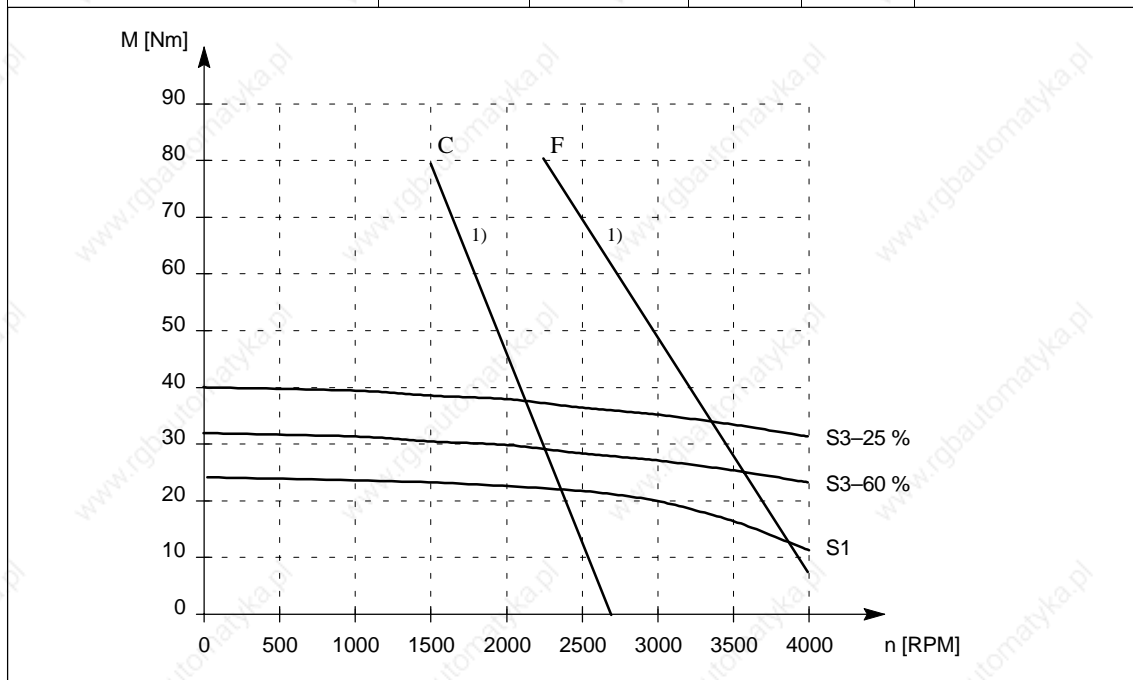

Fig. 2-34 Speed–torque diagram, 1FT5103

1) applies for a 600 V DC link voltage

2.2 Cantilever force diagrams

## 2.2 Cantilever force diagrams

### Cantilever force stressing

Point of application of cantilever forces  $F_Q$  at the shaft end

- for average operating speeds
- for a nominal bearing lifetime of 20 000 h

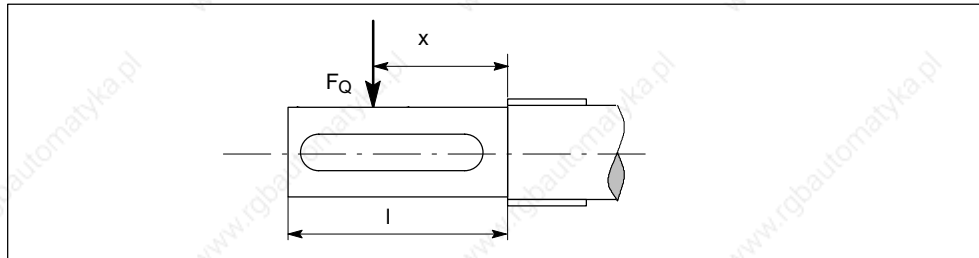

Fig. 2-35 Force application point at the drive shaft end

Dimension x: Distance between the point of application of force  $F_Q$  and the shaft shoulder in mm.

Dimension l: Length of the shaft end in mm.

### Calculating the pre-tensioned belt force

$$F_R = 2 * M_0 * c / d_R$$

$F_R$  [N] Belt pre-tension force

$M_0$  [Nm] Motor standstill torque

$d_R$  Effective diameter of the belt pulley

$c$  Pre-tension factor for the accelerating torque

Experience values for toothed belts  $c = 1.5$  to  $2.2$

Experience values for flat belts  $c = 2.2$  to  $3.0$

When using other configurations, the actual forces, generated from the torque being transferred, must be taken into account.

$$F_R \leq F_{Qper}$$

### 2.2.1 Standard motors

#### Cantilever force 1FT5034 to 1FT5036

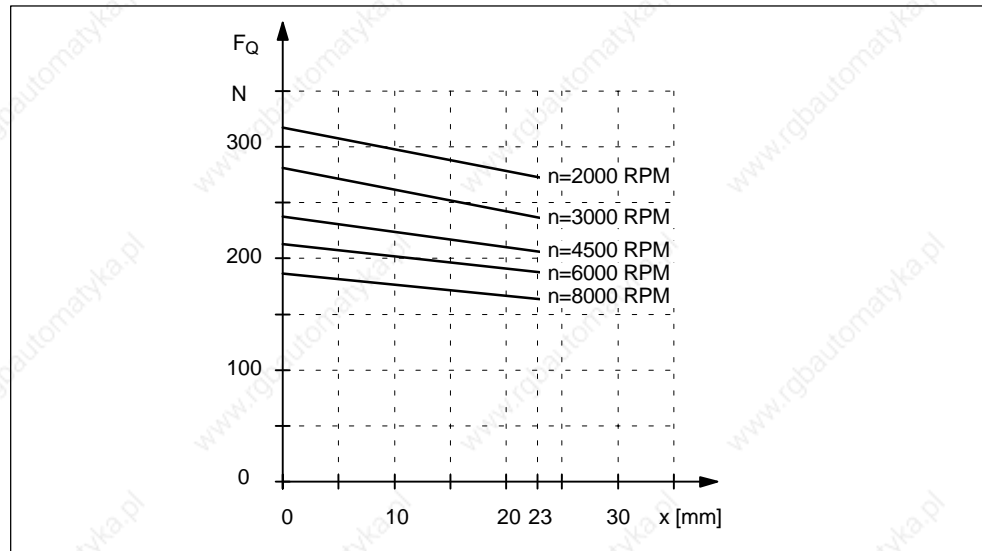

Fig. 2-36 Cantilever force  $F_Q$  at a distance  $x$  from the shaft shoulder for a nominal bearing lifetime of 20 000 h

#### Cantilever force 1FT5042 to 1FT5046

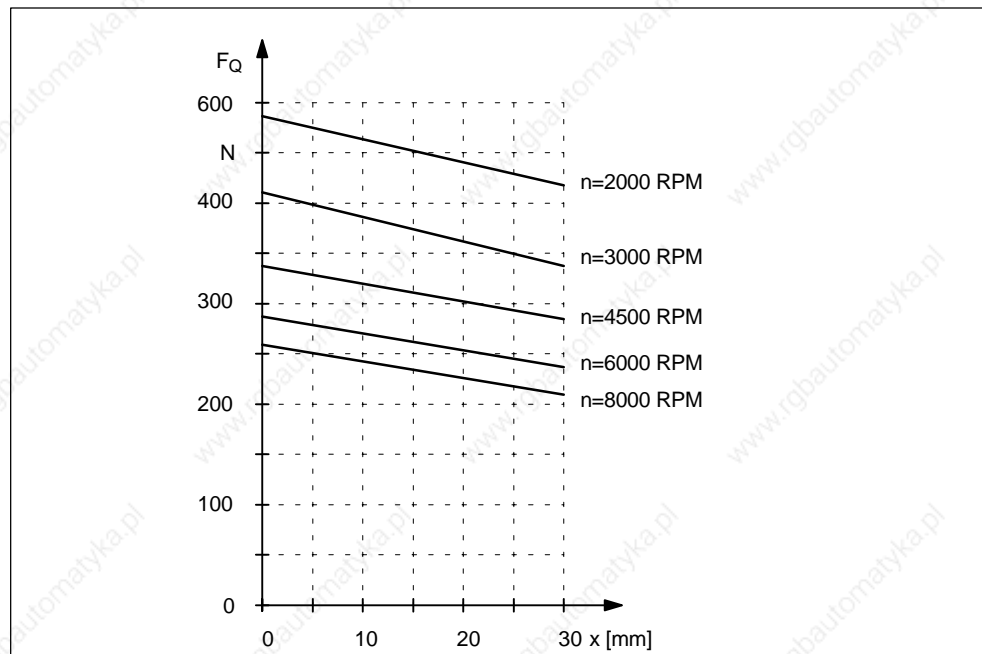

Fig. 2-37 Cantilever force  $F_Q$  at a distance  $x$  from the shaft shoulder for a nominal bearing lifetime of 20 000 h

2.2 Cantilever force diagrams

Cantilever force 1FT5062 to 1FT5066

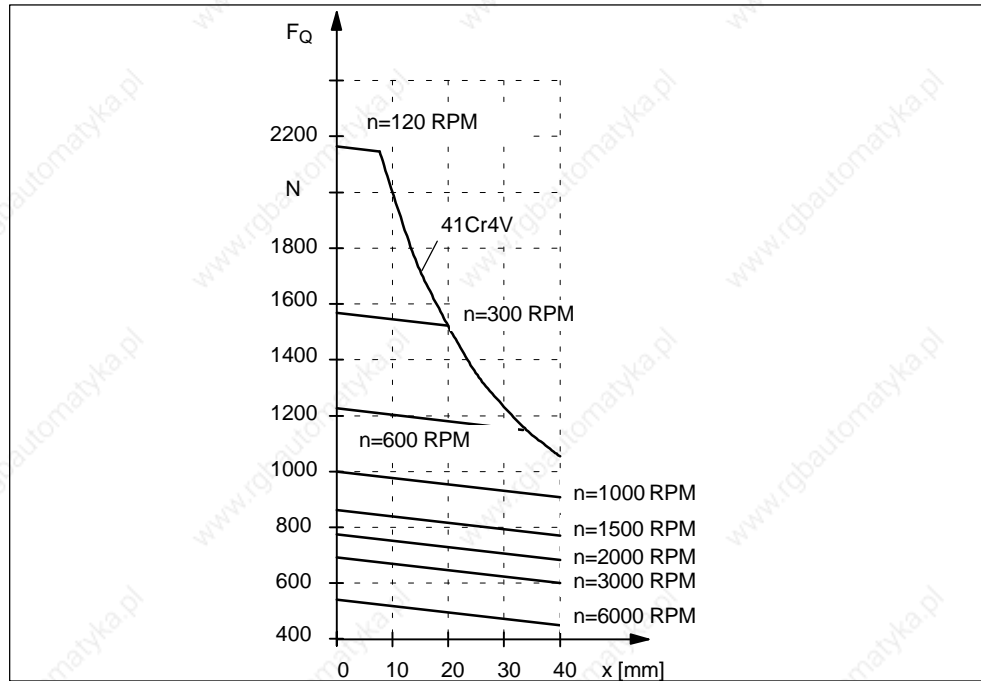

Fig. 2-38 Cantilever force  $F_Q$  at a distance  $x$  from the shaft shoulder for a nominal bearing lifetime of 20 000 h

Cantilever force 1FT5072 to 1FT5076

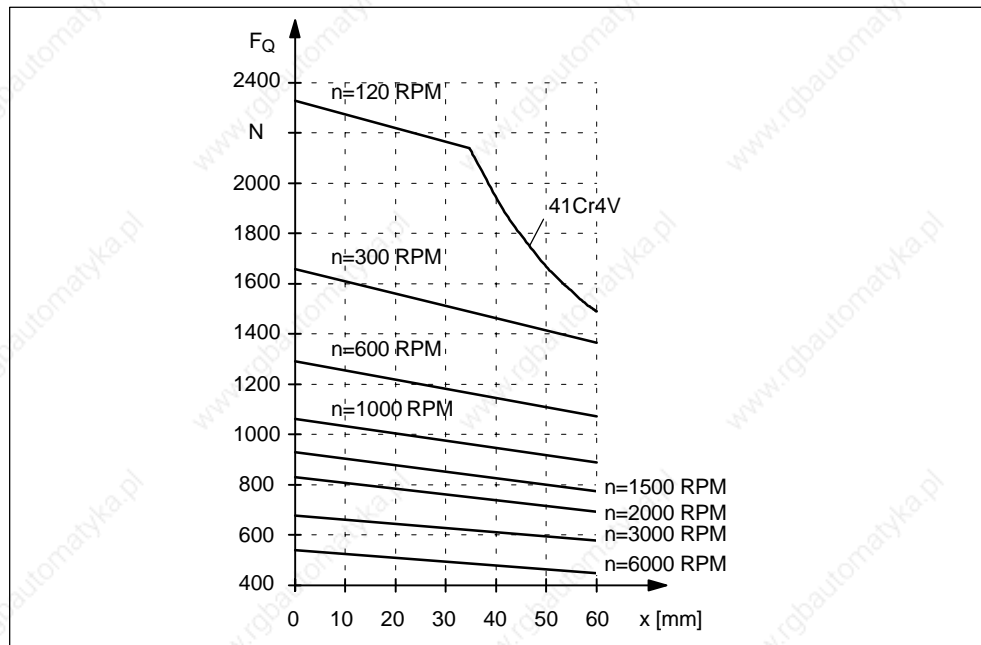

Fig. 2-39 Cantilever force  $F_Q$  at a distance  $x$  from the shaft shoulder for a nominal bearing lifetime of 20 000 h



## 2.2 Cantilever force diagrams

## Cantilever force 1FT5102 to 1FT5104

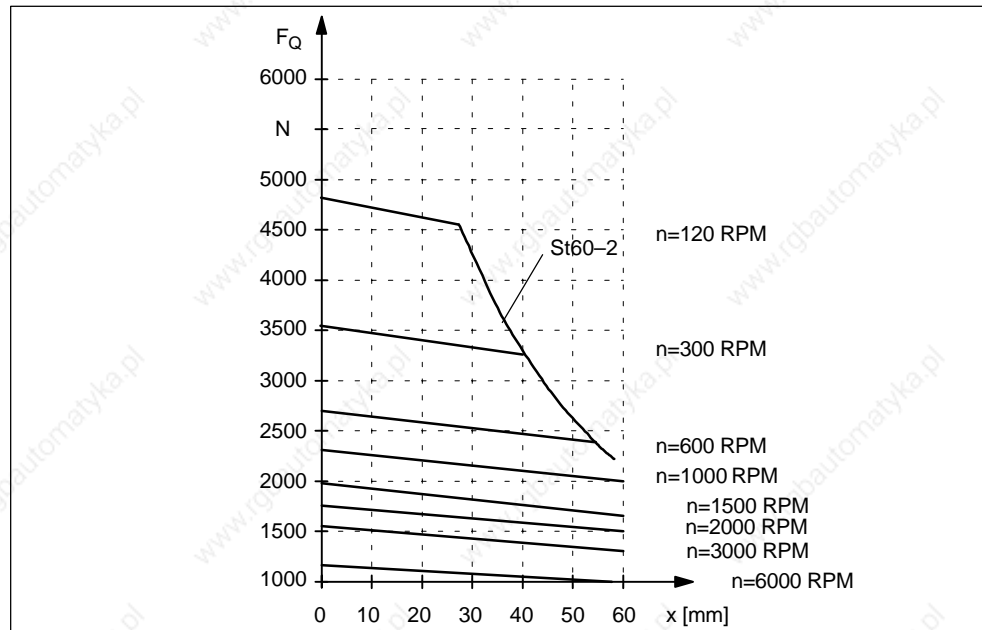

Fig. 2-40 Cantilever force  $F_Q$  at a distance  $x$  from the shaft shoulder for a nominal bearing lifetime of 20 000 h

## Cantilever force 1FT5132 to 1FT5136

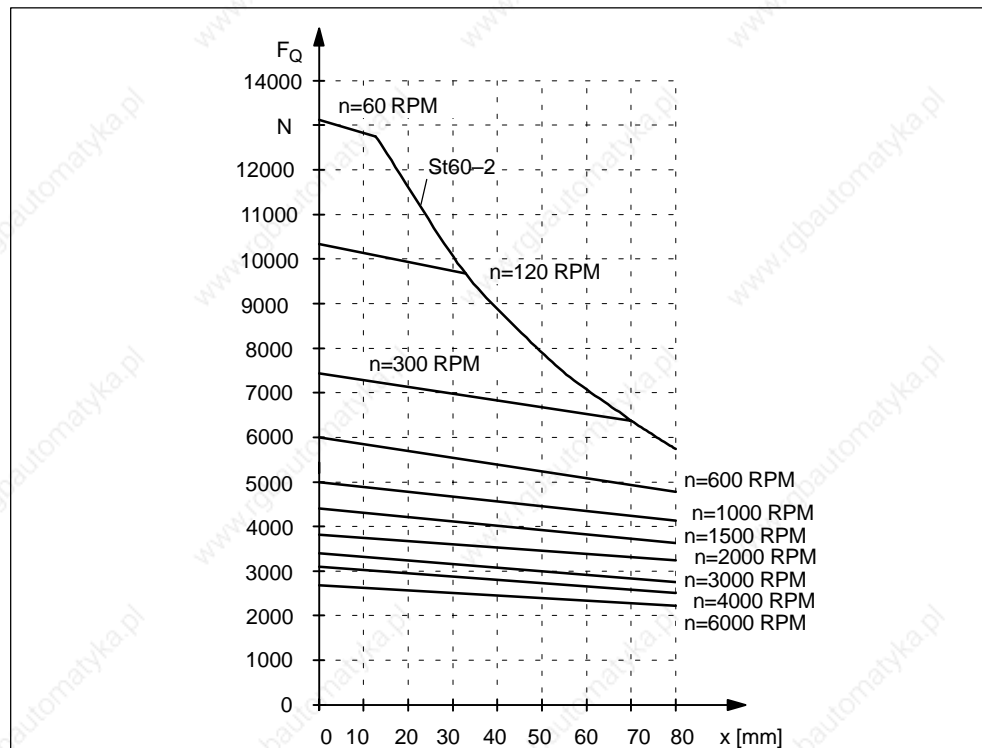

Fig. 2-41 Cantilever force  $F_Q$  at a distance  $x$  from the shaft shoulder for a nominal bearing lifetime of 20 000 h

2.2 Cantilever force diagrams

2.2.2 Short motors

Cantilever force 1FT5070 to 1FT5071

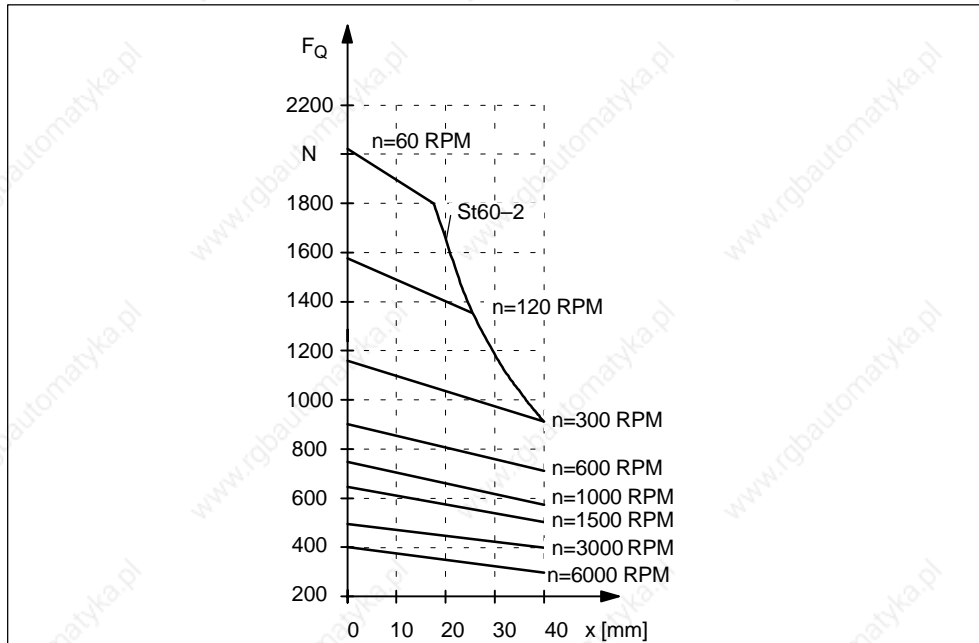

Fig. 2-42 Cantilever force  $F_Q$  at a distance  $x$  from the shaft shoulder for a nominal bearing lifetime of 20 000 h

Cantilever force 1FT5100, 1FT5101, 1FT5103

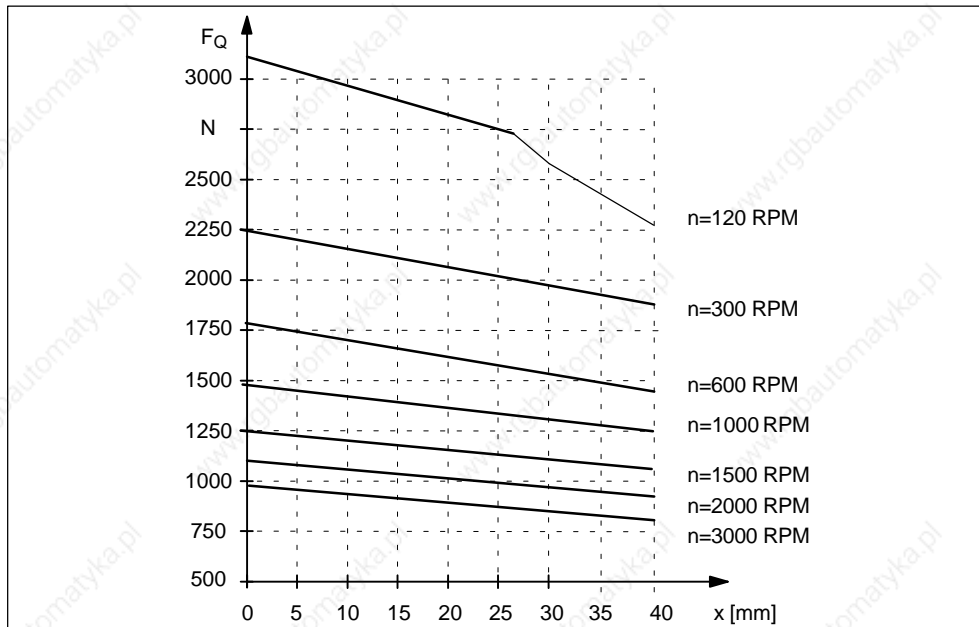

Fig. 2-43 Cantilever force  $F_Q$  at a distance  $x$  from the shaft shoulder for a nominal bearing lifetime of 20 000 h

## 2.3 Axial forces

### Axial force stressing



---

**Warning**

Axial forces are not permissible for motors with integrated holding brake!

---

When using, e.g. helical gearwheels as drive element, in addition to the radial force, the motor bearings are also subject to an axial force. For axial forces, the spring-loading of the bearings can be overcome so that the rotor moves corresponding to the axial bearing play present (up to 0.2 mm).

The permissible axial force can be approximately calculated using the following formula:

$$F_A = 0.35 * F_Q$$

■

2.3 Axial forces

Space for your notes

---

---

---

---

---

---

---

---

---

---

---

---

---

---

---

---

---

---

---

---

---

---

---

## Motor Components (Options)

### 3.1 Thermal motor protection

A temperature sensor is integrated in the stator winding to sense the motor temperature and provide thermal motor protection.

#### Temperature sensor, type Q63100–P426–M135

Characteristics acc. to DIN 44081

Characteristics PTC thermistor

Use For motors with the following shaft heights:

- shaft heights 36 and 48: 2 integrated PTC thermistors (in series)
- shaft heights 63 and 132: one integrated PTC thermistor

Resistance when cold (20° C): < 250 Ω

Response temperature: 155° C ± 5° C

Connection: via the encoder cable

The change in resistance is **not** proportional to the change in the winding temperature.

The evaluation circuit signal in the SIMODRIVE drive converter must externally be evaluated.

High short-term overload conditions require additional protective measures as a result of the thermal coupling time of the sensor.

The cables for the temperature sensor are included in the pre-assembled encoder cable.

## 3.1 Thermal motor protection

**Caution**

The integrated temperature sensor protects the servomotors against overload conditions:

Shaft heights 36 and 48 to  $2 * I_0 60 \text{ K}$   
 from shaft height 63 to  $4 * I_0 60 \text{ K}$

Sufficient protection is no longer provided for thermally critical load situations, e.g. a high overload condition at motor standstill. This means that as an additional protective measure, it is necessary, for example, to use a thermal overcurrent relay.

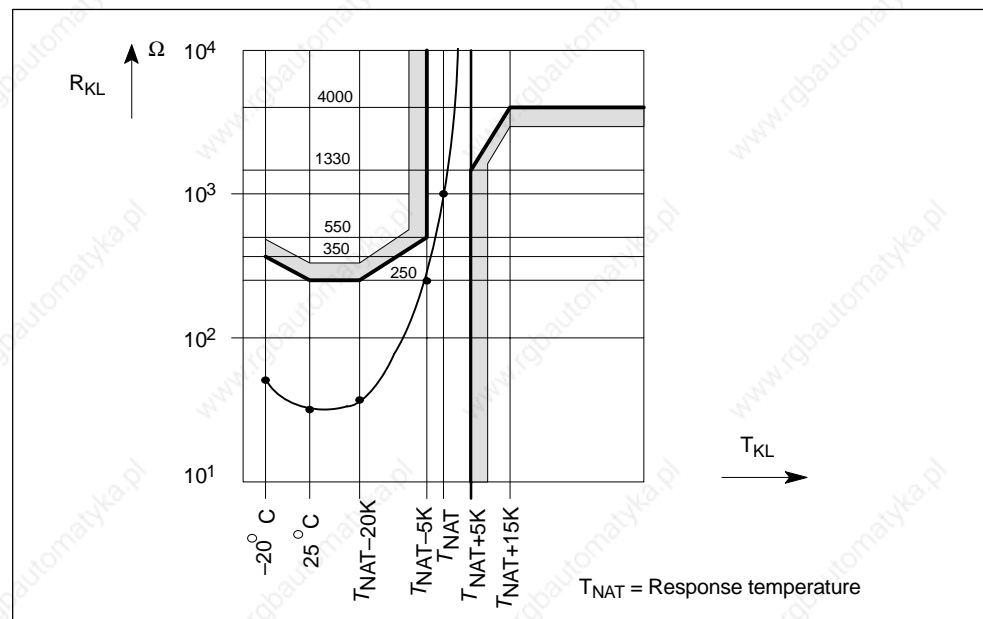

Fig. 3-1 Resistance characteristic

## 3.2 Encoders

Table 3-1 Overview of the encoders used

Motor types	Tach. system 1FU1030	Tach. system 1FU1050	Incremental encoders ROD 320.005	Incremental encoders ROD 426	Prepared for mounting encoders using a synchronous flange
1FT5 03□	X			X	X
1FT5 04□	X			X	X
1FT5 06□		X	X	X	X
1FT5 07□		X	X	X	X
1FT5 10□		X	X	X	X
1FT5 13□		X	X	X	X

## 3.2 Encoders

## 3.2.1 Tachogenerator system

Version:	Brushless analog encoder system
Coupling:	Via a taper on the drive end (this is integrated in the motor)
Function:	<ul style="list-style-type: none"> <li>• Tachometer to sense the speed actual value</li> <li>• Magnetic elements or Hall switch system as rotor position encoder for inverter control</li> </ul>
Output signals:	<ul style="list-style-type: none"> <li>• Trapezoidal voltage signals from the tachogenerator</li> <li>• Absolute signal for the rotor position 18 pieces of information per motor revolution</li> </ul>
Connection:	Connector with pre-assembled encoder cable

Table 3-2 Technical data, 1FU tachometer system

Technical data	1FU1030	1FU1050
	Hall switch system	Magnetic elements
Speed (mech. limiting speed)	8000 RPM	8000 RPM
Peak value, phase voltage at the rated speed	16/40 V	40 V
Voltage tolerance	+15 %, -5 %	± 8 %
Voltage calibration	± 20 %	± 20 %
Peak ripple	≤ 1 %	≤ 0.5 %
Linearity error	≤ 0.2 %	≤ 0.2 %
Reversing error	≤ 0.2 %	≤ 0.2 %

Encoder cable: 6FX□202-2CB31-□□□0

  
 Length

5 = MOTION-CONNECT® 500  
8 = MOTION-CONNECT® 800

Mating connector: 6FX2003-0CE12



### 3.2.2 ROD 320.005 incremental encoders

Version:	Optical encoder system with different pulse numbers (refer to the Catalog)
Coupling:	Via a taper on the drive end (this is integrated in the motor)
Application:	Indirect measuring system for digital position control loop
Evaluation:	Incremental
Output signals:	Squarewave; RS422 (TTL)
Connection:	Connector

Table 3-3 Technical data, ROD 320.005 pulse encoder

Mech. speed Electr. speed Operating voltage Current drain Frequency range	max. 8500 RPM Dependent on the pulse number (refer below) 5 V DC $\pm 5\%$ $\leq 150$ mA (without load) 0 to 300 kHz
Edge clearance Delay $V_{a0}$ to $V_{a1}$ and $V_{a2}$ Output load capacity	$a \geq 420$ ns $t_d \leq 50$ ns $I_{high} \leq DC 20$ mA $I_{low} \leq DC 20$ mA; $C_{Load} \leq 1000$ pF
Short-circuit strength	Briefly, all outputs with respect to 0 V; 1 output continuously at $\leq 25$ °C
Light source	Vibration-proof LED
Operating temperature	-30 °C to +100 °C
Intrinsic moment of inertia	$0.035 * 10^{-4}$ kgm <sup>2</sup>
Weight	0.25 kg

3.2 Encoders

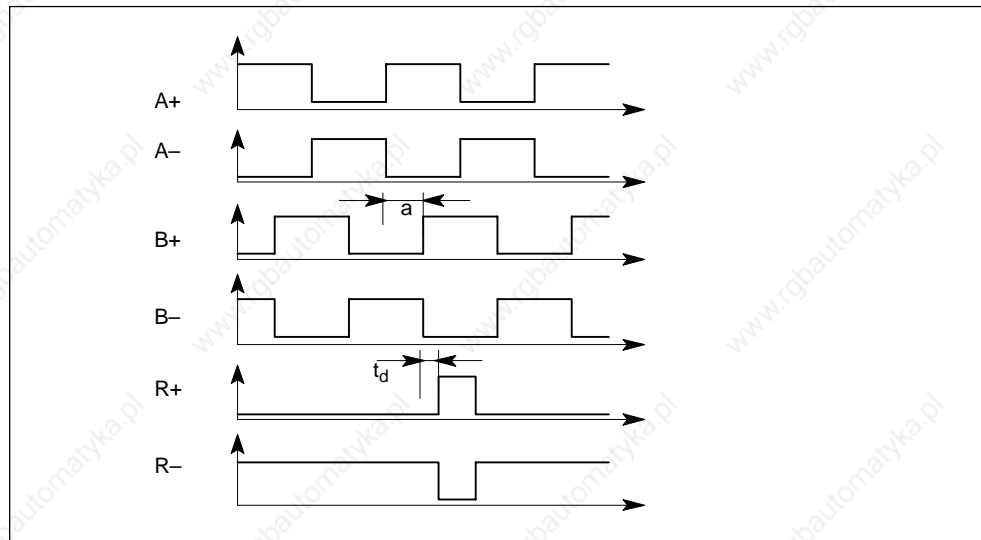

Fig. 3-2 Signal characteristic for clockwise direction of rotation

The servomotors may only be utilized for an overtemperature for  $\Delta T = 60$  K.

Maximum electrical speed:

$$n_{\max} = \frac{f_g * 10^3 * 60}{\text{Pulse number}} \text{ [RPM]}$$

$f_g$  [kHz] Limiting frequency (-3dB)

Connection assignment for 17-pin flange-mounted socket with pin contacts

PIN No.	Signal
A	A+
B	B+
C, J, K	+5 V
D	A-
E	B-
F	R+
G	R-
H	Shield
N, P, T	0 V
R, S	Bridge
L	Vas <sup>1)</sup>

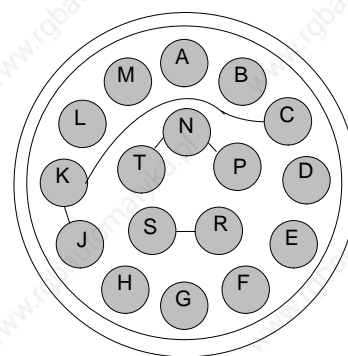

When viewing the plug-in side (pins)

Mating connector: 6FC9348-7AV01 (socket)

Pre-assembled cable: refer to Catalog NC Z

1) Fault signal: LED monitoring

### 3.2.3 ROD 426 incremental encoder

Version:	Optical encoder system with different pulse numbers (refer to the Catalog)
Coupling:	At the non-drive end through a bellows-type or plate-spring coupling (mounted at the motor); synchronous flange
Application:	Indirect measuring system for digital position control loop
Output signals:	<ul style="list-style-type: none"> <li>• squarewave; RS422 (TTL)</li> <li>• 2 channels offset through 90° electr.</li> <li>• one zero pulse per revolution</li> </ul>
Evaluation:	Incremental
Connection:	Connector

Table 3-4 Technical data, ROD426 pulse encoder

Speed	max. 12 000 RPM
Operating voltage	5 V DC $\pm 5\%$
Current drain	$\leq 150$ mA (without load)
Frequency range	0 kHz to 300 kHz
Signal edge	RS 422 (TTL)
Minimum edge clearance	$\geq 0.45$ $\mu$ s at 300 kHz
V <sub>a1</sub> to V <sub>a2</sub>	
Electrical resolution	500 to 5000 pulses/revolution (corresponds to the resolution of the pulse disk); for external multiplication, up to 20 000 pulses/revolution
Degree of protection (acc. to DIN 40050)	<ul style="list-style-type: none"> <li>• without shaft input: IP 67</li> <li>• with shaft input: IP 64</li> </ul>
Operating temperature	-30 °C to +100°C
Storage temperature	-30 °C to +80 °C
Vibration stressing (acc. to DIN IEC 68-2-6)	100 m/s <sup>2</sup> (50...2000 Hz)
Shock stressing (acc. to DIN IEC 68-2-29)	1000 m/s <sup>2</sup> (11 ms)
Moment of inertia of the mounting encoder incl. the coupling and motor shaft	0.0175 * 10 <sup>-4</sup> kgm <sup>2</sup>
Moment of inertia of the encoder	1.45 * 10 <sup>-6</sup> kgm <sup>2</sup>
Weight	0.25 kg

3.2 Encoders

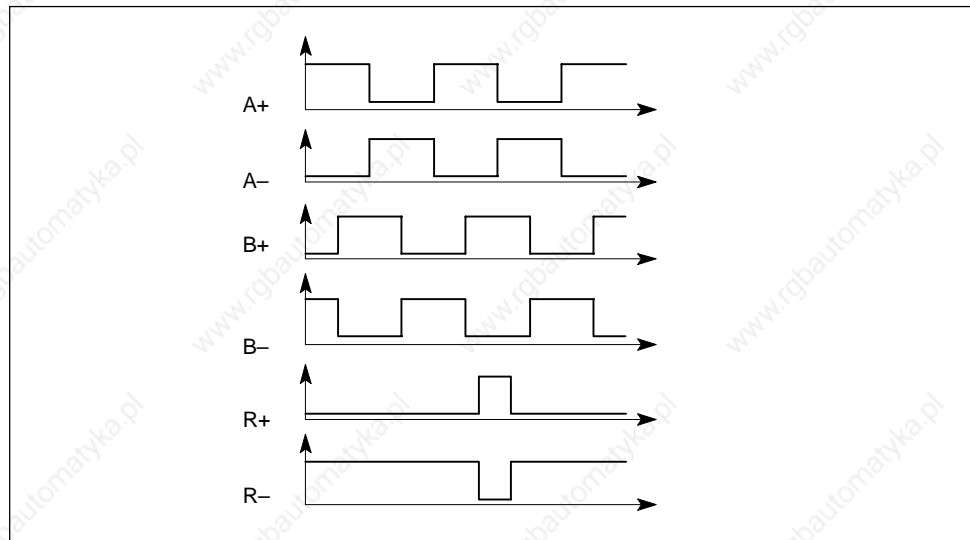

Fig. 3-3 Signal characteristic for a clockwise direction of rotation

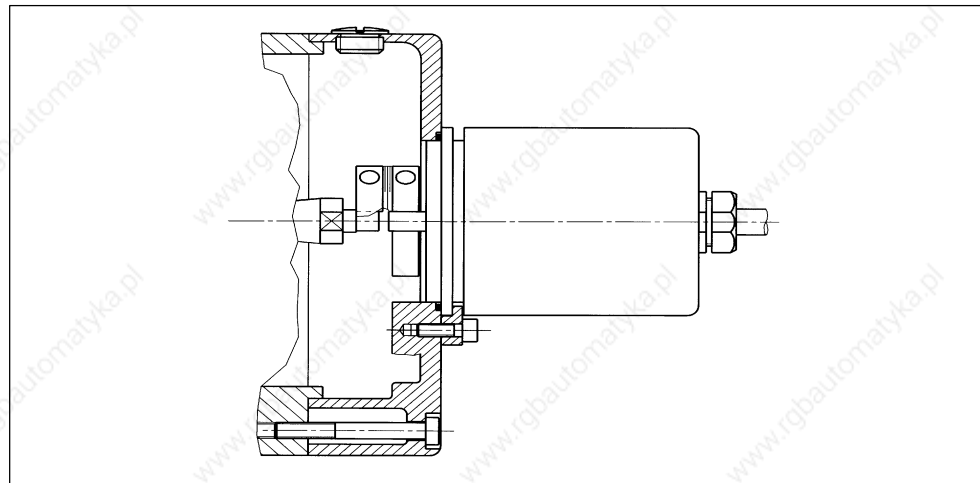
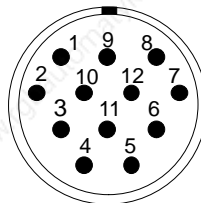

Fig. 3-4 1FT5 servomotor with mounted encoder

### Connection assignment for 12-pin connectors with pin contacts

PIN No.	Signal
1	B-
2	+5 V Sense
3	R+
4	R-
5	A+
6	A-
7	Uas <sup>1)</sup>
8	B+
9	not connected
10	0 V
11	0 V Sense
12	+5 V



When viewing the plug-in side (pins)

Mating connector: 6FX2003-0CE12 (socket)

Pre-assembled cable: refer to Catalog NC Z

1) Fault signal: LED monitoring

## 3.2 Encoders

## 3.2.4 Mounting encoders with synchronous flange

For this particular version, the ROD 426 incremental encoder is mounting-compatible

Order designation: G51

Application:

- SIMODRIVE sensor incremental encoder with synchronous flange:
  - 6FX2001-2□□□ with RS 422 (TTL)
  - 6FX2001-3□□□ with sinusoidal 1Vpp
  - 6FX2001-4□□□ with HTL
 as well as mounting-compatible encoders
- SIMODRIVE sensor absolute value encoder with synchronous flange:
  - 6FX2001-5□S□□ with SSI interface
  - 6FX2001-5□E□□ with EnDat interface
  - 6FX2001-5□P□□ with Profibus DP interface
 as well as mounting-compatible encoders

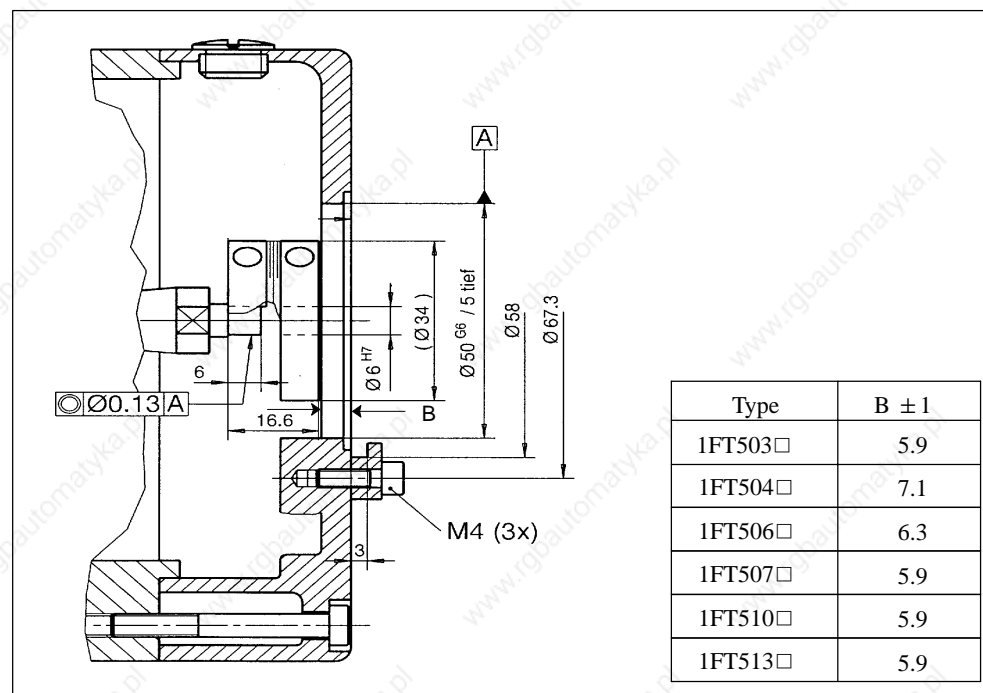

Fig. 3-5 Mounting absolute angular encoders with standard pulse encoder flange at motors 1FT503□ to 1FT513□

### 3.3 Holding brake

For a description of the function, refer to the "General Section" documentation.

The holding brake can be retrofitted!

This does not change the motor length.

Table 3-5 Technical data of the holding brakes used for 1FT5 motors

Motor type	Brake type	Holding torques $M_4$ <sup>1)</sup>		Dyn. torque $M_{1m}$ [Nm] 120 °C	DC current [A]	Power drain [W]	Opening time $t_2$ <sup>1)</sup> [ms]	Closing time <sup>1)</sup> [ms]	Moment of inertia [ $10^{-4}$ kgm <sup>2</sup> ]	Highest switching work <sup>2) 4)</sup> [J]
		[Nm]								
		20 °C	120 °C							
Standard motors, force-ventilated										
1FT503□	EBD 0.11B	1.2	1.0	0.75	0.3	7.5	20	10	0.07	24
1FT504□	EBD 0.2B	2.0	1.5	1.3	0.6	13	40	20	0.4	122
1FT506□	EBD 0.8B	12	10	7	0.7	16	55	15	1.1	291
1FT507□	EBD 2B	28	23	13	0.93	22	100	30	7.6	1005
1FT510□	EBD 4B	100	80	43	1.4	32	180	20	32	2150 <sup>3)</sup>
1FT513□	EBD 8B	200	140	60	1.7	40	260	70	76	9870
Short motors										
1FT507□	EBD 0.4B	6.5	5	3.5	0.8	20	30	15	1.1	148
1FT510□	EBD 2.2B	20	15	13	0.9	22	70	35	9.5	987

$M_{1m}$  = Average dynamic torque determined from the slip time  $t_3$

$M_4$  = Torque which can be transmitted taking into account the max. solenoid temperature, fluctuations in the frictional coefficient and spread of characteristic data

Refer to the "General Section" documentation for a definition of torques and switching times in compliance with VDE 0580.

- 1) Standardized acc. to VDE 0580 with resistor and diode
- 2) for each emergency stop with  $n=3000$  RPM
- 3) for each emergency stop with  $n=2000$  RPM
- 4)  $W=1/2 \cdot J_{tot} \cdot \omega^2$ ;  
 $J_{tot}$  in [kgm<sup>2</sup>],  
 $\omega$  in [1/s],  $W$  in [J]

## 3.4 Working brake (option C00)

### 3.4 Working brake (option C00)

The working brake is a fail-safe brake. This means that the brake is closed when it is in a no-current condition. However, the brake can be released in the no-voltage condition using a manual release lever.

The working brake cannot be ordered in conjunction with an integrated or mounted position encoder. Further, the brake can only be mounted to standard non-ventilated motors (not for 1FT503□, 1FT504□, 1FT506□ and not for short motors).

Mounting: Non-drive end  
 Degree of protection: IP 54  
 Connection: 24 V DC through a terminal box  
 Circuit connection: as for the holding brake  
 Dimensions: refer to Section 4.

Braking torque M can be subsequently reduced by up to 50% using the setting ring.

Table 3-6 Technical data, working brake

Motor type	Brake type	Brake torque m at speed n		Max. speed [RPM]	Highest switching power [kJ/h]	Rated-power [W]	Inter-locking-time [ms]	Moment of inertia [10 <sup>-4</sup> kgm <sup>2</sup> ]	Highest switching work (nominal value) [MJ]
		[Nm]	[RPM]						
1FT507□	13A	32	250	4000	460	38	40	5	175
1FT510□	16A	60	250	3500	570	60	85	14	345
1FT513□	19A	130	125	3000	640	75	100	38	440



## 3.5 Gearbox

Engineering, refer to the "General Section" documentation.

### 3.5.1 1-stage planetary gearbox

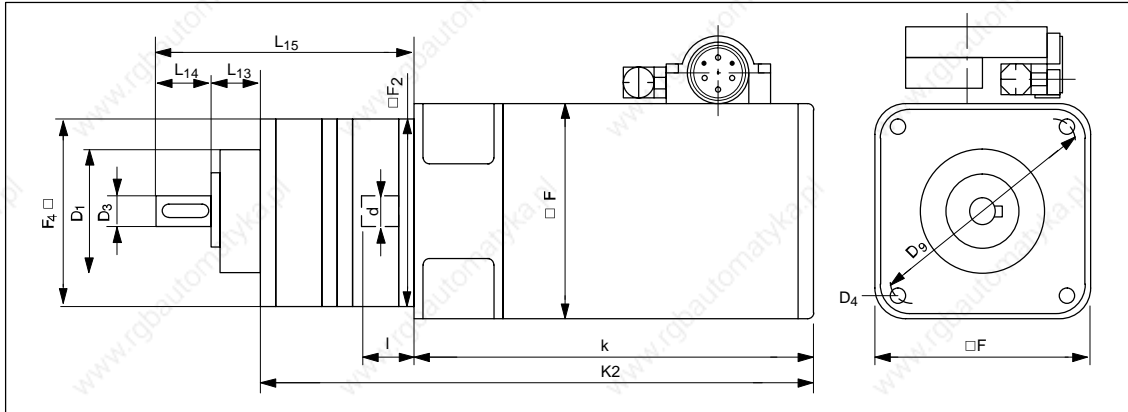

Fig. 3-6 1FT5 series with 1-stage planetary gearbox (alpha company), dimensions, refer to Table 3-7

Table 3-7 1FT5 series with 1-stage planetary gearbox (alpha company)

Standard motor version					1-stage planetary gearbox									Motor mit planetary gearbox	
Type	Dimensions				Type	Dimensions								Dimensions	
	k	l	d	□F		L13	L14	L15	D1	D3	D4	D9	□F4	K2	□F2
1FT5034	181	23	11	70	SP 060-MF1	20	28	129	60	16	5.5	68	62	262	70
1FT5036	206													287	
1FT5042	165													265	
1FT5044	190	30	14	92	SP 075-MF1	20	36	156	70	22	6.6	85	76	290	90
1FT5046	240													340	
1FT5062	241													355	
1FT5064	281	40	19	115	SP 100-MF1	30	58	202	90	32	9	120	101	395	100
1FT5066	321													435	
1FT5072	273													418	
1FT5074	323	50	24	142	SP 140-MF1	30	82	257	130	40	11	165	141	468	140
1FT5076	373													518	
1FT5102	352													537	
1FT5104	402	58	32	190	SP 180-MF1	30	82	297	160	55	13	215	182	587	190
1FT5106	452													637	
1FT5108	502													687	
1FT5132	429													625	
1FT5134	479	82	48	260	SP 210-MF1	38	105	339	180	75	17	250	212	675	260
1FT5136	529													725	
1FT5138	604													800	

## 3.5 Gearbox

## Gearbox selection for 1-stage planetary gearbox

Table 3-8 Selection for 1-stage planetary gear (alpha company, SP series)  
 Ordering data: **1FT5□□□-0A□71-1-Z**  
 Order No. of the motor (standard type) with codes **-Z** and **V□□**  
 Code for mounting the planetary gear assigned to the specific motor

Motor type non-venti- lated	Planetary gearbox 1-stage		Available gearbox ratios $i = 4...10$				Max. perm. input speed $n_{G1}$ [RPM]	Max. perm. output torque $M_{G2}$ [Nm]	Max. perm. drive out shaft load <sup>1)</sup>		Moment of inertia gearbox	
	Type	Weight approx. [kg]	4	5	7	10			$F_r$ [N]	$F_a$ [N]	$J_G$ at $i=4$ $10^{-4}$ kgm <sup>2</sup>	$J_G$ at $i=10$ $10^{-4}$ kgm <sup>2</sup>
1FT5034 1FT5036	SP 060-MF1	1.5	X	X	X	X	6000	40 (32) <sup>3)</sup>	2600	2300	0.14	0.12
1FT5042 1FT5044 1FT5046	SP 075-MF1	2.8	X	X	X	X	6000	100 (80) <sup>3)</sup>	3800	3200	0.57	0.4
1FT5062 1FT5064 1FT5066	SP 100-MF1	6.2	X	X	X	X	4500	250 (200) <sup>3)</sup>	6000	5400	2.0	1.3
1FT5072 1FT5074 1FT5076	SP 140-MF1	11.5	X	X	X	X	4000	500 (400) <sup>3)</sup>	9000	9400	5.7	3.5
1FT5102 1FT5104 1FT5106 1FT5108	SP 180-MF1	27	X	X	X	X	3500	1100 (880) <sup>3)</sup>	14000	13500	30.6	17.4
1FT5132 1FT5134 1FT5136 1FT5138	SP 210-MF1	53	X	X	X	X	2500	1900 (1520) <sup>3)</sup>	18000	22500	75.8	47.1
Code												
Gearbox shaft with keyway			V02	V03	V05	V09						
Gearbox shaft without keyway			V22	V23	V25	V29						

1) Nominal values for the max. permissible drive-out shaft load at the center of the shaft for a drive-out speed of 300 RPM

2) For SP 060 and SP 075: 6 arcmin

3) Values in brackets (...) for  $i = 10$

### 3.5.2 2-stage planetary gearbox

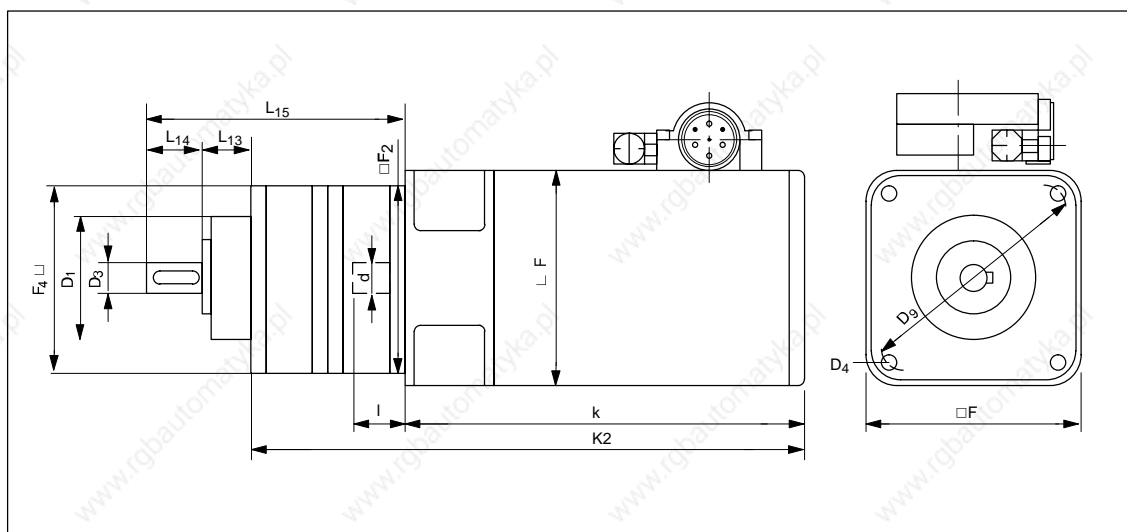

Fig. 3-7 1FT5 series with 2-stage planetary gearbox (alpha company), dimensions, refer to Table 3-9

## 3.5 Gearbox

Table 3-9 1FT5 series with 2-stage planetary gearbox (alpha company)

Standard motor version					2-stage planetary gearbox										Motor with planetary gearbox		
Type	Dimensions				Type	Dimensions										Dimensions	
	k	l	d	□F		L <sub>13</sub>	L <sub>14</sub>	L <sub>15</sub>	D <sub>1</sub>	D <sub>3</sub>	D <sub>4</sub>	D <sub>9</sub>	□F <sub>4</sub>	K	□F <sub>2</sub>		
1FT5034	181	23	11	70	SP 075-MF2	20	36	183	70	22	6.6	85	76	308	80		
1FT5036	206													333			
1FT5042	165	30	14	92										292	90		
1FT5044	190													317			
1FT5042	165	30	14	92	SP 100-MF2	30	58	235	90	32	9	120	101	312	100		
1FT5044	190													337			
1FT5046	240													387			
1FT5062	241													40		19	115
1FT5064	281				428												
1FT5064	281	40	19	115	SP 140-MF2	30	82	297	130	40	11	165	141	466		140	
1FT5066	321													506			
1FT5072	273	50	24	142										458			
1FT5072	273	50	24	142	SP 180-MF2	30	82	316	160	55	13	215	182	477	140		
1FT5074	323													527			
1FT5076	373													577			
1FT5072	273	50	24	142	SP 210-MF2	38	105	359	180	75	17	250	212	489	140		
1FT5074	323													539			
1FT5076	373													589			
1FT5102	352	58	32	190	SP 240-MF2	40	130	413	200	85	17	290	240	568	190		
1FT5076	373	50	24	142										616			
1FT5102	352													595			
1FT5104	402	58	32	190										645	190		
1FT5106	452													695			
1FT5108	502													745			

### Gearbox selection for 2-stage planetary gearbox

Table 3-10 Selection for 2-stage planetary gear (alpha company, SP series)  
 Ordering data: **1FT5□□□-0A□71-1-Z**  
 Order No. of the motor (standard type) with codes -Z and V□□  
 Code for mounting the planetary gear assigned to the specific motor

Motor type non-ventilated	Planetary gearbox 2-stage Rotary play ≤ 6 arcmin		Available gearbox ratios $i = 16..0.50$					Max. perm. input speed $n_{G1}$ [RPM]	Max. perm. output torque $M_{G2}$ [Nm]	Max. perm. drive out shaft load <sup>1)</sup>		Moment of inertia gearbox $J_G$ at $i=20$ $10^{-4}$ $\text{kgm}^2$
	Type	Weight approx. [kg]	16	20	28	40	50			$F_r$ [N]	$F_a$ [N]	
1FT5034	SP 075-MF2	3.1	X	X	X	X	X	6000	100	3800	3200	0.47
1FT5036			X	X	X	X	X					
1FT5042			X	X	X	X						
1FT5044			X	X								
1FT5042	SP 100-MF2	7.1			X	X	X	4500	250	6000	5400	1.7
1FT5044					X	X	X					
1FT5046			X	X	X	X	X					
1FT5062			X	X								
1FT5064			X	X								
1FT5064	SP 140-MF2	14.5			X	X	X	4000	500	9000	9400	4.4
1FT5066			X	X								
1FT5072			X	X								
1FT5072	SP 180-MF2	29			X	X		4000	1100	14000	13500	5.5
1FT5074			X	X								
1FT5076			X	X								
1FT5072	SP 210-MF2	51				X	X	3500	1900	18000	22500	34.5
1FT5074						X	X					
1FT5076					X							
1FT5102			X	X								
1FT5076	SP 240-MF2	78			X	X	X	3500	3400	27000	27800	43.1
1FT5102					X	X	X					
1FT5104			X	X	X							
1FT5106			X	X	X							
1FT5108			X	X								
Code												
Gearbox shaft with keyway			V12	V13	V15	V16	V17					
Gearbox shaft without keyway			V32	V33	V35	V36	V37					

1) Nominal values for the max. permissible drive-out shaft load at the center of the shaft for a drive-out speed of 300 RPM



3.5 Gearbox

Space for your notes

---

---

---

---

---

---

---

---

---

---

---

---

---

---

---

---

---

---

---

---

---

---

---

## Dimension Drawings

---

### Note

Siemens AG reserves the right to change the dimensions of motors without prior notice as part of ongoing improvements to the mechanical design. This means that dimensions drawings can go out-of-date.

Up-to-date dimension drawings can be requested at no charge. Please contact your local Siemens office.

---

### Standard type of construction, basic version

1FT503□ non-ventilated with Size 1 connector .....	1FT5/4-97
1FT504□ non-ventilated with Size 1 connector .....	1FT5/4-98
1FT506□ non-ventilated with Size 1 connector .....	1FT5/4-99
1FT507□ non-ventilated with Size 1 connector .....	1FT5/4-100
1FT507□ non-ventilated with Size 2 connector .....	1FT5/4-101
1FT510□ non-ventilated with Size 2/3 connector .....	1FT5/4-102
1FT513□ non-ventilated with Size 2/3 connector .....	1FT5/4-103
1FT507□ force-ventilated with Size 2/3 connector .....	1FT5/4-104
1FT510□ force-ventilated with Size 2/3 connector .....	1FT5/4-105
1FT513□ force-ventilated with Size 2/3 connector .....	1FT5/4-106

### Standard type of construction, pulse encoder mounting option

1FT503□ non-ventilated with Size 1 connector .....	1FT5/4-107
1FT504□ non-ventilated with Size 1 connector .....	1FT5/4-108
1FT506□ non-ventilated with Size 1 connector .....	1FT5/4-109
1FT507□ non-ventilated with Size 1 connector .....	1FT5/4-110
1FT507□ non-ventilated with Size 2 connector .....	1FT5/4-111
1FT510□ non-ventilated with connector .....	1FT5/4-112
1FT513□ non-ventilated with Size 2/3 connector .....	1FT5/4-113

### Short type of construction, basic version

1FT507□ non-ventilated with Size 1 connector .....	1FT5/4-114
1FT510□ non-ventilated with Size 2 connector .....	1FT5/4-115

**Short type of construction, pulse encoder mounting option**

1FT507□ non-ventilated with Size 1 connector .....	1FT5/4-116
1FT510□ non-ventilated with Size 2 connector .....	1FT5/4-117

**Standard type of construction, working brake option**

1FT507□ non-ventilated with Size 2 connector .....	1FT5/4-118
1FT510□ non-ventilated with Size 2/3 connector .....	1FT5/4-119
1FT513□ non-ventilated with Size 2/3 connector .....	1FT5/4-120



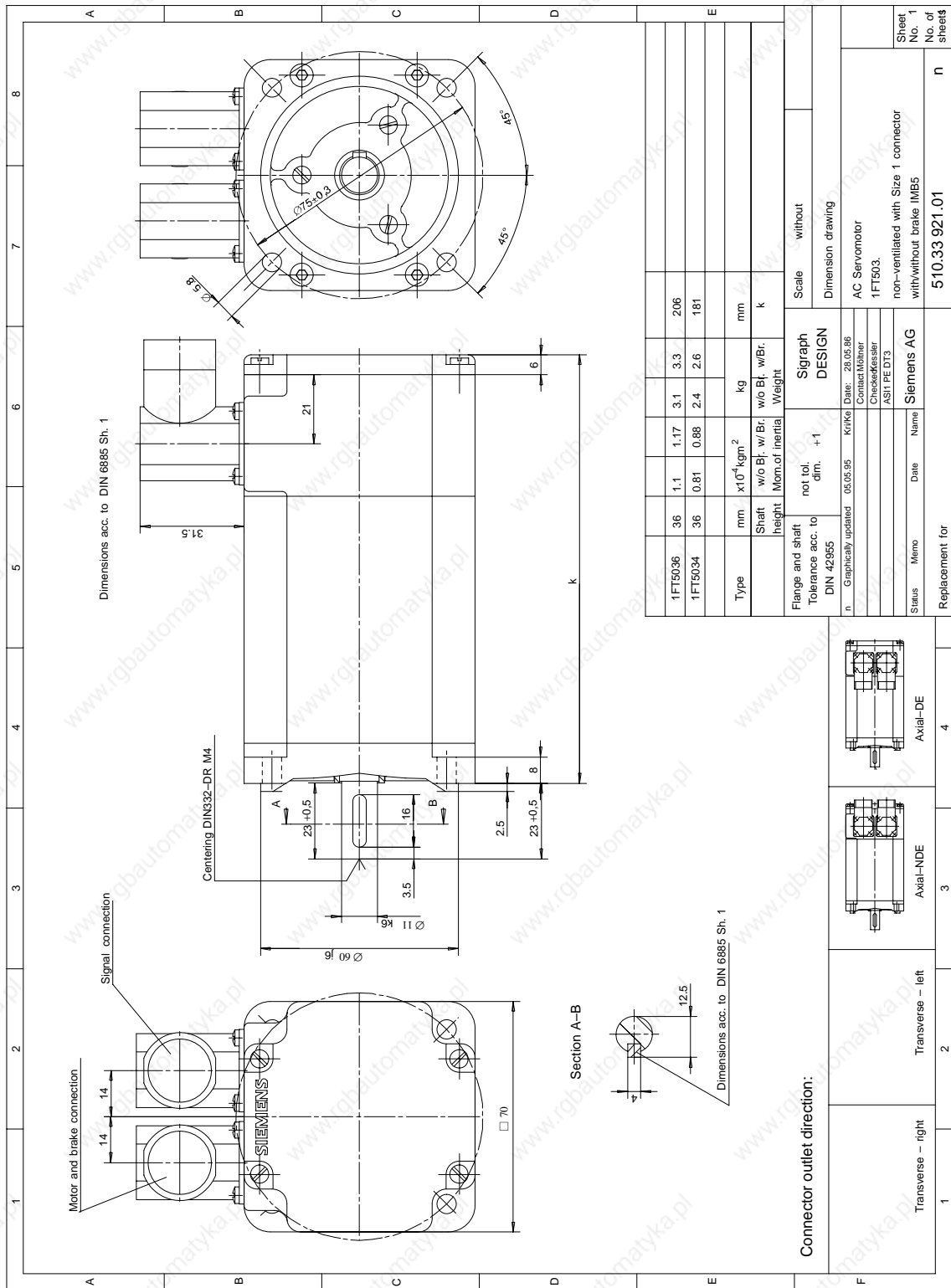

Fig. 4-1 1FT503□ non-ventilated with Size 1 connector

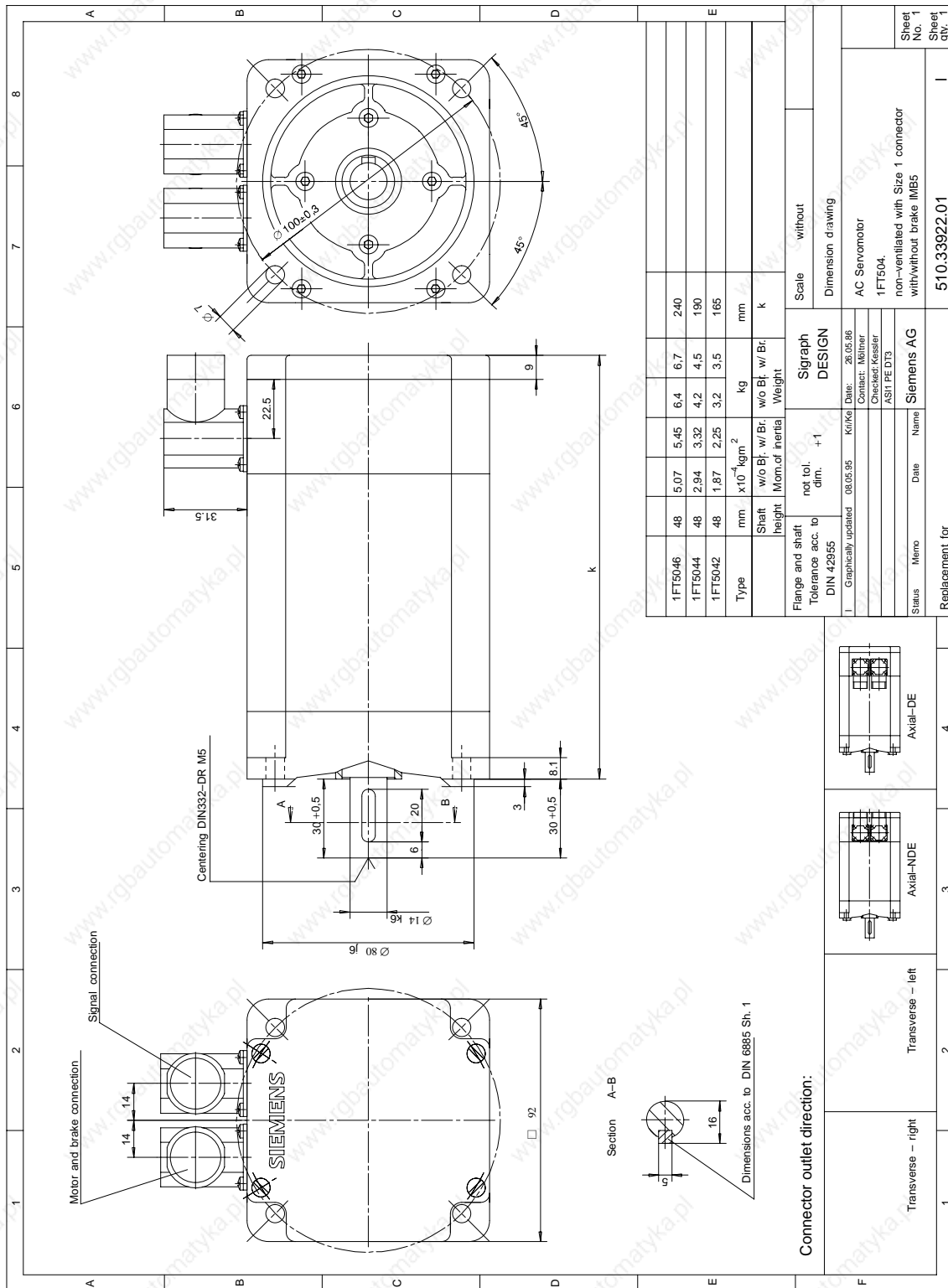
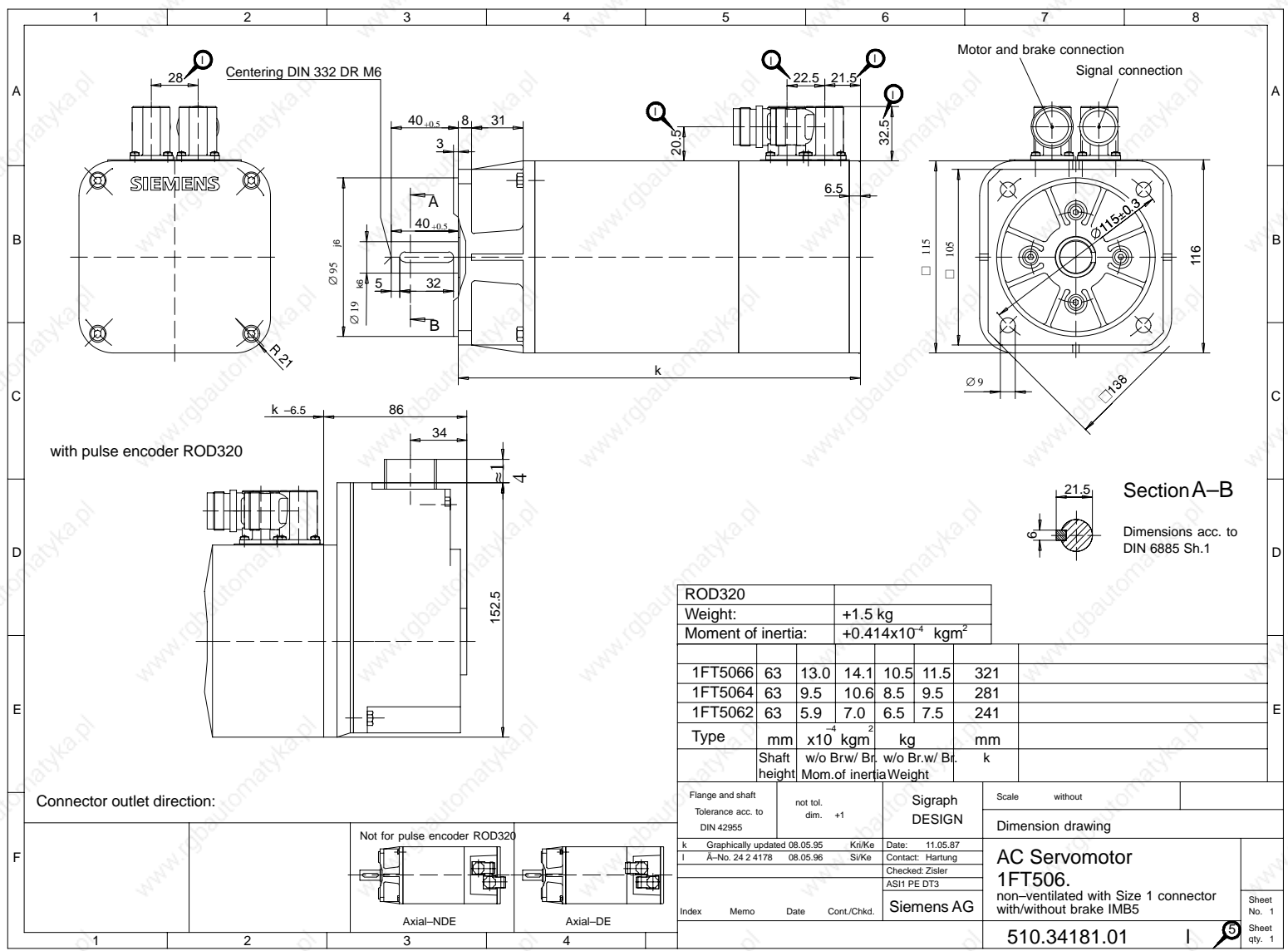

Fig. 4-2 1FT504□ non-ventilated with Size 1 connector



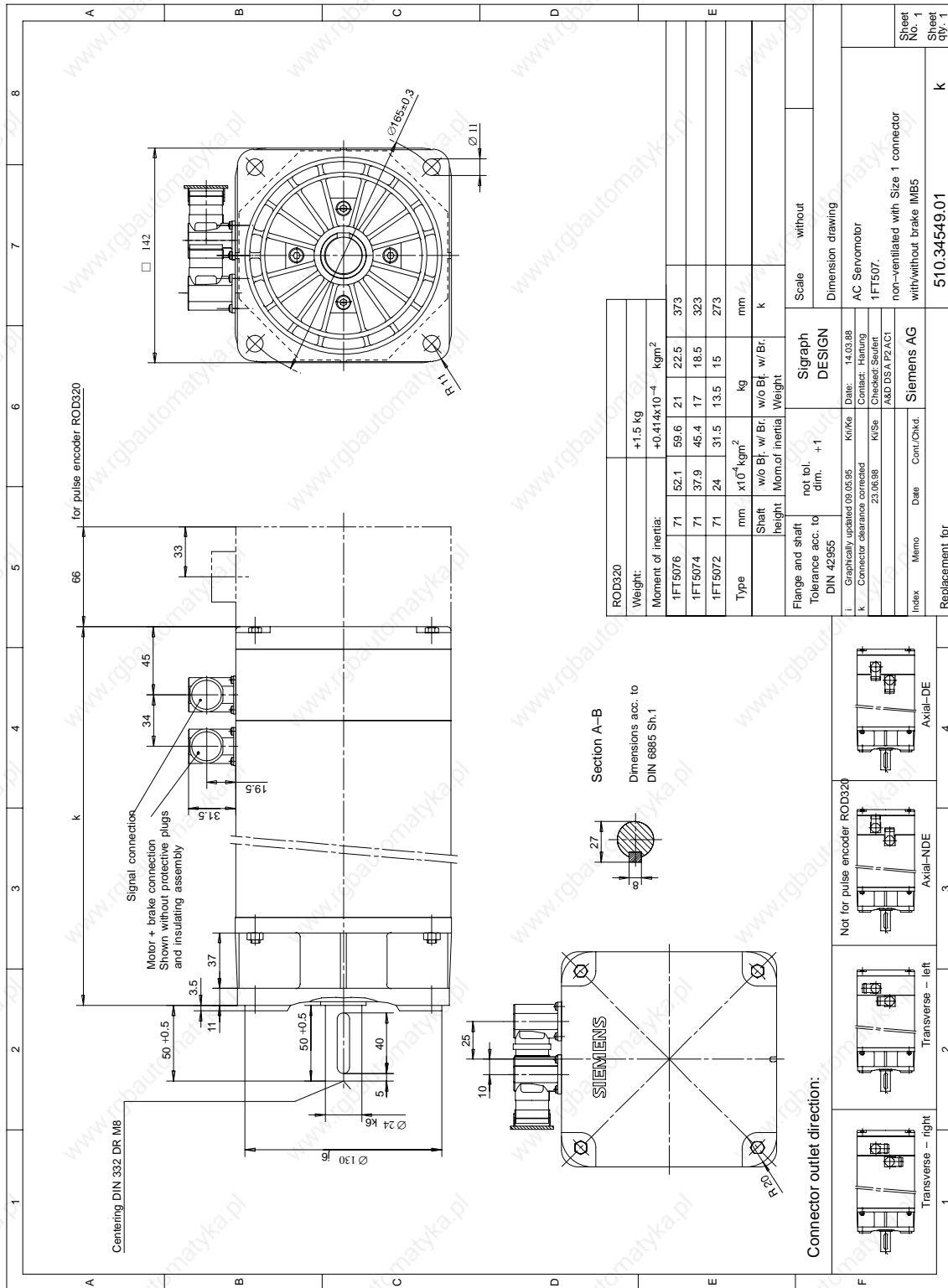

Fig. 4-4 1FT507□ non-ventilated with Size 1 connector

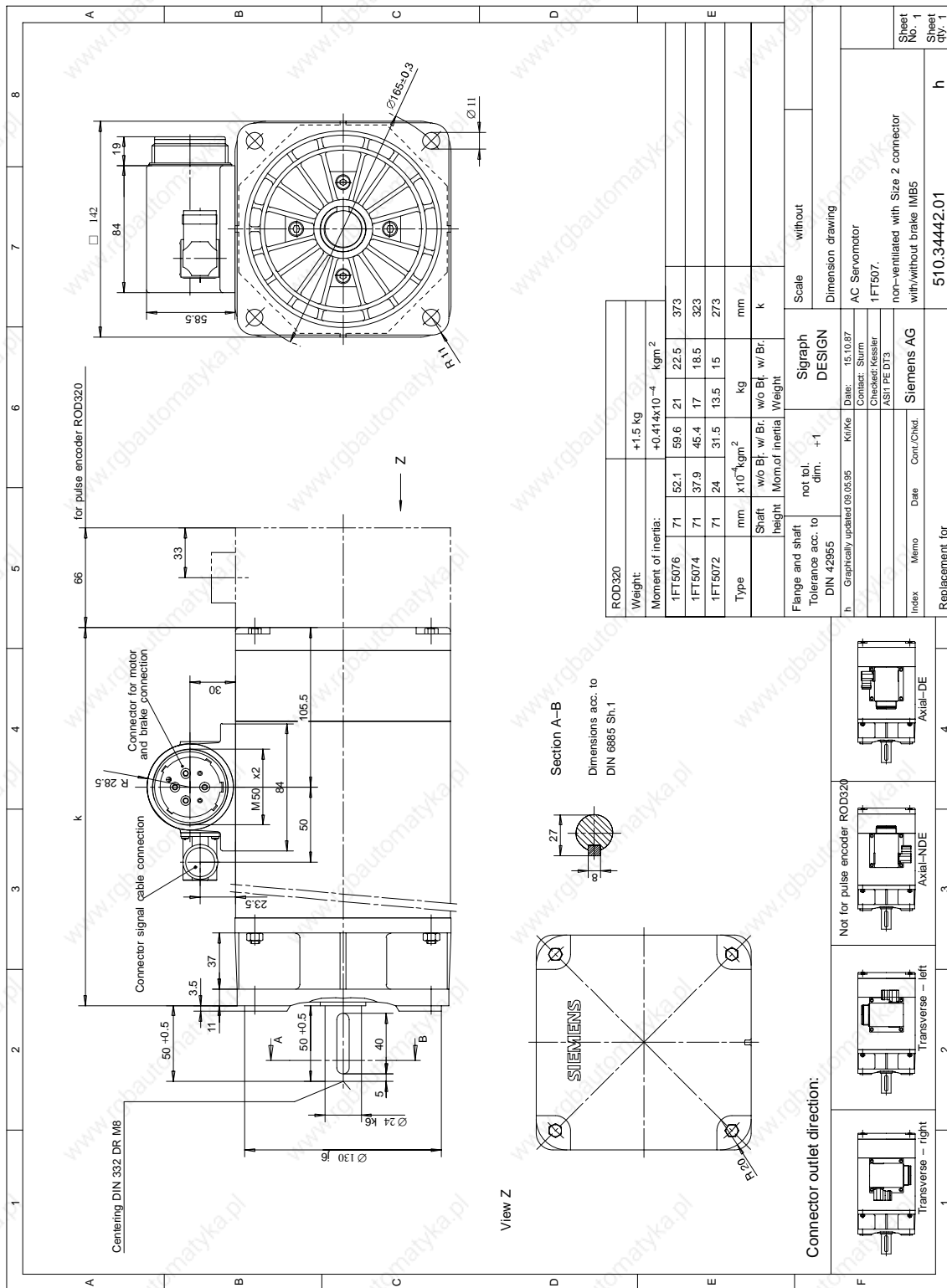

Fig. 4-5 1FT507□ non-ventilated with Size 2 connector

ROD320	Weight	+1.5 kg
	Moment of inertia:	+0.414x10 <sup>-4</sup> kgm <sup>2</sup>
1FT5076	71	52.1 59.6 21 22.5 373
1FT5074	71	37.9 45.4 17 18.5 323
1FT5072	71	24 31.5 13.5 15 273
Type	mm	x10 <sup>-4</sup> kgm <sup>2</sup> kg mm k
Flange and shaft	Shaft	w/o Br. w/ Br. w/o Br. w/ Br.
Tolerance acc. to	height	Mom. of inertia
DIN 42655	not tol.	dim. +1
h	Graphically updated 09.05.95	Kri/Ke
	Date:	15.10.87
	Contact:	Sturm
	Checked:	Keiser
	ASIT PE DT3	
Index	Memo	Date
	Cont./Chkd.	Siemens AG
Replacement for		510.34442.01
	Scale	without
	Dimension drawing	
	AC Servomotor	
	1FT507.	
	non-ventilated with Size 2 connector	
	with/without brake IMB5	
Sheet No. 1		
Sheet qty. 1		

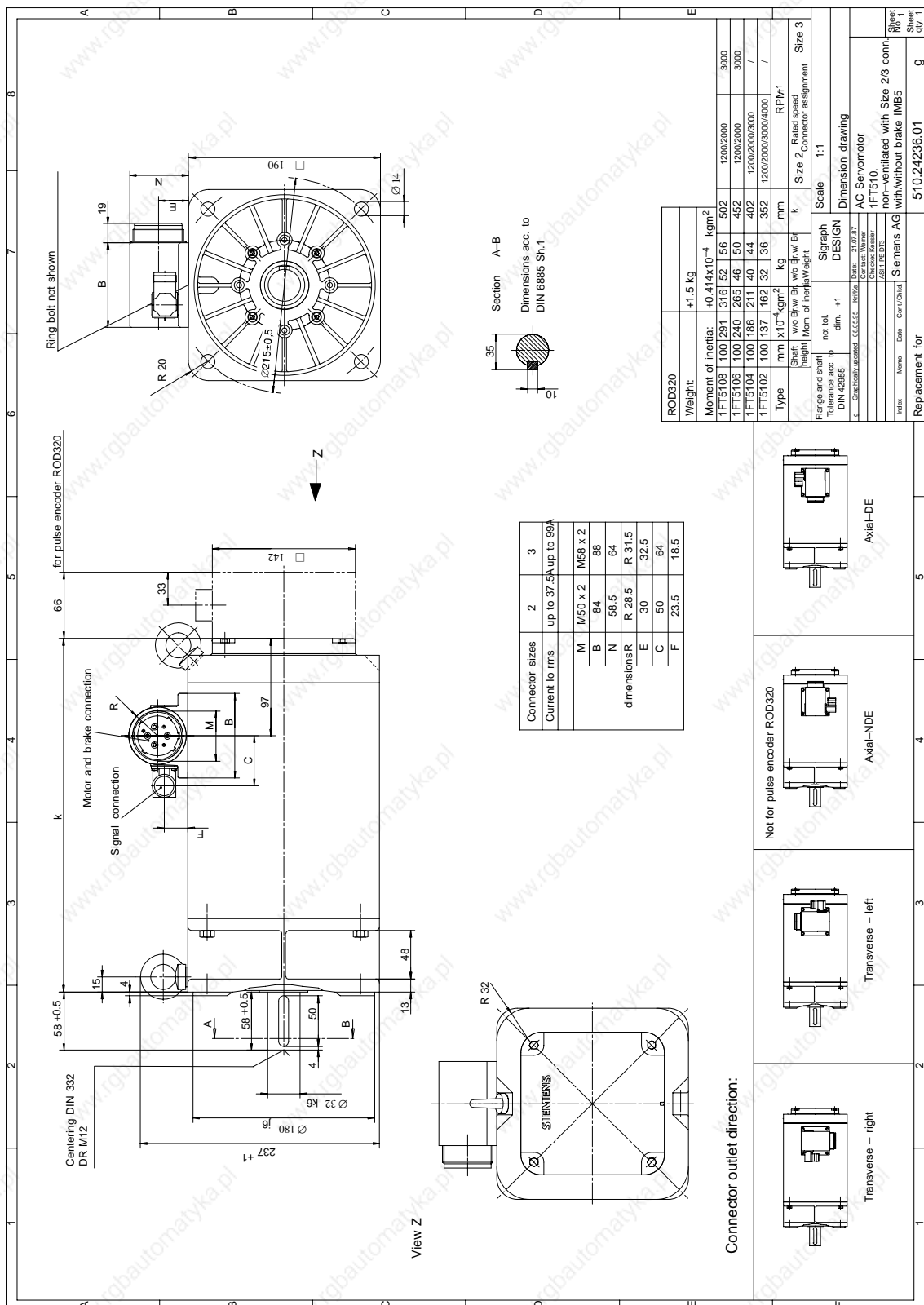

Fig. 4-6 1FT510 non-ventilated with Size 2/3 connector



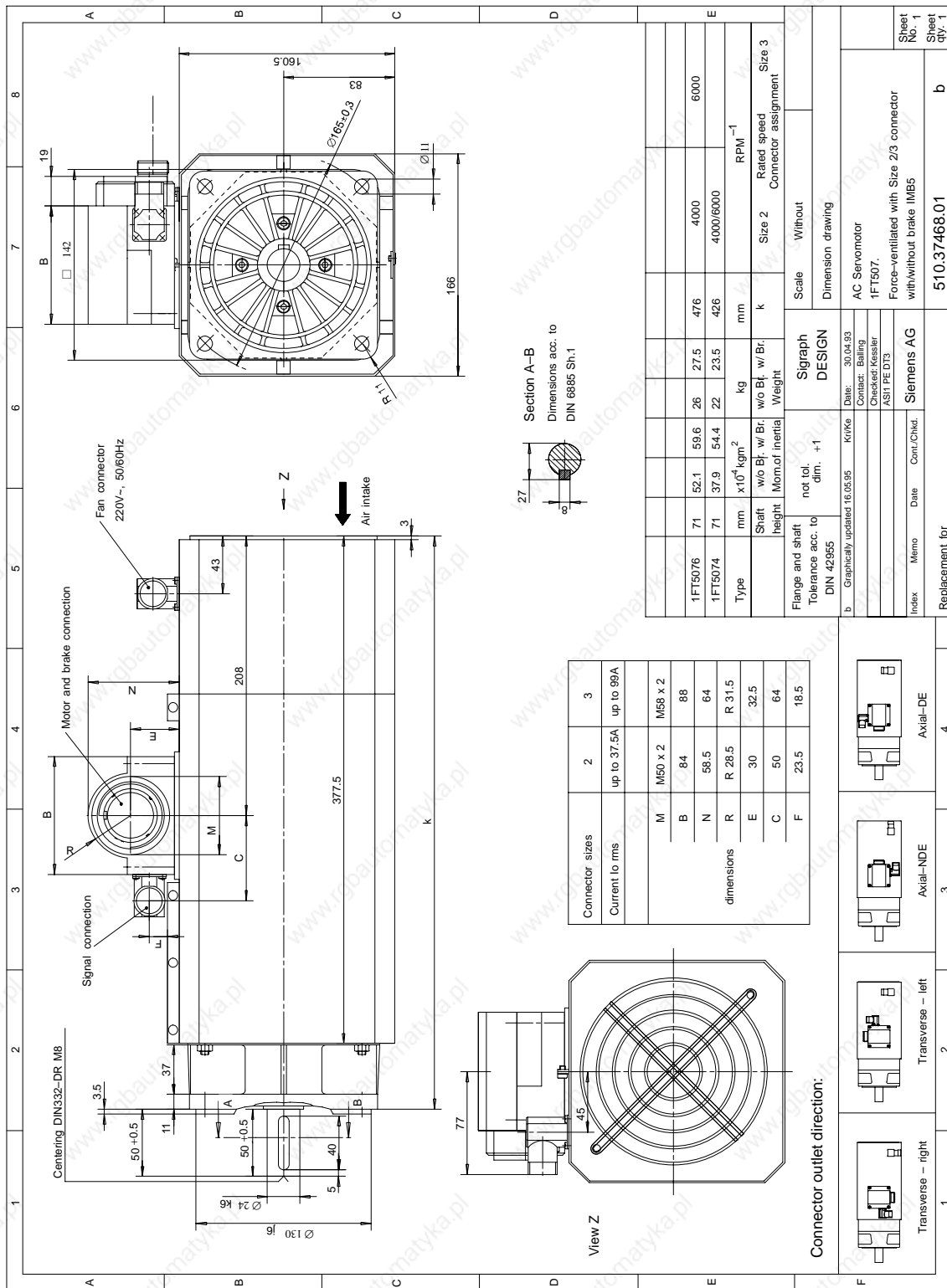
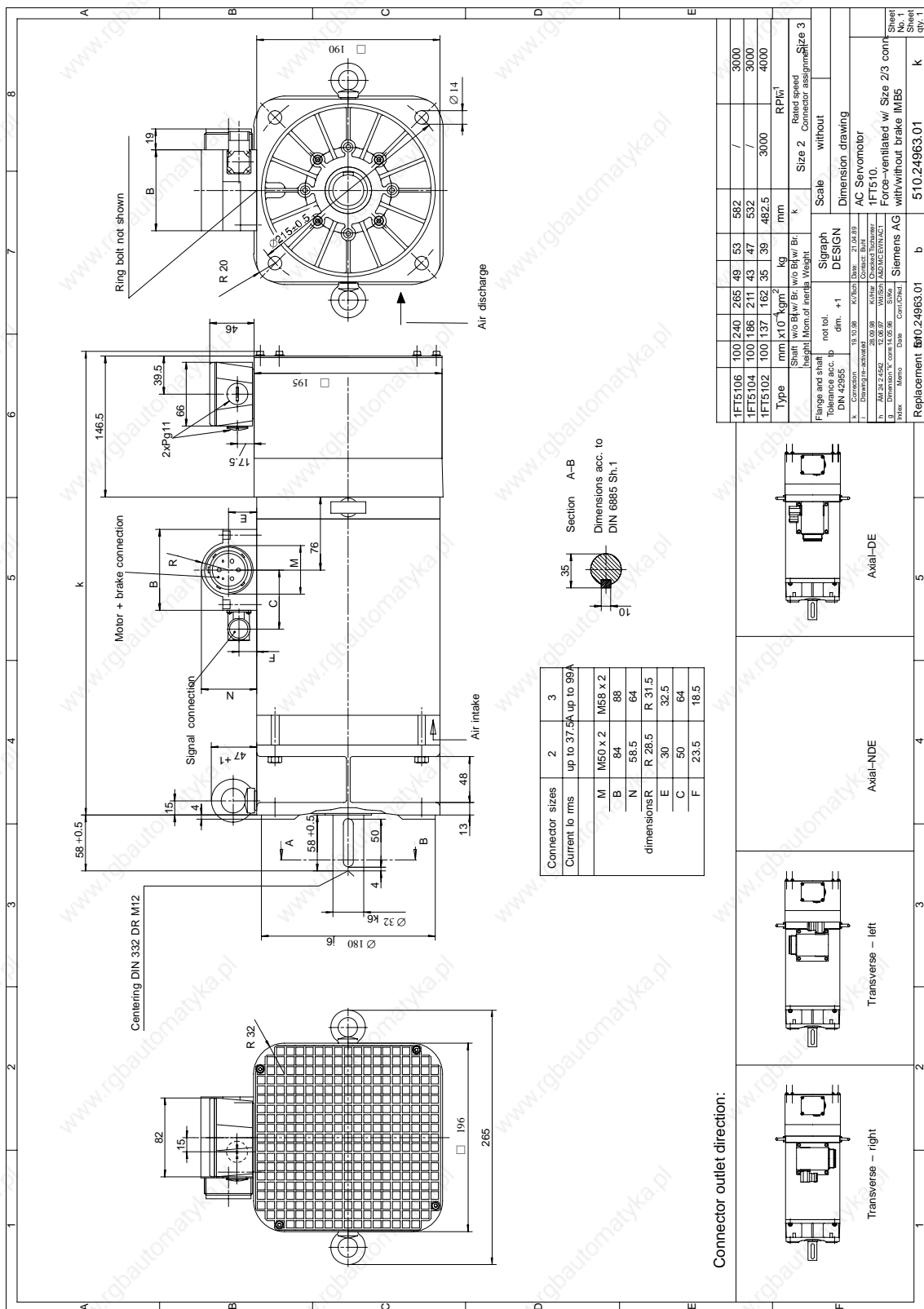

Fig. 4-8 1FT507 force-ventilated with Size 2/3 connector





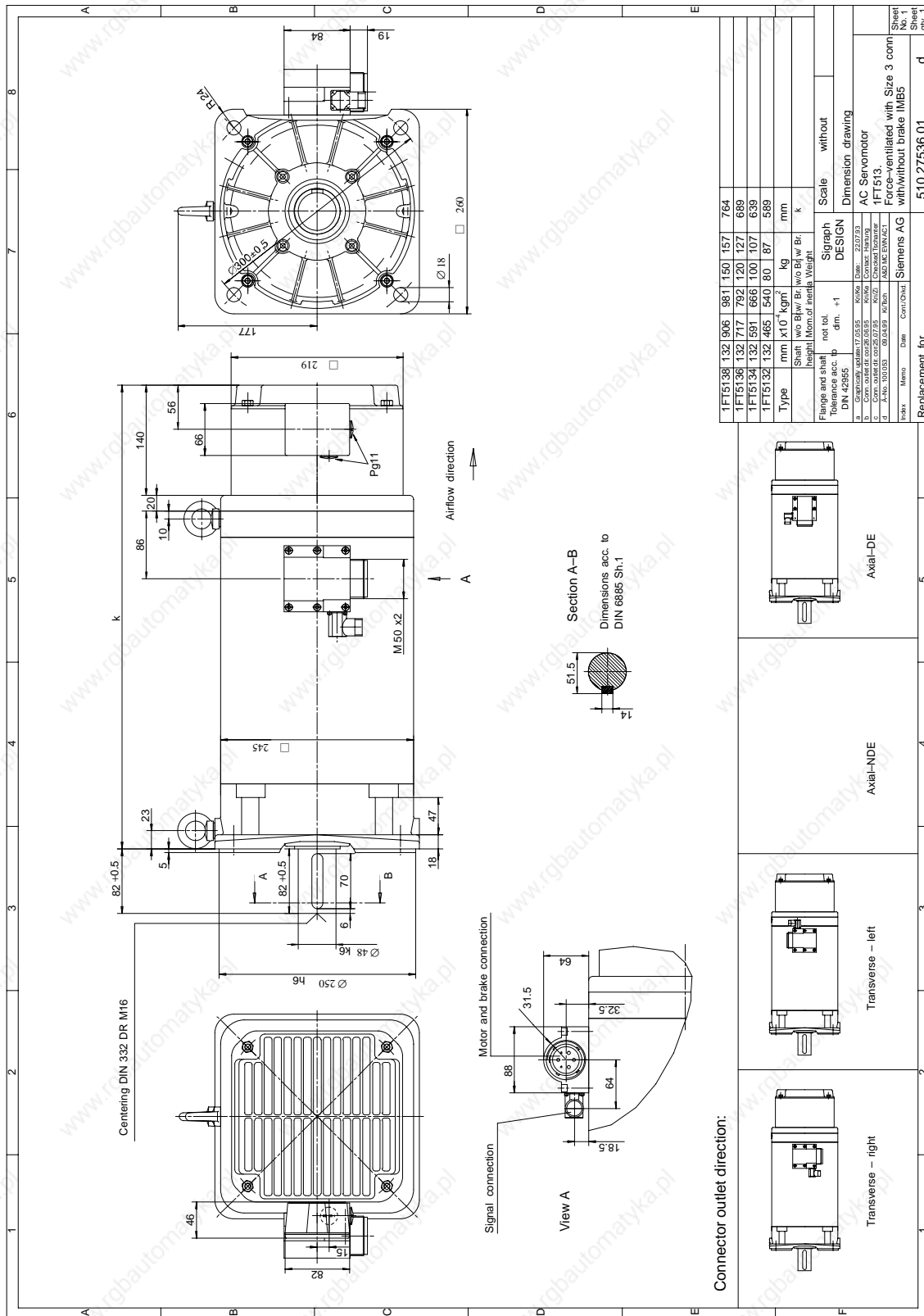

Fig. 4-10 1FT513 force-ventilated with Size 3 connector

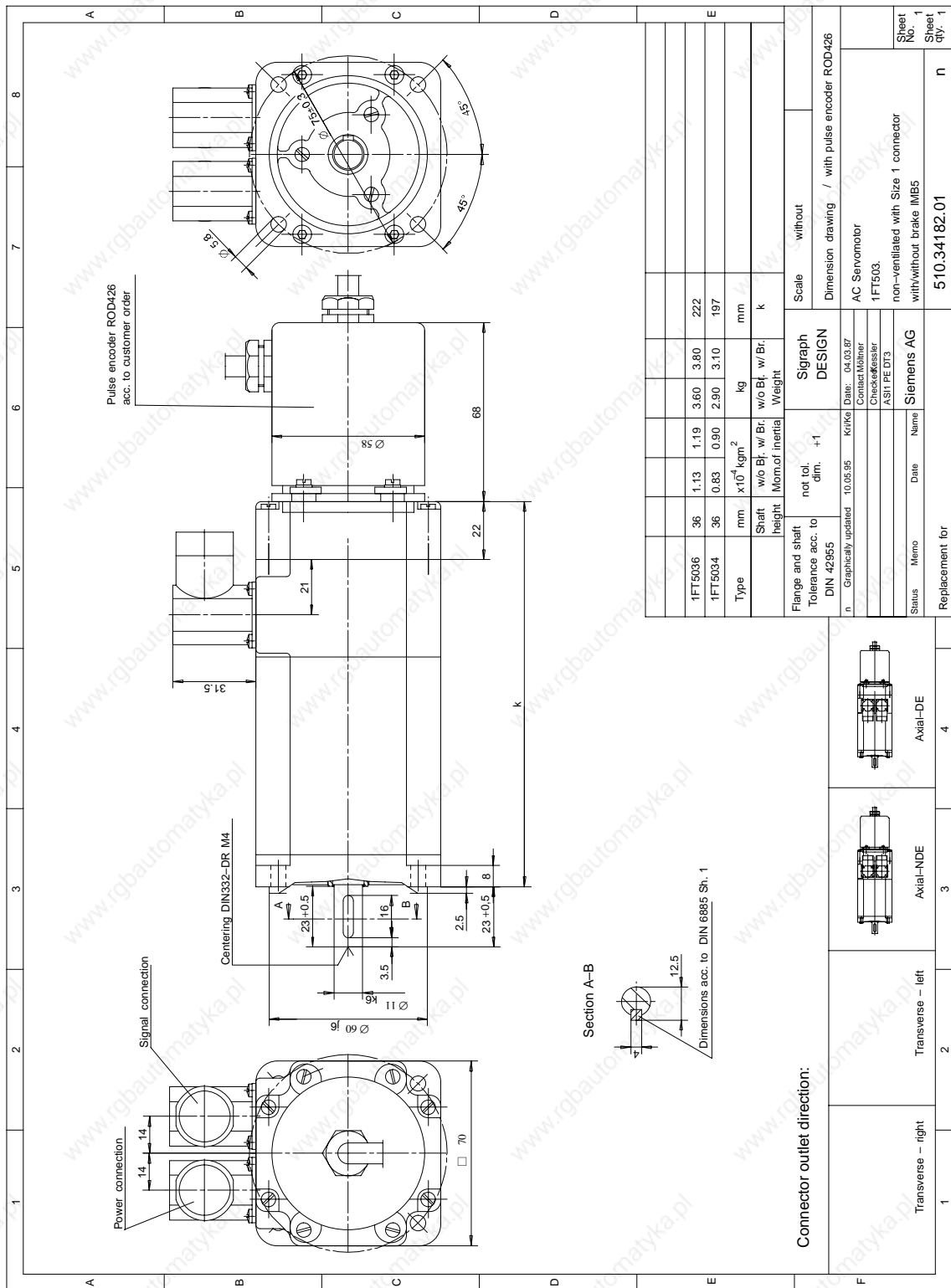

Fig. 4-11 1FT503□ non-ventilated with Size 1 connector

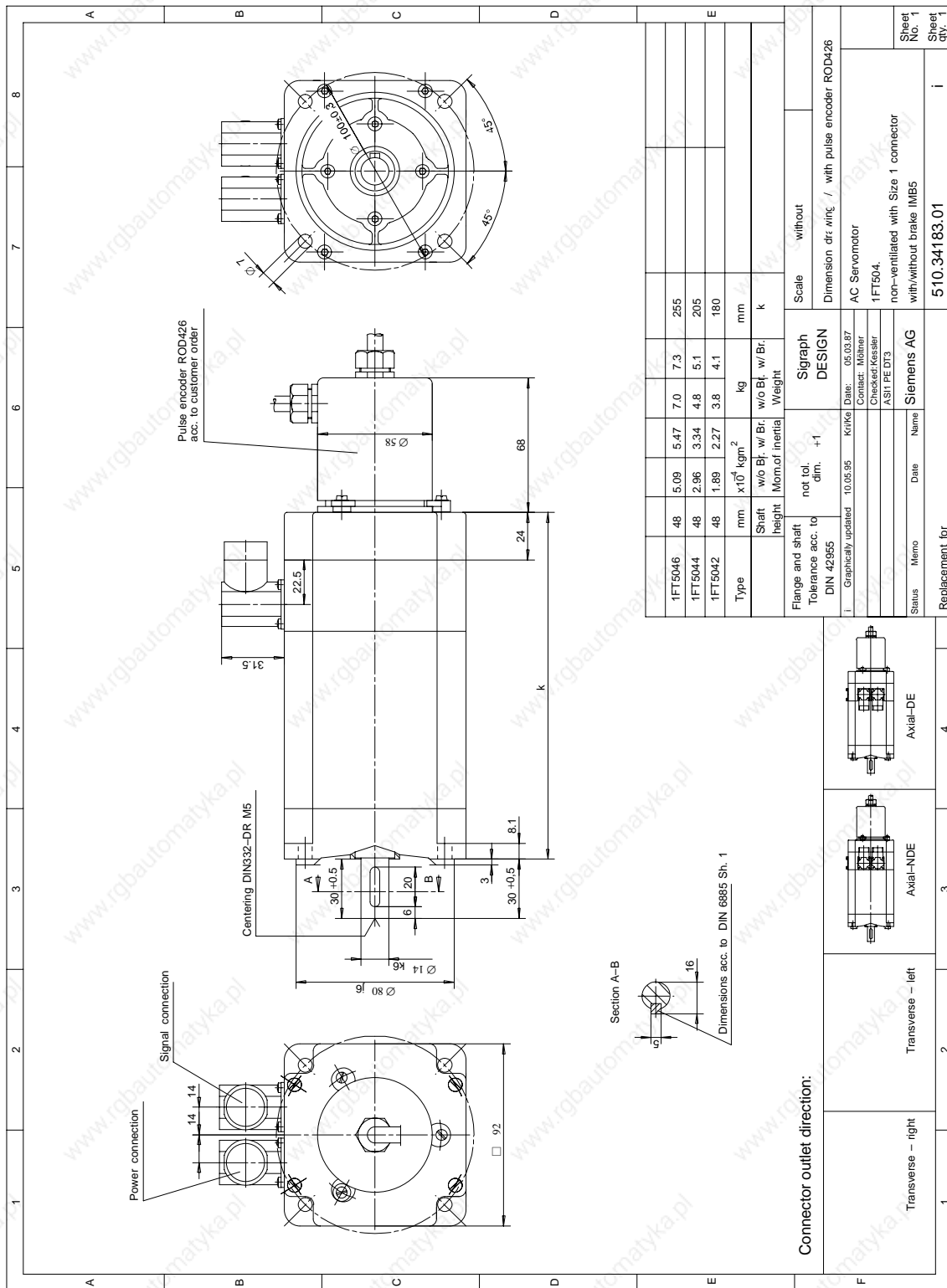

Fig. 4-12 1FT504□ non-ventilated with Size 1 connector

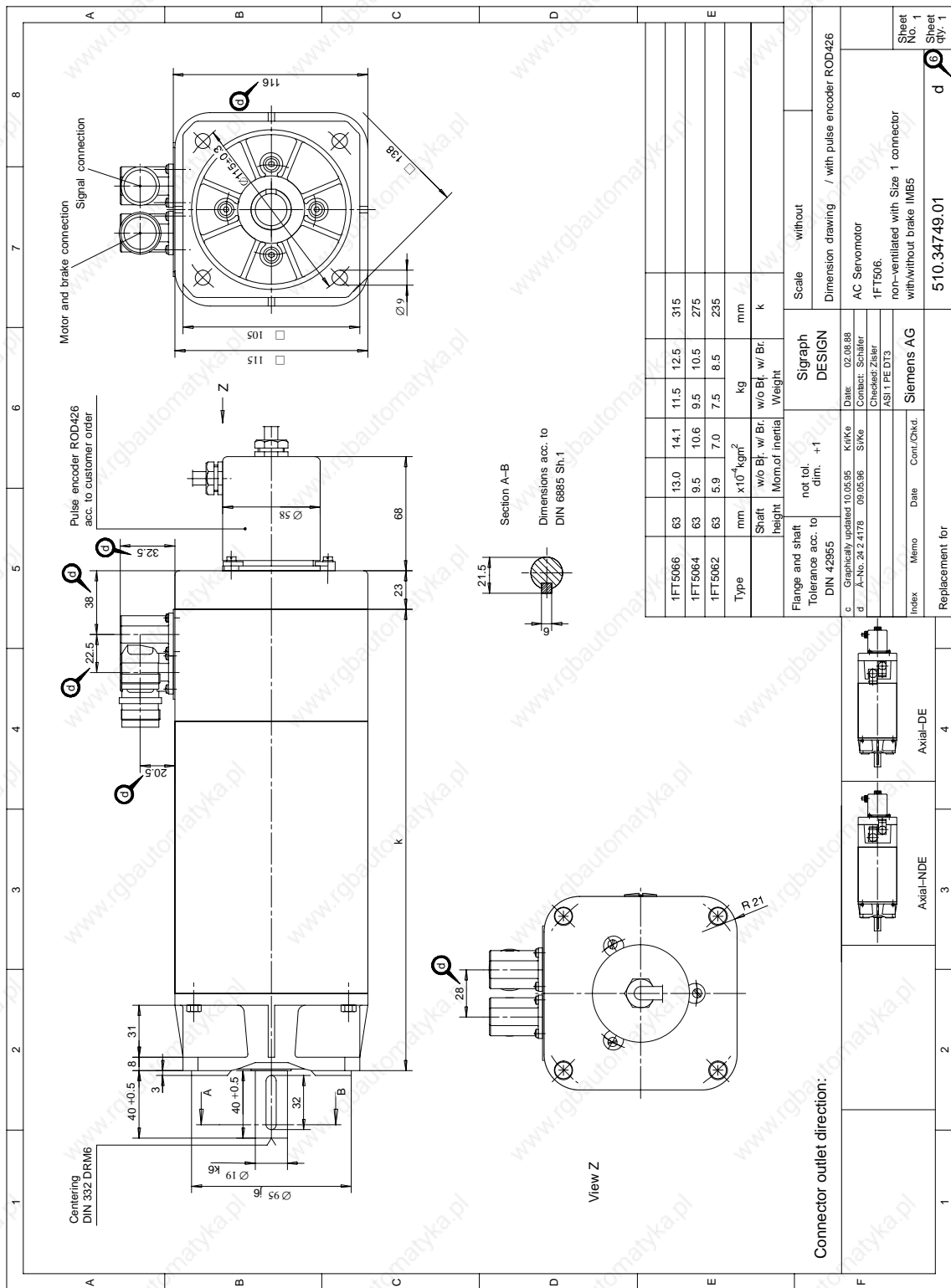

Fig. 4-13 1FT5062 non-ventilated with Size 1 connector

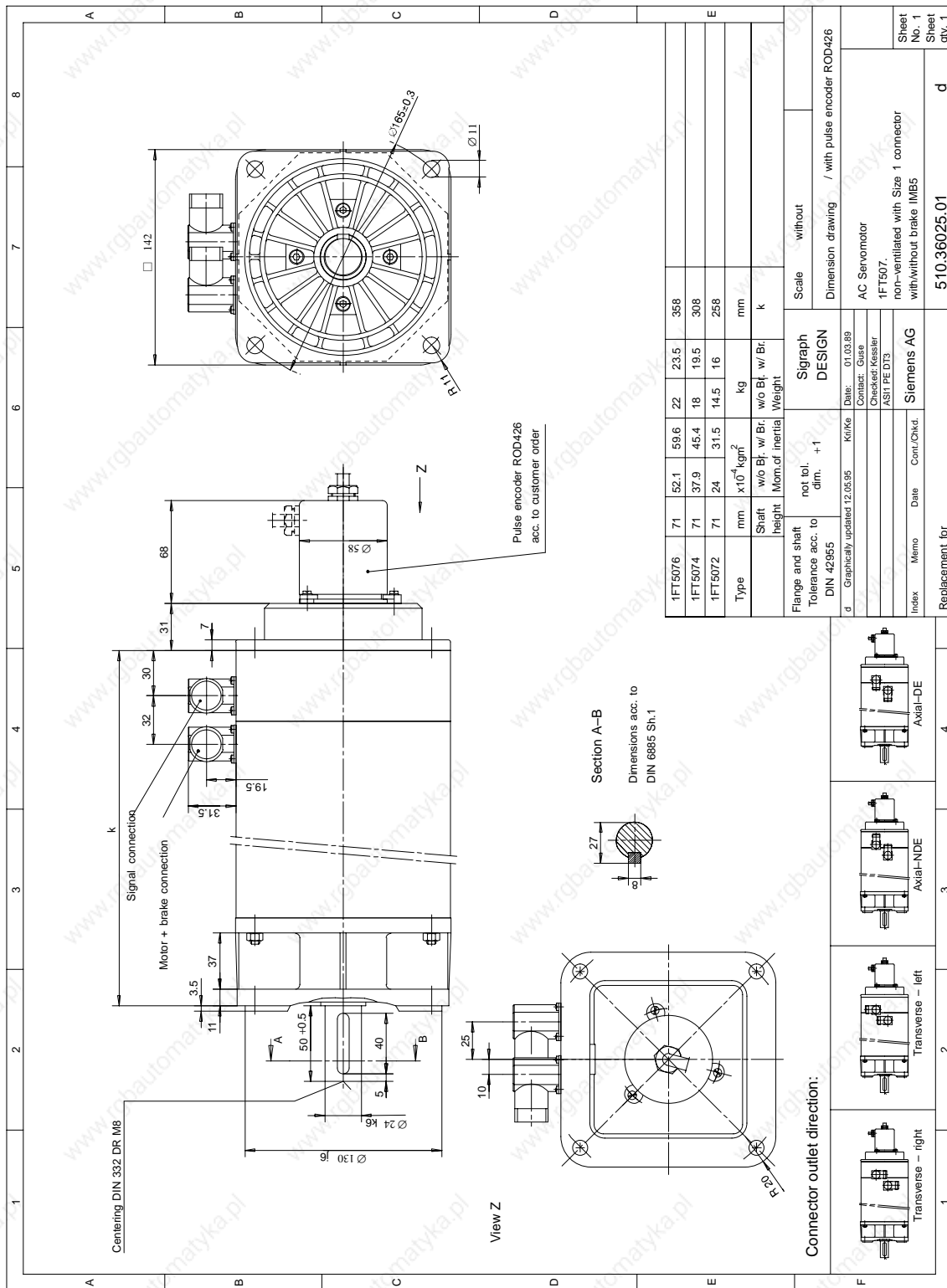

Fig. 4-14 1FT507□ non-ventilated with Size 1 connector

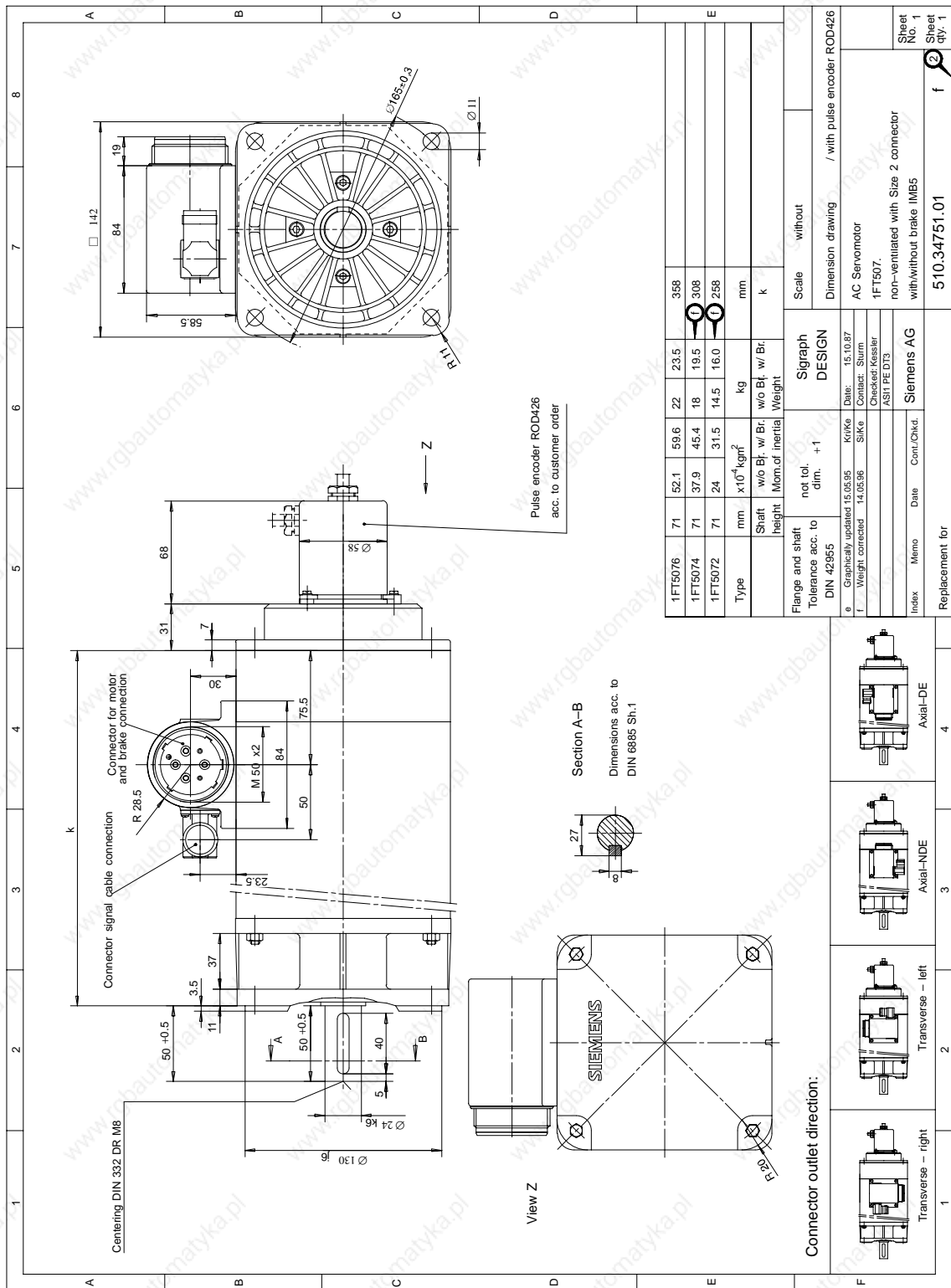

Fig. 4-15 1FT507□ non-ventilated with Size 2 connector

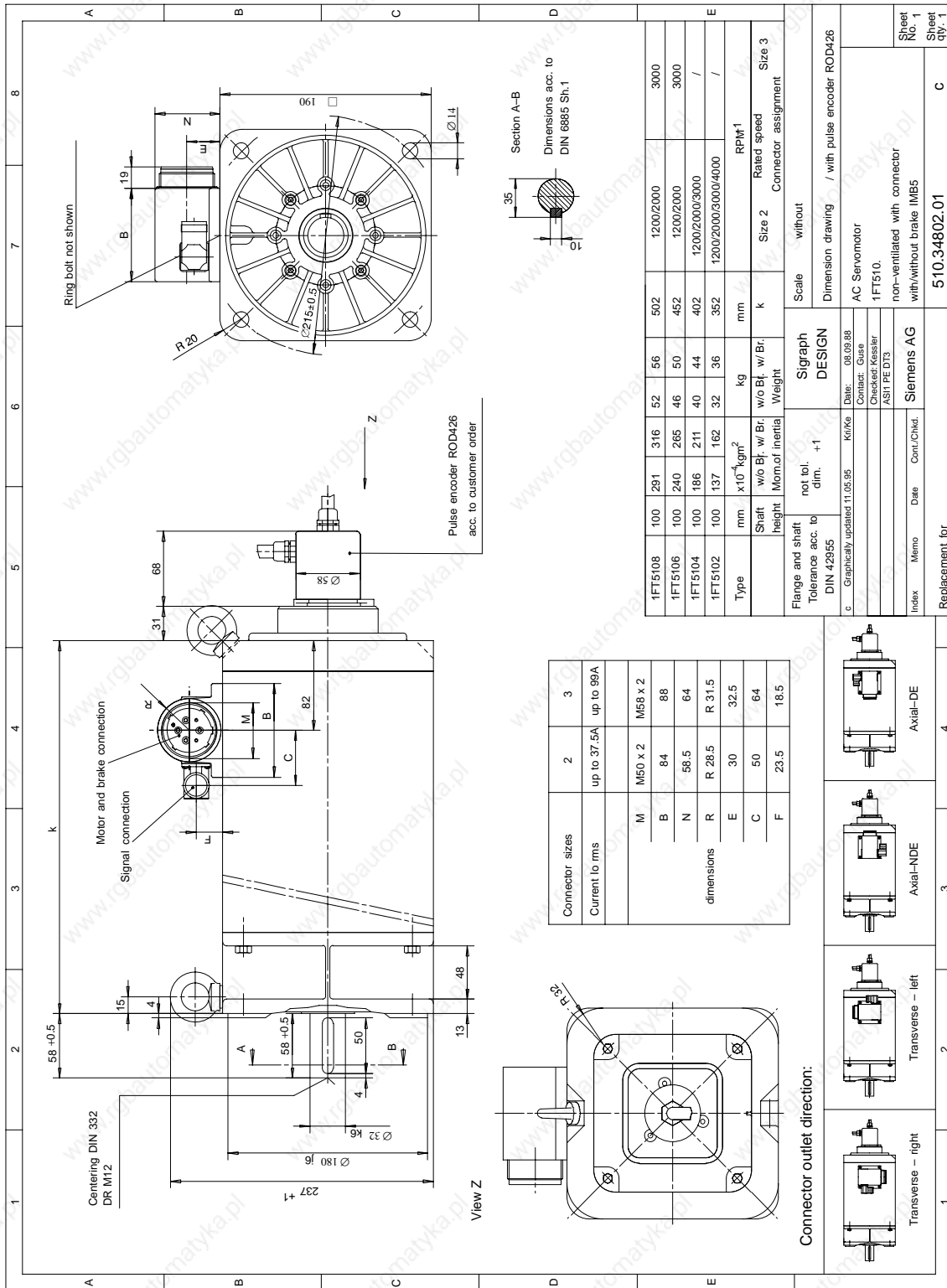

Fig. 4-16 1FT5100 non-ventilated with connector



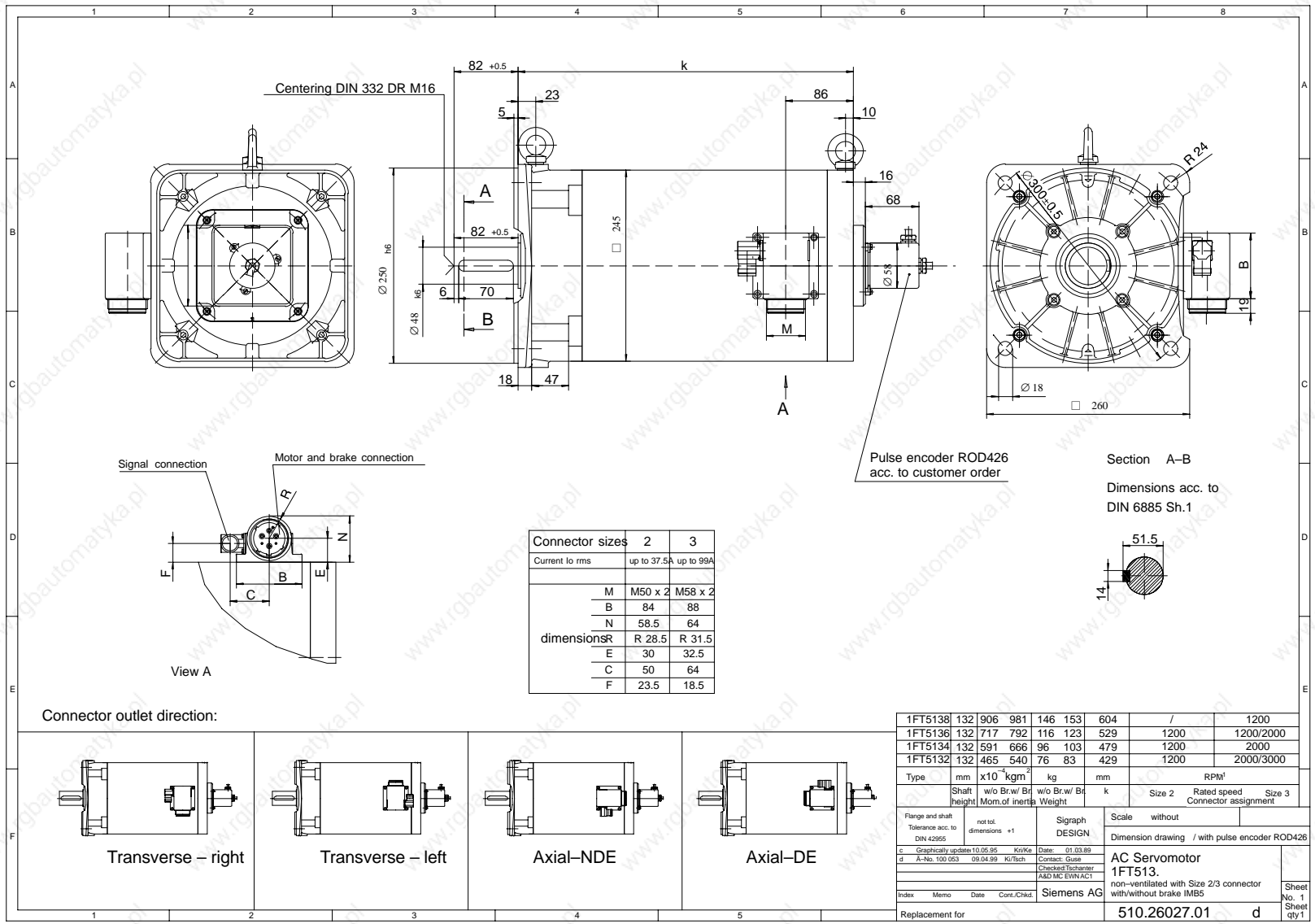

Fig. 4-17 1FT513 non-ventilated with Size 2/3 connector

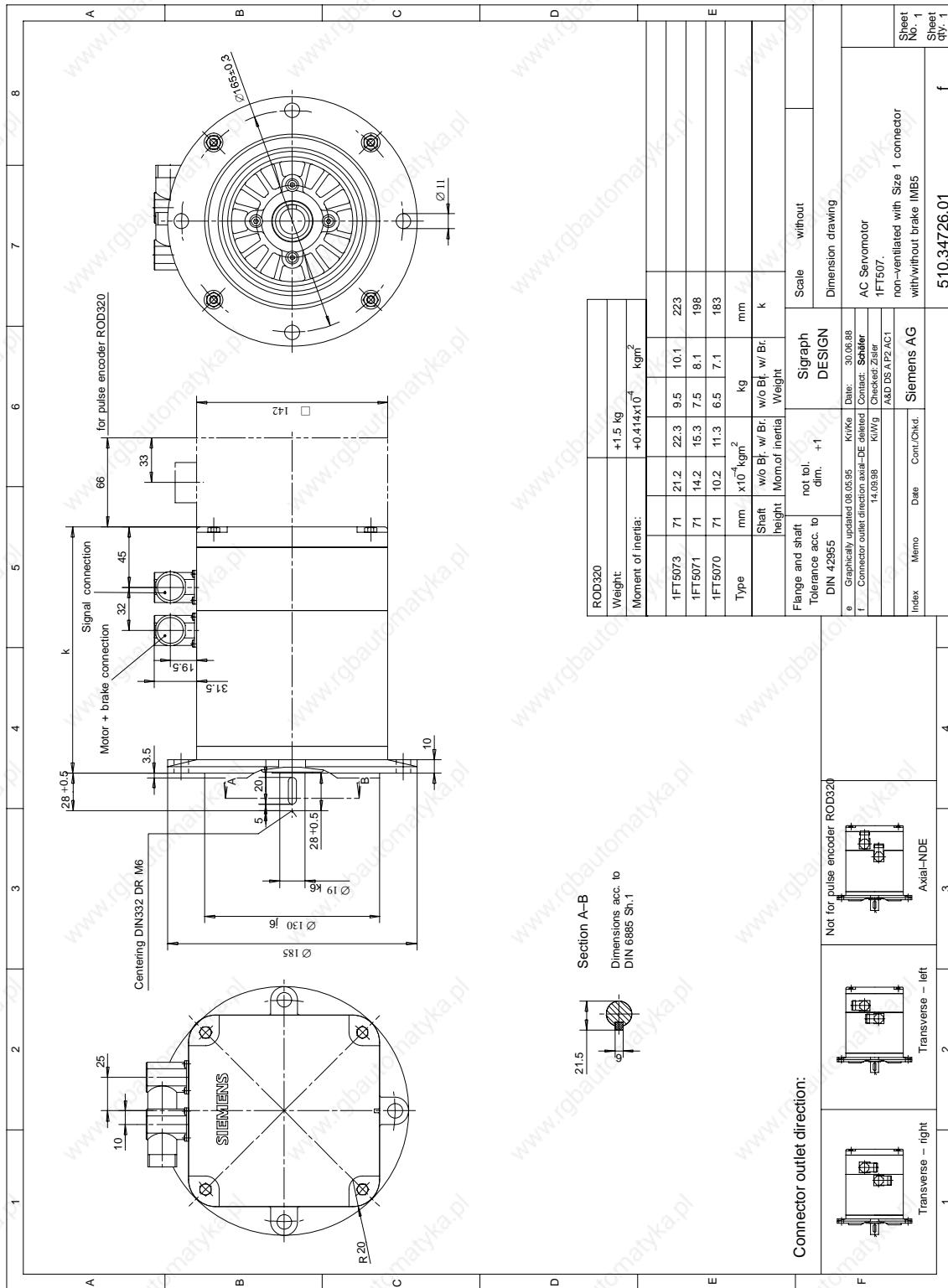

Fig. 4-18 1FT5070 non-ventilated with Size 1 connector



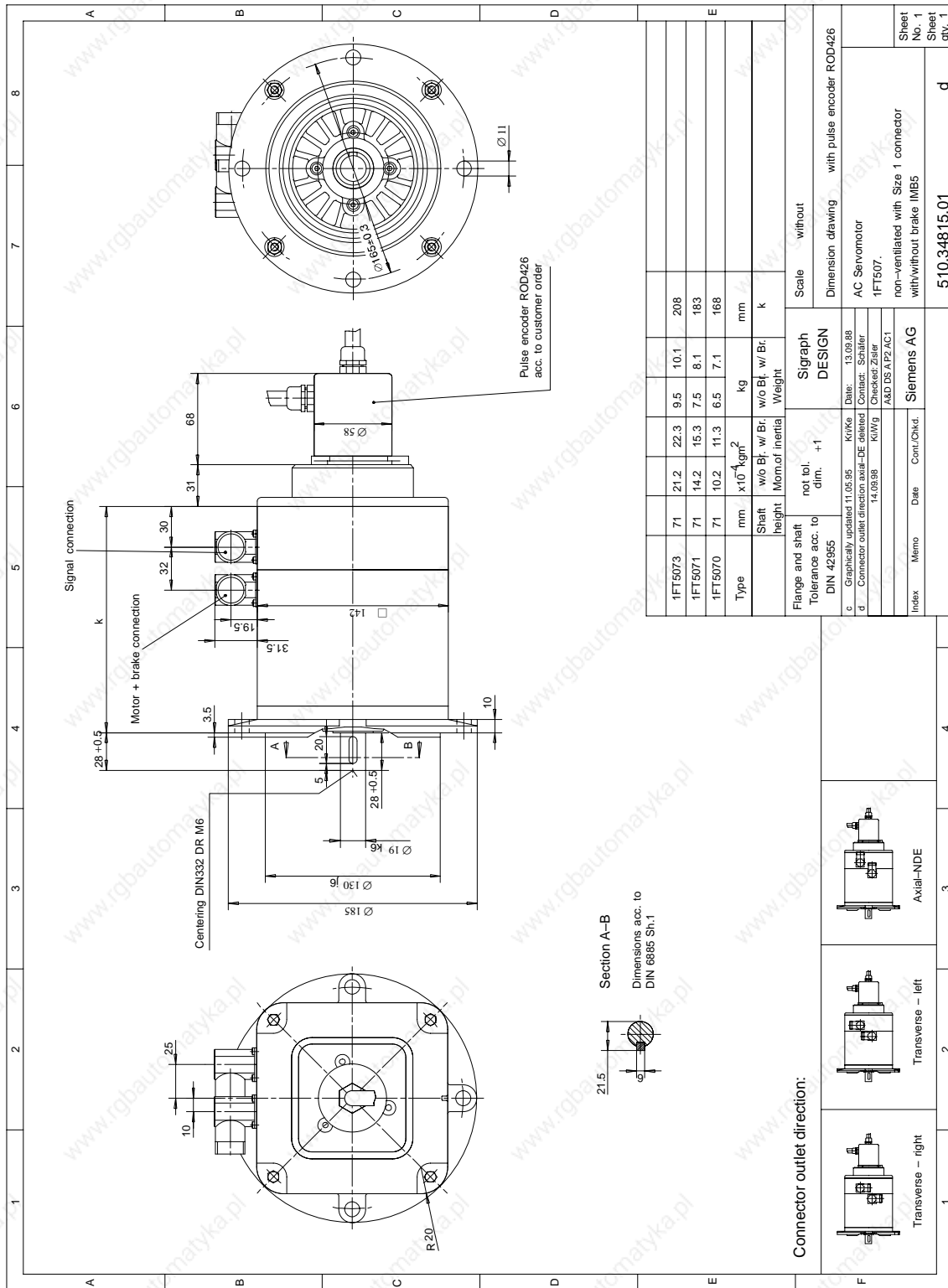

Fig. 4-20 1FT507□ non-ventilated with Size 1 connector

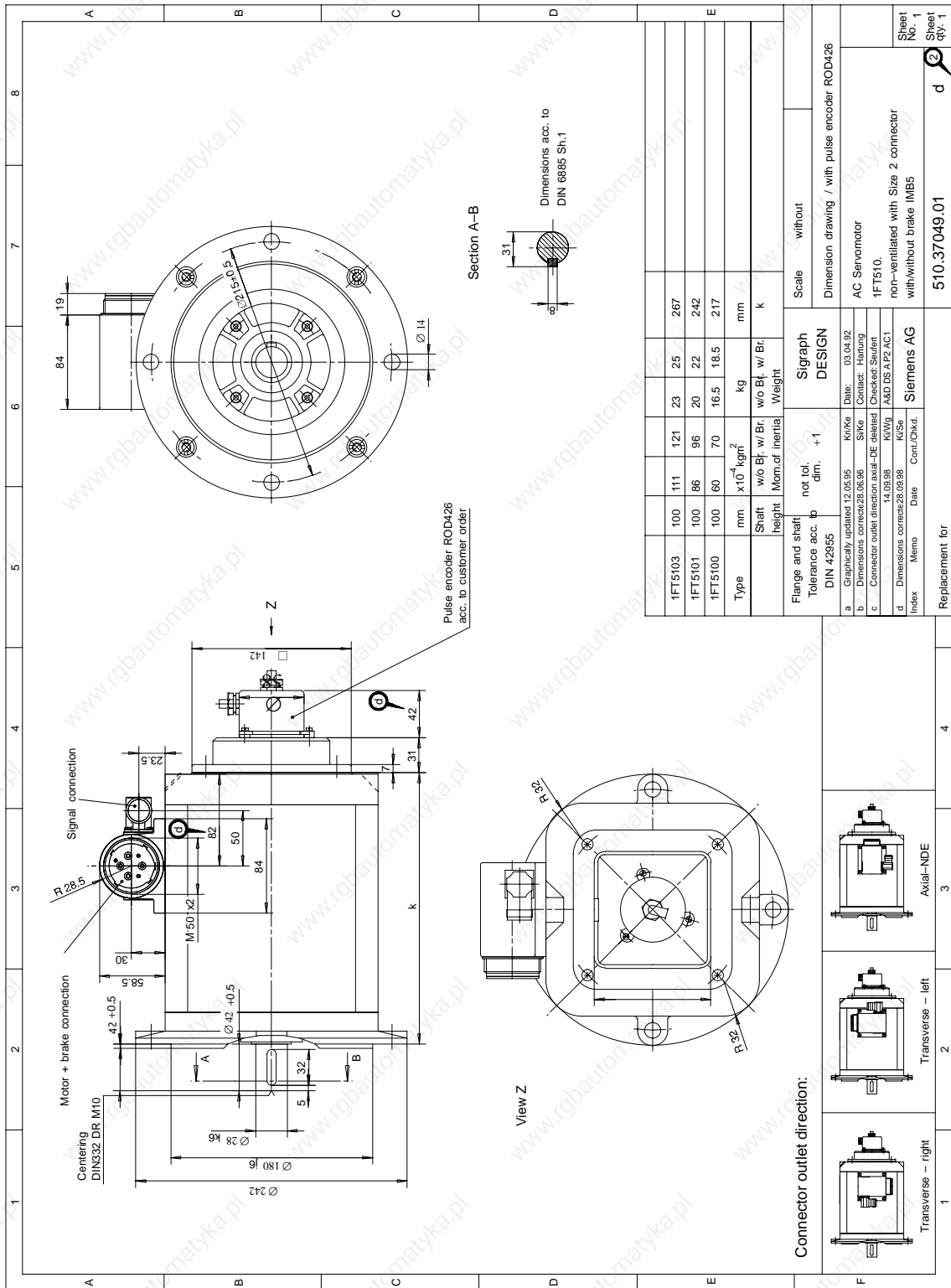

Fig. 4-21 1FT510□ non-ventilated with Size 2 connector

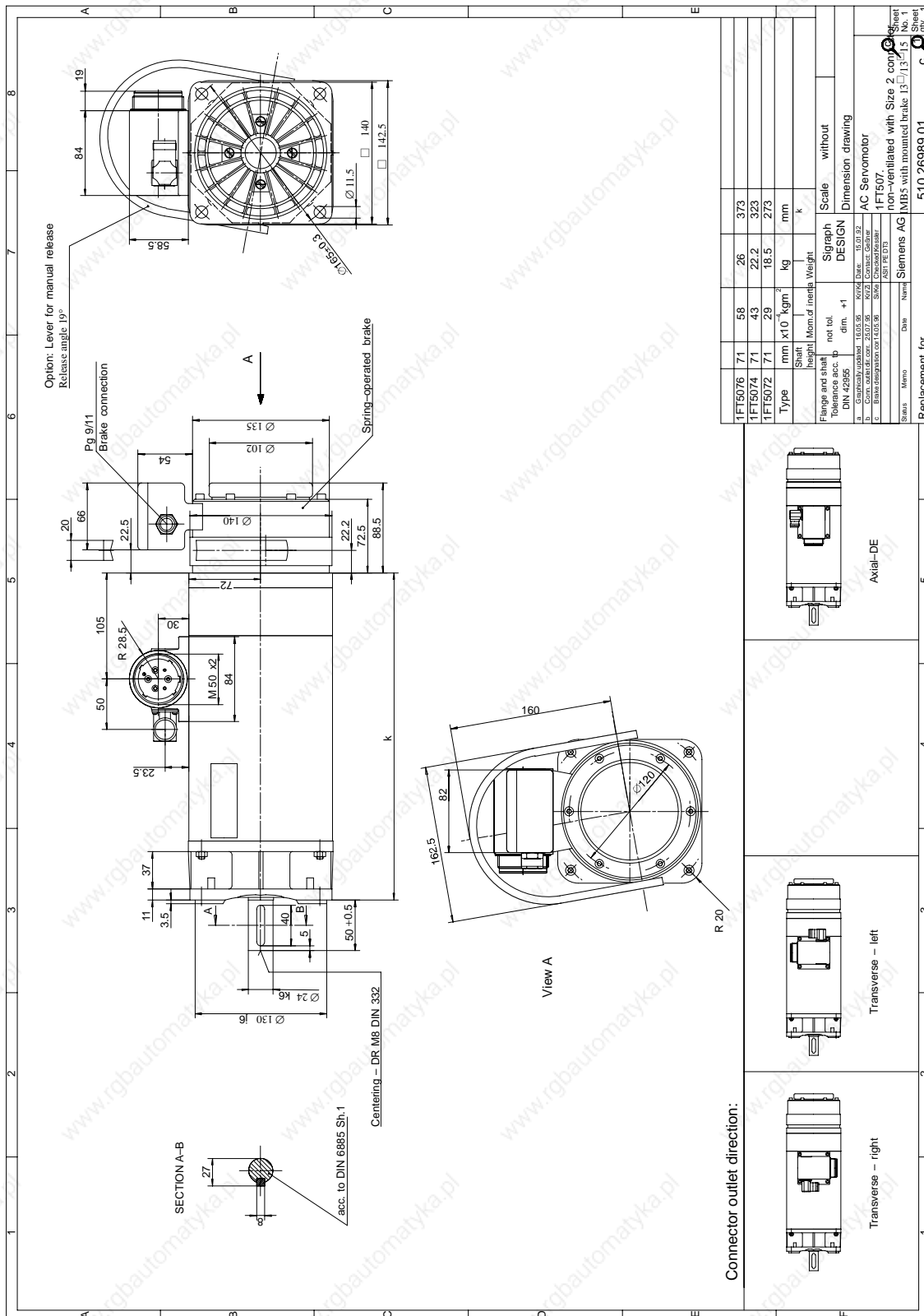

Fig. 4-22 1FT507□ non-ventilated with Size 2 connector

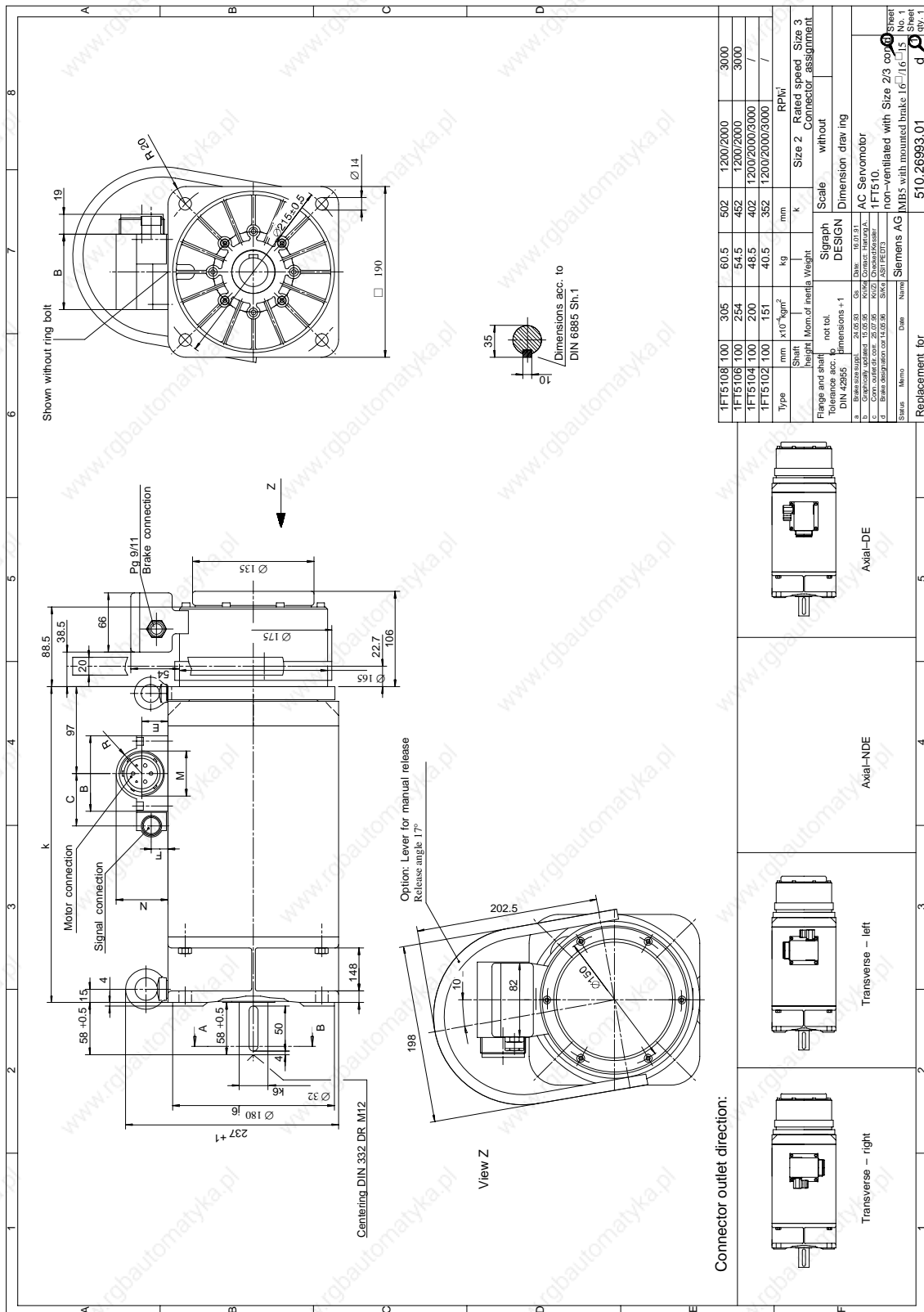

Fig. 4-23 1FT510 □ non-ventilated with Size 2/3 connector

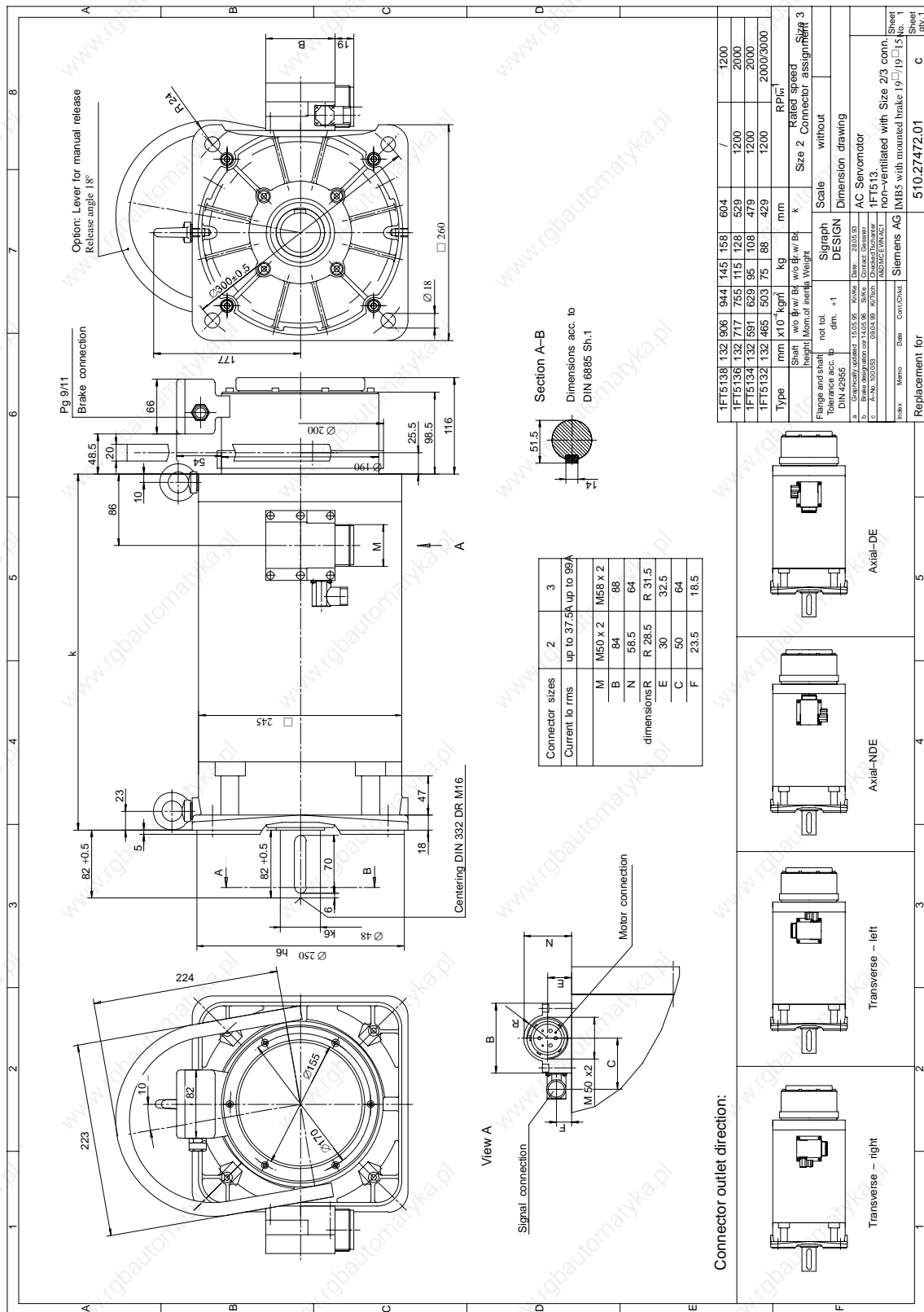

Fig. 4-24 1FT513 □ non-ventilated with Size 2/3 connector



# References

## General Documentation

### **/BU/ Catalog NC 60**

Automation Systems for Machine Tools

Order No.: E86060–K4460–A101–A9

Order No.: E86060–K4460–A101–A9–7600 (English)

### **/ZI/ Catalog NC Z**

Connection Technology and System Components for SIMATIC, SINUMERIK, MASTERDRIVES and SIMOTION

Order No.: E86060–K4490–A101–B1

Order No.: E86060–K4490–A101–B1–7600 (English)

## Electronic Documentation

### **/CD1/ DOC ON CD**

The SINUMERIK System

(includes all SINUMERIK 840D/810D and SIMODRIVE 611D documents)

Order No.: 6FC5298–6CA00–0BG3

## Manufacturer/Service Documentation

### **/PJM/ Planning Guide, AC Servomotors**

SIMODRIVE 611, MASTERDRIVES MC

General Section, 1FT5, 1FT6, 1FK6, 1FK7

Order No.: 6SN1197–0AC20–0BP0

### **/PJAL/ Planning Guide, AC Servomotors**

SIMODRIVE 611, MASTERDRIVES MC

AC servomotors, General Section

Order No.: 6SN1197–0AD07–0BP0

**/PFK7/ Planning Guide, AC Servomotors**

SIMODRIVE 611, MASTERDRIVES MC  
AC Servomotors 1FK7  
Order No.: 6SN1197-0AD06-0BP0

**/PFK6/ Planning Guide, AC Servomotors**

SIMODRIVE 611, MASTERDRIVES MC  
AC Servomotors 1FK6  
Order No.: 6SN1197-0AD05-0BP0

**/PFT5/ Planning Guide, AC Servomotors**

SIMODRIVE  
AC Servomotors 1FT5  
Order No.: 6SN1197-0AD01-0BP0

**/PFT6/ Planning Guide, AC Servomotors**

SIMODRIVE 611, MASTERDRIVES MC  
AC Servomotors 1FT6  
Order No.: 6SN1197-0AD02-0BP0

**/PPH/ Planning Guide, AC Induction Motors**

SIMODRIVE  
AC Induction Motors for Main Spindle Drives  
1PH2, 1PH4, 1PH7  
Order No.: 6SN1197-0AC60-0BP0

**/PPM/ Planning Guide, Hollow Shaft Motors**

SIMODRIVE  
Hollow Shaft Motors for Main Spindle Drives  
1PM6 and 1PM4  
Order No.: 6SN1197-0AD03-0BP0

**/PJFE/ Planning Guide, Synchronous Build-in Motors**

SIMODRIVE  
AC Motors for Main Spindle Drives  
Synchronous Build-in Motors 1FE1  
Order No.: 6SN1197-0AC00-0BP4

**/PJTM/ Planning Guide, Build-in Torque Motors**

SIMODRIVE  
Build-in Torque Motors 1FW6  
Order No.: 6SN197-0AD00-0BP1

**/PJLM/ Planning Guide, Motor Spindles**

SIMODRIVE  
ECO-Motor Spindle 2SP1  
Order No.: 6SN1197-0AD04-0BP0

**/PJLM/ Planning Guide, Linear Motors**

SIMODRIVE  
Linear Motors 1FN1 and 1FN3  
Order No.: 6SN1197-0AB70-0BP3

**/PJU/ Planning Guide, Drive Converters**

SIMODRIVE 611  
Drive Converters  
Order No.: 6SN1197-0AA00-0BP5

**/EMV/ Planning Guide, EMC Design Guidelines**

SINUMERIK, SIROTEC, SIMODRIVE  
Order No.: 6FC5297-0AD30-0BP1

**Operating Instructions 1FT5062 – 1FT5138**

Bestell-Nr. / Order No.: 610.41199.21

**Operating Instructions 1FT5020 – 1FT5046**

Bestell-Nr. / Order No.: 610.42078.21

**Operating Instructions 1FT6**

Bestell-Nr. / Order No.: 610.43410.21





# Index

## A

Additional data, 1FT5/1-15  
Armature short-circuit braking, 1FT5/1-23  
Axial force stressing, 1FT5/2-75

## B

Brake resistors, 1FT5/1-23

## C

Cantilever force diagrams, 1FT5/2-70  
Cantilever force stressing, 1FT5/2-70  
Connection assignment, 1FT5/1-31  
Cooling, 1FT5/1-29  
Core types, 1FT5/1-20

## D

Danger and warning information, vii  
Drive-out coupling, 1FT5/1-33

## E

Electrical connections, 1FT5/1-31  
Encoders  
    Overview, 1FT5/3-79  
    with synchronous flange, 1FT5/3-86  
ESDS information and instructions, x

## F

Features, 1FT5/1-13  
Forced cooling, 1FT5/1-29

## G

Gearboxes, 1FT5/3-89

## H

Holding brake, 1FT5/3-87  
Hotline, vi

## I

Incremental encoder, ROD 426, 1FT5/3-83  
Incremental encoders, ROD 320.005,  
    1FT5/3-81

## O

Options, 1FT5/1-15, 1FT5/1-19  
Order designation, 1FT5/1-14

## P

Planetary gearbox  
    1-stage, 1FT5/3-89  
    2-stage, 1FT5/3-91

## R

Resistance characteristic, 1FT5/3-78

## S

Speed-torque diagrams  
    Force-ventilated, 1FT5/2-55  
    Short motors, 1FT5/2-64  
    Standard motors, 1FT5/2-36

## T

Tachogenerator system, 1FT5/3-80  
Technical data, 1FT5/1-20  
Temperature sensor, 1FT5/3-77

## W

Working brake, 1FT5/3-88



To  
SIEMENS AG  
A&D MC BMS  
Postfach 3180  
D-91050 Erlangen

Tel.: +49 (0)180 / 5050 – 222 [Service Support]  
Fax: +49 (0)9131 / 98 – 2176 [Documentation]  
email: motioncontrol.docu@erlf.siemens.de

<b>From</b>	<b>Recommendations</b>
Name	<b>Corrections</b>
Company address/Dept.	For documentation:
Street	AC Servomotors 1FT5
Postal code:           City:	Manufacturer/Service Documentation
Telephone:                   /	Planning Guide
Telefax:                       /	Order No.:           6SN1197-0AD01-0BP0 Edition:              05.2003
	If you come across any printing errors in this document, please let us know using this form. We would also be grateful for any suggestions and recommendations for improvement.

**Recommendations and/or corrections**





# Documentation overview SIMODRIVE

## General Documentation

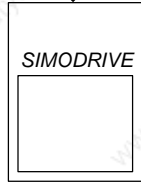

Advertising brochure



Catalog NC 60.1  
Ordering Document NC 60.2



Catalog Accessories NC Z

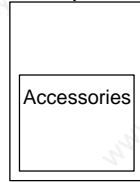

Electronic Catalog CA01

## Manufacturer/Service Documentation

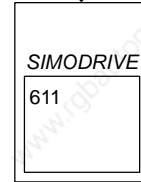

Planning Guide  
Drive Converters

## Manufacturer/Service Documentation

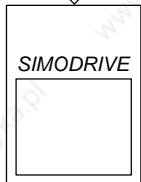

Planning Guide  
AC Servomotors General Part

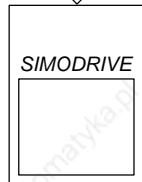

Planning Guide  
AC Servomotors 1FT5

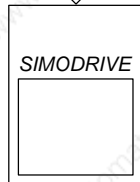

Planning Guide  
AC Servomotors 1FT6

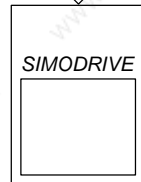

Planning Guide  
AC Servomotors 1FK6

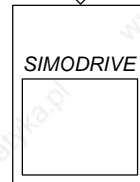

Planning Guide  
AC Servomotors 1FK7

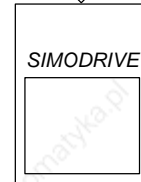

Planning Guide  
AC Induction Motors for Main Spindle Drives  
1PH2, 1PH4, 1PH7

## Manufacturer/Service Documentation

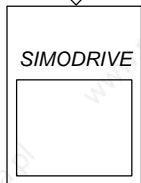

Planning Guide  
Hollow-Shaft Motors for Main Spindle Drives  
1PM6 and 1PM4

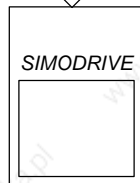

Planning Guide  
AC Motors for Main Spindle Drives  
1FE1 Synchronous Build-in Motors

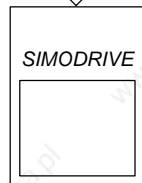

Planning Guide  
Linear Motors 1FN1, 1FN3

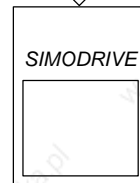

Planning Guide  
1FW6 Build-in Torque Motors



EMC Design Guidelines  
SINUMERIK SIROTEC SIMODRIVE

## Electronic Documentation

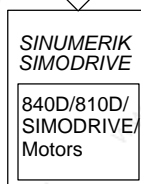

DOC ON CD  
The SINUMERIK System  
Order No.: 6FC5298-6CA00

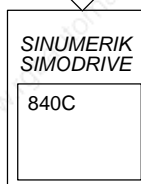

DOC ON CD  
Order No.: 6FC5198-6CA00



**Siemens AG**

Automatisierungs- und Antriebstechnik

Motion Control Systems

Postfach 3180, D – 91050 Erlangen

Bundesrepublik Deutschland

[www.ad.siemens.de](http://www.ad.siemens.de)

© Siemens AG 2003  
Subject to change without prior notice  
Order No.: 6SN1197-0AD01-0BP0

Printed in the Federal Republic of Germany