

SKiiP 23NAB126V1



MiniSKiiP[®] 2

3-phase bridge rectifier +
brake chopper + 3-phase
bridge inverter
SKiiP 23NAB126V1

Features

- Fast Trench IGBTs
- Robust and soft freewheeling diodes in CAL technology
- Highly reliable spring contacts for electrical connections
- UL recognised file no. E63532

Typical Applications*

- Inverter up to 16 kVA
- Typical motor power 7,5 kW

Remarks

- V_{CEsat} , V_F = chip level value

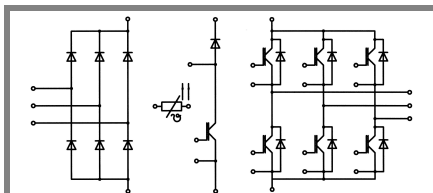

NAB

Absolute Maximum Ratings		$T_s = 25\text{ °C}$, unless otherwise specified		
Symbol	Conditions	Values	Units	
IGBT - Inverter, Chopper				
V_{CES}	$T_s = 25\text{ (70) °C}$	1200	V	
I_C		41 (31)	A	
I_{CRM}		50	A	
V_{GES}		± 20	V	
T_j		- 40 ... + 150	°C	
Diode - Inverter, Chopper				
I_F	$T_s = 25\text{ (70) °C}$	30 (22)	A	
I_{FRM}		50	A	
T_j		- 40 ... + 150	°C	
Diode - Rectifier				
V_{RRM}	$T_s = 70\text{ °C}$	1600	V	
I_F		46	A	
I_{FSM}		$t_p = 10\text{ ms, sin } 180\text{ °, } T_j = 25\text{ °C}$	370	A
i^2t		$t_p = 10\text{ ms, sin } 180\text{ °, } T_j = 25\text{ °C}$	680	A ² s
T_j		- 40 ... + 150	°C	
Module				
I_{tRMS}	per power terminal (20 A / spring)	40	A	
T_{stg}		- 40 ... + 125	°C	
V_{isol}	AC, 1 min.	2500	V	

Characteristics		$T_s = 25\text{ °C}$, unless otherwise specified			
Symbol	Conditions	min.	typ.	max.	Units
IGBT - Inverter, Chopper					
V_{CEsat}	$I_{Cnom} = 25\text{ A, } T_j = 25\text{ (125) °C}$		1,7 (2)	2,1 (2,4)	V
$V_{GE(th)}$	$V_{GE} = V_{CE}, I_C = 1\text{ mA}$	5	5,8	6,5	V
$V_{CE(TO)}$	$T_j = 25\text{ (125) °C}$		1 (0,9)	1,2 (1,1)	V
r_T	$T_j = 25\text{ (125) °C}$		28 (44)	36 (52)	mΩ
C_{ies}	$V_{CE} = 25\text{ V, } V_{GE} = 0\text{ V, } f = 1\text{ MHz}$		1,8		nF
C_{oes}	$V_{CE} = 25\text{ V, } V_{GE} = 0\text{ V, } f = 1\text{ MHz}$		0,3		nF
C_{res}	$V_{CE} = 25\text{ V, } V_{GE} = 0\text{ V, } f = 1\text{ MHz}$		0,2		nF
$R_{th(j-s)}$	per IGBT		0,9		K/W
$t_{d(on)}$	under following conditions		85		ns
t_r	$V_{CC} = 600\text{ V, } V_{GE} = \pm 15\text{ V}$		30		ns
$t_{d(off)}$	$I_{Cnom} = 25\text{ A, } T_j = 125\text{ °C}$		465		ns
t_f	$R_{Gon} = R_{Goff} = 30\text{ Ω}$		100		ns
E_{on}	inductive load		3,5		mJ
E_{off}			3		mJ
Diode - Inverter, Chopper					
$V_F = V_{EC}$	$I_{Fnom} = 25\text{ A, } T_j = 25\text{ (125) °C}$		1,8 (1,8)	2,1 (2,2)	V
$V_{(TO)}$	$T_j = 25\text{ (125) °C}$		1 (0,8)	1,1 (0,9)	V
r_T	$T_j = 25\text{ (125) °C}$		32 (40)	40 (52)	mΩ
$R_{th(j-s)}$	per diode		1,7		K/W
I_{RRM}	under following conditions		33		A
Q_{rr}	$I_{Fnom} = 25\text{ A, } V_R = 600\text{ V}$		5,7		μC
E_{rr}	$V_{GE} = 0\text{ V, } T_j = 125\text{ °C}$		2,5		mJ
	$di_F/dt = 1140\text{ A/μs}$				
Diode - Rectifier					
V_F	$I_{Fnom} = 25\text{ A, } T_j = 25\text{ °C}$		1,1		V
$V_{(TO)}$	$T_j = 150\text{ °C}$		0,8		V
r_T	$T_j = 150\text{ °C}$		13		mΩ
$R_{th(j-s)}$	per diode		1,25		K/W
Temperature Sensor					
R_{ts}	3 %, $T_r = 25\text{ (100) °C}$		1000(1670)		Ω
Mechanical Data					
w			65		g
M_s	Mounting torque	2		2,5	Nm

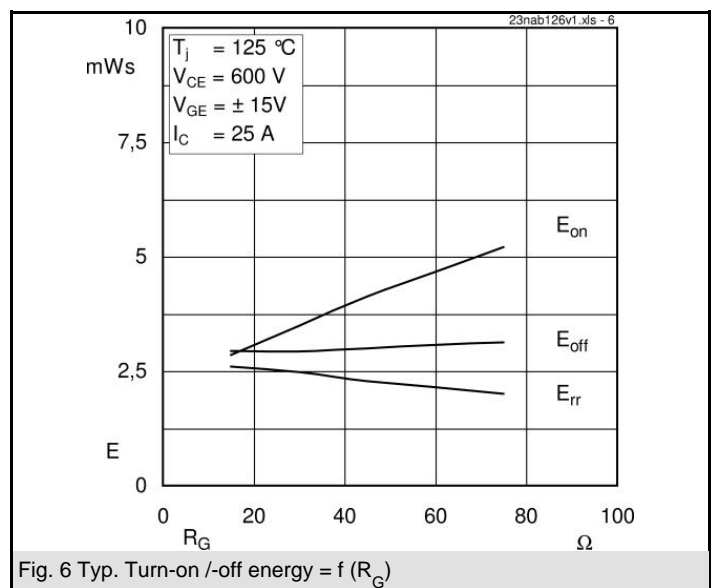
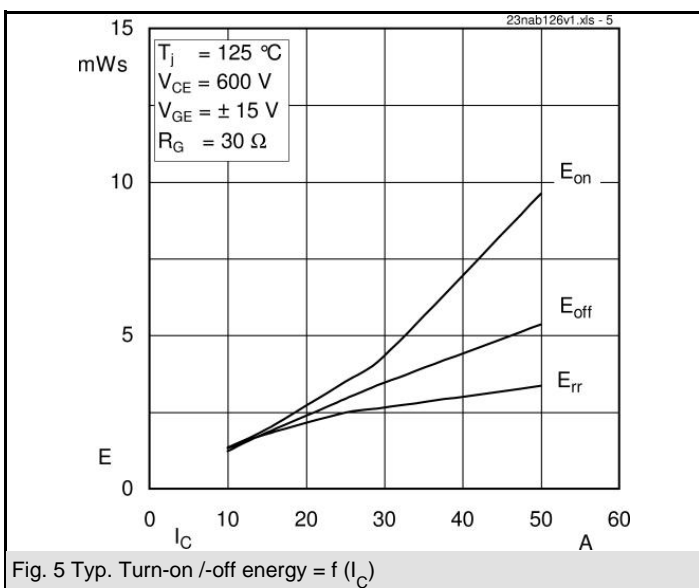
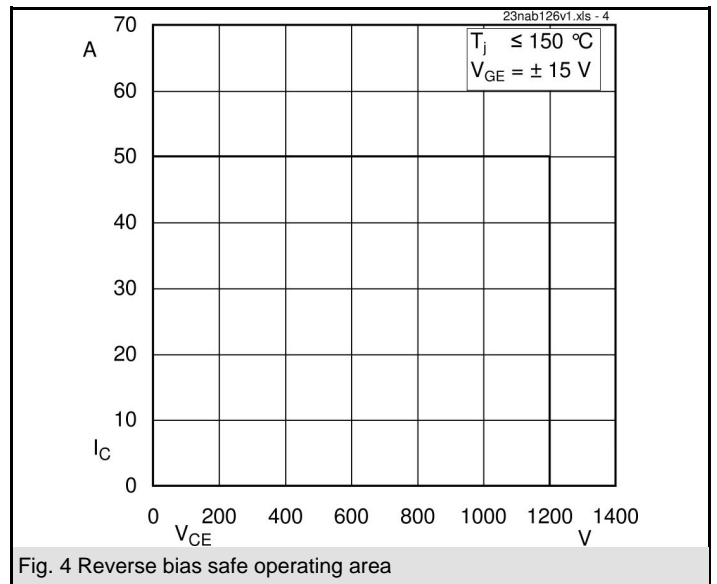
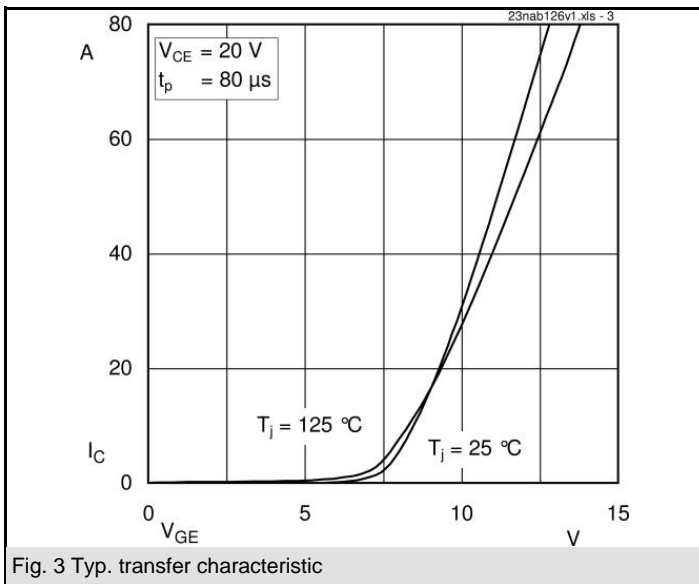
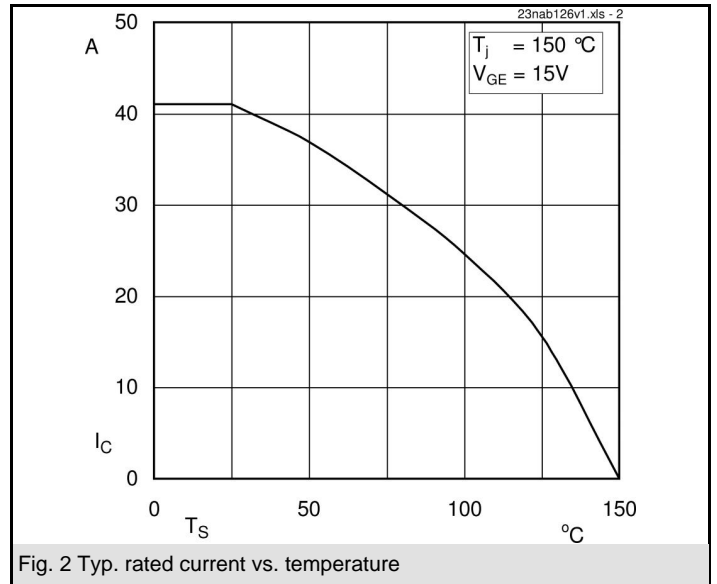
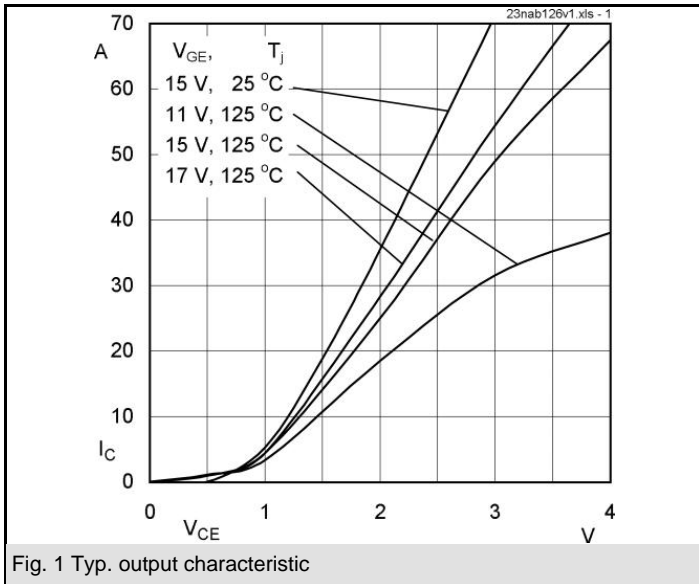

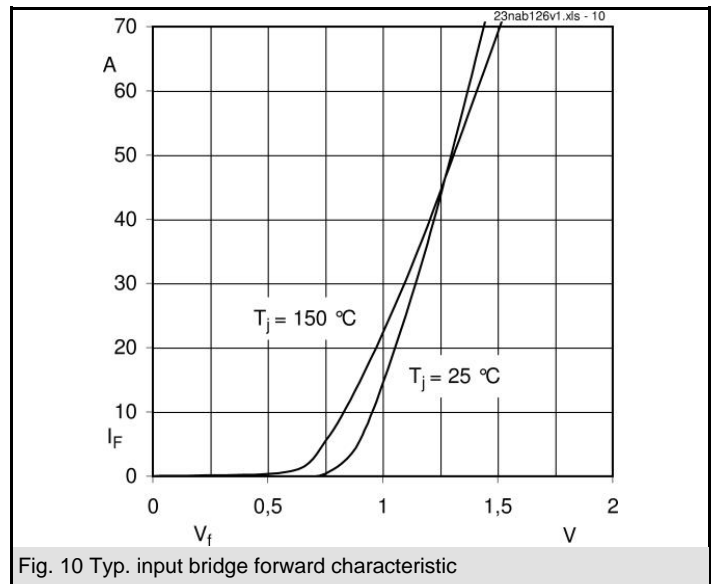
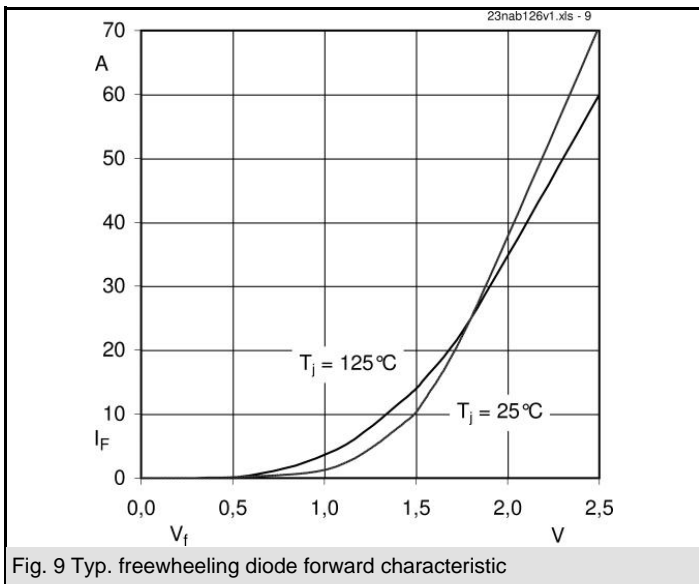
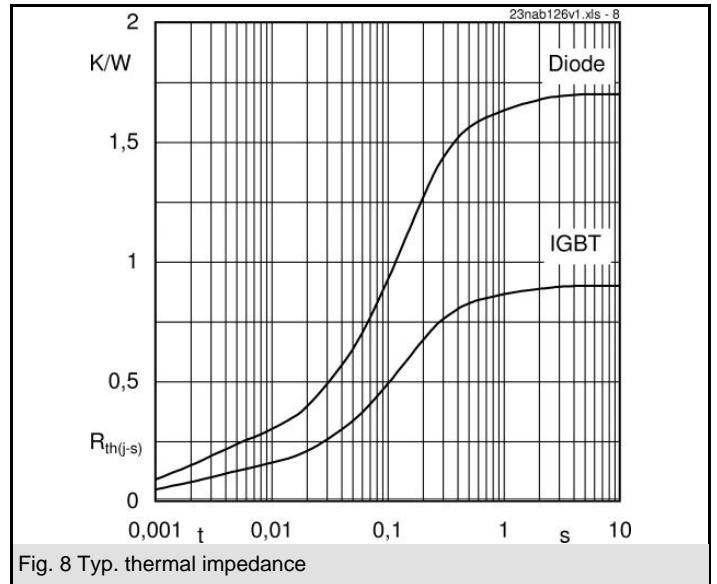
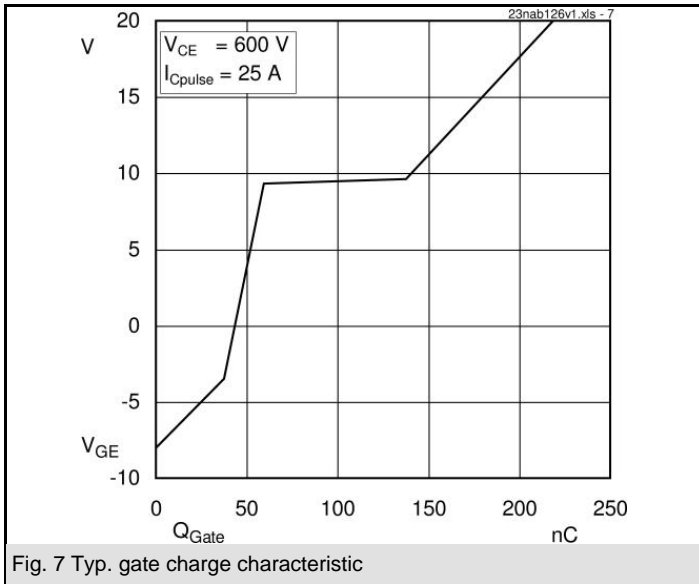

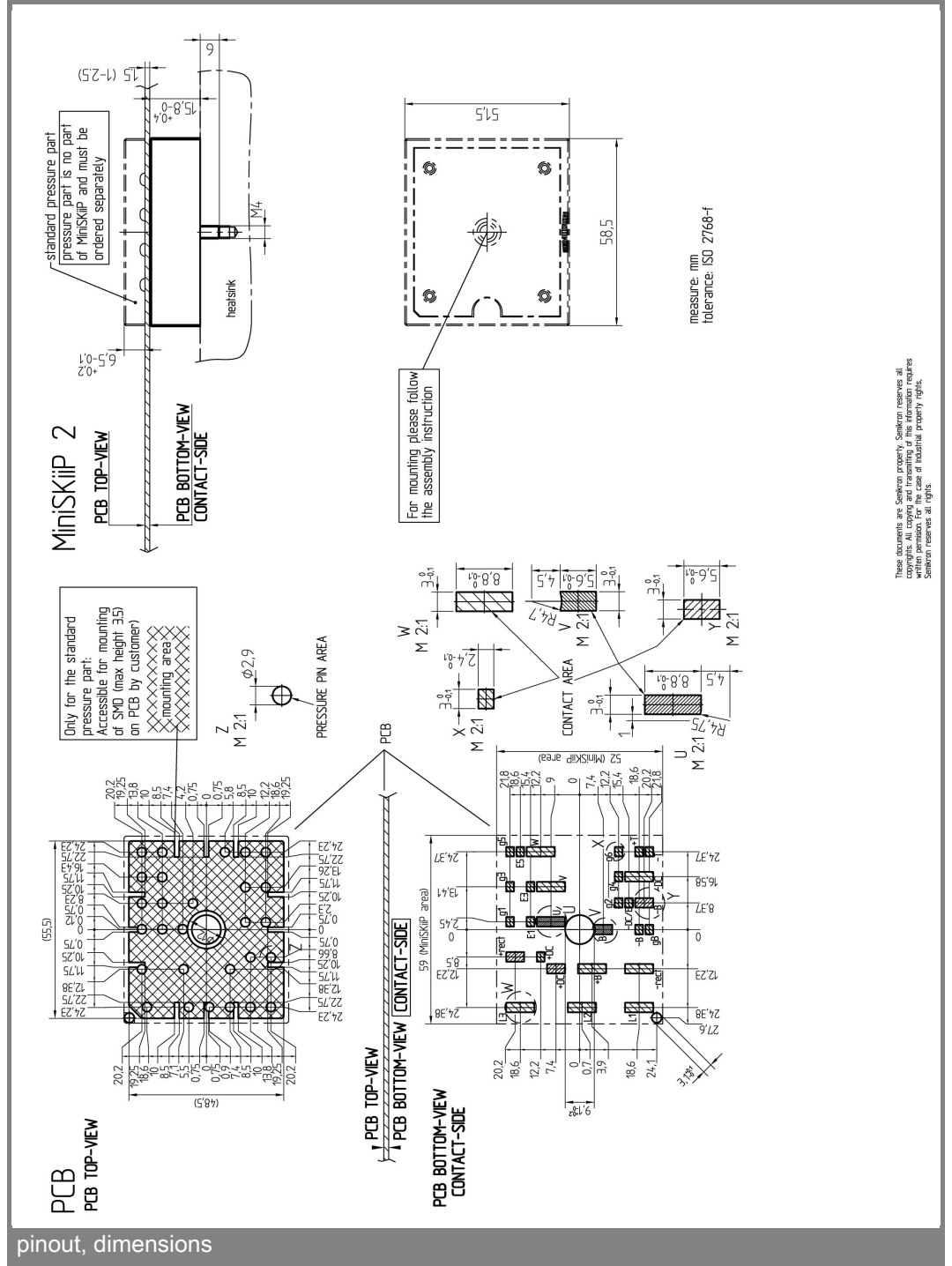
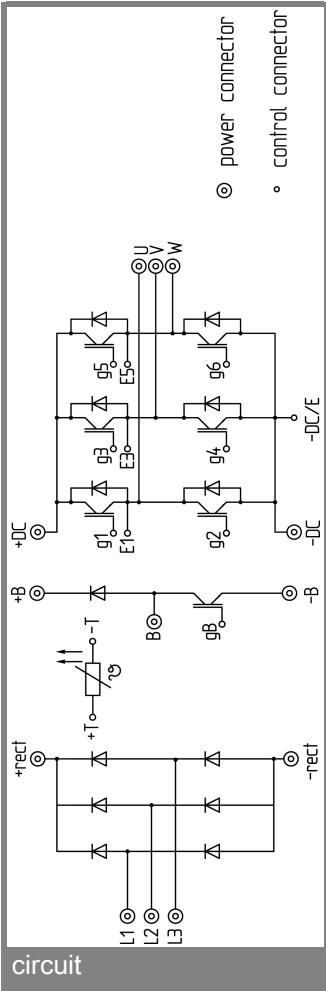

This is an electrostatic discharge sensitive device (ESDS), international standard IEC 60747-1, Chapter IX.

* The specifications of our components may not be considered as an assurance of component characteristics. Components have to be tested for the respective application. Adjustments may be necessary. The use of SEMIKRON products in life support appliances and systems is subject to prior specification and written approval by SEMIKRON. We therefore strongly recommend prior consultation of our personal.