

Operating manual

InterBus

SK TU1-IBS SK 700E
SK TU2-IBS SK 300/750E
SK TU3-IBS SK 5xxE



BU 0070 GB

Getriebebau NORD

GmbH & Co. KG





Safety and operating instructions for the drive power inverter

(as per: Low voltage directive 73/23/EEC)

1. General information

During operation, drive power converters may have, depending on their protection class, live, bare, moving or rotating parts or hot surfaces.

Unauthorised removal of covers, improper use, incorrect installation or operation leads to the risk of serious personal injury or material damage.

Further information can be found in this documentation.

All transportation, installation and initialisation and maintenance work must be carried out by **qualified personnel** (compliant with IEC 364, CENELEC HD 384, DIN VDE 0100, IEC 664 or DIN VDE 0110, and national accident prevention regulations).

For the purposes of these basic safety instructions, qualified personnel are persons who are familiar with the erection, installation, commissioning and operation of this product and who have the relevant qualifications for their work.

2. Intended use

Drive power converters are components intended for installation in electrical systems or machines.

When being installed in machines, the drive power converter cannot be commissioned (i.e. implementation of the proper use) until it has been ensured that the machine meets the provisions of the EC directive 89/392/EEC (machine directive); EN 60204 must also be complied with.

Commissioning (i.e. implementation of the proper use) is only permitted when the EMC directive (89/336/EEC) is complied with.

The drive power converters meet the requirements of the low voltage directive 73/23/EEC. The harmonised standards in prEN 50178/DIN VDE 0160, together with EN 60439-1/VDE 0660 Part 500 and EN 60146/VDE 0558 were applied for the drive power converter.

Technical data and information for connection conditions can be found on the rating plate and in the documentation, and must be complied with.

3. Transport, storage

Information regarding transport, storage and correct handling must be complied with.

Climatic conditions in line with prEN 50178 must be complied with.

4. Installation

The installation and cooling of the equipment must be implemented as per the regulations in the corresponding documentation.

The drive power converters must be protected against impermissible loads. In particular, no components must be bent and/or the insulation distances changed during transport and handling. Touching of electronic components and contacts must be avoided.

Drive power converters have electrostatically sensitive components that can be easily damaged by incorrect handling. Electrical components must not be mechanically damaged or destroyed (this may cause a health hazard!).

5. Electrical connection

When working on drive power converters which are connected to high voltages, the applicable national accident prevention regulations must be complied with (e.g. VBG 4).

The electrical installation must be implemented as per the applicable regulations (e.g. cable cross-section, fuses, earth lead connections). Further instructions can be found in the documentation.

Information about EMC-compliant installation – such as shielding, earthing, location of filters and installation of cables – can be found in the drive power converter documentation. These instructions must also always be observed for drive converters with CE approval. Compliance with the limit values specified in the EMC regulations is the responsibility of the manufacturer of the system or machine.

6. Operation

Systems where drive power converters are installed must be equipped, where necessary, with additional monitoring and protective equipment as per the applicable safety requirements, e.g. legislation concerning technical equipment, accident prevention regulations, etc. Modifications to the drive power converter using the operating software are permitted.

After the drive power converter is disconnected from the power supply, live equipment components and power connections should not be touched immediately because of possibly charged capacitors. Comply with the applicable information signs located on the drive power converter.

All covers must be kept closed during operation.

7. Maintenance and repairs

The manufacturer documentation must be complied with.

These safety instructions must be kept in a safe place!

Note:

This supplementary operating manual is only valid in conjunction with the operating manual BU 0700/0750 DE / BU 0500 DE / BU 0300 DE supplied for the NORDAC SK 700, SK 750E, SK 5xxE and SK 300E frequency inverters.

1 INTRODUCTION	4
1.1 Instruction notes.....	4
1.2 General information.....	4
1.3 Further Information.....	4
1.4 The bus system.....	4
1.5 InterBus in NORDAC frequency inverters.....	5
2 OPTION MODULES FOR SK 300E, SK 5XXE, SK 700E AND SK 750E	6
2.1 Bus modules for the SK 700E and SK 5xxE.....	6
2.1.1 InterBus module for the SK 700E and SK 5xxE.....	7
2.1.2 Installation of technology units in the SK 700E.....	8
2.1.3 Installing the FE (PE) connection.....	8
2.2 InterBus module for the SK 300E and SK 750E.....	9
2.2.1 M12 connector assignment.....	10
2.2.2 Installation of technology units in the SK 300E and SK 750E.....	11
2.2.3 Installing the FE (PE) connection.....	11
3 BUS CONFIGURATION	12
3.1 Laying the bus cables.....	12
3.2 Cable material.....	12
3.3 Cable layout and shielding (EMC measures).....	12
4 THE INTERBUS PROTOCOL	13
4.1 Drive profile.....	13
4.2 Data length.....	13
4.2.1 PPO type 1.....	13
4.2.2 PPO type 2.....	13
4.3 Transmission times.....	14
5 FREQUENCY INVERTERS – SETTINGS AND DISPLAYS	15
5.1 Frequency inverter bus parameters.....	15
5.2 Module status.....	20
5.3 LED display.....	21
6 DATA TRANSMISSION	23
6.1 Process data (PZD).....	23
6.1.1 The control word (STW).....	23
6.1.2 The status word (ZSW).....	24
6.1.3 The setpoint 1 (SW1).....	25
6.1.4 Second and third setpoint (SW2/3).....	26
6.1.5 The actual value 1 (IW1).....	26
6.1.6 Actual value 2 and actual value 3 (IW2/3).....	27
6.2 The status machine.....	27
6.3 Parameter orders with Compact PCP.....	29
6.3.1 Frequency inverter parameters (2000 _{hex} -23E7 _{hex}).....	29
6.3.2 Drive profile as per DRIVECOM21.....	29
6.4 Drive profile DRIVECOM 21.....	30
6.4.1 Speed functions overview.....	30
6.4.2 Object description.....	31
7 EXAMPLE TELEGRAMS	32
7.1 Switch-on block → Standby.....	32
7.2 Enable with 50% setpoint.....	33
7.3 Writing a parameter.....	34
8 ADDITIONAL INFORMATION	35
8.1 Repairs.....	35
9 TECHNICAL DATA	36
10 KEYWORD INDEX	37
11 SALES AGENCIES AND BRANCH OFFICES	38

1 Introduction

1.1 Instruction notes



The symbol "Attention" refers to actions that could lead to damage to hardware or software or damage to persons.



Conditions are listed here that you must comply with for correct operation. The symbol "Hand" refers to tips and advice for efficient use of the device and for reducing additional work.



The symbol "Text" refers to further information sources (manuals, data sheets, etc.). This symbol also helps you with better orientation in these instructions.

1.2 General information

This InterBus documentation is valid for the device series NORDAC trio SK 300E, SK 5xxE and SK 700/750E.



The respective SK 300E, SK 5xxE and SK 700/750E basic devices are delivered with a dummy cover for the technology box slot. The basic models do not have any components for parameterisation and control. To be able to establish communication via the InterBus, an **InterBus technology module** must be used.

The InterBus interface conforms to the standards DIN 19258 and DIN 19245 Part 2.

1.3 Further Information

These instructions only describe the NORDAC IBS technology module. Further information can be found in the manuals of Phoenix Contact or, with reference to the drive profile, in the DRIVECOM user group.

All the frequency inverter parameters are described in the manuals BU 0300, BU 0500, BU 0700 and BU 0750.



- BU 0300, BU 0500, BU 0700, BU 0750 manual
- DRIVECOM-Profile No. 21 / 22
- IBS PCP compact user manual (Phoenix Contact 10/2002)

Some manuals, instructions, etc. can be located on the Internet:

www.nord.de
www.interbusclub.com
www.phoenixcontact.com
www.drivecom.org

1.4 The bus system

The INTERBUS {xe "INTERBUS field bus system"} open field bus system provides standardised connection of all process peripherals with all common controllers.

The InterBus is a very efficient bus system which works according to the special master-slave access method, also referred to as the summation frame protocol. This total frame enables a constant bus cycle.

From a topological viewpoint, InterBus is a ring system, where send and return circuits are sent via every subscriber. This ensures full duplex operation.

The NORDAC SK 700E and SK 300E can be connected to other sensors/actuators via a serial bus cable. InterBus differentiates generally between remote bus subscribers (this module) and local bus subscribers that derive as sub-ring systems from the remote bus.

In general, two different data transmission channels are used, the process data channel and the parameter data channel, and both are supported by this access module.

In each data transmission cycle, a data volume of 3 to 5 words of 16 bit each are transmitted.

1.5 InterBus in NORDAC frequency inverters

Attributes:

- Galvanically isolated outgoing bus interface
- Master-Slave access process; constant bus cycle through total frame protocol
- Bus length: 400m (between two remote bus subscribers), total length 13km
- Transfer rate of 500kBit/s (optionally 2Mbit/s)
- Settable DRIVECOM 21 profile
- Processing of parameter data via PCP
- External 24V supply for continuous bus operation without interruptions
- 9-pin Sub-D connector for remote bus connection
- Max. 256 subscribers (max. 85 NORDAC 700E)
- Status display with 5 InterBus status LEDs, plus a two-colour operation LED
- Comprehensive system diagnostics and fast fault localisation
- Automatic subscriber addressing

2 Option modules for SK 300E, SK 5xxE, SK 700E and SK 750E

2.1 Bus modules for the SK 700E and SK 5xxE

Technology units, customer units and special extension units

Through the combination of modules for the display, **technology units** and modules with digital and analog inputs, as well as interfaces, **customer units** or **special extension units**, the NORDAC SK 700E can be easily adapted to the requirements of various applications.

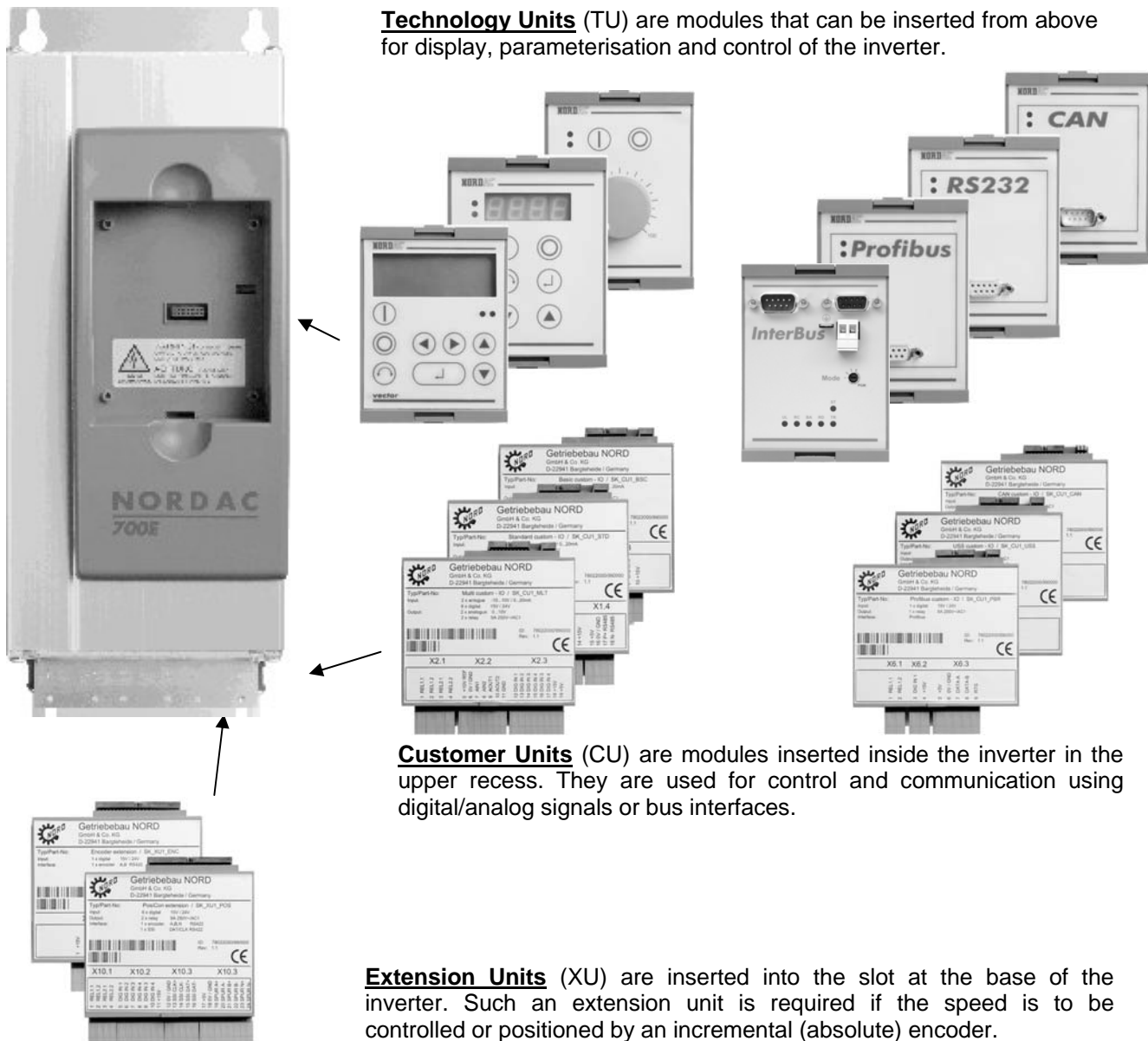

	<p>WARNING</p> <p>Modules should not be inserted or removed unless the device is free of voltage. The slots may <u>only</u> be used for the applicable modules. The slots are coded to prevent them being mixed up.</p>
---	---

2.1.1 InterBus module for the SK 700E and SK 5xxE

(SK TU1-IBS, Mat. No. 278200065 → SK 700E)

(SK TU3-IBS, Mat. No. 275900065 → SK 5xxE)

The InterBus communication module SK TU1-IBS is used for connecting drives from the device series SK 700E and SK TU3-IBS from the device series SK 5xxE to higher-level automation systems via InterBus.

Data width:

Variable (3 words; 5 words)

Baud rate:

500kBit/s (optionally 2Mbit/s)

Termination resistor:

Not required;
already integrated in device

Addressing:

Implemented automatically via physical arrangement of subscribers in the bus

Power supply

24V +/-10%

External 24V supply for

bus operation without interruptions.

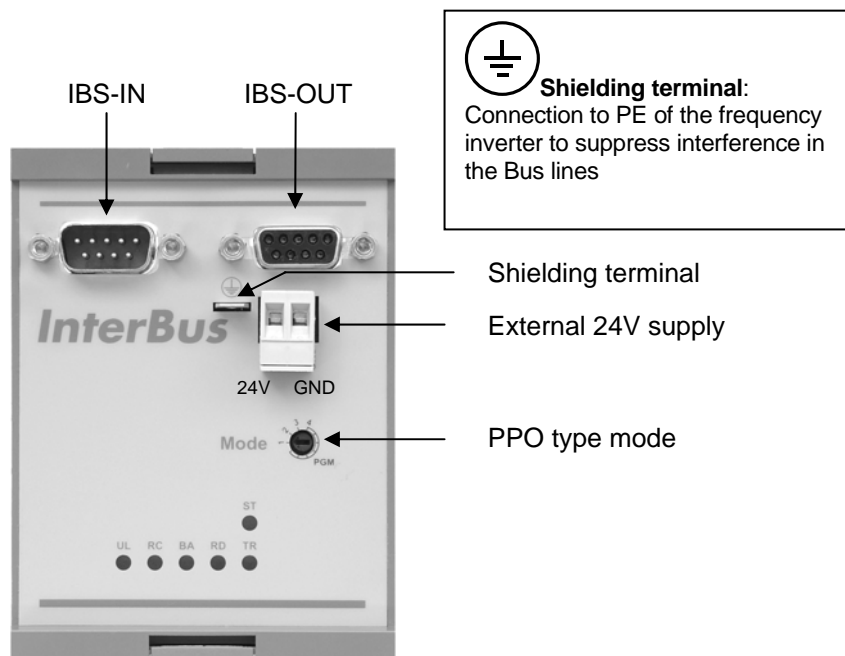

PPO type mode

The PPO type to be used can be set or the drive profile, as per DRIVECOM 21, can be switched on/off with the rotary coding switch "PPO type mode". The mode setting is always read in during the initialisation of the whole bus. If the switch is set to PGM (programming mode), the parameter values from P507 "PPO type" and P551 "Drive profile" are read in.

Position 1 → 3 words (PPO type 1)

Position 2 → 3 words with profile (PPO type 1 with profile)

Position 3 → 5 words (PPO type 2)

Position 4 → Reserve

Position PGM → programming mode (settings as per inverter parameterisation)



The settings made using the rotary coding switch are not transferred to the frequency inverter parameters!

Note: If the mode switch is permanently set (Position 1 – 3), the software/parameter settings are ineffective!

SUB-D connector assignment

Incoming remote bus:

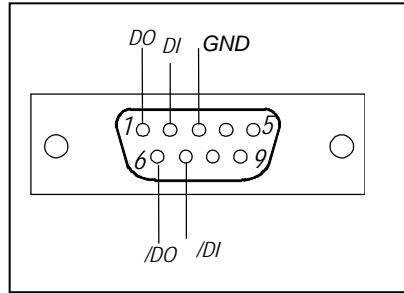

Forwarding remote bus:

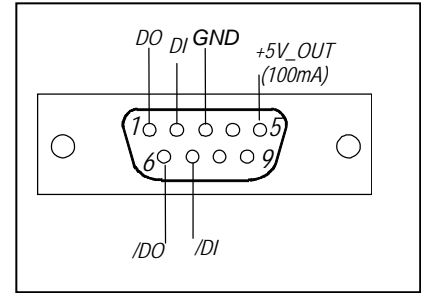

InterBus status LEDs (see Chap. 5.3):

UL (green):	Supply voltage applied	
RC (green):	RemoteCheck:	Remote bus to previous InterBus device OK
BA (green):	Bus Active:	InterBus data is being exchanged (Bus running)
RD (yellow):	Remotebus Disabled:	Remote bus to next InterBus device disabled
TR (green):	Transmit:	Data is being transferred from/to subscribers

Module status 2-colour LED (see Chap. 5.3):

ST (red):	Module error
ST (green):	Module status

2.1.2 Installation of technology units in the SK 700E

The technology units must be **installed** as follows:

1. Switch off the mains voltage, observe the waiting period.
2. Remove the dummy cover by actuating the unlocking device on the top and bottom edge.
3. Allow the technology unit to engage audibly by pressing lightly on the installation surface.

NOTE:

Installation of a technology box **separate** to the frequency inverter is not possible. It must be connected directly to the inverter.

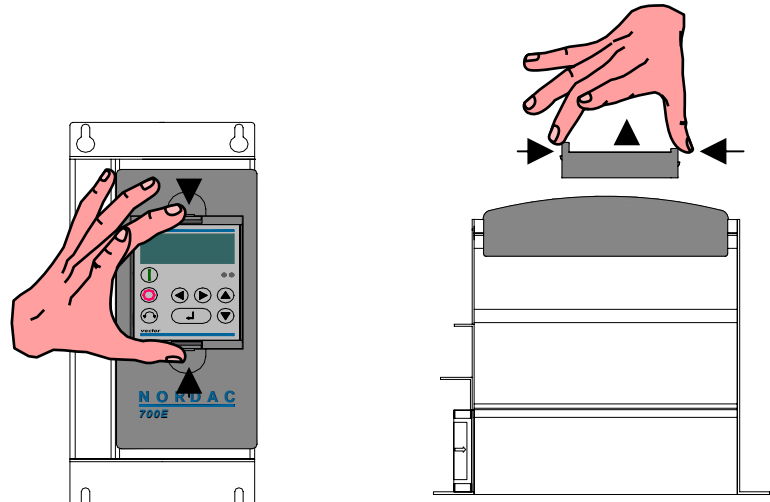

2.1.3 Installing the FE (PE) connection

A flat plug is provided on the outgoing IBS interface for connection to the FE (function earth) or PE. The accompanying green-yellow cable must be mounted here and fastened to the housing of the frequency inverter.

2.2 InterBus module for the SK 300E and SK 750E

(SK TU2-IBS, P. No. 075130080 → SK 300E / SK 750E)

The InterBus communication module SK TU2-IBS, is for connecting drives from the trio SK 300E and 750E device series to higher level automation systems via InterBus.

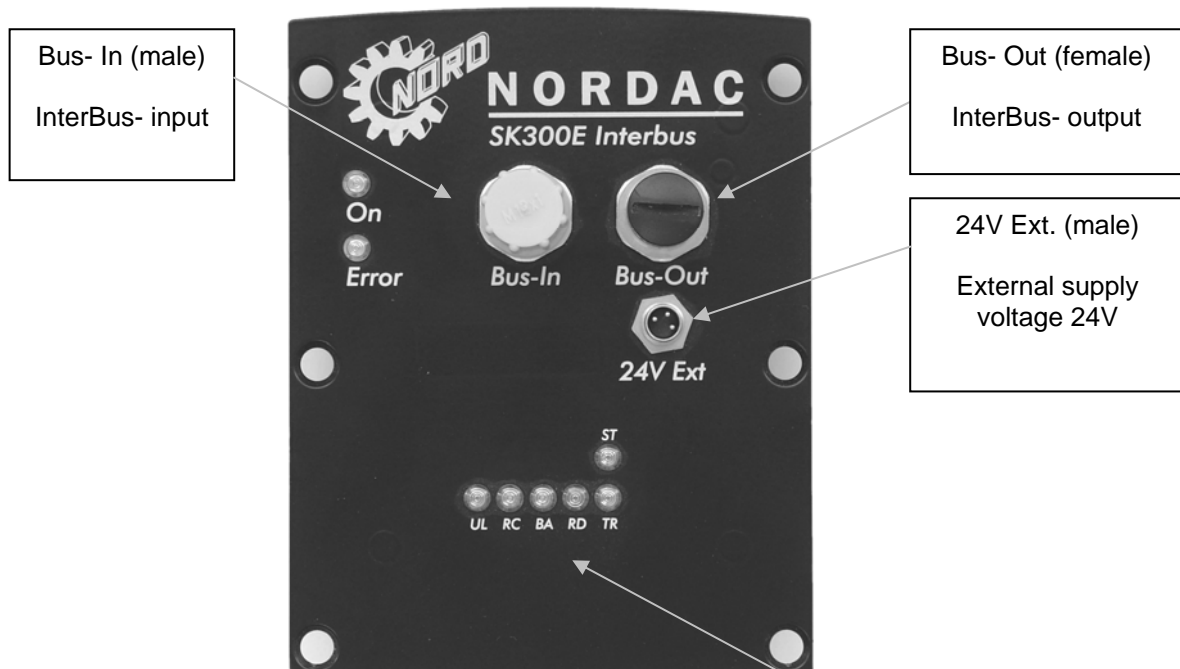

Data width:

Variable (3 words; 5 words)

Baud rate:

500kBit/s (optionally 2Mbit/s)

Termination resistor:

Not required; already integrated in device

Addressing:

Implemented automatically via physical arrangement of subscribers in the bus

Supply:

24V +/-10%

External 24V supply for continuous bus operation without interruptions

The status of the InterBus technology unit is shown by 5(6) LEDs:

- UL (green): Supply voltage applied
 - RC (green): RemoteCheck
 - BA(green): Bus Active
 - RD(yellow): Remotebus Disabled
 - TR(green): Transmit
- 2-colour LED
- ST (green): Module status
 - ST (red): Module error

→ See Chap. 5.3 "LED display"

2.2.1 M12 connector assignment

Connector assignment for M12 connector and sockets for Bus In and Bus Out :

IBS signal	M12 assignment
DO	1
$\overline{\text{DO}}$	2
DI	3
$\overline{\text{DI}}$	4
GND	5

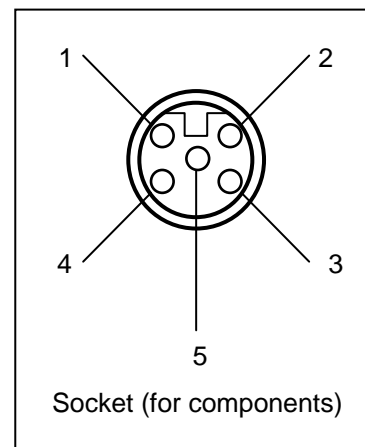
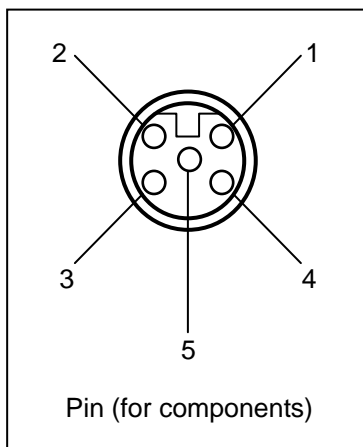

Connector assignment for M8 connector for ext. 24V:

IBS signal	M8 assignment
+24V	1
GND	3
PE	4

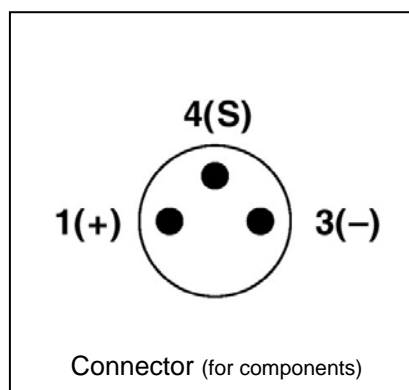

2.2.2 Installation of technology units in the SK 300E and SK 750E

The 6 cover plate screws must be removed to install the technology box. Note the earthing cable, which can be plugged into the plate. Ensure this cable is connected when installing the technology box to guarantee complete earthing. Maximum protection class IP66 is only guaranteed if the seal is used and the 6 screws are secured correctly to create a tight seal.

Installation of a technology box **separate** to the frequency inverter is not possible. It must be installed or connected directly on the inverter.

	<h3>WARNING / NOTE</h3>
<p>Installation must be carried out by qualified personnel only, paying particular attention to safety and warning instructions.</p> <p>Only install technology units when the device is voltage-free.</p> <p>Installation of a technology box separate to the frequency inverter is <u>not</u> possible. It must be connected directly to the frequency inverter.</p>	

The technology units must be **installed** as follows:

1. Switch off the mains voltage, observe the waiting period.
2. Remove the dummy cover by unscrewing the 6 hexagon socket screws.
3. Make sure that the plug-in connections are firmly in place and that the lid is sealed.
4. Insert the technology box and screw in place.

Earthing line

Make sure the earthing line is plugged into the plate of the standard device and each technology unit. This line must be connected when installing the technology unit to ensure it is fully earthed.

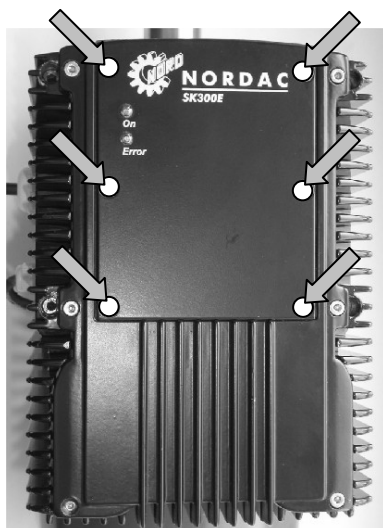

Fastening screws for the technology unit

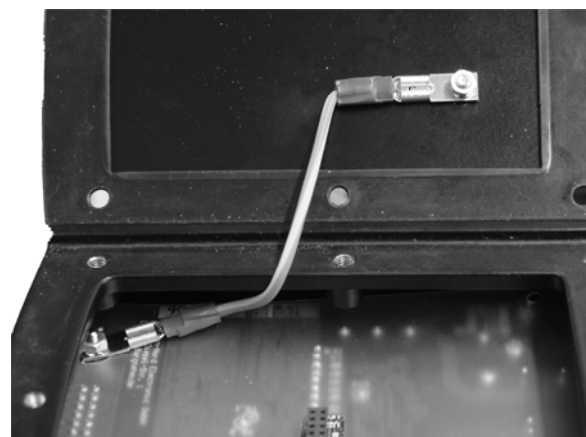

Earthing of the cover plate

2.2.3 Installing the FE (PE) connection

A flat plug is provided on the bottom of the technology box for connection to the FE (function earth) or PE. A connection cable with appropriate components is already included in the frequency inverter and is connected to the dummy cover in the standard design. This must be used to create the PE connection to the technology unit.

3 Bus configuration

An InterBus network consists of a maximum of 256 subscribers and is based on a ring topology. The number of subscribers is dependent on the number of IO's. With a useful data length of 3 words, it is possible to connect 85 devices with the NORDAC 700E.

3.1 Laying the bus cables

In an industrial environment the correct installation of the Bus system is particularly important in order to reduce potential interference. The following points are designed to help prevent interference and problems right from the start. The installation guidelines are not complete as applicable safety and accident prevention guidelines must also be complied with.

3.2 Cable material

The guaranteed transfer speeds or transfer distances can only be achieved without errors if the specific cable parameters are complied with.

Max. line capacitance	Resistance	Cable cross-section	Baud rate
60nF/km	250mΩ/m	3*2*0.2 mm ²	500k

See also <http://www.interbusclub.com/de/doku/pdf/kabel-d.pdf>

Certified InterBus data cables are recommended.

Designation (example):



3.3 Cable layout and shielding (EMC measures)

If EMC measures are not in place, high-frequency interference which is principally brought about by switch procedures or lightning often causes electronic components in the bus subscribers to be faulty and error-free operation can no longer be ensured.

Appropriate shielding of the bus cable reduces electrical interference which can arise in an industrial environment. You can achieve the best shielding qualities with the following measures

- Connect the bus subscribers with the shortest amount of cable possible.
- The shielding on the bus line must be applied completely on both sides.
- Avoid using tap lines to connect field devices to the bus.
- Avoid extending the bus lines using plug connectors.

Bus lines should be laid with a minimum spacing of 20 cm to other lines which carry a voltage higher than 60V. This applies to lines laid inside and outside of control cabinets.



If earthing potential values are different, transient current may flow through shielding which is connected on both sides. This may be a danger to electronic components. Differences in potential must be reduced using sufficient potential equalisation.

4 The InterBus protocol

InterBus works with a summation frame protocol. Each subscriber has a fixed data length.

Note: If the mode switch is permanently set (Position 1 – 3), the software/parameter settings are ineffective!

4.1 Drive profile

If the drive is to be operated as per DRIVECOM 21 profile, the frequency inverter can be configured via Parameter 551. This also changes the ID of the subscriber.

Drive profile On (P551 = 1) ID[7..0]= E3h → DRIVECOM with 1 PCP word, RemoteBus
 Drive profile Off (P551 = 0) ID[7..0]= F3h → Module with 1 PCP word, RemoteBus



To render the profile change effective, the module must be reinstalled (e.g. switch the mains voltage off and then on again). The entire bus must also be restarted. The profile is only effective with 3 word data lengths (PPO type 1).

4.2 Data length



The default setting is 5 words when the inverter is switched off.

Attention: After the frequency inverter is switched on, the profile and PPO type settings are read in and the InterBus reinitialised (P507 and P551).

The data length can be set between 3 and 5 words for the IBS module and is set via the PPO types (P507: see Chap. 5.1). The PPO types 3 and 4 are reserved.



To render the data length change effective, the InterBus must be reinstalled (e.g. switch the mains voltage off and then on again). The entire bus must also be restarted.

4.2.1 PPO type 1

3 words data width

Drive profile On (P551 = 1) ID[7..0]= E3h → DRIVECOM with 1 PCP word, RemoteBus
 Drive profile Off (P551 = 0) ID[7..0]= F3h → Module with 1 PCP word, RemoteBus

Byte	0	1	2	3	4	5
out	PCP		Control word		Speed setpoint (rpm)	
in	PCP		Status word		Speed actual value (rpm)	

4.2.2 PPO type 2

5 words data width

ID[7..0]= F3h → Module with 1 PCP word, RemoteBus

Note: The parameter "Drive profile" has no effect.

Byte	0	1	2	3	4	5	6	7	8	9
out	PCP		Control word		Setpoint 1		Setpoint 3		Setpoint 2	
in	PCP		Status word		Act. value 1		Act. value 3		Act. value 2	

4.3 Transmission times

The cycle time is dependent on the number of words to be transmitted. It increases linearly with increasing word quantity. The cycle time in dependence on the total word length is shown in the diagram for a transmission rate of 500kBit/s. The number of inverters shown is based on a 3 word data length.

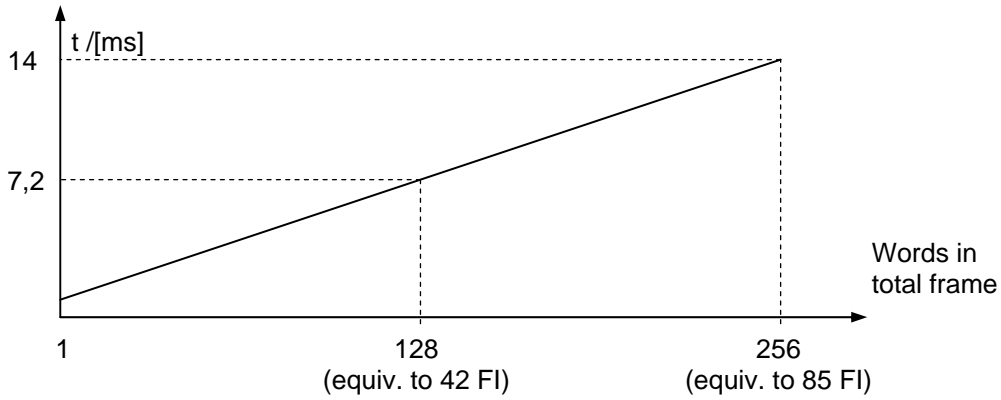

5 Frequency inverters – settings and displays

5.1 Frequency inverter bus parameters

To operate the inverter with the InterBus protocol, the bus must be connected to the master and some settings have to be made on the frequency inverter.

With InterBus protocol, the inverter parameters are mapped in the range 2000_{hex} to 23E7_{hex} (= 8192_{dec} to 9191_{dec}), i.e. when parameterisation is carried out via the bus, the parameter numbers must be added to the value 2000_{hex} (e.g. P508 → obj 21FC_{hex}).

The frequency inverter can always be parameterised. Control of the inverter via InterBus can be activated by setting parameter **P509** to value 12, 13 or 14. (see below)

Parameter	Setting value / Description / Note	Available in Option
P507	PPO type	Always visible
1 ... 4	Only with Profibus or InterBus option	
[1]	1 = PPO type 1: InterBus with data length of 3 words (see Chap. 4.2.1) 2 = PPO type 2: InterBus with data length of 5 words (see Chap. 4.2.2) 3, 4 = PPO type 3, 4: reserved	
P509	Interface	Always visible
0 ... 21	Selection of the interface from which the inverter is controlled.	
[0]	0 = Control terminals or keypad control with the Control Box (optional), the ParameterBox (optional) or the potentiometer option . 1 = Control terminals only . The inverter can only be controlled via the digital inputs and the analog input. 12= InterBus setpoint . The frequency setpoint is transferred via InterBus. Control via the digital inputs is still active. 13= InterBus control word . The control signals (enable, rotational direction ...) are transferred via InterBus, the setpoint via the analog input or the fixed frequencies. 14= InterBus . All control data and setpoints are transferred via InterBus. The analog input and the digital inputs have no function (except safety functions, see below)	
valid for SK 300/700/750E		
P510	Auxiliary setpoint interface	Always visible
0 ... 7	Selection of the interface from which the inverter is controlled.	
[0]	0 = Auto : The auxiliary setpoint value is automatically taken from the interface of the master setpoint value P509 >interface< 1 = USS 2 = CANbus	3 = Profibus 4 = InterBus 5 = CANopen 6 = DeviceNet 7 = Reserved
valid for SK 300/700/750E		

Parameter	Setting value / Description / Note	Available in Option
P509	Source control word	
0 ... 9	Selection of the interface via which the FI is controlled.	
[0]	0 = Control terminals or keyboard control ** with the Control Box (when P510=0), the Parameter Box (not ext. p-box) or via Bus I/O Bits.	
valid for SK 5xxE	1 = Only control terminals * , the FI can only be controlled via the digital and analog inputs or via the Bus I/O Bits.	
	2 = USS control word * , the control signals (enable, rotation direction, etc.) are transferred via the RS485 interface, the setpoint via the analog input or the fixed frequencies.	
	3 = CAN control word *	
	4 = Profibus control word *	
	5 = InterBus control word *	
	6 = CANopen control word *	
	7 = DeviceNet control word *	
	8 = reserved	
	9 = CAN Broadcast *	
	*) Keyboard control (ControlBox, ParameterBox) is blocked, parameterisation is still possible.	
	**) If the communication during keyboard control is interrupted (time out 0.5 sec), the FI will block without an error message.	

P510	... - 01 ... - 02	Setpoint source	
0 ... 8	Selection of the setpoint source to be parameterised.		
[0]	[01] = Master setpoint value source	[02] = Master setpoint value source	
valid for SK 5xxE	Selection of the interface via which the FI receives the setpoint.		
	0 = Auto: The source of the auxiliary setpoint is automatically derived from the setting in the parameter P509 >Interface<	4 = Profibus	
	1 = Control terminals , digital and analog inputs control the frequency, including fixed frequencies	5 = InterBus	
	2 = USS	6 = CANopen	
	3 = CAN	7 = DeviceNet	
		8 = reserved	

Parameter	Setting value / Description / Note	Available in Option
P513	Telegram down time	Always visible
0.0 / 0.1 ... 100.0 s [0.0]	Monitoring function of the active bus interface. Following receipt of a valid telegram, the next one must arrive within the set period. Otherwise the inverter reports an error and switches off with the error message E010 >Bus Time Out<. Monitoring is switched off at a setting value of 0.0.	
P543 (P)	Actual bus value 1	Always visible
0 ... 21 [1]	The return value 1 (IW1) can be set for bus control in this parameter. 0 = Off 1 = Actual frequency 2 = Actual speed 3 = Current 4 = Torque current 5 = Status of digital inputs and relay 6 = Actual position (with PosiCon, SK 700E only) 7 = Setpoint position (with PosiCon, SK 700E only) 8 = Setpoint frequency 9 = Error number	10 = Actual position increment¹ (with PosiCon, SK 700E only) 11 = Actual position increment¹ (with PosiCon, SK 700/750E only) 12 = Bus IO Out Bits 0...7 13 = ... 16 (reserved) 17 = Value analog input 1 (P400) 18 = Value analog input 2 (P405) 19 = Setpoint frequency master value (P507) 20 = Setpoint frequency after master value ramp 21 = Setpoint frequency without master value slip
P544 (P)	Actual bus value 2	Always visible
0 ... 21 [0]	The return value 2 (IW2) can be set for bus control in this parameter. This parameter is identical to P543. Condition is PPO 2 or PPO 4 type (P507).	
P545 (P)	Actual bus value 3	Always visible
0 ... 21 [0]	The return value 3 (IW3) can be set for bus control in this parameter. This is only available if P546 is ≠ 3 (not with SK 5xxE). This parameter is identical to P543. Condition is PPO 2 or PPO 4 type (P507).	
P546 (P)	Bus setpoint 1	Always visible
0 ... 6 [1] valid for SK 300/700/750E	In this parameter, a function is assigned to the delivered setpoint 1 (SW1) for bus control. 0 = Off 1 = Setpoint frequency (16 Bit) 2 = 16-bit setpoint position (with PosiCon option only) 3 = 32-bit setpoint position (only available with PosiCon option and when PPO type 2 or 4 is selected) 4 = PosiCon control terminals (only available with PosiCon option, 16-bit) 5 = Setpoint position (16 Bit) increment¹ (with PosiCon, SK 700E only) 6 = Setpoint position (32 Bit) increment¹ (with PosiCon, SK 700E only)	

¹ The setpoint/actual position corresponding to an 8192 increment encoder.

Parameter	Setting value / Description / Note	Available in Option
P546	Function bus - Setpoint 1	Always visible
0 ... 24	In this parameter, a function is allocated to the output setpoint 1 during bus actuation.	
[1]	NOTE: Further details can be found in the respective BUS operating instructions or in the description of P400.	
<i>valid for SK 5xxE</i>	0 = Off 1 = Setpoint frequency (16 Bit) 2 = Torque current limit (P112) 3 = Actual frequency PID 4 = Frequency addition 5 = Frequency subtraction 6 = Current limit (P536) 7 = Maximum frequency (P105) 8 = Actual PID frequency limited 9 = Actual PID frequency monitored 10 = Torque servo mode (P300) 11 = Torque lead (P214)	12 = Reserved 13 = Multiplication 14 = PI process controller actual value 15 = PI process controller setpoint 16 = PI process controller lead 17 = Digital In Bits 0...7 18 = Reserved 19 = Status output (P434/441/450/455=38) 20 = Value analog output (P418=31) 21 = ... 24 reserved
P547 (P)	Bus setpoint 2	Always visible
0 ... 20	In this parameter, a function is assigned to the delivered setpoint 2 (SW2) for bus control.	
[0]		
<i>valid for SK 300/700/750E</i>	0 = Off 1 = Setpoint frequency (16 Bit) 2 = Torque current limit (P112) 3 = Actual frequency PID 4 = Frequency addition 5 = Frequency subtraction 6 = Current limit (P536) 7 = Maximum frequency (P105) 8 = Actual PID frequency limited 9 = Actual PID frequency monitored 10 = Torque servo mode (P300) 11 = Torque lead (P214)	12 = Control terminals PosiCon (only with PosiCon option) 13 = Multiplication 14 = PI process controller actual value 15 = PI process controller setpoint 16 = PI process controller lead 17 = Digital In Bits 0...7 18 = Curve travel calculator 19 = Status output (P434/441/450/455=38) 20 = Value analog output (P418=31) 21 = ... 24 reserved

Parameter	Setting value / Description / Note	Available in Option
P547	Function bus - Setpoint 2	Always visible
0 ... 24 [0]	This parameter is identical to P546.	
<i>valid for SK 5xxE</i>		
P548 (P)	Bus setpoint 3	Always visible
0 ... 20 [0]	In this parameter, a function is assigned to the delivered setpoint 3 (SW3) for bus control. Only available if P546 is ≠ 3.	
<i>valid for SK 300/700/750E</i>		
P548	Function bus - Setpoint 3	Always visible
0 ... 24 [0]	This parameter is identical to P546.	
<i>valid for SK 5xxE</i>		
P551	Drive profile	Always visible
On / Off [0 = Off]	The InterBus Drivecom profile is activated with this parameter. 0: Switch off profile 1: Switch on profile as per DRIVECOM 21	

Information parameters:

P745	Module version	Always visible
0 ... 32767	Software version of the installed module (InterBus technology unit Index 01)	<u>Array level:</u> [01] Technology unit [02] Customer unit [03] Special extension unit
P746	Module status	Always visible
0000 ... FFFF hex	Status of installed modules (see 5.2) (InterBus technology unit Index 01)	<u>Array level:</u> [01] Technology unit [02] Customer unit [03] Special extension unit

**NOTE**

When activated, the functions **block voltage**, **quick stop**, **remote control** and **error acknowledgement** are available at the control terminals (local). To operate the drive, a high signal must be present on the digital inputs being used before the drive can be enabled.

5.3 LED display

The status of the InterBus technology unit is shown by 5(6) LED's :

- UL (green): Supply voltage applied
- RC (green): RemoteCheck
- BA (green): Bus Active
- RD (yellow): Remotebus Disabled
- TR (green): Transmit

2-colour LED

- ST (green): Module status
- ST (red): Module error

UL (green): InterBus power supply

Display	Meaning
Off	No power supply
On	InterBus power supply OK

RC (green): InterBus RemoteCheck

Display	Meaning
Off	Remote bus to previous subscriber interrupted - check corresponding cable connection
On	Remote bus to previous InterBus device OK

BA (green): Bus Active

Display	Meaning
Off	InterBus in stop state
On	InterBus data is being exchanged

RD (yellow): RemoteBus Disabled

Display	Meaning
Off	Remote bus to next InterBus device OK
On	Remote bus to next InterBus device disabled - check corresponding cable connection

TR (green): Transmit

Display	Meaning
Off	No communication at the moment
On	Communication telegrams are being transmitted to the access module

ST (red/green): Module status / Module error

ST (green) module status:

Display	Meaning
Off (red/green)	No voltage supply
Flashing (alternating with red)	Initialisation (init. phase)
On	Module OK

ST (red):

Display	Meaning
On	System error
Rapid flashing (0.2s)	Initialisation phase
Slow flashing (0.5s)	Time-out error
Isolated flashing	Inverter error (see frequency inverter instructions)
On	System error, e.g. plug contact not correct

6 Data transmission

6.1 Process data (PZD)

The inverter with InterBus technology unit is a slave on the InterBus. The process data are setpoint and actual data that need to be transmitted rapidly, e.g. motor speed.

In the process data area (PZD), control words and setpoints are transferred from the master to the slave and in return, status words and actual values are sent from the slave to the master.

6.1.1 The control word (STW)

The control word (STW) is the first word transferred to the frequency inverter in the process data area in an order telegram.

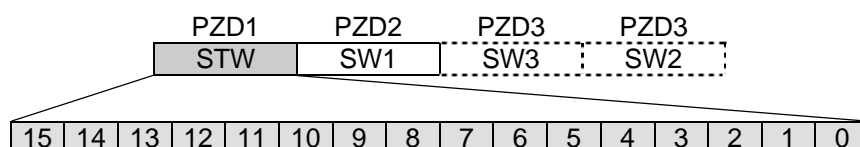

Significance of the individual bits

Bit	Value	Significance	Comments
0	0	OFF 1	Return with the brake ramp, at f=0Hz voltage activation
	1	ON	Ready for operation
1	0	OFF 2	Block voltage; the inverter output voltage is switched off, the FI goes into switch-on block status.
	1	Operating condition	OFF 2 is cancelled
2	0	OFF 3	Emergency stop with programmed emergency stop time; at f = 0Hz voltage enable; the FI goes into switch-on block status
	1	Operating condition	OFF 3 is cancelled
3	0	Block operation	Block voltage; the inverter output voltage is switched off, the FI goes into standby status.
	1	Enable operation	Output voltage enabled, run-up to present setpoint.
4	0	Block run-up encoder	Run-up encoder is set to zero; at f = 0Hz no voltage enable; FI remains in operation enabled status.
	1	Operating condition	Run-up encoder is enabled
5	0	Stop run-up encoder	Freezing of actual setpoint from run-up encoder (hold frequency).
	1	Enable run-up encoder	Enable setpoint on run-up encoder
6	0	Block setpoint	Selected setpoint is set to zero in the run-up encoder.
	1	Enable setpoint	Selected setpoint on run-up encoder is activated.
7	0		
	1	Acknowledge	With the switch from 0 to 1, inactive errors are acknowledged. <u>Note:</u> If a digital input is programmed to function "Error ack.", this Bit must not be set permanently to 1 via the bus (this will otherwise prevent edge detection).
8	0/1		Reserved
9	0/1		Reserved
10	0	PZD invalid	The transmitted process data is invalid.
	1	PZD valid	Valid process data is transferred from the master. <u>Note:</u> If setpoints only are transferred via the bus (setting: interface), this Bit must be set so that the setpoint transferred is valid.
11	0		
	1	Rotation right	Rotation right is on
12	0		
	1	Rotation left	Rotation left is on
13	0/1		Reserved
14	0/1	Parameter set switch Bit 0	00 Parameter set 1 01 Parameter set 2
15	0/1	Par. set switch Bit 1	10 Parameter set 3 11 Parameter set 4

6.1.2 The status word (ZSW)

The status word (ZSW) is the first word transferred to the inverter in the process data area in the inverter response telegram.

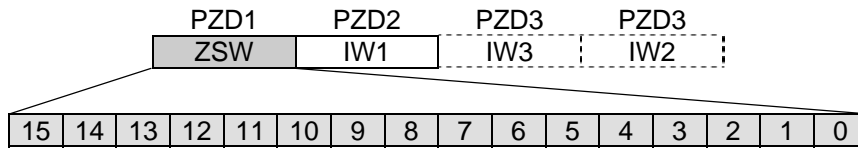

Significance of the individual bits

Bit	Value	Significance	Comments
0	0	Not on standby	
	1	Standby	Initialisation complete, load relay on, output voltage blocked
1	0	Not operational	Causes: No On command, an error has occurred, OFF 2 or OFF 3 active, switch-on block status active.
	1	Ready for operation	On command active, no errors. The inverter can be started with the ENABLE OPERATION command.
2	0	Operation blocked	
	1	Operation enabled	Output voltage enabled, run-up to present setpoint.
3	0	No errors	
	1	Error	Drive malfunctioning therefore out of order, if acknowledgement is successful, will go to switch-on block status.
4	0	OFF 2	OFF 2 command active
	1	No OFF 2	
5	0	OFF 3	OFF 3 command active
	1	No OFF 3	
6	0	No switch-on block	
	1	Switch-on block	Goes through OUT 1 to Standby status
7	0	No warning	
	1	Warning	Drive still in operation, no acknowledgement necessary
8	0	Actual value not O.K.	Actual value does not match the setpoint (with <i>posicon</i> : Setpoint position not reached)
	1	Actual value O.K.	Actual value matches the setpoint (setpoint reached) (with <i>posicon</i> : Setpoint position reached)
9	0	Local guidance	Local guidance active on device
	1	Guidance required	The Master is called upon to take over the guidance.
10	0	MFR 1 reference value undershot	Programmed function of the MFR 1 not met or actual value < programmed reference value
	1	MFR 1 reference value reached	Programmed function of the MFR 1 met or actual value > programmed reference value
11	0		
	1	Rotation right	Inverter output voltage has right-hand rotating field
12	0		
	1	Rotation left	Inverter output voltage has left-hand rotating field
13	0	MFR 4 reference value undershot	For SK 700E only with <i>posicon</i> upgrade: status MFR 4 = 0
	1	MFR 4 reference value reached	For SK 700E only with <i>posicon</i> upgrade: status MFR 4 = 1
14	0/1	Actual active parameter set Bit 0	00 Parameter set 1 01 Parameter set 2
15	0/1	Actual active parameter set Bit 1	10 Parameter set 3 11 Parameter set 4

6.1.3 The setpoint 1 (SW1)

The function of the 1st setpoint is set in parameter P546. The following options are available:

Setpoint frequency (16 Bit)

The setpoint frequency in setpoint 1 is transferred as a 16 Bit value as standard. Setpoint 1 is transferred to the inverter as the second word in the process data area in the order telegram.

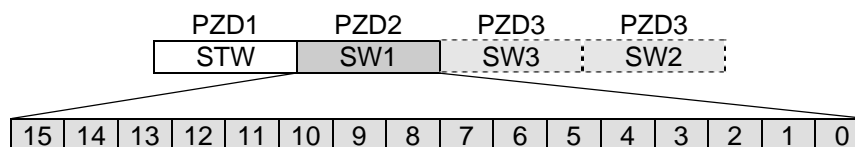

The setpoint is transferred as a whole number with a value range of -32768 to 32767 (8000 hex to 7FFF hex). The value 16384 (4000 hex) is equal to 100%. The value C000 HEX is equal to -100%. A setpoint of 100% corresponds to the parameter **maximum frequency** (parameter P105) set in the same parameter set.

Setpoint position (16 or 32 Bit)

Using the *posicon* special upgrade for the SK 700E, the absolute setpoint position can be transferred in setpoint 1. It can be transferred as a 16 or 32 Bit value with a resolution of 1=0.001 revolutions. In addition, the control terminals (*PosiCon control bits setting*) can be transferred in binary.

16-Bit setpoint position setting:

A value range of +32767 (= 32.767 revolutions) to -32768 (= -32.768 revolutions) is possible as a **16 Bit** value. The 16 Bit setpoint position is transferred as a second word in the area of the process data (like the setpoint frequency, see above)

32-Bit setpoint position setting:

The full position range of +/- 50000,000 revolutions is available as a 32 Bit value. The 32 Bit setpoint position is transferred as the **second and third** word in the process data area:

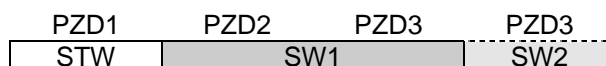

Posicon control bits setting:

A 16 Bit value is transferred in which the control terminals of the *posicon* special extension unit are mapped. The setpoint position is based on the position array / position increment as per the P610 setpoint mode. The transferred bits have the following significance (see operating instructions BU 0710):

Bit 0 -5	Bit0-Bit5 positional array / positional increm.
Bit 6	Reference point run
Bit 7	Reference Point
Bit 8	Teach-in
Bit 9	Quit teach-in
Bit 10	Reset position

6.1.4 Second and third setpoint (SW2/3)

If the PPO type 2 or 4 is used, in addition to setpoint 1, a 2nd setpoint can be transferred in word PZD4 and a 3rd setpoint in PZD3.

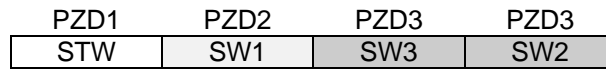

A third setpoint value can only be transferred if a 32 Bit setpoint value is not transferred in the first setpoint.

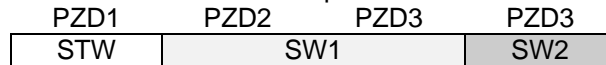

The second and third setpoints are always 16 Bits. The function of the second and third setpoints can be set in the inverter with parameter P547 'Setpoint 2 function' and P548 'Setpoint 3 function' respectively. Both setpoints are transferred as whole numbers in the range -32768 to 32767. The value 16384 (4000 HEX) is equal to 100%. The value C000 HEX is equal to -100%, so setpoints in the range -200% to +200% can be transferred. A setpoint of 100% corresponds to the respective nominal size:

Setting	100% equals
Off	
Setpoint frequency, actual frequency PID, actual frequency PID limited, actual frequency PID monitored, frequency addition, frequency subtraction, maximum frequency	Maximum frequency
Torque current limit	Torque current limit (P112)
Current limit	Inverter nominal current
Servo mode torque	Nominal torque
Torque precontrol	Torque precontrol (P214)

In addition, PosiCon control bits can be transferred here (see setpoint 1)

6.1.5 The actual value 1 (IW1)

The actual frequency, i.e. the actual output frequency of the inverter, is transferred as a 16 Bit value as standard. The actual value 1 is transferred to the master in the inverter response telegram as the second word in the process data area.

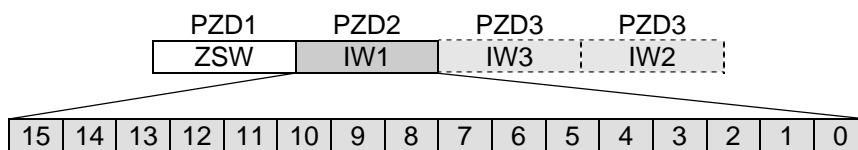

The actual value 1 is transferred as a whole number in the range -32768 to 32767. In addition to the actual frequency, other actual inverter values can be transferred. The setting is made in P543 'Actual value 1 function'.

The settings 'Actual frequency', 'Actual speed', 'Current' and 'Torque current' are transferred as percentages of the respective nominal sizes. The value 16384 (4000 HEX) is equal to 100%. The value C000 HEX is equal to -100%. Actual values in the range -200% to +200% can be transferred.

With the setting 'Digital I/O status', the states of the control terminals and the relay (MFR) can be transferred:

Bit	Status
Bit 0 -5	Digital input 1-6
Bit 6-11 for Posicon special extension unit	Digital input 7-12
Bit 6 for encoder special extension unit	Digital input 7
Bit 12 -15	Multifunctional relay 1-4

With the settings 'Actual position' and 'Setpoint position', the actual absolute position is transferred. The resolution is 1 = 0.001 revolutions. If the value 'Setpoint position 32 Bit' is set in parameter P546 'Setpoint 1 function', the actual value of the setpoint or actual position is also transferred as a 32 Bit value in PZD2 and PZD3:

PZD1	PZD2	PZD3	PZD3
ZSW	IW1	IW2	IW2

Please notice: with all SK5XXE inverter units the SW2 and SW3 are exchanged and IW2 and IW3 are exchanged, too. So the setpoints protocol is STW – SW1 – SW2 – SW3 and the status is ZSW – IW1 – IW2 – IW3.

6.1.6 Actual value 2 and actual value 3 (IW2/3)

It is possible to forward two more actual values to the controller when PPO type 2 or 4 is used for transfer. Actual value 2 (IW2) is transferred in PZD4. The value to be transferred can be selected in P544 (actual bus value 2). Actual value 3 (IW3) can be transmitted in PDZ3 if actual value 1 is **not** a 32 Bit value. The value to be transferred can be selected in P545 (actual bus value 3). The standardisations correspond to those of actual value 1 (see above)

6.2 The status machine

The frequency inverter passes through a status machine. The changes between various states are triggered by the respective control commands in the process data control word. The actual status is returned in the process data status word.

After switching on, the inverter is in switch-on block status. This status can only be ended by transmitting the "Shut down (Off 1)" command.

The answer to a master telegram normally does not yet contain a reaction to the control command. The controller has to check the answers from the slaves as to whether the control command has been carried out.

The following Bits indicate the status of the frequency inverter:

Status	Bit6 Switch-on block	Bit5 Emergency stop	Bit 4 Block voltage	Bit3 Error	Bit2 Operation enabled	Bit1 Ready for operation	Bit0 Standby
Not on standby	0	X	X	0	0	0	0
Switch-on block	1	X	X	0	0	0	0
Standby	0	1	1	0	0	0	1
activated	0	1	1	0	0	1	1
Operation enabled	0	1	1	0	1	1	1
Error	0	X	X	1	0	0	0
Error active	0	X	X	1	1	1	1
Emergency stop active	0	0	1	0	1	1	1

Internal status machine

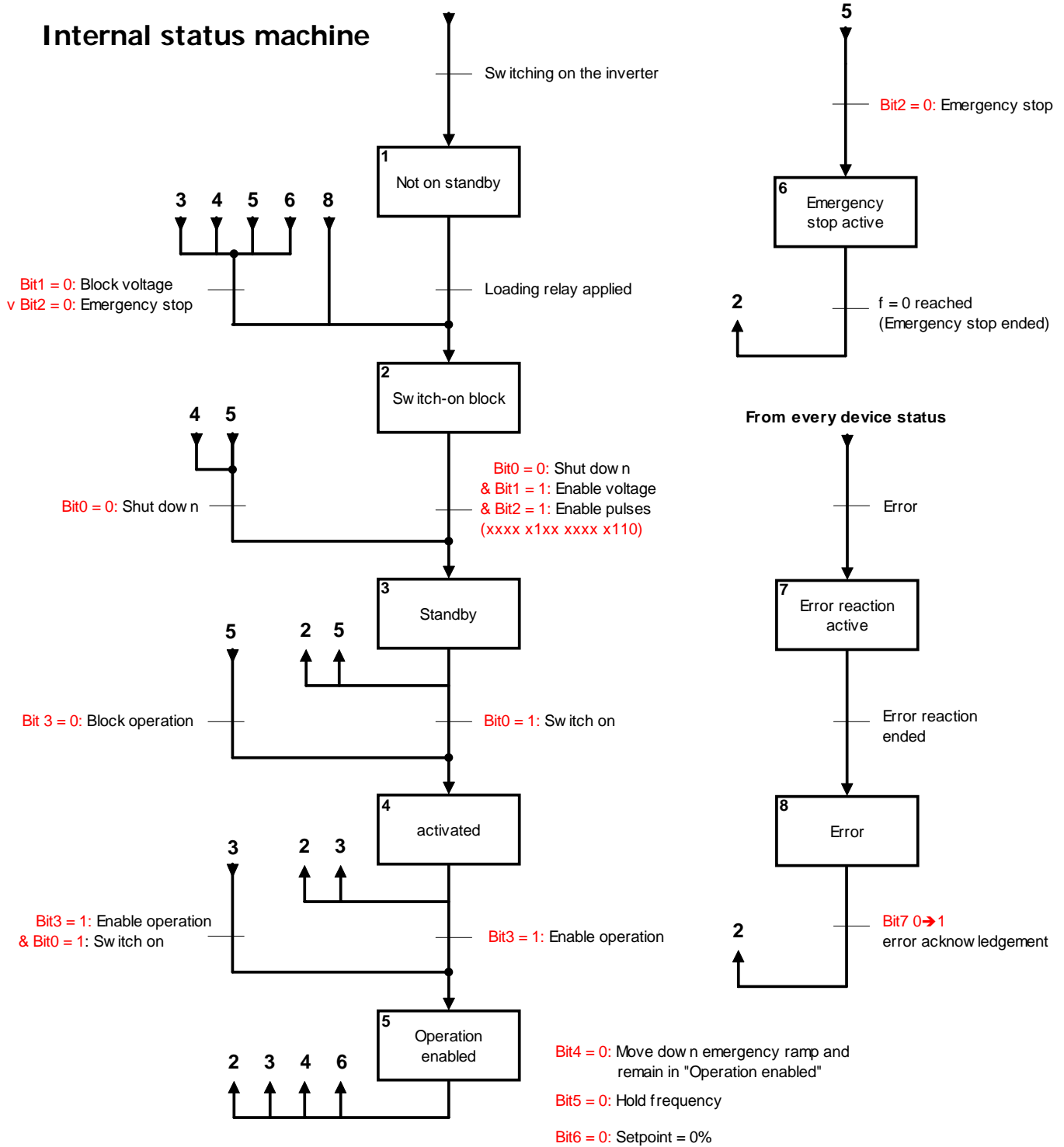

6.3 Parameter orders with Compact PCP

Parameter data are divided into individual parameter blocks and transmitted in sequence. This is implemented by the PCP (Peripherals Communication Protocol). The transmission of a parameter can therefore take several bus cycles. This is slower in comparison to process data transmission.

The IBS technology unit has an integrated 1 word PCP channel.

The PCP is implemented in the Compact PCP version.

Compact PCP has limited functionalities in comparison to the full PCP version. The following commands are supported: initiate, read, write

 The Phoenix Contact software for the InterBus master offers full Compact PCP support from firmware 4.60 onwards.

The object index (OI) used in PCP is omitted here.

6.3.1 Frequency inverter parameters (2000_{hex} -23E7_{hex})

All FI parameters can be accessed directly via the parameter channel.

 With InterBus protocol, the inverter parameters are mapped in the range 2000_{hex} to 23E7_{hex} (= 8192_{dec} to 9191_{dec}), i.e. when parameterisation is carried out via the bus, the parameter numbers must be added to the value 2000_{hex} (e.g. P508 → obj 21FC_{hex}).

Index	Sub	Object	Description	Unit	Acc	Type
2000-23E7	-	Manufacturer-specific parameters	FI parameters (see inverter operating instructions)	-	-	-

6.3.2 Drive profile as per DRIVECOM21

 The following parameters are only valid if the frequency inverter parameter drive profile (P551) is switched on. The profile is not valid in PPO type 2. The objects remain valid for the 1st parameter set only.

 The DRIVECOM objects are described in more detail in Chap. 6.4.

Index	Sub	Object	Description	Unit	Acc	Type
6000	-	PE data description	Control word	-	RO	U8
6001	-	PA data description	Control word	-	RO	U8
6002*	-	PA data enabled	Control word	-	RW	U16
603F	-	Error code	Error description	-	RO	U32
6040*	-	Control word	Control word	-	RW	U16
6041*	-	Status word	Status word	-	RO	U16
6042	-	Speed setpoint	Speed setpoint	rpm	RW	I16
6043	-	Speed control variable	Setpoint speed behind ramp	rpm	RO	I16
6044	-	Speed actual value	Actual speed value	rpm	RO	I16
6046	ARR	Speed min/max amount	Speed min/max amount	-	RW	ARR
	1	Speed min. amount	Speed min. amount	rpm	RW	U32
	2	Speed max. amount	Speed max. amount	rpm	RW	U32
6048	REC	Speed acceleration	Speed acceleration	-	RO	REC
	1	Delta speed	Delta speed	rpm	RW	U32
	2	Delta time	Delta time	s	RW	U16
6049	REC	Speed deceleration	Speed deceleration	-	RO	REC
	1	Delta speed	Delta speed	rpm	RW	U32
	2	Delta time	Delta time	s	RW	U16

 • The control word 6040 or the setpoint 6041 is only valid when object 6002 (PA data enabled) is switched off (not equal to 0xFF). Otherwise (6002=FF) control word and setpoint of the process data channel are valid.

6.4 Drive profile DRIVECOM 21

If the drive profile parameter (P551) is switched on in the frequency inverter, the device supports the profile as per DRIVECOM 21 (speed profile). The mandatory objects are implemented (see overview).



The profile is only valid in parameter set 1.

6.4.1 Speed functions overview

Speed function 1

(Mandatory objects only)

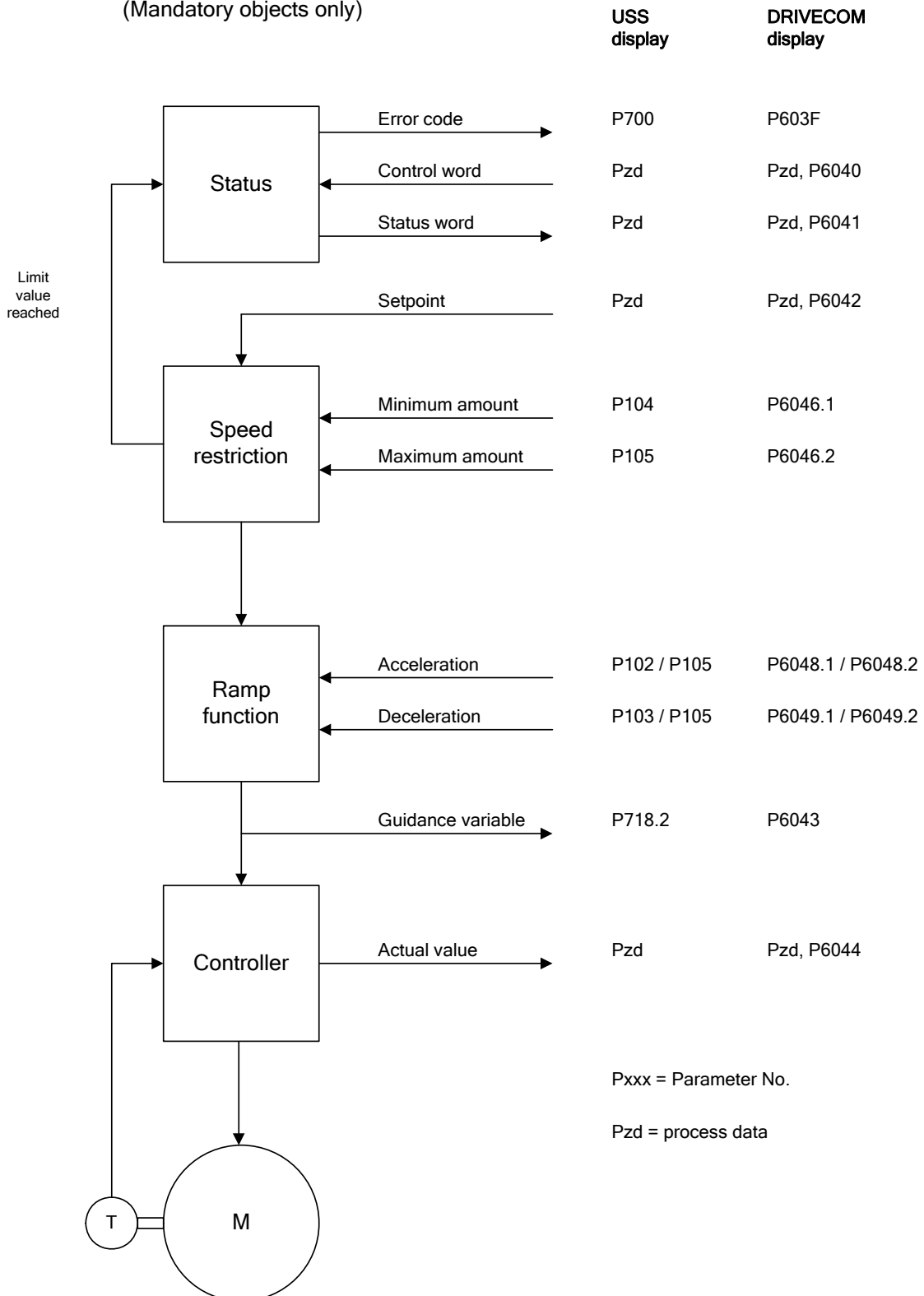

6.4.2 Object description

Object 603F error code

Code	Error description	Code	Error description
0	No error	6000	Device software
1000	General error	6310	Parameter loss
2200	Internal device current	7112	Brake chopper overcurrent
2310	Constant output overcurrent	7120	Motor
3110	Mains overvoltage	7300	Sensor
3120	Mains undervoltage	7305	Incremental encoder 1
3130	Phase failure	7306	Incremental encoder 2
3210	Internal device overvoltage	7310	Speed sensor
3230	Charging error	7320	Position sensor
4210	Device overheating	8100	Communication monitoring
4310	Drive overheating	8300	Torque controller
5110	Low voltage supply	8400	Speed controller
5300	Operation unit	8612	Reference limit
5510	RAM data memory	9000	External error
5520	Eprom data memory		
5530	EEPROM data memory		

Object 6040 control word and 6041 status word

6040 control word		6041 status word	
Bit	InterBus significance	Bit	InterBus significance
0	Switch on	0	Standby
1	Block voltage	1	Switched on
2	Emergency stop	2	Operation enabled
3	Enable operation	3	Error
4	Block run-up encoder	4	Current blocked
5	Stop RUE	5	Emergency stop
6	RUE zero	6	Switch-on block
7	Reset error	7	Warning
8	Reserve	8	0
9	Reserve	9	Remote
10	Reserve	10	Setpoint reached
11	Rotary direction (0=right)	11	Limit value*
12	Free	12	0
13	Free	13	0
14	Free	14	Rotation direction (0=right)
15	Free	15	0

*Min or max value reached

7 Example telegrams

Various example telegrams are shown below to clarify the control and parameterisation of the frequency inverter with InterBus.

7.1 Switch-on block → Standby

A frequency inverter must be switched from the "Switch-on block" status (STW Bit 0 – 0), which is active when the device is switched on, to the "Standby" status (STW Bit 0 = 1). Parameter set 1 is valid. Only the PZD channel is evaluated.

Procedure:

- Check last status word (ZSW 0A 70)
- Generate control word (STW 04 7E)
- Check response telegram (ZSW 0A 31)

Details:

Status word of frequency inverter → frequency inverter is in *switch-on block* status

Bit	Value	Value HEX	Significance
15	0	0	Parameter set Bit 1 off
14	0		Parameter set Bit 0 off
13	0		Reserved
12	0		Rotation left is off
11	1	B	Rotation right is on
10	0		Reference value undershot
9	1		Bus controller
8	1		Setpoint = actual value
7	0	7	No warning
6	1		Switch-on block
5	1		No emergency stop
4	1		Block voltage
3	0	0	No errors
2	0		Operation blocked
1	0		Not ready for operation
0	0		Not at standby

9	10	11	12
ZSW	ZSW	IW1	IW1
0B	70	00	00

Abbreviations used:

PKW Parameter identifier Value
 PZD Process data
 PKE Parameter identifier
 IND Index
 PWE Parameter Value
 STW Control word 1
 ZSW Status word 1
 SW1..3 Setpoint
 IW1..3 Actual value

To switch the frequency inverter to the *Standby* status, the following telegram must be sent:

9	10	11	12
STW	STW	SW1	SW1
04	7E	00	00

When the frequency inverter switches to the *Standby* status, it sends the following response telegram:

9	10	11	12
ZSW	ZSW	IW1	IW1
0B	31	00	00

Note: The control telegram must be sent cyclically as the frequency inverter may not switch to the required status within the response time of a telegram.

7.2 Enable with 50% setpoint

A frequency inverter in the "Standby" status must be enabled for clockwise rotation with 50% setpoint. The last response telegram was received as follows in the controller.

Procedure:

- Check last status word (ZSW 0A 31)
- Generate control word (STW 04 7F)
- Check response telegram (ZSW 0F 37)

Details:

Starting requirement (status word of frequency inverter)

9	10	11	12
ZSW	ZSW	IW1	IW1
0B	31	00	00

The following telegram must be sent to the frequency inverter

9	10	11	12
STW	STW	SW1	SW1
04	7F	20	00

The frequency inverter accelerates the motor in the ramp. When the inverter reaches 50% setpoint, it responds with the following telegram.

9	10	11	12
ZSW	ZSW	IW1	IW1
0F	37	20	00

Note: The status of MFR 1 is indicated in Bit 10 of the response telegram. Depending on the programmed function and status, the status word may differ.

7.3 Writing a parameter

When transferring parameter orders, it must be taken into account that the slave does not immediately respond to orders in the parameter channel of the master telegram, but a positive response can be delayed by one or more communication cycles. The master must therefore repeat the required order until the corresponding slave response is received.

The parameter acceleration time ($PNU = 102_{dec} / 66_{hex}$) of a frequency inverter should be set to the value 10sec in parameter set 3. Only the PKW channel is evaluated.

As the acceleration time has a frequency-internal resolution of 0.01sec, a parameter value of $10 / 0.01 = 1000$ ($3E8_{hex}$) must be transferred for 2 sec.

Procedure:

- Select parameter ($P 102_{dec} + 1000 = P 1102 = P 44E_{hex}$)
- Select parameter set 3 (IND = 02)
- Set parameter value ($1000_{dec} / 3E8_{hex}$)
- Check response telegram

The telegram is composed as follows in hexadecimal notation:

3	4	5	6	7	8	9	10
PKE	PKE	IND	IND	PWE	PWE	PWE	PWE
24	4E	02	00	00	00	03	E8

When the order has been fully implemented by the inverter, it responds with

3	4	5	6	7	8	9	10
PKE	PKE	IND	IND	PWE	PWE	PWE	PWE
14	4E	02	00	00	00	03	E8

8 Additional information

8.1 Repairs

The device must be sent to the following address if it needs repairing:

NORD Electronic DRIVESYSTEMS GmbH

Tjüchkampstraße 37
26605 Aurich, Germany

For queries about repairs, please contact:

Getriebebau NORD GmbH & Co. KG

Telephone: +49 4532 / 401 514 or 401 518
Fax: 04532 / 401-555

If a frequency inverter or accessories are sent in for repair, no liability can be accepted for any added components, e.g. such as line cables, potentiometer, external displays, etc.!

Please remove all non-original parts from the frequency inverter.

9 Technical data

Bus connection	Remote bus
Data width	3 words (1 word PCP) →PPO type 1 5 words (1 word PCP) →PPO type 2
ID	E3 _{hex} : with profile F3 _{hex} : without profile
Baud rate	500kBit/sec (2MBaud on request)
External power supply	24V +/-10% *
5V-out at IBS-Out	max. 100mA

* can be operated optionally via internal 5V (e.g. for commissioning)

10 Keyword index

2	
24V.....	7, 10
A	
Actual value	26, 27
B	
Bus cable	12
Bus configuration	12
Bus parameters	15
C	
Control word	23
E	
Example telegrams	32
F	
FE (function earth)	8, 11
I	
IW1.....	26
IW2.....	27
IW3.....	27
M	
M12 connector	10
M8 connector	10
O	
Object description	31
P	
PPO type 1.....	13
PPO type 2.....	13
Process data	23, 24
R	
Repairs.....	35
S	
Setpoint.....	25, 26
SK 300E.....	9
SK 500/520E.....	7
SK 700E.....	7
SK 750E.....	9
SK TU1-IBS	7
SK TU2-IBS	9
SK TU3-IBS	7
Status LEDs.....	8, 9, 21
Status machine	27
Status of the InterBus module	20
Status word.....	24
STW	23
SW1	25
SW2/3	26
T	
Technical Data	36
Transmission times.....	14
Z	
ZSW	24

11 Sales agencies and branch offices

<u>N O R D branches worldwide:</u>		
<p>Brazil / Brasilien NORD Motoredutores do Brasil Ltda. Rua Dr. Moacyr Antonio de Moraes, 700 Parque Santo Agostinho Guarulhos – São Paulo CEP 07140-285 Tel.: +55-11-6402 8855 Fax: +55-11-6402 8830 info@nord-br.com</p>	<p>Canada / Kanada NORD Gear Limited 41, West Drive CDN - Brampton, Ontario, L6T 4A1 Tel.: +1-905-796-3606 Fax: +1-905-796-8130 info@nord-ca.com</p>	<p>Mexico / Mexiko NORD GEAR CORPORATION Mexico Regional Office Av. Lázaro Cárdenas 1007 Pte. San Pedro Garza Garcia, N.L. México, C.P. 66266 Tel.: +52-81-8220-9165 Fax: +52-81-8220-9044 HGonzalez@nord-mx.com</p>
<p>India / Indien NORD Drivesystems Pvt. Ltd. 21 VEDAS CENTRE D.P. Road AUNDH Pune Maharashtra - 411 057 Tel: +91-2(0)-5889 373 Fax: +91-2(0)-5888 872 info@nord-in.com</p>	<p>Indonesia / Indonesien PT NORD Indonesia Jln. Raya Serpong KM. 7 Kompleks Rumah Multi Guna Blok D No. 1 Pakulonan (Serpong) - Tangerang West Java - Indonesia Tel.: +62-21-5312 2222 Fax: +62-21-5312 2288 info@nord-ri.com</p>	<p>P.R. China / V. R. China NORD (Beijing) Power Transmission Co.Ltd. No. 5 Tangjiacun, Guangqudonglu, Chaoyangqu Beijing 100022 Tel.: +86-10-67704 -069 (-787) Fax: +86-10-67704 -330 nordac@nord-cn.com</p>
<p>Singapore / Singapur NORD Gear Pte. Ltd. 33 Kian Teck Drive, Jurong Singapore 628850 Tel.: +65-6265 9118 Fax: +65-6265 6841 info@nord-sg.com</p>	<p>United States / USA NORD Gear Corporation 800 Nord Drive / P.O. Box 367 USA - Waunakee, WI 53597-0367 Tel.: +1-608-849 7300 Fax: +1-608-849 7367 info@nord-us.com</p>	<p>P.R. China / V. R. China NORD (Suzhou) Power Transmission Co.Ltd. 地址：苏州工业园区长阳街510号 No. 510 Changyang Street, Suzhou Ind. Park, Jiangsu, China. P.C : 215021 总机 Tel : +86-512-85180277 传真 Fax: +86-512-85180278 Kweng@nord-cn.com</p>

NORD branches in Europe:		
<p>Austria / Österreich Getriebebau NORD GmbH Deggendorfstr. 8 A - 4030 Linz Tel.: +43-732-318 920 Fax: +43-732-318 920 85 info@nord-at.com</p>	<p>Belgium / Belgien NORD Aandrijvingen Belgie N.V. Boutersem Dreef 24 B - 2240 Zandhoven Tel.: +32-3-4845 921 Fax: +32-3-4845 924 info@nord-be.com</p>	<p>Croatia / Kroatien NORD Pogoni d.o.o. Obrtnicka 9 HR - 48260 Krizevci Tel.: +385-48 711 900 Fax: +385-48 270 494 nord-pogoni@kc.htnet.hr</p>
<p>Czech. Republic / Tschechien NORD Poháněci Technika s.r.o Palackého 359 CZ - 50003 Hradec Králové Tel.: +420-495 5803 -10 (-11) Fax: +420-495 5803 -12 hzubr@nord-cz.com</p>	<p>Denmark / Dänemark NORD Gear Danmark A/S Kliplev Erhvervspark 28 – Kliplev DK - 6200 Aabenraa Tel.: +45 73 68 78 00 Fax: +45 73 68 78 10 info@nord-dk.com</p>	<p>Finland / Finnland NORD Gear Oy Aunankorvenkatu 7 FIN - 33840 Tampere Tel.: +358-3-254 1800 Fax: +358-3-254 1820 info@nord-fi.com</p>
<p>France / Frankreich NORD Réducteurs sarl. 17 Avenue Georges Clémenceau F - 93421 Villepinte Cedex Tel.: +33-1-49 63 01 89 Fax: +33-1-49 63 08 11 info@nord-fr.com</p>	<p>Great Britain / Großbritannien NORD Gear Limited 11, Barton Lane Abingdon Science Park GB - Abingdon, Oxfordshire OX 14 3NB Tel.: +44-1235-5344 04 Fax: +44-1235-5344 14 info@nord-uk.com</p>	<p>Hungary / Ungarn NORD Hajtastechnika Kft. Törökkö u. 5-7 H - 1037 Budapest Tel.: +36-1-437-0127 Fax: +36-1-250-5549 info@nord-hg.com</p>
<p>Italy / Italien NORD Motoriduttori s.r.l. Via Newton 22 IT-40017 San Giovanni in Persiceto (BO) Tel.: +39-051-6870 711 Fax: +39-051-6870 793 info@nord-it.com</p>	<p>Netherlands / Niederlande NORD Aandrijvingen Nederland B.V. Voltstraat 12 NL - 2181 HA Hillegom Tel.: +31-2525-29544 Fax: +31-2525-22222 info@nord-nl.com</p>	<p>Norway / Norwegen Nord Gear Norge A/S Solgaard Skog 7, PB 85 N-1501 Moss Tel.: +47-69-206 990 Fax: +47-69-206 993 info@nord-no.com</p>
<p>Poland / Polen NORD Napedy Sp. z.o.o. Ul. Grottgera 30 PL – 32-020 Wieliczka Tel.: +48-12-288 22 55 Fax: +48-12-288 22 56 biuro@nord-pl.com</p>	<p>Russian Federation / Russland OOO NORD PRIVODY Ul. A. Nevsky 9 RU-191167 St.Petersburg Tel.: +7-812-327 0192 Fax: +7-812-327 0192 info@nord-ru.com</p>	<p>Slovakia / Slowakei NORD Pohony, s.r.o Stromová 13 SK - 83101 Bratislava Tel.: +421-2-54791317 Fax: +421-2-54791402 info@nord-sk.com</p>
<p>Spain / Spanien NORD Motorreductores Ctra. de Sabadell a Prats de Lluçanès Aptdo. de Correos 166 E - 08200 Sabadell Tel.: +34-93-7235322 Fax: +34-93-7233147 info@nord-es.com</p>	<p>Sweden / Schweden NORD Drivsystem AB Ryttargatan 277 / Box 2097 S - 19402 Upplands Väsby Tel.: +46-8-594 114 00 Fax: +46-8-594 114 14 info@nord-se.com</p>	<p>Switzerland / Schweiz Getriebebau NORD AG Bächigenstr. 18 CH - 9212 Arnegg Tel.: +41-71-388 99 11 Fax: +41-71-388 99 15 info@nord-ch.com</p>
<p>Turkey / Türkei NORD-Remas Redüktör San. ve Tic. Ltd. Sti. Tepeören Köyü TR - 34959 Tuzla – Istanbul Tel.: +90-216-304 13 60 Fax: +90-216-304 13 69 info@nord-tr.com</p>		<p>Ukraine / Ukraine GETRIEBEBAU NORD GmbH Repräsentanz Vasilkovskaja, 1 office 306 03040 KIEW Tel.: + 380-44-537 0615 Fax: + 380-44-537 0615 vtsoka@nord-ukr.com</p>

NORD offices in Germany



Getriebebau NORD GmbH & Co. KG

Rudolf- Diesel- Str. 1 · 22941 Bargteheide

Telephone +49 4532 / 401 - 0

Fax +49 4532 / 401 - 253

info@nord-de.com

www.nord.com



North branches

Getriebebau NORD GmbH & Co. KG

Rudolf- Diesel- Str. 1 · 22941 Bargteheide

Telephone +49 4532 / 401 - 0

Fax +49 4532 / 401 - 253

NL-Bargteheide@nord-de.com

Sales office Bremen

Getriebebau NORD GmbH & Co. KG

Stührener Weg 27 · 27211 Bassum

Telephone +49 4249 / 9616 - 0

Fax +49 4249 / 9616 - 76

NL-Bremen@nord-de.com

Representative:

Hans-Hermann Wohlers Handelsgesellschaft mbH

Ellerbuscher Str. 179 · 32584 Löhne

Telephone +49 5732 / 40 72

Fax +49 5732 / 123 18

NL-Bielefeld@nord-de.com

West branches

Getriebebau NORD GmbH & Co. KG

Großenbaumer Weg 10 · 40472 Düsseldorf

Telephone +49 211 / 99 555 - 0

Fax +49 211 / 99 555 -45

NL-Duesseldorf@nord-de.com

Sales Office Butzbach

Getriebebau NORD GmbH & Co. KG

Marie- Curie- Str. 2 · 35510 Butzbach

Telephone +49 6033 / 9623 - 0

Fax +49 6033 / 9623 - 30

NL-Frankfurt@nord-de.com

South branches

Getriebebau NORD GmbH & Co. KG

Katharinenstr. 2-6 · 70794 Filderstadt- Sielmingen

Telephone +49 7158 / 95608 - 0

Fax +49 7158 / 95608 - 20

NL-Stuttgart@nord-de.com

Sales Office Nuremberg

Getriebebau NORD GmbH & Co. KG

Schillerstr. 3 · 90547 Stein

Telephone 0911 / 67 23 11

Telefax 0911 / 689378 - 0

NL-Nuernberg@nord-de.com

Sales Office Munich

Getriebebau NORD GmbH & Co. KG

Untere Bahnhofstr. 29a · 82110 Germering

Telephone +49 89 / 840 794 - 0

Fax +49 89 / 840 794 - 20

NL-Muenchen@nord-de.com

East branches

Getriebebau NORD GmbH & Co. KG

Leipzigerstr. 58 · 09113 Chemnitz

Telephone +49 371 / 33 407 - 0

Fax +49 371 / 33 407 - 20

NL-Chemnitz@nord-de.com

Sales Office Berlin

Getriebebau NORD GmbH & Co. KG

Heinrich- Mann- Str. 8 · 15566 Schöneiche

Telephone +49 371 / 639 79 - 0

Fax +49 371 / 639 79 - 414

NL-Berlin@nord-de.com