

Product Catalog Provit 5000/5600

Perfection in Automation
www.br-automation.com



Imprint

Providing a high-quality catalog is very important to us. In spite of this conscientious approach, however, B&R cannot guarantee or assume liability for the correctness, timeliness, or completeness of the contents and information contained herein. B&R shall not be held liable for possible tangible or intangible damages caused by incorrect or incomplete information unless proven to be caused by intent or gross negligence on the part of B&R. We additionally reserve the right to update the contents and technical characteristics of the products contained herein at any time.

Product Catalog Provit 5000/5600

Publisher:
Bernecker + Rainer Industrie-Elektronik Ges.m.b.H
B&R Strasse 1
5142 Eggelsberg
Austria

Tel.: +43 (0) 7748/6586-0
Fax: +43 (0) 7748/6586-26









info@br-automation.com
www.br-automation.com

Photo credits: B&R

Printing and processing:
Vorarlberger Verlagsanstalt AG, Dornbirn, Austria
www.vva.at

MM-E00631.418

Table of contents

System characteristics	 4
Typical topologies	 6
Product overview	 10
Product data sheets	 16
General technical data	 23
Dimensions	 24
Legend strips	 29
Accessories	 30
Index	 52

System characteristics



Provit 5000/5600 – Modular industrial PCs

Unlike many other IPC complete solutions, Provit industrial PCs from B&R have an uncompromising modular design. This means that display units and IPC5000C or IPC5600C controllers can be selected and combined as desired when using Provit 5000 and Provit 5600 systems. Limitations, such as the largest display requiring the most memory and fastest processor, simply don't exist. This allows both the display unit as well as the controller to be optimally matched to the respective application.

Made by B&R

Provit industrial PCs are "Made by B&R". As a result, all of the relevant components such as the motherboard and housing are developed and manufactured by B&R. The latest production and testing equipment guarantees the high quality that industrial users expect for continuous operation.

Individually configurable

IPC5000C and IPC5600C industrial PCs offer unique flexibility in this performance class. Their division into bus and system units means that these industrial PCs can be configured with a varied number of slots. For example, the IPC5000C can be equipped with two or five half-size PCI, ISA and PCI/ISA slots. A bus unit with five slots is available for the IPC5600C as well (four of these slots are for full-size cards). All bus units are offered in two versions for 120/230 VAC or 24 VDC. The processor and RAM can also be selected from the available product spectrum.



Integrated industrial communication

IPC5000C and IPC5600C controllers are equipped with all the necessary interfaces required for industrial communication:

- 2 x RS232
- 1 x parallel
- 2 x USB
- 2 x PS/2 for keyboard and mouse
- 1 x VGA for external monitor (in addition to the display unit)
- 1 x Ethernet 10/100 MBit/s
- External floppy drive or remote CD-ROM drive

In addition, other insert cards with interface expansions can be used at any time.

Reliable operation with CompactFlash

Modularity plays a role even for the mass memory. Instead of an installed hard disk, the IPC5000C has a slot which can be used to connect either a hard drive, a CompactFlash adapter, or a combination of both. CompactFlash memory has an available capacity between 64 MB and 8 GB. The IPC5600C also offers a second slot so that two hard drives can be combined here as well. All of these options are enough to guarantee secure operation for all applications, even under unusual conditions.

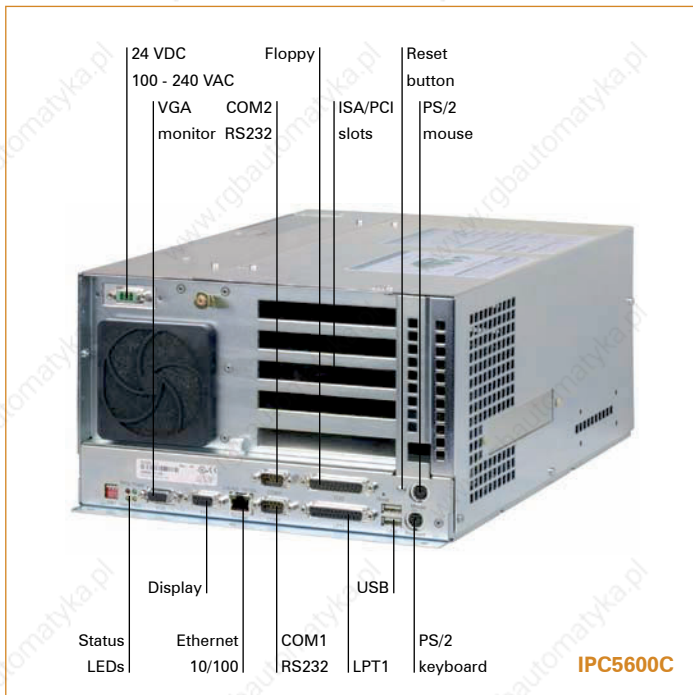

Extensive system diagnostics

In addition to demands on mechanical stability and load capacity, operational safety and diagnostics also play a crucial role. For this reason, a logbook is available on the Provit 5000 and Provit 5600 devices to record operating hours, power-on cycles, overtemperature hours, and fan and display operating times. This information can then be interpreted by the user to gain insight into the operational status of the IPC.

Optimal user guidance with touch screen and function keys

Provit 5000/5600 display units are available with diagonals of 10.4" to 15" and VGA to XGA resolution. The front of the panels feature IP65 protection from sprayed water. Devices are available with a touch screen, a touchpad (Provit 5600), and function keys to ensure optimum user guidance. Function keys can be individually marked with symbols using legend strips. Both key and LED functions can be easily defined using software.

Product comparison: IPC5000C / IPC5600C

	IPC5000C	IPC5600C
Processor	Intel Celeron 566, Pentium III 600, Pentium III 850	Intel Celeron 566, Pentium III 600, Pentium III 850
Memory	64 - 512 MB	64 - 512 MB
Graphics	ATI Rage Mobility M, 4 MB video RAM	ATI Rage Mobility M, 4 MB video RAM
Ethernet	1 x 10/100 MBit/s	1 x 10/100 MBit/s
Slots	2 or 5, half-size	5 (1 x half-size, 4 x full-size)
HDD	✓	✓
2 x HDD	-	✓
HDD + CF	✓	✓
2 x CF	✓	✓
Integrated drives	CD-ROM CD-RW	CD-ROM, FDD CD-RW, FDD DVD-ROM, FDD FDD
Power supply	100 - 240 VAC 24 VDC	100-240 VAC 24 VDC

Typical topologies

Industrial PC for centralized control and visualization

The controller program runs on an industrial PC. The visualization project is integrated with Visual Components. A display unit is connected to the PC. The PC is networked over Ethernet TCP/IP; additional Power Panel-based operator terminals can be also connected via Ethernet. Communication to I/O systems with axes is handled via fieldbus systems (CAN, ETHERNET Powerlink).

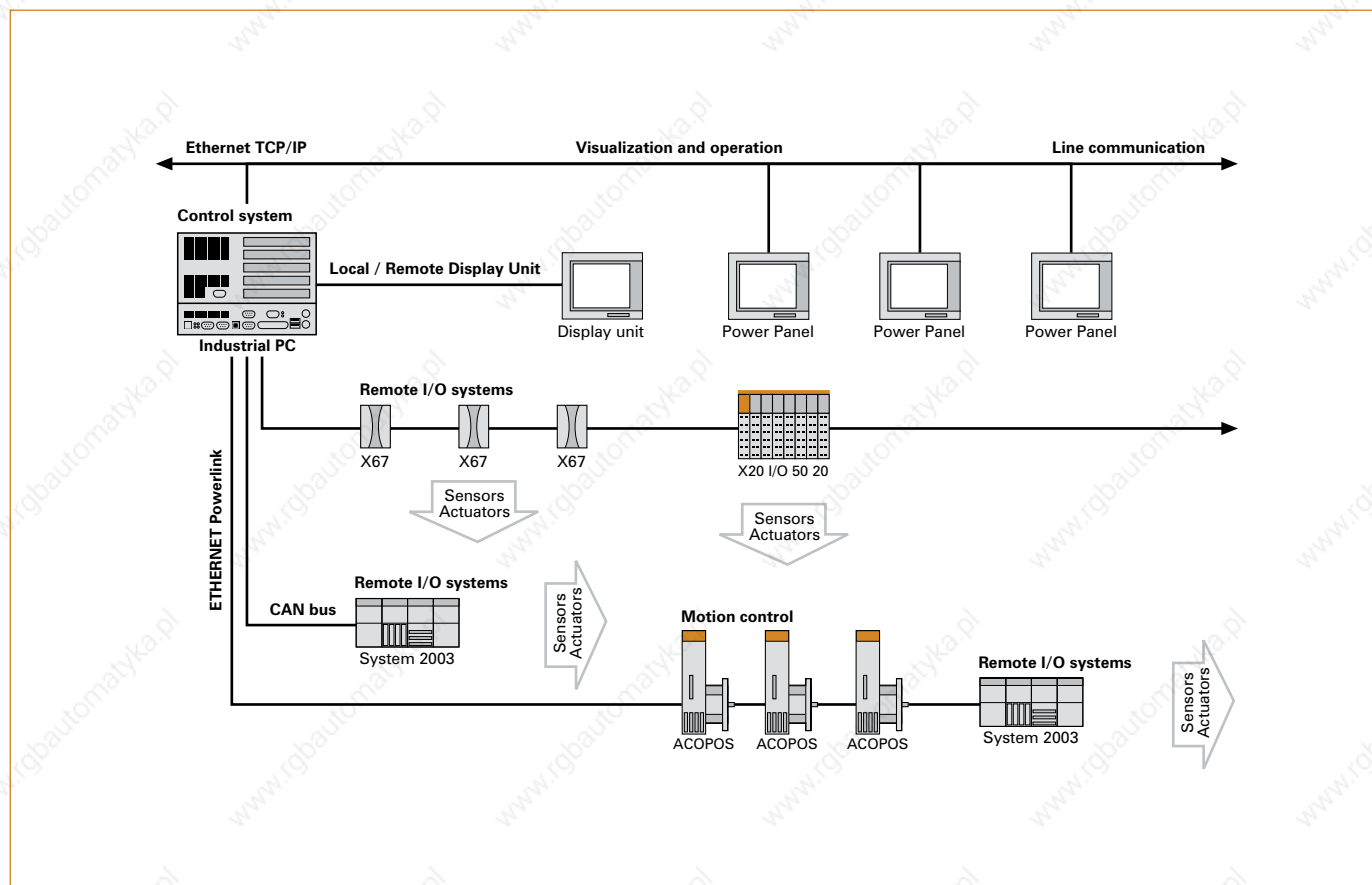

Control system	IPC5000/5600: Compact industrial PCs
Visualization and operation	Power Panel: Integrated control, operation, and visualization
Motion control	ACOPOS: Intelligent servo drives
Distributed I/O systems	X20 System X67 System: Remote I/O with IP67 protection System 2003: Compact controllers, remote I/O

The PC as a visualization device

The visualization application runs on the 5000/5600 industrial PC as a SCADA application. The control tasks interact with one or more underlying PLC stations where I/O systems and drives are connected locally or remotely over fieldbus systems. Additional SCADA stations can be networked via Ethernet TCP/IP.

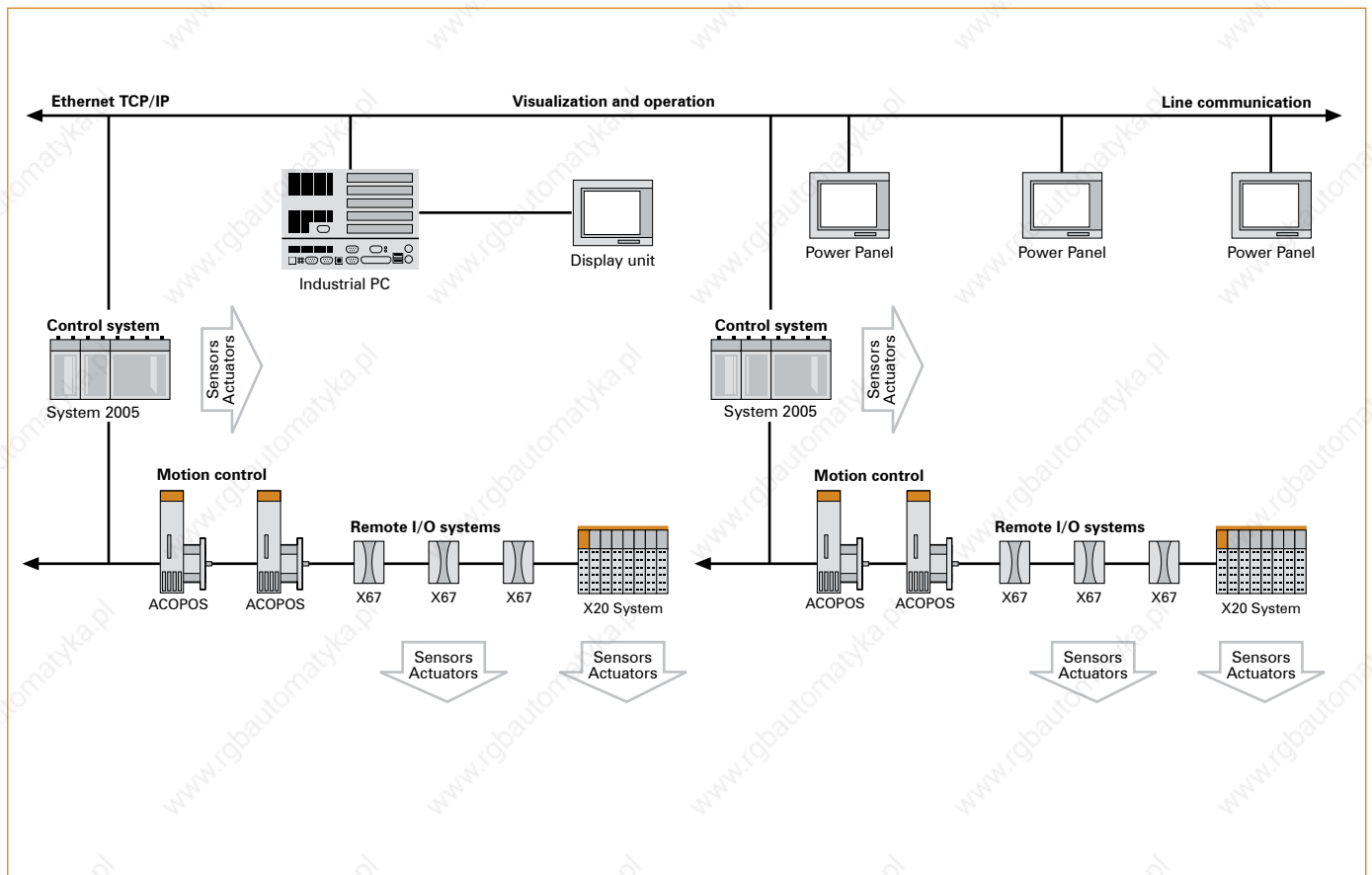

Control system	System 2005: Embedded PC-based automation IPC5000/5600: Compact industrial PCs
Visualization and operation	Power Panel: Integrated control, operation, and visualization IPC5000/5600: Compact industrial PCs
Motion control	ACOPOS: Intelligent servo drives
Distributed I/O systems	X20 System X67 System: Remote I/O with IP67 protection

Typical topologies

Industrial PC as a server

Windows XP Professional or Embedded runs on the industrial PC with real-time expansion for control and drive technology. Automation Runtime AR010 handles the control. Mobile Panel and Power Panel devices operate on Windows CE as thin clients. Communication to the industrial PC occurs via Ethernet TCP/IP and the Remote Desktop Protocol.

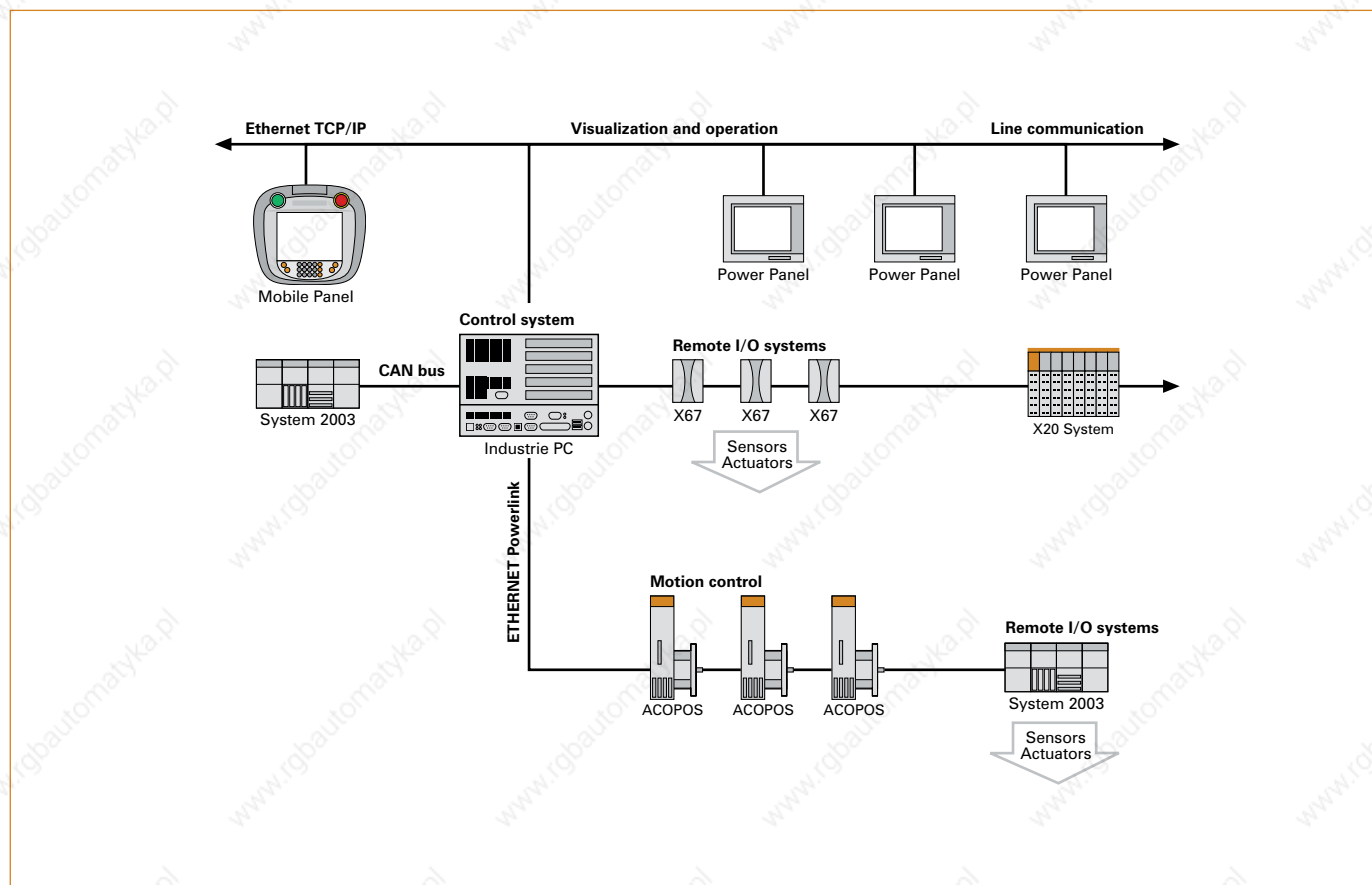

Control system	IPC5000/5600: Compact industrial PCs
Visualization and operation	Power Panel: Integrated control, operation, and visualization Mobile Panel: More than just operation and monitoring
Motion control	ACOPOS: Intelligent servo drives
Distributed I/O systems	X20 System X67 System: Remote I/O with IP67 protection System 2003: Compact controllers, remote I/O



Product overview

Device configuration

IPC5000C

	Model number	Description		Number / Combinations
System unit	5C5001.32	FDD connection	14	Select 1
	5C5001.42	Remote CD-ROM connection	14	
Bus unit	5C5000.21	2 slots, 100-240 VAC	15	Select 1
	5C5000.22	2 slots, 24 VDC	15	
	5C5000.31	5 slots, 100-240 VAC	15	
	5C5000.32	5 slots, 24 VDC	15	
Processor	5C5002.14	Intel Celeron 566 MHz		Select 1
	5C5002.15	Intel Pentium III 600 MHz		
	5C5002.16	Intel Pentium III 850 MHz		
Memory	9A0004.11	64 MB PC100 DIMM module		Select up to 2
	9A0004.12	128 MB PC100 DIMM module		(any combination)
	9A0004.14	256 MB PC100 DIMM module		
Mass memory	5A5001.15	30 GB hard disk		Select 1
	5A5001.16	30 GB hard disk / CompactFlash slot		CompactFlash is also necessary for 5A5002.02 and 5A5002.03.
	5A5002.02	CompactFlash adapter, 2 slots		
	5A5002.03	CompactFlash adapter, 1 slot		
Drives	5A5009.01	CD-ROM drive		Optional, select a maximum of 1
	5A5009.02	CD-RW drive		Note: Combining 5A5001.16 with 5A5002.02 is not possible.
Display units			16	Optional

IPC5600C

	Model number	Description		Number / Combinations
System unit	5C5601.32	FDD connection	14	Required
Bus unit	5C5600.03	5 slots, 115/230 VAC	15	Select 1
	5C5600.04	5 slots, 24 VDC	15	
Processor	5C5002.14	Intel Celeron 566 MHz		Select 1
	5C5002.15	Intel Pentium III 600 MHz		
	5C5002.16	Intel Pentium III 850 MHz		
Memory	9A0004.11	64 MB PC100 DIMM module		Select up to 2
	9A0004.12	128 MB PC100 DIMM module		(any combination)
	9A0004.14	256 MB PC100 DIMM module		
Mass memory	5A5001.15	30 GB hard disk		Select up to 2
	5A5002.03	CompactFlash adapter, 1 slot		CompactFlash is also necessary for 5A5002.02 and 5A5002.03.
Drives	5A5600.01	FDD drive		Optional, select a maximum of 1
	5A5600.02	FDD/CD-ROM drive		
	5A5600.05	FDD/DVD-ROM drive		
	5A5600.07	FDD/CD-RW drive		
Display units			16	Optional

System units



Model number	Short description	
5C5001.32	Provit 5000 controller system unit For Intel Celeron and Pentium III processors, 4 MB video memory, Intel 82440 BX chipset, 3 DIMM slots, 2 serial interfaces, and 1 parallel interface. Connections for FPD, monitor, PS/2 AT keyboard, PS/2 mouse, USB, external FDD, and Ethernet 10/100 (twisted pair). Without processor.	14
5C5001.42	Provit 5000 controller system unit For Intel Celeron and Pentium III processors, 4 MB video memory, Intel 82440 BX chipset, 3 DIMM slots, 2 serial interfaces, and 1 parallel interface. Connections for FPD, monitor, PS/2 AT keyboard, PS/2 mouse, USB, remote CD-ROM drives, and Ethernet 10/100 (twisted pair). Without processor.	14
5C5601.32	Provit 5600 controller system unit For Intel Celeron and Pentium III processors, 4 MB video memory, Intel 82440 BX chipset, 3 DIMM slots, 2 serial interfaces, and 1 parallel interface. Connections for FPD, monitor, PS/2 AT keyboard, PS/2 mouse, USB, external FDD, and Ethernet 10/100 (twisted pair). Without processor.	14

Bus units



Model number	Short description	
5C5000.21	Provit 5000 controller bus unit, 2 slots (1 BR PCI/ISA, 1 half-size PCI). Ready for add-on CD-ROM drive. Supply voltage 100-240 VAC. For 5C5001.xx system units.	15
5C5000.22	Provit 5000 controller bus unit, 2 slots (1 BR PCI/ISA, 1 half-size PCI). Ready for add-on CD-ROM drive. 24 VDC supply voltage. For 5C5001.xx system units.	15
5C5000.31	Provit 5000 controller bus unit, 5 slots (1 BR ISA, 1 half-size ISA, 1 half-size ISA/PCI, 2 half-size PCI). Prepared for add-on CD-ROM drive. 100 VAC supply voltage. For 5C5001.xx system units.	15
5C5000.32	Provit 5000 controller bus unit, 5 slots (1 BR ISA, 1 half-size ISA, 1 half-size ISA/PCI, 2 half-size PCI). Prepared for add-on CD-ROM drive. 24 VDC supply voltage. For 5C5001.xx system units.	15
5C5600.03	Provit 5600 controller bus unit, 5 slots (1 half-size ISA, 1 full-size ISA, 1 full-size ISA/PCI, 2 full-size PCI). 115/230 VAC supply voltage. For 5C5601.xx system units.	15
5C5600.04	Provit 5600 controller bus unit, 5 slots (1 half-size ISA, 1 full-size ISA, 1 full-size ISA/PCI, 2 full-size PCI). 24 VDC supply voltage. For 5C5601.xx system units.	15

Product overview

Processors

Model number	Short description
5C5002.14	Intel Celeron 566 MHz processor 128 KB L2 cache, 66 MHz front side bus For 5C5001.1x, 5C5601.1x, 5C5001.2x, 5C5601.2x, 5C5001.3x, 5C5601.3x und 5C5001.4x system units; incl. heat sink and fans.
5C5002.15	Intel Pentium III 600 MHz processor 256 KB L2 cache, 100 MHz front side bus For 5C5001.1x, 5C5601.1x, 5C5001.2x, 5C5601.2x, 5C5001.3x, 5C5601.3x und 5C5001.4x system units; incl. heat sink and fans.
5C5002.16	Intel Pentium III 850 MHz processor 256 KB L2 cache, 100 MHz front side bus For 5C5001.1x, 5C5601.1x, 5C5001.2x, 5C5601.2x, 5C5001.3x, 5C5601.3x und 5C5001.4x system units; incl. heat sink and fans.

Memory

Model number	Short description
9A0004.11	DIMM module, 64 MB PC100 CL2
9A0004.12	DIMM module, 128 MB PC100 CL2
9A0004.14	DIMM module, 256 MB PC100 CL2

Mass memory

Model number	Short description
5A5001.15	30 GB Fujitsu hard disk (fixed)
5A5001.16	30 GB hard disk (fixed) / CompactFlash slot
5A5002.02	Dual silicon disk adapter for CompactFlash with 2 slots for operating CompactFlash with the IPC5000C, IPC5600C
5A5002.03	Silicon disk adapter for CompactFlash with 1 slot for operating CompactFlash with the IPC5000C, IPC5600C

Provit 10.4" display units



Model number	Short description	
5D5210.01	Provit 5000 display unit, 10.4" VGA TFT color display with touch screen (resistive), IP65 protection (front side).	16
5D5211.02	Provit 5000 display unit, 10.4" SVGA TFT color display with touch screen (resistive), IP65 protection (front side).	16
5D5510.10	Provit 5000 display unit, 10.4" VGA TFT color display, 23 function and 20 system keys, IP65 protection (front side).	17
5D5600.01	Provit 5600 display unit, 10.4" VGA TFT color display, 52 function and 26 system keys, PS/2 keyboard interface, IP65 protection (front side).	18
5D5600.02	Provit 5600 display unit, 10.4" VGA TFT color display with touchpad (resistive), 52 function and 26 system keys, PS/2 keyboard interface, IP65 protection (front side).	18
5D5600.03	Provit 5600 display unit, 10.4" VGA TFT color display with touchpad (resistive), 52 function and 26 system keys, PS/2 keyboard interface, IP65 protection (front side).	18

Provit 12.1" display units



Model number	Short description	
5D5211.03	Provit 5000 display unit, 12.1" SVGA TFT color display with touch screen (resistive), IP65 protection (front side).	19
5D5601.01	Provit 5600 display unit, 12.1" SVGA TFT color display, 52 function and 26 system keys, PS/2 keyboard interface, IP65 protection (front side).	20
5D5601.02	Provit 5600 display unit, 12.1" VGA TFT color display with touchpad (resistive), 52 function and 26 system keys, PS/2 keyboard interface, IP65 protection (front side).	20
5D5601.03	Provit 5600 display unit, 12.1" VGA TFT color display with touch screen (resistive), 52 function and 26 system keys, PS/2 keyboard interface, IP65 protection (front side).	20

Provit 15" display units



Model number	Short description	
5D5212.02	Provit 5000 display unit, 15" XGA TFT color display with touch screen (resistive), IP65 protection (front side).	21
5D5212.04	Provit 5000 IP65 display unit, 15" XGA TFT color display with touch screen (resistive), IP65 protection (front side). 420 x 330 mm (W x H).	22

System units

The system unit is the central component of the IPC5000C/IPC5600C.

It contains a chipset, socket for the processor and RAM as well as interfaces (serial, display, etc.).



Mainboard	5C5001.32	5C5001.42	5C5601.32
General information	Real-time clock, CMOS backup in the FlashPROM, temperature monitoring (CPU, I/O, display unit)		
BIOS	AWARD Elite BIOS, Plug and Play compatible	AWARD Elite BIOS, Plug and Play compatible	AWARD Elite BIOS, Plug and Play compatible
Processor socket	Socket 370	Socket 370	Socket 370
DRAM socket	2 x DIMM PC100, max. 512 MB	2 x DIMM PC100, max. 512 MB	2 x DIMM PC100, max. 512 MB
Slots (hard disk/CF adapter)	1	1	2
Interfaces	5C5001.32	5C5001.42	5C5601.32
COM1 / COM2	Serial RS232, 115 kBit/s, not electrically isolated, 9-pin DSUB plug		
LPT1	SPP, EPP, and ECP mode, not electrically isolated, 25-pin DSUB socket		
USB	2 x USB 1.1 ports, connection type A	2 x USB 1.1 ports, connection type A	2 x USB 1.1 ports, connection type A
Keyboard	Enhanced AT PS/2	Enhanced AT PS/2	Enhanced AT PS/2
Mouse	PS/2	PS/2	PS/2
CRT	15-pin DSUB socket	15-pin DSUB socket	15-pin DSUB socket
Display (Panellink)	9-pin DSUB socket	9-pin DSUB socket	9-pin DSUB socket
Ethernet	1 x 10BaseT / 100BaseT	1 x 10BaseT / 100Base T	1 x 10BaseT / 100Base T
External disk drive	Yes	No	Yes
Remote IDE	No	Yes	No
Graphics	5C5001.32	5C5001.42	5C5601.32
VGA controller	ATI Rage Mobility M	ATI Rage Mobility M	ATI Rage Mobility M
Graphics memory	4 MB	4 MB	4 MB

Optional accessories	
5A2001.01	External 3.5" floppy disk drive, beige front
5A2001.02	Transparent door for external floppy disk drive 5A2001.01 and 5A2001.05, with lock, sealed with gasket, IP55 protection (front side)
5A2001.05	External 3.5" floppy disk drive, black front
5A5003.03	Front cover for remote CD-ROM drive 5A5003.07
5A5003.07	Remote CD-ROM, incl. mounting bracket, no front cover, for connecting to 5C5001.2x and 5C5601.2x system units, dimensions 156 x 52 x 164 mm (W x H x D)
5A5009.01	Provit 5000 controller CD-ROM, for 5C5000.2x and 5C5000.3x bus units
5A5009.02	Provit 5000 controller CD-RW, for 5C5000.2x and 5C5000.3x bus units
5A5600.01	Provit 5600 controller FDD, for 5C5601.xx system units
5A5600.02	Provit 5600 controller FDD and CD-ROM, for 5C5601.xx system units
5A5600.05	Provit 5600 controller FDD and DVD-ROM, for 5C5601.xx system units
5A5600.07	Provit 5600 controller FDD and CD-RW, for 5C5601.xx system units
5A5603.01	Fan filters for 5C5600.0x, 10 pieces
	AT keyboard (19")
	Operating systems
	CompactFlash cards

Bus units added to the system units complete the housing. They contain PCI and ISA slots as well as the power supply.



Slots	5C5000.21	5C5000.22	5C5000.31	5C5000.32	5C5600.03	5C5600.04
Total	2	2	5	5	5	5
B&R ISA 16-bit ¹⁾	1	1	1	1	-	-
Half-size ISA 16-bit	-	-	1	1	1	1
Half-size ISA 16-bit / PCI 32-bit	1	1	1	1	-	-
Half-size PCI 32-bit	-	-	2	2	-	-
Full-size ISA 16-bit	-	-	-	-	1	1
Full-size ISA 16-bit / PCI 32-bit	-	-	-	-	1	1
Full-size PCI 32-bit	-	-	-	-	2	2

1) Standard 16-bit ISA interface, but with specific mechanical properties

Supply voltage	5C5000.21	5C5000.22	5C5000.31	5C5000.32	5C5600.03	5C5600.04
Input voltage	100 - 240 VAC	24 VDC	100 - 240 VAC	24 VDC	100 - 240 VAC	24 VDC
	50 - 60 Hz		50 - 60 Hz		50 - 60 Hz	

Fans	5C5000.21	5C5000.22	5C5000.31	5C5000.32	5C5600.03	5C5600.04
Type / Design	Ball bearings, analog control		Ball bearings, analog control		Ball bearings, analog control	
Number						
ø 40 mm	2	2	1	1	-	-
ø 50 mm	-	-	2	1	-	-
ø 80 mm	-	-	-	-	1	1

Optional accessories

9A0001.03 Power cable for IPC5000 / 5600, length 2 m, with standard German plug

Provit 5000 10.4" display units with touch screen



Display	5D5210.01	5D5211.02
Type	TFT color	TFT color
Colors	262,144	262,144
Resolution	VGA, 640 x 480 pixels	SVGA, 800 x 600 pixels
Diagonal	10.4"	10.4"
Brightness	200 cd/m ²	280 cd/m ²
Half-brightness time	50,000 h	55,000 h
Touch screen	Analog resistive	Analog resistive
Interfaces	5D5210.01	5D5211.02
Display	Panellink (IPC5000C/IPC5600C)	Panellink (IPC5000C/IPC5600C)
Touch	RS232	RS232
Distance	Max. 10 m	Max. 10 m
1) Only remote operation is possible with the IPC5600C due to its mechanical dimensions.		
Environmental conditions	5D5210.01	5D5211.02
Temperature		
Operation	0 to 50°C	0 to 50°C
Storage	-20 to +60°C	-20 to +60°C
Relative humidity		
Operation	5 - 85%, non-condensing	5 - 85%, non-condensing
Storage	T ≤ 40°C: 5% to 90%, non-condensing T > 40°C: < 90%, non-condensing	T ≤ 40°C: 5% to 90%, non-condensing T > 40°C: < 90%, non-condensing
Mechanics	5D5210.01	5D5211.02
Protection type	IP65 (front side) IP20 (back side)	IP65 (front side) IP20 (back side)
Outer dimensions (W x H x D (mm))	310 x 236 x 45	310 x 236 x 45
Weight	Approx. 2 kg	Approx. 2.4 kg

Optional accessories ¹⁾	
5A5004.05	Remote CD-ROM / display cable, length 5 m, for Provit 5000/5600.
5A5004.06	Remote panel cable 5 m, 1 x 70°, for Provit 5000/5600, with angled plug.
5A5004.10	Remote CD-ROM / display cable, length 10 m, for Provit 5000/5600.
5A5004.11	Remote panel cable 10 m, 1 x 70°, for Provit 5000/5600, with angled plug.
9A0014.05	RS232 extension cable for remote operation of a display unit with touch screen, length 5 m.
9A0014.10	RS232 extension cable for remote operation of a display unit with touch screen, length 10 m.

1) Attachment cable (30 cm) for the display and touch screen are included with the delivery of display units.



Display	5D5510.10
Type	TFT color
Colors	262,144
Resolution	VGA, 640 x 480 pixels
Diagonal	10.4"
Brightness	200 cd/m ²
Half-brightness time	50,000 h
Keys	5D5510.10
Function keys	23, with LEDs
System keys	20
Interfaces	5D5510.10
Display	Panellink (IPC5000C/IPC5600C) ¹⁾
Distance	Max. 10 m
1) Only remote operation is possible with the IPC5600C due to its mechanical dimensions.	
Environmental conditions	5D5510.10
Temperature	
Operation	0 to 50°C
Storage	-20 to +60°C
Relative humidity	
Operation	5 - 85%, non-condensing
Storage	T ≤ 40°C: 5% to 90%, non-condensing T > 40°C: < 90%, non-condensing
Mechanics	5D5510.10
Protection type	
IP65 (front side)	
IP20 (back side)	
Outer dimensions (W x H x D [mm])	310 x 387 x 38
Weight	Approx. 3.7 kg

Optional accessories ¹⁾	
5A5004.05	Remote CD-ROM / display cable, length 5 m, for Provit 5000/5600.
5A5004.06	Remote panel cable 5 m, 1 x 70°, for Provit 5000/5600, with angled plug.
5A5004.10	Remote CD-ROM / display cable, length 10 m, for Provit 5000/5600.
5A5004.11	Remote panel cable 10 m, 1 x 70°, for Provit 5000/5600, with angled plug.
5A2500.09	A4 slide-in legend strip template for display units 5D2510.10, 5D2510.22, and 5D5510.10, 1 sheet, with CorelDraw template.

1) Attachment cable (40 cm) for the display and touch screen are included with the delivery of display units.

Provit 5600 10.4" display units



Display	5D5600.01	5D5600.02	5D5600.03
Type	TFT color	TFT color	TFT color
Colors	262,144	262,144	262,144
Resolution	VGA, 640 x 480 pixels	VGA, 640 x 480 pixels	VGA, 640 x 480 pixels
Diagonal	10.4"	10.4"	10.4"
Brightness	200 cd/m ²	200 cd/m ²	200 cd/m ²
Half-brightness time	50,000 h	50,000 h	50,000 h
Touch	-	Touchpad	Analog resistive touch screen
Keys	5D5600.01	5D5600.02	5D5600.03
Function keys	46, with LEDs	46, with LEDs	46, with LEDs
System keys	Number pad, cursor pad, 6 Windows system keys		
Interfaces	5D5600.01	5D5600.02	5D5600.03
Display	Panellink (IPC5000C/IPC5600C)	Panellink (IPC5000C/IPC5600C)	Panellink (IPC5000C/IPC5600C)
Touchpad / touch screen	-	RS232	RS232
Distance	Max. 10 m	Max. 10 m	Max. 10 m
Other	5D5600.01	5D5600.02	5D5600.03
Reset button	Accessible behind front cover		
AT keyboard (PS/2)	Socket accessible behind front cover		
FDD panel	Optional, accessible behind front cover (maximum distance 1.8 m)		
IPC5600C integrated drive	Accessible behind front cover if the display unit and PC are mounted together		
Environmental conditions	5D5600.01	5D5600.02	5D5600.03
Operational temperature	0 to 50°C		
Storage temperature	-20 to +60°C		
Relative humidity - operation	5 - 85%, non-condensing		
Relative humidity - storage	T ≤ 40°C: 5% to 90%, non-condensing, T > 40°C: < 90%, non-condensing		
Mechanics	5D5600.01	5D5600.02	5D5600.03
Protection type	IP65 (front side), IP20 (back side)		
Outer dimensions (W x H x D (mm))	482 x 310 x 31 (19 inch x 7 HU)	482 x 310 x 31 (19 inch x 7 HU)	482 x 310 x 31 (19 inch x 7 HU)
Weight	Approx. 4.5 kg	Approx. 4.5 kg	Approx. 4.5 kg

Optional accessories ¹⁾

5A5004.05	Remote CD-ROM / display cable, length 5 m, for Provit 5000/5600.	
5A5004.06	Remote panel cable 5 m, 1 x 70°, for Provit 5000/5600, with angled plug.	
5A5004.10	Remote CD-ROM / display cable, length 10 m, for Provit 5000/5600.	
5A5004.11	Remote panel cable 10 m, 1 x 70°, for Provit 5000/5600, with angled plug.	
5A5600.03	Provit 5600 FDD panel, for display units 5D5600.xx.	
5A5602.01	A4 slide-in 10.4" legend strip template for 5D5600.0x display units, 1 sheet, with CorelDraw template.	29
9A0014.05	RS232 extension cable for remote operation of a display unit with touch screen, length 5 m.	
9A0014.10	RS232 extension cable for remote operation of a display unit with touch screen, length 10 m.	

1) Attachment cable (40 cm) for the display and touch screen are included with the delivery of display units.

Provit 5000 12.1" display unit with touch screen



Display	5D5211.03
Type	TFT color
Colors	262,144
Resolution	SVGA, 800 x 600 pixels
Diagonal	12.1"
Brightness	300 cd/m ²
Half-brightness time	50,000 h
Touch screen	Analog resistive
Interfaces	5D5211.03
Display	Panellink (IPC5000C/IPC5600C)
Touch	RS232
Distance	Max. 10 m
1) Only remote operation is possible with the IPC5600 due to its mechanical dimensions.	
Environmental conditions	5D5211.03
Temperature	
Operation	0 to 50°C
Storage	-20 to +60°C
Relative humidity	
Operation	5 - 85%, non-condensing
Storage	T ≤ 40°C: 5% to 90%, non-condensing T > 40°C: < 90%, non-condensing
Mechanics	5D5211.03
Protection type	IP65 (front side) IP20 (back side)
Outer dimensions (W x H x D [mm])	379 x 300 x 50
Weight	Approx. 4.1 kg

Optional accessories ¹⁾	
5A5004.05	Remote CD-ROM / display cable, length 5 m, for Provit 5000/5600.
5A5004.06	Remote panel cable 5 m, 1 x 70°, for Provit 5000/5600, with angled plug.
5A5004.10	Remote CD-ROM / display cable, length 10 m, for Provit 5000/5600.
5A5004.11	Remote panel cable 10 m, 1 x 70°, for Provit 5000/5600, with angled plug.
9A0014.05	RS232 extension cable for remote operation of a display unit with touch screen, length 5 m.
9A0014.10	RS232 extension cable for remote operation of a display unit with touch screen, length 10 m.

1) Attachment cable (40 cm) for the display and touch screen are included with the delivery of display units.

Provit 5600 12.1" display units



Display	5D5601.01	5D5601.02	5D5601.03
Type	TFT color	TFT color	TFT color
Colors	262,144	262,144	262,144
Resolution	SVGA, 800 x 600 pixels	SVGA, 800 x 600 pixels	SVGA, 800 x 600 pixels
Diagonal	12.1"	12.1"	12.1"
Brightness	300 cd/m ²	300 cd/m ²	300 cd/m ²
Half-brightness time	50,000 h	50,000 h	50,000 h
Touch	-	Touchpad	Analog resistive touch screen
Keys	5D5600.01	5D5600.02	5D5600.03
Function keys	46, with LEDs	46, with LEDs	46, with LEDs
System keys	Number pad, cursor pad, 6 Windows system keys		
Interfaces	5D5600.01	5D5600.02	5D5600.03
Display	Panellink (IPC5000C/IPC5600C)		
Touchpad / touch screen	-	RS232	RS232
Distance	Max. 10 m	Max. 10 m	Max. 10 m
Other	5D5600.01	5D5600.02	5D5600.03
Reset button	Accessible behind front cover		
AT keyboard (PS/2)	Socket accessible behind front cover		
FDD panel	Optional, accessible behind front cover (maximum distance 1.8 m)		
IPC5600C integrated drive	Accessible behind front cover if the display unit and PC are mounted together		
Environmental conditions	5D5601.01	5D5601.02	5D5601.03
Operational temperature	0 to 50°C		
Storage temperature	-20 to +60°C		
Relative humidity - operation	5 - 85%, non-condensing		
Relative humidity - storage	T ≤ 40°C: 5% to 90%, non-condensing, T > 40°C: < 90%, non-condensing		
Mechanics	5D5601.01	5D5601.02	5D5601.03
Protection type	IP65 (front side) IP20 (back side)	IP65 (front side) IP20 (back side)	IP65 (front side) IP20 (back side)
Outer dimensions (W x H x D [mm])	482 x 310 x 31 (19 inch x 7 HU)		
Weight	Approx. 4.5 kg		

Optional accessories ¹⁾

5A5004.05	Remote CD-ROM / display cable, length 5 m, for Provit 5000/5600.
5A5004.06	Remote panel cable 5 m, 1 x 70°, for Provit 5000/5600, with angled plug.
5A5004.10	Remote CD-ROM / display cable, length 10 m, for Provit 5000/5600.
5A5004.11	Remote panel cable 10 m, 1 x 70°, for Provit 5000/5600, with angled plug.
5A5602.02	A4 slide-in 12.1" legend strip template for 5D5601.0x display units, 1 sheet, with CorelDraw template. 29
9A0014.05	RS232 extension cable for remote operation of a display unit with touch screen, length 5 m.
9A0014.10	RS232 extension cable for remote operation of a display unit with touch screen, length 10 m.

1) Attachment cable (40 cm) for the display and touch screen are included with the delivery of display units.

Provit 5000 15" display unit with touch screen



Display	5D5212.02
Type	TFT color
Colors	262,144
Resolution	XGA, 1024 x 768 pixels
Diagonal	15"
Brightness	200 cd/m ²
Half-brightness time	50,000 h
Touch screen	Analog resistive
Interfaces	5D5212.02
Display	Panellink (IPC5000C/IPC5600C)
Touch	RS232
Distance	Max. 10 m
1) Mounting on IPC5600 only possible using a separate cable set (model no. 5A5601.02)	
Environmental conditions	5D5212.02
Temperature	
Operation	0 to 50°C, depending on installation
Storage	-20 to +60°C
Relative humidity	
Operation	5 - 85%, non-condensing
Storage	T ≤ 40°C: 5% to 90%, non-condensing T > 40°C: < 90%, non-condensing
Mechanics	5D5212.02
Protection type	IP65 (front side) IP20 (back side)
Outer dimensions (W x H x D [mm])	435 x 330 x 51
Weight	Approx. 5.4 kg

Optional accessories ¹⁾

5A5004.05	Remote CD-ROM / display cable, length 5 m, for Provit 5000/5600.
5A5004.06	Remote panel cable 5 m, 1 x 70°, for Provit 5000/5600, with angled plug.
5A5004.10	Remote CD-ROM / display cable, length 10 m, for Provit 5000/5600.
5A5004.11	Remote panel cable 10 m, 1 x 70°, for Provit 5000/5600, with angled plug.
9A0014.05	RS232 extension cable for remote operation of a display unit with touch screen, length 5 m.
9A0014.10	RS232 extension cable for remote operation of a display unit with touch screen, length 10 m.

1) Attachment cable (40 cm) for the display and touch screen are included with the delivery of display units.

Provit 5000 15" display unit with touch screen



Display	5D5212.04
Type	TFT color
Colors	262,144
Resolution	XGA, 1024 x 768 pixels
Diagonal	15"
Brightness	200 cd/m ²
Half-brightness time	50,000 h
Touch screen	Analog resistive
Interfaces	5D5212.04
Display	Panellink (IPC5000C/IPC5600C)
Touch	RS232
Distance	Max. 10 m
Environmental conditions	5D5212.04
Temperature	
Operation	0 to 50°C, depending on installation
Storage	-20 to +60°C
Relative humidity	
Operation	5 - 85%, non-condensing
Storage	T ≤ 40°C: 5% to 90%, non-condensing T > 40°C: < 90%, non-condensing
Mechanics	5D5212.04
Protection type	IP65 (front side) IP20 (back side)
Outer dimensions (W x H x D [mm])	420 x 330 x 38
Weight	Approx. 5.5 kg

Optional accessories ¹⁾	
5A5004.05	Remote CD-ROM / display cable, length 5 m, for Provit 5000/5600.
5A5004.10	Remote CD-ROM / display cable, length 10 m, for Provit 5000/5600.
5A5007.01	Panel flange adapter type A for display unit 5D5212.04
9A0014.05	RS232 extension cable for remote operation of a display unit with touch screen, length 5 m.
9A0014.10	RS232 extension cable for remote operation of a display unit with touch screen, length 10 m.

1) Attachment cable (40cm) for the display and touch screen are included with the delivery of display units.

General technical data

General technical data	IPC5000C	IPC5600C
Standards / Compliance		
Temperature	IEC 61131-2 / IEC 60068-2-x	IEC 61131-2 / IEC 60068-2-x
Shock / Tests carried out	IEC 61131-2 / IEC 60068-2-27 (except hard disk)	IEC 61131-2 / IEC 60068-2-27 (except hard disk)
Vibration / Tests carried out	IEC 61131-2 / IEC 60068-2-6 (except hard disk)	IEC 61131-2 / IEC 60068-2-6 (except hard disk)
Emission / Tests carried out	EN 50081-2 / EN 55022+A1	EN 50081-2 / EN 55022+A1
Immunity / Tests carried out	IEC 61131-2 / IEC 61000-4-x	IEC 61131-2 / IEC 61000-4-x
Protection type	IP20	IP20
Mounting orientation	Vertical, $\pm 45^\circ$	Vertical, $\pm 45^\circ$
Operation		
Temperature	0 to 50°C	0 to 50°C
Relative humidity	5 to 95% (non-condensing)	5 to 95% (non-condensing)
Weight		
2-slot design	Approx. 3.9 kg	Approx. 7.9 kg
5-slot design	Approx. 5 kg	
Measurements (W x H x D [mm])		
2-slot design	270 x 92.4 x 196	
5-slot design	270 x 157.4 x 196	276.9 x 164.9 x 399.2

Dimensions

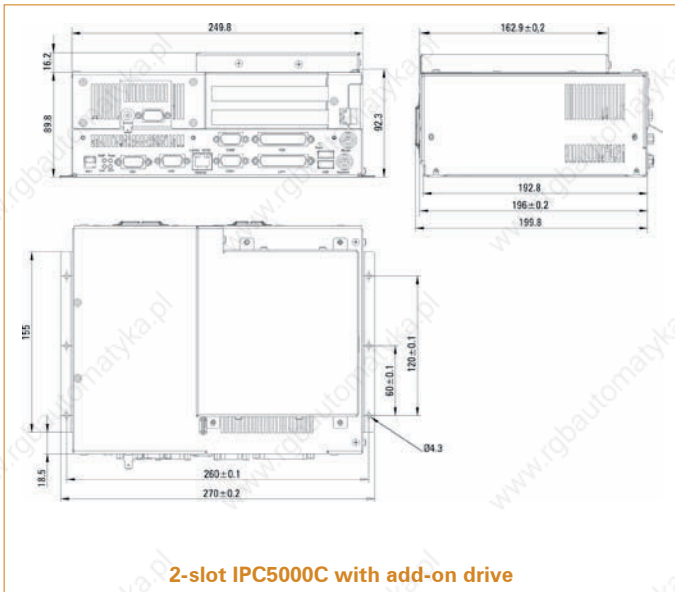

2-slot IPC5000C with add-on drive

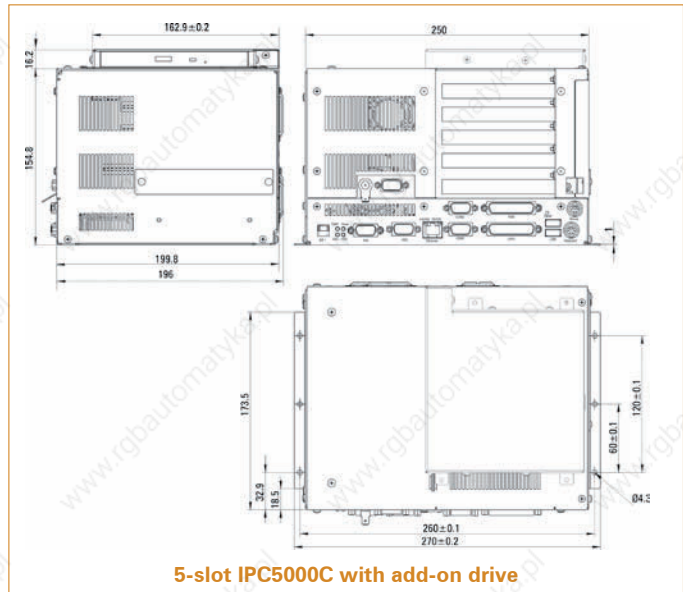

5-slot IPC5000C with add-on drive

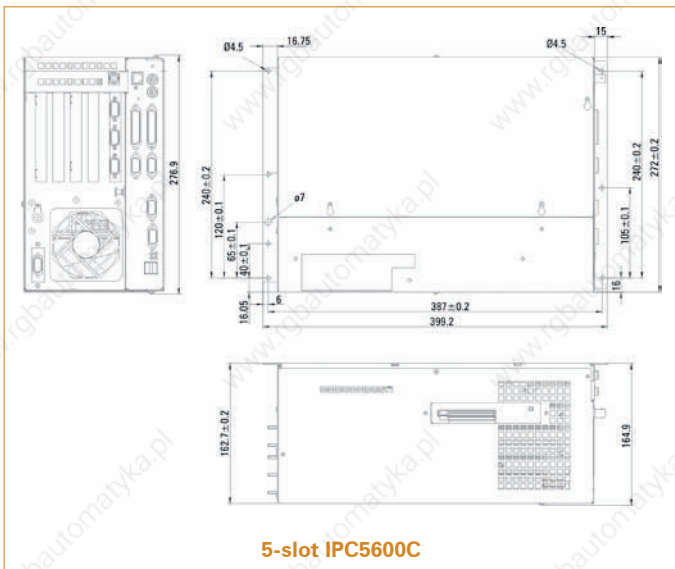

5-slot IPC5600C

All dimensions in mm

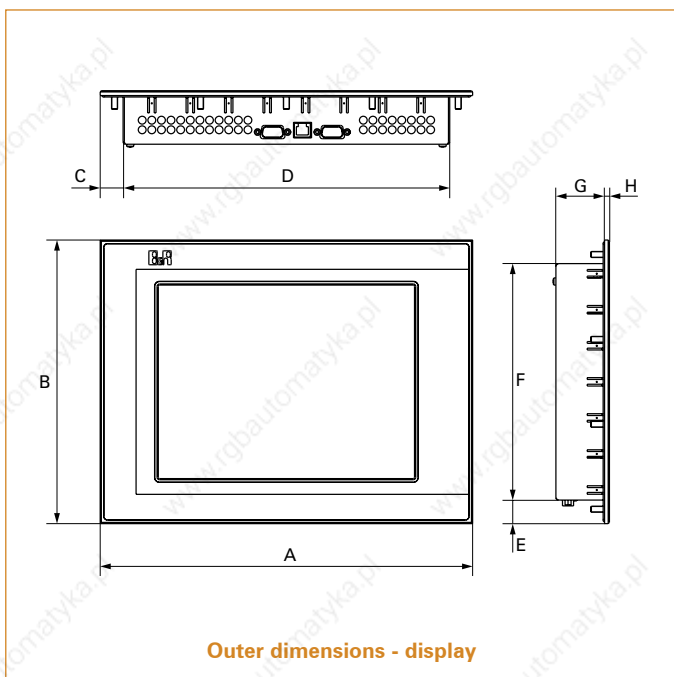

Model number	A	B	C	D	E	F	G	H
5D5210.01	310	236	19.1	271.8	19.6	196.8	41	4
5D5211.02	310	236	19.1	271.8	19.6	196.8	41	4
5D5211.03	379	300	21	337	20.5	259	39.5	5
5D5212.02	435	330	16	403	16	298	39.8	6
5D5510.10	310	387	19.1	271.8	31.3	336.9	40.5	4
5D5600.01	482.6	310.4	28	436.5	16	278	23.3	8
5D5600.02	482.6	310.4	28	436.5	16	278	23.3	8
5D5600.03	482.6	310.4	28	436.5	16	278	23.3	8
5D5601.01	482.6	310.4	28	436.5	16	278	23.3	8
5D5601.02	482.6	310.4	28	436.5	16	278	23.3	8
5D5601.03	482.6	310.4	28	436.5	16	278	23.3	8

All dimensions in mm

Dimensions

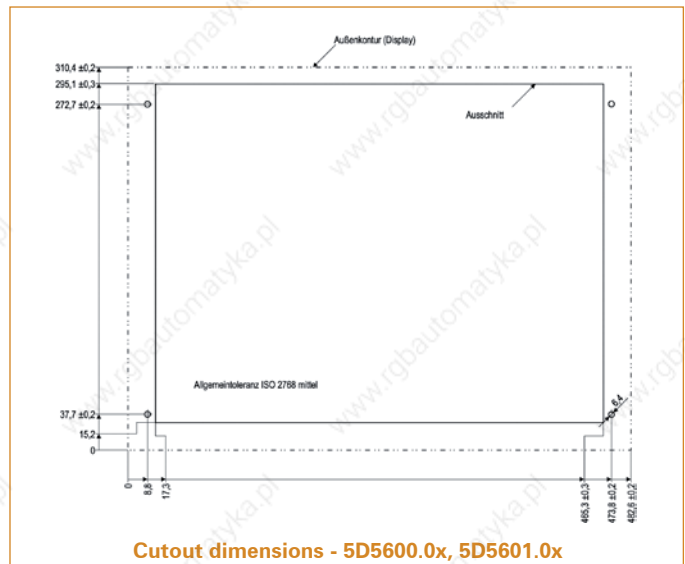
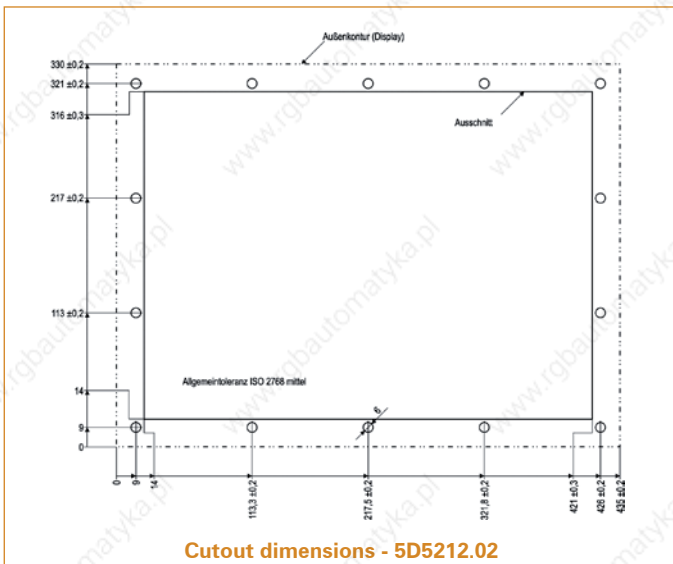
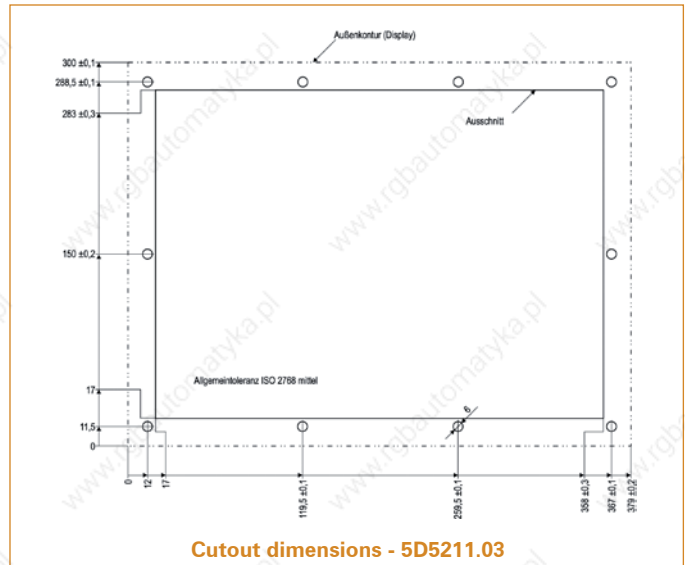
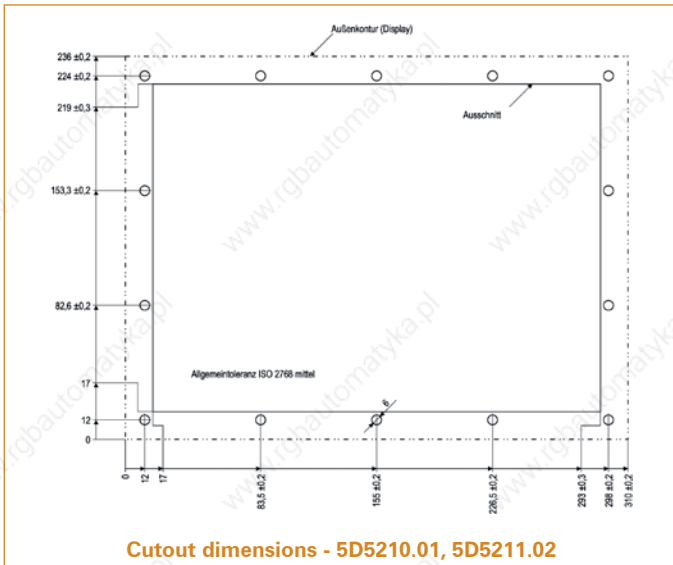

All dimensions in mm

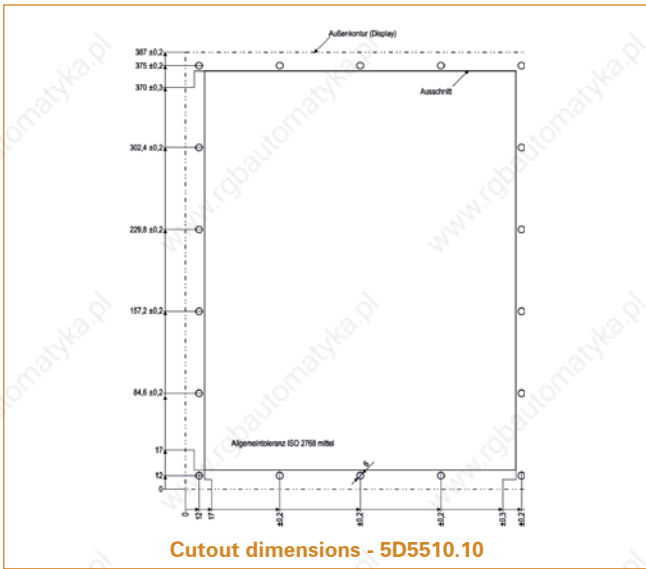

All dimensions in mm

Dimensions

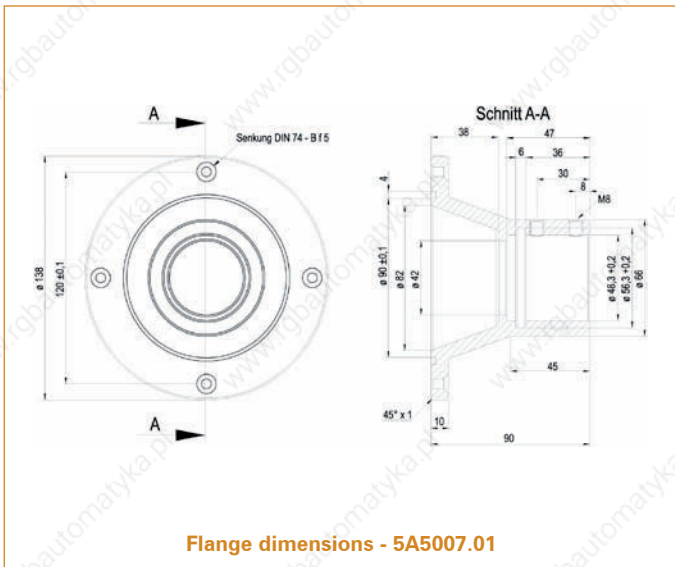
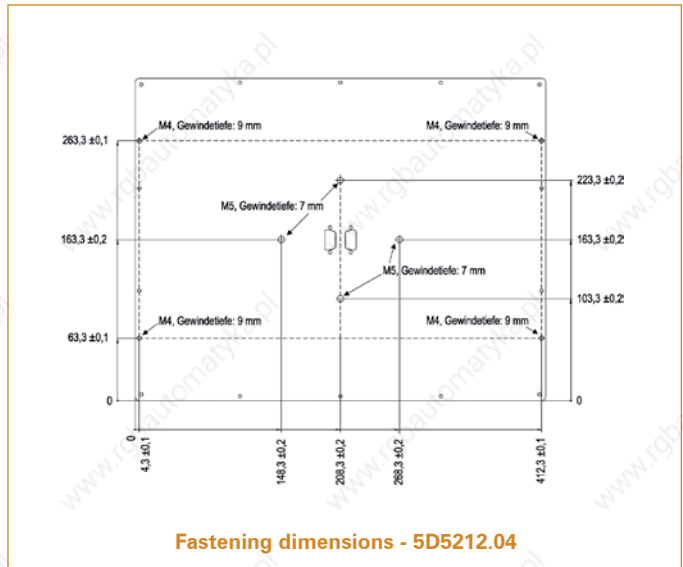
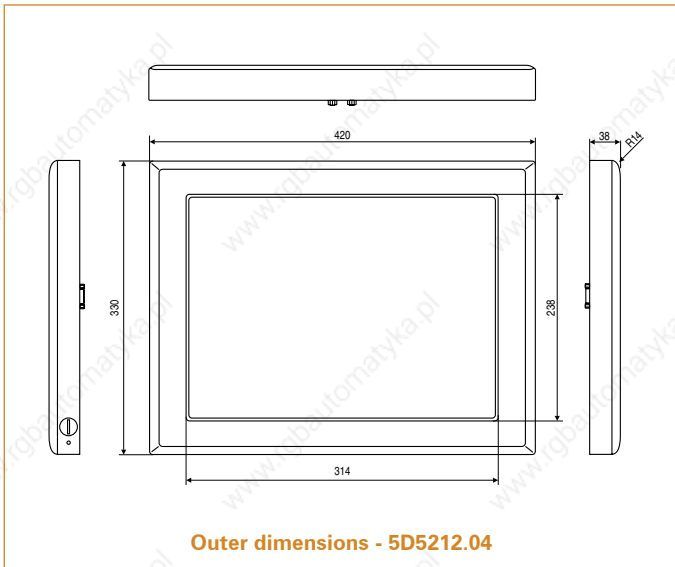

All dimensions in mm

Legend strips

Model number	Short description
5A2500.09	Legend strip template 10.4". For display units 5D2510.10, 5D2510.22 and 5D5510.10. For 2 devices.

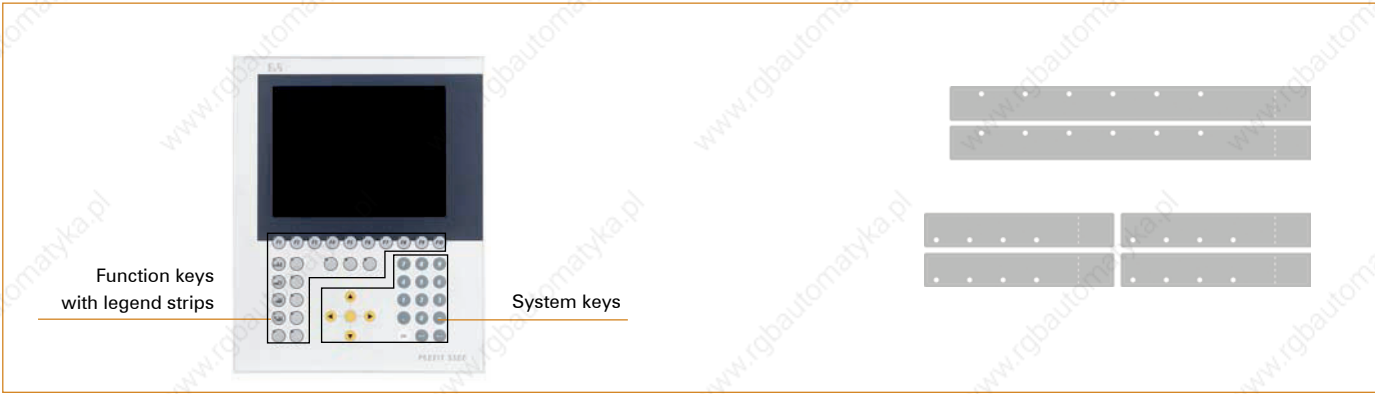

Model number	Short description
5A5602.01	Legend strip template 10.4". For display units 5D5600.01, 5D5600.02 and 5D5600.03. For 1 device.

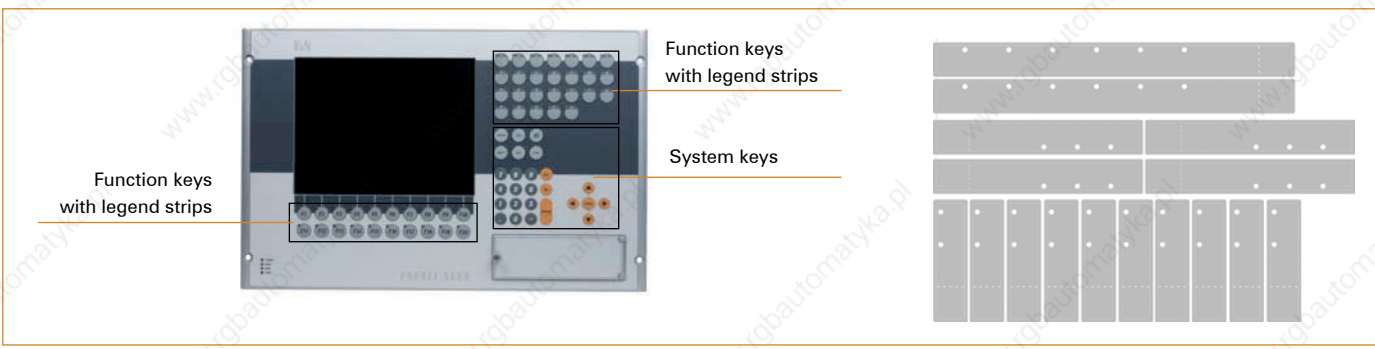

Model number	Short description
5A5602.02	Legend strip template 12.1". For display units 5D5601.01, 5D5601.02 and 5D5601.03. For 1 device.

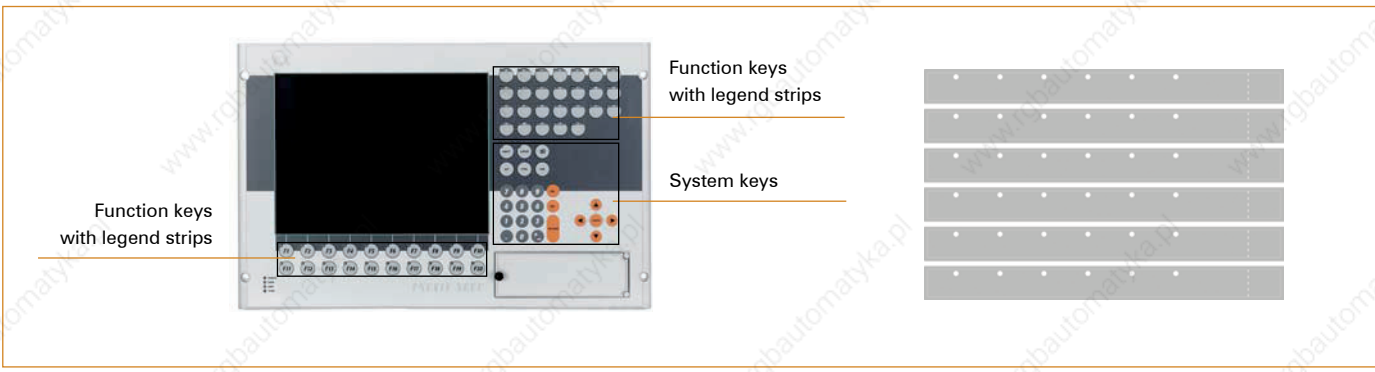

Accessories

Product overview

Terminal blocks



Model number	Short description	
0TB103.8	Connector, 24 VDC, 3-pin male, screw clamps, 3.31 mm ² , protected against vibration by the screw flange	34
0TB103.9	Connector, 24 VDC, 3-pin female, screw clamps, 3.31 mm ² , protected against vibration by the screw flange	34
0TB103.91	Connector, 24 VDC, 3-pin female, cage clamps, 3.31 mm ² , protected against vibration by the screw flange	34
0TB704.9	Terminal block, 4-pin, screw clamps, 1.5 mm ²	35
0TB704.91	Terminal block, 4-pin, cage clamps, 2.5 mm ²	35
0TB2105.9010	Terminal block, 5-pin, screw clamps, 1.5 mm ²	36
0TB2105.9110	Terminal block, 5-pin, cage clamps, 2.5 mm ²	36
0TB708.91	Terminal block, 8-pin, cage clamps, 1.5 mm ²	37
0TB710.91	Terminal block, 10-pin, cage clamps, 1.5 mm ²	38
7TB710.9	Terminal block, 10-pin, screw clamps, 1.5 mm ²	39
7TB710.91	Terminal block, 10-pin, cage clamps, 2.5 mm ²	39
0TB1111.8010	Terminal block, 11-pin, screw clamps, 1.5 mm ² , protected against vibration by the screw flange	40
0TB1111.8110	Terminal block, 11-pin, cage clamps, 1.5 mm ² , protected against vibration by the screw flange	40
7TB712.9	Terminal block, 12-pin, screw clamps, 1.5 mm ²	41
7TB712.91	Terminal block, 12-pin, cage clamps, 1.5 mm ²	41
7TB718.9	Terminal block, 18-pin, screw clamps, 1.5 mm ²	42
7TB718.91	Terminal block, 18-pin, cage clamps, 1.5 mm ²	42

Infrastructure components



Model number	Short description	
0AC808.9	8x industrial hub (Layer 2), 24 VDC, 10/100 MBit/s with auto-sensing, MDIX switch for channel 1	43
0AC401.9	Encoder 5 V - 24 V, converter for 5 V encoders (abs. or incr.)	44
0AC912.9	Bus adapter, CAN, 1 CAN interface	46
0AC913.92	Bus adapter, CAN, 2 CAN interfaces, including 30 cm connection cable (DSUB connector)	46
0AC913.93	Bus adapter, CAN, 2 CAN interfaces, including 30 cm connection cable (TB704)	46
0G1000.00-090	Bus connector, RS485, for Profibus networks	44
7AC911.9	Bus connector, CAN bus	44
ECINT1-1	RS232/RS485 interface converter, electrically isolated, for coupling RS232 interface modules to an RS485 twisted pair bus, without lightning protection	45
ECINT1-11	RS232/RS485 interface converter, electrically isolated, for coupling RS232 interface modules to an RS485 twisted pair bus, with lightning protection	45

CompactFlash



Model number	Short description
5CFCRD.0064-03	CompactFlash 64 MB ATA/IDE SiliconSystems
5CFCRD.0128-03	CompactFlash 128 MB ATA/IDE SiliconSystems
5CFCRD.0256-03	CompactFlash 256 MB ATA/IDE SiliconSystems
5CFCRD.0512-03	CompactFlash 512 MB ATA/IDE SiliconSystems
5CFCRD.1024-03	CompactFlash 1024 MB ATA/IDE SiliconSystems
5CFCRD.2048-03	CompactFlash 2048 MB ATA/IDE SiliconSystems
5CFCRD.4096-03	CompactFlash 4096 MB ATA/IDE SiliconSystems
5CFCRD.8192-03	CompactFlash 8192 MB ATA/IDE SiliconSystems

PC cards



Model number	Short description
0MC111.9	PC card, 2 MB FlashPROM
0MC112.9	PC card, 4 MB FlashPROM
0MC211.9	PC card, 2 MB SRAM
9A0015.99	CompactFlash adapter; for operating CompactFlash in a PC card slot

USB accessories



Model number	Short description	
5MD900.USB2-01	USB 2.0 drive combination, consists of DVD-ROM/CD-RW, FDD, Compact Flash slot (type II), USB connection (type A front, type B back); 24 VDC; (screw clamp 0TB103.9 or cage clamp 0TB103.91)	47
5A5003.03	Front cover for USB drive combination 5MD900.USB2-01	
5CAUSB.0018-00	USB 2.0 cable type A-B; 1.8 m	
5CAUSB.0050-00	USB 2.0 cable type A-B; 5 m	
5MMUSB.0256-00	USB 2.0 flash drive 256 MB	
5MMUSB.0512-00	USB 2.0 flash drive 512 MB	
5MMUSB.1024-00	USB 2.0 flash drive 1024 MB	

Accessories

Product overview

Cable

Model number	Short description	
0G0001.00-090	Cable PC <-> PLC/PW, RS232, online cable	
0G0010.00-090	Cable I/O bus expansion, 1 m, bus expansion for System 2005	
0G0012.00-090	Cable I/O bus expansion, 2 m, bus expansion for System 2005	
9A0017.01	Null modem cable RS232, 0.6 m, for connecting UPS and IPC	
9A0017.02	Null modem cable RS232, 1.8 m, for connecting UPS and IPC	
X20CA0E61.0002	EPL connection cable RJ45 to RJ45, 0.2 m	48
X20CA0E61.0010	EPL connection cable RJ45 to RJ45, 1.0 m	48
X20CA0E61.0020	EPL connection cable RJ45 to RJ45, 2.0 m	48
X20CA0E61.0050	EPL connection cable RJ45 to RJ45, 5.0 m	48
X20CA0E61.0100	EPL connection cable RJ45 to RJ45, 10.0 m	48
X20CA0E61.0150	EPL connection cable RJ45 to RJ45, 15.0 m	48
X20CA0E61.0500	EPL connection cable RJ45 to RJ45, 50.0 m	48
X67CA0E41.0050	EPL attachment cable RJ45 to M12, 5.0 m	48
X67CA0E41.0150	EPL attachment cable RJ45 to M12, 15.0 m	48
X67CA0E41.0500	EPL attachment cable RJ45 to M12, 50.0 m	48
X67CA0X99.1000	Cable for custom prefabrication, 100.0 m	

19" AT keyboard



Model number	Short description	
5E9600.01-010	AT keyboard, 19 inch, front mount installation, IP65 from front, German keyboard layout	50
5E9600.01-020	AT keyboard, 19 inch, front mount installation, IP65 from front, US keyboard layout	50

Batteries

Model number	Short description	
0AC200.9	Lithium batteries, 5 pcs., 3 V / 950 mAh, cylindrical battery	
0AC201.9	Lithium batteries, 5 pcs., 3 V / 950 mAh, button cell	
4A0006.00-000	Lithium batteries, 3 V / 950 mAh, button cell	

Other

Model number	Short description	
0AC171.9	Glass tube fuses 5 x 20 mm, 20 pcs., 3.15 A T / 250 V	
0AC301.9	Accessory, 8x shielding clamp	49
5AC900.1100-00	Touch screen pen (5x)	
9A0013.01	Pen for resistive touch screen	

Data sheets for product-specific accessories can be found in the sections for the respective product families.



Terminal blocks

The single-row 3-pin terminal block TB103 is used to connect the supply voltage.



Brief overview	0TB103.8	0TB103.9	0TB103.91
Number of pins	3 (male)	3 (female)	3 (female)
Type of terminal	Screw clamps	Screw clamps	Cage clamps
Distance between contacts	5.08 mm	5.08 mm	5.08 mm
Contact resistance	≤5 mΩ	≤5 mΩ	≤5 mΩ
Rated voltage	300 V	300 V	300 V
Rated current ¹⁾	10 A / contact	10 A / contact	10 A / contact
Connection cross section			
AWG lines	22 - 12 AWG	TBD AWG	26 - 12 AWG
Solid wire lines	0.20 - 2.50 mm ²	0.20 - 2.50 mm ²	0.20 - 2.50 mm ²
Fine wire lines without wire tip sleeves	0.20 - 1.50 mm ²	0.20 - 1.50 mm ²	0.20 - 2.50 mm ²
Fine wire lines with wire tip sleeves	0.20 - 1.50 mm ²	0.20 - 1.50 mm ²	0.20 - 1.50 mm ²
Wire tip sleeves with plastic covering	0.20 - 1.50 mm ²	0.20 - 1.50 mm ²	0.20 - 1.50 mm ²
Cable type	Copper wires only (no aluminum wires!)	Copper wires only (no aluminum wires!)	Copper wires only (no aluminum wires!)
Comment	Protected against vibration by the screw flange Rated values according to UL	Protected against vibration by the screw flange Rated values according to UL	Protected against vibration by the screw flange Rated values according to UL

1) The respective limit data for the I/O modules must be taken into consideration.

Terminal blocks

The single-row 4-pin terminal block TB704 is used as the supply voltage terminal block and the connection terminal for fieldbuses.



Brief overview	0TB704.9	0TB704.91 ¹⁾
Number of pins	4	4
Type of terminal	Screw clamps	Cage clamps
Distance between contacts	5.08 mm	5.08 mm
Contact resistance	≤5 mΩ	≤5 mΩ
Rated voltage	300 V	300 V
Rated current ²⁾	10 A / contact	10 A / contact
Connection cross section		
AWG lines	TBD AWG	26 - 12 AWG
Solid wire lines	0.20 - 2.50 mm ²	0.20 - 2.50 mm ²
Fine wire lines without wire tip sleeves	0.20 - 1.50 mm ²	0.20 - 2.50 mm ²
Fine wire lines with wire tip sleeves	0.20 - 1.50 mm ²	0.20 - 1.50 mm ²
Wire tip sleeves with plastic covering	0.20 - 1.50 mm ²	0.20 - 1.50 mm ²
Cable type	Copper wires only (no aluminum wires!)	Copper wires only (no aluminum wires!)
Comment	Rated values according to UL	Rated values according to UL

1) The terminal block in the cage clamp design cannot be added together.

2) The respective limit data for the I/O modules must be taken into consideration.

Terminal blocks

The single-row 5-pin terminal block TB2105 is also used as a connection terminal for fieldbuses.



Brief overview	0TB2105.9010	0TB2105.9110 ¹⁾
Number of pins	5	5
Type of terminal	Screw clamps	Cage clamps
Distance between contacts	5.08 mm	5.08 mm
Contact resistance	≤5 mΩ	≤5 mΩ
Rated voltage	300 V	300 V
Rated current ²⁾	10 A / contact	10 A / contact
Connection cross section		
AWG lines	TBD AWG	26 - 12 AWG
Solid wire lines	0.20 - 2.50 mm ²	0.20 - 2.50 mm ²
Fine wire lines without wire tip sleeves	0.20 - 1.50 mm ²	0.20 - 2.50 mm ²
Fine wire lines with wire tip sleeves	0.20 - 1.50 mm ²	0.20 - 1.50 mm ²
Wire tip sleeves with plastic covering	0.20 - 1.50 mm ²	0.20 - 1.50 mm ²
Cable type	Copper wires only (no aluminum wires!)	Copper wires only (no aluminum wires!)
Comment	Rated values according to UL	Rated values according to UL

1) The terminal block in the cage clamp design cannot be added together.

2) The respective limit data for the I/O modules must be taken into consideration.

Terminal blocks

The single-row 8-pin terminal block TB708 is used for making connections on various B&R modules.



Brief overview	0TB708.91
Number of pins	8
Type of terminal	Cage clamps
Distance between contacts	3.5 mm
Contact resistance	$\leq 4.2 \text{ m}\Omega$
Rated voltage	300 V
Rated current ¹⁾	10 A / contact
Connection cross section	
AWG lines	26 - 14 AWG
Solid wire lines	0.20 - 1.50 mm ²
Fine wire lines without wire tip sleeves	0.20 - 1.50 mm ²
Fine wire lines with wire tip sleeves	0.20 - 1.50 mm ²
Wire tip sleeves with plastic covering	0.20 - 1.00 mm ²
Cable type	Copper wires only (no aluminum wires!)
Comment	Mechanical removal help Rated values according to UL

1) The respective limit data for the I/O modules must be taken into consideration.

Terminal blocks

The single-row 10-pin terminal block 0TB710 is used for making connections on an XV module.



Brief overview	0TB710.91
Number of pins	10
Type of terminal	Cage clamps
Distance between contacts	3.5 mm
Contact resistance	$\leq 4.2 \text{ m}\Omega$
Rated voltage	300 V
Rated current ¹⁾	10 A / contact
Connection cross section	
AWG lines	26 - 14 AWG
Solid wire lines	0.20 - 1.50 mm ²
Fine wire lines without wire tip sleeves	0.20 - 1.50 mm ²
Fine wire lines with wire tip sleeves	0.20 - 1.50 mm ²
Wire tip sleeves with plastic covering	0.20 - 1.00 mm ²
Cable type	Copper wires only (no aluminum wires!)
Comment	Mechanical removal help Rated values according to UL

1) The respective limit data for the I/O modules must be taken into consideration.

Terminal blocks

The single-row 10-pin terminal block 7TB710 is used to connect I/O modules.



Brief overview	7TB710.9	7TB710.91
Number of pins	10	10
Type of terminal	Screw clamps	Cage clamps
Distance between contacts	5.08 mm	5.08 mm
Contact resistance	≤2 mΩ	≤5 mΩ
Rated voltage	300 V	300 V
Rated current ¹⁾	10 A / contact	10 A / contact
Connection cross section		
AWG lines	24 - 12 AWG	26 - 12 AWG
Solid wire lines	0.20 - 2.50 mm ²	0.20 - 2.50 mm ²
Fine wire lines without wire tip sleeves	0.20 - 2.50 mm ²	0.20 - 2.50 mm ²
Fine wire lines with wire tip sleeves	0.25 - 2.50 mm ²	0.20 - 1.50 mm ²
Wire tip sleeves with plastic covering	0.25 - 2.50 mm ²	0.20 - 1.50 mm ²
Cable type	Copper wires only (no aluminum wires!)	Copper wires only (no aluminum wires!)
Comment	Rated values according to UL	Rated values according to UL

1) The respective limit data for the I/O modules must be taken into consideration.

Terminal blocks

The single-row 11-pin terminal block TB1111 is used for making connections on various B&R modules.



Brief overview	0TB1111.8010	0TB1111.8110
Number of pins	11	11
Type of terminal	Screw clamps	Cage clamps
Distance between contacts	3.5 mm	3.5 mm
Contact resistance	≤4.2 mΩ	≤4.2 mΩ
Rated voltage	300 V	300 V
Rated current ¹⁾	10 A / contact	10 A / contact
Connection cross section		
AWG lines	28 - 14 AWG	26 - 14 AWG
Solid wire lines	0.20 - 1.50 mm ²	0.20 - 1.50 mm ²
Fine wire lines without wire tip sleeves	0.20 - 1.50 mm ²	0.20 - 1.50 mm ²
Fine wire lines with wire tip sleeves	0.20 - 1.50 mm ²	0.20 - 1.50 mm ²
Wire tip sleeves with plastic covering	0.20 - 1.50 mm ²	0.20 - 1.00 mm ²
Cable type	Copper wires only (no aluminum wires!)	Copper wires only (no aluminum wires!)
Comment	Protected against vibration by the screw flange Rated values according to UL	Protected against vibration by the screw flange Rated values according to UL

1) The respective limit data for the I/O modules must be taken into consideration.

Terminal blocks

The single-row 12-pin terminal block TB712 is used for making connections on various I/O modules. Removal is simplified by two ejection levers on the terminal block.



Brief overview	7TB712.9	7TB712.91
Number of pins	12	12
Type of terminal	Screw clamps	Cage clamps
Distance between contacts	3.5 mm	3.5 mm
Contact resistance	≤4.2 mΩ	≤4.2 mΩ
Rated voltage	300 V	300 V
Rated current ¹⁾	10 A / contact	10 A / contact
Connection cross section		
AWG lines	28 - 14 AWG	26 - 14 AWG
Solid wire lines	0.20 - 1.50 mm ²	0.20 - 1.50 mm ²
Fine wire lines without wire tip sleeves	0.20 - 1.50 mm ²	0.20 - 1.50 mm ²
Fine wire lines with wire tip sleeves	0.20 - 1.50 mm ²	0.20 - 1.50 mm ²
Wire tip sleeves with plastic covering	0.20 - 1.50 mm ²	0.20 - 1.00 mm ²
Cable type	Copper wires only (no aluminum wires!)	Copper wires only (no aluminum wires!)
Comment	Mechanical removal help Rated values according to UL	Mechanical removal help Rated values according to UL

1) The respective limit data for the I/O modules must be taken into consideration.

Terminal blocks

The single-row 18-pin terminal block TB718 is used for making connections on various I/O modules. Removal is simplified by two ejection levers on the terminal block.



Brief overview	7TB718.9	7TB718.91
Number of pins	18	18
Type of terminal	Screw clamps	Cage clamps
Distance between contacts	3.5 mm	3.5 mm
Contact resistance	≤4.2 mΩ	≤4.2 mΩ
Rated voltage	300 V	300 V
Rated current ¹⁾	10 A / contact	10 A / contact
Connection cross section		
AWG lines	28 - 14 AWG	26 - 14 AWG
Solid wire lines	0.20 - 1.50 mm ²	0.20 - 1.50 mm ²
Fine wire lines without wire tip sleeves	0.20 - 1.50 mm ²	0.20 - 1.50 mm ²
Fine wire lines with wire tip sleeves	0.20 - 1.50 mm ²	0.20 - 1.50 mm ²
Wire tip sleeves with plastic covering	0.20 - 1.50 mm ²	0.20 - 1.00 mm ²
Cable type	Copper wires only (no aluminum wires!)	Copper wires only (no aluminum wires!)
Comment	Mechanical removal help Rated values according to UL	Mechanical removal help Rated values according to UL

1) The respective limit data for the I/O modules must be taken into consideration.

Ethernet hub AC808



The AC808 Ethernet hub is a standalone device that can be used universally as a Level 2 hub in standard Ethernet or ETHERNET Powerlink networks. It is suitable for both 100 MBit/s (Fast Ethernet) and 10 MBit/s networks. The hub recognizes the transfer speed for the channels automatically.¹⁾

The Ethernet connections are made using RJ45 connectors. The pin assignments can be crossed for the first channel using switches.

The hub can be installed horizontally or vertically on the mounting rail. It also has fastening possibilities on the sides for direct mounting.

Brief overview	0AC808.9
Type	8x industrial hub (Layer 2)
Interface	Ethernet 10/100 Base-T (ANSI/IEEE 802.3)
Cable length	Max. 100 m between two stations (segment length)
Transfer rate	10 or 100 MBit/s; 100 MBit/s used for devices with 10/100 MBit/s auto-negotiation ¹⁾
Port design	Shielded RJ45 ports
Power supply	24 VDC, max. 5.2 W, protection against reverse polarity
General information	0AC808.9
Status indicators	Network activity for each channel, link/collision for each channel, supply voltage
Diagnostics	
Bus function	Yes, with status LED
Hub supply	Yes, with status LED
Certification	CE, C-UL-US, GOST-R
Mechanical characteristics	0AC808.9
Dimensions (W x H x D)	115 x 43 (51 with mounting rail) x 86 mm
Protection type	IP20
Installation	Mounting rail installation and mounting rail adapter included in delivery
Mounting orientation	Vertical or horizontal
Operating temperature	
Horizontal installation	0°C to +60°C
Vertical installation	0°C to +50°C
Storage temperature	-25°C to +70°C
Relative humidity	5 to 95%, non-condensing
Comment	Order 1 x TB704 terminal block separately

¹⁾ Note: If devices that use 10 MBit/s as well as 100 MBit/s are connected, then there is no communication between these devices. Devices with 10/100 MBit/s auto-negotiation are always operated at 100 MBit/s on the hub.

Required accessories

0TB704.9	Accessory, terminal block, 4-pin, screw clamps, 1.5 mm ²	35
0TB704.91	Accessory, terminal block, 4-pin, cage clamps, 2.5 mm ²	35

Level converter Bus connectors



Brief overview	0AC401.9
Power supply	24 VDC
Overvoltage protection	External fuse specified at 10 AT
Input frequency	100 kHz
Power consumption	Typ. 6.0 W @ 24 V, the encoder supply (+5 V) is loaded with 500 mA
General information	0AC401.9
Certification	CE, C-UL-US, GOST-R
Mechanical characteristics	0AC401.9
Dimensions (W x H x D)	77 x 112.5 x 58 mm
Protection type	IP20
Installation	DIN rail installation
Mounting orientation	Horizontal or vertical
Operating temperature	0°C to +55°C
Storage temperature	-20°C to +70°C
Relative humidity	0 - 95%, non-condensing

The RS485 bus connector is used to connect a controller to a Profibus network or an RS485 network. The termination resistor is integrated in the bus connector. The terminating resistor can be turned on or off.



The AC911 bus connector is used to connect a controller to a CAN network. The termination resistor is integrated in the bus connector. The terminating resistor can be turned on or off.

Brief overview	0G1000.00-090	7AC911.9
Interface		
Fieldbus	Profibus DP, RS485 network	-
Type	RS485	CAN
Design	9-pin DSUB plug	9-pin DSUB socket
Connection	For two bus lines using screw clamps	For two bus lines using screw clamps
Terminating resistors	Can be switched on	Can be switched on
Stress relief	Integrated	Integrated
Certification	CE, GOST-R	CE, GOST-R

Interface converters

ECINT1



The INT1 interface converter is used to convert RS232 interface signals to an RS485 signal level. It is used if:

- Data transfer over a long distance is required which cannot be bridged by an RS232 interface. The distance between two stations can be max. 5000 m when using shielded RS485 cables.
- Electrical isolation is required for the interface.
- A PLC is to be connected to a network using an RS232 interface.

The INT1-11 interface converter is equipped with lightning protection.

Brief overview	ECINT1-1	ECINT1-11
Power supply	24 VDC, maximum 4.3 W, protection against reverse polarity	24 VDC, maximum 4.3 W, protection against reverse polarity
Overtoltage protection	Yes	Yes
Maximum baud rate	115.2 kBaud	115.2 kBaud
Cable length		
RS232	Max. 10 m	Max. 10 m
RS485	Max. 5,000 m	Max. 5,000 m
Operating modes	Point-to-point RS422 network RS485 network	Point-to-point RS422 network RS485 network
Terminating resistors	Can be switched on	Can be switched on
Lightning protection	-	Yes
General information	ECINT1-1	ECINT1-11
Status indicators	RS232 signal lines, RS485 active, supply voltage	RS232 signal lines, RS485 active, supply voltage
Diagnostics		
Interface function	Yes, with status LED	Yes, with status LED
Power supply	Yes, with status LED	Yes, with status LED
Certification	CE, GOST-R	CE, GOST-R
Mechanical characteristics	ECINT1-1	ECINT1-11
Dimensions (W x H x D)	100 x 73 x 114 mm	100 x 73 x 114 mm
Protection type	IP20	IP20
Installation	Mounting rail or back wall installation using M5 screws	Mounting rail or back wall installation using M5 screws
Mounting orientation	Any	Any
Operating temperature	0°C to +60°C	0°C to +60°C
Storage temperature	-20°C to +70°C	-20°C to +70°C
Relative humidity	0 - 95%, non-condensing	0 - 95%, non-condensing

Bus adapters CAN 1x, CAN 2x



Brief overview	0AC912.9	0AC913.92	0AC913.93
Bus adapter	CAN 1x	CAN 2x	CAN 2x
Connection to controller	9-pin DSUB socket, connection made by customer	Using 30 cm cable with 9-pin DSUB housing	Using 30 cm cable with 4-pin plug
Networking	Using 9-pin terminal block	Using 9-pin DSUB plug (C1) and 9-pin DSUB socket (C2)	Using 9-pin DSUB plug (C1) and 9-pin DSUB socket (C2)
Terminating resistors	Can be switched on	Can be switched on	Can be switched on
Installation	DIN rail installation	DIN rail installation	DIN rail installation
Mounting orientation	Horizontal or vertical	Horizontal or vertical	Horizontal or vertical
Certification	CE, GOST-R	CE, GOST-R	CE, GOST-R

USB drive combination



General information		5MD900.USB2-01	
Transfer rate	Low speed (1.5 MBit/s), full speed (12 MBit/s), to high speed (480 MBit/s)		
Maximum cable length	5 m (without hub)		
CD/DVD formats	Read	Write	
	CD-ROM	CD-R/RW	
	CD-RW	DVD-R/RW	
	CD-R	DVD-RAM	
	CD-DA	DVD+R/RW	
	Photo CD (single/multi-session)	DVD+R (double layer)	
	Enhanced CD		
	DVD-ROM		
	DVD-R, +R		
	DVD-RW, +RW		
	DVD video		
	DVD RAM (4.7 GB, 2.6 GB)		
CD/DVD speed	CD: 24 x / DVD: 8 x	CD: 24 x / DVD: 8 x	
Floppy disk drive	1.44 MB		
CompactFlash slot	Type II		
Interfaces	USB 2.0: front (type A), back (type B)		
Power supply	24 VDC \pm 25%		
Environmental conditions		5MD900.USB2-01	
Environmental temperature			
Operation	+5°C to +45°C		
Storage	-20°C to +60°C		
Transport	-40°C to +65°C		
Relative humidity			
Operation	8 - 80% (non-condensing)		
Storage	5 - 95% (non-condensing)		
Transport	5 - 95% (non-condensing)		
Mechanical characteristics		5MD900.USB2-01	
Protection type	IP65 front side (only with optional front cover), IP20 back side		
Dimensions (W x H x D)	156 x 52 x 140 mm		

Required accessories

0TB103.9	Connector, 24 VDC, 3-pin female, screw clamps, 3.31 mm ² , protected against vibration by the screw flange	34
0TB103.91	Connector, 24 VDC, 3-pin female, cage clamps, 3.31 mm ² , protected against vibration by the screw flange	34
5A5003.03	Controller R-IDE front cover	
5CAUSB.0018-00	USB 2.0 cable type A-B; 1.8 m	
5CAUSB.0050-00	USB 2.0 cable type A-B; 5 m	
5SWUT1.0000-00	Nero CD-RW OEM software. Only available with a CD-RW drive.	

ETHERNET Powerlink cables

ETHERNET Powerlink cable
RJ45 to RJ45



Length	Connection cable Model number	Short description
0.2 m	X20CA0E61.0002	EPL connection cable RJ45 to RJ45, 0.2 m
1.0 m	X20CA0E61.0010	EPL connection cable RJ45 to RJ45, 1.0 m
2.0 m	X20CA0E61.0020	EPL connection cable RJ45 to RJ45, 2.0 m
5.0 m	X20CA0E61.0050	EPL connection cable RJ45 to RJ45, 5.0 m
10.0 m	X20CA0E61.0100	EPL connection cable RJ45 to RJ45, 10.0 m
15.0 m	X20CA0E61.0150	EPL connection cable RJ45 to RJ45, 15.0 m
50.0 m	X20CA0E61.0500	EPL connection cable RJ45 to RJ45, 50.0 m

ETHERNET Powerlink cable
RJ45 to M12



Length	Connection cable Model number	Short description
5 m	X67CA0E41.0050	EPL attachment cable RJ45 to M12, 5.0 m
15 m	X67CA0E41.0150	EPL attachment cable RJ45 to M12, 15.0 m
50 m	X67CA0E41.0500	EPL attachment cable RJ45 to M12, 50.0 m

For detailed information and support: www.br-automation.com

8 connection shielding clamp AC301



The AC301 8 connection shielding clamp is used for optimal cable shielding for analog signal lines, as well as encoder and counter signals. The cable shields are screwed directly on the shield bracket. The required mounting materials are included in the delivery.

Short description	0AC301.9
Number of cable shield clamps	8
Type of terminal	4 x screw clamps (sets of two)
Dimensions including shield clamps (W x H x D)	76 x 25 x 22 mm

19" AT keyboard



General information	5E9600.01-010	5E9600.01-020
Keyboard format	German	English
Installation	Front mount installation, 19" format	Front mount installation, 19" format
Connection	PS/2 plug	PS/2 plug
Environmental conditions	5E9600.01-010	5E9600.01-020
Environmental temperature		
Operation	0°C to +55°C	0°C to +55°C
Storage / Transport	-20°C to +60°C	-20°C to +60°C
Relative humidity	5 - 95% (non-condensing)	5 - 95% (non-condensing)
Mechanical characteristics	5E9600.01-010	5E9600.01-020
EN 60529 protection	IP65 (front side)	IP65 (front side)
Dimensions (W x H x D)	482.6 x 177 x 35 mm	482.6 x 177 x 35 mm



Index

0

0AC171.9	32
0AC200.9	32
0AC201.9	32
0AC301.9	32
0AC401.9	44
0AC808.9	43
0AC912.9	46
0AC913.92	46
0AC913.93	46
0G0001.00-090	32
0G0010.00-090	32
0G0012.00-090	32
0G1000.00-090	44
0MC111.9	31
0MC112.9	31
0MC211.9	31
0TB103.8	34
0TB103.9	34
0TB103.91	34
0TB1111.8010	40
0TB1111.8110	40
0TB2105.9010	36
0TB2105.9110	36
0TB704.9	35
0TB704.91	35
0TB708.91	37
0TB710.91	38

4

4A0006.00-000	32
---------------	----

5

5A5001.15	12
5A5001.16	12
5A5002.02	12
5A5002.03	12

5A5003.03	31
5AC900.1100-00	32
5C5000.21	15
5C5000.22	15
5C5000.31	15
5C5000.32	15
5C5001.32	14
5C5001.42	14
5C5002.14	12
5C5002.15	12
5C5002.16	12
5C5600.03	15
5C5600.04	15
5C5601.32	14
5CAUSB.0018-00	31
5CAUSB.0050-00	31
5CFCRD.0064-03	30
5CFCRD.0128-03	30
5CFCRD.0256-03	30
5CFCRD.0512-03	30
5CFCRD.1024-03	30
5CFCRD.2048-03	30
5CFCRD.4096-03	30
5CFCRD.8192-03	30
5D5210.01	16
5D5211.02	16
5D5211.03	19
5D5212.02	21
5D5212.04	22
5D5510.10	17
5D5600.01	18
5D5600.02	18
5D5600.03	18
5D5601.01	20
5D5601.02	20
5D5601.03	20
5E9600.01-010	50

5E9600.01-020	50
5MD900.USB2-01	47
5MMUSB.0256-00	31
5MMUSB.0512-00	31
5MMUSB.1024-00	31

7

7AC911.9	44
7TB710.9	39
7TB710.91	39
7TB712.9	41
7TB712.91	41
7TB718.9	42
7TB718.91	42

9

9A0004.11	12
9A0004.12	12
9A0004.14	12
9A0013.01	32
9A0015.99	31
9A0017.01	32
9A0017.02	32

ECINT

ECINT1-1	45
ECINT1-11	45

X20

X20CA0E61.0002	48
X20CA0E61.0010	48
X20CA0E61.0020	48
X20CA0E61.0050	48
X20CA0E61.0100	48
X20CA0E61.0150	48
X20CA0E61.0500	48

X67

X67CA0E41.0050	48
X67CA0E41.0150	48
X67CA0E41.0500	48
X67CA0X99.1000	32





COMPANY HEADQUARTERS

Bernecker + Rainer Industrie-Elektronik Ges.m.b.H.

B&R Strasse 1

5142 Eggelsberg

Austria

Tel.: +43 (0) 77 48/65 86 - 0

Fax: +43 (0) 77 48/65 86 - 26

info@br-automation.com

www.br-automation.com

Always close by - 120 offices in more than 50 countries - www.br-automation.com/contact

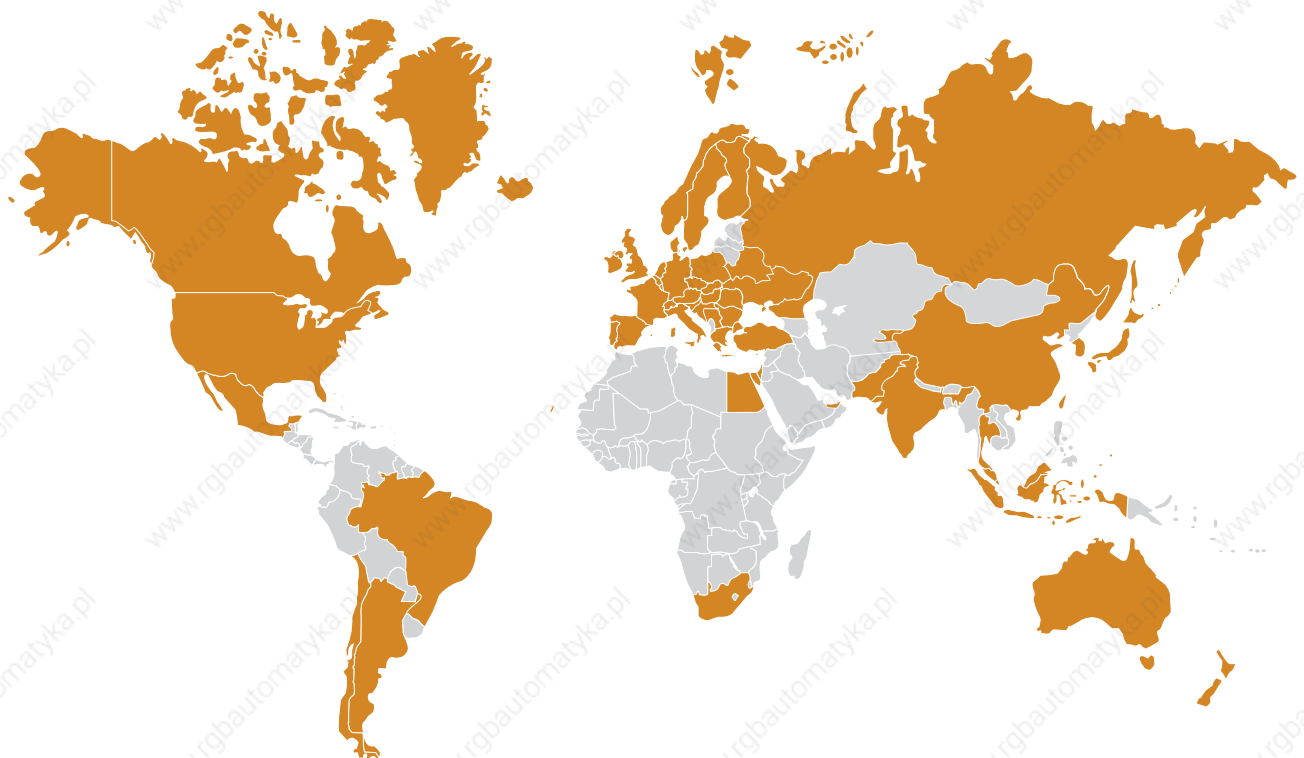

Argentina • Australia • Austria • Belarus • Belgium • Brazil • Bulgaria • Canada • Chile • China • Croatia • Cyprus • Czech Republic
Denmark • Egypt • Emirates • Finland • France • Germany • Greece • Hungary • India • Indonesia • Ireland • Israel • Italy • Japan • Korea
Kyrgyzstan • Malaysia • Mexico • The Netherlands • Norway • Pakistan • Poland • Portugal • Romania • Russia • Singapore
Slovakia • Slovenia • South Africa • Spain • Sweden • Switzerland • Taiwan • Thailand • Turkey • Ukraine • United Kingdom • USA