



# TRANSISTORIZED INVERTER

## FR-S<sub>500</sub>

### INSTRUCTION MANUAL (Detailed)

---

#### SIMPLE INVERTER

## FR-S540E-0.4K to 3.7K-EC

## FR-S520SE-0.2K to 1.5K-EC

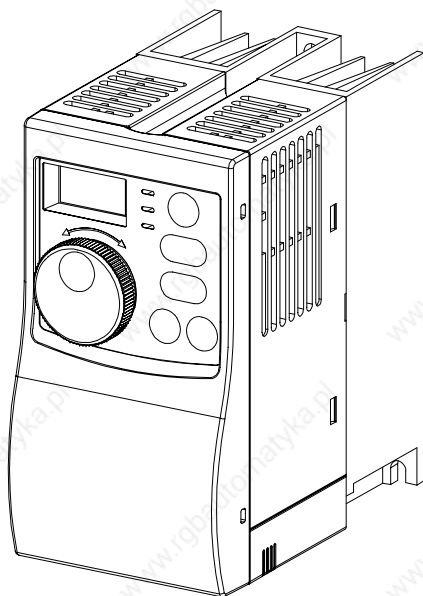

WIRING Chapter 1

FUNCTIONS Chapter 2

PROTECTIVE  
FUNCTIONS Chapter 3

SPECIFICATIONS Chapter 4

Thank you for choosing this Mitsubishi Transistorized inverter.

This instruction manual (detailed) provides instructions for advanced use of the FR-S500 series inverters.

Incorrect handling might cause an unexpected fault. Before using the inverter, always read this instruction manual and the instruction manual (basic) [IB-0600210ENG] packed with the product carefully to use the equipment to its optimum.

## This section is specifically about safety matters

Do not attempt to install, operate, maintain or inspect the inverter until you have read through this instruction manual (basic) and appended documents carefully and can use the equipment correctly. Do not use the inverter until you have a full knowledge of the equipment, safety information and instructions.

In this instruction manual (detailed), the safety instruction levels are classified into "WARNING" and "CAUTION".



### WARNING

Assumes that incorrect handling may cause hazardous conditions, resulting in death or severe injury.



### CAUTION

Assumes that incorrect handling may cause hazardous conditions, resulting in medium or slight injury, or may cause physical damage only.

Note that even the **CAUTION** level may lead to a serious consequence according to conditions. Please follow the instructions of both levels because they are important to personnel safety.

## 1. Electric Shock Prevention



### WARNING

- While power is on or when the inverter is running, do not open the front cover. You may get an electric shock.
- Do not run the inverter with the front cover or wiring cover removed. Otherwise, you may access the exposed high-voltage terminals or the charging part of the circuitry and get an electric shock. Also, the inverter's ability to withstand earthquakes will deteriorate.
- Even if power is off, do not remove the front cover except for wiring or periodic inspection. You may access the charged inverter circuits and get an electric shock.
- Before starting wiring or inspection, check to make sure that the 3-digit LED inverter monitor is off, wait for at least 10 minutes after the power supply has been switched off, and check to make sure that there are no residual voltage using a tester or the like.
- This inverter must be earthed. Earthing must conform to the requirements of national and local safety regulations and electrical codes. (JIS, NEC section 250, IEC 536 class 1 and other applicable standards)
- Any person who is involved in the wiring or inspection of this equipment should be fully competent to do the work.
- Always install the inverter before wiring. Otherwise, you may get an electric shock or be injured.
- Perform setting dial and key operations with dry hands to prevent an electric shock.
- Do not subject the cables to scratches, excessive stress, heavy loads or pinching. Otherwise, you may get an electric shock.
- Do not change the cooling fan while power is on. It is dangerous to change the cooling fan while power is on.
- When you have removed the front cover, do not touch the connector above the 3-digit monitor LED display. Otherwise, you get an electric shock.

## 2. Fire Prevention

### CAUTION

- Mount the inverter on an incombustible surface. Installing the inverter directly on or near a combustible surface could lead to a fire.
- If the inverter has become faulty, switch off the inverter power. A continuous flow of large current could cause a fire.
- Do not connect a resistor directly to the DC terminals +, -. This could cause a fire.

## 3. Injury Prevention

### CAUTION

- Apply only the voltage specified in the instruction manual to each terminal to prevent damage, etc.
- Always connect to the correct terminal to prevent damage, etc.
- Always make sure that polarity is correct to prevent damage, etc.
- While power is on or for some time after power-off, do not touch the inverter as it is hot and you may get burnt.

## 4. Additional Instructions

Also note the following points to prevent an accidental failure, injury, electric shock, etc.

### (1) Transportation and installation

### CAUTION

- When carrying products, use correct lifting gear to prevent injury.
- Do not stack the inverter boxes higher than the number recommended.
- Ensure that installation position and material can withstand the weight of the inverter. Install according to the information in the instruction manual.
- Do not install or operate if the inverter is damaged or has parts missing.
- When carrying the inverter, do not hold it by the front cover or setting dial; it may fall off or fail.
- Do not stand or rest heavy objects on the inverter.
- Check the inverter mounting orientation is correct.
- Prevent other conductive bodies as screws and metal fragments or other flammable substance as oil from entering the inverter.
- As the inverter is a precision instrument, do not drop or subject it to impact.
- Use the inverter under the following environmental conditions: This could cause the inverter damage.

Environment	Ambient Temperature	-10°C to +50°C (non-freezing)
	Ambient humidity	90%RH maximum (non-condensing)
	Storage temperature	-20°C to +65°C *
	Atmosphere	Indoors (free from corrosive gas, flammable gas, oil mist, dust and dirt)
	Altitude/vibration	Maximum 1000m above sea level for standard operation. After that derate by 3% for every extra 500m up to 2500m (91%). 5.9m/s <sup>2</sup> or less (conforming to JIS C 60068-2-6)

\*Temperatures applicable for a short time, e.g. in transit.

## (2) Wiring

### CAUTION

- Do not fit capacitive equipment such as power factor correction capacitor, radio noise filter (option FR-BIF(-H)) or surge suppressor to the output of the inverter.
- The connection orientation of the output cables U, V, W to the motor will affect the direction of rotation of the motor.

## (3) Trial run

### CAUTION

- Check all parameters, and ensure that the machine will not be damaged by a sudden start-up.
- When the load  $GD^2$  is small (at the motor  $GD$  or smaller) for 400V from 1.5K to 3.7K, the output current may vary when the output frequency is in the 20Hz to 30Hz range. If this is a problem, set the Pr.72 "PWM frequency selection" to 6kHz or higher. (When setting the PWM to a higher frequency, check for noise or leakage current problem and take countermeasures against it.)

## (4) Operation

### WARNING

- When you have chosen the retry function, stay away from the equipment as it will restart suddenly after an alarm stop.
- The [STOP] key is valid only when the appropriate function setting has been made. Prepare an emergency stop switch separately.
- Make sure that the start signal is off before resetting the inverter alarm. A failure to do so may restart the motor suddenly.
- The load used should be a three-phase induction motor only. Connection of any other electrical equipment to the inverter output may damage the equipment.
- Do not modify the equipment.
- Do not perform parts removal which is not instructed in this manual. Doing so may lead to fault or damage of the inverter.

## CAUTION

- The electronic thermal relay function does not guarantee protection of the motor from overheating.
- Do not use a magnetic contactor on the inverter input for frequent starting/stopping of the inverter.
- Use a noise filter to reduce the effect of electromagnetic interference. Otherwise nearby electronic equipment may be affected.
- Take measures to suppress harmonics. Otherwise power supply harmonics from the inverter may heat/damage the power capacitor and generator.
- When a 400V class motor is inverter-driven, please use an insulation-enhanced motor or measures taken to suppress surge voltages. Surge voltages attributable to the wiring constants may occur at the motor terminals, deteriorating the insulation of the motor.
- When parameter clear or all clear is performed, reset the required parameters before starting operations. Each parameter returns to the factory setting.
- The inverter can be easily set for high-speed operation. Before changing its setting, fully examine the performances of the motor and machine.
- In addition to the inverter's holding function, install a holding device to ensure safety.
- Before running an inverter which had been stored for a long period, always perform inspection and test operation.

### (5) Emergency stop

## CAUTION

- Provide a safety backup such as an emergency brake which will prevent the machine and equipment from hazardous conditions if the inverter fails.
- When the breaker on the inverter primary side trips, check for the wiring fault (short circuit), damage to internal parts of the inverter, etc. Identify the cause of the trip, then remove the cause and power on the breaker.
- When any protective function is activated, take the appropriate corrective action, then reset the inverter, and resume operation.

### (6) Maintenance, inspection and parts replacement

## CAUTION

- Do not carry out a megger (insulation resistance) test on the control circuit of the inverter.

### (7) Disposing of the inverter

## CAUTION

- Treat as industrial waste.

### (8) General instructions

Many of the diagrams and drawings in this instruction manual (detailed) show the inverter without a cover, or partially open. Never operate the inverter in this manner. Always replace the cover and follow this instruction manual (detailed) when operating the inverter.

# CONTENTS

## 1. WIRING

1

<b>1.1</b>	<b>Standard connection diagram and terminal specifications ..2</b>	
1.1.1	Standard connection diagram .....	2
1.1.2	Explanation of main circuit terminals.....	3
<b>1.2</b>	<b>Main circuit terminals .....</b>	<b>6</b>
1.2.1	Terminal block layout .....	6
1.2.2	Cables, wiring length, and crimping terminals.....	7
1.2.3	Wiring instructions .....	8
1.2.4	Selection of peripheral devices .....	9
1.2.5	Leakage current and installation of earth leakage circuit breaker .....	10
1.2.6	Power-off and magnetic contactor (MC).....	14
1.2.7	Regarding the installation of the power factor improving reactor .....	15
1.2.8	Regarding noise and the installation of a noise filter.....	16
1.2.9	Earthing precautions .....	17
1.2.10	Power supply harmonics .....	18
1.2.11	Inverter-driven 400V class motor .....	19
<b>1.3</b>	<b>How to use the control circuit terminals .....</b>	<b>20</b>
1.3.1	Terminal block layout .....	20
1.3.2	Wiring instructions .....	20
1.3.3	Changing the control logic.....	21
<b>1.4</b>	<b>Input terminals.....</b>	<b>23</b>
1.4.1	Run (start) and stop (STF, STR, STOP) .....	23
1.4.2	Connection of frequency setting potentiometer and output frequency meter (10, 2, 5, 4, AU) .....	26
1.4.3	External frequency selection (REX, RH, RM, RL).....	27
1.4.4	Indicator connection and adjustment (AM).....	29
1.4.5	Control circuit common terminals (PC, 5, SE).....	30
1.4.6	Signal inputs by contactless switches .....	30
<b>1.5</b>	<b>How to use the input signals (assigned terminals RL, RM, RH, STR).....</b>	<b>31</b>
1.5.1	Multi-speed setting (RL, RM, RH, REX signals): Pr. 60 to Pr. 63 setting "0, 1, 2, 8" Remote setting (RL, RM, RH signals): Pr. 60 to Pr. 63 setting "0, 1, 2" .....	31
1.5.2	Second function selection (RT signal): Pr. 60 to Pr. 63 setting "3" .....	31
1.5.3	Current input selection "AU signal": Pr. 60 to Pr. 63 setting "4" .....	31

1.5.4	Start self-holding selection (STOP signal): Pr. 60 to Pr. 63 setting "5" .....	32
1.5.5	Output shut-off (MRS signal): Pr. 60 to Pr. 63 setting "6" .....	32
1.5.6	External thermal relay input: Pr. 60 to Pr. 63 setting "7" .....	33
1.5.7	Jog operation (JOG signal): Pr. 60 to Pr. 63 setting "9" .....	33
1.5.8	Reset signal: Pr. 60 to Pr. 63 setting "10" .....	34
1.5.9	PID control valid terminal: Pr. 60 to Pr. 63 setting "14" .....	35
1.5.10	PU operation/external operation switchover: Pr. 60 to Pr. 63 setting "16" ..	35
<b>1.6</b>	<b>Connection to the Stand-Alone Option .....</b>	<b>36</b>
1.6.1	Connection of the brake unit (BU type) .....	36
1.6.2	Connection of the high power factor converter (FR-HC) .....	37
1.6.3	Connection of the power regeneration common converter (FR-CV) .....	38
<b>1.7</b>	<b>Handling of the RS-485 connector .....</b>	<b>39</b>
1.7.1	Connection of the parameter unit (FR-PU04) .....	39
1.7.2	Wiring of RS-485 communication .....	40
<b>1.8</b>	<b>Design information .....</b>	<b>43</b>
<b>2. FUNCTIONS</b>		<b>45</b>

---



---

<b>2.1</b>	<b>Function (Parameter) list .....</b>	<b>46</b>
<b>2.2</b>	<b>List of parameters classified by purpose of use .....</b>	<b>59</b>
<b>2.3</b>	<b>Explanation of functions (parameters) .....</b>	<b>61</b>
2.3.1	Torque boost (Pr. 0 , Pr. 46 ) .....	61
2.3.2	Maximum and minimum frequency (Pr. 1 , Pr. 2 ) .....	62
2.3.3	Base frequency, base frequency voltage (Pr.3 , Pr.19 , Pr.47 ) .....	63
2.3.4	Multi-speed operation (Pr. 4, Pr. 5, Pr. 6, Pr. 24 to Pr. 27, Pr. 80 to Pr. 87) ..	64
2.3.5	Acceleration/deceleration time (Pr. 7 , Pr. 8 , Pr. 20 , Pr. 44 , Pr. 45 ) .....	65
2.3.6	Selection and protection of a motor (Pr. 9 , Pr. 71 , H7 ) .....	67
2.3.7	DC injection brake (Pr. 10 , Pr. 11 , Pr. 12 ) .....	69
2.3.8	Starting frequency (Pr. 13 ) .....	70
2.3.9	Load pattern selection (Pr. 14 ) .....	71
2.3.10	Jog operation (Pr.15 , Pr.16 ) .....	72
2.3.11	RUN key rotation direction selection (Pr.17 ) .....	72
2.3.12	Stall prevention function and current limit function (Pr. 21 ) .....	73
2.3.13	Stall prevention (Pr. 22 , Pr. 23 , Pr. 28 ) .....	75
2.3.14	Acceleration/deceleration pattern (Pr. 29 ) .....	77
2.3.15	Extended function display selection (Pr. 30 ) .....	78
2.3.16	Frequency jump (Pr. 31 to Pr. 36 ) .....	78
2.3.17	Speed display (Pr. 37 ) .....	79

2.3.18	Biases and gains of the frequency setting voltage (current) (Pr. 38 , Pr. 39 , C2 to C7 ).....	80
2.3.19	Start-time earth fault detection selection (Pr. 40 ).....	84
<b>2.4</b>	<b>Output terminal function parameters .....</b>	<b>84</b>
2.4.1	Up-to-frequency (Pr. 41 ).....	84
2.4.2	Output frequency detection (Pr. 42 , Pr. 43 ).....	85
<b>2.5</b>	<b>Current detection function parameters .....</b>	<b>86</b>
2.5.1	Output current detection functions (Pr. 48 , Pr. 49 ).....	86
2.5.2	Zero current detection (Pr. 50 , Pr. 51 ).....	87
<b>2.6</b>	<b>Display function parameters .....</b>	<b>88</b>
2.6.1	Monitor display (Pr. 52 , Pr. 54 ).....	88
2.6.2	Setting dial function selection (Pr. 53 ).....	89
2.6.3	Monitoring reference (Pr. 55 , Pr. 56 ).....	90
<b>2.7</b>	<b>Restart operation parameters .....</b>	<b>90</b>
2.7.1	Restart setting (Pr. 57 , Pr. 58 , H6 ).....	90
<b>2.8</b>	<b>Additional function parameters .....</b>	<b>93</b>
2.8.1	Remote setting function selection (Pr. 59 ) .....	93
<b>2.9</b>	<b>Terminal function selection parameters .....</b>	<b>96</b>
2.9.1	Input terminal function selection (Pr. 60 , Pr. 61 , Pr. 62 , Pr. 63 ).....	96
2.9.2	Output terminal function selection (Pr. 64 , Pr. 65 ) .....	98
<b>2.10</b>	<b>Operation selection function parameters .....</b>	<b>99</b>
2.10.1	Retry function (Pr. 66 , Pr. 67 , Pr. 68 , Pr. 69 ) .....	99
2.10.2	PWM carrier frequency and long wiring mode (Pr. 70 , Pr. 72 ).....	101
2.10.3	Voltage input selection (Pr. 73 ) .....	102
2.10.4	Input filter time constant (Pr. 74 ) .....	103
2.10.5	Reset selection/PU stop selection (Pr. 75 ).....	103
2.10.6	Cooling fan operation selection (Pr. 76 ) .....	105
2.10.7	Parameter write disable selection (Pr. 77 ) .....	106
2.10.8	Reverse rotation prevention selection (Pr. 78 ) .....	107
2.10.9	Operation mode selection (Pr. 79 ) .....	107
2.10.10	PID control (Pr. 88 to Pr. 94 ) .....	111
<b>2.11</b>	<b>Auxiliary parameters .....</b>	<b>118</b>
2.11.1	Slip compensation (Pr. 95 , Pr. 96 , Pr. 97 ).....	118
2.11.2	Automatic torque boost selection (Pr. 98 ) .....	119
2.11.3	Motor primary resistance (Pr. 99 ).....	120
<b>2.12</b>	<b>Maintenance parameters .....</b>	<b>120</b>



2.12.1	Maintenance output function (H1, H2 ) .....	120
2.12.2	Current average value monitor signal (H3, H4, H5) .....	121
<b>2.13</b>	<b>Calibration parameters.....</b>	<b>124</b>
2.13.1	Meter (frequency meter) calibration (C1 ) .....	124
<b>2.14</b>	<b>Clear parameters.....</b>	<b>127</b>
2.14.1	Parameter clear (CLr ) .....	127
2.14.2	Alarm history clear (ECL ) .....	127
<b>2.15</b>	<b>Communication parameters.....</b>	<b>128</b>
2.15.1	Communication settings (n1 to n7 , n11 ) .....	130
2.15.2	Operation and speed command source (n8 , n9 ) .....	145
2.15.3	Link startup mode selection (n10 ) .....	146
2.15.4	E2PROM write selection (n12 ) .....	148
<b>2.16</b>	<b>Parameter unit (FR-PU04) setting.....</b>	<b>149</b>
2.16.1	PU display language selection (n13 ) .....	149
2.16.2	PU buzzer control (n14 ) .....	149
2.16.3	PU contrast adjustment (n15 ) .....	150
2.16.4	PU main display screen data selection (n16 ) .....	150
2.16.5	Disconnected PU detection/PU setting lock selection (n17 ) .....	151

---

## **3. PROTECTIVE FUNCTIONS 153**

---

<b>3.1</b>	<b>Errors (Alarms).....</b>	<b>154</b>
3.1.1	Error (alarm) definitions .....	155
3.1.2	To know the operating status at the occurrence of alarm (only when FR-PU04 is used) .....	163
3.1.3	Correspondence between digital and actual characters .....	163
3.1.4	Resetting the inverter.....	163
<b>3.2</b>	<b>Troubleshooting.....</b>	<b>164</b>
3.2.1	Motor remains stopped .....	164
3.2.2	Motor rotates in opposite direction .....	165
3.2.3	Speed greatly differs from the setting .....	165
3.2.4	Acceleration/deceleration is not smooth .....	165
3.2.5	Motor current is large .....	165
3.2.6	Speed does not increase .....	165
3.2.7	Speed varies during operation .....	165
3.2.8	Operation mode is not changed properly .....	166
3.2.9	Operation panel display is not operating.....	166
3.2.10	Parameter write cannot be performed .....	166

3.2.11 Motor produces annoying sound .....	166
--	-----

---

---

<b>4. SPECIFICATIONS</b>	<b>167</b>
--------------------------	------------

---

---

<b>4.1 Specification list .....</b>	<b>168</b>
-------------------------------------	------------

4.1.1 Ratings .....	168
---------------------	-----

4.1.2 Common specifications .....	170
-----------------------------------	-----

<b>4.2 Outline drawings .....</b>	<b>172</b>
-----------------------------------	------------

---

---

<b>APPENDIX</b>	<b>175</b>
-----------------	------------

---

---

<b>APPENDIX 1 Parameter Instruction Code List .....</b>	<b>176</b>
---	------------

# 1. WIRING

This chapter explains the basic "wiring" for use of this product. Always read the instructions before use.

For description of "installation", refer to the instruction manual (basic).

<b>1.1 Standard connection diagram and terminal specifications .....</b>	<b>2</b>
<b>1.2 Main circuit terminals .....</b>	<b>6</b>
<b>1.3 How to use the control circuit terminals .....</b>	<b>20</b>
<b>1.4 Input terminals.....</b>	<b>23</b>
<b>1.5 How to use the input signals (assigned terminals RL, RM, RH, STR) .....</b>	<b>31</b>
<b>1.6 Connection to the Stand-Alone Option .....</b>	<b>36</b>
<b>1.7 Handling of the RS-485 connector .....</b>	<b>39</b>
<b>1.8 Design information.....</b>	<b>43</b>

## <Abbreviations>

### •PU

Operation panel and parameter unit (FR-PU04)

### •Inverter

Mitsubishi transistorized inverter FR-S500 series

### •FR-S500

Mitsubishi transistorized inverter FR-S500 series

### •Pr.

Parameter number

Chapter 1

Chapter 2

Chapter 3

Chapter 4

# 1.1 Standard connection diagram and terminal specifications

## 1.1.1 Standard connection diagram

- Three-phase 400V power input

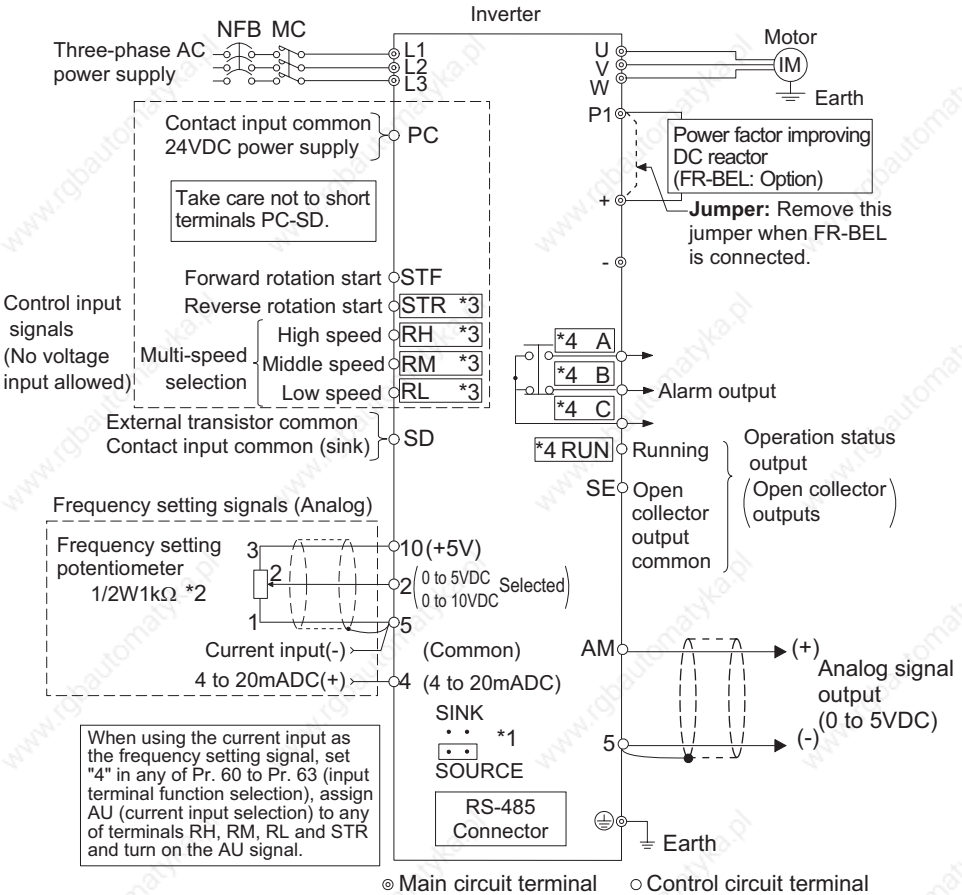

### REMARKS

- \*1. You can switch the position of sink and source logic. Refer to page 21.
- \*2. When the setting potentiometer is used frequently, use a 2W 1kΩ potentiometer.
- \*3. The terminal functions change with input terminal function selection (Pr. 60 to Pr. 63). (Refer to page 96.) (RES, RL, RM, RH, RT, AU, STOP, MRS, OH, REX, JOG, X14, X16, (STR) signal selection)
- \*4. The terminal function changes according to the setting of output terminal function selection (Pr. 64, Pr. 65). (Refer to page 98.) (RUN, SU, OL, FU, RY, Y12, Y13, FDN, FUP, RL, Y93, Y95, LF, ABC signal selection)

### CAUTION

To prevent a malfunction due to noise, keep the signal cables more than 10cm away from the power cables.

- Single-phase 200V power input

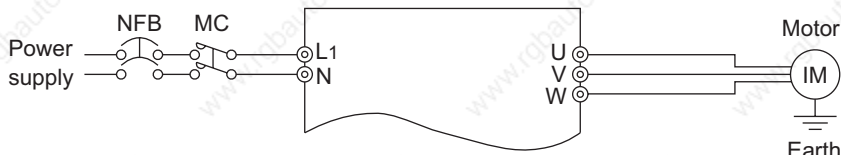

### REMARKS

- To ensure safety, connect the power input to the inverter via a magnetic contactor and earth leakage circuit breaker or no-fuse breaker, and use the magnetic contactor to switch power on-off.
- The output is three-phase 200V.

## 1.1.2 Explanation of main circuit terminals

### (1) Main circuit

Terminal Symbol	Terminal Name	Description
L1, L2, L3 (*1)	AC power input	Connect to the commercial power supply.
U, V, W	Inverter output	Connect a three-phase squirrel-cage motor.
+, -	Brake unit connection	Connect the brake unit (BU), power regeneration common converter (FR-CV) or high power factor converter (FR-HC).
+, P1	Power factor improving DC reactor connection	Remove the jumper across terminals + - P1 and connect the optional power factor improving DC reactor (FR-BEL(-H)).
	Earth	For earthing the inverter chassis. Must be earthed.

\*1. When using single-phase power input, terminals are L1 and N.

## (2) Control circuit

Symbol		Terminal Name	Definition		
Input signals	Contact input	STF	<b>Forward rotation start</b>	Turn on the STF signal to start forward rotation and turn it off to stop.	When the STF and STR signals are turned on simultaneously, the stop command is given.
		STR	<b>Reverse rotation start</b>	Turn on the STR signal to start reverse rotation and turn it off to stop.	
		RH RM RL	<b>Multi-speed selection</b>	Turn on the RH, RM and RL signals in appropriate combinations to select multiple speeds. The priorities of the speed commands are in order of jog, multi-speed setting (RH, RM, RL, REX) and AU.	The terminal functions change with input terminal function selection (Pr. 60 to Pr.63). (*3)
	SD (*1)	<b>External transistor common, Contact input common (sink)</b>	When connecting the transistor output (open collector output), such as a programmable controller (PLC), connect the negative external power supply for transistor output to this terminal to prevent a malfunction caused by undesirable currents. (*6) When sink logic has been selected, this terminal serves as a contact input common.		
	PC (*1)	<b>24VDC power supply, Contact input common (source)</b>	Common to the contact input terminals (STF, STR, RH, RM, RL). This terminal can be used as a 0.1A 24VDC power supply across terminals PC-SD.		
	10	<b>Frequency setting power supply</b>	5VDC, Permissible load current 10mA.		
Frequency setting	2	<b>Frequency setting (voltage signal)</b>	Inputting 0 to 5VDC (or 0 to 10V) provides the maximum output frequency at 5V (10V) and makes input and output proportional. Switch between 5V and 10V using Pr. 73 "0-5V, 0-10V selection". Input resistance 10kΩ. Maximum permissible input voltage 20V		
	4	<b>Frequency setting (current signal)</b>	Input 4 to 20mADC. It is factory set at 0Hz for 4mA and at 50Hz for 20mA. Maximum permissible input current 30mA. Input resistance approximately 250Ω. Turn ON signal AU for current input. Turning the AU signal on makes voltage input invalid. Use any of Pr. 60 to Pr. 63 (input terminal function selection) to set the AU signal.		
	5	<b>Frequency setting input common</b>	Common terminal for the frequency setting signals (terminal 2, 4) and indicator connection (terminal AM). (*6)		

Symbol	Terminal Name	Definition
Output signals	A B C	<b>Alarm output</b> Changeover contact output indicates that the inverter protective function has activated and the output stopped. 230VAC 0.3A, 30VDC 0.3A. Alarm: discontinuity across B-C (continuity across A-C), Normal: continuity across B-C (discontinuity across A-C).(*5)
	Open collector RUN	<b>Inverter running</b> Switched low when the inverter output frequency is equal to or higher than the starting frequency (factory set to 0.5Hz variable). Switched high during stop or DC injection brake operation. (*2) Permissible load 24VDC 0.1A (a voltage drop is 3.4V maximum when the signal is on)
	SE	<b>Open collector common</b> Common terminal for inverter running terminal RUN. (*6)
	Indicator AM	<b>Analog signal output</b> The output signal across terminals AM-5 is factory set to about 5VDC at 50Hz and is proportional to the corresponding output frequency. Frequency permissible load current 1mA Output signal 0 to 5VDC
Communication	— <b>RS-485 connector</b>	Using the parameter unit connection cable (FR-CB201 to 205), the parameter unit (FR-PU04) can be connected. Communication operation can be performed using RS-485. For details of RS-485 communication, refer to page 40.

- \*1. Do not connect terminals SD and PC each other or to the earth.  
For source logic (factory setting), terminal PC acts as the common terminal of contact input. For sink logic, terminal SD acts as the common terminal of contact input. (Refer to page 21 for switching method.)
- \*2. Low indicates that the open collector output transistor is on (conducts). High indicates that the transistor is off (does not conduct).
- \*3. RL, RM, RH, RT, AU, STOP, MRS, OH, REX, JOG, RES, X14, X16, (STR) signal selection (Refer to page 96.)
- \*4. RUN, SU, OL, FU, RY, Y12, Y13, FDN, FUP, RL, Y93, Y95, LF, ABC signal selection (Refer to page 98.)
- \*5. To be compliant with the European Directive (Low Voltage Directive), the operating capacity of relay outputs (A, B, C) should be 30VDC 0.3A.
- \*6. Terminals SD, SE and 5 are isolated from each other. Do not earth.

## 1.2 Main circuit terminals

### 1.2.1 Terminal block layout

#### 1) Three-phase 400V power input

- FR-S540E-0.4K, 0.75K, 1.5K, 2.2K, 3.7K-EC

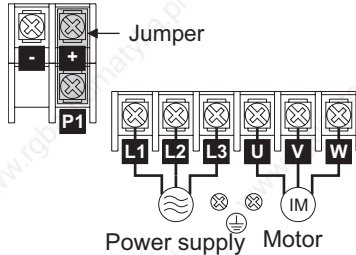

#### 2) Single-phase 200V power input

- FR-S520SE-0.2K, 0.4K, 0.75K-EC

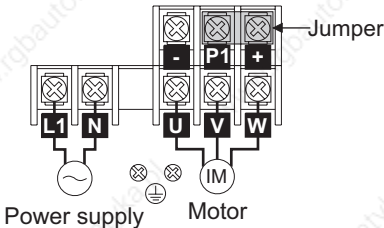

- FR-S520SE-1.5K-EC

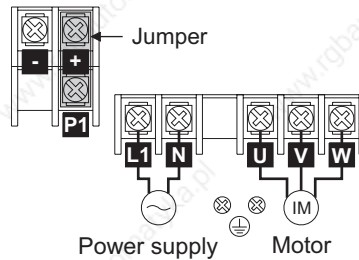

#### CAUTION

- Make sure the power cables are connected to the L1, L2, L3 of the inverter. Never connect the power cable to the U, V, W of the inverter. (Phase need not be matched)
- Connect the motor to U, V, W. At this time, turning on the forward rotation switch (signal) rotates the motor in the counterclockwise direction when viewed from the motor shaft.



## 1.2.2 Cables, wiring length, and crimping terminals

The following table indicates a selection example for the wiring length of 20m.

### 1) Three-phase 400V power input

Applied Inverter	Terminal Screw size	Tightening Torque N·m	Crimping Terminal		Cable				PVC Insulation Cable	
					mm <sup>2</sup>		AWG		mm <sup>2</sup>	
			L1, L2, L3	U, V, W	L1, L2, L3	U, V, W	L1, L2, L3	U, V, W	L1, L2, L3	U, V, W
<b>FR-S540E-0.4K to 3.7K-EC</b>	M4	1.5	2-4	2-4	2	2	14	14	2.5	2.5

### 2) Single-phase 200V power input

Applied Inverter	Terminal Screw size	Tightening Torque N·m	Crimping Terminal		Cable				PVC Insulation Cable	
					mm <sup>2</sup>		AWG		mm <sup>2</sup>	
			L1, N	U, V, W	L1, N	U, V, W	L1, N	U, V, W	L1, N	U, V, W
<b>FR-S520SE-0.2K to 0.75K-EC</b>	M3.5	1.2	2-3.5	2-3.5	2	2	14	14	2.5	2.5
<b>FR-S520SE-1.5K-EC</b>	M4	1.5	2-4	2-4	2	2	14	14	2.5	2.5

#### ● Wiring length

100m maximum. (50m maximum for the FR-S540E-0.4K-EC.)

#### CAUTION

- When the wiring length of the 0.2K of the single-phase 200V class and 0.4K and 0.75K of the three-phase 400V class is 30m or more, set the carrier frequency to 1kHz.
- When automatic torque boost is selected in Pr. 98 "automatic torque boost selection (motor capacity)", the wiring length should be 30m maximum. (Refer to page 119.)

### **1.2.3 Wiring instructions**

- 1) Use insulation-sleeved crimping terminals for the power supply and motor cables.
- 2) Application of power to the output terminals (U, V, W) of the inverter will damage the inverter. Never perform such wiring.
- 3) After wiring, wire offcuts must not be left in the inverter.  
Wire offcuts can cause an alarm, failure or malfunction. Always keep the inverter clean.  
When drilling a control box etc., take care not to let wire offcuts enter the inverter.
- 4) Use cables of the recommended size to make a voltage drop 2% maximum.  
If the wiring distance is long between the inverter and motor, a main circuit cable voltage drop will cause the motor torque to decrease especially at the output of a low frequency.
- 5) For long distance wiring, the high response current limit function may be reduced or the devices connected to the secondary side may malfunction or become faulty under the influence of a charging current due to the stray capacity of wiring.  
Therefore, note the maximum overall wiring length.
- 6) Electromagnetic wave interference  
The input/output (main circuit) of the inverter includes high frequency components, which may interfere with the communication devices (such as AM radios) used near the inverter. In this case, install a FR-BIF(-H) optional radio noise filter (for use on the input side only) or FR-BSF01 or FR-BLF line noise filter to minimize interference.
- 7) Do not install a power capacitor, surge suppressor or radio noise filter (FR-BIF(-H) option) on the output side of the inverter.  
This will cause the inverter to trip or the capacitor and surge suppressor to be damaged. If any of the above devices are connected, remove them. (When using the FR-BIF(-H) radio noise filter with a single-phase power supply, connect it to the input side of the inverter after isolating the L3 phase securely.)
- 8) Before starting wiring or other work after the inverter is operated, wait for at least 10 minutes after the power supply has been switched off, and check that there are no residual voltage using a tester or the like. The capacitor is charged with high voltage for some time after power off and it is dangerous.

## 1.2.4 Selection of peripheral devices

Check the capacity of the motor applicable to the inverter you purchased. Appropriate peripheral devices must be selected according to the capacity.

Refer to the following list and prepare appropriate peripheral devices:

### 1) Three-phase 400V power input

Motor Output (kW)	Applied Inverter Type	No-fuse Breaker (NFB *1, 4) or Earth Leakage Circuit Breaker (ELB) (Refer to page 10) (*2, 4)	Magnetic Contactor (MC) (Refer to page 14)	Power Factor Improving AC Reactor (Refer to page 15)	Power Factor Improving DC Reactor (Refer to page 15)
0.4	FR-S540E-0.4K-EC	30AF/5A	S-N10	FR-BAL-H0.4K	FR-BEL-H0.4K
0.75	FR-S540E-0.75K-EC	30AF/5A	S-N10	FR-BAL-H0.75K	FR-BEL-H0.75K
1.5	FR-S540E-1.5K-EC	30AF/10A	S-N10	FR-BAL-H1.5K	FR-BEL-H1.5K
2.2	FR-S540E-2.2K-EC	30AF/15A	S-N10	FR-BAL-H2.2K	FR-BEL-H2.2K
3.7	FR-S540E-3.7K-EC	30AF/20A	S-N20, S-N21	FR-BAL-H3.7K	FR-BEL-H3.7K

### 2) Single-phase 200V power input

Motor Output (kW)	Applied Inverter Type	No-fuse Breaker (NFB *1, 4) or Earth Leakage Circuit Breaker (ELB) (Refer to page 10) (*2, 4)	Magnetic Contactor (MC) (Refer to page 14)	Power Factor Improving AC Reactor (Refer to page 15) (*3)	Power Factor Improving DC Reactor (Refer to page 15) (*3)
0.2	FR-S520SE-0.2K-EC	30AF/10A	S-N10	FR-BAL-0.4K	FR-BEL-0.4K
0.4	FR-S520SE-0.4K-EC	30AF/10A	S-N20, S-N21	FR-BAL-0.75K	FR-BEL-0.75K
0.75	FR-S520SE-0.75K-EC	30AF/15A	S-N20, S-N21	FR-BAL-1.5K	FR-BEL-1.5K
1.5	FR-S520SE-1.5K-EC	30AF/20A	S-N20, S-N21	FR-BAL-2.2K	FR-BEL-2.2K

\*1. •Select the NFB according to the inverter power supply capacity.

•Install one NFB per inverter.

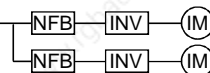

\*2. For installations in the United States or Canada, the circuit breaker must be inverse time or instantaneous trip type.

\*3. The power factor may be slightly lower.

\*4. When the breaker on the inverter primary side trips, check for the wiring fault (short circuit), damage to internal parts of the inverter, etc. Identify the cause of the trip, then remove the cause and power on the breaker.

## **1.2.5 Leakage current and installation of earth leakage circuit breaker**

Due to static capacitances existing in the inverter I/O wiring and motor, leakage currents flow through them. Since their values depend on the static capacitances, carrier frequency, etc., take the following countermeasures.

### **(1) To-earth leakage currents**

Leakage currents may flow not only into the inverter's own line but also into the other line through the earth cable, etc.

These leakage currents may operate earth leakage circuit breakers and earth leakage relays unnecessarily.

#### **● Countermeasures**

- If the carrier frequency setting is high, decrease the carrier frequency (Pr. 72) of the inverter.  
Note that motor noise increases. Selection of Soft-PWM control (Pr. 70) will make it unoffending. (Factory setting)
- By using earth leakage circuit breakers designed for harmonic and surge suppression in the inverter's own line and other line, operation can be performed with the carrier frequency kept high (with low noise).

## (2) Line-to-line leakage currents

Harmonics of leakage currents flowing in static capacities between the inverter output cables may operate the external thermal relay unnecessarily.

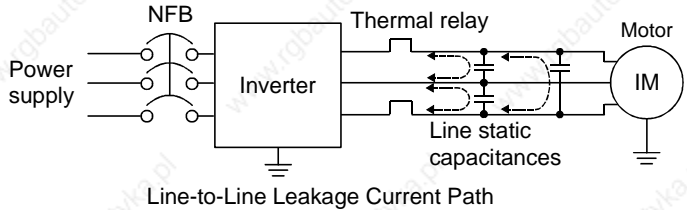

### ● Countermeasures

- Use the electronic thermal relay function of the inverter.
- Decrease the carrier frequency. Note that motor noise increases. Selection of Soft-PWM (Pr. 70) makes it unoffending.

To ensure that the motor is protected against line-to-line leakage currents, it is recommended to use a temperature sensor to directly detect motor temperature.

### ● Installation and selection of no-fuse breaker

Install a no-fuse breaker (NFB) on the power receiving side to protect the wiring of the inverter primary side. Select the NFB according to the power supply side power factor (which depends on the power supply voltage, output frequency and load). Especially for a completely electromagnetic NFB, one of a slightly large capacity must be selected since its operation characteristic varies with harmonic currents. (Check it in the data of the corresponding breaker.) As an earth leakage breaker, use the Mitsubishi earth leakage breaker designed for harmonics and surge suppression. (Refer to page 7 for the recommended models.)

## CAUTION

- Select the NFB according to the inverter power supply capacity.
- Install one NFB per inverter.

### (3) Selecting the rated sensitivity current for the earth leakage circuit breaker

When using the earth leakage circuit breaker with the inverter circuit, select its rated sensitivity current as follows, independently of the PWM carrier frequency:

- Breaker for harmonic and surge  
 Rated sensitivity current:  
 $I_{\Delta n} \geq 10 \times (I_{g1} + I_{gn} + I_{g2} + I_{gm})$
- Standard breaker  
 Rated sensitivity current:  
 $I_{\Delta n} \geq 10 \times \{I_{g1} + I_{gn} + 3 \times (I_{g2} + I_{gm})\}$   
 $I_{g1}, I_{g2}$  : Leakage currents of cable path during commercial power supply operation  
 $I_{gn}^*$  : Leakage current of noise filter on inverter input side  
 $I_{gm}$  : Leakage current of motor during commercial power supply operation

\* Note the leakage current value of the noise filter installed on the inverter input side.

Example of leakage current per 1km in cable path during commercial power supply operation when the CV cable is routed in metal conduit (3-phase 3-wire delta connection cable 400V 60Hz)

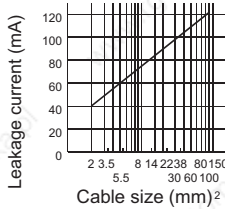

Leakage current example of three-phase induction motor during commercial power supply operation (Totally-enclosed fan-cooled type motor 400V 60Hz)

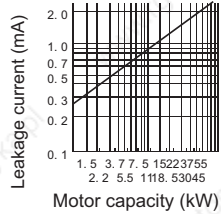

About 1/3 of the above for star connection cable.

<Example>

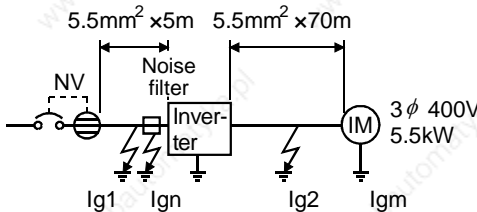

	Breaker for harmonic and surge	Standard breaker
Leakage current ( $I_{g1}$ ) (mA)	$\frac{1}{3} \times 66 \times 5m/1000m = 0.11$	
Leakage current ( $I_{gn}$ ) (mA)	0 (without noise filter)	
Leakage current ( $I_{g2}$ ) (mA)	$\frac{1}{3} \times 66 \times 70m/1000m = 1.54$	
Motor leakage current ( $I_{gm}$ ) (mA)		0.58
Total leakage current (mA)	2.23	6.47
Rated sensitivity current (mA) ( $\geq I_g \times 10$ )	30	100

---

**CAUTION**

---

- The earth leakage circuit breaker should be installed to the primary (power supply) side of the inverter.
  - In the  $\Delta$  connection neutral point earthed system, the sensitivity current becomes worse for earth faults on the inverter secondary side. Earthing must conform to the requirements of national and local safety regulations and electrical codes. (JIS, NEC section 250, IEC 536 class 1 and other applicable standards)
  - When the breaker is installed on the secondary side of the inverter, it may be unnecessarily operated by harmonics if the effective value is less than the rating. In this case, do not install the breaker since the eddy current and hysteresis loss increase and the temperature rises.
  - General products indicate the following models: BV-C1, BC-V, NVB, NV-L, NV-G2N, NV-G3NA, NV-2F, earth leakage relay (except NV-ZHA), NV with AA neutral wire open-phase protection  
The other models are designed for harmonic and surge suppression: NV-C/NV-S/MN series, NV30-FA, NV50-FA, BV-C2, earth leakage alarm breaker (NF-Z), NV-ZHA, NV-H
-

## 1.2.6 Power-off and magnetic contactor (MC)

### (1) Inverter input side magnetic contactor (MC)

On the inverter's input side, it is recommended to provide an MC for the following purposes. (Refer to page 9 for selection)

- 1) To release the inverter from the power supply when the inverter protective function is activated or the drive becomes faulty (e.g. emergency stop operation)
- 2) To prevent any accident due to an automatic restart at restoration of power after an inverter stop made by a power failure
- 3) To rest the inverter for an extended period of time

The control power supply for inverter is always running and consumes a little power. When stopping the inverter for an extended period of time, powering off the inverter will save power slightly.

- 4) To separate the inverter from the power supply to ensure safe maintenance and inspection work

The inverter's input side MC is used for the above purpose, select class JEM1038-AC3 for the inverter input side current when making an emergency stop during normal operation.

#### REMARKS

The MC may be switched on/off to start/stop the inverter. However, since repeated inrush currents at power on will shorten the life of the converter circuit (switching life is about 100,000 times), frequent starts and stops must be avoided. Turn on/off the inverter start controlling terminals (STF, STR) to run/stop the inverter.

As shown on the right, always use the start signal (ON or OFF across terminals STF or STR-PC) to make a start or stop. (Refer to page 23)

- \*1. When the power supply is 400V class, install a step-down transformer.

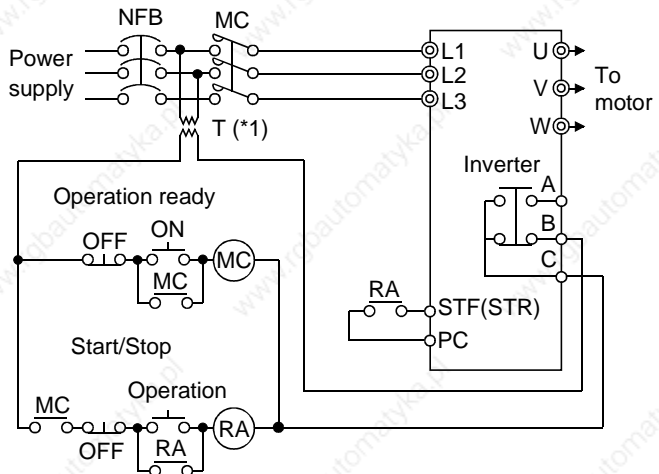

Inverter Start/Stop Circuit Example

### (2) Handling of output side magnetic contactor

In principle, do not provide a magnetic contactor between the inverter and motor and switch it from off to on during operation. If it is switched on during inverter operation, a large inrush current may flow, stopping the inverter due to overcurrent shut-off. When an MC is provided for switching to the commercial power supply, for example, switch it on/off after the inverter and motor have stopped.



## 1.2.7 Regarding the installation of the power factor improving reactor

When the inverter is installed near a large-capacity power transformer (500kVA or more with the wiring length of 10m or less) or the power capacitor is to be switched, an excessive peak current will flow in the power supply input circuit, damaging the converter circuit. In such a case, always install the power factor improving reactor (FR-BEL(-H) or FR-BAL(-H)).

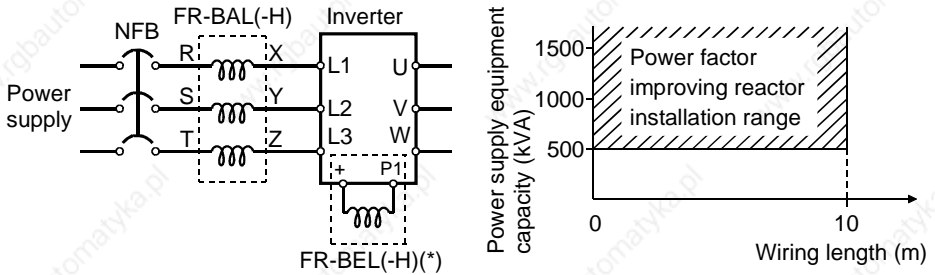

### REMARKS

\*When connecting the FR-BEL(-H), remove the jumper across terminals -P1.

The wiring length between the FR-BEL(-H) and the inverter should be 5m maximum and as short as possible.

Use the cables which are equal in size to those of the main circuit. (Refer to page 7)

## 1.2.8 Regarding noise and the installation of a noise filter

Some noise enters the inverter causing it to malfunction and others are generated by the inverter causing the malfunction of peripheral devices. Though the inverter is designed to be insusceptible to noise, it handles low-level signals, so it requires the following general countermeasures to be taken.

### (1) General countermeasures

- Do not run the power cables (I/O cables) and signal cables of the inverter in parallel with each other and do not bundle them.
- Use twisted shield cables for the detector connecting and control signal cables and connect the sheathes of the shield cables to terminal SD.
- Earth the inverter, motor, etc. at one point.
- Capacitances exist between the inverter's I/O wiring, other cables, earth and motor, through which leakage currents flow to cause the earth leakage circuit breaker, earth leakage relay and external thermal relay to operate unnecessarily. To prevent this, take appropriate measures, e.g. set the carrier frequency in Pr. 72 to a low value, use an earth leakage circuit breaker designed for suppression of harmonics and surges, and use the electronic thermal relay function built in the inverter.
- The input and output of the inverter main circuit include high-degree harmonics, which may disturb communication devices (AM radios) and sensors used near the inverter. In this case, install a FR-BIF(-H) optional radio noise filter (for use on the input side only) or FR-BSF01 line noise filter to minimize interference.

### <Noise reduction examples>

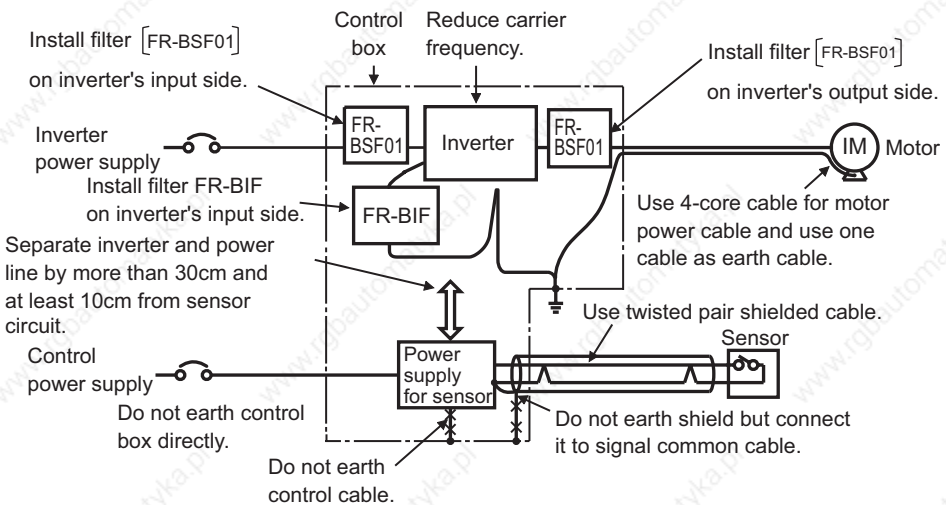

## 1.2.9 Earthing precautions

- Leakage currents flow in the inverter. To prevent an electric shock, the inverter and motor must be earthed. Earthing must conform to the requirements of national and local safety regulations and electrical codes.  
(JIS, NEC section 250, IEC 536 class 1 and other applicable standards)
- Use the dedicated earth terminal to earth the inverter. (Do not use the screw in the casing, chassis, etc.)  
Use a tinned\* crimping terminal to connect the earth cable. When tightening the screw, be careful not to damage the threads.  
\*Plating should not include zinc.
- Use the thickest possible earth cable. Use the cable whose size is equal to or greater than that indicated in the following table, and minimize the cable length.  
The earthing point should be as near as possible to the inverter.

Motor Capacity	Earth Cable Size (Unit: mm <sup>2</sup> )	
	200V class	400V class
2.2kW or less	2 (2.5)	2 (2.5)
3.7kW	3.5 (4)	2 (4)

For use as a product compliant with the Low Voltage Directive, use PVC cable whose size is indicated within parentheses.

- Earth the motor on the inverter side using one wire of the 4-core cable.

## 1.2.10 Power supply harmonics

The inverter may generate power supply harmonics from its converter circuit to affect the power generator, power capacitor etc. Power supply harmonics are different from noise and leakage currents in source, frequency band and transmission path. Take the following countermeasure suppression techniques.

● The following table indicates differences between harmonics and noise:

Item	Harmonics	Noise
Frequency	Normally 40th to 50th degrees or less (up to 3kHz or less)	High frequency (several 10kHz to 1GHz order)
Environment	To-electric channel, power impedance	To-space, distance, wiring path
Quantitative understanding	Theoretical calculation possible	Random occurrence, quantitative grasping difficult
Generated amount	Nearly proportional to load capacity	Change with current variation ratio (larger as switching speed increases)
Affected equipment immunity	Specified in standard per equipment	Different depending on maker's equipment specifications
Suppression example	Provide reactor.	Increase distance.

● Suppression technique

Harmonic currents produced on the power supply side by the inverter change with such conditions as whether there are wiring impedances and a power factor improving reactor (FR-BEL(-H) or FR-BAL(-H)) and the magnitudes of output frequency and output current on the load side.

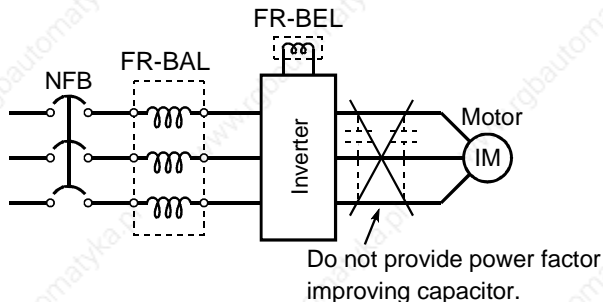

For the output frequency and output current, we understand that they should be calculated in the conditions under the rated load at the maximum operating frequency.

### CAUTION

The power factor improving capacitor and surge suppressor on the inverter output side may be overheated or damaged by the harmonic components of the inverter output. Also, since an excessive current flows in the inverter to activate overcurrent protection, do not provide a capacitor and surge suppressor on the inverter output side when the motor is driven by the inverter. To improve the power factor, insert a power factor improving reactor on the inverter's primary side or DC circuit. For full information, refer to page 15.

## 1.2.11 Inverter-driven 400V class motor

In the PWM type inverter, a surge voltage attributable to wiring constants is generated at the motor terminals. Especially for a 400V class motor, the surge voltage may deteriorate the insulation. When the 400V class motor is driven by the inverter, consider the following measures:

- Measures

It is recommended to take either of the following measures:

### (1) Rectifying the motor insulation

For the 400V class motor, use an insulation-enhanced motor. Specifically

- 1) Specify the "400V class inverter-driven, insulation-enhanced motor".
- 2) For the dedicated motor such as the constant-torque motor and low-vibration motor, use the "inverter-driven, dedicated motor".

---

### CAUTION

---

**When the wiring length between the motor and inverter is 40m or more, take the above countermeasure and also set the long wiring mode in Pr. 70 "Soft-PWM setting". (Refer to page 101 for Pr. 70.)**

---

### (2) Suppressing the surge voltage on the inverter side

On the secondary side of the inverter, connect the optional surge voltage suppression filter (FR-ASF-H).

## 1.3 How to use the control circuit terminals

### 1.3.1 Terminal block layout

In the control circuit of the inverter, the terminals are arranged as shown below:

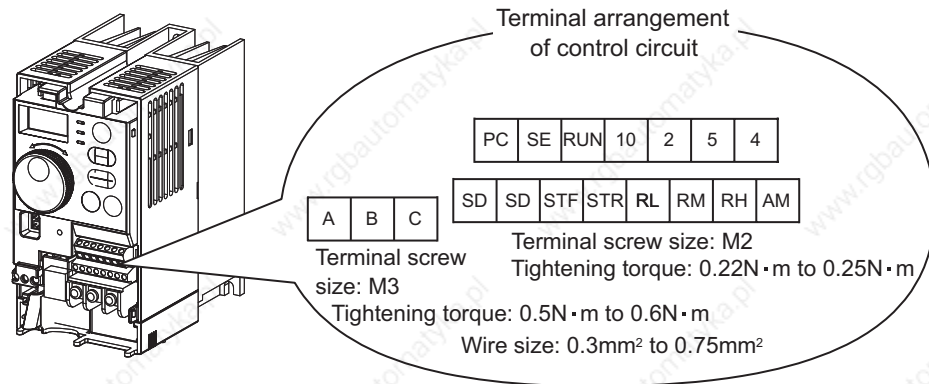

### 1.3.2 Wiring instructions

- 1) Terminals PC, SE and 5 are common to the I/O signals isolated from each other. Do not earth them.
- 2) Use shielded or twisted cables for connection to the control circuit terminals and run them away from the main and power circuits (including the 200V relay sequence circuit).
- 3) The input signals to the control circuit are micro currents. When contacts are required, use two or more parallel micro signal contacts or a twin contact to prevent a contact fault.

### 1.3.3 Changing the control logic

The input signals are set to source logic.

To change the control logic, the jumper connector under the setting dial must be moved to the other position.

- Change the jumper connector position using tweezers, a pair of long-nose pliers etc. Change the jumper connector position before switching power on.

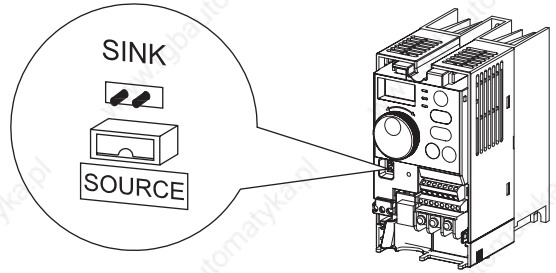

#### CAUTION

- Make sure that the front cover is installed securely.
- The front cover is fitted with the capacity plate and the inverter unit with the rating plate. Since these plates have the same serial numbers, always replace the removed cover onto the original inverter.
- The sink-source logic change-over jumper connector must be fitted in only one of those positions. If it is fitted in both positions at the same time, the inverter may be damaged.

#### 1) Source logic type

- In this logic, a signal switches on when a current flows into the corresponding signal input terminal.

Terminal PC is common to the contact input signals. For the open collector output signals, terminal SE is a positive external power supply terminal.

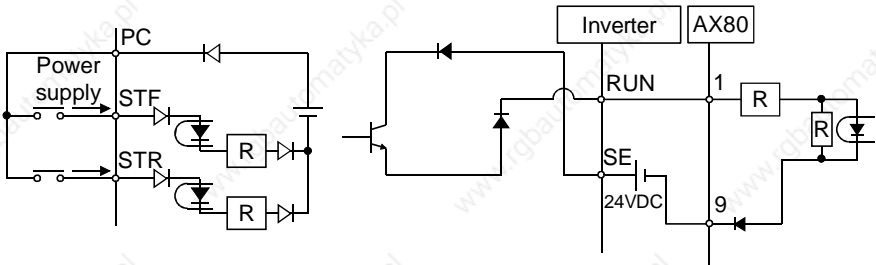

- Connecting the 0V terminal of the external power supply for transistor output to terminal SD prevents a malfunction caused by an undesirable current.

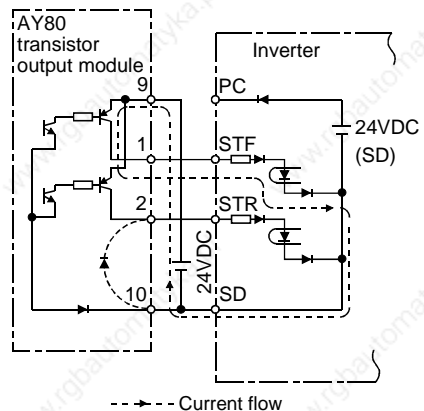

1  
WIRING

2) Sink logic type

- In this logic, a signal switches on when a current flows from the corresponding signal input terminal. Terminal SD is common to the contact input signals. Terminal SE is common to the open collector output signals.

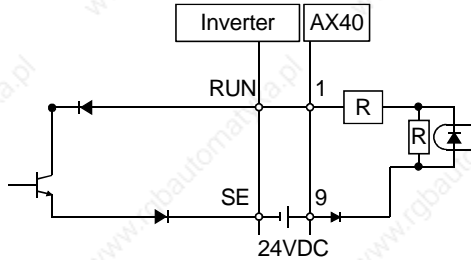
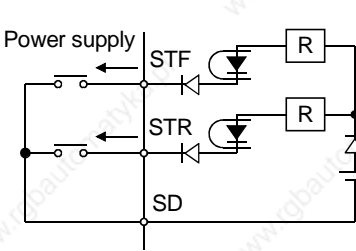

- Connecting a positive terminal of the external power supply for transistor output to terminal PC prevents a malfunction caused by an undesirable current. (Do not connect terminal SD of the inverter with terminal 0V of the external power supply. When using terminals PC-SD as a 24VDC power supply, do not install an external power supply in parallel with the inverter. Doing so may cause a malfunction in the inverter due to an undesirable current.)

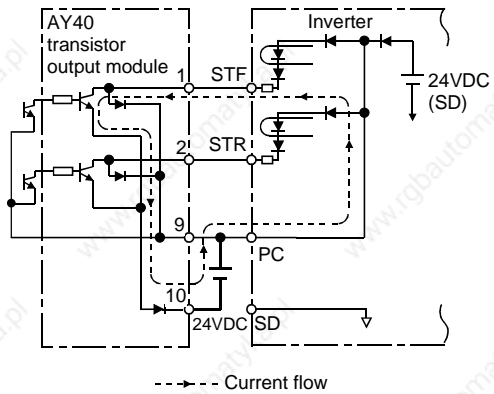



## 1.4 Input terminals

### 1.4.1 Run (start) and stop (STF, STR, STOP)

To start and stop the motor, first switch on the input power supply of the inverter (switch on the magnetic contactor, if any, in the input circuit during preparation for operation), then start the motor with the forward or reverse rotation start signal.

#### (1) Two-wire type connection (STF, STR)

A two-wire type connection is shown on the right.

- 1) The forward/reverse rotation signal is used as both the start and stop signals. Switch on either of the forward and reverse rotation signals to start the motor in the corresponding direction. Switch on both or switch off the start signal during operation to decelerate the inverter to a stop.
- 2) The frequency setting signal may either be given by entering 0 to 5VDC (or 0 to 10VDC) across frequency setting input terminals 2-5 or by setting the required values in Pr. 4 to Pr. 6 "multi-speed setting" (high, middle, low speeds). (For multi-speed operation, refer to page 27.)

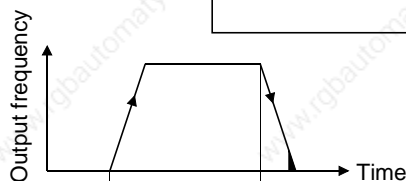
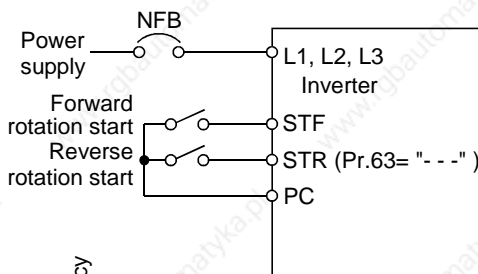

Across STF-PC (STR) 2-wire type connection example

- 3) After the start signal has been input, the inverter starts operating when the frequency setting signal reaches or exceeds the "starting frequency" set in Pr. 13 (factory-set to 0.5Hz).

If the motor load torque is large or the "torque boost" set in Pr. 0 is small, operation may not be started due to insufficient torque until the inverter output frequency reaches about 3 to 6Hz.

If the "minimum frequency" set in Pr. 2 (factory setting = 0Hz) is 6Hz, for example, merely entering the start signal causes the running frequency to reach the minimum frequency of 6Hz according to the "acceleration time" set in Pr. 7.

- 4) To stop the motor, operate the DC injection brake for the period of "DC injection brake operation time" set in Pr. 11 (factory setting = 0.5s) at not more than the DC injection brake operation frequency or at not more than 0.5Hz.

To disable the DC injection brake function, set 0 in either of Pr. 11 "DC injection brake operation time" or Pr. 12 "DC injection brake voltage".

In this case, the motor is coasted to a stop at not more than the frequency set in Pr. 10 "DC injection brake operation frequency" (0 to 120Hz variable) or at not more than 0.5Hz (when the DC injection brake is not operated).

- 5) If the reverse rotation signal is input during forward rotation or the forward rotation signal is input during reverse rotation, the inverter is decelerated and then switched to the opposite output without going through the stop mode.

## (2) Three-wire type connection (STF, STR, STOP)

A three-wire type connection is shown on the right. Assign the start self-holding signal (STOP) to any of the input terminals. To make a reverse rotation start, set Pr. 63 to "-" (factory setting).

1) Short the signals STOP-PC to enable the start self-holding function. In this case, the forward/reverse rotation signal functions only as a start signal.  
(Note) Assign the stop signal to any of Pr. 60 to Pr. 62 (input terminal function selection).

2) If the start signal terminals STF (STR)-PC are shorted once, then opened, the start signal is kept on and starts the inverter. To change the rotation direction, short the start signals STR (STF)-PC once, then open it.

3) The inverter is decelerated to a stop by opening the signals STOP-PC once. For the frequency setting signal and the operation of DC injection brake at a stop time, refer to paragraphs 2) to 4) in (1) Two-wire type connection. The right diagram shows 3-wire type connection.

4) When the signals JOG-PC are shorted, the STOP signal is invalid and the JOG signal has precedence.

5) If the output stop signals MRS-PC are shorted, the self-holding function is not deactivated.

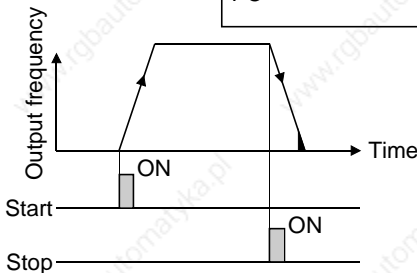
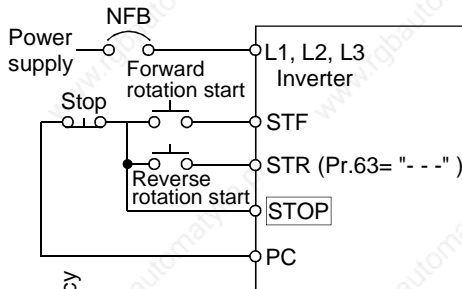

3-wire type connection example

### DC Injection Brake and Coasting to Stop Functionality

Operation Mode	External Operation or Combined Operation Pr. 79 = "0", "2", "3"		PU Operation or Combined Operation Pr. 79 = "0", "1", "4"	
	Terminals STF (STR)-PC disconnected (*1)	Set frequency changed to 0Hz	Stop key	Set frequency changed to 0Hz
<b>DC Injection Brake</b>				
<b>DC injection brake enabled</b>	DC injection brake operated at not more than "DC injection brake operation frequency" set in Pr. 10	DC injection brake operated at 0.5Hz or less.	DC injection brake operated at not more than "DC injection brake operation frequency" set in Pr. 10	DC injection brake operated at 0.5Hz or less.
<b>DC injection brake disabled</b>	Coasted to a stop at not more than "DC injection brake operation frequency" set in Pr. 10	Coasted to a stop at 0.5Hz or less.	Coasted to a stop at not more than "DC injection brake operation frequency" set in Pr. 10	Coasted to a stop at 0.5Hz or less.

\*1: Also stopped by the . Refer to page 103.

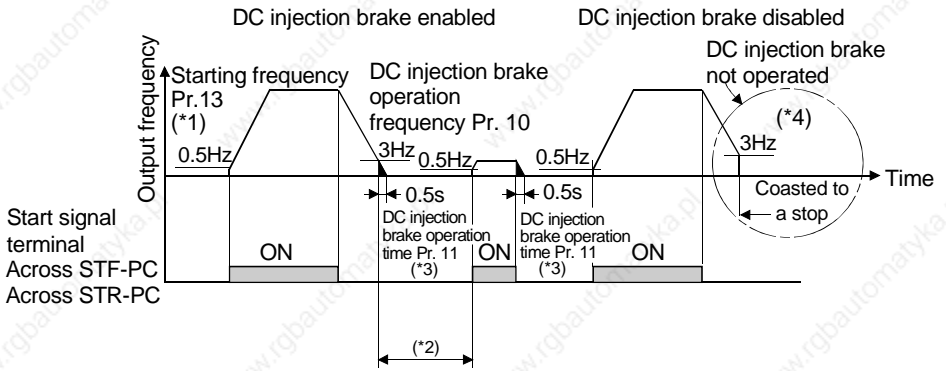

Start/Stop Timing Chart (for two-wire type)

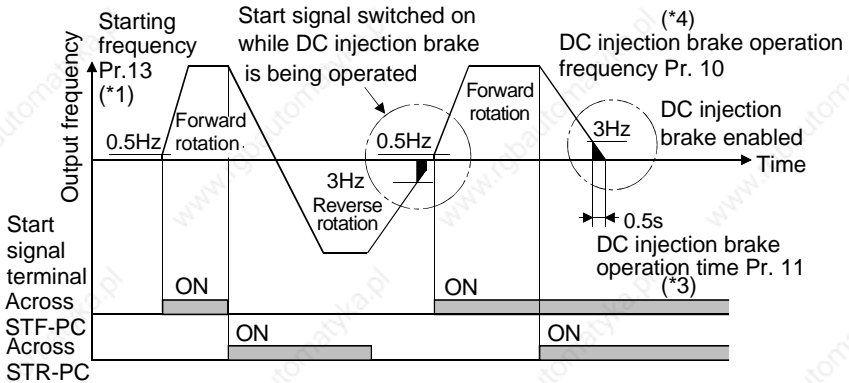

Forward-Reverse Rotation Switch-Over Timing Chart

**REMARKS**

- \*1. The "starting frequency" in Pr. 13 (factory-set to 0.5Hz) may be set between 0 and 60Hz.
- \*2. If the next start signal is given during DC injection brake operation, the DC injection brake is disabled and restart is made.
- \*3. The "DC injection brake operation time" in Pr. 11 (factory-set to 0.5s) may be set between 0 and 10s.
- \*4. The frequency at which the motor is coasted to a stop is not more than the "DC injection brake operation frequency" set in Pr. 10 (factory setting = 3Hz; may be set between 0 and 120Hz) or not more than 0.5Hz.
- \*5. The "starting frequency" in Pr. 13, "DC injection brake operation time" in Pr. 11 and "DC injection brake operation frequency" in Pr. 10 are the factory-set values.

### 1.4.2 Connection of frequency setting potentiometer and output frequency meter (10, 2, 5, 4, AU)

The analog frequency setting input signals that may be entered are voltage and current signals.

For the relationships between the frequency setting input voltages (currents) and output frequencies, refer to the following diagram. The frequency setting input signals are proportional to the output frequencies. Note that when the input signal is less than the starting frequency, the output frequency of the inverter is 0Hz.

If the input signal of 5VDC (or 10V, 20mA) or higher is entered, the output frequency does not exceed the maximum output frequency.

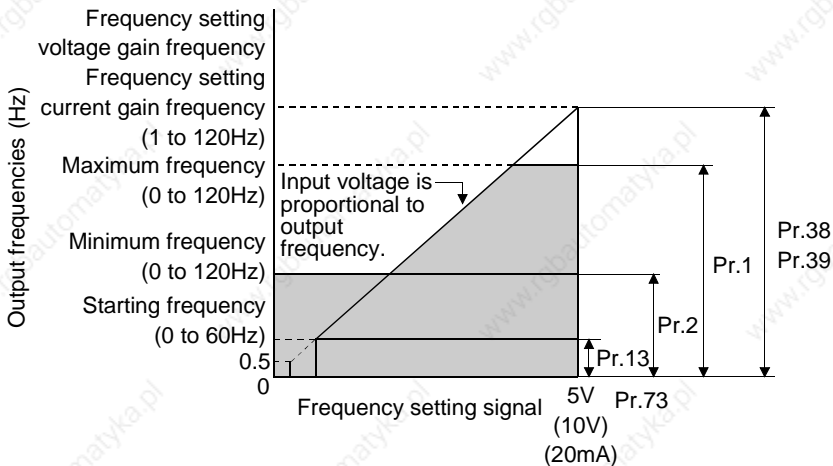

#### Relationships between Frequency Setting Inputs and Output Frequencies

##### REMARKS

For the way to calibrate the output frequency meter, refer to page 124.

#### (1) Voltage input (10, 2, 5)

Enter the frequency setting input signal of 0 to 5VDC (or 0 to 10VDC) across the frequency setting input terminals 2-5. The maximum output frequency is reached when 5V (10V) is input across terminals 2-5.

The power supply used may either be the inverter's built-in power supply or an external power supply. For the built-in power supply, terminals 10-5 provide 5VDC output.

- For operation at 0 to 5VDC, set "0" in Pr. 73 to the 0 to 5VDC input. Use terminal 10 for the built-in power supply.

- For operation at 0 to 10VDC, set "1" in Pr. 73 to the 0 to 10VDC input.

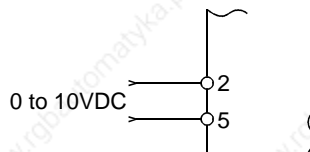
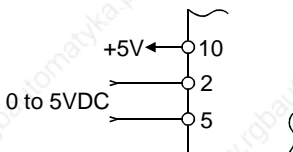

## (2) Current input (4, 5, AU)

To automatically perform operation under constant pressure or temperature control using a fan, pump etc., enter the controller output signal of 4 to 20mADC across terminals 4-5.

Terminals AU-PC must be shorted to use the 4 to 20mADC signal for operation. (Assign the signal AU using any of Pr. 60 to Pr. 63.)

When the multi-speed signal is input, the current input is ignored.

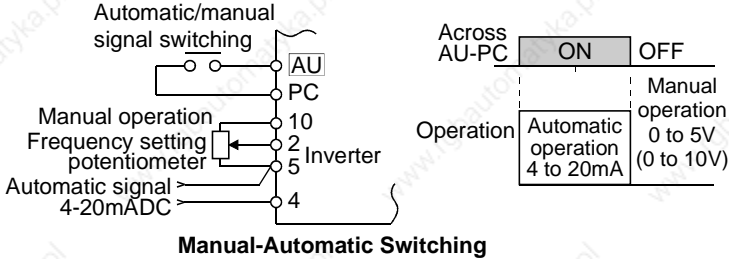

### 1.4.3 External frequency selection (REX, RH, RM, RL)

Up to 15 speeds (\*) may be selected for an external command forward rotation start or up to 7 speeds for an external command reverse rotation start according to the combination of connecting the multi-speed select terminals REX, RH, RM and RL-PC, and multi-speed operation can be performed as shown below by shorting the start signal terminal STF (STR)-PC.

Speeds (frequencies) may be specified as desired from the operation panel or parameter unit as listed below.

#### CAUTION

- \* Change the setting of Pr. 63 "STR terminal function selection" to "8", and assign and use as the 15-speed select signal (REX).  
Has precedence over the main speed setting signal (0 to 5V, 0 to 10V, 4 to 20mADC).

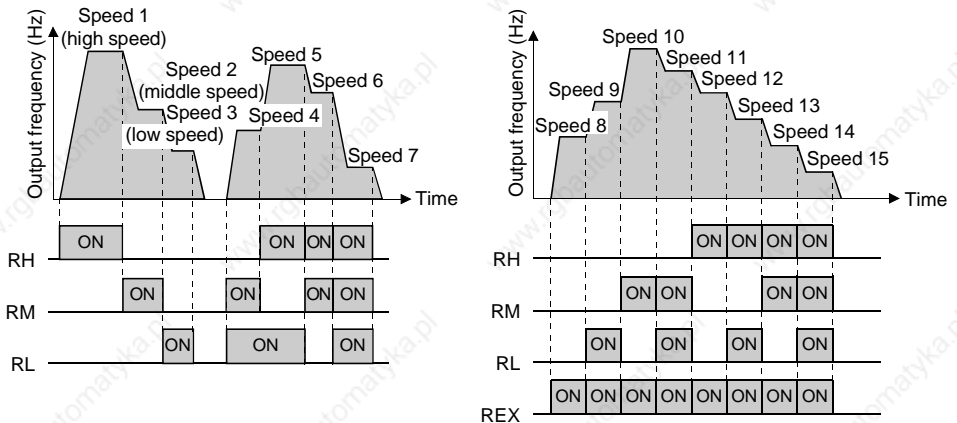

1  
WIRING

### Multi-Speed Setting

Speed	Terminal Input				Parameter	Set Frequency Range	Remarks	
	REX-PC*	RH-PC	RM-PC	RL-PC*				
Speed 1 (high speed)	OFF	<input type="checkbox"/>	OFF	OFF	Pr. 4	0 to 120Hz	_____	
Speed 2 (middle speed)	OFF	OFF	<input type="checkbox"/>	OFF	Pr. 5	0 to 120Hz	_____	
Speed 3 (low speed)	OFF	OFF	OFF	<input type="checkbox"/>	Pr. 6	0 to 120Hz	_____	
Speed 4	OFF	OFF	<input type="checkbox"/>	<input type="checkbox"/>	Pr. 24	0 to 120Hz, - - -	Pr. 6 setting when Pr. 24=" - - -"	
Speed 5	OFF	<input type="checkbox"/>	OFF	<input type="checkbox"/>	Pr. 25		Pr. 6 setting when Pr. 25=" - - -"	
Speed 6	OFF	<input type="checkbox"/>	<input type="checkbox"/>	OFF	Pr. 26		Pr. 5 setting when Pr. 26=" - - -"	
Speed 7	OFF	<input type="checkbox"/>	<input type="checkbox"/>	<input type="checkbox"/>	Pr. 27		Pr. 6 setting when Pr. 27=" - - -"	
Speed 8	<input type="checkbox"/>	OFF	OFF	OFF	Pr. 80		0Hz when Pr. 80=" - - -"	
Speed 9	<input type="checkbox"/>	OFF	OFF	<input type="checkbox"/>	Pr. 81		Pr. 6 setting when Pr. 81=" - - -"	
Speed 10	<input type="checkbox"/>	OFF	<input type="checkbox"/>	OFF	Pr. 82		Pr. 5 setting when Pr. 82=" - - -"	
Speed 11	<input type="checkbox"/>	OFF	<input type="checkbox"/>	<input type="checkbox"/>	Pr. 83		Pr. 6 setting when Pr. 83=" - - -"	
Speed 12	<input type="checkbox"/>	<input type="checkbox"/>	OFF	OFF	Pr. 84		Pr. 4 setting when Pr. 84=" - - -"	
Speed 13	<input type="checkbox"/>	<input type="checkbox"/>	OFF	<input type="checkbox"/>	Pr. 85		Pr. 6 setting when Pr. 85=" - - -"	
Speed 14	<input type="checkbox"/>	<input type="checkbox"/>	<input type="checkbox"/>	OFF	Pr. 86		Pr. 5 setting when Pr. 86=" - - -"	
Speed 15	<input type="checkbox"/>	<input type="checkbox"/>	<input type="checkbox"/>	<input type="checkbox"/>	Pr. 87		Pr. 6 setting when Pr. 87=" - - -"	
External setting	OFF	OFF	OFF	OFF	Frequency setting potentiometer		0 to max. setting	_____

\*When using the REX signal, an external command cannot be used to make a reverse rotation start.

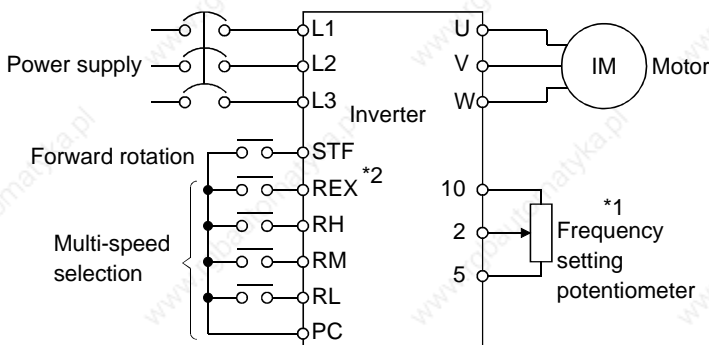

Multi-Speed Operation Connection Example

#### REMARKS

- \*1. When the frequency setting potentiometer is connected, the input signal of the frequency setting potentiometer is ignored if the multi-speed select signal is switched on. (This also applies to the 4 to 20mA input signal.)
- \*2. For a reverse rotation start, set Pr. 63 to " - - -" (factory setting) to make the STR signal of terminal STR valid.

### 1.4.4 Indicator connection and adjustment (AM)

A full-scale 5VDC analog signal can be output from across terminals AM-5.

The analog output level can be calibrated by the operation panel or parameter unit (FR-PU04). Terminal AM function selection can be set in Pr. 54 "AM terminal function selection".

Terminal AM is isolated from the control circuit of the inverter. The cable length should not exceed 30m.

The output signal from terminal AM delays about several 100ms in output and therefore cannot be used as a signal for control which requires fast response.

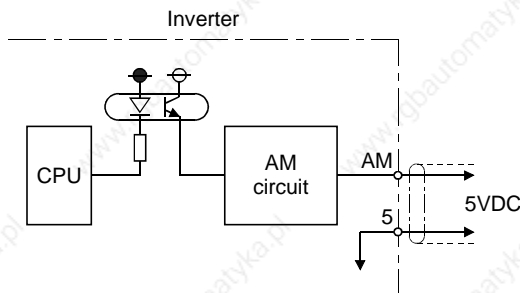
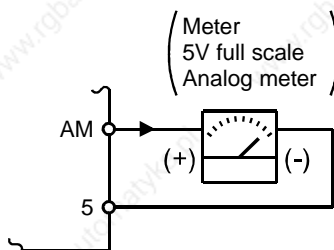

Terminal AM Output Circuit

#### Adjustment

Set the reference output value of the inverter which outputs the full-scale voltage 5VDC.

Set it in Pr. 55 for frequency monitoring reference, or in Pr. 56 for current monitoring reference.

Use the terminal AM output calibration parameter C1 to adjust the output voltage.

- [Example]
- To set the output across AM-5 to 5VDC at the inverter output frequency of 90Hz, set 90Hz in Pr. 55. (Factory setting: 50Hz)
  - To set the output across AM-5 to 5VDC at the inverter output current of 20A, set 20A in Pr. 56. (Factory setting: rated inverter current)

#### CAUTION

•Refer to page 124 for the procedure of indicator adjustment.

### 1.4.5 Control circuit common terminals (PC, 5, SE)

Terminals PC, 5, and SE are all common terminals for I/O signals and are isolated from each other.

Terminal PC is a common terminal for the contact input terminals (STF, STR, RH, RM, RL).

Terminal 5 is a common terminal for the frequency setting analog input signals and indicator terminal "AM". It should be protected from external noise using a shielded or twisted cable.

Terminal SE is a common terminal for the open collector output terminal (RUN).

### 1.4.6 Signal inputs by contactless switches

If a transistor is used instead of a contacted switch as shown on the right, the input signals of the inverter can control terminals STF, STR, RH, RM, RL.

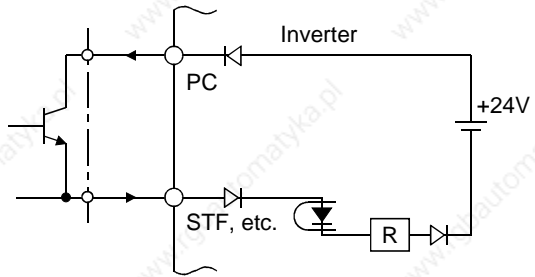

External signal input using transistor

#### REMARKS

1. When using an external transistor connected to an external power supply, use terminal PC to prevent a malfunction from occurring due to a leakage current. (Refer to page 21.)
2. Note that an SSR (solid-state relay) has a relatively large leakage current at OFF time and it may be accidentally input to the inverter.



## 1.5 How to use the input signals (assigned terminals RL, RM, RH, STR)

These terminals can be changed in function by setting Pr. 60 to Pr. 63.

Pr. 60 "RL terminal function selection"	Page 96
Pr. 61 "RM terminal function selection"	
Pr. 62 "RH terminal function selection"	
Pr. 63 "STR terminal function selection"	

### 1.5.1 Multi-speed setting (RL, RM, RH, REX signals):

Pr. 60 to Pr. 63 setting "0, 1, 2, 8"

#### Remote setting (RL, RM, RH signals):

Pr. 60 to Pr. 63 setting "0, 1, 2"

- By entering frequency commands into the RL, RM, RH and REX signals and turning on/off the corresponding signals, you can perform multi-speed operation (15 speeds). (For details, refer to page 27.)
- If the operation panel is away from the control box, you can perform continuous variable-speed operation with signal contacts, without using analog signals. (For details, refer to page 93.)

### 1.5.2 Second function selection (RT signal): Pr. 60 to Pr. 63 setting "3"

Pr. 44 "second acceleration/deceleration time"

Pr. 45 "second deceleration time"

Pr. 46 "second torque boost"

Pr. 47 "second V/F (base frequency)"

To set any of the above functions, turn on this "RT signal".

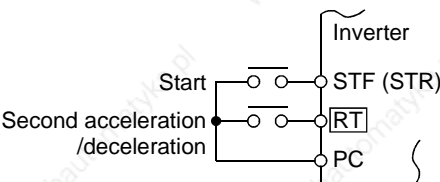

### 1.5.3 Current input selection "AU signal": Pr. 60 to Pr. 63 setting "4"

When a fan, pump etc. is used to perform operation of constant- pressure/ temperature control, automatic operation can be performed by entering the 4-20mADC output signal of a regulator into across terminals 4-5.

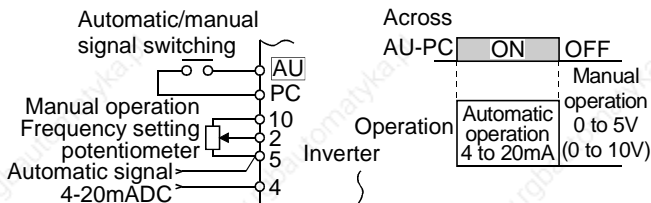

When the 4-20mADC signal is used to perform operation, always short the AU signal.

#### REMARKS

The current input is ignored if the multi-speed signal is input.

### 1.5.4 Start self-holding selection (STOP signal): Pr. 60 to Pr. 63 setting "5"

This connection example is used when you want to self-hold the start signal (forward rotation, reverse rotation).

\* Connected to the STOP signal to avoid forward or reverse rotation if forward or reverse rotation and stop are turned on simultaneously.

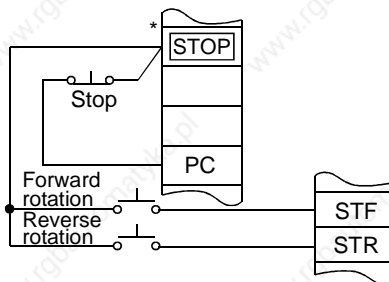

(Wiring example for sink logic)

### 1.5.5 Output shut-off (MRS signal): Pr. 60 to Pr. 63 setting "6"

Short the output stop terminal MRS-PC during inverter output to cause the inverter to immediately stop the output. Open terminals MRS-PC to resume operation in about 10ms. Terminal MRS may be used as described below:

#### (1) To stop the motor by mechanical brake (e.g. electromagnetic brake)

Terminals MRS-PC must be shorted when the mechanical brake is operated and be opened before motor restart.

#### (2) To provide interlock to disable operation by the inverter

After MRS-PC have been shorted, the inverter cannot be operated if the start signal is given to the inverter.

#### (3) To coast the motor to stop

The motor is decelerated according to the preset deceleration time and is stopped by operating the DC injection brake at 3Hz or less. By using terminal MRS, the motor is coasted to a stop.

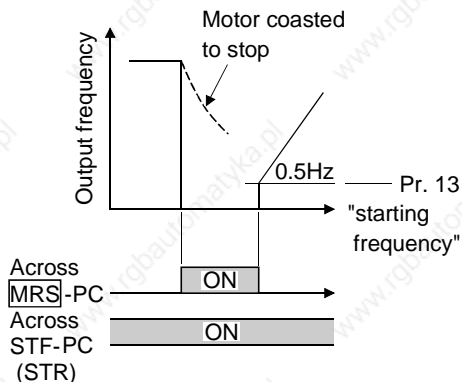

### 1.5.6 External thermal relay input: Pr. 60 to Pr. 63 setting "7"

When the external thermal relay or thermal relay built in the motor is actuated, the inverter output is shut off and an alarm signal is given to keep the motor stopped to protect the motor from overheat. Even if the thermal relay contact resets, the motor cannot be restarted unless the reset terminals RES-PC are shorted for more than 0.1s and then opened or a power-on reset is made. The function may therefore be used as an external emergency stop signal input.

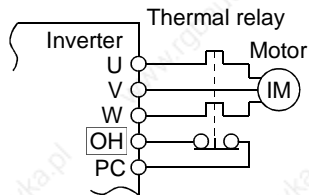

### 1.5.7 Jog operation (JOG signal): Pr. 60 to Pr. 63 setting "9"

#### (1) Jog operation using external signals

Jog operation can be started/stopped by shorting the jog mode select terminals JOG-PC and shorting/opening the start signal terminals STF or STR-PC. The jog frequency and jog acceleration/deceleration time are set in Pr. 15 (factory setting 5Hz, variable between 0 and 120Hz) and Pr. 16 (factory setting 0.5s, variable between 0 and 999s), respectively, and their settings can be changed from the operation panel or parameter unit.

The JOG signal has precedence over the multi-speed signal. (External)

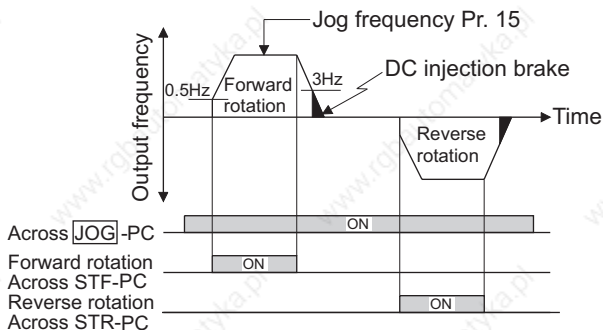

### 1.5.8 Reset signal: Pr. 60 to Pr. 63 setting "10"

Used to reset the alarm stop state established when the inverter's protective function is activated. The reset signal immediately sets the control circuit to the initial (cold) status, e.g. initializes the electronic thermal relay function protection circuit. It shuts off the inverter output at the same time. During reset, the inverter output is kept shut off. To give this reset input, short terminals RES-PC for more than 0.1s. When the shorting time is long, the operation panel or parameter unit displays the initial screen, which is not a fault.

After opening terminals RES-PC (about 1s), operation is enabled.

The reset terminal is used to reset the inverter alarm stop state. If the reset terminal is shorted, then opened while the inverter is running, the motor may be restarted during coasting (refer to the timing chart below) and the output may be shut off due to overcurrent or overvoltage.

Setting either "1" or "15" in reset selection Pr. 75 allows the accidental input of the reset signal during operation to be ignored.

(For details, refer to page 103.)

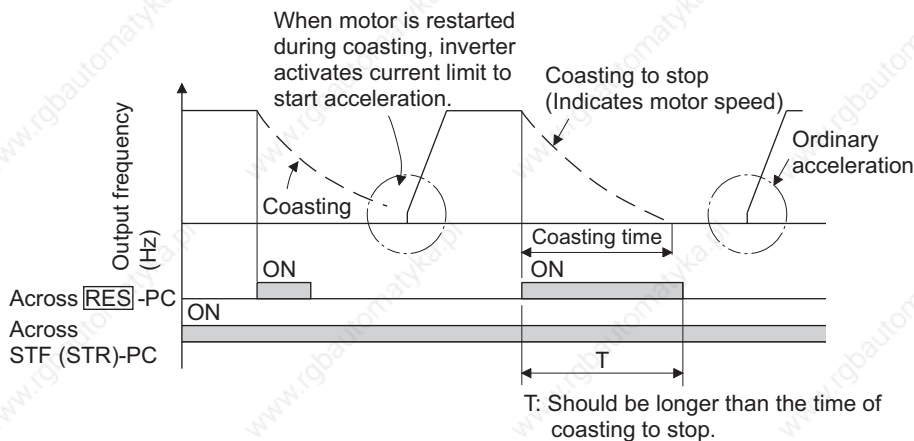

#### CAUTION

**Frequent resetting will make electronic thermal relay function invalid.**

### 1.5.9 PID control valid terminal: Pr. 60 to Pr. 63 setting "14"

To exercise PID control, turn on the X14 signal. When this signal is off, ordinary inverter operation is performed. For more information, refer to page 111.

#### ◆Related parameters◆

Pr. 88 "PID action selection", Pr. 89 "PID proportional band", Pr. 90 "PID integral time", Pr. 91 "PID upper limit", Pr. 92 "PID lower limit", Pr. 93 "PID action set point for PU operation", Pr. 94 "PID differential time" (Refer to page 111.)

### 1.5.10 PU operation/external operation switchover: Pr. 60 to Pr. 63 setting "16"

You can change the operation mode.

With "8" set in Pr. 79 "operation mode selection", turning on the X16 signal shifts the operation mode to the external operation mode and turning off the X16 signal shifts it to the PU operation mode. For details, refer to page 107.

#### ◆Related parameters◆

Pr. 79 "operation mode selection" (Refer to page 107.)

## 1.6 Connection to the Stand-Alone Option

The inverter accepts a variety of stand-alone option units as required. Incorrect connection will cause inverter damage or accident. Connect and operate the option unit carefully in accordance with the corresponding option unit manual.

### 1.6.1 Connection of the brake unit (BU type)

Connect the BU type brake unit correctly as shown below. Incorrect connection will damage the inverter. Remove jumpers across terminals HB-PC and TB-HC and connect a jumper across terminals PC-TB of the brake unit.

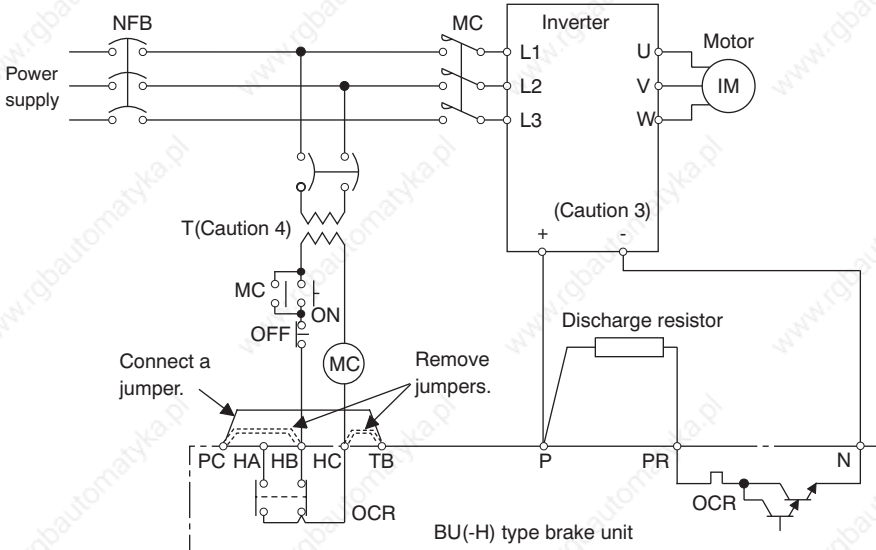

### CAUTION

1. The wiring distance between the inverter, brake unit and discharge resistor should be within 2m. If twisted wires are used, the distance should be within 5m.
2. If the transistors in the brake unit should become faulty, the resistor can be unusually hot, causing a fire. Therefore, install a magnetic contactor on the inverter's power supply side to shut off a current in case of fault.
3. When the power supply is 400V class, install a step-down transformer.

## 1.6.2 Connection of the high power factor converter (FR-HC)

When connecting the high power factor converter (FR-HC) to suppress power supply harmonics, perform wiring securely as shown below. Incorrect connection will damage the high power factor converter and inverter.

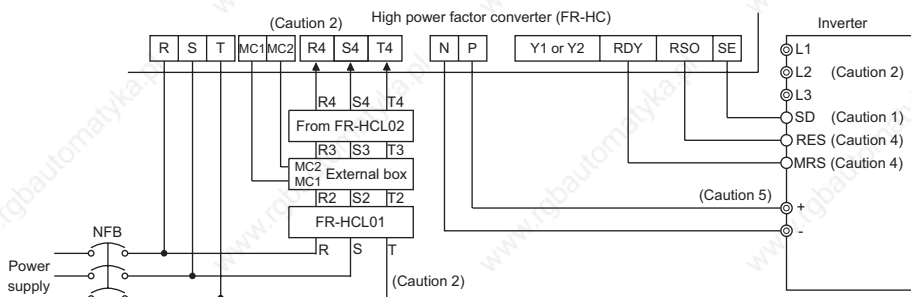

### CAUTION

1. Use sink logic when the FR-HC is connected. The FR-HC cannot be connected when source logic (factory setting) is selected.
2. The power input terminals L1, L2, L3 must be open. Incorrect connection will damage the inverter. Opposite polarity of terminals -, + will damage the inverter.
3. The voltage phases of terminals L1, L2, L3 and terminals R4, S4, T4 must be matched before connection.
4. Use Pr. 60 to Pr. 63 (input terminal function selection) to assign the terminals used for the RES and MRS signals.
5. Do not insert NFB between terminals P-N (P -, N -)

### 1.6.3 Connection of the power regeneration common converter (FR-CV)

When connecting the FR-CV type power regeneration common converter, connect the inverter terminals (+, -) and FR-CV type power regeneration common converter terminals as shown below so that their signals match with each other.

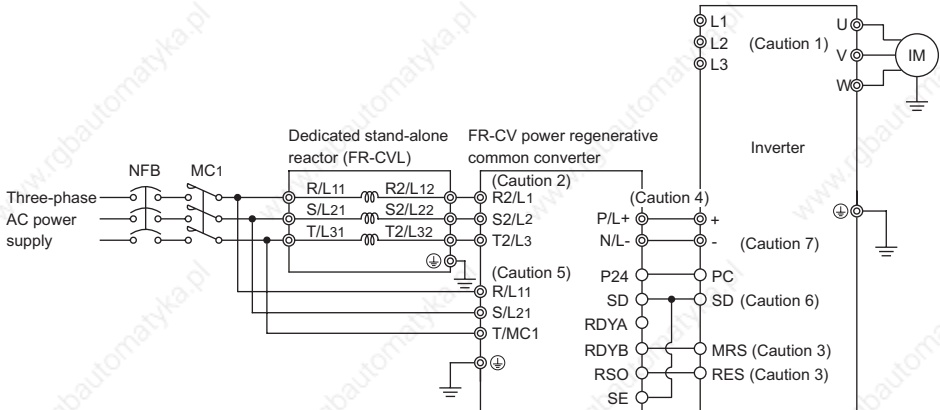

#### CAUTION

1. Use sink logic when the FR-CV is connected. The FR-CV cannot be connected when source logic (factory setting) is selected.
2. The power input terminals L1, L2, L3 must be open. Incorrect connection will damage the inverter. Opposite polarity of terminals -, + will damage the inverter.
3. The voltage phases of terminals R/L11, S/L21, T/MC1 and terminals R2/L1, S2/L2, T2/L3 must be matched before connection.
4. Use Pr. 60 to Pr. 63 (input terminal function selection) to assign the terminals used for the RES and MRS signals.
5. Do not insert NFB between terminals P-N (P/L+ - +, N/L- - -)
6. Make sure to connect the terminal R/L11, S/L21, T/MC1 to the power supply. Running the inverter without connecting the terminals will damage the power regeneration common converter.



## 1.7 Handling of the RS-485 connector

<RS-485 connector pin layout>

View A of the inverter (receptacle side)

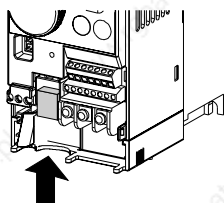

View A



View A

- |          |        |
|----------|--------|
| 1) SG    | 5) SDA |
| 2) P5S   | 6) RDB |
| 3) RDA   | 7) SG  |
| 8) to 1) | 4) SDB |
|          | 8) P5S |

### CAUTION

- Do not plug the connector to a computer LAN port, fax modem socket, telephone modular connector etc.. The product could be damaged due to differences in electrical specifications.
- Pins 2 and 8 (P5S) are provided for the parameter unit power supply. Do not use them for any other purpose or when making parallel connection by RS-485 communication.
- Refer to page 130 for the communication parameters.

### 1.7.1 Connection of the parameter unit (FR-PU04)

When connecting the parameter unit to the RS-485 connector, use the optional parameter unit connection cable (FR-CB2□□).

### CAUTION

When the parameter unit is used, the operation other than the stop key

() of the operation panel is disabled.

☞ Refer to page 149 for the parameters related to parameter unit setting.

## 1.7.2 Wiring of RS-485 communication

Use the RS-485 connector to perform communication operation from a personal computer etc.

When the RS-485 connector is connected with a personal, FA or other computer by a communication cable, a user program can run and monitor the inverter or read and write to the parameters. For parameter setting, refer to page 128.

- Conforming standard: EIA-485 (RS-485)
- Transmission format: Multidrop link system
- Communication speed: Max. 19200bps
- Overall extension: 500m

☞ Refer to page 128 for the setting related to RS-485 communication operation.

### <System configuration examples>

#### (1) Connection of a computer to the inverter (1:1 connection)

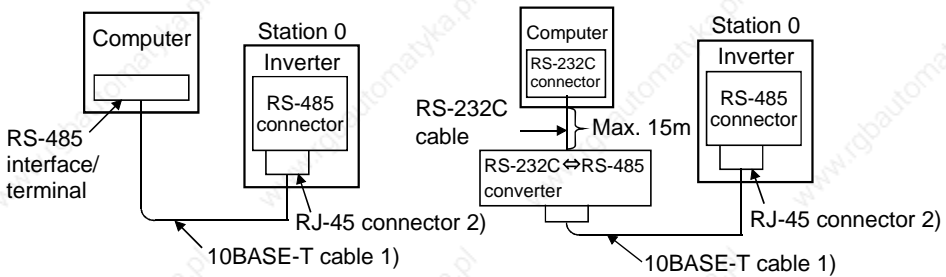

#### ● Computer-inverter connection cable

Refer to the following for the cable (RS-232C↔RS-485 converter) for connection of the computer having the RS-232C interface with the inverter.

Example of product available on the market (as of April, 2004)

Model	Maker
FA-T-RS40□*	Mitsubishi Electric Engineering Co., Ltd.

\*The converter cable cannot connect two or more inverters (the computer and inverter are connected on a 1:1 basis). Since the product is packed with the RS-232C cable and RS-485 cable (10BASE-T + RJ-45 connector), the cable and connector need not be prepared separately.

#### REMARKS

Refer to the following when fabricating the cable on the user side.

Example of product available on the market (as of April, 2004)

	Product	Model	Maker
1)	10BASE-T cable	SGLPEV-T 0.5mm × 4P * Do not use pins No. 2, 8 (P5S).	Mitsubishi Cable Industries, Ltd.
2)	RJ-45 connector	5-554720-3	Tyco Electronics Corporation

## (2) Combination of computer and multiple inverters (1:n connection)

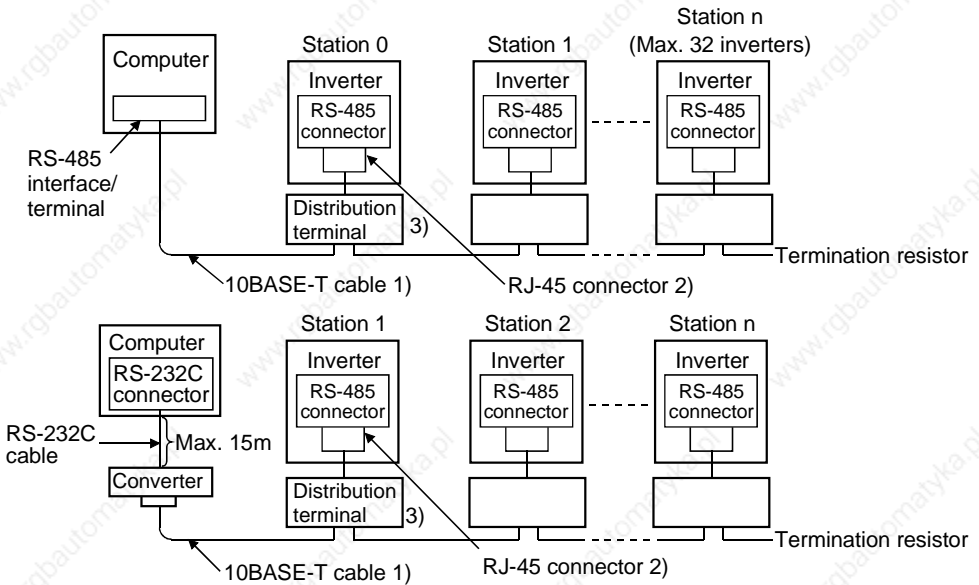

### REMARKS

Refer to the following when fabricating the cable on the user side.  
 Example of product available on the market (as of April, 2004)

	Product	Model	Maker
1)	10BASE-T cable	SGLPEV-T 0.5mm × 4P*	Mitsubishi Cable Industries, Ltd.
2)	RJ-45 connector	5-554720-3	Tyco Electronics Corporation

\* Do not use pins No. 2, 8 (P5S) of the 10BASE-T cable.

### <Wiring methods>

#### 1) Wiring of one RS-485 computer and one inverter

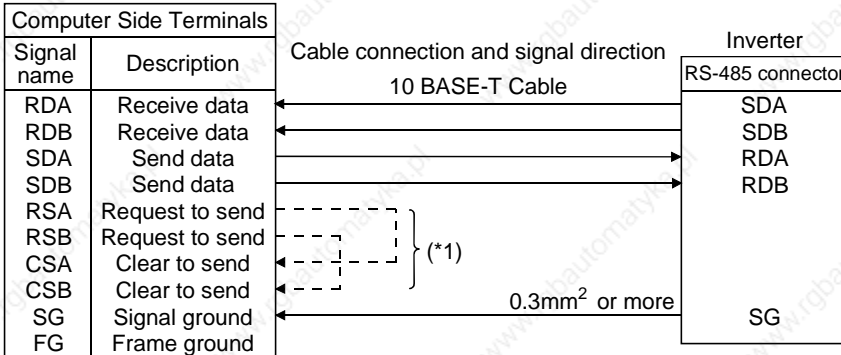

#### 2) Wiring of one RS-485 computer and "n" inverters (several inverters)

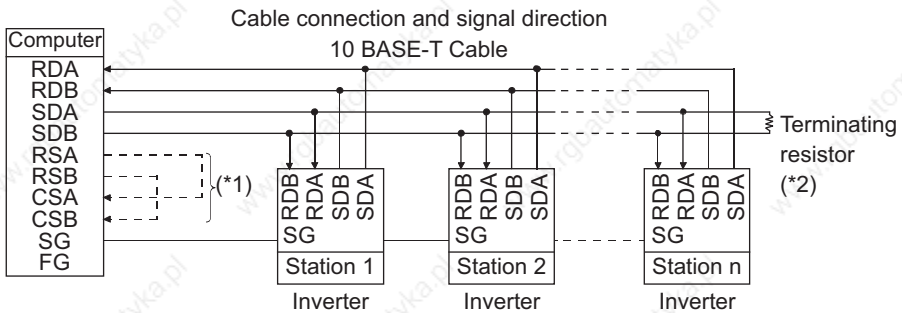

### REMARKS

- \*1. Make connection in accordance with the instruction manual of the computer to be used with. Fully check the terminal numbers of the computer since they change with the model.
- \*2. The inverters may be affected by reflection depending on the transmission speed or transmission distance. If this reflection hinders communication, provide a terminating resistor. When the RS-485 connector is used for connection, a terminating resistor cannot be fitted, so use a distributor. Connect the terminating resistor to only the inverter remotest from the computer. (Terminating resistor: 100Ω)

## 1.8 Design information

- 1) Provide electrical and mechanical interlocks for MC1 and MC2 which are used for commercial power supply-inverter switchover.

When the wiring is incorrect or if there is a commercial power supply-inverter switch-over circuit as shown below, the inverter will be damaged by leakage current from the power supply due to arcs generated at the time of switchover or chattering caused by a sequence error.

- 2) If the machine must not be restarted when power is restored after a power failure, provide a magnetic contactor in the inverter's primary circuit and also make up a sequence which will not switch on the start signal.

If the start signal (start switch) remains on after a power failure, the inverter will automatically restart as soon as the power is restored.

- 3) Since the input signals to the control circuit are on a low level, use two or more parallel micro signal contacts or a twin contact for contact inputs to prevent a contact fault.
- 4) Do not apply a large voltage to the contact input terminals (e.g. STF) of the control circuit.
- 5) Always apply a voltage to the alarm output terminals (A, B, C) via a relay coil, lamp etc.
- 6) Make sure that the specifications and rating match the system requirements.

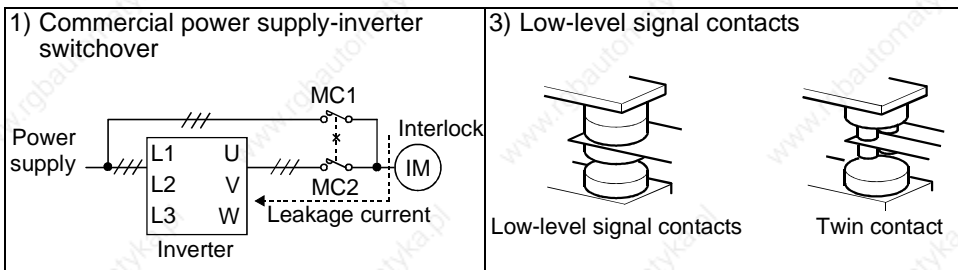

# MEMO

# 2. FUNCTIONS

This chapter explains the "functions" for use of this product. For simple variable-speed operation of the inverter, the factory settings of the parameters may be used as they are. Set the necessary parameters to meet the load and operational specifications. Refer to the instruction manual (basic) for the operation procedures. Always read the instructions before using the functions.

2.1	Function (Parameter) list .....	46
2.2	List of parameters classified by purpose of use .....	59
2.3	Explanation of functions (parameters) .....	61
2.4	Output terminal function parameters .....	84
2.5	Current detection function parameters .....	86
2.6	Display function parameters .....	88
2.7	Restart operation parameters.....	90
2.8	Additional function parameters .....	93
2.9	Terminal function selection parameters.....	96
2.10	Operation selection function parameters .....	99
2.11	Auxiliary parameters .....	118
2.12	Maintenance parameters .....	120
2.13	Brake parameters (FR-S520E-0.4K to 3.7K only).....	130
2.13	Calibration parameters .....	124
2.13	Calibration parameters .....	124
2.15	Communication parameters .....	128
2.16	Parameter unit (FR-PU04) setting .....	149

## CAUTION

As the contact input terminals RL, RM, RH, STR, open collector output terminal RUN and contact output terminals A, B, C can be changed in functions by parameter setting, their signal names used for the corresponding functions are used in this chapter (with the exception of the wiring examples). Note that they are not terminal names.

## REMARKS

### Parameter copy

Use of the parameter unit (FR-PU04) allows the parameter values to be copied to another FR-S500 series inverter. After batch-reading the parameters of the copy source inverter, you can connect the parameter unit to the copy destination inverter and batch-write the parameters.

For the operation procedure, refer to the instruction manual of the parameter unit (FR-PU04).

Chapter 1

Chapter 2

Chapter 3

Chapter 4

## 2.1 Function (Parameter) list

### CAUTION

□ indicates that the setting can be changed during operation if Pr. 77 "parameter write disable selection" has been set to "0" (factory setting). (Note that the Pr. 53, Pr. 70 and Pr. 72 values can be changed only during PU operation.)

Parameter	Indication	Name	Setting Range	Minimum Setting Increments	Factory Setting	Refer To:	Customer Setting
0	P 0	Torque boost	0 to 15%	0.1%	6%/5%/4% (*1)	61	
1	P 1	Maximum frequency	0 to 120Hz	0.1Hz	50Hz	62	
2	P 2	Minimum frequency	0 to 120Hz	0.1Hz	0Hz	62	
3	P 3	Base frequency	0 to 120Hz	0.1Hz	50Hz	63	
4	P 4	Multi-speed setting (high speed)	0 to 120Hz	0.1Hz	50Hz	64	
5	P 5	Multi-speed setting (middle speed)	0 to 120Hz	0.1Hz	30Hz	64	
6	P 6	Multi-speed setting (low speed)	0 to 120Hz	0.1Hz	10Hz	64	
7	P 7	Acceleration time	0 to 999s	0.1s	5s	65	
8	P 8	Deceleration time	0 to 999s	0.1s	5s	65	
9	P 9	Electronic thermal O/L relay	0 to 50A	0.1A	Rated output current	67	
30	P30	Extended function display selection	0, 1	1	0	78	
79	P79	Operation mode selection	0 to 4, 7, 8	1	0	107	

\*1. The factory setting varies with the inverter capacity: 5% for FR-S540E-1.5K and 2.2K, 4% for FR-S540E-3.7K.



The extended function parameters are made valid by setting "1" in Pr. 30 "extended function display selection". (For more detailed information on the way to set Pr. 30, refer to the instruction manual (basic).)

Function	Parameter	Indication	Name	Setting Range	Minimum Setting Increments	Factory Setting	Refer To:	Customer Setting
Parameters 0 to 9 are basic function parameters.								
Standard operation functions	10	P10	DC injection brake operation frequency	0 to 120Hz	0.1Hz	3Hz	69	
	11	P11	DC injection brake operation time	0 to 10s	0.1s	0.5s	69	
	12	P12	DC injection brake voltage	0 to 15%	0.1%	6%	69	
	13	P13	Starting frequency	0 to 60Hz	0.1Hz	0.5Hz	70	
	14	P14	Load pattern selection	0: For constant-torque loads, 1: For variable-torque loads, 2: For vertical lift loads, 3: For vertical lift loads	1	0	71	
	15	P15	Jog frequency	0 to 120Hz	0.1Hz	5Hz	72	
	16	P16	Jog acceleration/ deceleration time	0 to 999s	0.1s	0.5s	72	
	17	P17	RUN key rotation direction selection	0: Forward rotation, 1: Reverse rotation	1	0	72	
	19	P19	Base frequency voltage	0 to 800V, 888, - - -	1V	888	63	
	20	P20	Acceleration/ deceleration reference frequency	1 to 120Hz	0.1Hz	50Hz	65	
	21	P21	Stall prevention function selection	0 to 31, 100	1	0	73	
	22	P22	Stall prevention operation level	0 to 200%	1%	150%	75	
	23	P23	Stall prevention operation level compensation factor at double speed	0 to 200%, - - -	1%	- - -	75	

**Function (Parameter) list**

Parameter List

Function	Parameter	Indication	Name	Setting Range	Minimum Setting Increments	Factory Setting	Refer To:	Customer Setting	
Standard operation functions	24	P24	Multi-speed setting (speed 4)	0 to 120Hz, ---	0.1Hz	---	64		
	25	P25	Multi-speed setting (speed 5)	0 to 120Hz, ---	0.1Hz	---	64		
	26	P26	Multi-speed setting (speed 6)	0 to 120Hz, ---	0.1Hz	---	64		
	27	P27	Multi-speed setting (speed 7)	0 to 120Hz, ---	0.1Hz	---	64		
	28	P28	Stall prevention operation reduction starting frequency	0 to 120Hz	0.1Hz	50Hz	75		
	29	P29	Acceleration/deceleration pattern	0: Linear acceleration/deceleration, 1: S-pattern acceleration/deceleration A, 2: S-pattern acceleration/deceleration B	1	0	77		
	Parameter 30 is basic function parameter.								
	31	P31	Frequency jump 1A	0 to 120Hz, ---	0.1Hz	---	78		
	32	P32	Frequency jump 1B	0 to 120Hz, ---	0.1Hz	---	78		
	33	P33	Frequency jump 2A	0 to 120Hz, ---	0.1Hz	---	78		
	34	P34	Frequency jump 2B	0 to 120Hz, ---	0.1Hz	---	78		
	35	P35	Frequency jump 3A	0 to 120Hz, ---	0.1Hz	---	78		
	36	P36	Frequency jump 3B	0 to 120Hz, ---	0.1Hz	---	78		
	37	P37	Speed display	0, 0.1 to 999	0.1	0	79		
	38	P38	Frequency setting voltage gain frequency	1 to 120Hz	0.1Hz	50Hz	80		
	39	P39	Frequency setting current gain frequency	1 to 120Hz	0.1Hz	50Hz	80		
40	P40	Start-time earth fault detection selection	0: Not detected 1: Detected	1	1	84			

Function	Parameter	Indication	Name	Setting Range	Minimum Setting Increments	Factory Setting	Refer To:	Customer Setting
Output terminal functions	41	P41	Up-to-frequency sensitivity	0 to 100%	1%	10%	84	
	42	P42	Output frequency detection	0 to 120Hz	0.1Hz	6Hz	85	
	43	P43	Output frequency detection for reverse rotation	0 to 120Hz, ---	0.1Hz	---	85	
Second functions	44	P44	Second acceleration/ deceleration time	0 to 999s	0.1s	5s	65	
	45	P45	Second deceleration time	0 to 999s, ---	0.1s	---	65	
	46	P46	Second torque boost	0 to 15%, ---	0.1%	---	61	
	47	P47	Second V/F (base frequency)	0 to 120Hz, ---	0.1Hz	---	63	
Current detection	48	P48	Output current detection level	0 to 200%	1%	150%	86	
	49	P49	Output current detection period	0 to 10s	0.1s	0s	86	
	50	P50	Zero current detection level	0 to 200%	1%	5%	87	
	51	P51	Zero current detection period	0.05 to 1s	0.01s	0.5s	87	

**Function (Parameter) list**

Parameter List

Function	Parameter	Indication	Name	Setting Range	Minimum Setting Increments	Factory Setting	Refer To:	Customer Setting
Display functions	52	P52	Operation panel display data selection	0: Output frequency, 1: Output current, 100: Set frequency during stop/output frequency during operation	1	0	88	
	53	P53	Frequency setting operation selection	0: Setting dial frequency setting mode 1: Setting dial potentiometer mode	1	0	89	
	54	P54	AM terminal function selection	0: Output frequency monitor 1: Output current monitor	1	0	88	
	55	P55	Frequency monitoring reference	0 to 120Hz	0.1Hz	50Hz	90	
	56	P56	Current monitoring reference	0 to 50A	0.1A	Rated output current	90	
Automatic restart functions	57	P57	Restart coasting time	0 to 5s, ---	0.1s	---	90	
	58	P58	Restart cushion time	0 to 60s	0.1s	1s	90	
Additional function	59	P59	Remote setting function selection	0: Without remote setting function 1: With remote setting function With frequency setting storage function 2: With remote setting function Without frequency setting storage function	1	0	93	

Function	Parameter	Indication	Name	Setting Range	Minimum Setting Increments	Factory Setting	Refer To:	Customer Setting
Terminal function selection	60	P60	RL terminal function selection	0: RL, 1: RM, 2: RH, 3: RT, 4: AU, 5: STOP, 6: MRS, 7: OH, 8: REX, 9: JOG, 10: RES, 14: X14, 16: X16, ---: STR (The STR signal can be assigned to the STR terminal only.)	1	0	96	
	61	P61	RM terminal function selection		1	1	96	
	62	P62	RH terminal function selection		1	2	96	
	63	P63	STR terminal function selection		1	---	96	
	64	P64	RUN terminal function selection	0:RUN, 1:SU, 3:OL, 4:FU, 11:RY, 12:Y12, 13:Y13, 14:FDN, 15:FUP, 16:RL, 93:Y93, 95:Y95 98:LF, 99:ABC (The Y93 signal can be assigned to the RUN terminal only.)	1	0	98	
	65	P65	A, B, C terminal function selection		1	99	98	
Operation selection functions	66	P66	Retry selection	0: OC1 to 3, OV1 to 3, THM, THT, GF, OHT, OLT, PE, OPT 1: OC1 to 3, 2: OV1 to 3, 3: OC1 to 3, OV1 to 3	1	0	99	
	67	P67	Number of retries at alarm occurrence	0: No retry 1 to 10: Without alarm output during retry operation 101 to 110: With alarm output during retry operation	1	0	99	
	68	P68	Retry waiting time	0.1 to 360s	0.1s	1s	99	
	69	P69	Retry count display erase	0: Cumulative count erase	1	0	99	

Function	Parameter	Indication	Name	Setting Range	Minimum Setting Increments	Factory Setting	Refer To:	Customer Setting															
Operation selection functions	70	P70	Soft-PWM setting	<p>Presence/absence of Soft-PWM control and long wiring mode can be selected. When Soft-PWM is valid, the metallic tone of motor noise can be changed into unoffending composite tone.</p> <p>In the long wiring mode, surge voltages can be suppressed independently of the wiring length.</p> <table border="1" style="margin-left: auto; margin-right: auto;"> <thead> <tr> <th></th> <th>Soft-PWM</th> <th>Long wiring mode</th> </tr> </thead> <tbody> <tr> <td>0</td> <td>Absence</td> <td>Absence</td> </tr> <tr> <td>1</td> <td>Presence</td> <td>Absence</td> </tr> <tr> <td>10</td> <td>Absence</td> <td>Presence</td> </tr> <tr> <td>11</td> <td>Presence</td> <td>Presence</td> </tr> </tbody> </table>		Soft-PWM	Long wiring mode	0	Absence	Absence	1	Presence	Absence	10	Absence	Presence	11	Presence	Presence	1	1	101	
		Soft-PWM	Long wiring mode																				
	0	Absence	Absence																				
	1	Presence	Absence																				
	10	Absence	Presence																				
11	Presence	Presence																					
71	P71	Applied motor	<p>0, 100: Thermal characteristic for Mitsubishi standard motor</p> <p>1, 101: Thermal characteristic for Mitsubishi constant-torque motor (Thermal characteristic for Mitsubishi constant-torque motor is selected with the RT signal ON when 100 and 101 are set.)</p>	1	0	67																	
72	P72	PWM frequency selection	0 to 15	1	1	101																	
73	P73	0-5V/0-10V selection	0: For 0 to 5VDC input 1: For 0 to 10VDC input	1	0	102																	
74	P74	Input filter time constant	0: 2-step moving average processing 1 to 8: Exponential average value of 2n at the setting of n	1	1	103																	

Function	Parameter	Indication	Name	Setting Range	Minimum Setting Increments	Factory Setting	Refer To:	Customer Setting
Operation selection functions	75	P75	Reset selection/PU stop selection	0: Reset normally enabled/PU stop key disabled 1: Enabled at alarm occurrence only/PU stop key disabled 14: Reset normally enabled/normally decelerated to stop 15: Enabled at alarm occurrence only/normally decelerated to stop	1	14	103	
	76	P76	Cooling fan operation selection	0: Operation started at power on 1: Cooling fan ON/OFF control	1	1	105	
	77	P77	Parameter write disable selection	0: Write is enabled only during a stop 1: Write disabled (except some parameters) 2: Write during operation enabled	1	0	106	
	78	P78	Reverse rotation prevention selection	0: Both forward rotation and reverse rotation enabled, 1: Reverse rotation disabled, 2: Forward rotation disabled	1	0	107	
Parameter 79 is basic function parameter.								
Multi-speed operation function	80	P80	Multi-speed setting (speed 8)	0 to 120Hz, ---	0.1Hz	---	64	
	81	P81	Multi-speed setting (speed 9)	0 to 120Hz, ---	0.1Hz	---	64	
	82	P82	Multi-speed setting (speed 10)	0 to 120Hz, ---	0.1Hz	---	64	
	83	P83	Multi-speed setting (speed 11)	0 to 120Hz, ---	0.1Hz	---	64	

Function	Parameter	Indication	Name	Setting Range	Minimum Setting Increments	Factory Setting	Refer To:	Customer Setting
Multi-speed operation function	84	P84	Multi-speed setting (speed 12)	0 to 120Hz, ---	0.1Hz	---	64	
	85	P85	Multi-speed setting (speed 13)	0 to 120Hz, ---	0.1Hz	---	64	
	86	P86	Multi-speed setting (speed 14)	0 to 120Hz, ---	0.1Hz	---	64	
	87	P87	Multi-speed setting (speed 15)	0 to 120Hz, ---	0.1Hz	---	64	
PID control	88	P88	PID action selection	20: PID reverse action, 21: PID forward action	1	20	111	
	89	P89	PID proportional band	0.1 to 999%, ---	0.1%	100%	111	
	90	P90	PID integral time	0.1 to 999s, ---	0.1s	1s	111	
	91	P91	PID upper limit	0 to 100%, ---	0.1%	---	111	
	92	P92	PID lower limit	0 to 100%, ---	0.1%	---	111	
	93	P93	PID action set point for PU operation	0 to 100%	0.01%	0%	111	
	94	P94	PID differential time	0.01 to 10s, ---	0.01s	---	111	
Slip compensation	95	P95	Rated motor slip	0 to 50%, ---	0.01%	---	118	
	96	P96	Slip compensation time constant	0.01 to 10s	0.01s	0.5s	118	
	97	P97	Constant-output region slip compensation selection	0, ---	1	---	118	
Automatic torque boost	98	P98	Automatic torque boost selection (Motor capacity)	0.1 to 3.7kW, ---	0.01kW	---	119	
	99	P99	Motor primary resistance	0 to 50Ω, ---	0.01Ω	---	120	



## ● Maintenance parameters

Function	Maintenance parameters	Indication	Name	Setting Range	Minimum Setting Increments	Factory Setting	Refer To:	Customer Setting
Maintenance function	H1 (503)	H 1	Maintenance timer	0 to 999	1 (1000h)	0	120	
	H2 (504)	H 2	Maintenance timer alarm output set time	0 to 999, - - -	1 (1000h)	36 (36000h)	120	
	H3 (555)	H 3	Current average time	0.1 to 1s	0.1s	1s	121	
	H4 (556)	H 4	Data output mask time	0 to 20s	0.1s	0s	121	
	H5 (557)	H 5	Current average value monitor signal output reference current	0.1 to 999A	0.1A	1A	121	

## ● Additional parameters

Function	Maintenance parameters	Indication	Name	Setting Range	Minimum Setting Increments	Factory Setting	Refer To:	Customer Setting
Additional function	H6 (162)	H 6	Automatic restart after instantaneous power failure selection	0, 1, 10	1	1	90	
	H7 (559)	H 7	Second electronic thermal O/L relay	0 to 50A, - - -	0.1A	- - -	67	

● Calibration parameters

Function	Parameters	Indication	Name	Setting Range	Minimum Setting Increments	Factory Setting	Refer To:	Customer Setting
Calibration parameters	C1 (901)	$\left[ \begin{array}{c} 1 \\ 1 \end{array} \right]$	AM terminal calibration	—	—	—	124	
	C2 (902)	$\left[ \begin{array}{c} 2 \\ 2 \end{array} \right]$	Frequency setting voltage bias frequency	0 to 60Hz	0.1Hz	0Hz	80	
	C3 (902)	$\left[ \begin{array}{c} 3 \\ 3 \end{array} \right]$	Frequency setting voltage bias	0 to 300%	0.1%	0% (*)	80	
	C4 (903)	$\left[ \begin{array}{c} 4 \\ 4 \end{array} \right]$	Frequency setting voltage gain	0 to 300%	0.1%	96% (*)	80	
	C5 (904)	$\left[ \begin{array}{c} 5 \\ 5 \end{array} \right]$	Frequency setting current bias frequency	0 to 60Hz	0.1Hz	0Hz	80	
	C6 (904)	$\left[ \begin{array}{c} 6 \\ 6 \end{array} \right]$	Frequency setting current bias	0 to 300%	0.1%	20% (*)	80	
	C7 (905)	$\left[ \begin{array}{c} 7 \\ 7 \end{array} \right]$	Frequency setting current gain	0 to 300%	0.1%	100% (*)	80	
	C8 (269)	$\left[ \begin{array}{c} 8 \\ 8 \end{array} \right]$	Parameter set by manufacturer. Do not set.					
Clear parameters	CLr	$\left[ \begin{array}{c} CLr \\ CLr \end{array} \right]$	Parameter clear	0: Not executed 1: Parameter clear 10: All clear	1	0	127	
	ECL	$\left[ \begin{array}{c} ECL \\ ECL \end{array} \right]$	Alarm history clear	0: Not cleared, 1: Alarm history clear	1	0	127	







\* Factory settings may differ because of calibration parameters.

## ● Communication Parameters

Function	Parameter	Indication	Name	Setting Range	Minimum Setting Increments	Factory Setting	Refer To:	Customer Setting
Communication Parameters	n1 (331)	n 1	Communication station number	0 to 31: Specify the station number of the inverter.	1	0	130	
	n2 (332)	n 2	Communication speed	48: 4800bps, 96: 9600bps, 192: 19200bps	1	192	130	
	n3 (333)	n 3	Stop bit length	0, 1: (Data length 8), 10, 11: (Data length 7)	1	1	130	
	n4 (334)	n 4	Parity check presence/absence	0: Absent, 1: With odd parity check, 2: With even parity check	1	2	130	
	n5 (335)	n 5	Number of communication retries	0 to 10, ---	1	1	130	
	n6 (336)	n 6	Communication check time interval	0 to 999s, ---	0.1s	---	130	
	n7 (337)	n 7	Waiting time setting	0 to 150ms, ---	1	---	130	
	n8 (338)	n 8	Operation command source	0: Command source is computer, 1: Command source is external terminal	1	0	145	
	n9 (339)	n 9	Speed command source	0: Command source is computer, 1: Command source is external terminal	1	0	145	
	n10 (340)	n 10	Link startup mode selection	0: As set in Pr. 79. 1: Started in computer link operation mode.	1	0	146	
	n11 (341)	n 11	CR/LF selection	0: Without CR/LF, 1: With CR, without LF 2: With CR/LF	1	1	130	
	n12 (342)	n 12	E <sup>2</sup> PROM write selection	0: Write to RAM and E <sup>2</sup> PROM 1: Write to RAM only	1	0	148	

● PU parameters

When the parameter unit (FR-PU04) is used, operation from the operation panel is not accepted. (The stop key () is valid)

Function	Parameter	Indication	Name	Setting Range	Minimum Setting Increments	Factory Setting	Refer To:	Customer Setting
PU parameters	n13 (145)		PU display language selection	0: Japanese, 1: English, 2: German, 3: French, 4: Spanish, 5: Italian, 6: Swedish, 7: Finish	1	1	149	
	n14 (990)		PU buzzer control	0: Without sound, 1: With sound	1	1	149	
	n15 (991)		PU contrast adjustment	 0 (Light) 63 (Dark)	1	58	150	
	n16 (992)		PU main display screen data selection	0: Selectable between output frequency and output current 100: (during stop): Set frequency, output current (during operation): Output frequency, output current	1	0	150	
	n17 (993)		disconnected PU detection/PU setting lock	0: Without disconnected PU error, 1: Error at disconnected PU, 10: Without disconnected PU error (PU operation disable)	1	0	151	

**REMARKS**

1. The parameter number in parentheses is the one for use with the parameter unit (FR-PU04).
2. Set "9999" when setting a value "- - -" using the parameter unit (FR-PU04).
3. The decimal places of a value 100 or more (3 digits or more) cannot be displayed.

## 2.2 List of parameters classified by purpose of use

Set the parameters according to the operating conditions. The following list indicates purpose of use and corresponding parameters.

Purpose of Use		Parameter Numbers
		Parameter numbers which must be set
Related to operation	Use of extended function parameters	Pr. 30
	Operation mode selection	Pr. 53, Pr. 79 (Communication parameters n10, n17)
	Acceleration/deceleration time/pattern adjustment	Pr. 7, Pr. 8, Pr. 16, Pr. 20, Pr. 29, Pr. 44, Pr. 45
	Selection of output characteristics optimum for load characteristics	Pr. 3, Pr. 14, Pr. 19, Pr. 44, Pr. 45
	Output frequency restriction (limit)	Pr. 1, Pr. 2
	Operation over 50Hz	Pr. 1, Pr. 38, Pr. 39, calibration parameter C4, C7
	Adjustment of frequency setting signals and outputs	Pr. 38, Pr. 39, Pr. 73, calibration parameter C2 to C7
	Motor output torque adjustment	Pr. 0, Pr. 98
	Brake operation adjustment	Pr. 10, Pr. 11, Pr. 12
	Multi-speed operation	Pr. 1, Pr. 2, Pr. 4, Pr. 5, Pr. 6, Pr. 24, Pr. 25, Pr. 26, Pr. 27, Pr. 80, Pr. 81, Pr. 82, Pr. 83, Pr. 84, Pr. 85, Pr. 86, Pr. 87
	Jog operation	Pr. 15, Pr. 16
	Frequency jump operation	Pr. 31, Pr. 32, Pr. 33, Pr. 34, Pr. 35, Pr. 36
	Automatic restart operation after instantaneous power failure	Pr. 57, Pr. 58, additional parameter H6
	Slip compensation setting	Pr. 95 to Pr. 97
	Setting of output characteristics matching the motor	Pr. 3, Pr. 19, Pr. 71
Related to application operation	Electromagnetic brake operation timing	Pr. 42, Pr. 64, Pr. 65
	Sub-motor operation	Pr. 0, Pr. 3, Pr. 7, Pr. 8, Pr. 44, Pr. 45, Pr. 46, Pr. 47, additional parameter H7
	Operation in communication with personal computer	Communication parameters n1 to n12
	Operation under PID control	Pr. 60 to Pr. 65, Pr. 73, Pr. 79, Pr. 88 to Pr. 94
	Noise reduction	Pr. 70, Pr. 72

**List of parameters classified by purpose of use**

Purpose of Use		Parameter Numbers
		Parameter numbers which must be set
Related to monitoring	Frequency meter calibration	Pr. 54, Pr. 55, Pr. 56, calibration parameter C1
	Display of monitor on operation panel or parameter unit (FR-PU04)	Pr. 52, Communication parameter n16
	Display of speed, etc.	Pr. 37, Pr. 52
Related to incorrect operation prevention	Function write prevention	Pr. 77
	Reverse rotation prevention	(Pr. 17), Pr. 78
	Current detection	Pr. 48 to Pr. 51, Pr. 64, Pr. 65
	Motor stall prevention	Pr. 21, Pr. 22, Pr. 23, Pr. 28
Others	Input terminal function assignment	Pr. 60 to Pr. 63
	Output terminal function assignment	Pr. 64, Pr. 65
	Increased cooling fan life	Pr. 76
	Motor protection from overheat	Pr. 9, Pr. 71
	Automatic restart operation at alarm stop	Pr. 66 to Pr. 69
	Setting of earth fault overcurrent protection	Pr. 40
	Inverter reset selection	Pr. 75
	Maintenance timer output	Maintenance parameters H1 to H5

## 2.3 Explanation of functions (parameters)

### 2.3.1 Torque boost (Pr. 0 **P.0**, Pr. 46 **P.46**)

Increase this value for use when the inverter-to-motor distance is long or motor torque is insufficient in the low speed range (stall prevention is activated).

- Motor torque in the low-frequency range can be adjusted to the load to increase the starting motor torque.

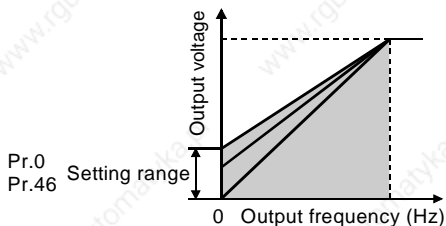

Parameter	Name	Factory Setting	Setting Range	Remarks
0	Torque boost	/5%/4%	0 to 15%	The factory setting varies according to the inverter capacity. (Refer to the following table for details.)
46	Second torque boost	---	0 to 15%, ---	---: Function invalid. Setting is enabled when Pr. 30 = "1".

#### <Setting>

- Assuming that the base frequency voltage is 100%, set the 0Hz voltage in %. Use the RT signal to switch between two different torque boosts. (Turn on the RT signal to make Pr. 46 valid(\*).)

#### REMARKS

\* The RT signal acts as the second function selection signal and makes the other second functions valid.

- When using an inverter-dedicated motor (constant-torque motor), make setting as indicated below.  
(If the factory set Pr. 71 value is changed to the setting for use with a constant-torque motor, the Pr. 0 setting changes to the corresponding value in the following table.)

Inverter Type	Inverter Capacity	Factory Setting	Constant-torque Motor Setting
FR-S520SE	0.2K to 0.75K	6%	6% (no change)
	1.5K to 3.7K		4%
FR-S540E	0.4K, 0.75K	6%	6% (no change)
	1.5K	5%	4%
	2.2K		3%
	3.7K	4%	

#### CAUTION

- Selecting automatic torque boost control makes this parameter setting invalid.
- A too large setting may cause the motor to overheat or result in an overcurrent trip. The guideline is about 10% at the greatest.

#### ◆ Related parameters ◆

- RT signal (second function "Pr. 46") setting ⇒ Pr. 60 to Pr. 63 "input terminal function selection" (refer to page 96)
- Constant-torque motor setting ⇒ Pr. 71 "applied motor" (refer to page 67)
- Automatic torque boost control selection ⇒ Pr. 98 "automatic torque boost selection (motor capacity)" (refer to page 119)

## 2.3.2 Maximum and minimum frequency (Pr. 1 P 1, Pr. 2 P 2)

You can clamp the upper and lower limits of the output frequency.

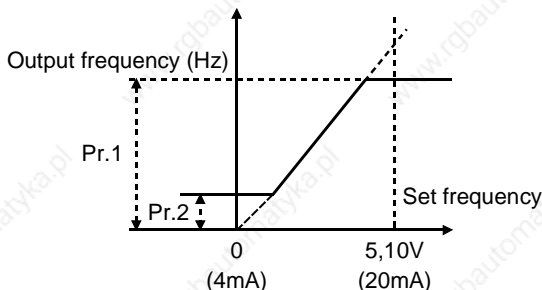

Parameter	Name	Factory Setting	Setting Range
1	Maximum frequency	50Hz	0 to 120Hz
2	Minimum frequency	0Hz	0 to 120Hz

### <Setting>

- Use Pr. 1 to set the upper limit of the output frequency. If the frequency of the frequency command entered is higher than the setting, the output frequency is clamped at the maximum frequency.
- Use Pr. 2 to set the lower limit of the output frequency.

### REMARKS

When using the potentiometer (frequency setting potentiometer) connected across terminals 2-5 to perform operation above 50Hz, change the Pr. 1 and Pr. 38 (Pr. 39 when using the potentiometer across terminals 4-5) values.

## ⚠ CAUTION

- ⚠ If the Pr. 2 setting is higher than the Pr. 13 "starting frequency" value, note that the motor will run at the frequency set in Pr. 2 according to the acceleration time setting by merely switching the start signal on, without entry of the command frequency.

### ◆ Related parameters ◆

- Maximum frequency setting using external potentiometer
  - ⇒ Pr. 30 "extended function display selection" (refer to page 78),
  - Pr. 38 "frequency setting voltage gain frequency",
  - Pr. 39 "frequency setting current gain frequency" (refer to page 80)



### 2.3.3 Base frequency, base frequency voltage

(Pr.3 P.3, Pr.19 P.19, Pr.47 P.47)

Used to adjust the inverter outputs (voltage, frequency) to the motor rating.

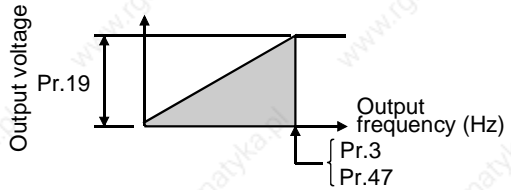

Parameter	Name	Factory Setting	Setting Range	Remarks
3	Base frequency	50Hz	0 to 120Hz	---
19	Base frequency voltage	888	0 to 800V, 888, ---	888: 95% of power supply voltage ---: Same as power supply voltage Setting is enabled when Pr. 30 = "1".
47	Second V/F (base frequency)	---	0 to 120Hz, ---	---: Function invalid Setting is enabled when Pr. 30 = "1".

#### <Setting>

- In Pr. 3 and Pr. 47, set the base frequency (motor's rated frequency). Use the RT signal to switch between these two different base frequencies. (Turn on the RT signal to make Pr. 47 valid.) (\*)  
When running the standard motor, generally set the "base frequency" to the rated frequency of the motor. When running the motor using commercial power supply-inverter switch-over operation, set the base frequency to the same value as the power supply frequency.
- Set the base voltage (e.g. rated voltage of motor) in Pr. 19.

#### CAUTION

- Set 60Hz in Pr. 3 "base frequency" when using a Mitsubishi constant-torque motor.
- When automatic torque boost is selected, Pr. 47 is invalid. When automatic torque boost is selected, setting " - - - " or "888" in Pr. 19 uses the rated output voltage.

#### REMARKS

\* The RT signal serves as the second function selection signal and makes the other second functions valid.

#### ◆ Related parameters ◆

- RT signal (second function "Pr. 47") setting ⇒ Pr. 60 to Pr. 63 (input terminal function selection) (refer to page 96)
- Motor setting ⇒ Pr. 71 "applied motor" (refer to page 67)
- Automatic torque boost selection ⇒ Pr. 98 "automatic torque boost selection (motor capacity)" (refer to page 119)

### 2.3.4 Multi-speed operation (Pr. 4 P 4, Pr. 5 P 5, Pr. 6 P 6, Pr. 24 P 24 to Pr. 27 P 27, Pr. 80 P 80 to Pr. 87 P 87)

Used to switch between the predetermined running speeds.

- Any speed can be selected by merely switching on/off the corresponding contact signals (RH, RM, RL, REX signals).
- By using these functions with Pr. 1 "maximum frequency" and Pr. 2 "minimum frequency", up to 17 speeds can be set.
- This function is valid in the external operation mode or in the combined operation mode which is available when Pr. 79 = "3" or "4".

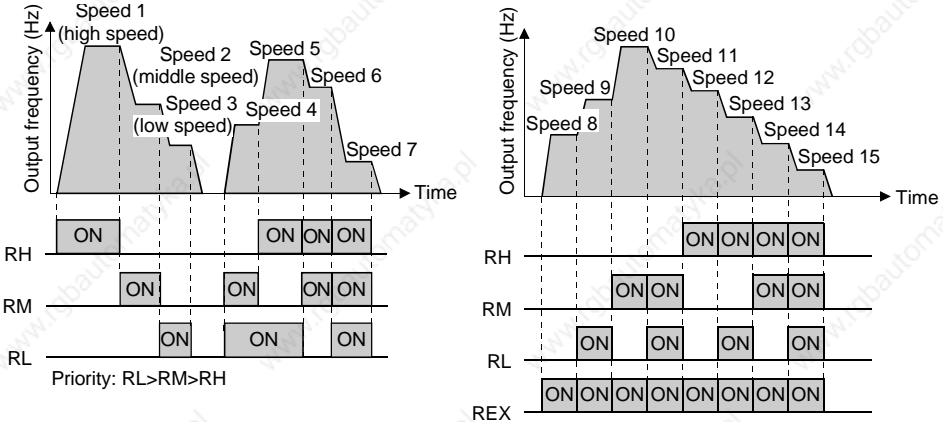

Parameter	Name	Factory Setting	Setting Range	Remarks
4	Multi-speed setting (high speed)	50Hz	0 to 120Hz	—
5	Multi-speed setting (middle speed)	30Hz	0 to 120Hz	—
6	Multi-speed setting (low speed)	10Hz	0 to 120Hz	—
24 to 27	Multi-speed setting (speeds 4 to 7)	---	0 to 120Hz, ---	"---" = no setting. Setting enabled when Pr. 30 = "1".
80 to 87	Multi-speed setting (speeds 8 to 15)	---	0 to 120Hz, ---	"---" = no setting. Setting enabled when Pr. 30 = "1".

#### <Setting>

- Set the running frequencies in the corresponding parameters.

Each speed (frequency) can be set as desired between 0 and 120Hz during inverter operation.

When the parameter of any multi-speed setting is read, turn the to change the setting.

In this case, press the () to store the frequency. (This is also enabled in the external mode.)

The setting is reflected by pressing the ()

- Assign the terminals used for signals RH, RM, RL and REX using Pr. 60 to Pr. 63. (When terminal assignment is changed using Pr. 60 to Pr. 63, the other functions may be affected. Please make setting after confirming the function of each terminal.)

**CAUTION**

1. The multi-speed settings override the main speeds (across terminals 2-5, 4-5, setting dial). When the multi-speed settings and setting dial are used in the combined operation mode (Pr. 79=3), the multi-speed settings have precedence.
2. The multi-speeds can also be set in the PU or external operation mode.
3. For 3-speed setting, if two or three speeds are simultaneously selected, priority is given to the set frequency of the lower signal.
4. Pr. 24 to Pr. 27 and Pr. 80 to Pr. 87 settings have no priority between them.
5. The parameter values can be changed during operation.
6. When using this function with the jog signal, the jog signal has precedence.

**REMARKS**

The frequency-set external terminals have the following priority:  
Jog > multi-speed operation > AU (terminal 4) > terminal 2

**◆ Related parameters ◆**

- Maximum, minimum frequency setting ⇒ Pr. 1 "maximum frequency", Pr. 2 "minimum frequency" (refer to page 62)
- Assignment of signals RH, RM, RL, REX to terminals ⇒ Pr. 60 to Pr. 63 (input terminal function selection) (refer to page 96)
- External operation mode setting ⇒ Pr. 79 "operation mode selection" (refer to page 107)
- Computer link mode ⇒ Pr. 79 "operation mode selection" (refer to page 107), communication parameter n10 "link startup mode selection" (refer to page 146)
- Speed command source ⇒ Communication parameter n9 "speed command source" (refer to page 145)

**2.3.5 Acceleration/deceleration time (Pr. 7 **P7**, Pr. 8 **P8**, Pr. 20 **P20**, Pr. 44 **P44**, Pr. 45 **P45**)**

Used to set motor acceleration/deceleration time.  
Set a larger value for a slower speed increase/decrease or a smaller value for a faster speed increase/decrease.

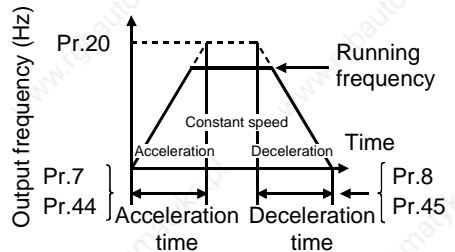

Parameter	Name	Factory Setting	Setting Range	Remarks
7	Acceleration time	5s	0 to 999s	—
8	Deceleration time	5s	0 to 999s	—
20	Acceleration/ deceleration reference frequency	50Hz	1 to 120Hz	Setting is enabled when Pr. 30 = "1".
44	Second acceleration/ deceleration time	5s	0 to 999s	Setting is enabled when Pr. 30 = "1".
45	Second deceleration time	---	0 to 999s, ---	---: acceleration time= deceleration time. Setting is enabled when Pr. 30 = "1".

**<Setting>**

- Use Pr. 7 and Pr. 44 to set the acceleration time required to reach the frequency set in Pr. 20 from 0Hz.
- Use Pr. 8 and Pr. 45 to set the deceleration time required to reach 0Hz from the frequency set in Pr. 20.
- Pr. 44 and Pr. 45 are valid when the RT signal is on. (When the RT signal is on, the other second functions (Pr. 44, Pr. 45, Pr. 46, Pr. 47, additional parameter H7) are also selected.)
- Set "-" in Pr. 45 to make the deceleration time equal to the acceleration time (Pr. 44).

**CAUTION**

1. In S-shaped acceleration/deceleration pattern A (refer to page 77), the set time is the period required to reach the base frequency set in Pr. 3.

- Acceleration/deceleration time formula when the set frequency is the base frequency or higher

$$t = \frac{4}{9} \times \frac{T}{(\text{Pr.3})^2} \times f^2 + \frac{5}{9} T$$

T: Acceleration/deceleration time setting (s)

f : Set frequency (Hz)

- Guideline for acceleration/deceleration time at the base frequency of 50Hz (0Hz to set frequency)

Frequency setting (Hz)	50	120
Acceleration/ deceleration time (s)		
5	5	16
15	15	47

2. If the Pr. 20 setting is changed, the settings of calibration functions Pr. 38 and Pr. 39 (frequency setting signal gains) remain unchanged.  
To adjust the gains, adjust calibration functions Pr. 38 and Pr. 39.
3. When the setting of Pr. 7, Pr. 8, Pr. 44 or Pr. 45 is "0", the acceleration/deceleration time is 0.04s.
4. If the acceleration/deceleration time is set to the shortest value, the actual motor acceleration/deceleration time cannot be made shorter than the shortest acceleration/deceleration time which is determined by the mechanical system's J (moment of inertia) and motor torque.

**◆ Related parameters ◆**

- Base frequency setting ⇒ Pr. 3 "base frequency" (refer to page 63)
- Acceleration/deceleration pattern, S-pattern acceleration/deceleration A ⇒ Pr. 29 "acceleration/deceleration pattern" (refer to page 77)
- Calibration function ⇒ Pr. 38 "frequency setting voltage gain frequency"  
Pr. 39 "frequency setting current gain frequency" (refer to page 80)
- RT signal setting ⇒ Pr. 60 to Pr. 63 (input terminal function selection) (refer to page 96)
- Jog acceleration/deceleration time ⇒ Pr. 16 "jog acceleration/deceleration time" (refer to page 72)

### 2.3.6 Selection and protection of a motor (Pr. 9 P 9, Pr. 71 P 71, H7 H 7)

Set the motor used and protect the motor from overheat.  
This feature provides the optimum protective characteristics, including reduced motor cooling capability, at low speed.

#### POINT

- When using the Mitsubishi constant-torque motor  
Set "1" in Pr. 71 for V/F control or automatic torque boost control.  
The electronic thermal relay function is set to the thermal characteristic of the constant-torque motor.
- When you selected the Mitsubishi constant-torque motor, the values of the following parameters are automatically changed. (only when the setting values of those parameters are at factory setting)  
Pr. 0 "torque boost", Pr. 12 "DC injection brake voltage"

Parameter	Name	Factory Setting	Setting Range	Remarks	
9	Electronic thermal O/L relay	Rated output current	0 to 50A		
71	Applied motor	0	0, 1, 100, 101		Setting is enabled when Pr. 30 = "1"
H7 (559)	Second electronic thermal O/L relay	---	0 to 50A, ---	---: Without second electronic thermal relay function	

- The parameter number in parentheses is the one for use with the parameter unit (FR-PU04).

#### <Setting>

- Refer to the following list and set Pr. 71 according to the motor used.  
Setting "100 or 101" changes thermal characteristic of the electronic thermal relay function to thermal characteristics of a Mitsubishi constant-torque motor when the RT signal is ON.

Pr. 71 Setting	Thermal Characteristic of the Electronic Thermal Relay Function
0, 100	Thermal characteristics of a standard motor
1, 101	Thermal characteristics of a Mitsubishi constant-torque motor (This provides a 100% continuous torque characteristic in the low-speed region.)

- Set the rated current [A] of the motor in Pr. 9.
- Setting "0" in Pr. 9 disables electronic thermal relay function (motor protective function). (The protective function of the inverter is activated.)
- When setting second electronic thermal relay function, set the motor rated current value in the additional parameter H7. The second electronic thermal relay function is valid when the RT signal is on. (When the RT signal is on, other second functions (Pr.44 to Pr.47) are also selected.)

#### CAUTION

- When two or more motors are connected to the inverter, they cannot be protected by the electronic thermal relay function. Install an external thermal relay to each motor.
- When a difference between the inverter and motor capacities is large and the setting becomes less than half amount of the inverter rated current, the protective characteristics of the electronic thermal relay function will be deteriorated. In this case, use an external thermal relay.
- A special motor cannot be protected by the electronic thermal relay function. Use an external thermal relay.

**REMARKS**

•When running two motors with one inverter, you can set the electronic thermal relay function of each inverter.

Pr. 71 applied motor	First Motor Electronic Thermal Relay Function		Second Motor Electronic Thermal Relay Function			
	Pr. 9 setting	RT = OFF	RT = ON	additional parameter H7 setting	RT = OFF	RT = ON
0	0		×	---, 0		×
	0.1 to 50A	○ standard	△	0.1 to 50A	△	○ standard
				0		×
1	0		×	---, 0		×
	0.1 to 50A	○ constant-torque	△	0.1 to 50A	△	○ standard
				0		×
100	0		×	---, 0		×
	0.1 to 50A	○ standard	△	0.1 to 50A	△	○ constant-torque
				0		×
101	0		×	---, 0		×
	0.1 to 50A	○ constant-torque	△	0.1 to 50A	△	○ constant-torque
				0		×
				0.1 to 50A	△	○ constant-torque

standard .....Thermal characteristic for standard motor  
 constant-torque .....Thermal characteristic for constant-torque motor

○ ..... Output current value is used to perform integration processing.  
 △ ..... Perform integration processing using output current of 0A.  
 × ..... Electronic thermal relay function is not activated (cumulative value clear)

**⚠ CAUTION**

**⚠ Set this parameter correctly according to the motor used. Incorrect setting may cause the motor to overheat and burn.**

### 2.3.7 DC injection brake (Pr. 10 P10, Pr. 11 P11, Pr. 12 P12)

By setting the DC injection brake voltage (torque), operation time and operation starting frequency, the stopping accuracy of positioning operation, etc. or the timing of operating the DC injection brake to stop the motor can be adjusted according to the load.

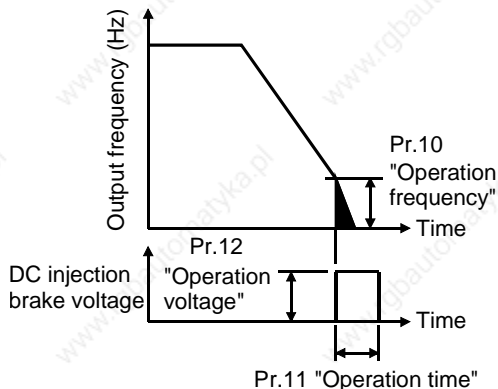

Parameter	Name	Factory Setting	Setting Range	Remarks
10	DC injection brake operation frequency	3Hz	0 to 120Hz	Setting is enabled when Pr. 30 = "1". (When Pr. 11 is set to "0s" or Pr. 12 is set to "0%", DC injection brake is not operated.)
11	DC injection brake operation time	0.5s	0 to 10s	
12	DC injection brake voltage	6%	0 to 15%	

\* The factory setting varies according to the inverter capacity. (Refer to the following table for details.)

#### <Setting>

- Use Pr. 10 to set the frequency at which the DC injection brake operation is started.
- Use Pr. 11 to set the period during when the brake is operated.
- Use Pr. 12 to set the percentage of the power supply voltage.
- Change the Pr. 12 setting to 4% when using the inverter-dedicated (constant-torque motor).

(If the Pr. 12 value remains unchanged from the factory setting and Pr. 71 is changed to the setting for use of the constant-torque motor, the Pr. 12 setting is automatically changed to 4%.)

## ⚠ CAUTION

⚠ Install a mechanical brake. No holding torque is provided.

### 2.3.8 Starting frequency (Pr. 13 **P13**)

The starting frequency at which the start signal is turned on can be set in the range 0 to 60Hz.

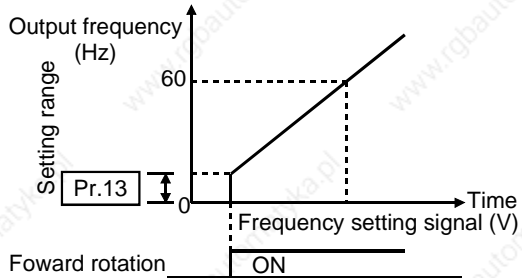

Parameter	Name	Factory Setting	Setting Range	Remarks
13	Starting frequency	0.5Hz	0 to 60Hz	Setting is enabled when Pr. 30 = "1".

#### CAUTION

The inverter will not start if the frequency setting signal is less than the value set in Pr. 13 "starting frequency".  
 For example, when 5Hz is set in Pr. 13, the motor will not start running until the frequency setting signal reaches 5Hz.

## ! CAUTION

**! Note that when Pr. 13 is set to any value lower than Pr. 2 "minimum frequency", simply turning on the start signal will run the motor at the preset frequency even if the command frequency is not input.**

#### ◆ Related parameters ◆

- Minimum frequency setting ⇒ Pr. 2 "minimum frequency" (refer to page 62)



### 2.3.9 Load pattern selection (Pr. 14 P.14)

You can select the optimum output characteristic (V/F characteristic) for the application and load characteristics.

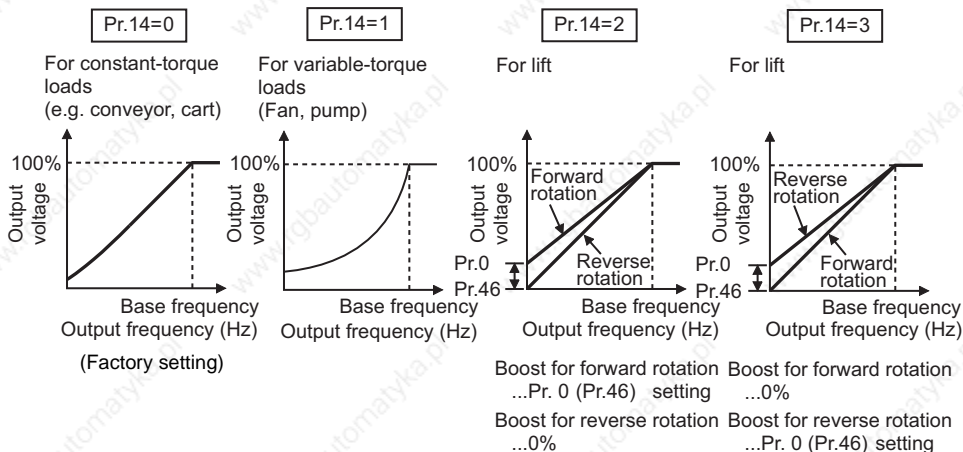

Parameter	Name	Factory Setting	Setting Range	Remarks
14	Load pattern selection	1	0, 1, 2, 3	0: For constant-torque loads 1: For variable-torque loads 2: For vertical lift loads 3: For vertical lift loads

#### CAUTION

- When automatic torque boost control is selected, this parameter setting is ignored.
- Pr. 46 "second torque boost" is made valid when the RT signal turns on. The RT signal acts as the second function selection signal and makes the other second functions valid.

#### ◆ Related parameters ◆

- Automatic torque boost ⇒ Pr. 98 "automatic torque boost selection (motor capacity)" (refer to page 119)
- Boost setting ⇒ Pr. 0 "torque boost", Pr. 46 "second torque boost" (refer to page 61)
- Assignment of RT signal to terminal when second torque boost is used ⇒ Pr. 60 to Pr. 63 (input terminal function selection) (refer to page 96)

### 2.3.10 Jog operation (Pr.15 P 15, Pr.16 P 16)

To start/stop jog operation in the external operation mode, choose the jog operation function in input terminal function selection, turn on the jog signal, and turn on/off the start signal (STF, STR).

You can choose the jog operation mode from the parameter unit (FR-PU04) and perform jog operation using the  FWD or  REV.

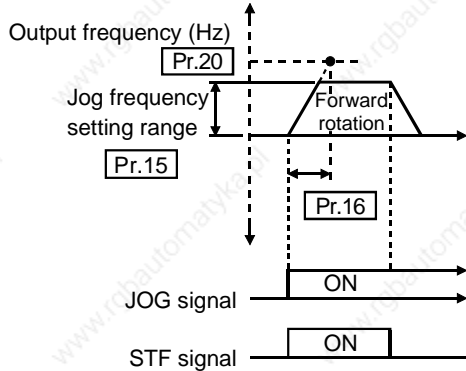

(Can be read as the basic parameters when the FR-PU04 is connected.)

● Set the frequency and acceleration/deceleration time for jog operation.

Parameter	Name	Factory Setting	Setting Range	Remarks
15	Jog frequency	5Hz	0 to 120Hz	Setting is enabled when Pr. 30 = "1".
16	Jog acceleration/ deceleration time	0.5s	0 to 999s	

#### CAUTION

- In S-shaped acceleration/deceleration pattern A, the acceleration/deceleration time is the period of time required to reach Pr. 3 "base frequency", not Pr. 20 "acceleration/deceleration reference frequency".
- The acceleration time and deceleration time cannot be set separately for jog operation.
- The Pr. 15 "Jog frequency" value should be equal to or higher than the Pr. 13 "starting frequency" setting.
- Assign the jog signal using any of Pr. 60 to Pr. 63 (input terminal function selection).

#### ◆ Related parameters ◆

- Assignment of jog signal to terminal ⇒ Pr. 60 to Pr. 63 (input terminal function selection) (refer to page 96)
- Acceleration/deceleration pattern S-shaped acceleration/deceleration A ⇒ Pr. 29 "acceleration/deceleration pattern" (refer to page 77)

### 2.3.11 RUN key rotation direction selection (Pr.17 P 17)

Used to choose the direction of rotation by operating the  RUN key of the operation panel.

Parameter	Name	Factory Setting	Setting Range	Remarks
17	RUN key rotation direction selection	0	0, 1	0: Forward rotation 1: Reverse rotation Setting is enabled when Pr. 30 = "1".

P 19 ➡ Refer to  P 3 (page 63)

P 20 ➡ Refer to  P 7,  P 8 (page 65)

### 2.3.12 Stall prevention function and current limit function (Pr. 21 P21)

You can make setting to prevent stall caused by overcurrent and/or to prevent the inverter from resulting in an overcurrent trip (to disable high-response current restriction that limits the current) when an excessive current flows due to sudden load fluctuation or ON-OFF on the output side of a running inverter.

- Stall prevention  
If the current exceeds the stall prevention operation level (Pr.22), the output frequency of the inverter is automatically varied to reduce the current.
- High response current limit  
If the current exceeds the limit value, the output of the inverter is shut off to prevent an overcurrent.

Parameter	Name	Factory Setting	Setting Range	Remarks
21	Stall prevention function selection	0	0 to 31, 100	Setting is enabled when Pr. 30 = "1".

Pr. 21 Setting	High Response Current Limit ○: Activated ●: Not activated	Stall Prevention Operation Selection ○: Activated ●: Not activated			OL Signal Output ○: Operation continued ●: Operation not continued (*)
		Acceleration	Constant speed	Deceleration	
0	○	○	○	○	○
1	●	○	○	○	○
2	○	●	○	○	○
3	●	●	○	○	○
4	○	○	●	○	○
5	●	○	●	○	○
6	○	●	●	○	○
7	●	●	●	○	○
8	○	○	○	●	○
9	○	○	○	●	○
10	○	●	○	●	○
11	●	●	○	●	○
12	○	○	●	●	○
13	●	○	●	●	○
14	○	●	●	●	○
15	●	●	●	●	○

Pr. 21 Setting	High Response Current Limit ○: Activated ●: Not activated	Stall Prevention Operation Selection ○: Activated ●: Not activated			OL Signal Output ○: Operation continued ●: Operation not continued (*)
		Acceleration	Constant speed	Deceleration	
16	○	○	○	○	●
17	●	○	○	○	●
18	○	●	○	○	●
19	●	●	○	○	●
20	○	○	●	○	●
21	●	○	●	○	●
22	○	●	●	○	●
23	●	●	●	○	●
24	○	○	○	●	●
25	●	○	○	●	●
26	○	●	○	●	●
27	●	●	○	●	●
28	○	○	●	●	●
29	●	○	●	●	●
30	○	●	●	●	●
31	●	●	●	●	●

\* When "Operation not continued for OL signal output" is selected, the "OLT" alarm code (stopped by stall prevention) is displayed and operation stopped.

(Alarm stop display "OLr")

100	Driving	○	○	○	○
	Regenerative	●	●	●	○

2  
FUNCTIONS

## CAUTION

- If the load is heavy, the lift is predetermined, or the acceleration/deceleration time is short, the stall prevention may be activated and the motor not stopped in the preset acceleration/deceleration time. Therefore, set optimum values to the Pr. 21 and stall prevention operation level.
- When the high response current limit has been set in Pr. 21 (factory setting), torque will not be provided at the Pr. 22 setting of 170% or higher. At this time, make setting so that the high response current limit is not activated.
- In vertical lift applications, make setting so that the high response current limit is not activated. Torque may not be produced, causing a drop due to gravity.

## CAUTION

 Always perform test operation.

Stall prevention operation performed during acceleration may increase the acceleration time.

Stall prevention operation performed during constant speed may cause sudden speed changes.

Stall prevention operation performed during deceleration may increase the deceleration time, increasing the deceleration distance.

### 2.3.13 Stall prevention (Pr. 22 **Pr.22**, Pr. 23 **Pr.23**, Pr. 28 **Pr.28**)

Set the output current level (% value to the inverter rated current) at which the output frequency will be adjusted to prevent the inverter from stopping due to overcurrent etc.

- During high-speed operation above the rated motor frequency, acceleration may not be made because the motor current does not increase. To improve the operating characteristics of the motor in this case, the stall prevention level can be reduced in the high frequency region. This function is effective for performing operation up to the high speed range on a centrifugal separator etc. Normally, set 50Hz in Pr. 28 "stall prevention operation reduction starting frequency" and 100% in Pr. 23.

Parameter	Name	Factory Setting	Setting Range	Remarks
22	Stall prevention operation level	150%	0 to 200%	—
23	Stall prevention operation level compensation factor at double speed	- - -	0 to 200%, - - -	- - -: Pr. 22 equally
28	Stall prevention operation reduction starting frequency	50Hz	0 to 120Hz	—

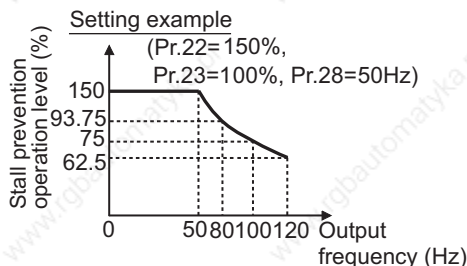
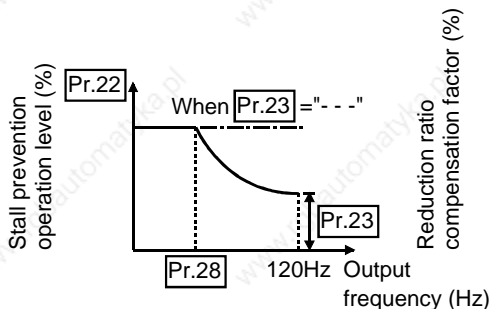

#### <Setting>

- Generally, set 150% (factory setting) in Pr. 22 "stall prevention operation level". Setting "0" in Pr. 22 disables stall prevention operation.
- To reduce the stall prevention operation level in the high frequency range, set the reduction starting frequency in Pr. 28 "stall prevention operation reduction starting frequency" and the reduction ratio compensation factor in Pr. 23.

Formula for stall prevention operation level

$$\text{Stall prevention operation level (\%)} = A + B \times \left[ \frac{\text{Pr. 22-A}}{\text{Pr. 22-B}} \right] \times \left[ \frac{\text{Pr. 23-100}}{100} \right]$$

$$\text{where, } A = \frac{\text{Pr. 28 (Hz)} \times \text{Pr. 22 (\%)}}{\text{output frequency (Hz)}}, \quad B = \frac{\text{Pr. 28 (Hz)} \times \text{Pr. 22 (\%)}}{120\text{Hz}}$$

- By setting "- - -" (factory setting) in Pr. 23, the stall prevention operation level is constant at the Pr. 22 setting up to 120Hz.

**REMARKS**

When the high response current limit is set in Pr. 21 "stall prevention function selection" (factory setting), do not set any value above 170% in Pr. 22. The torque will not be developed by doing so.

If the Pr. 22 value is set to higher than 170%, make setting in Pr. 21 to disable the high response current limit.

In vertical lift applications, make setting so the high response current limit is not activated. Torque may not be produced, causing a drop due to gravity.

 **CAUTION**

 **Do not set a small value as the stall prevention operation current. Otherwise, torque generated will reduce.**

 **Test operation must be performed.**

**Stall prevention operation during acceleration may increase the acceleration time.**

**Stall prevention operation during constant speed may change the speed suddenly.**

**Stall prevention operation during deceleration may increase the deceleration time, increasing the deceleration distance.**

**P24** to **P27** ➡ Refer to **P4** to **P6** (page 64)

### 2.3.14 Acceleration/deceleration pattern (Pr. 29 **Pr. 29**)

Set the acceleration/deceleration pattern.

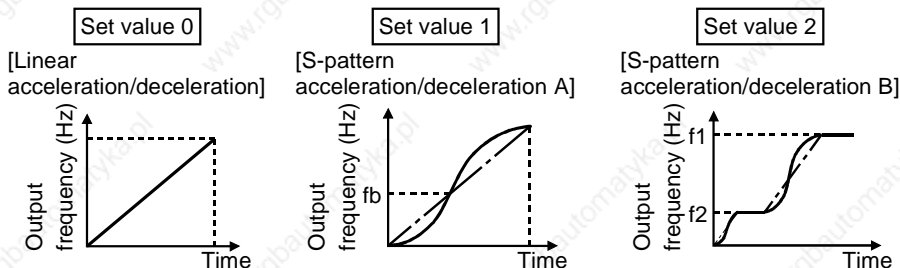

Parameter	Name	Factory Setting	Setting Range	Remarks
29	Acceleration/deceleration pattern	0	0, 1, 2	Setting is enabled when Pr. 30 = "1".

#### <Setting>

Pr. 29 Setting	Function	Description
0	Linear acceleration/deceleration	Acceleration is made to the set frequency linearly. (Factory setting)
1	S-pattern acceleration/deceleration A (*)	For machine tool spindle applications, etc. Used when acceleration/deceleration must be made in a short time to a high-speed region of not lower than the base frequency. Acceleration/deceleration is made in a pattern where $f_b$ (base frequency) acts as the inflection point of an S shape, and you can set the acceleration/deceleration time which matches the motor torque reduction in the constant-output operation region of not lower than the base frequency.
2	S-pattern acceleration/deceleration B	For prevention of load shifting in conveyor and other applications. Since acceleration/deceleration is always made in an S shape from $f_2$ (current frequency) to $f_1$ (target frequency), this function eases shock produced at acceleration/deceleration and is effective for load collapse prevention, etc.

#### CAUTION

\* As the acceleration/deceleration time, set the time taken to reach the Pr. 3 "base frequency" value, not the Pr. 20 "acceleration/deceleration reference frequency" value.

#### ◆ Related parameters ◆

- Base frequency (acceleration/deceleration time setting) setting  $\Rightarrow$  Pr. 3 "base frequency" (refer to page 63)
- Pr. 20 "acceleration / deceleration reference frequency"  $\Rightarrow$  refer to page 65
- For setting of "1" (S-pattern acceleration/deceleration A)  
 $\Rightarrow$  Pr. 44 "second acceleration/deceleration time", Pr. 45 "second deceleration time" (refer to page 65)

### 2.3.15 Extended function display selection (Pr. 30 P30)

Used to display the extended function parameters.

- Refer to page 46 for the extended function parameter list.
- Refer to the instruction manual (basic) for the parameter setting method.

Parameter	Name	Factory Setting	Setting Range	Remarks
30	Extended function display selection	0	0, 1	0: Without display, 1: With display

### 2.3.16 Frequency jump (Pr. 31 P31 to Pr. 36 P36)

When it is desired to avoid resonance attributable to the natural frequency of a mechanical system, these parameters allow resonant frequencies to be jumped. Up to three areas may be set, with the jump frequencies set to either the top or bottom point of each area.

The value set to 1A, 2A or 3A is a jump point and operation is performed at this frequency.

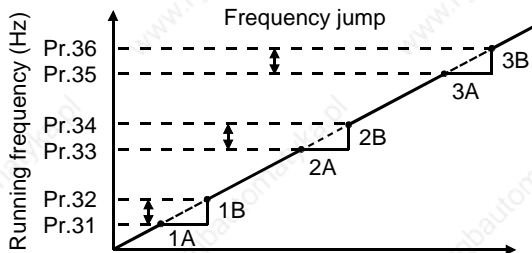

Parameter	Name	Factory Setting	Setting Range	Remarks
31	Frequency jump 1A	---	0 to 120Hz,---	• - - -: Function invalid • Setting is enabled when Pr. 30 = "1"
32	Frequency jump 1B	---	0 to 120Hz,---	
33	Frequency jump 2A	---	0 to 120Hz,---	
34	Frequency jump 2B	---	0 to 120Hz,---	
35	Frequency jump 3A	---	0 to 120Hz,---	
36	Frequency jump 3B	---	0 to 120Hz,---	

#### <Setting>

- To fix the frequency at 30Hz between Pr. 33 and Pr. 34 (30Hz and 35Hz), set 30Hz in Pr. 33 and 35Hz in Pr. 34.

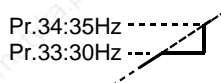

- To jump to 35Hz between 30 and 35Hz, set 35Hz in Pr. 33 and 30Hz in Pr. 34.

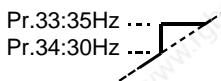

#### CAUTION

During acceleration/deceleration, the running frequency within the set area is valid.

#### REMARKS

Write disable error "E\_r !" occurs if the frequency jump setting ranges overlap.



### 2.3.17 Speed display (Pr. 37 )

You can change the output frequency indication or set frequency of the operation panel and parameter unit (FR-PU04) to the motor speed or machine speed.

Parameter	Name	Factory Setting	Setting Range	Remarks	
37	Speed display	0	0, 0.1 to 999	0:Output frequency	Setting is enabled when Pr. 30 = "1".

#### <Setting>

- To display the machine speed, set in Pr. 37 the machine speed for 60Hz operation.

#### CAUTION

- The motor speed is converted from the output frequency and does not match the actual speed.
- When you want to change the monitor (PU main display) of the operation panel, refer to Pr. 52 "operation panel display data selection" and communication parameter n16 "PU main display screen data selection".
- Since the operation panel indication is 3 digits, make a setting so that the monitor value does not exceed "999". If the Pr. 1 value is higher than 60Hz and Pr. 1 value  $\times$  Pr. 37 value  $>$  60Hz  $\times$  999

$\overline{E}r\overline{2}$  (write error) occurs when Pr. 1 or Pr. 37 is written.

#### REMARKS

When the speed is set in Pr. 37 (Pr. 37  $\neq$  0), the speed is monitored and displayed in the monitor/frequency setting mode.

At this time, setting can be made in the minimum setting (display) increments of 0.01r/min. Due to the limitations on the resolution of the set frequency, the indication in the second decimal place may differ from the setting.

## CAUTION

-  **Make sure that the running speed setting is correct.**  
Otherwise, the motor might run at extremely high speed, damaging the machine.

#### ◆ Related parameters ◆

- To choose running speed monitor display  $\Rightarrow$  Pr. 52 "operation panel display data selection" (refer to page 88)
- FR-PU04 display switching  $\Rightarrow$  Communication parameter n16 "PU main display screen data selection" (refer to page 150)

### 2.3.18 Biases and gains of the frequency setting voltage (current)

(Pr. 38 **P38**, Pr. 39 **P39**, C2 **C2** to C7 **C7**)

You can set the magnitude (slope) of the output frequency as desired in relation to the external frequency setting signal (0 to 5V, 0 to 10V or 4 to 20mADC). The "bias" and "gain" functions are used to adjust the relationship between the input signal entered from outside the inverter to set the output frequency, e.g. 0 to 5V, 0 to 10V or 4 to 20mADC, and the output frequency.

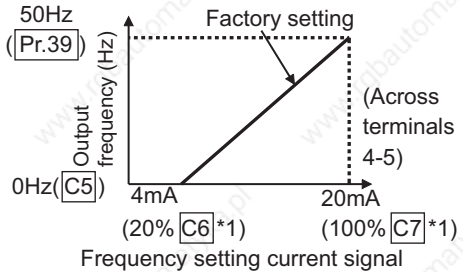
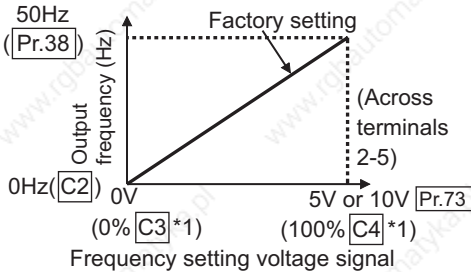

Parameter	Name	Factory Setting	Setting Range	Remarks
38	Frequency setting voltage gain frequency	50Hz	1 to 120Hz	Setting is enabled when Pr. 30 = "1".
39	Frequency setting current gain frequency	50Hz	1 to 120Hz	
C2 (902) *2	Frequency setting voltage bias frequency	0Hz	0 to 60Hz	
C3 (902) *2	Frequency setting voltage bias	0% *1	0 to 300%	
C4 (903) *2	Frequency setting voltage gain	96% *1	0 to 300%	
C5 (904) *2	Frequency setting current bias frequency	0Hz	0 to 60Hz	
C6 (904) *2	Frequency setting current bias	20% *1	0 to 300%	
C7 (905) *2	Frequency setting current gain	100% *1	0 to 300%	

\*1. Factory settings may differ because of calibration parameters.

\*2. The parameter number in parentheses is the one for use with the parameter unit (FR-PU04).

#### POINT

- Bias setting for 0-5VDC (0-10VDC) input ➡ Use calibration parameters C2, C3 for setting.
  - Gain setting for 0-5VDC (0-10VDC) input ➡ Use Pr. 38, calibration parameter C4 for setting.
  - Bias setting for 4-20mADC input ➡ Use calibration parameters C5, C6 for setting.
  - Gain setting for 4-20mADC input ➡ Use Pr. 39, calibration parameter C7 for setting.
- (For 4 to 20mADC input, set "4" in any of Pr. 60 to Pr. 63 (input terminal function selection) and assign AU (current input selection) to any of terminals RH, RM, RL and STR, and turn on the AU signal.)

<Setting>











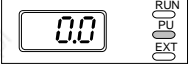





- (1) How to change the highest frequency
- (2) Adjusting the deviation of the highest frequency from the Pr. 38 (Pr. 39) setting.
  - (2-1) Make adjustment with a voltage applied directly across terminals 2-5 (with a current flowing across terminals 4-5)
  - (2-2) Make adjustment at any point without a voltage applied across terminals 2-5 (without a current flowing across terminals 4-5)

**Changingexample** When you want to use the 0 to 5VDC input frequency setting potentiometer to change the 5V frequency from 50Hz(factory setting) to 40Hz

**POINT**



- Pr. 38 is an extended function parameter. Pr. 30 must be set to "1".
- Change Pr. 38 "frequency setting voltage gain frequency" to 40Hz.

**(1) How to change the highest frequency**

Operation	Display
<p>1. Confirm the RUN indication and operation mode indication.</p> <ul style="list-style-type: none"> <li>●The inverter must be at a stop.</li> <li>●The inverter must be in the PU operation mode.</li> </ul> <p>(Press the .)</p>	
<p>2. Press the  to choose the parameter setting mode.</p>	 ⇒ 
<p>3. Turn the  until the parameter number 38 "frequency setting voltage gain frequency" appears.</p> <ul style="list-style-type: none"> <li>●Pr. 30 must be set to "1".</li> </ul> <p>(For the Pr. 30 setting method, refer to the instruction manual (basic).)</p>	 ⇒ 
<p>4. Pressing the  shows the currently set value. (50Hz)</p>	 ⇒ 
<p>5. Turn the  to change the set value to "40.0". (40Hz)</p>	 ⇒ 
<p>6. Press the  to set the value.</p>	 ⇒ 

(The parameter number read previously appears.)

**Flicker ... Parameter setting complete!!**

- By turning the , you can read another parameter.
- Press the  to show the setting again.
- Press the  twice to show the next parameter.

? **The monitor/frequency setting indication cannot be changed to just 40Hz ... Why?**

☞ The calibration parameter C4 "frequency setting voltage gain" value must be set. (Refer to next page (2).)

**REMARKS**

To change the value to more than 50Hz, Pr. 1 "maximum frequency" must be set to more than 50Hz.

**Changing example** Changing the calibration parameter C4 "frequency setting voltage gain" value

**POINT**

The calibration parameter C4 is an extended function parameter. Pr. 30 must be set to "1".

**(2) Adjusting a deviation of the highest frequency from the Pr. 38 (Pr. 39) setting.**  
**(2)-1 Making adjustment with a voltage applied directly across terminals 2-5 (with a current flowing across terminals 4-5)**

**Operation**

**Display**

1. Confirm the RUN indication and operation mode indication.



- The inverter must be at a stop.
- The inverter must be in the PU operation mode.

(Press the )

2. Press the to choose the parameter setting mode.



(The parameter number read previously appears.)

3. Turn the to show "┌ . .".



- Pr. 30 must be set to "1".
- (For the Pr. 30 setting method, refer to the instruction manual (basic).)

4. Press the to show "┌ -".



When adjusting Pr. 38

5. Turn the until the calibration parameter C4 "frequency setting voltage gain" appears.

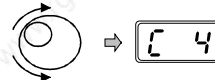

6. Press the to show the analog voltage value (%).



(Analog voltage value (%) across terminals 2-5)

7. Apply a 5V voltage.  
 (Turn the external potentiometer connected to across terminals 2-5 to the maximum (any position).)



\*The value is nearly 100 (%) in the maximum position of the potentiometer.

**CAUTION**

After performing operation in step 7, do not touch the until completion of calibration.

8. Press the to set the value.



**Flicker ... Parameter setting complete!!**  
 (Adjustment complete)

\*The value is nearly 100 (%) in the maximum position of the potentiometer.

- By turning the , you can read another parameter.
- Press the to return to the ┌ - indication (step 4).
- Press the twice to show the next parameter (┌ ┌ r).

? The frequency meter (indicator) connected to across terminals AM-5 does not indicate just 40Hz ... Why?

☞ The calibration parameter C1 "AM terminal calibration" value must be set.  
 (For the setting method, refer to the instruction manual (basic).)

? When write is performed, an error (┌ r 3) is displayed.

☞ The gain and bias frequency settings are too close.

## (2)-2 Making adjustment at any point with a voltage not applied across terminals 2-5 (without a current flowing across terminals 4-5)

### Operation

1. Confirm the RUN indication and operation mode indication.
  - The inverter must be at a stop.
  - The inverter must be in the PU operation mode.  
(Press the )

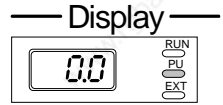

2. Press the  to choose the parameter setting mode.

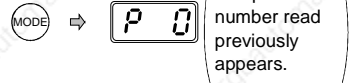

3. Turn the  to show "┌ . .".
  - Pr. 30 must be set to "1".  
(For the Pr. 30 setting method, refer to the instruction manual (basic).)

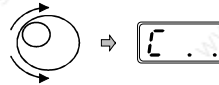



4. Press the  to show "┌ -".



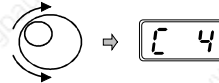

When adjusting Pr. 38

5. Turn the  until the calibration parameter C4 "frequency setting voltage gain" appears.

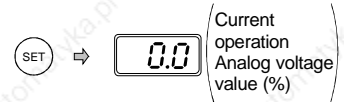

6. Press the  to show the analog voltage value (%).  
(The maximum value can be displayed by merely turning the  clockwise or counterclockwise in this status by one pulse's worth of turns (there is tactile feedback because of the notch type).)



7. Turn the  to the maximum value (100%) or any point.

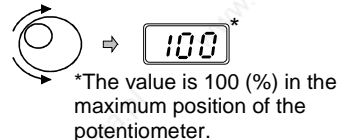





8. Press the  to set the value.



**Flicker ... Parameter setting complete!!**

\*The value is 100 (%) in the maximum position of the potentiometer.

- Turn the  to read another parameter.
- Press the  to return to the  indication (step 4).
- Press the  twice to show the next parameter ().

### REMARKS

For the way to change the output frequency setting of the frequency setting potentiometer, refer to the instruction manual (basic).

### 2.3.19 Start-time earth fault detection selection (Pr. 40 **P40**)

You can choose whether to make earth fault detection at start valid or invalid. Earth fault detection is executed only right after the start signal is input to the inverter. Protective function will not activate if an earth fault occurs during operation.

Parameter	Name	Factory Setting	Setting Range	Remarks
40	Start-time earth fault detection selection	1	0, 1	0: Earth fault detection for protection is not executed. 1: Earth fault detection for protection is executed. Setting is enabled when Pr. 30 = "1".

#### CAUTION

1. If an earth fault is detected with "1" set in Pr. 40, alarm output "CF" is detected and the output is shut off.
2. If the motor capacity is less than 0.1kW, earth fault protection may not be provided.

#### REMARKS

When an earth fault is detected with "1" set in Pr. 40, an approximate 20ms delay occurs at every start.

## 2.4 Output terminal function parameters

### 2.4.1 Up-to-frequency (Pr. 41 **P41**)

The ON range of the up-to-frequency signal (SU) output when the output frequency reaches the running frequency can be adjusted between 0 and  $\pm 100\%$  of the running frequency. This parameter can be used to ensure that the running frequency has been reached to provide the operation start signal etc. for related equipment.

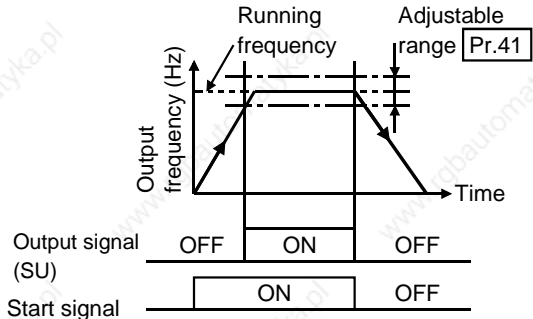

Parameter	Name	Factory Setting	Setting Range	Remarks
41	Up-to-frequency	10%	0 to 100%	Setting is enabled when Pr. 30 = "1".

Use Pr. 64 or Pr. 65 (output terminal function selection) to assign the terminal used for SU signal output.

#### CAUTION

Using Pr. 64 or Pr. 65 to change the terminal assignment may affect the other functions. Please make setting after confirming the function of each terminal. (Refer to page 98.)

#### ◆Related parameters◆

- Assignment of SU signal to terminal  $\Rightarrow$  Pr. 64 "RUN terminal function selection", Pr. 65 "A, B, C terminal function selection" (refer to page 98)

## 2.4.2 Output frequency detection (Pr. 42 , Pr. 43 )

The output frequency detection signal (FU) is output when the output frequency reaches or exceeds the setting. This function can be used for electromagnetic brake operation, open signal, etc. You can also set the detection of the frequency used exclusively for reverse rotation.

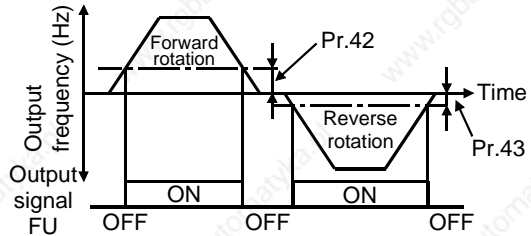

This function is effective for switching the timing of electromagnetic brake operation between forward rotation (rise) and reverse rotation (fall) during vertical lift operation, etc.

Parameter	Name	Factory Setting	Setting Range	Remarks	
42	Output frequency detection	6Hz	0 to 120Hz	—	Setting is enabled when Pr. 30 = "1".
43	Output frequency detection for reverse rotation	---	0 to 120Hz, ---	---: Same as Pr. 42 setting	

### <Setting>

Refer to the above chart and set the corresponding parameters.





- When Pr. 43 "output frequency detection for reverse rotation"  $\neq$  " - - - ", the Pr.42 setting applies to forward rotation and the Pr.43 setting applies to reverse rotation.
- Use Pr. 64 or Pr. 65 (output terminal function selection) to assign the terminal used for FU signal output.



### CAUTION



Using Pr. 64 or Pr. 65 to change the terminal assignment may affect the other functions. Make setting after confirming the function of each terminal.

#### ◆ Related parameters ◆

- Assignment of FU signal to terminal  $\Rightarrow$  Pr. 64 "RUN terminal function selection", Pr. 65 "A, B, C terminal function selection" (refer to page 98)

   $\Rightarrow$  Refer to ,  (page 65).

  $\Rightarrow$  Refer to  (page 61).

  $\Rightarrow$  Refer to  (page 63).

## 2.5 Current detection function parameters

### 2.5.1 Output current detection functions

(Pr. 48 **P48**, Pr. 49 **P49**)

If the output remains higher than the Pr. 48 setting during inverter operation for longer than the time set in Pr. 49, the output current detection signal (Y12) is output from the inverter's open collector output or contact output terminal.

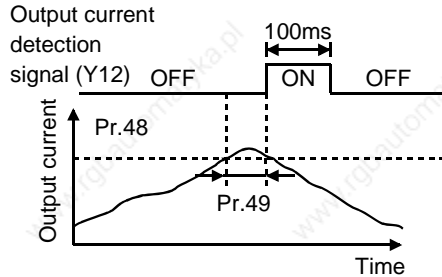

Parameter	Name	Factory Setting	Setting Range	Remarks
48	Output current detection level	150%	0 to 200%	Setting is enabled when Pr. 30 = "1"
49	Output current detection period	0s	0 to 10s	

#### <Setting>

Parameter Number	Description
48	Set the output current detection level. 100% is the rated inverter current.
49	Set the output current detection period. Set the time from when the output current has risen above the Pr. 48 setting until the output current detection signal (Y12) is output.

Use Pr. 64 or Pr. 65 (output terminal function selection) to assign the terminal used for Y12 signal output.

#### CAUTION

- Once turned ON, when the output current has risen above the preset detection level, the output current detection signal is held for at least 100ms (approximately).
- Using Pr. 64 or Pr. 65 (output terminal function selection) to change terminal assignment may affect the other functions. Make setting after confirming the function of each terminal.

#### ◆ Related parameters ◆

- Assignment of Y12 signal to terminal ⇒ Pr. 64 "RUN terminal function selection", Pr. 65 "A, B, C terminal function selection" (refer to page 98)



## 2.5.2 Zero current detection (Pr. 50 **PS0**, Pr. 51 **PS1**)

When the inverter's output current falls to "0[A]", torque will not be generated. This may cause a gravity drop when the inverter is used in vertical lift application.

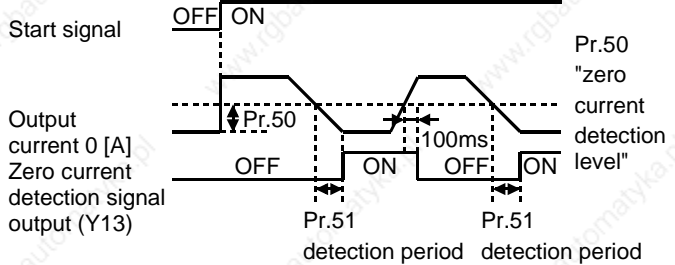

To prevent this, the output current "zero" signal can be output from the inverter to close the mechanical brake when the output current has fallen to "0[A]".

Parameter	Name	Factory Setting	Setting Range	Remarks
50	Zero current detection level	5%	0 to 200%	Setting is enabled when Pr. 30 = "1"
51	Zero current detection period	0.5s	0.05 to 1s	Pr. 30 = "1"

### POINT

If the output is lower than the Pr. 50 setting for longer than the time set in Pr. 51 during inverter operation, the zero current detection (Y13) signal is output from the inverter's open collector output terminal or contact output terminal.

### <Setting>

Parameter	Description
50	Set the zero current detection level. Set the level of zero current detection in terms of the percentage of the rated inverter current from the output current value of 0 [A].
51	Set the zero current detection period. Set a period of time from when the output current falls to or below the Pr. 50 setting to when the zero current detection signal (Y13) is output.

Use Pr. 64 or Pr. 65 (output terminal function selection) to assign the terminal used for Y13 signal output.

### CAUTION

- If the current falls below the preset detection level but the timing condition is not satisfied, the zero current detection signal is held on for about 100ms.
- When the terminal functions are changed using Pr. 64, Pr. 65, the other functions may be affected. Please make setting after confirming the function of each terminal.
- When running (connecting) multiple motors with one inverter in due order, the zero current detection signal (Y13) may be output. Set 13% or more for the 0.1K and 8% or more for the 0.2K.  
(when the total capacity of motors is less than the zero current detection level and the motor capacity per inverter is less than the zero current detection level)

### ◆ Related parameters ◆

- Assignment of Y13 signal to terminal ⇒ Pr. 64 "RUN terminal function selection", Pr. 65 "A, B, C terminal function selection" (refer to page 98)

## 2.6 Display function parameters

### 2.6.1 Monitor display (Pr. 52 ~~P52~~, Pr. 54 ~~P54~~)

You can choose the display of the operation panel "monitor/frequency setting screen".

Parameter	Name	Factory Setting	Setting Range	Remarks
52	Operation panel display data selection	0	0, 1, 100	Setting is enabled when Pr. 30 = "1"
54	AM terminal function selection	0	0, 1	

#### POINT

- You can also use the **SET** to change the display. (Refer to the instruction manual (basic) for the operation procedure.)
- The analog current output terminal AM is available for signal output. (Make selection using the Pr. 54 "AM terminal function selection" value.)

#### <Setting>

Signal Type	Unit	Parameter Setting		Full-Scale Value of AM Level Meter
		Pr. 52	Pr. 54	
		Operation panel LED	AM terminal	
Output frequency	Hz	0/100	0	Pr. 55 "frequency monitoring reference"
Output current	A	1	1	Pr. 56 "current monitoring reference"

When "100" is set in Pr. 52, the monitored values during stop and during operation differ as indicated below.

	Pr. 52		
	0	100	
	During running/stop	During stop	During running
Output frequency	Output frequency	Set frequency	Output frequency

#### REMARKS

- During an error, its definition appears.
- During reset, the values displayed are the same as during a stop.
- For selection of the parameter unit (FR-PU04) monitor display, refer to the communication parameter n16 "PU main display screen data selection". (Page 150)

#### CAUTION

**The unit displayed on the operation panel is only A and other units are not displayed.**

#### ◆ Related parameters ◆

- Speed display ⇒ Pr. 37 "speed display" (refer to page 79)
- Adjustment of level meter full-scale value ⇒ Calibration parameter C1 "AM terminal calibration" (refer to page 124)
- Monitoring reference ⇒ Pr. 55 "frequency monitoring reference", Pr. 56 "current monitoring reference" (refer to page 90)

## 2.6.2 Setting dial function selection (Pr. 53 ~~P53~~)

You can use the dial like a potentiometer to perform operation.

Parameter	Name	Factory Setting	Setting Range	Remarks
53	Frequency setting operation selection	0	0, 1	0: Setting dial frequency setting mode 1: Setting dial potentiometer mode Setting is enabled when Pr. 30 = "1"





### Using the setting dial like a potentiometer to perform operation

#### POINT



- Set "1" (extended function parameter valid) in Pr. 30 "extended function display selection".
- Set "1" (setting dial potentiometer mode) in Pr. 53 "frequency setting operation selection".

**Operation example** Changing the frequency from 0Hz to 50Hz during operation

**Operation**

- Mode/monitor check
  - Choose monitor/frequency monitor. (MODE)
  - The inverter must be in the PU operation mode. (Press the )
  - Pr. 30 must be set to "1".
  - Pr. 53 must be set to "1".
- Press the  to start the inverter.
- Turn the  clockwise until "50.0" appears. The flickering frequency is the set frequency. You need not press the .

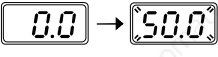

**Display**

Flickers for 3s.

#### REMARKS

- If flickering "50.0" turns to "0.0", the Pr. 53 "frequency setting operation selection" setting may not be "1".
- Independently of whether the inverter is running or at a stop, the frequency can be set by merely turning the dial.
- When the frequency is changed, it will be stored as the set frequency after 10s.

 ➔ Refer to  (page 88).

## 2.6.3 Monitoring reference (Pr. 55 **P55**, Pr. 56 **P56**)

Set the frequency or current which is referenced when the output frequency or output current is selected for the terminal AM.

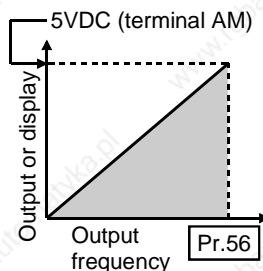
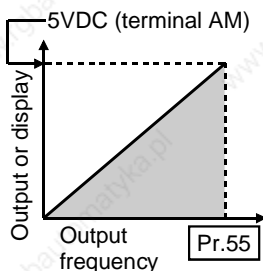

Parameter	Name	Factory Setting	Setting Range	Remarks
55	Frequency monitoring reference	50Hz	0 to 120Hz	Setting is enabled when Pr. 30 = "1"
56	Current monitoring reference	Rated output current	0 to 50A	

### <Setting>

Refer to the above diagrams and set the frequency monitoring reference value in Pr. 55 and the current monitoring reference value in Pr. 56.

Pr. 55 is set when Pr. 54 "AM terminal function selection" = "0" and Pr. 56 is set when Pr. 54 = "1".

In Pr. 55 and Pr. 56, set the frequency and current at which the output voltage of terminal AM will be 5V.

### CAUTION

The maximum output voltage of terminal AM is 5VDC.

## 2.7 Restart operation parameters

### 2.7.1 Restart setting (Pr. 57 **P57**, Pr. 58 **P58**, H6 **H 6**)

At power restoration after an instantaneous power failure, you can restart the inverter without stopping the motor (with the motor coasting).

Parameter	Name	Factory Setting	Setting Range	Remarks
57	Restart coasting time	---	0 to 5s, ---	Setting is enabled when Pr. 30 = "1"
58	Restart cushion time	1s	0 to 60s	
H6 (162)	Automatic restart after instantaneous power failure selection	1	0, 1, 10	

The parameter number in parentheses is the one for use with the parameter unit (FR-PU04).

## &lt;Setting&gt;

Refer to the following table and set the parameters:

Parameter	Setting	Description	
57	0	0.1K to 1.5K	Coasting time of 0.5s
		2.2K, 3.7K	Coasting time of 1.0s
	0.1 to 5s	Waiting time for inverter-triggered restart after power is restored from an instantaneous power failure. (Set this time between 0.1 and 5s according to the moment (J) of inertia and torque of the load.)	
58	- - -	No restart (factory setting)	
	0 to 60s	Normally the motor may be run with the factory settings. These values are adjustable to the load (moment of inertia, torque).	
H6 (162)	0	With speed search The motor coasting speed is detected after instantaneous power failure is detected.	
	1	Without speed search (factory setting) Automatic restart operation after instantaneous power failure is a reduced voltage starting system in which the output voltage is risen gradually at the preset frequency independently of the coasting speed of the motor.	
	10	With speed search at starting The motor coasting speed is detected after instantaneous power failure and at starting.	

H6 = 0, 10 (with speed search)

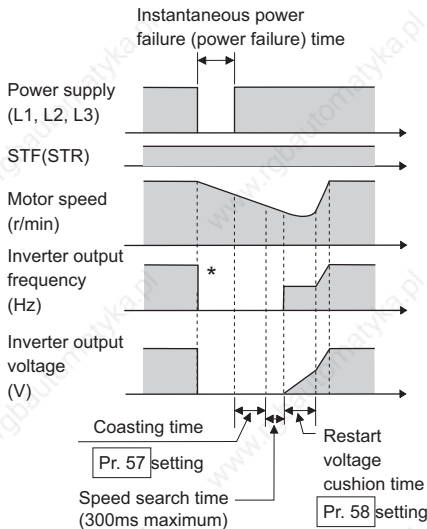

H6 = 1 (without speed search)

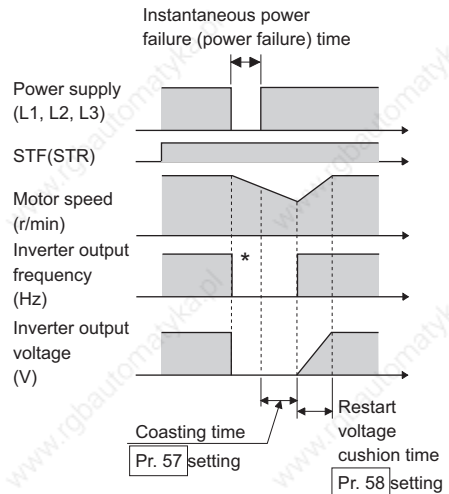

\*The output shut off timing differs according to the load condition.



## REMARKS

- When the start signal is turned off during power failure and power is restored  
Without speed search (H6=1): Decelerates to stop after running in the same direction before power failure. Note that the motor will coast if the start signal is turned off during restart operation.  
If the start signal turns on upon power restoration, the inverter starts at the starting frequency (Pr. 13). Keep the starting signal on during power failure.
- With speed search (H6=0,10): The motor will coast.
- With speed search (H6=0,10)
  - It will start at the starting frequency (Pr.13) when the speed search is less than 10Hz.
  - Restart operation is also performed after the inverter reset and retry reset.
  - The motor starts at the starting frequency when an instantaneous power failure occurs during restart voltage cushion time.
  - When the special motor is used, speed search can not be performed, the motor may start at the starting frequency.
- When speed search is selected (H6=0), automatic restart operation at a start is first performed after powering on and normal restart is performed thereafter.  
When speed search at starting (H6=10) is selected, restart operation is performed at each starting.  
There is delay time (Pr. 57 setting + speed search time) until frequency is output after the start command is input during restart operation.
- If two or more motors are connected to one inverter, speed search is not performed properly.  
Select without speed search (H6=1)
- The SU and FU signals are not output during a restart. They are output after the restart cushion time has elapsed.

## CAUTION

For the restart after instantaneous power failure operation without speed search (H6=1), the state (output frequency, rotation direction) before an instantaneous power failure cannot be stored in memory if the instantaneous power failure time is 0.2s or longer (changes according to the motor load condition) and the inverter restarts at the starting frequency (Pr.13).

## CAUTION

-  **When automatic restart after instantaneous power failure has been selected, the motor and machine will start suddenly (after the restart coasting time has elapsed) after occurrence of an instantaneous power failure. Stay away from the motor and machine.**  
**When you have selected automatic restart after instantaneous power failure, apply in easily visible places the CAUTION stickers supplied to the instruction manual (basic).**
-  **The motor is coasted to a stop as soon as you turn off the start signal or press the  during the restart cushion time after instantaneous power failure.**

### ◆ Related parameters ◆

- Retry reset ⇒ Pr.66 to Pr.69 (retry function) (Refer to page 99.)

## 2.8 Additional function parameters

### 2.8.1 Remote setting function selection (Pr. 59 **P59**)

If the operation panel is located away from the control box, you can use contact signals to perform continuous variable-speed operation, without using analog signals.

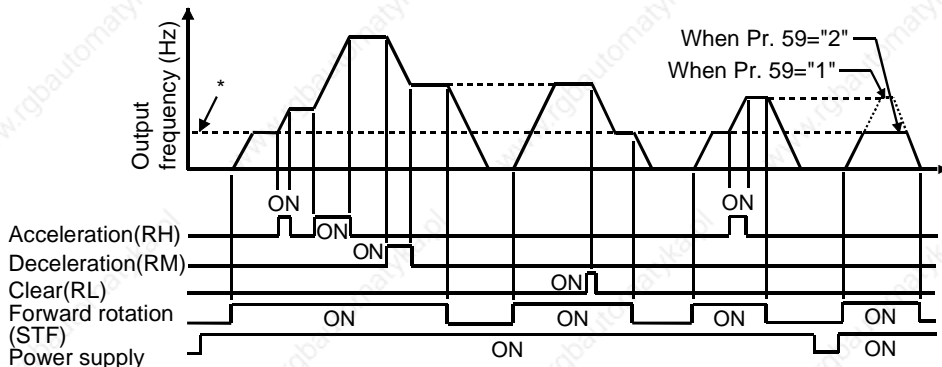

\* External running frequency (other than multi-speed) or PU running frequency

Parameter	Name	Factory Setting	Setting Range	Remarks
59	Remote setting function selection	0	0, 1, 2	Setting is enabled when Pr. 30 = "1"

#### REMARKS

- When the remote function is used, the output frequency of the inverter can be compensated for as follows:

External operation mode      Frequency set by RH/RM operation plus external analog frequency command

PU operation mode              Frequency set by RH/RM operation plus setting dial or PU digital preset frequency

<Operation panel operation procedure>

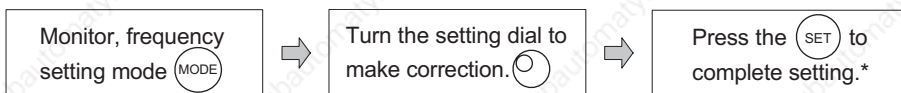

- \* When you have set "1" in Pr. 53 "frequency setting operation selection", you need not press the (SET).

**<Setting>**

Pr. 59 Setting	Operation	
	Remote setting function	Frequency setting storage function (E <sup>2</sup> PROM)
0	No	—
1	Yes	Yes
2	Yes	No

- Use Pr. 59 to select whether the remote setting function is used or not and whether the frequency setting storage function\* in the remote setting mode is used or not. When "remote setting function - yes" is selected, the functions of signals RH, RM and RL are changed to acceleration (RH), deceleration (RM) and clear (RL), respectively. Use Pr. 60 to Pr. 63 (input terminal function selection) to set the signals RH, RM, RL.

\* Frequency setting storage function

This function stores the remotely-set frequency (frequency set by RH/RM operation) into memory.

When power is switched off once, then on, operation is resumed with that output frequency value. (Pr. 59="1")



### <Frequency setting storage conditions>

- The frequency at which the start signal (STF or STR) turns off is stored.
- The remotely-set frequency is stored every one minute after one minute has elapsed since turn off (on) of both the RH (acceleration) and RM (deceleration) signals. (The frequency is written if the present frequency setting compared with the past frequency setting every one minute is different.) (The state of the RL signal dose not affect writing.)

#### REMARKS

- This function is invalid under jog operation and PID control operation.

Setting frequency is "0"

- Even when the remotely-set frequency is cleared by turning on the RL (clear) signal after turn off (on) of both the RH and RM signals, the inverter operates at the remotely-set frequency stored in the last operation if power is reapplied before one minute has elapsed since turn off (on) of both the RH and RM signals

remotely-set frequency stored in the last operation

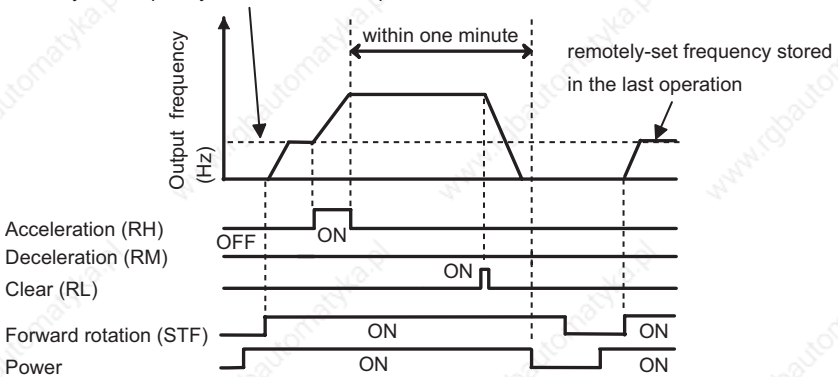

- When the remotely-set frequency is cleared by turning on the RL (clear) signal after turn off (on) of both the RH and RM signals, the inverter operates at the speed in the remotely-set frequency cleared state if power is reapplied after one minute has elapsed since turn off (on) of both the RH and RM signals.

remotely-set frequency stored in the last operation

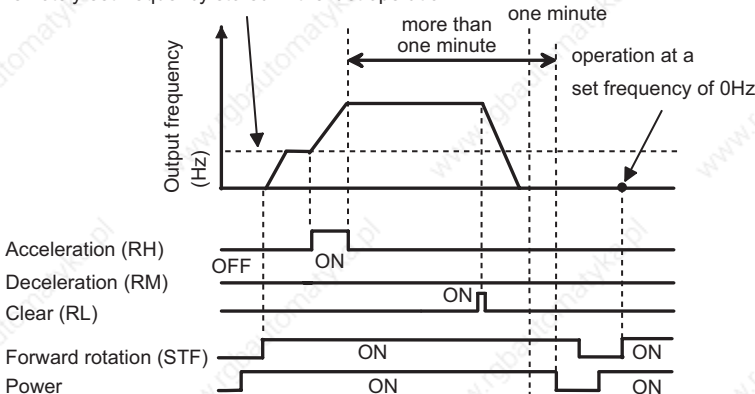

**CAUTION**

- The frequency can be varied by RH (acceleration) and RM (deceleration) between 0 and the maximum frequency (Pr. 1 setting).
- When the acceleration or deceleration signal switches on, the set frequency varies according to the slope set in Pr. 44 "second acceleration/deceleration time" or Pr. 45 "second deceleration time". The output frequency acceleration and deceleration times are as set in Pr. 7 "acceleration time" and Pr. 8 "deceleration time", respectively. Therefore, the longer preset times are used to vary the actual output frequency.
- If the start signal (STF or STR) is off, turning on the acceleration (RH) or deceleration (RM) signal varies the preset frequency.

**CAUTION**

⚠ When selecting this function, re-set the maximum frequency according to the machine.

**◆ Related parameters ◆**

- RH, RM, RL signal terminal assignment ⇒ Pr. 60 to Pr. 63 (input terminal function selection) (Refer to page 96.)
- Maximum frequency setting ⇒ Pr. 1 "maximum frequency" (Refer to page 62.)
- Output frequency acceleration/deceleration time ⇒ Pr. 7 "acceleration time", Pr. 8 "deceleration time" (Refer to page 65.)
- Time setting for acceleration/deceleration ⇒ Pr. 44 "second acceleration/deceleration time", Pr. 45 "second deceleration time" (Refer to page 65.)

**2.9 Terminal function selection parameters****2.9.1 Input terminal function selection (Pr. 60 **P60**, Pr. 61 **P61**, Pr. 62 **P62**, Pr. 63 **P63**)**

Use these parameters to select/change the input terminal functions.

Parameter	Name	Factory Setting	Setting Range	Remarks
60	RL terminal function selection	0	0 to 10, 14, 16	Setting is enabled when Pr. 30 = "1"
61	RM terminal function selection	1		
62	RH terminal function selection	2		
63	STR terminal function selection	---	0 to 10, 14, 16, ---	

**<Setting>**

Refer to the following table and set the parameters:

Setting	Signal Name	Functions		Related Parameters
0	RL	Pr. 59 = "0"	Low-speed operation command	Pr. 4 to Pr. 6, Pr. 24 to Pr. 27, Pr. 80 to Pr. 87
		Pr. 59 = "1", "2" (*1)	Remote setting (setting clear)	Pr. 59
1	RM	Pr. 59 = "0"	Middle-speed operation command	Pr. 4 to Pr. 6, Pr. 24 to Pr. 27, Pr. 80 to Pr. 87
		Pr. 59 = "1", "2" (*1)	Remote setting (deceleration)	Pr. 59
2	RH	Pr. 59 = "0"	High-speed operation command	Pr. 4 to Pr. 6, Pr. 24 to Pr. 27, Pr. 80 to Pr. 87
		Pr. 59 = "1", "2" (*1)	Remote setting (acceleration)	Pr. 59
3	RT	Second function selection		Pr. 44 to Pr. 47, H7
4	AU	Current input selection		—
5	STOP	Start self-holding selection		—
6	MRS	Output shut-off stop		—
7	OH	External thermal relay input (*2) The inverter stops when the externally provided thermal relay for overheat protection, motor's embedded temperature relay etc. is actuated.		Refer to page 158.
8	REX	15-speed selection (combination with 3 speeds RL, RM, RH) (*3)		Pr. 4 to Pr. 6, Pr. 24 to Pr. 27, Pr. 80 to Pr. 87
9	JOG	Jog operation selection		Pr. 15, Pr. 16
10	RES	Reset		Pr. 75
14	X14	PID control presence/absence selection		Pr. 88 to Pr. 94
16	X16	PU-external operation switch-over		Pr. 79 (setting: 8)
- - -	STR	Reverse rotation start		(can be assigned to STR terminal (Pr. 63) only)

\*1.When Pr. 59 = "1 or 2", the functions of the RL, RM and RH signals change as listed above.

\*2.Actuated when the relay contact "opens".

\*3.When using the REX signal, an external command cannot be used to make a reverse rotation start.

**REMARKS**

- One function can be assigned to two or more terminals. In this case, the function is activated when one of the multiple terminals used for assignment turns on.
- The speed command priorities are higher in order of jog, multi-speed setting (RH, RM, RL, REX) and AU.
- Use common terminals to assign multi-speeds (7 speeds) and remote setting. They cannot be set individually.  
(Common terminals are used since these functions are designed for speed setting and need not be set at the same time.)

## 2.9.2 Output terminal function selection (Pr. 64 ~~Pr. 64~~, Pr. 65 ~~Pr. 65~~)

You can change the functions of the open collector output terminal and contact output terminal.

Parameter	Name	Factory Setting	Setting Range	Remarks
64	RUN terminal function selection	0	0, 1, 3, 4, 11 to 16, 93, 95, 98, 99	Setting is enabled when Pr. 30 = "1"
65	A, B, C terminal function selection	99	0, 1, 3, 4, 11 to 16, 95, 98, 99	

### <Setting>

Setting	Signal Name	Function	Operation	Parameters Referred to
0	RUN	Inverter running	Output during operation when the inverter output frequency rises to or above the starting frequency.	Pr. 2, Pr. 13
1	SU	Up to frequency	Output when the output frequency is reached.	Pr. 41
3	OL	Overload alarm	Output while stall prevention function is activated.	Pr. 21, Pr. 22, Pr. 23, Pr. 28
4	FU	Output frequency detection	Output when the output frequency rises to or above the setting.	Pr. 42, Pr. 43
11	RY	Inverter operation ready	Output when the inverter is ready to be started by switching the start signal on.	—
12	Y12	Output current detection	Output when the output current rises to or above the setting.	Pr. 48, Pr. 49
13	Y13	Zero current detection	Output when the output current reaches 0.	Pr. 50, Pr. 51
14	FDN	PID lower limit	Outputs the detection signal under PID control.	Pr. 88 to Pr. 94
15	FUP	PID upper limit		
16	RL	PID forward-reverse rotation output		
93	Y93	Current average value monitor signal	The output current average value and maintenance timer value are output during the constant speed operation. (can be set to the RUN terminal (Pr.64) only)	H3 to H5
95	Y95	Maintenance timer alarm	Output when maintenance parameter H1 is greater than maintenance parameter H2.	H1, H2
98	LF	Minor fault output	Output when a minor fault (fan failure or communication error warning) occurs.	Pr. 76, n5
99	ABC	Alarm output	Output when the inverter's protective function is activated to stop the output (major fault).	—

### REMARKS

One function can be assigned to two terminals.

## 2.10 Operation selection function parameters

### 2.10.1 Retry function (Pr. 66 P66, Pr. 67 P67, Pr. 68 P68, Pr. 69 P69)

When any protective function (major fault) is activated and the inverter stops its output, the inverter itself resets automatically and performs retries. Whether retry is performed or not, alarms reset for retry, number of retries made and waiting time can be selected.

When you have selected automatic restart after instantaneous power failure (with speed search), restart operation is performed at the retry operation time which is the same of that of a power failure. (Refer to page 90 for automatic restart function.)

Parameter	Name	Factory Setting	Setting Range	Remarks
66	Retry selection	0	0 to 3	Setting is enabled when Pr. 30 = "1"
67	Number of retries at alarm occurrence	0	0, 1 to 10, 101 to 110	
68	Retry waiting time	1s	0.1 to 360s	
69	Retry count display erase	0	0	

#### <Setting>

- Use Pr. 66 to select the protective functions (major faults) to be activated for retries.

Pr. 66 Setting	Protective Functions (Major Faults) for Retries													
	OCT	OVT	THM	THT	FIN	GF	OHT	OLT	PE	PUE	RET	CPU	OPT	
0	●	●	●	●		●	●	●	●					●
1	●													
2		●												
3	●	●												

\* ● Indicates the retry items selected. (OCT denotes any of OC1 to OC3 and OVT any of OV1 to OV3.)

- Use Pr. 67 to set the number of retries at alarm occurrence.

Pr. 67 Setting	Number of Retries	Alarm Signal Output
0	Retry is not made.	————
1 to 10	1 to 10 times	Not output every time *
101 to 110	1 to 10 times	Output every time

\* If the retry count is exceeded, " r E r " (retry count over) is displayed.

- Use Pr. 68 to set the waiting time from when an inverter alarm occurs until a restart in the range 0.1 to 360s.
- Reading the Pr. 69 value provides the cumulative number of successful restart times made by retry. The cumulative number of time is cleared when setting value "0" is written.

## CAUTION

- The cumulative number in Pr. 69 is incremented by "1" when retry operation is regarded as successful, i.e. when normal operation is continued without the protective function (major fault) activated during a period four times longer than the time set in Pr. 68.
- If the protective function (major fault) is activated consecutively within a period four times longer than the above waiting time, the operation panel may show data different from the most recent data or the parameter unit (FR-PU04) may show data different from the first retry data. The data stored as the error reset for retry is only that of the protective function (major fault) which was activated the first time.
- When an inverter alarm is reset by the retry function at the retry time, the stored data of the electronic thermal relay function, etc. are not cleared. (Different from the power-on reset.)

## CAUTION

- ⚠ When you have selected the retry function, stay away from the motor and machine unless required. They will start suddenly (after the reset time has elapsed) after occurrence of an alarm.  
When you have selected the retry function, apply in easily visible places the CAUTION stickers supplied to the instruction manual (basic).

## 2.10.2 PWM carrier frequency and long wiring mode (Pr. 70

**Pr. 70, Pr. 72 Pr. 72)**

You can change the motor sound.

Parameter	Name	Factory Setting	Setting Range	Remarks
70	Soft-PWM setting	1	0, 1, 10, 11	Setting is enabled when
72	PWM frequency selection	1	0 to 15	Pr. 30 = "1"

### <Setting>

- By parameter setting, you can set whether to exercise Soft-PWM control that changes the motor tone or select with or without long wiring mode.
- Soft-PWM control is a control system that changes the motor noise from a metallic tone into an unoffending complex tone.
- Surge voltage is suppressed regardless of wiring length in the long wiring mode. (When operating the 400V motor with wiring length of 40m or longer, select the long wiring mode.)

Pr.70 Setting	Description		
	Soft-PWM	Long wiring mode	Remarks
0	Invalid	Invalid	—
1	Valid (When Pr. 72 setting = any of "0" to "5")	Invalid	—
10	Invalid	Valid	•When Pr. 72 "PWM frequency selection" = 1 or more, the PWM carrier frequency is constant at 1kHz. (When "0" is set, the PWM carrier frequency is constant at 0.7kHz.)
11	Valid	Valid	

### CAUTION

- 1.The output voltage at the rated frequency drops by a maximum of 5V.
- 2.For the 400V class, use an insulation-enhanced motor.  
Refer to page 19 for an inverter-driven 400V class motor.

Pr.72 Setting	Description
0 to 15	PWM carrier frequency can be changed. The setting displayed is in [kHz]. Note that 0 indicates 0.7kHz and 15 indicates 14.5kHz.

### REMARKS

- An increased PWM frequency will decrease the motor sound but increase noise and leakage currents. Therefore, perform the reduction techniques. (Refer to page 16.)
- Metallic sound may be generated from the motor at sudden deceleration but it is not a fault.

**Pr. 71** ➡ Refer to **Pr. 9** (page 67).

### 2.10.3 Voltage input selection (Pr. 73 **Pr. 73**)

You can change the input (terminal 2) specifications according to the frequency setting voltage signal. When entering 0 to 10VDC, always make this setting.

Parameter	Name	Factory Setting	Setting Range	Remarks	
73	0-5V/0-10V selection	0	0, 1	Terminal 2 input voltage 0: 0-5VDC input 1: 0-10VDC input	Setting is enabled when Pr. 30 = "1"

#### **CAUTION**

- The acceleration/deceleration time, which is a slope up/down to the acceleration/deceleration reference frequency, is not affected by the change in Pr. 73 setting.
- When connecting a frequency setting potentiometer across terminals 10-2-5 for operation, always set "0" in this parameter.



## 2.10.4 Input filter time constant (Pr. 74 **P74**)

You can set the input section's built-in filter constant for an external voltage or current frequency setting signal.

- Effective for eliminating noise in the frequency setting circuit.

Parameter	Name	Factory Setting	Setting Range	Remarks
74	Input filter time constant	1	0 to 8	Setting is enabled when Pr. 30 = "1"

### <Setting>

Increase the filter time constant if steady operation cannot be performed due to noise. A larger setting results in slower response. (The time constant can be set between approximately 1ms to 1s with the setting of 0 to 8. A larger setting results in a larger filter time constant.)



## 2.10.5 Reset selection/PU stop selection (Pr. 75 **P75**)

You can make reset input acceptance selection and choose the stop function from the operation panel (PU).

- Reset selection : You can choose the reset function input (RES signal) timing.
- PU stop selection : When an alarm etc. occurs in any operation mode, you can make a stop from the operation panel by pressing the .

Parameter	Name	Factory Setting	Setting Range	Remarks
75	Reset selection/ PU stop selection	14	0, 1, 14, 15	Setting is enabled when Pr. 30 = "1"

### <Setting>

Pr. 75 Setting	Reset Selection	PU Stop Selection
0	Reset input normally enabled.	The PU stop key is invalid. Note that the  is valid only in the PU operation mode or combined operation mode (Pr. 79 = "4").
1	Enabled only when the protective function is activated.	
14	Reset input normally enabled.	Pressing the  decelerates the inverter to a stop in any of the PU, external and communication operation modes.
15	Enabled only when the protective function is activated.	

## (1) How to make a restart after a stop by the **STOP RESET** input from the operation panel (Restarting method with **PS** shown)

1. After completion of deceleration to a stop, switch off the STF or STR signal.
2. Press the **PU** to show **PU**  
(**PS** canceled)
3. Press the **PU** to return to **EXT**.
4. Switch on the STF or STR signal.

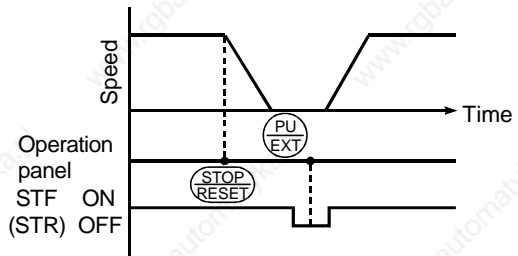

Stop and restart example for external operation

### REMARKS

- If the reset signal (RES) is provided during operation, the inverter shuts off its output while it is reset, the internal thermal integrated value of the electronic thermal relay function and the number of retries are reset, and the motor coasts.
- The Pr. 75 value can be set any time. Also, if parameter (all) clear is executed, this setting will not return to the initial value.
- When the inverter is stopped by the PU stop function, the display alternates between **PS** and **00**. An alarm is not output.

## (2) How to make a restart when a stop is made by the **STOP RESET** input from the PU

1. After completion of deceleration to a stop, switch off the STF or STR signal.
2. Press the **EXT**.  
(**PS** canceled)
3. Switch on the STF or STR signal.

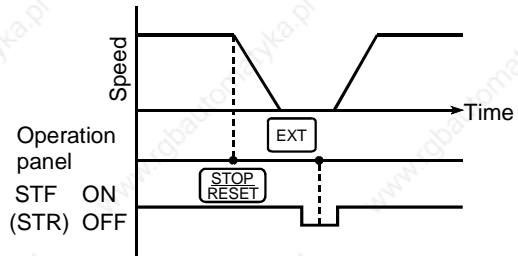

Stop and restart example for external operation

Besides the above operations, a restart can be made by performing a power-on reset or resetting the inverter with the inverter's reset terminal.

### REMARKS

- If the reset signal (RES) is provided during operation, the inverter shuts off its output while it is reset, the internal thermal integrated value of the electronic thermal relay function and the number of retries are reset, and the motor coasts.
- To resume operation, reset the inverter after confirming that the PU is connected securely.
- The Pr. 75 value can be set any time. Also, if parameter (all) clear is executed, this setting will not return to the initial value.
- When the inverter is stopped by the PU stop function, PS is displayed but an alarm is not output.

## ⚠ CAUTION

⚠ **Do not reset the inverter with the start signal on. Otherwise, the motor will start instantly after resetting, leading to potentially hazardous conditions.**

### 2.10.6 Cooling fan operation selection (Pr. 76 **Pr. 76**)

You can control the operation of the cooling fan built in the inverter (whether there is a cooling fan or not depends on the model.).

Parameter	Name	Factory Setting	Setting Range	Remarks
76	Cooling fan operation selection	0	0, 1	0: Operation is performed with power on. 1: Cooling fan ON/OFF control Setting is enabled when Pr. 30 = "1"

#### <Setting>

Setting	Description
0	Operated at power on (independent of whether the inverter is running or at a stop).
1	Cooling fan ON/OFF control valid ● Always on during inverter operation ● During stop (reset or error), the inverter status is monitored and the fan is switched on/off according to the temperature. <ul style="list-style-type: none"> <li>• Heatsink temperature is less than 40°C .....Cooling fan off</li> <li>• Heatsink temperature is not less than 40°C .....Cooling fan on</li> </ul>

#### REMARKS

In either of the following cases, fan operation is regarded as faulty,  $F_n$  is shown on the operation panel, and the minor fault (LF) signal is output. Use any of Pr. 64, Pr. 65 (output terminal function selection) to allocate the terminal used to output the LF signal.\*

- Pr. 76 = "0"  
When the fan comes to a stop with power on.
- Pr. 76 = "1"  
When the inverter is running and the fan stops during fan ON command.

#### CAUTION

\* When the terminal assignment is changed using Pr. 64, Pr. 65, the other functions may be affected. Confirm the functions of the corresponding terminals before making settings.

## 2.10.7 Parameter write disable selection (Pr. 77 **Pr. 77**)

You can select between write-enable and disable for parameters. This function is used to prevent parameter values from being rewritten by incorrect operation.

Parameter	Name	Factory Setting	Setting Range	Remarks
77	Parameter write disable selection	0	0, 1, 2	Setting is enabled when Pr. 30 = "1"

### <Setting>

Pr. 77 Setting	Function
0	Write is enabled only during a stop in the PU operation mode. (*)
1	Write disabled. Values of Pr. 22, Pr. 30, Pr. 75, Pr. 77 and Pr. 79 can be written.
2	Write is enabled even during operation. Write is enabled independently of the operation mode.

### CAUTION

- \*The shaded parameters in the parameter list always allow setting. Note that the Pr. 70 and Pr. 72 values may be changed during PU operation only.
- If Pr. 77 = 2, the values of Pr. 17, Pr. 23, Pr. 28, Pr. 60 to Pr. 63, Pr. 64, Pr. 65, Pr. 71, Pr. 79, Pr. 98, Pr. 99, CLr cannot be written during operation. Stop operation when changing their parameter settings.
- By setting "1" in Pr. 77, the following clear operations can be inhibited:
  - Parameter clear
  - All clear

## 2.10.8 Reverse rotation prevention selection (Pr. 78 **Pr. 78**)

This function can prevent reverse rotation faults resulting from the incorrect input of the start signal.

### POINT

Used for a machine which runs only in one direction, e.g. fan, pump.  
(The setting of this function is valid for the combined, PU, external and communication operations.)

Parameter	Name	Factory Setting	Setting Range	Remarks
78	Reverse rotation prevention selection	0	0, 1, 2	Setting is enabled when Pr. 30 = "1"

### <Setting>

Pr. 78 Setting	Function
0	Both forward and reverse rotations allowed
1	Reverse rotation disallowed
2	Forward rotation disallowed

## 2.10.9 Operation mode selection (Pr. 79 **Pr. 79**)

Used to select the operation mode of the inverter.

The inverter can be run from the operation panel or parameter unit (PU operation), with external signals (external operation), or by combination of PU operation and external operation (external/PU combined operation).

The inverter is placed in the external operation mode at power on (factory setting).

Parameter	Name	Factory Setting	Setting Range
79	Operation mode selection	0	0 to 4, 7, 8

**<Setting>**

In the following table, operation using the operation panel or parameter unit is abbreviated to PU operation.

Pr. 79 Setting	Function			LED Indication *		
				RUN	PU	EXT
0	At power on, the inverter is put in the external operation mode. The operation mode can be changed between the PU and external operation modes from the operation panel ( $\begin{matrix} \text{PU} \\ \text{EXT} \end{matrix}$ ) or parameter unit ( $\begin{matrix} \text{PU} \\ \text{EXT} \end{matrix}$ ). For each mode, refer to the columns of settings 1 and 2.					Refer to settings "1" and "2".
1	<b>Operation mode</b>	<b>Running frequency</b>	<b>Start signal</b>	Off: Stop without start command	On (Off)	Off
	PU operation mode	Setting from operation panel or FR-PU04	$\begin{matrix} \text{RUN} \end{matrix}$			
2	External operation mode	External signal input (across terminals 2(4)-5, multi-speed selection) jog	External signal input (terminal STF, STR)	Forward rotation: On Reverse rotation: Slow flickering	Off	On
3	External/ PU combined operation mode 1	Setting dial of operation panel, digital setting by parameter unit key operation, or external signal input (multi-speed setting, across terminals 4-5 (valid when AU signal is on))	External signal input (terminal STF, STR)	With start command } Without frequency setting } Fast flickering	On	On
4	External/ PU combined operation mode 2	External signal input (across terminals 2(4)-5, multi-speed selection, jog)	$\begin{matrix} \text{RUN} \end{matrix}$			
7	External operation mode (PU operation interlock) MRS signal ON... Switching to PU operation mode (output stop during external operation) allowed MRS signal OFF.. Switching to PU operation mode inhibited					Refer to settings "1" and "2".
8	Operation mode change using external signal (disallowed during operation) X16 signal ON .... Switched to external operation mode X16 signal OFF.....Switched to PU operation mode					

**REMARKS**

- In other than the PU operation mode, the stop function (PU stop selection) activated by pressing  $\begin{matrix} \text{STOP} \\ \text{RESET} \end{matrix}$  of the PU (operation panel/FR-PU04) is valid. (Refer to page 103.)
  - Either "3" or "4" may be set to select the PU/external combined operation, and these settings differ in starting method.
  - Refer to page 128 for the computer link operation mode.
- \*When the FR-PU04 is connected, the LED indicators (PU, EXT) are not lit.  
In the computer link operation mode, the LED indicators (PU, EXT) flicker slowly.

## (1) PU operation interlock

PU operation interlock forces the operation mode to be changed to the external operation mode when the MRS signal switches off. This function prevents the inverter from being inoperative by the external command if the mode is accidentally left unswitched from the PU operation mode.

### 1) Preparation

- Set "7" (PU operation interlock) in Pr. 79.
- Set the terminal used for MRS signal input with any of Pr. 60 to Pr. 63 (input terminal function selection).

Refer to page 96 for Pr. 60 to Pr. 63 (input terminal function selection).

### CAUTION

**When terminal assignment is changed using Pr. 60 to Pr. 63, the other functions may be affected.**

**Check the functions of the corresponding terminals before making settings.**

### 2) Function

MRS Signal	Function/Operation
ON	Output stopped during external operation. Operation mode can be switched to PU operation mode. Parameter values can be rewritten in PU operation mode. PU operation allowed.
OFF	Forcibly switched to external operation mode. External operation allowed. Switching to PU operation mode inhibited.

### <Function/operation changed by switching on-off the MRS signal>

Operating Condition Operation mode	Status	MRS Signal	Operation Mode (*2)	Operating Status	Parameter Write	Switching to PU Operation Mode
During operation	ON → OFF (*1)	If external operation frequency setting and start signal are entered, operation is performed in that status.	Allowed → disallowed	Disallowed		
External	During stop	OFF → ON	External	During stop	Disallowed → disallowed	Allowed
		ON → OFF			Disallowed → disallowed	Disallowed
	During operation	OFF → ON		During operation → output stop	Disallowed → disallowed	Disallowed
		ON → OFF		Output stop → operation	Disallowed → disallowed	Disallowed

**REMARKS**

- If the MRS signal is on, the operation mode cannot be switched to the PU operation mode when the start signal (STF, STR) is on.
- \*1. The operation mode switches to the external operation mode independently of whether the start signal (STF, STR) is on or off.  
Therefore, the motor is run in the external operation mode when the MRS signal is switched off with either of STF and STR on.
- \*2. Switching the MRS signal on and rewriting the Pr. 79 value to other than "7" in the PU operation mode causes the MRS signal to act as the ordinary MRS function (output stop). Also as soon as "7" is set in Pr. 79, the signal acts as the PU interlock signal.

**(2) Operation mode switching by external signal**

1) Preparation

Set "8" (switching to other than external operation mode) in Pr. 79.

Use any of Pr. 60 to Pr. 63 (input terminal function selection) to set the terminal used for X16 signal input.

**CAUTION**

**When terminal assignment is changed using Pr. 60 to Pr. 63, the other functions may be affected.**

**Check the functions of the corresponding terminals before making settings.**

**For details refer to page 96.**

2) Function

This switching is enabled during an inverter stop only and cannot be achieved during operation.

X16 Signal	Operation Mode
ON	External operation mode (cannot be changed to the PU operation mode)
OFF	PU operation mode (cannot be changed to the external operation mode)

**P80** to **P87** ➡ Refer to **P 4** to **P 5** (page 64).



## 2.10.10 PID control (Pr. 88 ~~988~~ to Pr. 94 ~~994~~)

The inverter can be used to exercise process control, e.g. flow rate, air volume or pressure.

- The voltage input signal (0 to +5V or 0 to +10V) or Pr. 93 setting is used as a set point and the 4 to 20mA DC current input signal used as a feedback value to constitute a feedback system for PID control.

### POINT

Made valid by turning on the X14 signal. Use Pr. 60 to Pr. 63 (input terminal function selection) to make assignment.

Parameter	Name	Factory Setting	Setting Range	Remarks
88	PID action selection	20	20, 21	Setting is enabled when Pr. 30 = "1"
89	PID proportional band	100%	0.1 to 999%, ---	
90	PID integral time	1s	0.1 to 999s, ---	
91	PID upper limit	---	0 to 100%, ---	
92	PID lower limit	---	0 to 100%, ---	
93	PID action set point for PU operation	0%	0 to 100%	
94	PID differential time	---	0.01 to 10s, ---	

### <Setting>

#### (1) Basic PID control configuration

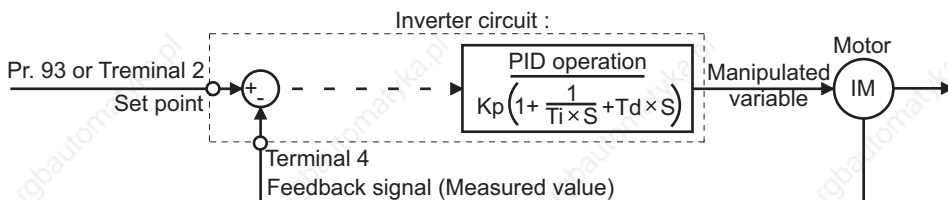

Kp: Proportion constant    Ti: Integral time    S: Operator    Td: Differential time

#### (2) PID action overview

##### 1) PI action

A combination of proportional control action (P) and integral control action (I) for providing a manipulated variable in response to deviation and changes with time.

##### [Operation example for stepped changes of measured value]

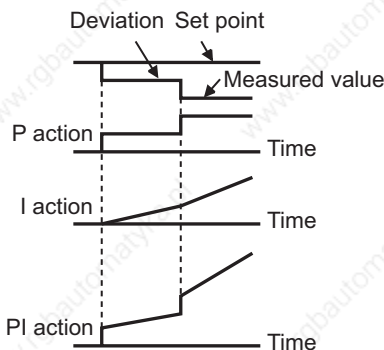

### REMARKS

PI action is the sum of P and I actions.

2) PD action

A combination of proportional control action (P) and differential control action (D) for providing a manipulated variable in response to deviation speed to improve the transient characteristic.

**[Operation example for proportional changes of measured value]**

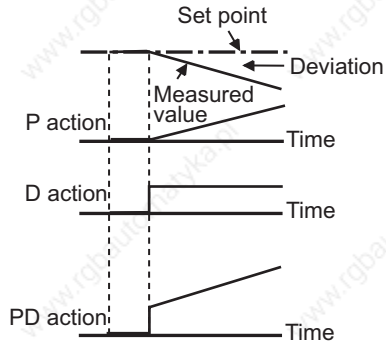

3) PID action

The PI action and PD action are combined to utilize the advantages of both actions for control.

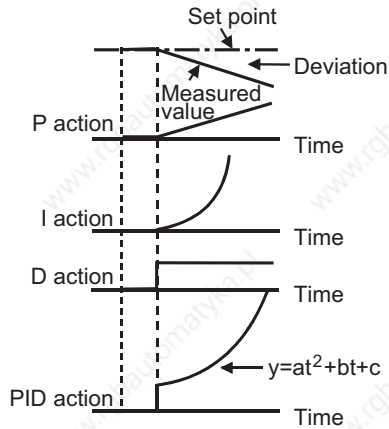

**REMARKS**

The PID action is the sum of P, I and D actions.

4) Reverse action

Increases the manipulated variable (output frequency) if deviation  $X = (\text{set point} - \text{measured value})$  is positive, and decreases the manipulated variable if deviation is negative.

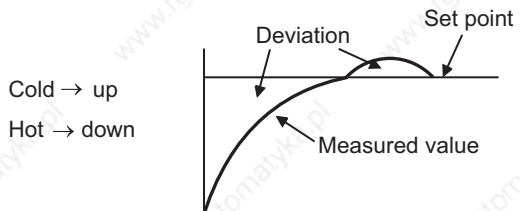
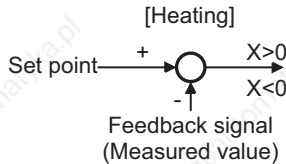

5) Forward action

Increases the manipulated variable (output frequency) if deviation  $X = (\text{set point} - \text{measured value})$  is negative, and decreases the manipulated variable if deviation is positive.

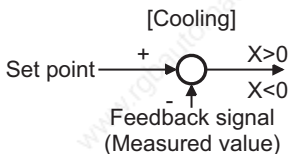

Too cold → down  
Hot → up

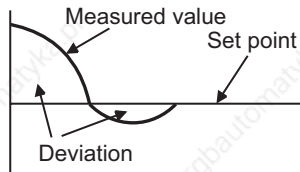

Relationships between deviation and manipulated variable (output frequency)

	Deviation	
	Positive	Negative
Reverse action	↗	↘
Forward action	↘	↗

(3) Wiring example

- Pr. 60 = 14
- Pr. 64 = 15
- Pr. 65 = 16
- Pr. 88 = 20

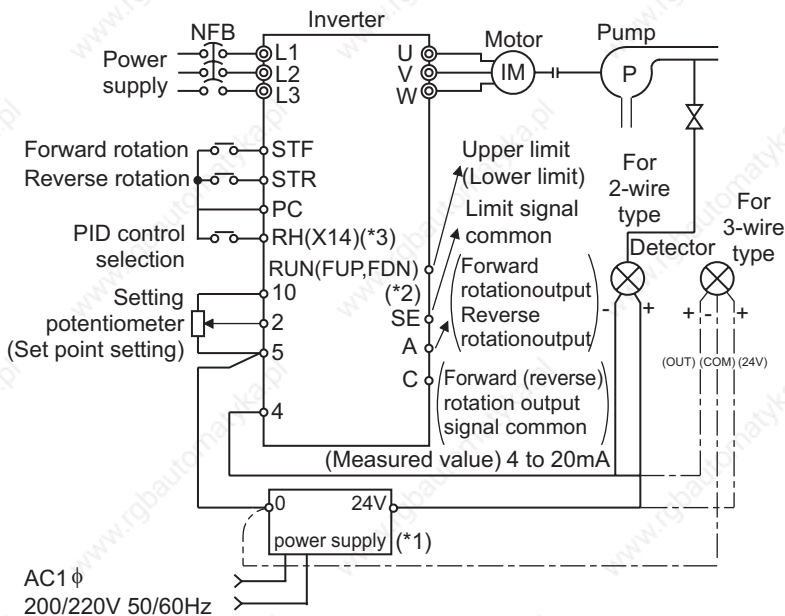

**CAUTION**

- \*1.The power supply must be selected in accordance with the power specifications of the detector used.
- \*2.The output signal terminal used depends on the Pr. 64, Pr. 65 settings.
- \*3.The input signal terminal used depends on the setting of Pr. 60 to Pr. 63.
- The contact input signal (AU Signal) need not be turned on.

### (4) I/O signals

Signal		Terminal Used	Function	Description
Input	X14	Depending on Pr. 60 to Pr. 63	PID control selection	Turn on X14 to exercise PID control.
	2	2	Set point input	Enter the set point for PID control.
	4	4	Measured value input	Enter the 4 to 20mADC measured value signal from the detector.
Output	FUP	Depending on Pr. 64, Pr. 65	Upper limit output	Output to indicate that the measured value signal exceeded the upper limit value.
	FDN		Lower limit output	Output to indicate that the measured value signal exceeded the lower limit value.
	RL		Forward (reverse) rotation direction output	"Hi" is output to indicate that the output indication of the parameter unit is forward rotation (FWD) or "Low" to indicate that it is reverse rotation (REV) or stop (STOP).

- Enter the set point across inverter terminals 2-5 or in Pr. 93 and enter the measured value signal across inverter terminals 4-5.
- To exercise PID control, turn on the X14 signal. When this signal is off, PID control is not exercised.

Item	Entry	Description	
Set point	Across terminals 2-5	Set 0V as 0% and 5V as 100%.	When "0" is set in Pr. 73 (5V selected for terminal 2).
		Set 0V as 0% and 10V as 100%.	When "1" is set in Pr. 73 (10V selected for terminal 2).
	Pr. 93	Set the set point (%) in Pr. 93.	
Measured value	Across terminals 4-5	4mA is equivalent to 0% and 20mA to 100%.	

### (5) Parameter setting

Parameter Number	Name	Setting	Description	
88	PID action selection	20	For heating, pressure control, etc.	PID reverse action
		21	For cooling, etc.	PID forward action
89	PID proportional band	0.1 to 999%	If the proportional band is narrow (parameter setting is small), the manipulated variable varies greatly with a slight change of the measured value. Hence, as the proportional band narrows, the response sensitivity (gain) improves but the stability deteriorates, e.g. hunting occurs. Gain $K = 1/\text{proportional band}$	
		- - -	No proportional control	
90	PID integral time	0.1 to 999s	Time required for the integral (I) action to provide the same manipulated variable as that for the proportional (P) action. As the integral time decreases, the set point is reached earlier but hunting occurs more easily.	
		- - -	No integral control.	

Parameter Number	Name	Setting	Description
91	PID upper limit	0 to 100%	Set the upper limit. If the feedback value exceeds the setting, the FUP signal is output. (Measured value of 4mA is equivalent to 0% and 20mA to 100%.)
		- - -	No function
92	PID lower limit	0 to 100%	Set the lower limit. (If the measured value falls below the setting, the FDN signal is output. In this case, the measured value of 4mA is equivalent to 0% and 20mA to 100%.)
		- - -	No function
93	PID action set point for PU operation	0 to 100%	Valid only when Pr. 79 = "3" (n9 = 0 for computer link operation) under the PU command in the PU operation or PU/external combined mode. (When the computer has the speed command source in the computer link operation mode (NET)) For external operation, the voltage across 2-5 is the set point. (C3 value is equivalent to 0% and C4 value to 100%.)
94	PID differential time	0.01 to 10s	Time required for the differential (D) action to provide the same measured value as that for the proportional (P) action. As the differential time increases, greater response is made to a deviation change.
		- - -	No differential control.

## (6) Adjustment procedure

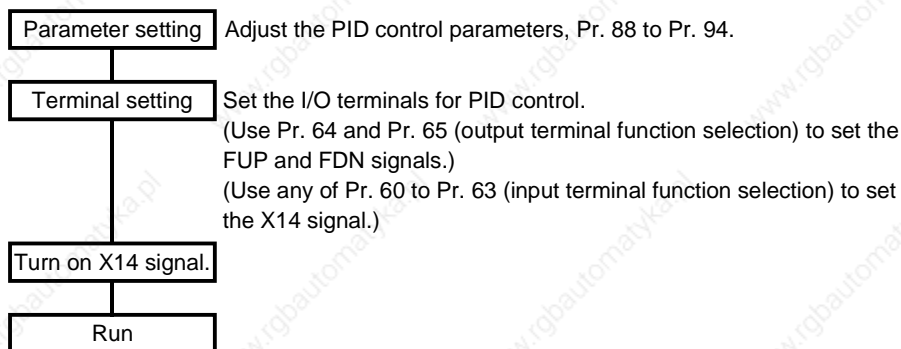

### (7) Calibration example

(A detector of 4mA at 0°C and 20mA at 50°C is used to adjust the room temperature to 25°C under PID control. The set point is given to across inverter terminals 2-5 (0-5V).)

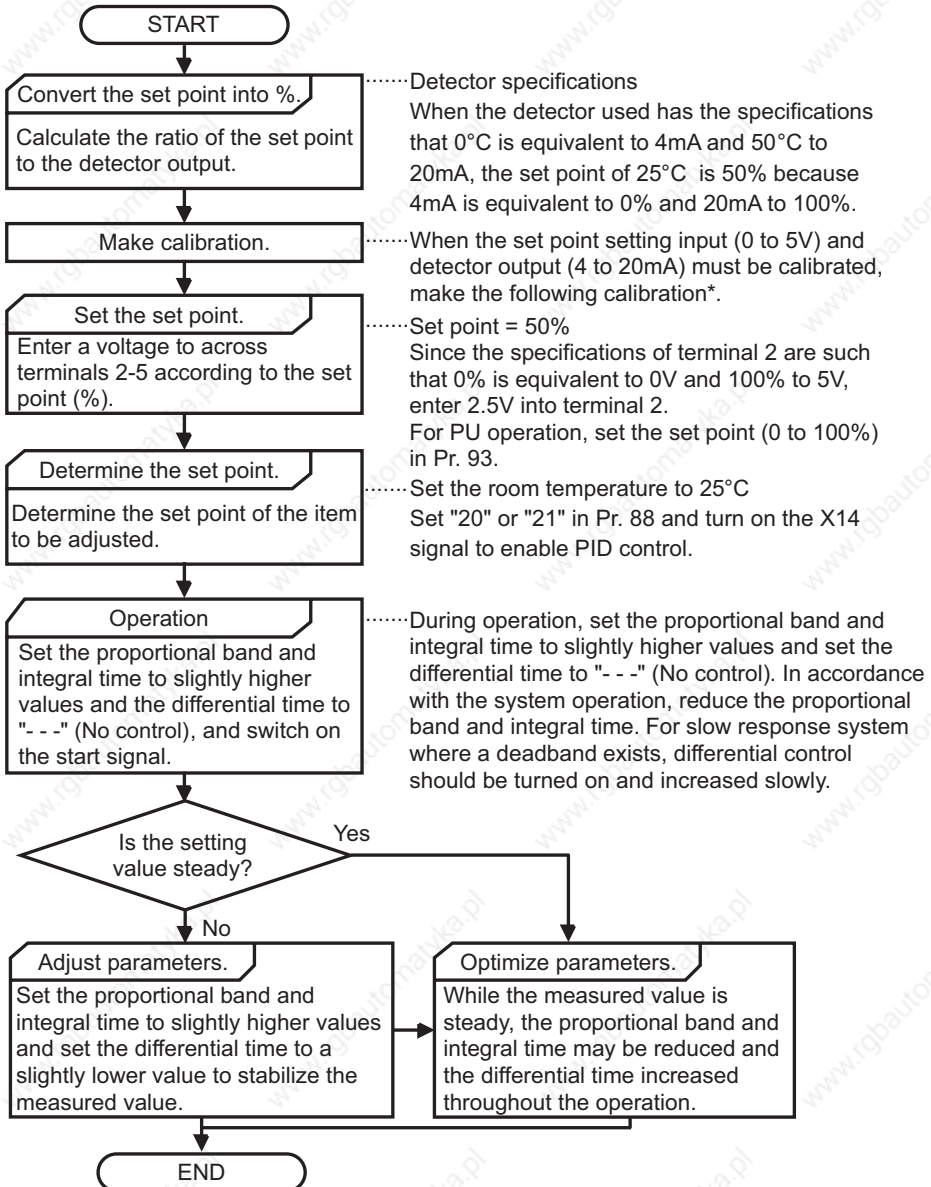

\*When calibration → Use Pr. 38 and calibration parameters C2 to C4 (terminal 2) and Pr. 39 and calibration parameters C5 to C7 (terminal 4) to calibrate the detector output and set point setting input. Make calibration in the PU mode when the inverter is at a stop.

### <Set point input calibration>

1. Apply the input voltage of 0% set point setting (e.g. 0V) across terminals 2-5.
2. Make calibration using the calibration parameters C2, C3. At this time, enter in C2 the frequency which should be output by the inverter at the deviation of 0% (e.g. 0Hz). (When using the FR-PU04, make calibration with Pr. 902.)
3. Apply the voltage of 100% set point (e.g. 5V) to across terminals 2-5.
4. Make calibration using Pr. 38 and calibration parameter C4. At this time, enter in Pr. 38 the frequency which should be output by the inverter at the deviation of 100% (e.g. 50Hz). (When using the FR-PU04, make calibration with Pr. 903.)

### <Detector output calibration>

1. Apply the output current of 0% detector setting (e.g. 4mA) across terminals 4-5.
2. Make calibration using the calibration parameter C6. (When using the FR-PU04, make calibration with Pr. 904.)
3. Apply the output current of 100% detector setting (e.g. 20mA) across terminals 4-5.
4. Make calibration using the calibration parameter C7. (When using the FR-PU04, make calibration with Pr. 905.)

Note: The frequencies set in the calibration parameter C5 and Pr. 39 should be equal to those set in the calibration parameter C2 and Pr. 38, respectively.

The results of the above calibration are as shown below:

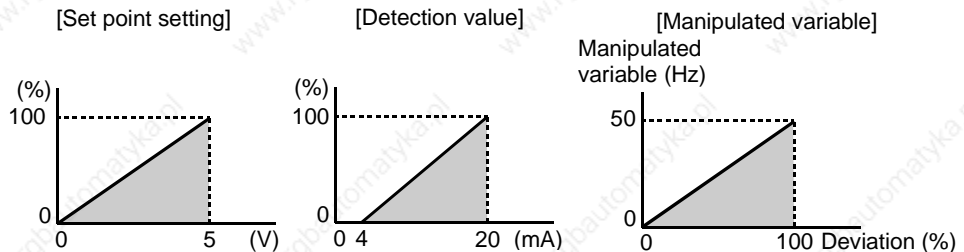

#### REMARKS

- If the multi-speed (RH, RM, RL signal) or jog operation (JOG signal) is entered, PID control is stopped and multi-speed or jog operation is started.
- When the terminal functions are changed using Pr. 60 to Pr. 65, the other functions may be affected. Confirm the functions of the corresponding terminals before making settings.
- When PID control is selected, the minimum frequency is the frequency set in the calibration parameter C2 and the maximum frequency is the frequency set in Pr. 38. (The Pr. 1 "maximum frequency" and Pr. 2 "minimum frequency" settings are also valid.)

#### ◆ Related parameters ◆

- X14 signal assignment ⇒ Pr. 60 to Pr. 63 (input terminal function selection) (refer to page 96)
- FUP, FDN and RL signal assignment ⇒ Pr. 64 "RUN terminal function selection", Pr. 65 "A, B, C terminal function selection" (refer to page 98)
- Voltage input selection (0 to ±5V, 0 to ±10V) ⇒ Pr. 73 "0-5V/0-10V selection" (refer to page 102)
- Operation mode selection ⇒ Pr. 79 "operation mode selection" (refer to page 107)
- Making terminal calibration ⇒ Pr. 38, Pr. 39, C2 to C7 (calibration parameters) (refer to page 80)

## 2.11 Auxiliary parameters

### 2.11.1 Slip compensation (Pr. 95 **Pr. 95**, Pr. 96 **Pr. 96**, Pr. 97 **Pr. 97**)

The inverter output current may be used to assume motor slip to keep the motor speed constant.

Parameter	Name	Factory Setting	Setting Range	Remarks
95	Rated motor slip	---	0 to 50%, ---	Setting is enabled when Pr. 30 = "1"
96	Slip compensation time constant	0.5s	0.01 to 10s	
97	Constant-output region slip compensation selection	---	0, ---	

#### <Setting>

$$\text{Rated slip} = \frac{\text{Synchronous speed at base frequency} - \text{rated speed}}{\text{Synchronous speed at base frequency}} \times 100[\%]$$

Parameter	Setting	Function
95	0.01 to 50%	Used to set the rated motor slip.
	0, ---	Slip compensation is not made.
96	0.01 to 10s	Used to set the slip compensation response time. (*)
97	0	Slip compensation is not made in the constant output range (frequency range above the frequency set in Pr. 3).
	---	Slip compensation is made in the constant output range.

\*When this value is made smaller, response will be faster.

However, as load inertia is greater, a regenerative overvoltage (OVT) error is more liable to occur.

#### REMARKS

When making slip compensation at 50Hz, set the maximum frequency (Pr. 1) to slightly higher than 50Hz.

In the factory setting status, it is clamped at 50Hz.



## 2.11.2 Automatic torque boost selection (Pr. 98 ~~998~~)

You can choose automatic torque boost control.

● Automatic torque boost control

Not only gives the motor the optimum excitation but also provides high torque even in a low speed range.

Parameter	Name	Factory Setting	Setting Range	Remarks
98	Automatic torque boost selection (motor capacity)	- - -	0.1 to 3.7kW, - - -	Setting is enabled when Pr. 30 = "1"

### <Operating conditions>

- The number of motor poles should be any of 2, 4 and 6 poles.
- Single-motor operation (One motor for one inverter)
- The wiring length from inverter to motor should be within 30m.

### <Setting>

Parameter	Setting	Description
98	- - -	Ordinary V/F control and torque boost (Pr. 0, Pr. 46) are valid.
	0.1 to 3.7kW	Automatic torque boost control valid (Set the applied motor capacity or one rank lower motor capacity.)

- Also when the Pr. 98 setting is other than "- - -", Pr. 3 "base frequency" and Pr. 19 "base frequency voltage" are valid.
- When "- - -" or "888" is set in Pr. 19, the rated output voltage is selected.

### CAUTION

During operation using automatic torque boost, write to Pr. 3 and Pr. 19 is disabled even if "2" is set in Pr. 77.

### ◆ Related parameters ◆

- Torque boost ⇒ Pr. 0 "torque boost", Pr. 46 "second torque boost" (refer to page 61)
- Base frequency ⇒ Pr. 3 "base frequency", Pr. 19 "base frequency voltage" (refer to page 63)
- Applied motor setting ⇒ Pr. 71 "applied motor" (refer to page 67)
- Motor primary resistance ⇒ Pr. 99 "motor primary resistance" (refer to page 120)

### 2.11.3 Motor primary resistance (Pr. 99 )

Generally this parameter need not be set. At the factory setting of "- - -", the standard motor constant of the motor capacity set in Pr. 98 (including that of the constant-torque motor) is used.

Parameter	Name	Factory Setting	Setting Range	Remarks
99	Motor primary resistance	- - -	0 to 50Ω, - - -	Setting is enabled when Pr. 30 = "1"

#### ◆ Related parameters ◆

- Applied motor setting ⇒ Pr. 71 "applied motor" (refer to page 67)
- Automatic torque boost selection ⇒ Pr. 98 "automatic torque boost selection" (refer to page 119)

## 2.12 Maintenance parameters

### 2.12.1 Maintenance output function (H1 , H2 )

The maintenance timer alarm signal (Y95) is output when the cumulative energization time (H1 "maintenance timer") of the inverter reaches the time set in H2 "maintenance alarm output set time". (Used to alert the operator of the main circuit smoothing capacitor life expiration, for example.)

Parameter	Name	Factory Setting	Setting Range	Remarks
H1 (503)	Maintenance timer	0	0 to 999	Write disabled
H2 (504)	Maintenance alarm output set time	36 (36000h)	0 to 999, - - -	- - -: Function as 36000h

The parameter numbers in parentheses are those for use with the parameter unit (FR-PU04).

#### <Setting>

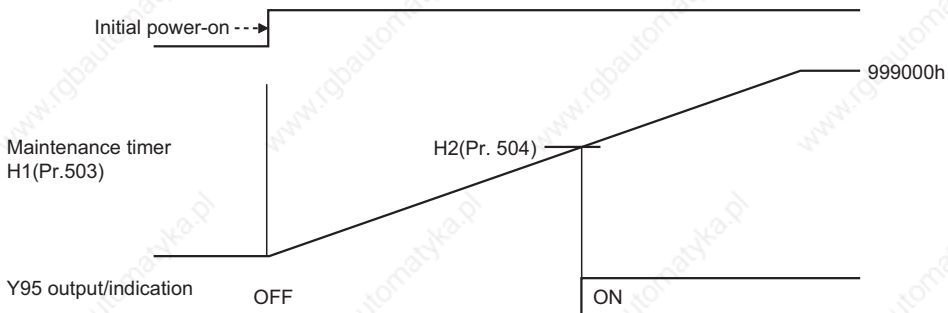

## 1) H1 (Pr. 503) "maintenance timer"

- The cumulative energization time of the inverter is stored into the E<sup>2</sup>PROM every hour and indicated in 1000h increments. (Cannot be written.)
- The maintenance timer is clamped at 999 (999000h).

## 2) H2 (Pr. 504) "maintenance alarm output set time"

- Set the time when the maintenance timer alarm signal (Y95) is output.
- The setting unit is 1000h.

**REMARKS**

The factory setting (36000h) is the guideline for the main circuit smoothing capacitor life (about 10 years in the operating environment of 40°C ambient temperature, 10h/day, and 365 days/year) of the inverter. The lifetime changes depending on the operating environment of the inverter.

## 3) Maintenance timer alarm signal (Y95)

- Made valid by setting "95" (maintenance timer alarm output signal) in Pr. 64 or Pr. 65 (output terminal function selection).
- If the value set in H2 is equal to or greater than the H1 setting, the maintenance timer alarm output (Y95) turns off.

## ◆Related parameters◆

- Assignment of Y95 signal to terminal ⇒ Pr. 64 "RUN terminal function selection", Pr. 65 "A, B, C terminal function selection" (Refer to page 98)

**2.12.2 Current average value monitor signal****(H3 H3, H4 H4, H5 H5)**

The average value of the output current during constant speed operation and the maintenance timer value (maintenance parameter H1) are output as pulses to the current average value monitor signal (Y93).

The pulse width measured by inputting the signal to the I/O module of the PLC or the like can be used as a guideline for increase in output current due to abrasion of peripheral machines and elongation of belt and for aged deterioration of peripheral devices to know the maintenance time.

The current average value monitor signal (Y93) is output as pulse for 20s as 1 cycle and repeatedly output during constant speed operation.

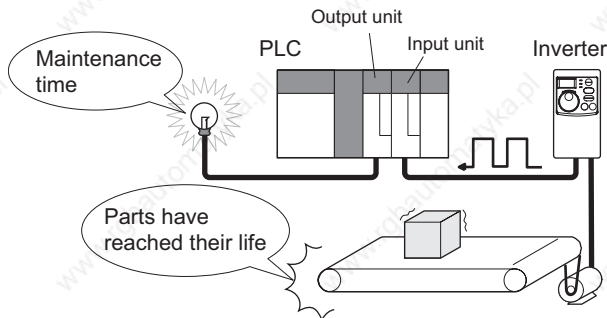

Parameter	Name	Factory Setting	Setting Range	Remarks
H3 (555)	Current average time	1s	0.1 to 1s	Setting is enabled when Pr. 30 = "1"
H4 (556)	Data output mask time	0s	0 to 20s	
H5 (557)	Current average value monitor signal output reference current	1A	0.1 to 999A	

The parameter number in parentheses is the one for use with the parameter unit (FR-PU04).

<Pulse operation>

The output pulse of the Y93 signal is shown below.

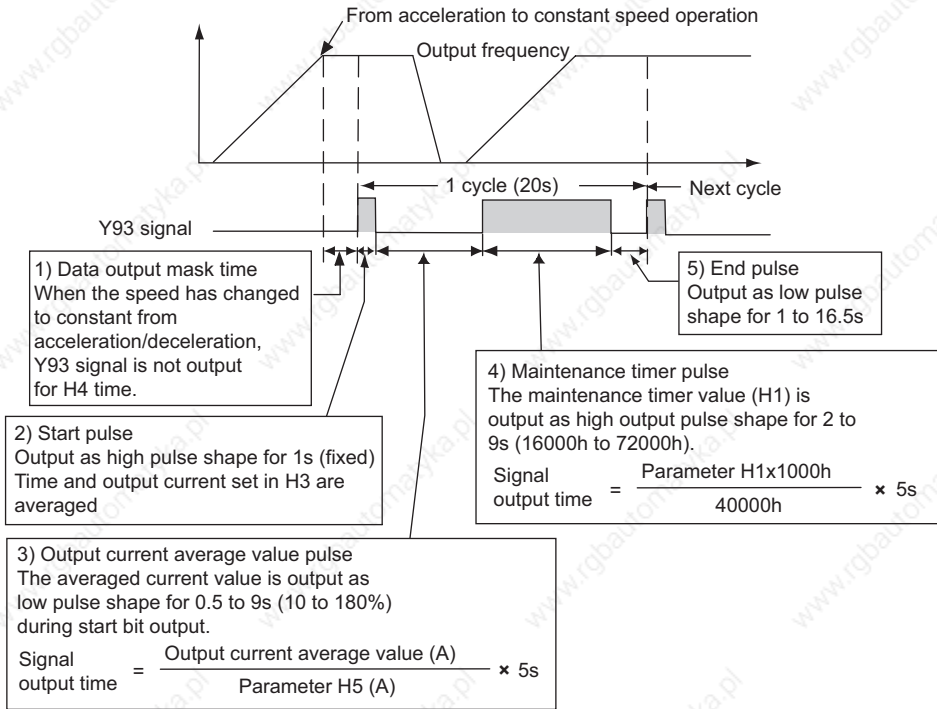

<Setting>

Perform setting according to the following steps.

- 1) Setting of maintenance parameter H4 "data output mask time"  
The output current is unstable (transient state) right after the operation is changed from the acceleration/deceleration state to the constant speed operation. Set the time for not obtaining (mask) transient state data in H4.
- 2) Setting of maintenance parameter H3 "output current average time"  
The average output current is calculated during Hi output of start bit (1s). Set the time taken to average the current during start bit output in H3.
- 3) Setting of maintenance parameter H5 "output reference current"  
Set the reference (100%) for outputting the signal of the current average value. Obtain the time to output the signal from the following calculation.

Output current average value

$$\frac{\text{Setting value of output reference current (H5)}}{\text{Output current average value (100\%/5s)}} \times 5s$$

Note that the output time range is 0.5s to 9s, and it is 0.5s when the output current average value is less than 10% of the setting value of output reference current (H5) and 9s when exceeds 180%.

Example) when H5=10A and the average value of output current is 15A

As  $15A/10A \times 5s = 7.5s$ , the current average value monitor signal is output as low pulse shape for 7.5s.

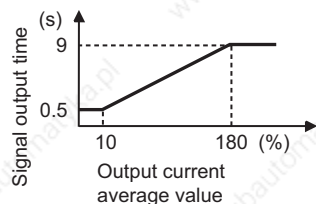

## 4) Output of maintenance timer value (maintenance parameter H1)

After the output current average value is output as low pulse shape, the maintenance timer value is output as high pulse shape. The output time of the maintenance timer value is obtained from the following calculation.

$$\frac{\text{Maintenance timer value (H1)}}{40000\text{h}} \times 5\text{s (Maintenance timer value 100\%/5s)}$$

Note that the output time range is 2 to 9s, and it is 2s when the maintenance timer value (H1) is less than 16000h and 9s when exceeds 72000h.

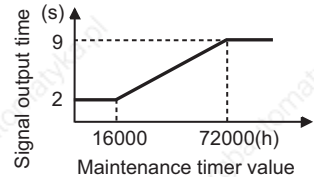
**REMARKS**

- Mask of data output and sampling of output current are not performed during acceleration/deceleration.
- Set "93" in Pr. 64 and assign the current average value monitor signal (Y93) to the RUN terminal. It can not be assigned to the ABC contact (Pr.65)
- When the speed is changed to acceleration/deceleration from constant speed during start bit output, the data is judged as invalid, the start bit is output as high pulse shape for 3.5s, and the end signal is output as low pulse shape for 16.5s.

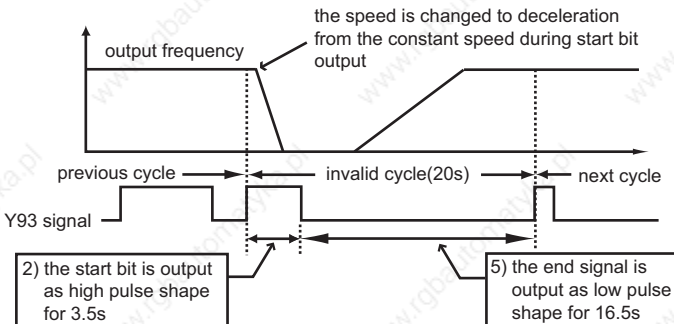

The signal is output for at least 1 cycle even when acceleration/deceleration state continues after the start bit output is completed.

- When the output current value (inverter output current monitor) is 0A on completion of the 1 cycle signal output, the signal is not output until the speed becomes constant next time.
- The current average value monitor signal (Y93) is output as low pulse shape for 20s (without data output) under the following condition.
  - (1) when the motor is in the acceleration/deceleration state on completion of the 1 cycle signal output
  - (2) when the 1 cycle output is completed during restart operation with automatic restart after instantaneous power failure (Pr. 57≠"---")
  - (3) when automatic restart operation was being performed with automatic restart after instantaneous power failure selected (Pr. 57≠"---") on completion of the data output mask

**◆Related parameters◆**

- Assignment of Y93 signal to terminal ⇒ Pr. 64 "RUN terminal function selection" (Refer to page 98.)
- Maintenance timer value ⇒ maintenance parameter H1 "maintenance timer (Refer to page 120.)
- Automatic restart after instantaneous power failure operation ⇒ Pr. 57 "restart coasting time" (Refer to page 90.)

H 5 ➡ Refer to P 5 (page 90).

H 7 ➡ Refer to P 9 (page 67).

## 2.13 Calibration parameters

### 2.13.1 Meter (frequency meter) calibration (C1 )

The AM terminal is factory-set to provide 5VDC output in the full-scale status of each monitor item. However, calibration parameter C1 can be used to adjust the output voltage ratio (gain) according to the meter scale. Note that the maximum output voltage is 5VDC.

Parameter	Name	Factory Setting	Setting Range	Remarks
C1 (901)	AM terminal calibration	_____	_____	Setting is enabled when Pr. 30 = "1"

The parameter number in parentheses is the one for use with the parameter unit (FR-PU04).

**Changing example** Deflecting the meter (analog indicator) to full-scale (5V) at the preset frequency of 50Hz (for frequency setting, refer to the instruction manual (basic).)

**POINT**

- The calibration parameters "C1" can be made to be ready by setting "1" (extended function parameter valid) in Pr. 30 "extended function display selection".
- Set the value of the calibration parameter C1 "AM terminal calibration".

**Operation**

**Display**

1. Press the **MODE** to choose the parameter setting mode.



(The parameter number read previously appears.)

2. Turn the **⊖** to show "┌ . . .".



● Pr. 30 must be set to "1".  
(For details, refer to the instruction manual (basic).)

3. Press the **SET** to show "┌ -".



4. Turn the **⊖** until the calibration parameter C1 "AM terminal calibration" appears.



5. Press the **SET** to enable setting.



6. If the inverter is at a stop, press the **RUN** to start it. (The motor need not be connected.)

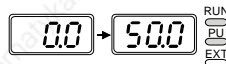

7. Turn the **⊖** to adjust the indicator needle to the desired position.



Analog indicator

8. Press the **SET**.  
Setting is complete.



Flicker ... Parameter setting complete!!

- By turning the **⊖**, you can read another parameter.
- Press the **SET** to return to the **┌ -** indication (step 3).
- Press the **SET** twice to show the next parameter (**┌ ┌ r**).

**REMARKS**

- Depending on the set value, it may take some time for the needle to move.
- If "1" is set in Pr. 30 "extended function display selection", the calibration parameter C1 "AM terminal calibration" can also be set in the external operation mode.
- When the FR-PU04 is used, make calibration with Pr. 901.

**POINT**

By setting the Pr. 54 "AM terminal function selection" value, preset Pr. 55 "frequency monitoring reference" or Pr. 56 "current monitoring reference" to the running frequency or current value at which the output signal is 5V.  
At 5V, the meter generally deflects to full-scale.

**◆Related parameters◆**

Choosing signal to be output to AM terminal ⇒ Pr. 54 "AM terminal function selection" (refer to page 88)

Reference values of frequency and current values ⇒ Pr. 55 "frequency monitoring reference", Pr. 56 "current monitoring reference" (refer to page 90)

**[ 2 ]** to **[ 7 ]** ➡ Refer to **P38**, **P39** (page 80).



## 2.14 Clear parameters

### 2.14.1 Parameter clear (CLr )

Initializes the parameter values to the factory settings.

Clear the parameters during a stop in the PU operation mode.

Parameter	Name	Factory Setting	Setting Range	Remarks
CLr	Parameter clear	0	0, 1, 10	0: Clear is not executed. 1: Parameter clear *1 (Calibration parameters C1 to C7 are not cleared) 10: All clear *2 (All settings including those of the calibration parameters C1 to C7 return to factory settings)

\*1.Parameters are not cleared by setting "1" in Pr. 77 "parameter write disable selection".

Pr. 75, Pr. 38, Pr. 39, Pr. 53, Pr. 60 to Pr. 65, Pr. 99, maintenance parameters H1, H2, calibration parameters C1 to C7 and communication parameters n13, n15 are not cleared.

\*2.Pr. 75, maintenance parameter H1 and communication parameter n13 are not cleared.

#### REMARKS

For details of the operation procedure, refer to the instruction manual (basic).

### 2.14.2 Alarm history clear (ECL )

Clear the alarm history.

Parameter	Name	Factory Setting	Setting Range	Remarks
ECL	Alarm history clear	0	0, 1	0: Not cleared 1: Alarm history clear

## 2.15 Communication parameters

You can perform communication operation from the RS-485 connector of the inverter through RS-485.

### (1) Operational functions

1) Operation mode switching  
[Operation mode switching method]

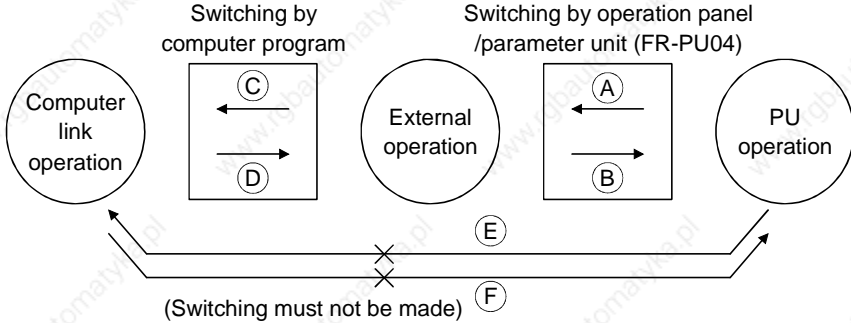

Symbol	Switching Type	Switching Method		
Ⓐ	PU operation to external operation	Using the $\begin{matrix} \text{PU} \\ \text{EXT} \end{matrix}$ of the operation panel or the $\begin{matrix} \text{PU} \\ \text{EXT} \end{matrix}$ of the parameter unit (FR-PU04)		
Ⓑ	External operation to PU operation	Using the $\begin{matrix} \text{PU} \\ \text{EXT} \end{matrix}$ of the operation panel or the $\begin{matrix} \text{PU} \\ \text{EXT} \end{matrix}$ of the parameter unit (FR-PU04)		
Ⓒ	External operation to computer link operation	Using the computer program	Read (H7B)/ Write (H7B)	H0000: Communication operation H0001: External operation
Ⓓ	Computer link operation to external operation			
Ⓔ	PU operation to computer link operation	Switching must not be made (External operation may be selected at Ⓐ and then switched to computer link operation at Ⓒ*)		
Ⓕ	Computer link operation to PU operation	Switching must not be made (External operation may be selected at Ⓓ and then switched to PU operation at Ⓑ*)		

\* When "1" is set in the communication parameter n10 "link startup mode selection", the inverter is placed in the computer link operation mode at power on or inverter reset. (Note that it is overridden by the Pr. 79 "operation mode selection" setting.)

### REMARKS

Unlike the other inverters, the FR-S500 series is not the type of inverter whose operation panel is removed to make communication.

Parameter setting using setup S/W is not enabled in the PU operation mode and external / PU combined operation mode (Pr. 79 = 1, 3, 4). Also, pressing the  $\text{RUN}$  on the operation panel starts the inverter in the external / PU combined operation mode. (Pr. 79=1, 3)

## 2) Operation mode-based functions

Operation Location	Item	Operation Mode		
		PU operation	External operation	Computer link operation
Operation panel or FR-PU04	Run command (start)	Enabled	Enabled (Combined operation mode)	Disabled
	Running frequency setting	Enabled	Enabled (Combined operation mode)	Disabled
	Monitoring	Enabled	Enabled	Enabled
	Parameter write	Enabled (*4)	Disabled	Disabled
	Parameter read	Enabled	Enabled	Enabled
	Inverter reset	Enabled	Enabled	Enabled
	Stop command	Enabled	Enabled (*3)	Enabled (*3)
On-computer user program by RS-485 communication	Run command	Disabled	Disabled	Enabled (*1)
	Running frequency setting (*)	Disabled	Disabled	Enabled (*1)
	Monitoring	Enabled	Enabled	Enabled
	Parameter write	Disabled	Disabled	Enabled (*4)
	Parameter read	Enabled	Enabled	Enabled
	Inverter reset	Disabled	Disabled	Enabled (*2)
Control circuit external terminal	Stop command	Disabled	Disabled	Enabled
	Inverter reset	Enabled	Enabled	Enabled
	Run command	Enabled (Combined operation mode)	Enabled	Enabled (*1)
	Frequency setting	Enabled (Combined operation mode)	Enabled	Enabled (*1)

\*1. As set in the communication parameters n8 "operation command source" and n9 "speed command source". (refer to page 145)

\*2. At occurrence of RS-485 communication error, the inverter cannot be reset from the computer.

\*3. As set in Pr. 75 "reset selection/PU stop selection".

\*4. As set in Pr. 77 "parameter write disable selection".

### CAUTION

**\* When the user program of the computer is used to make the running frequency setting by RS-485 communication, setting can be made in the minimum setting increments of 0.01Hz, but the setting may be written to the inverter in increments of 0.1Hz. (0 is written in the second decimal place.)**

### POINT

To perform parameter write, give an operation command, make inverter reset, etc. using RS-485 communication, the operation mode must be changed to the "computer link operation mode".

Set "0", "2", "7" or "8" in Pr. 79 "operation mode selection" to select the external operation mode, and change the operation mode to the "computer link operation mode" in either of the following methods.

- 1) Set "1" in the communication parameter n10 "link startup mode selection" to start the inverter in the "computer link operation mode" at power on. (Refer to page 146 for the communication parameter n10.)
- 2) Using operation mode write (instruction code HFB), write H0000 to choose the "computer link operation mode". (Refer to page 139 for operation mode write.)

## 2.15.1 Communication settings (n1 to n7 , n11 )

### ● Communication-related parameters

Parameter	Name	Factory Setting	Setting Range	Remarks	Reflection Timing
n1(331)	Communication station number	0	0 to 31	Setting is enabled when Pr. 30 = "1"	After reset
n2(332)	Communication speed	192	48,96,192		After reset
n3(333)	Stop bit length	1	0,1,10,11		After reset
n4(334)	Parity check presence/ absence	2	0,1,2		After reset
n5(335)	Number of communication retries	1	0 to 10, ---		Immediately
n6(336)	Communication check time interval (*)	---	0, 0.1 to 999s, ---		Immediately
n7(337)	Waiting time setting	---	0 to 150ms, ---		After reset
n11(341)	CR/LF selection	1	0,1,2	After reset	

- The parameter numbers within parentheses are those for use of the parameter unit (FR-PU04).
- Refer to page 176 for the instruction codes.

#### POINTS

\*When making RS-485 communication, set any value other than 0 in the communication parameter n6 "communication check time interval". RS-485 communication is disabled if the setting is "0s".

### ● Communication specifications

Item		Computer
Conforming standard		EIA-485 (RS-485)
Number of inverters connected		1:N (max. 32 inverters)
Communication speed		Selected between 19200, 9600 and 4800bps
Control protocol		Asynchronous
Communication method		Half-duplex
Communication specifications	Character system	ASCII (7 bits/8 bits) selectable
	Stop bit length	Selectable between 1 bit and 2 bits.
	Terminator	CR/LF (presence/absence selectable)
	Check system	Parity check
Sum check		Presence
Waiting time setting		Selectable between presence and absence

#### REMARKS

- For computer link operation, set 65535 (HFFFF) as the value "- - -"and 65520 (HFFF0) as the Pr. 19 value "888".
- Refer to page 39 for handling the RS-485 connector.
- For parameter instruction codes, refer to the appended parameter instruction code list (page 176).

<Setting>

To make communication between the personal computer and inverter, initialization of the communication specifications must be made to the inverter. If initial setting is not made or there is a setting fault, data transfer cannot be made.

\*After making the initial setting of the parameters, always reset the inverter. After you have changed the communication-related parameters, communication cannot be made until the inverter is reset.

Parameter	Description	Setting	Description	
n1	Communication station number	0 to 31	Station number specified for communication from the RS-485 connector. Set the inverter station numbers when two or more inverters are connected to one personal computer.	
n2	Communication speed	48	4800bps	
		96	9600bps	
		192	19200bps	
n3	Stop bit length/ data length	8 bits	0	Stop bit length 1 bit
			1	Stop bit length 2 bits
		7 bits	10	Stop bit length 1 bit
			11	Stop bit length 2 bits
n4	Parity check presence/ absence	0	Absent	
		1	Odd parity present	
		2	Even parity present	
n5	Number of communication retries	0 to 10	Set the permissible number of retries at occurrence of a data receive error. If the number of consecutive errors exceeds the permissible value, the inverter will come to an alarm stop (OPT).	
		--- (65535)	If a communication error occurs, the inverter will not come to an alarm stop. At this time, the inverter can be coasted to a stop by MRS or RES input. During a communication error (H0 to H5), the minor fault signal (LF) is switched on. Allocate the used terminal with any of Pr. 64, Pr. 65 (output terminal function selection).	
n6	Communication check time interval	0	No communication	
		0.1 to 999	Set the communication check time [s] interval. If a no-communication state persists for longer than the permissible time, the inverter will come to an alarm stop (OPT).	
		---	Communication check suspension.	
n7	Waiting time setting	0 to 150	Set the waiting time between data transmission to the inverter and response.	
		---	Set with communication data.	
n11	CR/LF selection	0	Without CR/LF	
		1	With CR, without LF	
		2	With CR/LF	

## <Computer programming>

### (1) Communication protocol

Data communication between the computer and inverter is performed using the following procedure:

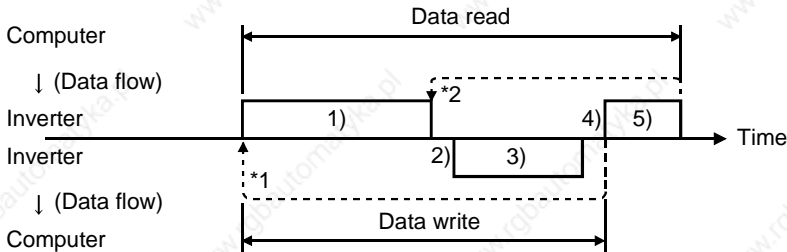

#### REMARKS

- \*1. If a data error is detected and a retry must be made, execute retry operation with the user program. The inverter comes to an alarm stop if the number of consecutive retries exceeds the parameter setting.
- \*2. On receipt of a data error occurrence, the inverter returns "reply data 3)" to the computer again. The inverter comes to an alarm stop if the number of consecutive data errors reaches or exceeds the parameter setting.

### (2) Communication operation presence/absence and data format types

Communication operation presence/absence and data format types are as follows:

No.	Operation	Run Command	Running Frequency	Parameter Write	Inverter Reset	Monitoring	Parameter Read	
1)	Communication request is sent to the inverter in accordance with the user program in the computer.	A'	A (A")*1	A (A")*2	A	B	B	
2)	Inverter data processing time	Present	Present	Present	Absent	Present	Present	
3)	Reply data from the inverter. (Data 1) is checked for error)	No error* (Request accepted)	C	C	C	Absent	E, E' (E")*1	E (E")*2
		With error (request rejected)	D	D	D	Absent	F	F
4)	Computer processing delay time	Absent	Absent	Absent	Absent	Absent	Absent	
5)	Answer from computer in response to reply data 3). (Data 3) is checked for error)	No error* (No inverter processing)	Absent	Absent	Absent	Absent	G (Absent)	G (Absent)
		With error. (Inverter outputs 3) again.)	Absent	Absent	Absent	Absent	H	H

\* In the communication request data from the computer to the inverter, 10ms or more is also required after "no data error (ACK)". (Refer to page 135.)

**REMARKS**

- \*1. Setting any of "0.1" to "999" in Pr. 37 "speed display" and "1" in instruction code "HFF" sets the data format to A" or E" (6-digit data). Also, the output frequency turns to a speed display, which is valid in 0.01r/min increments. (The third decimal place is invalid.) If the instruction code "HFF" is other than "1", the display is in 1r/min increments and a 4-digit data format can be used. Reply data is given in format E if the requested monitor data has 4 digits, in format E' if the data has 2 digits, or in format E" if the data has 6 digits.
- \*2. The data format to read/write Pr. 37 "speed display" is always E"/A" (6-digit data).

**(3) Data format**

Data used is hexadecimal.

Data is automatically transferred in ASCII between the computer and inverter.

● Data format types

1) Communication request data from computer to inverter

[Data write]

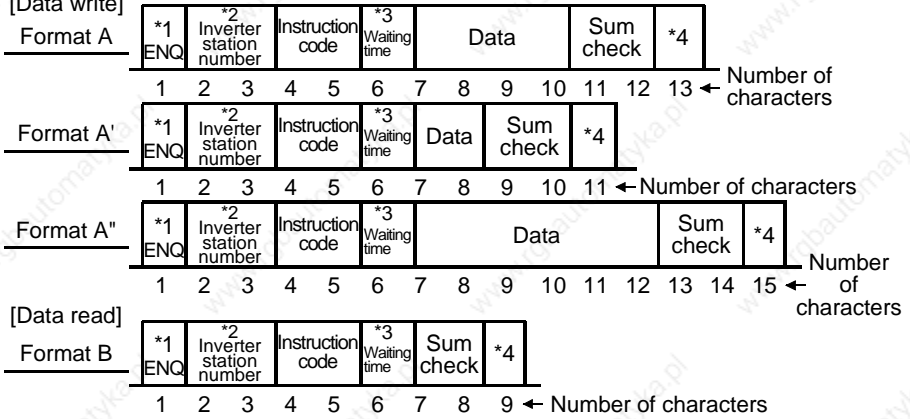

2) Reply data from inverter to computer during data write

[No data error detected]

[Data error detected]

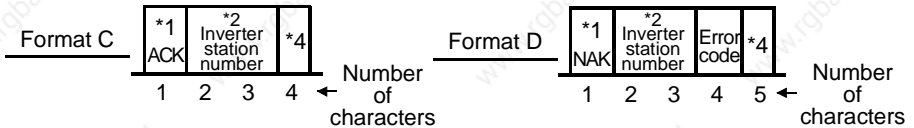

3) Reply data from inverter to computer during data read

[No data error detected]

[Data error detected]

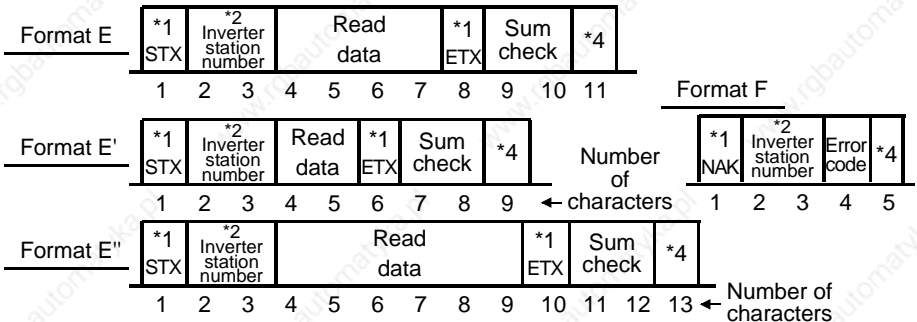

#### 4) Send data from computer to inverter during data read

[No data error detected]  
(May be omitted)

[Data error detected]

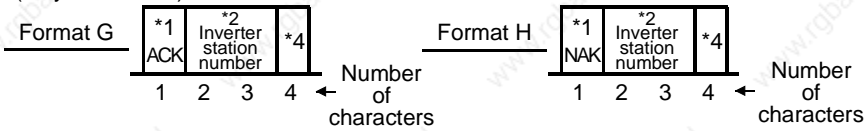

#### REMARKS

- \*1. Indicates the control code. (Refer to the table below.)
- \*2. Specify the inverter station numbers between H00 and H1F (stations 0 to 31) in hexadecimal.
- \*3. When communication parameter n7 "waiting time setting" ≠ ---, create the communication request data without "waiting time" in the data format. (The number of characters is decremented by 1.)
- \*4. CR or LF code  
When data is transmitted from the computer to the inverter, codes CR (carriage return) and LF (line feed) codes are automatically set at the end of a data group on some computers. In this case, setting must also be made on the inverter according to the computer.  
Also, the presence or absence of the CR and LF codes can be selected using n11.

### (4) Data definitions

#### 1) Control codes

Signal	ASCII Code	Description
STX	H02	Start of Text (Start of data)
ETX	H03	End of Text (End of data)
ENQ	H05	Enquiry (Communication request)
ACK	H06	Acknowledge (No data error detected)
LF	H0A	Line Feed
CR	H0D	Carriage Return
NAK	H15	Negative Acknowledge (Data error detected)

#### 2) Inverter station number

Specify the station number of the inverter which communicates with the computer.

#### 3) Instruction code

Specify the processing request, e.g. operation or monitoring, given by the computer to the inverter. Hence, the inverter can be run and monitored in various ways by specifying the instruction code as appropriate. (Refer to page 176.)

#### 4) Data

Indicates the data such as frequency and parameters transferred to and from the inverter. The definitions and ranges of set data are determined in accordance with the instruction codes. (Refer to page 176.)



### 5) Waiting time

Specify the waiting time between the receipt of data at the inverter from the computer and the transmission of reply data. Set the waiting time in accordance with the response time of the computer between 0 and 150ms in 10ms increments (e.g. 1 = 10ms, 2 = 20ms).

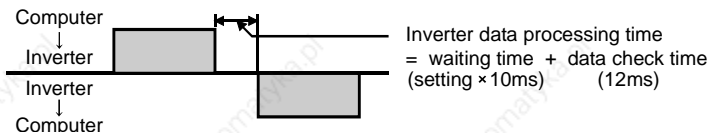

#### REMARKS

When communication parameter n7 "waiting time setting" ≠ "- - -", create the communication request data without "waiting time" in the data format. (The number of characters is decremented by 1.)

### 6) Response time

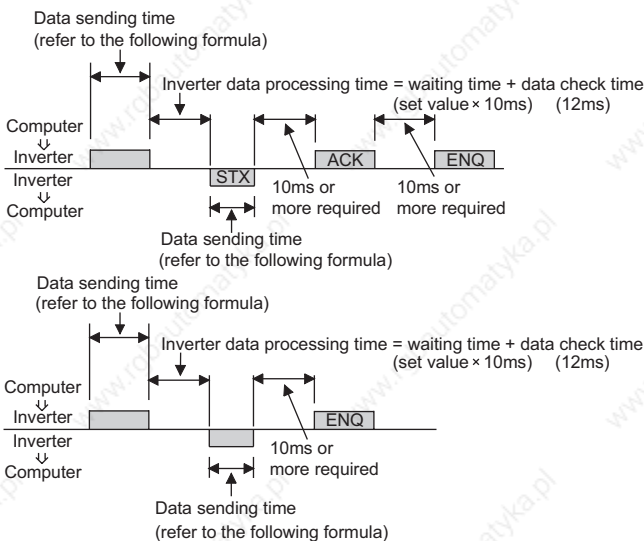

[Formula for data sending time]

$$\frac{1}{\text{Communication speed (bps)}} \times \text{Number of data characters (Refer to page 133)} \times \text{Communication specification (Total number of bits) (See below)} = \text{Data sending time (s)}$$

● Communication specification

Name	Number of Bits
Stop bit length	1 bit
	2 bits
Data length	7 bits
	8 bits
Parity check	Yes 1 bit
	No 0 bit

In addition to the bits in the above table, 1 bit is required for the start bit.

Minimum total number of bits ... 9 bits

Maximum total number of bits ... 12 bits

**7) Open cable detection (Communication parameter n6 "communication check time interval")**

- If disconnection (communication stop) is detected between the inverter and computer as a result of disconnection check, a communication error (OPT) occurs and the inverter output is shut off.
- Disconnection check is made when the setting is any of "0.1s" to "999s". To make disconnection check, it is necessary to send data (control code refer to page 134) from the computer within the communication check time interval. (The send data has nothing to do with the station number)
- Communication check is performed in computer link operation mode from at the first communication.
- When the setting is "---", communication check (disconnection detection) is not made.
- When the setting is "0", RS-485 communication is disabled.

Example: When communication parameter n6= "0.1 to 999"

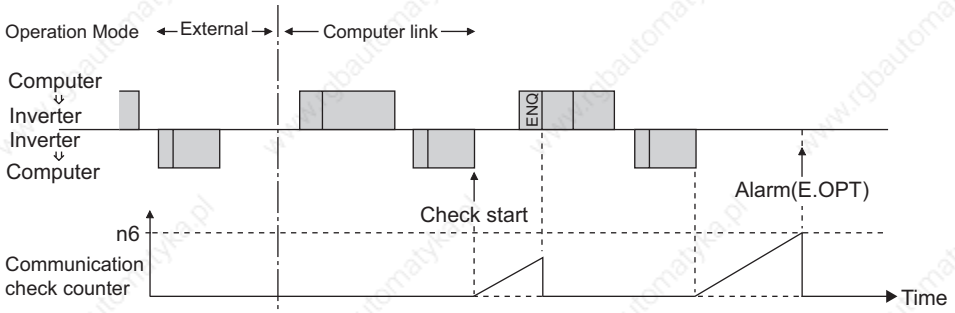

### 8) Sum check code

The sum check code is 2-digit ASCII (hexadecimal) representing the lower 1 byte (8 bits) of the sum (binary) derived from the checked ASCII data

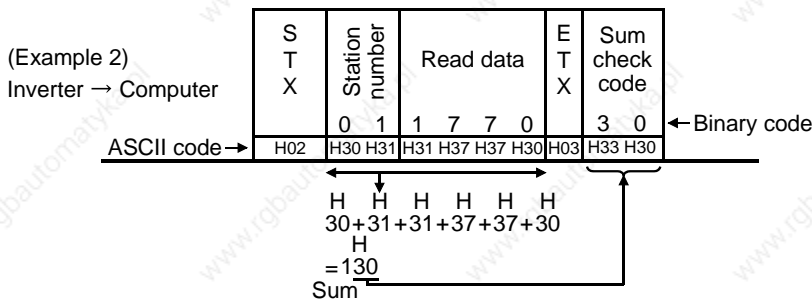
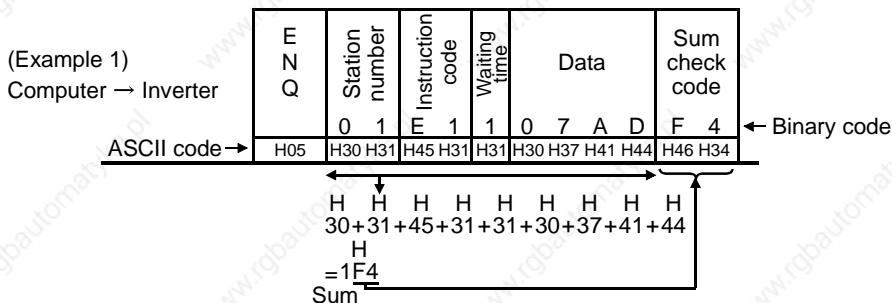



### 9) Error code

If any error is found in the data received by the inverter, its definition is sent back to the computer together with the NAK code. (Refer to page 143.)

#### REMARKS

1. When the data from the computer has an error, the inverter will not accept that data.
2. All data communication, e.g. run command or monitoring, are started when the computer gives a communication request. The inverter does not return any data without the computer's request. For monitoring, therefore, design the program to cause the computer to provide a data read request as required.
3. When the parameter setting is read or written, the data of the link parameter expansion setting changes depending on the parameter. For the data, refer to the parameter instruction code list on page 176.

## CAUTION

-  Always set the communication check time interval before starting operation to prevent hazardous conditions.
-  Data communication is not started automatically but is made only once when the computer provides a communication request. If communication is disabled during operation due to signal cable breakage etc., the inverter cannot be stopped. When the communication check time interval has elapsed, the inverter will come to an alarm stop (OPT).  
The inverter can be coasted to a stop by switching on its RES signal or by switching power off.
-  If communication is broken due to signal cable breakage, computer fault etc., the inverter does not detect such a fault. This should be fully noted.

### <Setting items and set data>

After completion of parameter settings, set the instruction codes and data then start communication from the computer to allow various types of operation control and monitoring.

No.	Item	Instruction Code	Description	Number of Data Digits																																																								
1	Operation mode	Read	H7B H0000: Communication operation H0001: External operation H0002: PU operation	4 digits																																																								
		Write	HFB H0000: Communication operation H0001: External operation																																																									
2	Output frequency [speed]	H6F	H0000 to HFFFF: Output frequency in 0.01Hz increments Pr. 37 = 0 (factory setting)	4 digits																																																								
			H0000 to HFFFF: Speed in 1r/min increments When Pr. 37 = "0.1 to 999", expansion link parameter (HFF) = 0																																																									
			H000000 to HFFFFFF: Speed in 0.01r/min increments When Pr. 37 = "0.1 to 999", expansion link parameter (HFF) = 1	6 digits																																																								
	Output current	H70	H0000 to HFFFF: Output current (hexadecimal) in 0.01A increments	4 digits																																																								
Monitoring	Alarm definition	H74 to H75	H0000 to HFFFF: Two most recent alarm definitions Alarm definition display example (instruction code H74)	4 digits																																																								
			<div style="text-align: center;"> <p>b15                      b8b7                      b0</p> <table border="1" style="margin: auto;"> <tr> <td>0</td><td>0</td><td>1</td><td>1</td><td>0</td><td>0</td><td>0</td><td>0</td><td>1</td><td>0</td><td>1</td><td>0</td><td>0</td><td>0</td><td>0</td><td>0</td> </tr> </table> <p>Previous alarm (H30)                      Most recent alarm (HA0)</p> </div> <p>Alarm data</p> <table border="1" style="width: 100%; border-collapse: collapse;"> <thead> <tr> <th>Data</th> <th>Description</th> <th>Data</th> <th>Description</th> </tr> </thead> <tbody> <tr><td>H00</td><td>No alarm</td><td>H60</td><td>OLT</td></tr> <tr><td>H10</td><td>OC1</td><td>H80</td><td>GF</td></tr> <tr><td>H11</td><td>OC2</td><td>H90</td><td>OHT</td></tr> <tr><td>H12</td><td>OC3</td><td>HA0</td><td>OPT</td></tr> <tr><td>H20</td><td>OV1</td><td>HB0</td><td>PE</td></tr> <tr><td>H21</td><td>OV2</td><td>HB1</td><td>PUE</td></tr> <tr><td>H22</td><td>OV3</td><td>HB2</td><td>RET</td></tr> <tr><td>H30</td><td>THT</td><td>HC0</td><td>CPU*</td></tr> <tr><td>H31</td><td>THM</td><td></td><td></td></tr> <tr><td>H40</td><td>FIN</td><td></td><td></td></tr> </tbody> </table> <p>* Error code may not be returned.</p>		0	0	1	1	0	0	0	0	1	0	1	0	0	0	0	0	Data	Description	Data	Description	H00	No alarm	H60	OLT	H10	OC1	H80	GF	H11	OC2	H90	OHT	H12	OC3	HA0	OPT	H20	OV1	HB0	PE	H21	OV2	HB1	PUE	H22	OV3	HB2	RET	H30	THT	HC0	CPU*	H31	THM		
0	0	1	1	0	0	0	0	1	0	1	0	0	0	0	0																																													
Data	Description	Data	Description																																																									
H00	No alarm	H60	OLT																																																									
H10	OC1	H80	GF																																																									
H11	OC2	H90	OHT																																																									
H12	OC3	HA0	OPT																																																									
H20	OV1	HB0	PE																																																									
H21	OV2	HB1	PUE																																																									
H22	OV3	HB2	RET																																																									
H30	THT	HC0	CPU*																																																									
H31	THM																																																											
H40	FIN																																																											

**Communication parameters**

No.	Item	Instruction Code	Description	Number of Data Digits								
3	Run command	HFA	<p style="text-align: center;">b7 <span style="margin-left: 150px;">b0</span></p> <table border="1" style="margin-left: auto; margin-right: auto;"> <tr> <td style="padding: 2px 5px;">0</td> <td style="padding: 2px 5px;">0</td> <td style="padding: 2px 5px;">0</td> <td style="padding: 2px 5px;">0</td> <td style="padding: 2px 5px;">0</td> <td style="padding: 2px 5px;">0</td> <td style="padding: 2px 5px;">1</td> <td style="padding: 2px 5px;">0</td> </tr> </table> <p style="text-align: center;">[For example 1]</p> <p>[Example 1] H02 ... Forward rotation</p> <p>[Example 2] H00 ... Stop</p> <p>b0 : _____            b1 : Forward rotation (STF)            b2 : Reverse rotation (STR) *            b3 : Low speed (RL) *            b4 : Middle speed (RM) *            b5 : High speed (RH) *            b6 : _____            b7 : _____</p> <p>* Function change can be made using Pr. 60 to Pr. 63 (input terminal function selection).</p>	0	0	0	0	0	0	1	0	2 digits
0	0	0	0	0	0	1	0					
4	Inverter status monitor	H7A	<p style="text-align: center;">b7 <span style="margin-left: 150px;">b0</span></p> <table border="1" style="margin-left: auto; margin-right: auto;"> <tr> <td style="padding: 2px 5px;">0</td> <td style="padding: 2px 5px;">0</td> <td style="padding: 2px 5px;">0</td> <td style="padding: 2px 5px;">0</td> <td style="padding: 2px 5px;">0</td> <td style="padding: 2px 5px;">0</td> <td style="padding: 2px 5px;">1</td> <td style="padding: 2px 5px;">0</td> </tr> </table> <p style="text-align: center;">[For example 1]</p> <p>[Example 1] H02 ... During forward rotation</p> <p>[Example 2] H80 ... Stop due to alarm</p> <p>b0: Inverter running (RUN)*            b1: Forward rotation            b2: Reverse rotation            b3: Up to frequency (SU)            b4: Overload (OL)            b5: _____            b6: Frequency detection (FU)            b7: Alarm occurrence*</p> <p>* Function change can be made using Pr. 64 and Pr. 65 (output terminal function selection).</p>	0	0	0	0	0	0	1	0	2 digits
0	0	0	0	0	0	1	0					

No.	Item	Instruction Code	Description	Number of Data Digits
5	Set frequency read (RAM)	H6D	<ul style="list-style-type: none"> <li>When Pr. 37 = "0" (factory setting) The set frequency (RAM or E<sup>2</sup>PROM) is read. H0000 to H2EE0: 0.01Hz increments</li> <li>When Pr. 37 = "0.1 to 999", expansion link parameter (HFF) = 0 The set speed is read. H0000 to H03E7: 1r/min increments</li> </ul>	4 digits (6 digits)
	Set frequency read (E <sup>2</sup> PROM)	H6E	<ul style="list-style-type: none"> <li>When Pr. 37 = "0.1 to 999", expansion link parameter (HFF) = 1 The set speed is read. (The number of data digits is 6 digits.) H0000 to HF3E58: 0.001r/min increments</li> </ul>	
	Set frequency write (RAM only)	HED	<ul style="list-style-type: none"> <li>When Pr. 37 = "0" (factory setting) H0000 to H2EE0 (0 to 120.00Hz): Set frequency in 0.01Hz increments When changing the set frequency continuously, write it to the inverter RAM (instruction code: HED). The minimum setting increments are 0.01Hz but setting can be made in only 0.1Hz increments.</li> <li>When Pr. 37 = "0.1 to 999", expansion link parameter HFF = 0 H0000 to H03E7 (0 to 999): Set speed in 1r/min increments</li> </ul>	4 digits (6 digits)
Set frequency write (RAM and E <sup>2</sup> PROM)	HEE	<ul style="list-style-type: none"> <li>When Pr. 37 = "0.1 to 999", expansion link parameter HFF = 1 H0000 to HF3E58 (0 to 999.000): Set speed in 0.001r/min increments Set the number of data digits as 6 digits. The minimum setting increments are 0.001r/min but setting can be made in only 0.01r/min increments.</li> </ul>		
6	Inverter reset	HFD	<p>H9696: Resets the inverter.</p> <p>As the inverter is reset on start of communication by the computer, the inverter cannot send reply data back to the computer.</p>	4 digits
7	Alarm definition batch clear	HF4	H9696: Alarm history batch clear	4 digits

No.	Item	Instruction Code	Description	Number of Data Digits																									
8	All parameter clear	HFC	<p>All parameters return to the factory settings. Any of four different all clear operations are performed according to the data.</p> <table border="1"> <thead> <tr> <th>Data \ Pr.</th> <th>Communication Pr.</th> <th>Calibration Pr</th> <th>Other Pr.*</th> <th>HEC HFF</th> </tr> </thead> <tbody> <tr> <td>H9696</td> <td>○</td> <td>×</td> <td>○</td> <td>○</td> </tr> <tr> <td>H9966</td> <td>○</td> <td>○</td> <td>○</td> <td>○</td> </tr> <tr> <td>H5A5A</td> <td>×</td> <td>×</td> <td>○</td> <td>○</td> </tr> <tr> <td>H55AA</td> <td>×</td> <td>○</td> <td>○</td> <td>○</td> </tr> </tbody> </table> <p>When all parameter clear is executed for H9696 or H9966, communication-related parameter settings also return to the factory settings. When resuming operation, set the parameters again. * Pr. 75 is not cleared.</p>	Data \ Pr.	Communication Pr.	Calibration Pr	Other Pr.*	HEC HFF	H9696	○	×	○	○	H9966	○	○	○	○	H5A5A	×	×	○	○	H55AA	×	○	○	○	4 digits
Data \ Pr.	Communication Pr.	Calibration Pr	Other Pr.*	HEC HFF																									
H9696	○	×	○	○																									
H9966	○	○	○	○																									
H5A5A	×	×	○	○																									
H55AA	×	○	○	○																									
9	Parameter read	H00 to H63	Refer to the "Instruction Code List" (page 176) and write and/or read the values as required.	4 digits																									
10	Parameter write	H80 to HE3																											
11	Link parameter expansion setting	Read	H7F	Set any of H00 to H09 to change the parameter settings. For details of the settings, refer to the parameter instruction code list (page 176).	2 digits																								
		Write	HFF																										
12	Second parameter changing (Code HFF = 1)	Read	H6C	<p>When setting the bias/gain (Instruction code H5E to H61, HDE to HE1) parameters H00: Frequency (*1) H01: Analog H02: Analog value of terminal (*2)</p> <p>*1. The gain frequencies may also be written using Pr. 38 and Pr. 39 (Instruction codes A6 and A7). *2. When a voltage is given to the external terminal to make bias or gain calibration, the data value written is 4 digits.</p>	2 digits																								
		Write	HEC																										

**REMARKS**

For the instruction codes HFF, HEC, their set values are held once they are written, but changed to 0 when the inverter is reset or all clear is performed.



### <Error Code List>

The following error code in the following list is displayed if an error is detected in any communication request data from the computer:

Error Code	Item	Definition	Inverter Operation
H0	Computer NAK error	The number of errors consecutively detected in communication request data from the computer is greater than allowed number of retries.	Brought to an alarm stop (OPT) if error occurs continuously more than the allowable number of retries.
H1	Parity error	The parity check result does not match the specified parity.	
H2	Sum check error	The sum check code in the computer does not match that of the data received by the inverter.	
H3	Protocol error	Data received by the inverter is in wrong protocol, data receive is not completed within given time, or CR and LF are not as set in the parameter.	
H4	Framing error	The stop bit length is not as specified by initialization.	
H5	Overrun error	New data has been sent by the computer before the inverter completes receiving the preceding data.	
H6	_____	_____	_____
H7	Character error	The character received is invalid (other than 0 to 9, A to F, control code).	Does not accept received data but is not brought to alarm stop
H8	_____	_____	_____
H9	_____	_____	_____
HA	Mode error	Parameter write was attempted in other than the computer link operation mode or during inverter operation.	Does not accept received data but is not brought to alarm stop.
HB	Instruction code error	The specified command does not exist.	
HC	Data range error	Invalid data has been specified for parameter write, frequency setting, etc.	
HD	_____	_____	
HE	_____	_____	_____
HF	_____	_____	_____

### (5) Operation at alarm occurrence

Fault Location	Status		Operation Mode	
			Communication Operation (RS-485 connector)	External Operation
Inverter fault	Inverter operation		Stop	Stop
	Communication	RS-485 connector	Continued	Continued
Communication error (Communication from RS-485 connector)	Inverter operation		Stop/continued (*3)	Continued
	Communication	RS-485 connector	Stop	Stop

\*3: Can be selected using the corresponding parameter (factory-set to stop).

### (6) Communication error

Fault Location	Error Message (Operation panel)	Remarks
Communication error (Communication from RS-485 connector)	OPT	Error code is OPT

## (7) Program example

To change the operation mode to computer link operation

### Program

Line number

```
10 OPEN"COM1:9600,E,8,2,HD"AS #1
20 COMST1,1,1:COMST1,2,1
30 ON COM(1)GOSUB*REC
40 COM(1)ON
```

```
50 D$="01FB10000"
```

```
60 S=0
```

```
70 FOR I=1 TO LEN(D$)
```

```
80 A$=MID$(D$,I,1)
```

```
90 A=ASC(A$)
```

```
100 S=S+A
```

```
110 NEXT I
```

```
120 D$=CHR$(&H5)+D$+RIGHT$(HEX$(S),2)
```

```
130 PRINT#1,D$
```

```
140 GOTO 50
```

```
1000 *REC
```

```
1010 IF LOC(1)=0 THEN RETURN
```

```
1020 PRINT"RECEIVE DATA"
```

```
1030 PRINT INPUT$(LOC(1),#1)
```

```
1040 RETURN
```

### General flowchart

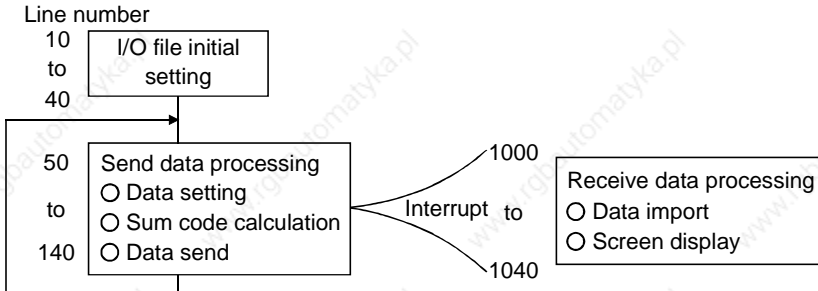

Initial setting of I/O file

- ☆ Opening the communication file
- ☆ ON/OFF setting of circuit control signals (RS, ER)
- ☆ Interrupt definition for data receive
- ☆ Interrupt enable

Send data setting

Sum code calculation

- ☆ Addition of control and sum codes

Data send

Interrupt data receive

- ☆ Interrupt occurrence during data receive

## 2.15.2 Operation and speed command source (n8 , n9 )

Used to make valid the operation and speed commands from the computer or external terminals.

Parameter	Name	Factory Setting	Setting Range	Remarks
n8 (338)	Operation command source	0	0, 1	Setting is enabled when Pr. 30 = "1"
n9 (339)	Speed command source	0	0, 1	

The parameter numbers within parentheses are those for use of the parameter unit (FR-PU04).

### <Setting>

In the computer operation mode, commands from the external terminals and computer are as listed below.

(Refer to page 96 for Pr. 60 to Pr. 63 (input terminal function selection).)

Operation location selection	n8 (Pr. 338) "operation command source"		0:	0:	1:	1:	Remarks	
	n9 (Pr. 339) "speed command source"		0:	1:	0:	1:		
			Computer	Computer	External	External		
Fixed function (Terminal-equivalent function)	Forward rotation command (STF)		Computer	Computer	External	External		
	Computer link operation frequency		Computer	—	Computer	—		
	2		—	External	—	External		
	4		—	External	—	External		
Selection function	Pr. 60 to Pr. 63 settings	0	Low-speed operation command (RL)	Computer	External	Computer	External	Pr. 59 = "0"
		1	Middle-speed operation command (RM)	Computer	External	Computer	External	Pr. 59 = "0"
		2	High-speed operation command (RH)	Computer	External	Computer	External	Pr. 59 = "0"
		3	Second function selection (RT)	Computer	Computer	External	External	
		4	Current input selection (AU)	—	Combined	—	Combined	
		5	Start self-holding selection (STOP)	—	—	External	External	
		6	Output stop (MRS)	Combined	Combined	External	External	Pr. 79 ≠ "7"
		7	External thermal relay input (OH)	External	External	External	External	
		8	15-speed selection (REX)	Computer	External	Computer	External	Pr. 59 = "0"
		9	Jog operation selection (JOG)	—	—	External	External	
		10	Reset (RES)	External	External	External	External	
		14	PID control valid terminal (X14)	Computer	External	Computer	External	
		16	PU-external operation switch-over (X16)	External	External	External	External	
---	Reverse rotation command (STR)	Computer	Computer	External	External			

Operation location selection	n8 (Pr. 338) "operation command source"	0: Computer	0: Computer	1: External	1: External	Remarks
	n9 (Pr. 339) "speed command source"	0: Computer	1: External	0: Computer	1: External	
RH, RM, RL, REX selection function	Remote setting (RH, RM, RL)	Computer	External	Computer	External	Pr. 59 = "1", "2"
	15-speed selection (REX)	—	—	—	—	
MRS selection function	PU operation interlock (MRS)	External	External	External	External	Pr. 79 = "7"

### [Explanation of table]

External : Operation is valid only from external terminal signal.

Computer : Operation is valid only from computer.

Combined : Operation is valid from either of external terminal and computer.

— : Operation is invalid from either of external terminal and computer.

### CAUTION

When Pr. 79 "operation mode selection" is set to "7" (PU operation interlock function), only the external terminal is made valid independently of the n8 and n9 settings because the MRS terminal is shared.

## 2.15.3 Link startup mode selection (n10 )

The operation mode at power on and at power restoration after instantaneous power failure can be selected.

Set "1" in n10 to select the computer link operation mode.

After a link start, parameter write is enabled with a program.



Parameter	Name	Factory Setting	Setting Range	Remarks
n10 (340)	Link startup mode selection	0	0, 1	Setting is enabled when Pr. 30 = "1"

The parameter number in parentheses is the one for use with the parameter unit (FR-PU04).

## &lt;Setting&gt;

n10 Setting	Pr. 79 Setting	Operation Mode at Power on or Power Restoration	Remarks
0 (Factory setting)	0	External operation mode	Can be changed to the computer link operation mode by RS-485 communication.
	1	PU operation mode	Operation mode cannot be changed.
	2	External operation mode	Can be changed to the computer link operation mode by RS-485 communication.
	3	External/PU combined mode	Operation mode cannot be changed.
	4	External/PU combined mode	
	7	External operation mode (PU operation interlock)	MRS signal ON....Can be changed to PU operation by RS-485 communication. MRS signal OFF...Operation mode cannot be changed.
	8	<ul style="list-style-type: none"> <li>•X16 signal ON Started in the external operation mode.</li> <li>•X16 signal OFF Started in the PU operation mode.</li> </ul>	Can be changed to the computer link operation mode by RS-485 communication.
1	0	Computer link operation mode	Can be changed to the external operation mode by RS-485 communication.
	1	PU operation mode	Operation mode cannot be changed.
	2	Computer link operation mode	Can be changed to the external operation mode by RS-485 communication.
	3	External/PU combined mode	Operation mode cannot be changed.
	4	External/PU combined mode	
	7	PU operation interlock <ul style="list-style-type: none"> <li>•MRS signal ON Started in the computer link operation mode.</li> <li>•MRS signal OFF Started in the external operation mode.</li> </ul>	Can be changed to external operation by RS-485 communication.
	8	<ul style="list-style-type: none"> <li>•X16 signal ON Started in the computer link operation mode.</li> </ul>	Can be changed to external operation by RS-485 communication.
		<ul style="list-style-type: none"> <li>•X16 signal OFF Started in the PU operation mode.</li> </ul>	Operation mode cannot be changed.

- n10 can be changed independently of the operation mode of the operation panel.
- Setting of n10 = "1" is made valid when "0" or "2" is set in Pr. 79 "operation mode selection".

 Refer to  to  (page 130)

## 2.15.4 E<sup>2</sup>PROM write selection (n12 )

You can choose whether the parameters are stored into the E<sup>2</sup>PROM or not at the parameter setting for computer communication. When performing parameter write frequently, write them to the RAM.

Parameter	Name	Factory Setting	Setting Range	Remarks
n12 (342)	E <sup>2</sup> PROM write selection	0	0, 1	0: Written to RAM and E <sup>2</sup> PROM 1: Written to RAM only Not written to E <sup>2</sup> PROM* Setting is enabled when Pr. 30 = "1"

The parameter number in parentheses is the one for use with the parameter unit (FR-PU04).

### REMARKS

\*When the parameter setting is "not written to E<sup>2</sup>PROM" (setting=1), the settings return to the original values (values saved in the E<sup>2</sup>PROM) at power-on reset or terminal reset.

## 2.16 Parameter unit (FR-PU04) setting

When the optional parameter unit (FR-PU04) is connected to the RS-485 connector of the inverter, you can make the environment setting of the parameter unit.

### CAUTION

When the parameter unit (FR-PU04) is used, operation from the operation panel is not accepted. (The stop key (  ) is valid)

### 2.16.1 PU display language selection (n13 )

By setting the communication parameter n13 "PU display language selection", you can switch the display language of the parameter unit to another.

Parameter	Name	Factory Setting	Setting Range	Remarks
n13 (145)	PU display language selection		0 to 7	Setting is enabled when Pr. 30 = "1"

The parameter number in parentheses is the one for use with the parameter unit (FR-PU04).

#### <Setting>

n13 Setting	Display Language
0	Japanese
1	English (factory setting)
2	German
3	French
4	Spanish
5	Italian
6	Swedish
7	Finish



### 2.16.2 PU buzzer control (n14 )

By setting the communication parameter n14 "PU buzzer control", you can control "beep" produced when any of the parameter unit (FR-PU04) keys is operated.

Parameter	Name	Factory Setting	Setting Range	Remarks
n14 (990)	PU buzzer control	1	0, 1	0: Without sound 1: With sound (factory setting) Setting is enabled when Pr. 30 = "1"

The parameter number in parentheses is the one for use with the parameter unit (FR-PU04).

### 2.16.3 PU contrast adjustment (n15 )

By setting the communication parameter n15 "PU contrast adjustment", you can adjust the LCD contrast of the parameter unit (FR-PU04). When using the FR-PU04, adjust the numerical value to any darkness with the   and define that brightness with the  of the parameter unit.

Parameter	Name	Factory Setting	Setting Range	Remarks
n15 (991)	PU contrast adjustment	58	0 to 63	Setting is enabled when Pr. 30 = "1"

The parameter number in parentheses is the one for use with the parameter unit (FR-PU04).

#### CAUTION

When using the FR-PU04, you should press the  to store the PU contrast setting value.

### 2.16.4 PU main display screen data selection (n16 )

You can choose the main display screen of the parameter unit (FR-PU04).

Parameter	Name	Factory Setting	Setting Range	Remarks
n16 (992)	PU main display screen data selection	0	0, 100	Setting is enabled when Pr. 30 = "1"

The parameter number in parentheses is the one for use with the parameter unit (FR-PU04).

#### <Setting>

When "100" is set in n16, the monitor value is different depending on whether the inverter is at a stop or running.

	n16		
	0	100	
	During operation/stop	During stop	During operation
Output frequency	Output frequency	Set frequency	Output frequency
Output current	Output current		
Alarm display	Alarm display		

#### REMARKS

- During an error, the output frequency at error occurrence appears.
- During MRS, the values displayed are the same as during a stop.

#### ◆ Related parameters ◆

- Speed display ⇒ Pr. 37 "speed display" (refer to page 79)



## 2.16.5 Disconnected PU detection/PU setting lock selection (n17 )

You can choose the connector disconnection detection function of the parameter unit (FR-PU04) and the control source of the PU (operation panel, FR-PU04).

- **Disconnected PU detection** : This function detects that the parameter unit (FR-PU04) has been disconnected from the inverter for longer than 1s and causes the inverter to provide an alarm output (PUE) and come to an alarm stop. When the PU has been disconnected since before power-on, it is not judged as an alarm.
- **PU setting lock** : Control source of operation command, frequency command and parameter setting is restricted to the operation panel or parameter unit (FR-PU04).

Parameter	Name	Factory Setting	Setting Range	Remarks
n17 (993)	Disconnected PU detection/ PU setting lock	0	0, 1, 10	Setting is enabled when Pr. 30 = "1"

The parameter number in parentheses is the one for use with the parameter unit (FR-PU04).

### <Setting>

n17 Setting	Disconnected PU Detection	PU Setting Lock*
0	Operation is continued as-is if the PU is disconnected (without disconnected PU detection)	Parameter unit (FR-PU04) is valid
1	Inverter output is shut off when the PU is disconnected (with disconnected PU detection)	
10	Operation is continued as-is if the PU is disconnected (without disconnected PU detection)	Operation panel is valid

\* The monitor display and the  are valid.

### REMARKS

When RS-485 communication operation is performed through the RS-485 connector, the reset selection/PU stop selection function is valid but the disconnected PU detection function is invalid.

## CAUTION

 **Do not reset the inverter while the start signal is being input. Doing so will cause the inverter to start immediately after a reset, leading to hazardous conditions.**

# MEMO

# 3. PROTECTIVE FUNCTIONS

This chapter explains the "protective functions" of this product.

Always read the instructions before using the equipment.

<b>3.1 Errors (Alarms)</b> .....	<b>154</b>
<b>3.2 Troubleshooting</b> .....	<b>164</b>

Chapter 1

Chapter 2

**Chapter 3**

Chapter 4

### 3.1 Errors (Alarms)

---

If any fault has occurred in the inverter, the corresponding protective function is activated to bring the inverter to an alarm stop and automatically give the corresponding error (alarm) indication on the PU display.

If your fault does not correspond to any of the following errors or if you have any other problem, please contact your sales representative.

- Retention of alarm output signal ..... When the magnetic contactor (MC) provided on the power supply side of the inverter is opened at the activation of the protective function, the inverter's control power will be lost and the alarm output will not be held.
- Alarm indication ..... When the protective function is activated, the operation panel display automatically switches to the above indication.
- Resetting method..... When the protective function is activated, the inverter output is kept stopped. Unless reset, therefore, the inverter cannot restart. Switch power off once, then on again; or apply RES signal for more than 0.1s. If the RES signal is kept on, "Err." appears (flickers) to indicate that the inverter is in a reset status.
- When the protective function is activated, take the appropriate corrective action, then reset the inverter, and resume operation.

### 3.1.1 Error (alarm) definitions

#### (1) Major failures

When the protective function is activated, the inverter output is shut off and the alarm is output.

Operation Panel Indication	OC1	OC 1	FR-PU04	OC During Acc
Name	Overcurrent shut-off during acceleration			
Description	When the inverter output current reaches or exceeds approximately 200% of the rated inverter current during acceleration, the protective circuit is activated to stop the inverter output.			
Check point	Check for sudden acceleration. Check that the downward acceleration time is not long in vertical lift application. Check for output short-circuit/earth fault.			
Corrective action	Increase the acceleration time. Shorten the downward acceleration time in vertical lift application.			

Operation Panel Indication	OC2	OC 2	FR-PU04	Stedy Spd OC
Name	Overcurrent shut-off during constant speed			
Description	When the inverter output current reaches or exceeds approximately 200% of the rated inverter current during constant-speed operation, the protective circuit is activated to stop the inverter output.			
Check point	Check for sudden load change. Check for output short-circuit/earth fault.			
Corrective action	Keep load stable.			

Operation Panel Indication	OC3	OC 3	FR-PU04	OC During Dec
Name	Overcurrent shut-off during deceleration			
Description	When the inverter output current reaches or exceeds approximately 200% of the rated inverter current during deceleration (other than acceleration or constant speed), the protective circuit is activated to stop the inverter output.			
Check point	Check for sudden speed reduction. Check for output short-circuit/earth fault. Check for too fast operation of motor's mechanical brake.			
Corrective action	Increase the deceleration time. Adjust brake operation.			

## Errors (Alarms)

Operation Panel Indication	OV1	OV1	FR-PU04	OV During Acc
Name	Regenerative overvoltage shut-off during acceleration			
Description	When the main circuit DC voltage in the inverter rises to or above the specified value due to excessive regenerative energy during acceleration, the protective circuit is activated to stop the inverter output. The circuit may also be activated by a surge voltage produced in the power supply system.			
Check point	Check for too slow acceleration. (e.g. during downward acceleration in vertical lift load)			
Corrective action	<ul style="list-style-type: none"> <li>• Decrease the acceleration time.</li> <li>• Install a power factor improving reactor.</li> </ul>			

Operation Panel Indication	OV2	OV2	FR-PU04	Stedy Spd OV
Name	Regenerative overvoltage shut-off during constant speed			
Description	When the main circuit DC voltage in the inverter rises to or above the specified value due to excessive regenerative energy during constant speed, the protective circuit is activated to stop the inverter output. The circuit may also be activated by a surge voltage produced in the power supply system.			
Check point	Check for sudden load change.			
Corrective action	<ul style="list-style-type: none"> <li>• Keep load stable.</li> <li>• Install a power factor improving reactor.</li> </ul>			

Operation Panel Indication	OV3	OV3	FR-PU04	OV During Dec
Name	Regenerative overvoltage shut-off during deceleration or stop			
Description	When the main circuit DC voltage in the inverter rises to or above the specified value due to excessive regenerative energy during deceleration or stop, the protective circuit is activated to stop the inverter output. The circuit may also be activated by a surge voltage produced in the power supply system.			
Check point	Check for sudden speed reduction.			
Corrective action	<ul style="list-style-type: none"> <li>• Increase the deceleration time. (Set the deceleration time which matches the moment of inertia of the load)</li> <li>• Decrease the braking duty.</li> <li>• Install a power factor improving reactor.</li> </ul>			

Operation Panel Indication	THM	<i>THM</i>	FR-PU04	Motor Overload
Name	Motor overload shut-off (electronic thermal relay function) (* 1)			
Description	The electronic thermal relay function in the inverter detects motor overheat due to overload or reduced cooling capability during low-speed operation to stop the inverter output. When a multi-pole motor or two or more motors are run, provide a thermal relay on the output side of the inverter. Protection from burning due to motor temperature rise.			
Check point	Check the motor for use under overload.			
Corrective action	<ul style="list-style-type: none"> <li>• Reduce the load weight.</li> <li>• For a constant-torque motor, set the constant-torque motor in Pr. 71 "applied motor".</li> </ul>			

Operation Panel Indication	THT	<i>THT</i>	FR-PU04	Inv. Overload
Name	Inverter overload shut-off (electronic thermal relay function) (* 1)			
Description	If a current of more than 150% of the rated output current flows and overcurrent shut-off does not occur (150% or less), inverse-time characteristics cause the electronic thermal relay function to be activated to stop the inverter output in order to protect the output transistors. Output transistor protection from overheat			
Check point	Check the motor for use under overload.			
Corrective action	Reduce the load weight.			

\*1. Resetting the inverter initializes the internal thermal integrated data of the electronic thermal relay function.

Operation Panel Indication	FIN	<i>Fin</i>	FR-PU04	H/Sink O/Temp
Name	Fin overheat			
Description	If the heatsink overheats, the temperature sensor is actuated to stop the inverter output.			
Check point	<ul style="list-style-type: none"> <li>• Check for too high ambient temperature.</li> <li>• Check for heatsink clogging.</li> </ul>			
Corrective action	Set the ambient temperature to within the specifications.			

Operation Panel Indication	GF	<i>GF</i>	FR-PU04	Earth Fault
Name	Start-time output side earth fault overcurrent protection			
Description	This function stops the inverter output if an earth fault overcurrent flows due to an earth fault which occurred on the inverter's output (load) side. Made valid when Pr. 40 "start-time earth fault detection selection" = "1".			
Check point	Check for an earth fault in the motor and connection cable.			
Corrective action	Remedy the earth fault portion.			

## Errors (Alarms)

Operation Panel Indication	OHT	<b>OHT</b>	FR-PU04	OH Fault
Name	External thermal relay (*2)			
Description	If the external thermal relay provided for motor overheating protection or the internally mounted temperature relay in the motor switches on (contacts open), the inverter output is stopped. If the relay contacts are reset automatically, the inverter will not restart unless it is reset.			
Check point	<ul style="list-style-type: none"> <li>• Check for motor overheating.</li> <li>• Check that the value of 7 (OH signal) is set correctly in any of Pr. 60 to Pr. 63 (input terminal function selection).</li> </ul>			
Corrective action	Reduce the load and operating duty.			

\*2. Functions only when any of Pr. 60 to Pr. 63 (input terminal function selection) is set to OH.

Operation Panel Indication	OLT	<b>OLT</b>	FR-PU04	Still Prev STP
Name	Stall prevention (overload)			
Description	The running frequency has fallen to 0 by stall prevention operation activated. OL appears while stall prevention is being activated.			
Check point	Check the motor for use under overload.			
Corrective action	Reduce the load weight.			

Operation Panel Indication	OPT	<b>OPT</b>	FR-PU04	Option Fault
Name	Communication error			
Description	Stops the inverter output if a setting error or connection (connector) fault occurs during use of RS-485 communication function.			
Check point	Check that the connector is plugged securely.			
Corrective action	Make connection securely. Please contact your sales representative.			

Operation Panel Indication	PE	<b>PE</b>	FR-PU04	Corrupt Memory
Name	Parameter storage device alarm			
Description	A fault occurred in parameters stored (example: E <sup>2</sup> PROM fault).			
Check point	Check for too many number of parameter write times.			
Corrective action	Please contact your sales representative.			

Operation Panel Indication	PUE	<b>PUE</b>	FR-PU04	PU Leave Out
Name	Parameter Unit disconnection			
Description	Stops the inverter output if communication between inverter and PU is suspended, e.g. if the PU is disconnected with "1" set in the communication parameter n17 "disconnected PU detection/PU setting lock".			
Check point	<ul style="list-style-type: none"> <li>• Check that the FR-PU04 is fitted securely.</li> <li>• Check the setting of the communication parameter n17 "disconnected PU detection".</li> </ul>			
Corrective action	Fit the FR-PU04 securely.			



Operation Panel Indication	RET	<i>r-ET</i>	FR-PU04	Retry No Over
Name	Retry count over			
Description	If operation cannot be resumed properly within the number of retries set, this function stops the inverter output.			
Check point	Find the cause of alarm occurrence.			
Corrective action	Eliminate the cause of the error preceding this error indication.			

Operation Panel Indication	CPU	<i>CPU</i>	FR-PU04	CPU Fault
Name	CPU error			
Description	If the arithmetic operation of the built-in CPU does not end within a predetermined period, the inverter self-determines it as an alarm and stops the output.			
Check point	—			
Corrective action	Please contact your sales representative.			

## (2) Minor failures

When the protective function is activated, the output is not shut off. You can make parameter setting to output the minor fault signal. (Set "98" in any of Pr. 64, Pr. 65 (output terminal function selection). Refer to page 98.)



Operation Panel Indication	FN	<i>F<sub>n</sub></i>	FR-PU04	FN
Name	Fan trouble			
Description	For the inverter which contains a cooling fan, <i>F<sub>n</sub></i> appears on the operation panel when the cooling fan stops due to a fault.			
Check point	Check the cooling fan for a fault.			
Corrective action	Replace the fan.			

### (3) Warnings

Operation Panel Indication	OL	<b>OL</b>	FR-PU04	OL
Name	Stall prevention (overcurrent)			
Description	During acceleration	If a current of more than 150% (* 3) of the rated inverter current flows in the motor, this function stops the increase in frequency until the overload current reduces to prevent the inverter from resulting in overcurrent shut-off. When the overload current has reduced below 150%, this function increases the frequency again.		
	During constant-speed operation	If a current of more than 150% (* 3) of the rated inverter current flows in the motor, this function lowers the frequency until the overload current reduces to prevent overcurrent shut-off. When the overload current has reduced below 150%, this function increases the frequency up to the set value.		
	During deceleration	If a current of more than 150% (* 3) of the rated inverter current flows in the motor, this function stops the decrease in frequency until the overload current reduces to prevent the inverter from resulting in overcurrent shut-off. When the overload current has reduced below 150%, this function decreases the frequency again.		
Check point	Check the motor for use under overload.			
Corrective action	<ul style="list-style-type: none"> <li>• The acceleration/deceleration time may change.</li> <li>• Increase the stall prevention operation level with Pr. 22 "stall prevention operation level", or disable stall prevention with Pr. 21 "stall prevention function selection".</li> <li>• Check that the torque boost (Pr. 0) setting is not higher than required.</li> </ul>			

\*3. The stall prevention operation current can be set as desired. It is factory-set to 150%.

Operation Panel Indication	oL	<b>oL</b>	FR-PU04	oL
Name	Stall prevention (overvoltage)			
Description	During deceleration	If the regenerative energy of the motor increases too much to exceed the brake capability, this function stops the decrease in frequency to prevent overvoltage shut-off. As soon as the regenerative energy has reduced, deceleration resumes.		
Check point	Check for sudden speed reduction.			
Corrective action	The deceleration time may change. Increase the deceleration time using Pr. 8 "deceleration time".			

Operation Panel Indication	PS	<i>PS</i>	FR-PU04	PS
Name	PU stop			
Description	Pr. 75 "reset selection/PU stop selection" had been set and a stop was made by pressing the  of the operation panel or parameter unit (FR-PU04) during operation in the external operation mode.			
Check point	Check for a stop made by pressing the  of the operation panel during external operation.			
Corrective action	Refer to page 103.			

Operation Panel Indication	UV	<i>UV</i>
Name	Undervoltage	
Description	If the power supply voltage of the inverter reduces, the control circuit will not operate properly and will result in decreased motor torque or increased heat generation. To prevent this, if the power supply voltage reduces below about 230VAC (about 115VAC for the single-phase 200V power input series), this function stops the inverter output.	
Check point	<ul style="list-style-type: none"> <li>• Check for a start of large-capacity motor.</li> <li>• Check that the power supply capacity is as indicated in the specifications (Refer to page 168.).</li> </ul>	
Corrective action	Check the power supply system equipment such as the power supply.	

**(4) Write errors**

Operation Panel Indication	Er1	<b>Er 1</b>	FR-PU04	Control Mode
Name	Write disable error			
Description	<ul style="list-style-type: none"> <li>Write was performed with "1" (write disable) set in Pr. 77 "parameter write disable selection".</li> <li>Frequency jump setting range overlapped.</li> <li>Parameter write was performed though the operation panel does not have the write precedence.</li> </ul>			
Corrective action	<ul style="list-style-type: none"> <li>Check the setting of Pr. 77 "parameter write disable selection". (Refer to page 106.)</li> <li>Check the settings of Pr. 31 to 36 (frequency jump). (Refer to page 78.)</li> <li>When the FR-PU04 is fitted and n17 = "0" or "1", the operation of the operation panel is invalid.</li> </ul> For RS-485 connector (RS-485) communication, the operation of the operation panel is invalid.			

Operation Panel Indication	Er2	<b>Er 2</b>	FR-PU04	In PU/EXT Mode OPERATOR ERR
Name	Write-while-running error/mode designation error			
Description	<ul style="list-style-type: none"> <li>Write was performed during operation.</li> <li>An attempt was made to change the Pr. 79 setting to the operation mode where the operation command has been input.</li> <li>Write was performed in the external operation mode.</li> </ul>			
Corrective action	<ul style="list-style-type: none"> <li>After stopping operation, make parameter setting.</li> <li>After setting the operation mode to the "PU operation mode", make parameter setting. (Refer to page 107.)</li> </ul>			

Operation Panel Indication	Er3	<b>Er 3</b>	FR-PU04	Incr I/P
Name	Calibration error			
Description	Analog input bias and gain calibration values are too close.			
Corrective action	Check the settings of C3, C4, C6 and C7 (calibration functions). (Refer to page 80.)			

### 3.1.2 To know the operating status at the occurrence of alarm (only when FR-PU04 is used)

When any alarm has occurred, the display automatically switches to the indication of the corresponding protective function (error). By pressing the **(MON)** at this point without resetting the inverter, the display shows the output frequency. In this way, it is possible to know the running frequency at the occurrence of the alarm. It is also possible to know the current in the same manner. After resetting, you can confirm the definitions in "Alarm History". (For details, refer to the instruction manual of the parameter unit (FR-PU04).)

### 3.1.3 Correspondence between digital and actual characters

There are the following correspondences between the actual alphanumeric characters and the digital characters displayed on the operation panel:

Actual	Display	Actual	Display	Actual	Display
0	0	A	A	M	7
1	1	B	b	N	7
2	2	C	C	O	0
3	3	D	d	o	0
4	4	E	E	P	P
5	5	F	F	S	5
6	6	G	G	T	7
7	7	H	H	U	U
8	8	I	I	V	U
9	9	J	J	r	r
		L	L	-	-

### 3.1.4 Resetting the inverter

The inverter can be reset by performing any of the following operations. Note that the internal thermal integrated value of the electronic thermal relay function and the number of retries are cleared (erased) by resetting the inverter.

Recover about 1s after reset is cancelled.

**Err**.(Err) flickers on the operation panel during reset.

- Operation 1 ..... Using the operation panel, perform a reset with the **(STOP RESET)**.  
(Enabled only when the inverter protective function is activated (major failure))
- Operation 2 ..... Switch power off once, then switch it on again after the LED turns off.
- Operation 3 ..... Turn on the reset signal (RES). (Assign this signal to any of Pr. 60 to Pr. 63.) (Refer to page 34, 96.)

## 3.2 Troubleshooting

### POINTS

If the cause is still unknown after every check, it is recommended to initialize the parameters (return to factory setting) then re-set the required parameter values and check again.

### 3.2.1 Motor remains stopped

#### 1) Check the main circuit

- Check that a proper power supply voltage is applied (operation panel display is provided).
- Check that the motor is connected properly.
- Check that the jumper across + - P1 is connected.

#### 2) Check the input signals

- Check that the start signal is input.
- Check that both the forward and reverse rotation start signals are not input simultaneously.
- Check that the frequency setting signal is not zero.
- Check that the AU signal is on when the frequency setting signal is 4 to 20mA.
- Check that the output stop signal (MRS) or reset signal (RES) is not on. (Assign signals MRS and RES using Pr. 60 to Pr. 63 (input terminal function selection).)
- Check that the sink or source jumper connector is fitted securely.

#### 3) Check the parameter settings

- Check that the reverse rotation prevention (Pr. 78) is not selected.
- Check that the operation mode (Pr. 79) setting is correct.
- Check that the bias and gain (C2 to C7) settings are correct.
- Check that the starting frequency (Pr. 13) setting is not greater than the running frequency.
- Check that various operational functions (such as three-speed operation), especially the maximum frequency (Pr. 1), are not zero.

#### 4) Check the load

- Check that the load is not too heavy.
- Check that the shaft is not locked.

#### 5) Others

- Check that the operation panel display does not show an error (e.g. OC1).
- Check that the Pr. 15 "jog frequency" setting is not lower than the Pr. 13 "starting frequency" value.

### 3.2.2 Motor rotates in opposite direction

- Check that the phase sequence of output terminals U, V and W is correct.
- Check that the start signals (forward rotation, reverse rotation) are connected properly.
- Check the setting of Pr. 17 "RUN key rotation direction selection".

### 3.2.3 Speed greatly differs from the setting

- Check that the frequency setting signal is correct. (Measure the input signal level.)
- Check that the following parameter settings are correct (Pr. 1, Pr. 2, Pr. 19, Pr. 38, Pr. 39, Pr. 95, C2 to C7).
- Check that the input signal lines are not affected by external noise. (Use shielded cables)
- Check that the load is not too heavy.

### 3.2.4 Acceleration/deceleration is not smooth

- Check that the acceleration and deceleration time settings are not too short.
- Check that the load is not too heavy.
- Check that the torque boost setting is not too large to activate the stall prevention function.

### 3.2.5 Motor current is large

- Check that the load is not too heavy.
- Check that the torque boost setting is not too large.

### 3.2.6 Speed does not increase

- Check that the maximum frequency setting is correct.
- Check that the load is not too heavy. (In agitators, etc., load may become heavier in winter.)
- Check that the torque boost setting is not too large to activate the stall prevention function.

### 3.2.7 Speed varies during operation

When slip compensation is selected, the output frequency varies with load fluctuation between 0 and 2Hz. This is a normal operation and is not a fault.

#### 1) Inspection of load

- Check that the load is not varying.

#### 2) Inspection of input signal

- Check that the frequency setting signal is not varying.
- Check that the frequency setting signal is not affected by noise.
- Check for a malfunction due to an undesirable current when the transistor output unit is connected. (Refer to page 21.)

#### 3) Others

- Check that the wiring length is not too long.
- Check that GD<sup>2</sup> load is not small. (at the motor GD<sup>2</sup> or smaller)  
 . . . . . FR-S540E-1.5K to 3.7K  
 If so, set the Pr. 72 "PWM frequency selection" to 6kHz or higher.  
 (Check for noise or leakage current problem.)

### 3.2.8 Operation mode is not changed properly

If the operation mode does not change correctly, check the following:

1. External input signal ..... Check that the STF or STR signal is off.  
When it is on, the operation mode cannot be changed.

2. Parameter setting ..... Check the Pr. 79 setting.  
When the Pr. 79 "operation mode selection" setting is "0", switching input power on places the inverter in the external operation mode.

Press the  to switch to the PU operation mode.

For other settings (1 to 8), the operation mode is limited accordingly.

(For details of Pr. 79, refer to page 107.)



### 3.2.9 Operation panel display is not operating

— Make sure that terminals PC-SD are not shorted.

— Make sure that the connector is fitted securely across terminals + - P1.

### 3.2.10 Parameter write cannot be performed

— Make sure that operation is not being performed (signal STF or STR is not ON).

— Check that the  () was pressed.

— Make sure that you are not attempting to set the parameter outside the setting range.

— Make sure that you are not attempting to set the parameter in the external operation mode.

— Check Pr. 77 "parameter write disable selection".

### 3.2.11 Motor produces annoying sound

— Check the Pr. 70 "Soft-PWM setting" and Pr. 72 "PWM frequency selection" settings.

— Make sure that the deceleration time is not too short.



# 4. SPECIFICATIONS

This chapter provides the "specifications" of this product. Always read the instructions before using the equipment

<b>4.1 Specification list .....</b>	<b>168</b>
<b>4.2 Outline drawings .....</b>	<b>172</b>

Chapter 1

Chapter 2

Chapter 3

Chapter 4

## 4.1 Specification list

### 4.1.1 Ratings

(1) Three-phase 400V power supply

Type FR-S540E-□K-EC		0.4	0.75	1.5	2.2	3.7
Applied motor capacity (kW) (*1)		0.4	0.75	1.5	2.2	3.7
Output	Rated capacity (kVA) (*2)	0.9	1.6	2.7	3.7	5.9
	Rated current (A)	1.1	2.1	3.5	4.8	7.7
	Overload current rating (*3)	150% 60s, 200% 0.5s (Inverse time characteristics)				
	Voltage (*4)	Three phase, 380V to 480V 50Hz/60Hz				
Power supply	Rated input AC voltage/frequency	Three phase, 380V to 480V 50Hz/60Hz				
	Permissible AC voltage fluctuation	325 to 528V 50Hz/60Hz				
	Permissible frequency fluctuation	±5%				
	Power supply system capacity (kVA) (*5)	1.5	2.5	4.5	5.5	9.5
Protective structure (JEM1030)		Enclosed type (IP20)				
Cooling system		Self-cooling		Forced air cooling		
Approximate mass (kg)		1.5	1.5	1.5	1.6	1.7

- \*1. The applied motor capacity indicated is the maximum capacity applicable for use of the Mitsubishi 4-pole standard motor.
- \*2. The rated output capacity indicated assumes that the output voltage is 440V.
- \*3. The % value of the overload current rating indicates the ratio of the overload current to the inverter's rated output current.  
For repeated duty, allow time for the inverter and motor to return to or below the temperatures under 100% load.
- \*4. The maximum output voltage does not exceed the power supply voltage. You can set the maximum output voltage to any value below the power supply voltage. However, the pulse voltage value of the inverter output side voltage remains unchanged at about  $\sqrt{2}$  that of the power supply.
- \*5. The power supply capacity varies with the value of the power supply side inverter impedance (including those of the input reactor and cables).

## (2) Single-phase 200V power supply

Type FR-S520SE-□K-EC		0.2	0.4	0.75	1.5
Applicable motor capacity (kW) (*1)		0.2	0.4	0.75	1.5
Output	Rated capacity (kVA) (*2)	0.5	1.0	1.6	2.8
	Rated current (A)	1.4	2.5	4.1	7.0
	Overload current rating (*3)	150% 60s, 200% 0.5s (Inverse time characteristics)			
	Voltage (*4)	Three phase, 200V to 240V 50Hz/60Hz			
Power supply	Rated input AC voltage/frequency	Single-phase, 200V to 240V 50Hz/60Hz			
	Permissible AC voltage fluctuation	170 to 264V 50Hz/60Hz			
	Permissible frequency fluctuation	±5%			
	Power supply system capacity (kVA) (*5)	0.9	1.5	2.5	4.4
Protective structure (JEM1030)		Enclosed type (IP20)			
Cooling system		Self-cooling			Forced air cooling
Approximate mass (kg)		0.6	0.8	1.0	1.5

- \*1. The applied motor capacity indicated is the maximum capacity applicable when a Mitsubishi 4-pole standard motor is used.
- \*2. The rated output capacity indicated assumes that the output voltage is 230V.
- \*3. The % value of the overload current rating indicates the ratio of the overload current to the inverter's rated output current.  
For repeated duty, allow time for the inverter to return to or below the temperatures under 100% load.
- \*4. The maximum output voltage does not exceed the power supply voltage. The maximum output voltage may be set as desired below the power supply voltage. However, the PWM pulse voltage value of the inverter output side voltage remains unchanged at about  $\sqrt{2}$  that of the power supply.
- \*5. The power supply capacity changes with the values of the power supply side inverter impedances (including those of the input reactor and cables).

## 4.1.2 Common specifications

Control specifications	Control system		Selectable between Soft-PWM control and high carrier frequency PWM control, V/F control or automatic torque boost control are selectable.	
	Output frequency range		0.5 to 120Hz (starting frequency variable between 0 and 60Hz)	
	Frequency setting resolution		5VDC input: 1/500 of max. set frequency, 10VDC, 4 to 20mADC input: 1/1000 of max. set frequency Digital input: 0.1Hz (less than 100Hz), 1Hz (100Hz or higher)	
	Frequency accuracy		Analog input: Within $\pm 1\%$ of max. output frequency ( $25^{\circ}\text{C} \pm 10^{\circ}\text{C}$ ) Digital input: Within $\pm 0.5\%$ of set output frequency (when set by the setting dial)	
	Starting torque		150% (at 5Hz) during automatic torque boost control	
	Acceleration/deceleration time setting		0, 0.1 to 999s (acceleration and deceleration can be set individually), linear or S-pattern acceleration/deceleration mode can be selected.	
	Braking torque (*2)	Regeneration	0.2K ... 150%, 0.4K, 0.75K ... 100%, 1.5K ... 50%, 2.2K, 3.7K ... 20%	
		DC injection brake	Operation frequency (0 to 120Hz), operation time (0 to 10s), operation voltage (0 to 15%)	
	Input signals	Frequency setting signal	Analog input	0 to 5VDC, 0 to 10VDC, 4 to 20mA
			Digital input	Entered from operation panel
Start signal		STF, STR	Forward and reverse rotation, start signal automatic self-holding input (3-wire input) can be selected.	
Alarm reset			Used to reset alarm output provided when protective function is activated.	
Multi-speed selection			Up to 15 speeds can be selected. (Each speed can be set between 0 and 120Hz, running speed can be changed during operation from the operation panel.)	
Second function selection			Used to select second functions (acceleration time, deceleration time, torque boost, base frequency, electronic thermal relay function).	
Output stop			Instantaneous shut-off of inverter output (frequency, voltage)	
Current input selection			Used to select frequency setting signal 4 to 20 mA (terminal 4).	
External thermal relay input			Thermal relay contact input for use when the inverter is stopped by the external thermal relay.	
Jog signal			Jog operation mode selection	
PID control valid			Selection for exercising PID control	
PU operation /external operation switchover			Used to switch between PU operation and external operation from outside the inverter.	

Use Pr. 60 to Pr. 63 for selection

Control specifications	Operational functions		Maximum and minimum frequency settings, frequency jump operation, external thermal relay input selection, automatic restart after instantaneous power failure, forward/reverse rotation prevention, slip compensation, operation mode selection, PID control, computer link operation (RS-485).
	Output signals	Operating Status	1 open collector signal can be selected from among inverter running, up-to-frequency, frequency detection, overload warning, zero current detection, output current detection, PID upper limit, PID lower limit, PID forward/reverse rotation, operation ready, current average value monitor signal, maintenance timer alarm, minor failure and alarm. 1 contact output (1 contact, 230V 0.3AAC, 30V 0.3ADC) signal can be selected.
		For meter	1 signal can be selected from between output frequency and motor current. Analog output (0 to 5VDC)
Protective/warning function			Overcurrent shut-off (during acceleration, deceleration, constant speed), regenerative overvoltage shut-off (during acceleration, deceleration, constant speed), overload shut-off (electronic thermal relay function), heatsink overheat, fan failure (*3), stall prevention, start-time output side earth fault protection (*4), external thermal relay (*5), disconnected PU, retry count over, communication error, CPU error, undervoltage (*1)
Environment	Ambient temperature		-10°C to +50°C (non-freezing)
	Ambient humidity		90%RH or less (non-condensing)
	Storage temperature (*6)		-20°C to +65°C
	Atmosphere		Indoors (without corrosive gas, flammable gas, oil mist, dust and dirt etc.)
	Altitude, vibration		Maximum 1000m above sea level for standard operation. After that derate by 3% for every extra 500m up to 2500m (91%). 5.9m/s <sup>2</sup> or less (conforms to JIS C 60068-2-6)

- \*1. When undervoltage or instantaneous power failure occurs, no alarm output is provided but the output is shut off. After power restoration, the inverter may be run as it is. Depending on the running status (e.g. load magnitude), however, overcurrent, regenerative overvoltage or other protection may be activated at power restoration. (in the external operation mode)
- \*2. The braking torque indicated is a short-duration average torque (which varies with motor loss) when the motor alone is decelerated from 60Hz in the shortest time and is not a continuous regenerative torque. When the motor is decelerated from the frequency higher than the base frequency, the average deceleration torque will reduce.
- \*3. Compatible with only the product having the built-in cooling fan.
- \*4. Activated only when "1 (factory setting)" is set in Pr. 40 "start-time earth fault detection selection".
- \*5. Activated only when external thermal relay input (OH) is selected in any of Pr. 60 to Pr. 63 (input terminal function selection).
- \*6. Temperature applicable for a short period such as transportation.

## 4.2 Outline drawings

•FR-S520SE-0.2K, 0.4K, 0.75K-EC

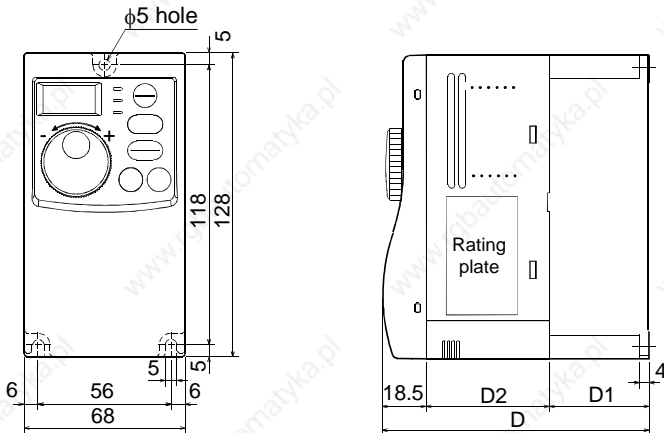

•Single-phase 200V power supply

Capacity	D	D1	D2
0.2K	80.5	10	52
0.4K	142.5	42	82
0.75K	162.5	62	82

(Unit: mm)

- FR-S540E-0.4K, 0.75K, 1.5K, 2.2K, 3.7K-EC
- FR-S520SE-1.5K-EC

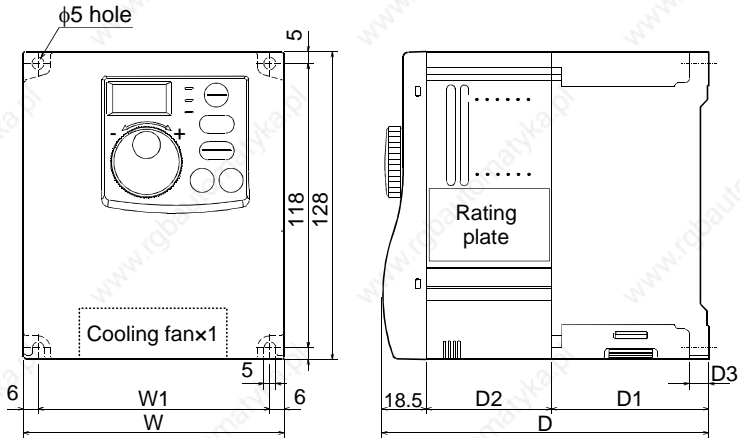

•Three-phase 400V power supply

Capacity	W	W1	D	D1	D2	D3
0.4K,0.75K	108	96	129.5	59	52	5
1.5K	108	96	135.5	65	52	8
2.2K	108	96	155.5	65	72	8
3.7K	108	96	165.5	65	82	8

•Single-phase 200V power supply

Capacity	W	W1	D	D1	D2	D3
1.5K	108	96	155.5	65	72	8

(Unit: mm)

**REMARKS**

- The FR-S540E-0.4K, 0.75K-EC do not have a cooling fan.

**Outline drawings**

•Parameter unit (FR-PU04)

<Outline drawing>

<Panel cut dimension drawing>

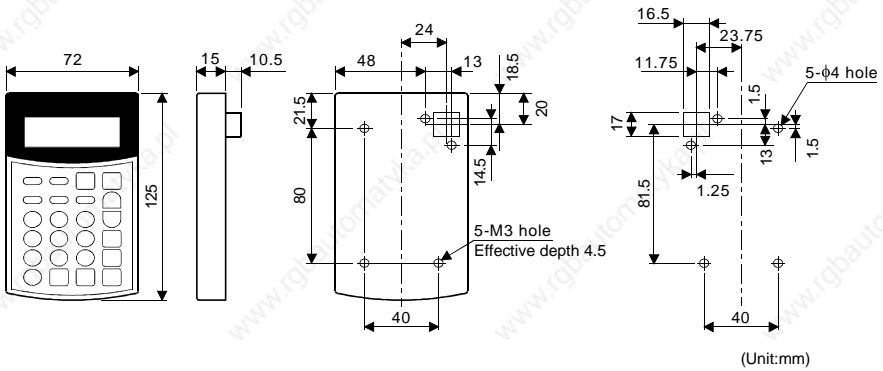

Choose the mounting screws whose length will not exceed the effective depth of the mounting threads.



# APPENDIX

**APPENDIX 1 Parameter Instruction Code List ..... 176**

## APPENDIX 1 Parameter Instruction Code List

Function	Parameter Number	Name	Instruction Code		Computer Link Data Setting Increments*	Link Parameter Extension Setting (Instruction Code 7F/FF)
			Read	Write		
Basic functions	0	Torque boost	00	80	0.1%	0
	1	Maximum frequency	01	81	0.01Hz	0
	2	Minimum frequency	02	82	0.01Hz	0
	3	Base frequency	03	83	0.01Hz	0
	4	Multi-speed setting (high speed)	04	84	0.01Hz	0
	5	Multi-speed setting (middle speed)	05	85	0.01Hz	0
	6	Multi-speed setting (low speed)	06	86	0.01Hz	0
	7	Acceleration time	07	87	0.1s	0
	8	Deceleration time	08	88	0.1s	0
	9	Electronic thermal O/L relay	09	89	0.01A	0
	30	Extended function display selection	1E	9E	1	0
79	Operation mode selection	4F	None	1	0	

The extended function parameters are made valid by setting "1" in Pr. 30 "extended function display selection".

Function	Parameter Number	Name	Instruction Code		Computer Link Data Setting Increments *	Link Parameter Extension Setting (Instruction Code 7F/FF)
			Read	Write		
Standard operation functions	10	DC injection brake operation frequency	0A	8A	0.01Hz	0
	11	DC injection brake operation time	0B	8B	0.1s	0
	12	DC injection brake voltage	0C	8C	0.1%	0
	13	Starting frequency	0D	8D	0.01Hz	0
	14	Load pattern selection	0E	8E	1	0
	15	Jog frequency	0F	8F	0.01Hz	0
	16	Jog acceleration/ deceleration time	10	90	0.1s	0
	17	RUN key rotation direction selection	11	91	1	0
	19	Base frequency voltage	13	93	0.1V	0
	20	Acceleration/deceleration reference frequency	14	94	0.01Hz	0
	21	Stall prevention function selection	15	95	1	0
	22	Stall prevention operation level	16	96	0.1%	0

Function	Parameter Number	Name	Instruction Code		Computer Link Data Setting Increments *	Link Parameter Extension Setting (Instruction Code 7F/FF)
			Read	Write		
Standard operation functions	23	Stall prevention operation level compensation factor at double speed	17	97	0.1%	0
	24	Multi-speed setting (speed 4)	18	98	0.01Hz	0
	25	Multi-speed setting (speed 5)	19	99	0.01Hz	0
	26	Multi-speed setting (speed 6)	1A	9A	0.01Hz	0
	27	Multi-speed setting (speed 7)	1B	9B	0.01Hz	0
	28	Stall prevention operation reduction starting frequency	1C	9C	0.01Hz	0
	29	Acceleration/deceleration pattern	1D	9D	1	0
	31	Frequency jump 1A	1F	9F	0.01Hz	0
	32	Frequency jump 1B	20	A0	0.01Hz	0
	33	Frequency jump 2A	21	A1	0.01Hz	0
	34	Frequency jump 2B	22	A2	0.01Hz	0
	35	Frequency jump 3A	23	A3	0.01Hz	0
	36	Frequency jump 3B	24	A4	0.01Hz	0
	37	Speed display	25	A5	0.001	0
	38	Frequency setting voltage gain frequency	26	A6	0.01Hz	0
	39	Frequency setting current gain frequency	27	A7	0.01Hz	0
40	Start-time earth fault detection selection	28	A8	1	0	
Output terminal functions	41	Up-to-frequency	29	A9	0.1%	0
	42	Output frequency detection	2A	AA	0.01Hz	0
	43	Output frequency detection for reverse rotation	2B	AB	0.01Hz	0
Second functions	44	Second acceleration/deceleration time	2C	AC	0.1s	0
	45	Second deceleration time	2D	AD	0.1s	0
	46	Second torque boost	2E	AE	0.1%	0
	47	Second V/F (base frequency)	2F	AF	0.01Hz	0
Current detection	48	Output current detection level	30	B0	0.1%	0
	49	Output current detection signal delay time	31	B1	0.1s	0
	50	Zero current detection level	32	B2	0.1%	0
	51	Zero current detection period	33	B3	0.01s	0

## Parameter Instruction Code List

Function	Parameter Number	Name	Instruction Code		Computer Link Data Setting Increments *	Link Parameter Extension Setting (Instruction Code 7F/FF)
			Read	Write		
Display functions	52	Operation panel display data selection	34	B4	1	0
	53	Frequency setting operation selection	35	B5	1	0
	54	terminal function selection	36	B6	1	0
	55	Frequency monitoring reference	37	B7	0.01Hz	0
	56	Current monitoring reference	38	B8	0.01A	0
Automatic restart functions	57	Restart coasting time	39	B9	0.1s	0
	58	Restart cushion time	3A	BA	0.1s	0
Additional function	59	Remote setting function selection	3B	BB	1	0
Terminal functions selection	60	RL terminal function selection	3C	BC	1	0
	61	RM terminal function selection	3D	BD	1	0
	62	RH terminal function selection	3E	BE	1	0
	63	STR terminal function selection	3F	BF	1	0
	64	RUN terminal function selection	40	C0	1	0
	65	A, B, C terminal function selection	41	C1	1	0
Operation selection functions	66	Retry selection	42	C2	1	0
	67	Number of retries at alarm occurrence	43	C3	1	0
	68	Retry waiting time	44	C4	0.1s	0
	69	Retry count display erase	45	C5	1	0
	70	Soft-PWM setting	46	C6	1	0
	71	Applied motor	47	C7	1	0
	72	PWM frequency selection	48	C8	1	0
	73	0-5V/0-10V selection	49	C9	1	0
	74	Input filter time constant	4A	CA	1	0
	75	Reset selection/PU stop selection	4B	CB	1	0
	76	Cooling fan operation selection	4C	CC	1	0
	77	Parameter write disable selection	4D	None	1	0
	78	Reverse rotation prevention selection	4E	CE	1	0

Function	Parameter Number	Name	Instruction Code		Computer Link Data Setting Increments *	Link Parameter Extension Setting (Instruction Code 7F/FF)
			Read	Write		
Multi-speed operation	80	Multi-speed setting (speed 8)	50	D0	0.01Hz	0
	81	Multi-speed setting (speed 9)	51	D1	0.01Hz	0
	82	Multi-speed setting (speed 10)	52	D2	0.01Hz	0
	83	Multi-speed setting (speed 11)	53	D3	0.01Hz	0
	84	Multi-speed setting (speed 12)	54	D4	0.01Hz	0
	85	Multi-speed setting (speed 13)	55	D5	0.01Hz	0
	86	Multi-speed setting (speed 14)	56	D6	0.01Hz	0
	87	Multi-speed setting (speed 15)	57	D7	0.01Hz	0
PID control	88	PID action selection	58	D8	1	0
	89	PID proportional band	59	D9	0.1%	0
	90	PID integral time	5A	DA	0.1s	0
	91	PID upper limit	5B	DB	0.1%	0
	92	PID lower limit	5C	DC	0.1%	0
	93	PID action set point for PU operation	5D	DD	0.01%	0
	94	PID differential time	5E	DE	0.01s	0
Sub functions	95	Rated motor slip	5F	DF	0.01%	0
	96	Slip compensation time constant	60	E0	0.01s	0
	97	Constant-output region slip compensation selection	61	E1	1	0
	98	Automatic torque boost selection (Motor capacity)	62	E2	0.01kW	0
	99	Motor primary resistance	63	E3	0.001Ω	0
Maintenance function	H1 (503)	Maintenance timer	03	—	1	5
	H2 (504)	Maintenance timer alarm output set time	04	84	1	5
	H3 (555)	Current average time	37	B7	0.1s	5
	H4 (556)	Data output mask time	38	B8	0.1s	5
	H5 (557)	Current average value monitor signal output reference current	39	B9	0.01A	5

**Parameter Instruction Code List**

Function	Parameter Number	Name	Instruction Code		Computer Link Data Setting Increments *	Link Parameter Extension Setting (Instruction Code 7F/FF)
			Read	Write		
Additional function	H6 (162)	Automatic restart after instantaneous power failure selection	3E	BE	1	1
	H7 (559)	Second electronic thermal O/L relay	3B	BB	0.01A	5
Calibration parameters	C1 (901)	AM terminal calibration	5D	DD	—	1
	C2(902)	Frequency setting voltage bias frequency	5E	DE	0.01Hz	1 (6C/EC=0)
	C3(902)	Frequency setting voltage bias	5E	DE	0.1%	1 (6C/EC=1)
	C4(903)	Frequency setting voltage gain	5F	DF	0.1%	1 (6C/EC=1)
	C5(904)	Frequency setting current bias frequency	60	E0	0.01Hz	1 (6C/EC=0)
	C6(904)	Frequency setting current bias	60	E0	0.1%	1 (6C/EC=1)
	C7(905)	Frequency setting current gain	61	E1	0.1%	1 (6C/EC=1)
	C8(269)	Parameter set by manufacturer.				
Clear parameters	CLr	Parameter clear	—	FC	1	—
	ECL	Alarm history clear	—	F4	1	—

Function	Parameter Number	Name	Instruction Code		Computer Link Data Setting Increments *	Link Parameter Extension Setting (Instruction Code 7F/FF)
			Read	Write		
Communication parameters	n1 (331)	Communication station number	1F	9F	1	3
	n2 (332)	Communication speed	20	A0	1	3
	n3 (333)	Stop bit length	21	A1	1	3
	n4 (334)	Parity check presence/absence	22	A2	1	3
	n5 (335)	Number of communication retries	23	A3	1	3
	n6 (336)	Communication check time interval	24	A4	0.1s	3
	n7 (337)	Waiting time setting	25	A5	1	3
	n8 (338)	Operation command source	26	A6	1	3
	n9 (339)	Speed command source	27	A7	1	3
	n10 (340)	Link startup mode selection	28	A8	1	3
	n11 (341)	CR/LF selection	29	A9	1	3
	n12 (342)	E <sup>2</sup> PROM write selection	2A	AA	1	3
	n13 (145)	PU display language selection	2D	AD	1	1
	n14 (990)	PU buzzer control	5A	DA	1	9
	n15 (991)	PU contrast adjustment	5B	DB	1	9
	n16 (992)	PU main display screen data selection	5C	DC	1	9
	n17 (993)	Disconnected PU detection/PU setting lock	5D	DD	1	9

The parameter numbers in parentheses are those for use with the parameter unit (FR-PU04).

\* Though parameter setting by RS-485 communication can be made in the setting increments indicated in the table, note that the valid setting increments are as indicated in the parameter list (page 46).

REVISIONS

\*The manual number is given on the bottom left of the back cover.

Print Date	*Manual Number	Revision
Sep., 2004	IB(NA)-0600211ENG-A	First edition