

## **CJ Series General-purpose Serial Connection Guide (RS-485 Modbus Communication)**

**OMRON Corporation  
Multi-function Compact Inverter  
(3G3MX2 Series Type V1)**

### **About Intellectual Property Rights and Trademarks**

---

Microsoft product screen shots reprinted with permission from Microsoft Corporation.

Windows is a registered trademark of Microsoft Corporation in the USA and other countries.

Company names and product names in this document are the trademarks or registered trademarks of their respective companies.

---

## Table of Contents

<b>1. Related Manuals</b> .....	<b>1</b>
<b>2. Terms and Definitions</b> .....	<b>2</b>
<b>3. Precautions</b> .....	<b>3</b>
<b>4. Overview</b> .....	<b>4</b>
<b>5. Applicable Devices and Device Configuration</b> .....	<b>5</b>
5.1. Applicable Devices .....	5
5.2. Device Configuration .....	6
<b>6. Serial Communications Settings</b> .....	<b>8</b>
6.1. Parameters .....	8
6.2. Cable Wiring Diagram .....	9
<b>7. Serial Communications Connection Procedure</b> .....	<b>10</b>
7.1. Work Flow .....	10
7.2. Setting up Inverter .....	11
7.3. Setting up PLC .....	17
7.4. Checking the Serial Communications .....	31
<b>8. Initialization Method</b> .....	<b>35</b>
8.1. Initializing PLC .....	35
8.2. Initializing Inverter .....	36
<b>9. Program</b> .....	<b>37</b>
9.1. Overview .....	37
9.2. Destination Device Command .....	42
9.3. Error Detection Processing .....	44
9.4. Memory Maps .....	45
9.5. Ladder program .....	48
9.6. Timing Chart .....	54
9.7. Error processing .....	55
<b>10. Revision History</b> .....	<b>57</b>

## 1. Related Manuals

To ensure system safety, make sure to always read and heed the information provided in all Safety Precautions and Precautions for Safe Use of manuals for each device which is used in the system.

The table below lists the manuals related to this document.

Cat. No.	Model	Manual name
W472	CJ2H-CPU6[]-EIP CJ2H-CPU6[] CJ2M-CPU[][]	CJ Series CJ2 CPU Unit Hardware USER'S MANUAL
W473	CJ2H-CPU6[]-EIP CJ2H-CPU6[] CJ2M-CPU[][]	CJ Series CJ2 CPU Unit Software USER'S MANUAL
W336	CJ1W-SCU[]1-V1 CJ1W-SCU[]2	CJ Series Serial Communications Units OPERATION MANUAL
W446	-	CX-Programmer OPERATION MANUAL
W342	CJ2[]-CPU[][]	CJ Series Communications Commands REFERENCE MANUAL
W474	CJ2[]-CPU[][]	CJ Series Programmable Controllers INSTRUCTIONS REFERENCE MANUAL
I585	3G3MX2-A[][][]-V1	Multi-function Compact Inverter MX2 Series Type V1 User's Manual

## 2. Terms and Definitions

Term	Explanation and Definition
Serial Gateway mode	This is a function of PLC that performs serial communications by automatically converting a message (command data) to a specified protocol (either CompoWay/F, Modbus-RTU, or Modbus-ASCII) depending on a type of message.

## 3. Precautions

- (1) Understand the specifications of devices which are used in the system. Allow some margin for ratings and performance. Provide safety measures, such as installing safety circuit, in order to ensure safety and minimize risks of abnormal occurrence.
- (2) To ensure system safety, make sure to always read and heed the information provided in all Safety Precautions and Precautions for Safe Use of manuals for each device which is used in the system.
- (3) The user is encouraged to confirm the standards and regulations that the system must conform to.
- (4) It is prohibited to copy, to reproduce, and to distribute a part or the whole of this document without the permission of OMRON Corporation.
- (5) The information contained in this document is current as of November 2015. It is subject to change without notice for improvement.

The following notations are used in this document.



**Caution**

Indicates a potentially hazardous situation which, if not avoided, may result in minor or moderate injury or property damage.



### Precautions for Safe Use

Precautions on what to do and what not to do to ensure safe usage of the product.



### Precautions for Correct Use

Precautions on what to do and what not to do to ensure proper operation and performance.



### Additional Information

Additional information to read as required.

This information is provided to increase understanding or make operation easier.

### Symbol



The triangle symbol indicates precautions (including warnings).  
The specific operation is shown in the triangle and explained in text.  
This example indicates a general precaution.



The filled circle symbol indicates operations that you must do.  
The specific operation is shown in the circle and explained in text.  
This example shows a general precaution for something that must do.

## 4. Overview

This document describes the procedures for connecting 3G3MX2 Series Type V1 Multi-function Compact Inverter (hereinafter referred to as Inverter) of OMRON Corporation (hereinafter referred to as OMRON) to CJ-series Programmable Controller + Serial Communications Unit (hereinafter referred to as PLC) of OMRON using serial communications as well as the procedures for checking their connections.

Refer to *Section 6. Serial Communications Settings* and *Section 7. Serial Communications Connection Procedure* to understand setting methods and key points to send or receive messages using serial communications.

The ladder program in a prepared CX-Programmer project file is used to check the serial connection by sending or receiving the messages of "Total Power ON Time Monitor" to/from Inverter.

### ■ Send/Receive messages of "Total Power ON Time Monitor"

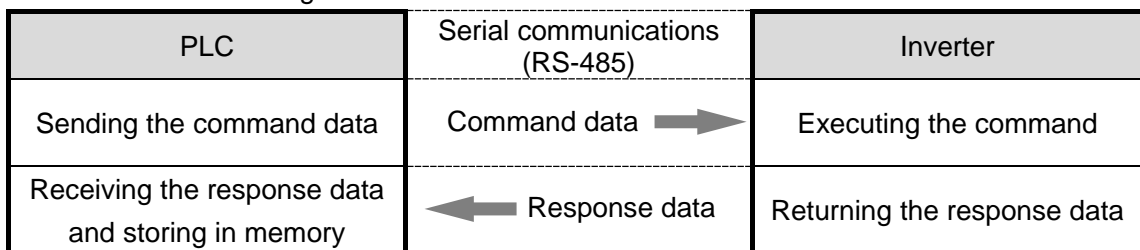

Prepare a latest CX-Programmer project file beforehand. To obtain a project file, contact your OMRON representative.

Name	File name	Version
CX-Programmer project file (extension: cxp)	OMRON_3G3MX2-V1_Mod485_EV100.cxp	Ver.1.00

### Caution

This document aims to explain the wiring methods and communications settings necessary to connect the corresponding devices and provide the setting procedures. The program used in this document is designed to check if the connection was properly established and is not designed to be constantly used at a site. Therefore, functionality and performances are not sufficiently taken into consideration.

When you construct an actual system, please use the wiring methods, communications settings, and setting procedures described in this document as a reference and design a new program according to your application needs.



## 5. Applicable Devices and Device Configuration

### 5.1. Applicable Devices

The applicable devices are as follows:

Manufacturer	Name	Model
OMRON	CJ2 CPU Unit	CJ2□-CPU□□
OMRON	Serial Communications Unit	CJ1W-SCU□1-V1 CJ1W-SCU□2
OMRON	Inverter	3G3MX2-A□□□□-V1



#### Precautions for Correct Use

As applicable devices above, the devices with the models and versions listed in 5.2. *Device Configuration* are actually used in this document to describe the procedure for connecting devices and checking the connection.

You cannot use devices with versions lower than the versions listed in 5.2.

To use the above devices with models not listed in 5.2. or versions higher than those listed in 5.2., check the differences in the specifications by referring to the manuals before operating the devices.



#### Additional Information

This document describes the procedure to establish the network connection. It does not provide information on operation, installation, wiring method, device functionality or device operation which is not related to the connection procedure. Refer to the manuals or contact your OMRON representative.



**5.2. Device Configuration**

The hardware components to reproduce the connection procedures of this document are as follows:

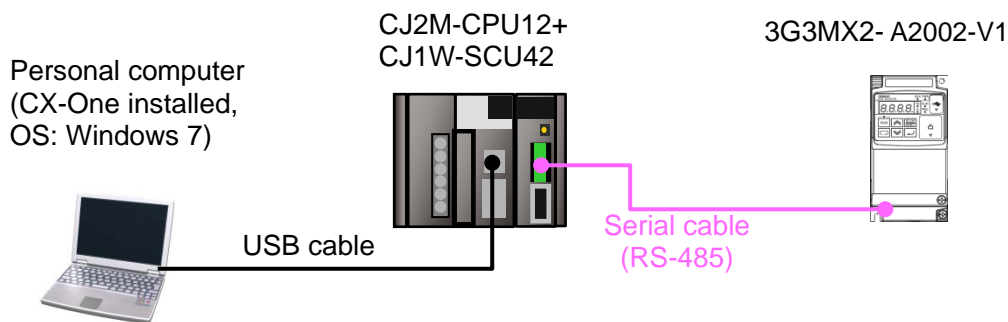

Manufacturer	Name	Model	Version
OMRON	Serial Communications Unit	CJ1W-SCU42	Ver.2.0
OMRON	CPU Unit	CJ2M-CPU12	Ver.2.0
OMRON	Power Supply Unit	CJ1W-PA202	
OMRON	CX-One	CXONE-AL[C]C-V4 /AL[D]D-V4	Ver.4.[ ]
OMRON	CX-Programmer	(Included in CX-One)	Ver.9.54
OMRON	CX-Programmer project file	OMRON_3G3MX2-V1_M od485_EV100.cxp	Ver.1.00
-	Personal computer (OS: Windows 7)	-	
-	USB cable (USB 2.0 type B connector)	-	
-	Serial cable (RS-485)	-	
OMRON	Inverter	3G3MX2-A2002-V1	V2.0

**Precautions for Correct Use**

Prepare a latest project file beforehand.  
To obtain a project file, contact your OMRON representative.

**Precautions for Correct Use**

Update CX-Programmer to the version specified in this clause or higher version.  
If you use a version higher than the one specified in this clause, the procedures and related screenshots described in *Section 7.* and subsequent sections may not be applicable. In that case, use the equivalent procedures described in this document by referring to the *CX-Programmer OPERATION MANUAL* (Cat. No. W446).

**Precautions for Correct Use**

Turn ON the terminating resistance switch on Serial Communications Unit and connect a 100 to 125Ω(1/2W) terminating resistor to the end of Inverter on RS-422A/485 port.



### **Precautions for Correct Use**

---

The maximum length of communications cable for Inverter is 500m.

Make sure to connect Serial Communications Unit and Inverter with a 500m or less serial cable (RS-485).

---



### **Additional Information**

---

For information on the serial cable (RS-485), refer to *3-4 RS-232C and RS-422A/485 Wiring* of the *CJ Series Serial Communications Units OPERATION MANUAL* (Cat. No. W336).

---



### **Additional Information**

---

The system configuration in this document uses USB for the connection between Personal computer and PLC. For information on how to install a USB driver, refer to *A-5 Installing the USB Driver in Appendices of the CJ-series CJ2 CPU Unit Hardware USER'S MANUAL* (Cat. No. W472).

---

## 6. Serial Communications Settings

This section describes the specifications of parameters and wirings that are set in this document.

### 6.1. Parameters

The parameters required for connecting PLC and Inverter using serial communications are shown below.

Item	PLC (Serial Communications Unit)	Inverter
Unit number	0	-
Address number (Slave address)	-	1 (Default) (C072: Communication Station No. Selection =1.)
Communications (Connection) port	Port 1 (RS-422/485)	-
Terminating resistor	Yes (TERM: ON)	No (Terminating register selector switch OFF)
2-wire or 4-wire	2-wire (WIRE: 2)	2-wire (Fixed)
Serial communications mode	Serial Gateway	-
Data length (Transmission character)	8 bits	8 bits (Fixed)
Stop bit	1 bit	1 bit (Default) (C075: Communication Stop Bit Selection = 01)
Parity (Parity bit)	No	No (Default) (C074: Communication Parity Selection = 00)
Transmission rate (Baud rate)	9,600 bps (Default)	9,600 bps (Default) (C071: Communication Speed Selection = 05)
Communication selection	-	Modbus communication (Default) (C096: Communication Selection = 00)



#### Precautions for Correct Use

This document describes the setting procedures of CJ1W-SCU42 Serial Communications Unit with unit number 0 and communications (connection) port 1. To connect devices under different conditions, change the CIO area and the control word of CMND instruction used in the program. Refer to *Section 9. Program* for details.

6.2. Cable Wiring Diagram

Refer to SECTION 3 Installation and Wiring of the CJ Series Serial Communications Units OPERATION MANUAL (Cat. No. W336) for details on cable wirings.

Check connector configurations and signal lines (pin assignments) before wiring.

■Connector configurations and signal lines (pin assignments)

CJ1W-SCU42 Serial Communications Unit applicable connector: Terminal block

Pin No.	Symbol	Signal name	Input/Output
1(See note 1.)	RDA	Receive data -	Input
2(See Note 1.)	RDB	Receive data +	Input
3(See Note 1.)	SDA	Send data -	Output
4(See Note 1.)	SDB	Send data +	Output
5(See Note 2.)	FG	Shield	-



Note 1: For 2-wire connection, use either pins 1 and 2 or pins 3 and 4.

Note 2: Pin 5 (Shield) is connected to the GR terminal on Power Supply Unit though Serial Communications Unit. The cable shield can thus be grounded by grounding the GR terminal of Power Supply Unit.

Inverter (3G3MX2-A[ ]-[ ]-V1) applicable connector: Terminal block

Control Circuit Terminal

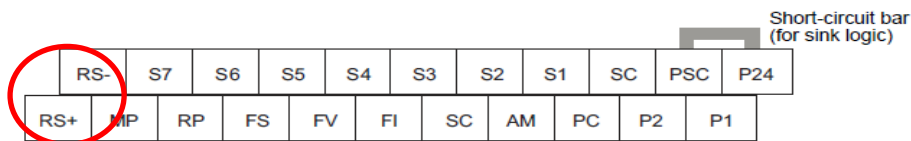
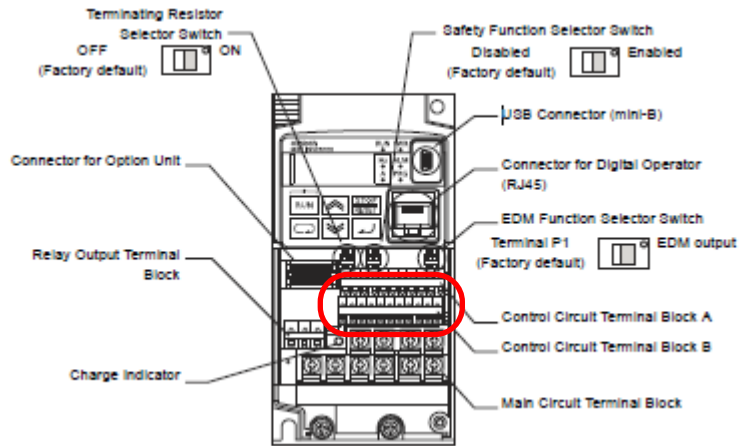

■Cable/Pin assignments

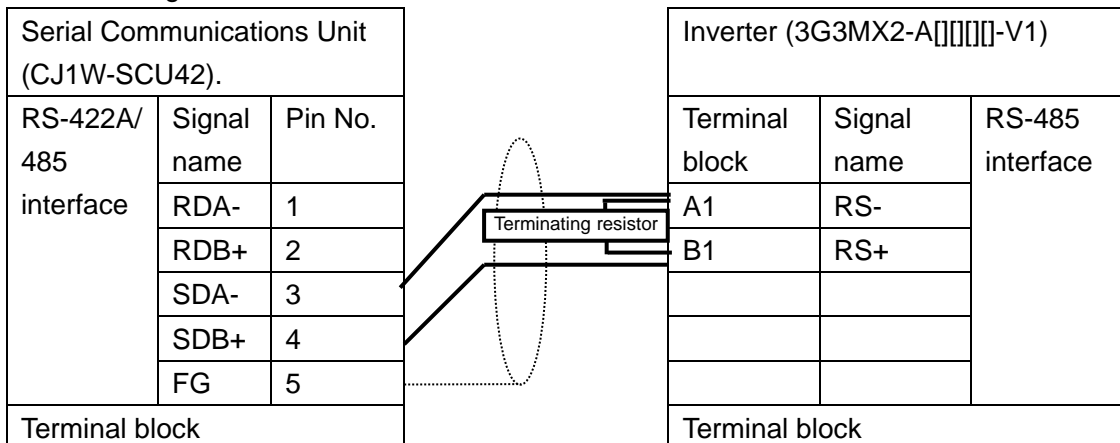

## 7. Serial Communications Connection Procedure

This section describes the procedures for connecting PLC to Inverter using serial communications.

In this document, the explanations of procedures for setting up PLC and Inverter are based on the factory default settings. For the initialization, refer to *Section 8. Initialization Method*.

### 7.1. Work Flow

Take the following steps to connect PLC to Inverter using serial communications, and send and receive messages.

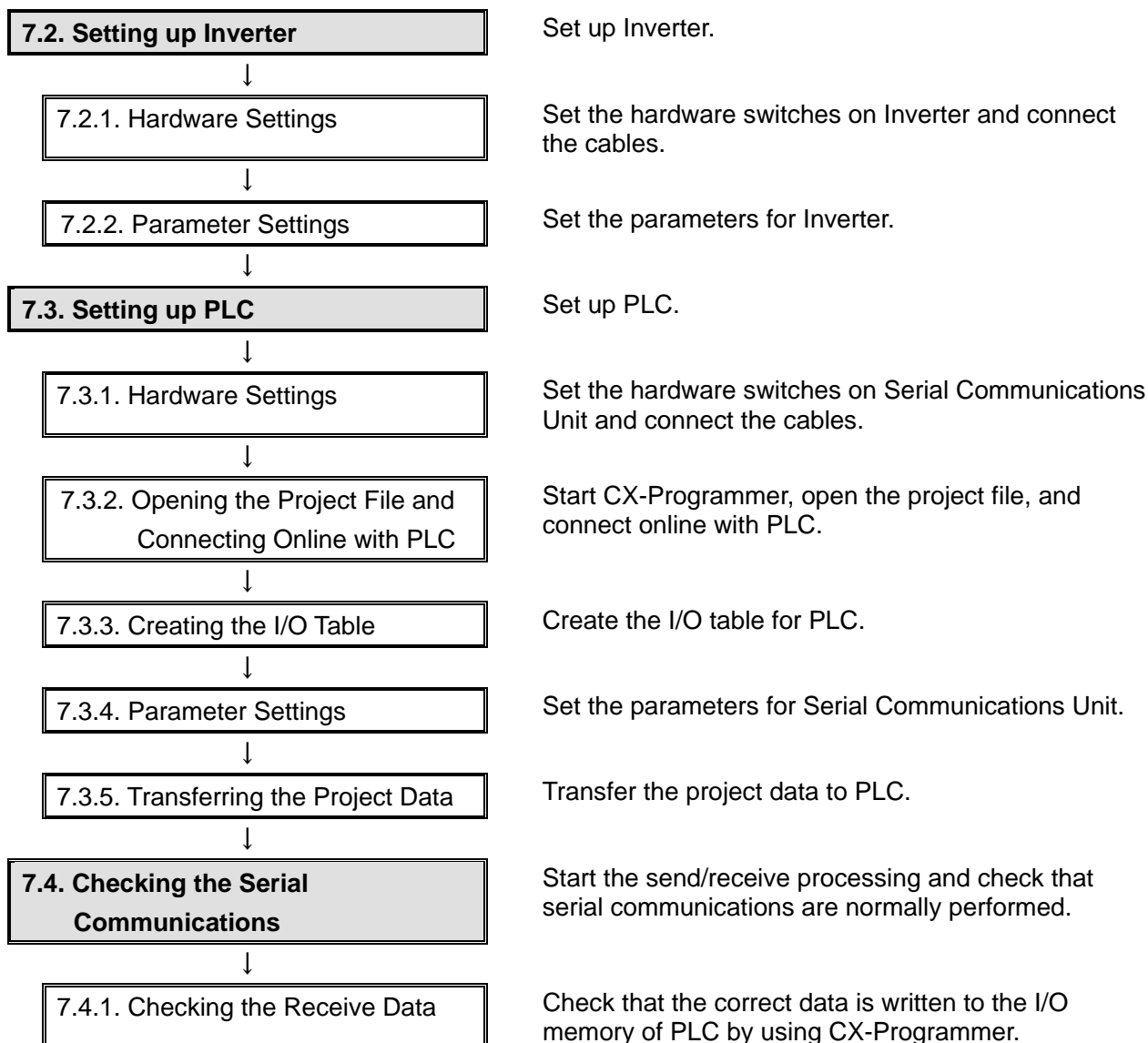

7.2. Setting up Inverter

Set up Inverter.

7.2.1. Hardware Settings

Set the hardware switches on Inverter and connect the cables.



Precautions for Correct Use

Make sure that the power supply is OFF when you perform the setting up.

- 1 Make sure that the power supply to Inverter is OFF.

\*If the power supply is turned ON, settings may not be applicable as described in the following procedure.

- 2 Remove Option Unit Cover from the Inverter front panel as shown in the right figure.

- 1: Loosen the mounting screw (x 1) from Option Unit Cover of the Inverter front panel.
- 2: Remove Option Unit Cover.

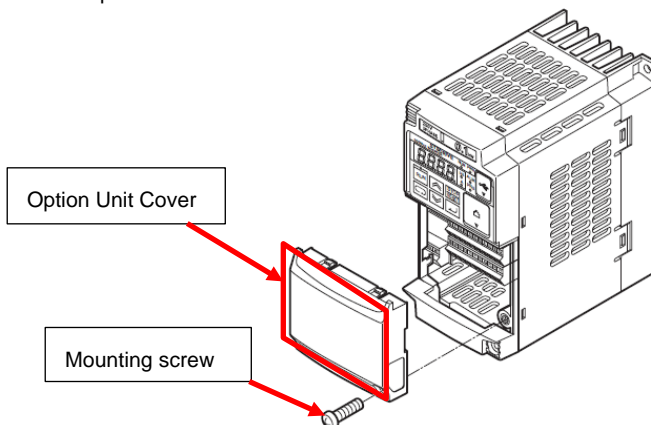

- 3 Check that Terminating Resistor Selector Switch inside of the terminal block cover is OFF.

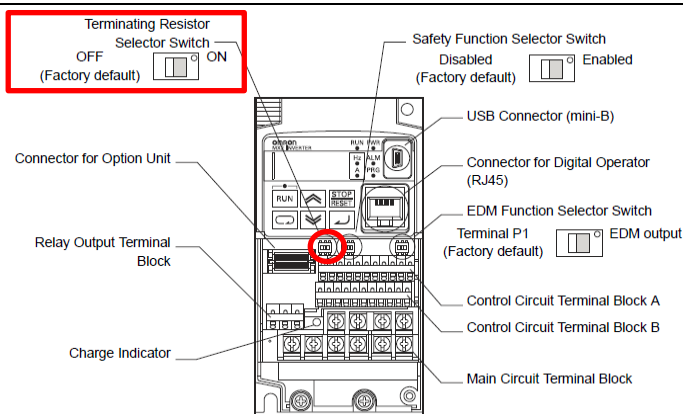

- 4 Connect a Serial cable to RS-485 terminal (RS-, RS+). Connect Terminating resistor (120Ω 1/2W) to RS-485 terminal (RS-, RS+).

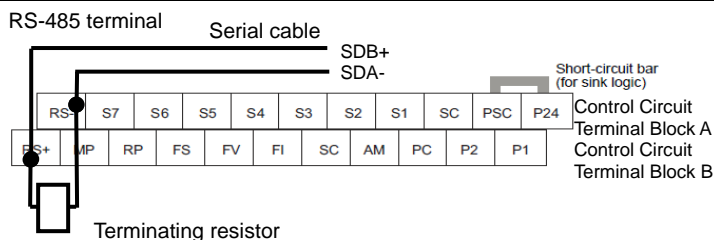

## 7. Serial Communications Connection Procedure

- 5 Connect 3-Phase 200 VAC power supply to Main power supply input terminal on Inverter with a Power supply cable.

\*For details on wiring specifications of the power supply, refer to 2-3 *Wiring of the Inverter Multi-function Compact Inverter MX2 Series Type V1 User's Manual* (Cat. No. I585).

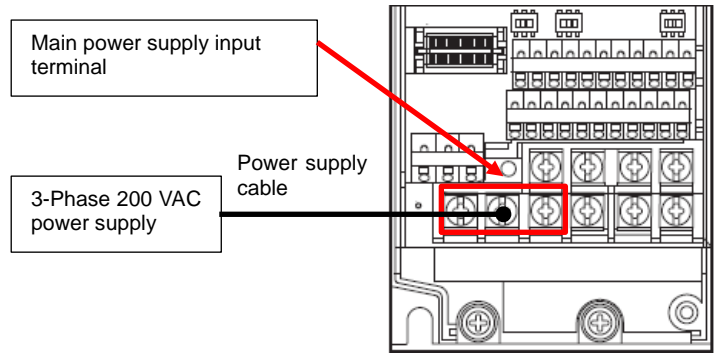

- 6 Mount Option Unit Cover on the Inverter front panel.

7.2.2. Parameter Settings

Set the parameters for Inverter.

- 1 Check the positions of Data display and Operation keys on Digital Operator.

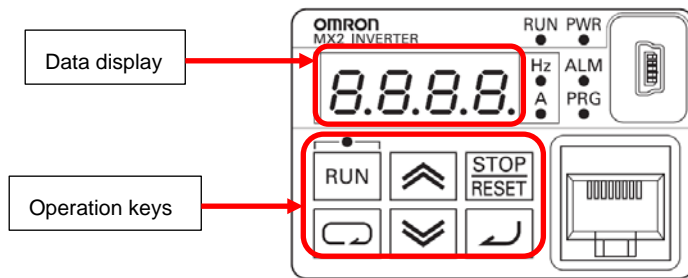

Digital Operator

Display	Name	Description
	POWER LED	Lights (green) when the inverter power is turned on.
	RUN LED	Lights (green) when the inverter is running. (Because this LED is designed to light based on the result of logical OR operation between the conditions "RUN command present" and "Inverter output in progress," it also lights when the RUN command is input with the frequency set to 0 Hz, or during deceleration after the RUN command turns OFF.)
	Monitor LED (Hz)	Lights (green) when a frequency value is displayed on the display.
	Monitor LED (A)	Lights (green) when a current value is displayed on the display.
	Data display	Displays (in red) various data such as a parameter value, frequency value, or set value.
	RUN key	Starts inverter operation. Note that this key is enabled when the RUN command is set to Digital Operator.
	STOP/RESET key	Stops the inverter (deceleration stop). (Although the STOP/RESET key is enabled even when the RUN command is set to other than Digital Operator, you can disable it by setting the parameter b087.) When the inverter is in a trip error state, pressing this key causes a reset (and the inverter recovers from the trip error state).
	Mode key	When parameter is displayed: Moves to the beginning of the next parameter group. When data is displayed: Cancels the setting and returns to the parameter display. In individual input mode: Moves the blinking position one digit to the left, if not located at the leftmost digit. At the leftmost digit, moves the blinking position to the rightmost digit. Regardless of the display, if you press the Mode key for 3 seconds or more, the data of Output Frequency Monitor (d001) is displayed.
	Enter key	In parameter display mode: Switches to the data display. In data display mode: Enters and stores the set value (into the EEPROM) and returns to the parameter display. In individual input mode: Enters the value in the blinking position.
	Increment key	Increases the parameter number or the set data value. Press and hold the key to quickly increase the number or value. Press the increment key and the decrement key simultaneously to enter the individual input mode, where you can edit the value in each digit independently.
	Decrement Key	Decreases the parameter number or the set data value. Press and hold the key to quickly decrease the number or value. Press the increment key and the decrement key simultaneously to enter the individual input mode, where you can edit the value in each digit independently.

- 2 Turn ON the power supply to Inverter.

- 3 Use the procedure on the right to display the parameters in the extended function mode C.



The output frequency is displayed in Data display.



Press the **Mode Key** 5 times.



C001 parameter is displayed.

\*If the output frequency is not displayed in Data display, press and hold the **Mode** Key for 3 seconds or more to display the output frequency.





4 Use the procedure on the right to set the parameters as follows:

C071 (Communication Speed Selection): 05 (9600bps)

03: 2400bps	07: 38.4kbps
04: 4800bps	08: 57.6kbps
05: 9600bps	09: 76.8kbp
06: 19.2kbps	10: 115.2kbps



Press the  **Increment** Key or the  **Decrement** Key to display C071 parameter.





C071 parameter is displayed.

Press the  **Enter** Key.

Check that the displayed value is the default value "05".  
\*If the setting is different, change the set value.



Press the  **Enter** Key.





C071parameter is displayed again.

5 Use the procedure on the right to set the parameters as follows:

C072 (Communication Station No. Selection): 1.  
Slave address: 1.

Setting range 1. to 247.



Press the  **Increment** Key.



C072 parameter is displayed.





















Press the  **Enter** Key.

Check that the displayed value is the default value "1."  
\*If the setting is different, change the set value.



Press the  **Enter** Key.

C072 parameter is displayed again.



<p>6</p>	<p>Use the procedure on the right to set the parameters as follows:</p> <p>C074 (Communication Parity Selection): 00 (No parity)</p> <p>00: No parity 01: Even parity 02: Odd parity</p>	      	<p>Press the  <b>Increment Key</b>.</p> <p>C074 parameter is displayed.</p> <p>Press the  <b>Enter Key</b>.</p> <p>Check that the displayed value is the default value "00". *If the setting is different, change the set value.</p> <p>Press the  <b>Enter Key</b>.</p> <p>C074 parameter is displayed again.</p>
<p>7</p>	<p>Use the procedure on the right to set the parameters as follows:</p> <p>C075 (Communication Stop Bit Selection): 01 (1 bit)</p> <p>01: 1 bit 02: 2 bits</p>	      	<p>Press the  <b>Increment Key</b>.</p> <p>C075 parameter is displayed.</p> <p>Press the  <b>Enter Key</b>.</p> <p>Check that the displayed value is the default value "01". *If the setting is different, change the set value.</p> <p>Press the  <b>Enter Key</b>.</p> <p>C075 parameter is displayed again.</p>

8 Use the procedure on the right to set the parameters as follows:

0075



C096 (Communication Selection): 00 (Modbus communication)

Press the  **Increment** Key or the  **Decrement** Key to display C096 parameter.

- 00: Modbus communication
- 01: Co-inverter communication
- 02: Co-inverter communication (management inverter)

0096

C096 parameter is displayed.



Press the  **Enter** Key.

00

Check that the displayed value is the default value "00".  
\*If the setting is different, change the set value.



Press the  **Enter** Key.

0096

C096 parameter is displayed again.

9 Turn OFF the power supply to Inverter.

\*After connecting to PLC in the procedure described on the following page, turn ON the power supply again.

7.3. Setting up PLC

Set up PLC.

7.3.1. Hardware Settings

Set the hardware switches on Serial Communications Unit and connect the cables.



Precautions for Correct Use

Make sure that the power supply is OFF when you perform the setting up.

- 1 Make sure that the power supply to PLC is OFF.

\*If the power supply is turned ON, settings may not be applicable as described in the following procedure.

- 2 Check the positions of hardware switches on the front panel of Serial Communications Unit by referring to the right figure.

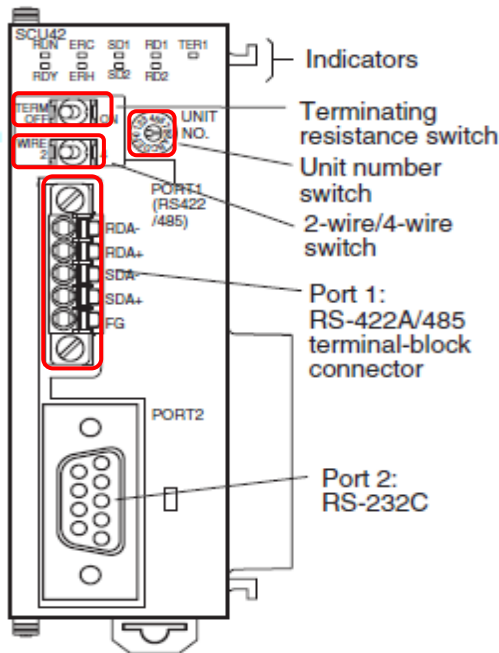

- 3 Set Unit number switch to 0.

\*The unit number is set to 0 as the factory default setting.

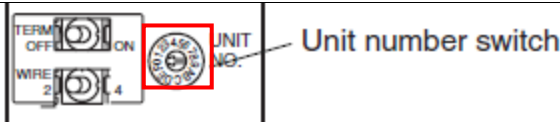

- 4 Set Terminating resistance ON/OFF switch to ON (Terminating resistance ON).

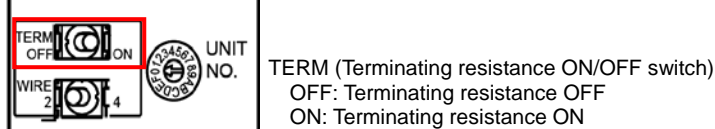

- 5 Set 2-wire or 4-wire switch to 2 (2-wire).

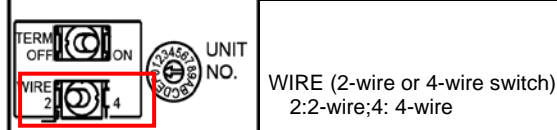

6 Connect Serial Communications Unit to PLC as shown on the right.

Connect Inverter to Port 1 on Serial Communications Unit with a Serial cable (RS-485).

\*For connections, refer to 6.2 *Cable Wiring Diagram*.

Connect Personal computer to PLC with a USB cable.

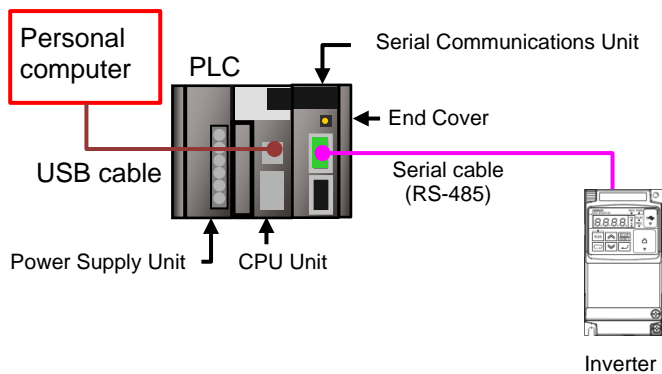

7.3.2. Opening the Project File and Connecting Online with PLC

Start CX-Programmer, open the project file, and connect online with PLC.  
 Install CX-Programmer and a USB driver on Personal computer beforehand.

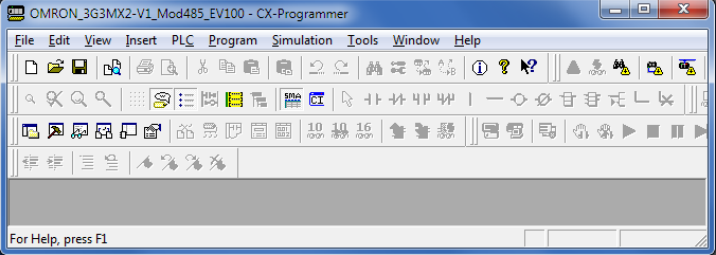
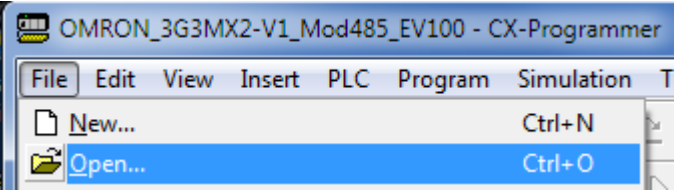
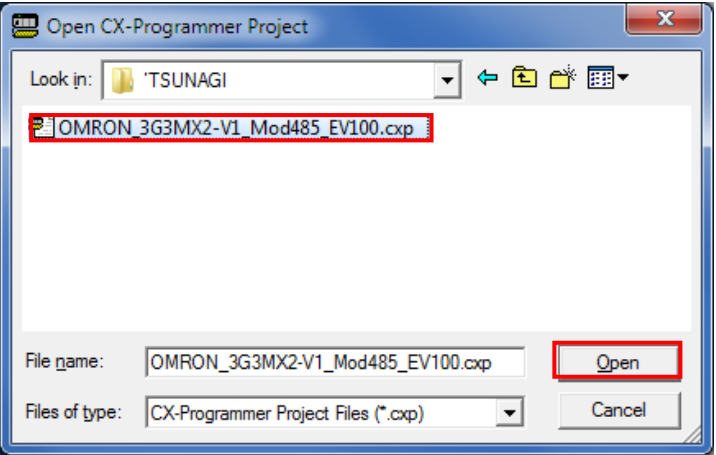
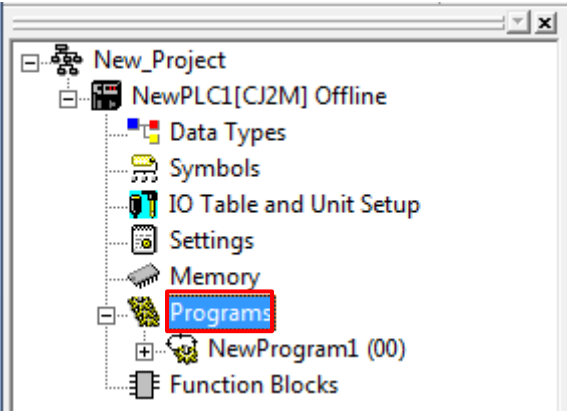
1	Turn ON the power supplies to PLC and Inverter.	
2	Start CX-Programmer.  *If a confirmation dialog for an access right is displayed at start, execute a selection to start.	
3	CX-Programmer starts.	
4	Select <b>Open</b> from the File Menu.	
5	The Open CX-Programmer Project Dialog Box is displayed. Select <i>OMRON_3G3MX2-V1_Mod485_EV100.cxp</i> and click <b>Open</b> .  *Obtain the project file from OMRON.	
6	After opening the project file, select <b>Programs</b> in the project workspace.	

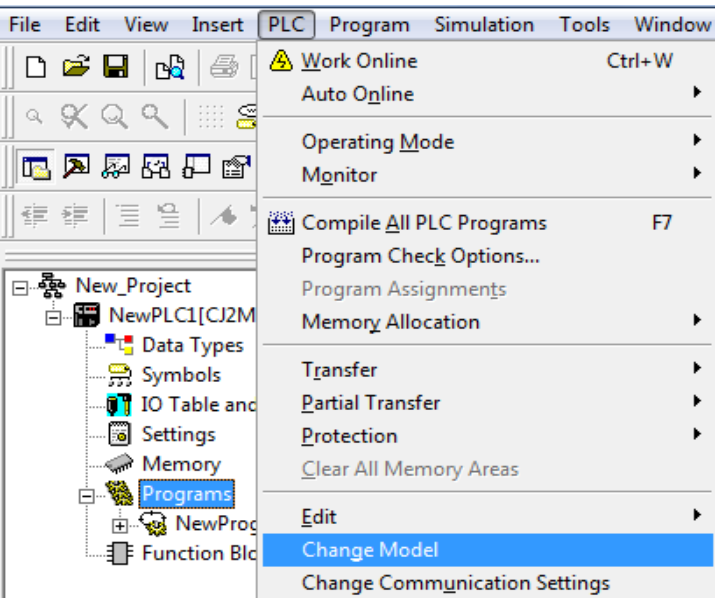
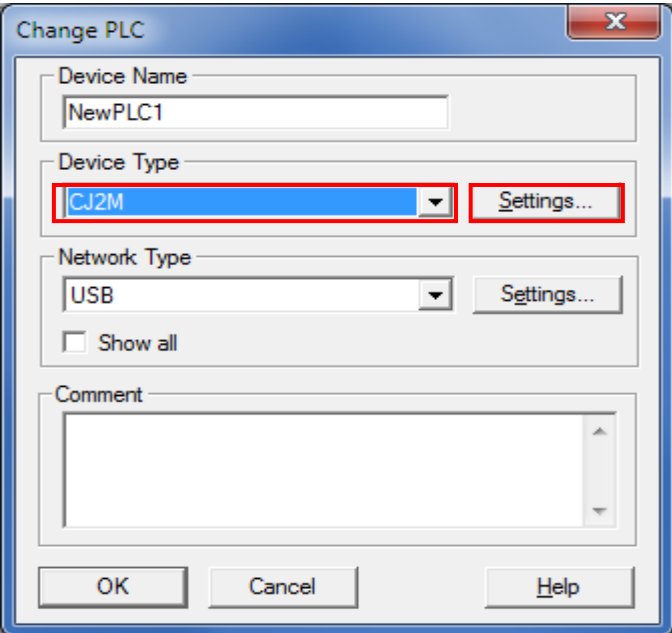
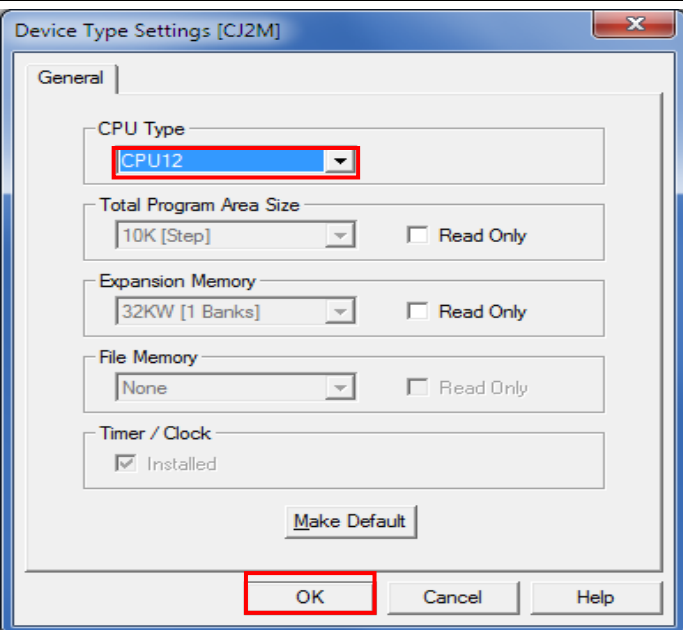
- 7 Select **Change Model** from the PLC Menu.
- 
- 8 The Change PLC Dialog Box is displayed.  
From the pull-down list of Device Type, select the device type of PLC that you use.  
Click **Settings**.
- \*CJ2M is selected in this document.
- 
- 9 The Device Type Settings Dialog Box is displayed.  
From the pull-down list of CPU Type, select the CPU type that you use.  
Click **OK**.
- \*CPU12 is selected in this document.
- 

10 Check that USB is set for Network Type on the Change PLC Dialog Box.  
Click **OK**.

\*If USB is not set for Network Type, select **USB** from the pull-down list.

\*If you changed Device Type in step 8 or CPU Type in step 9, the dialog box on the right is displayed. Check that there is no problem and click **Yes**. Make sure that the program was normally converted. ("0 errors" must be shown.) (Although duplicated output warnings were detected in the right dialog box, they are not problems.)

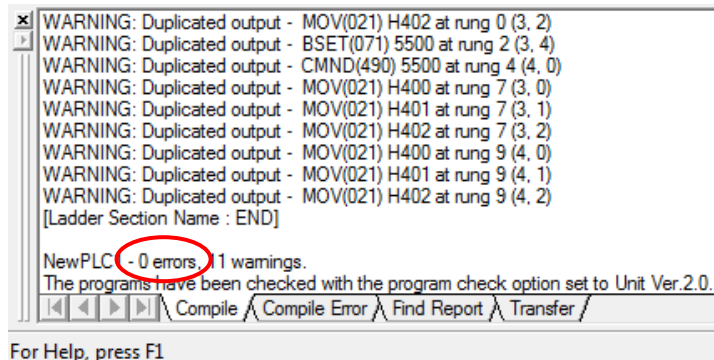
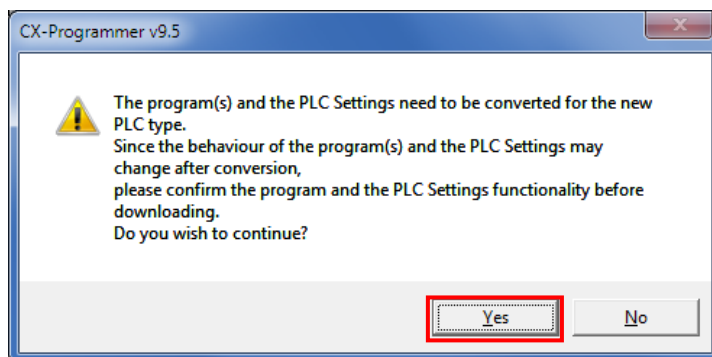
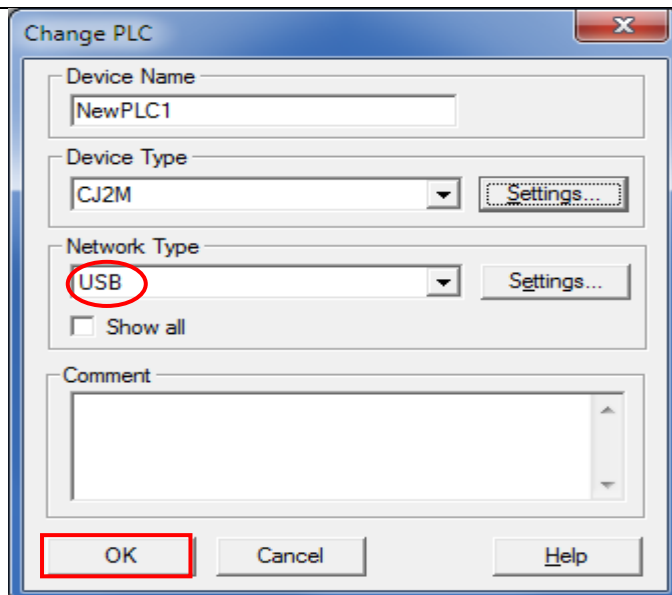

11 Select **Programs** in the project workspace.  
  
Select **Work Online** from the PLC Menu.

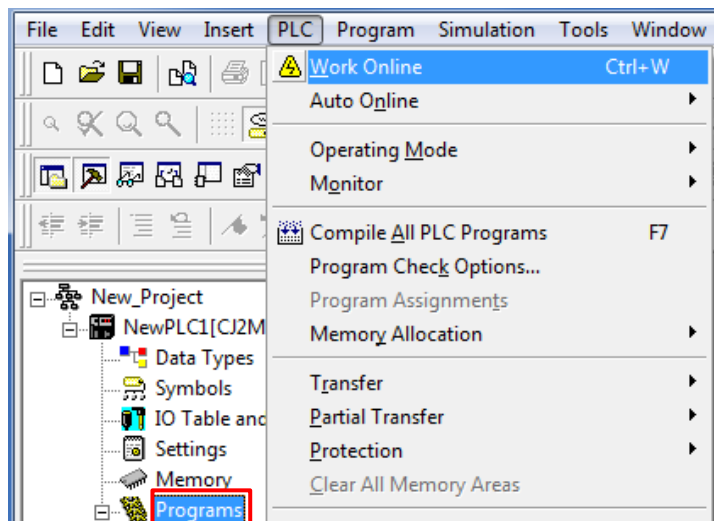



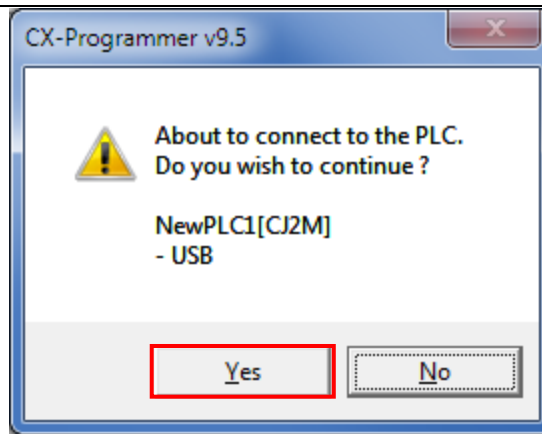

- 12 A confirmation dialog box on the right is displayed.  
Check that there is no problem and click **Yes**.

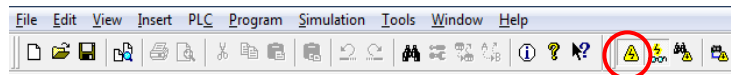

- 13 Check that CX-Programmer and PLC are normally connected online.



\*The  icon is pressed down during online connection.



### Additional Information

If PLC cannot be connected online, check the cable connection

After you check the cable connection, return to step 6, check the settings such as the connection type in steps 7 to 9 and try again. For details, refer to *Connecting Directly to a CJ2 CPU Unit Using a USB Cable* of the *CX-Programmer OPERATION MANUAL* (Cat. No. W446).



### Additional Information

The dialog boxes explained in this document may not be displayed depending on the environmental settings of CX-Programmer. For details on the environmental settings, refer to *Options and Preferences* in *CHAPTER 3 Project Reference* in *PART 1: CX-Programmer* of the *CX-Programmer OPERATION MANUAL* (Cat. No. W446).

This document explains the setting procedures when "Confirm all operations affecting the PLC" is selected.

7.3.3. Creating the I/O Table

Create the I/O table for PLC.

1 If the operating mode of PLC is Run Mode or Monitor Mode, change it to Program Mode by following the steps below.

(1) Select **Operating Mode - Program** from the PLC Menu of CX-Programmer.

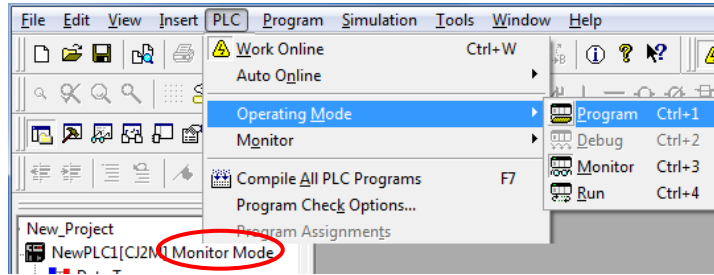

(2) A confirmation dialog box on the right is displayed. Check that there is no problem and click **Yes**.

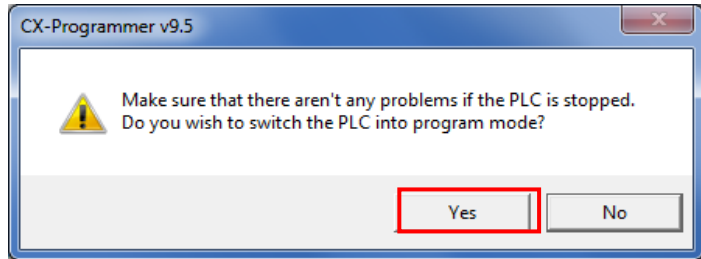

\*Refer to *Additional Information* on the previous page for the settings concerning the dialog display.

(3) Check that Stop/Program Mode is displayed on the right of the PLC model in the project workspace tree.

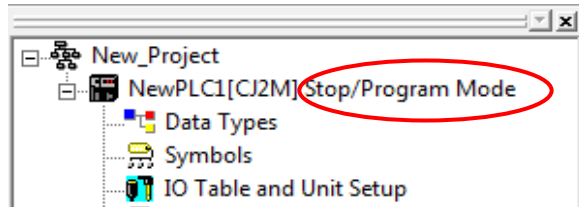

2 Select **Edit - I/O Table and Unit Setup** from the PLC Menu of CX-Programmer.

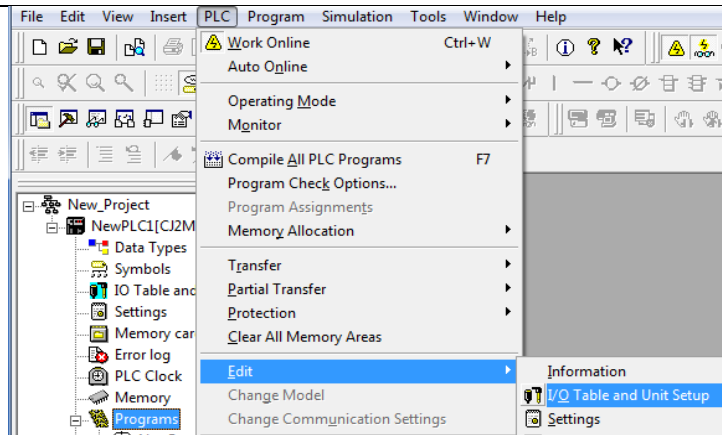

The PLC IO Table Window is displayed.

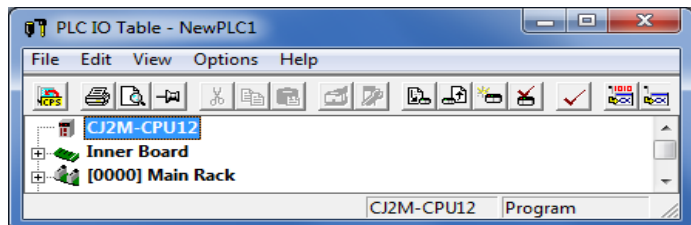

 **Precautions for Correct Use**

The PLC will be reset after creating and transferring the I/O table in step 3 and subsequent steps. Always confirm safety before creating and transferring the I/O table.

3 Select **Create** from the Options Menu in the PLC IO Table Window.

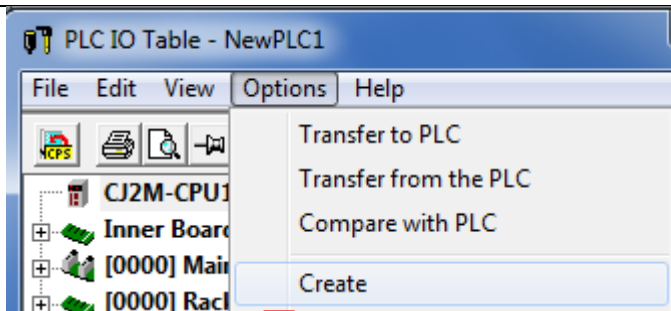

A confirmation dialog box on the right is displayed. Check that there is no problem and click **Yes**.

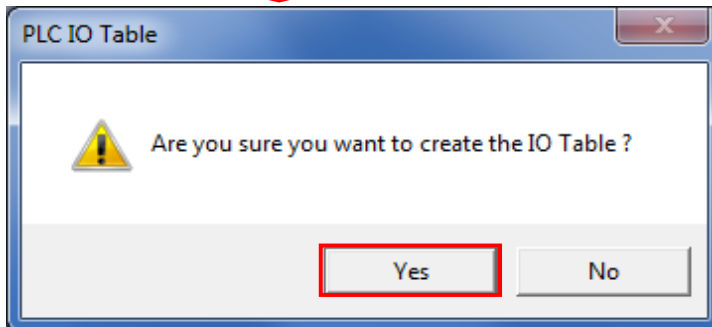

A confirmation dialog box on the right is displayed. Check that there is no problem and click **Yes**.

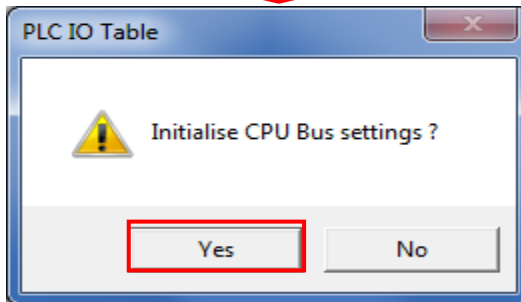

4 The Transfer from PLC Dialog Box is displayed. Select *IO Table* and *SIO Unit Parameters* and click **Transfer**.

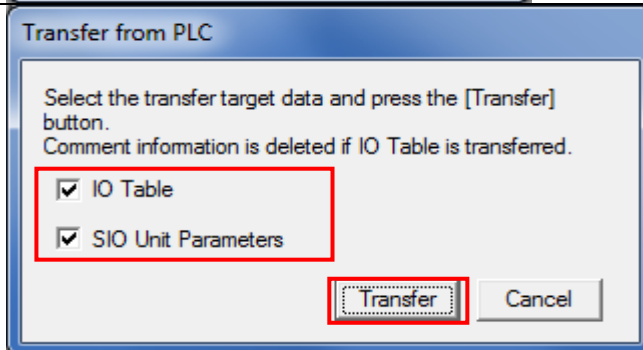

When the transfer is completed, the Transfer Results Dialog Box is displayed.

Check that the transfer was normally executed by referring to the message in the dialog box.

When the I/O table is created normally, the dialog box displays as follows:

Transfer Success: 1 Unit

Transfer Unsuccessful: 0 Unit

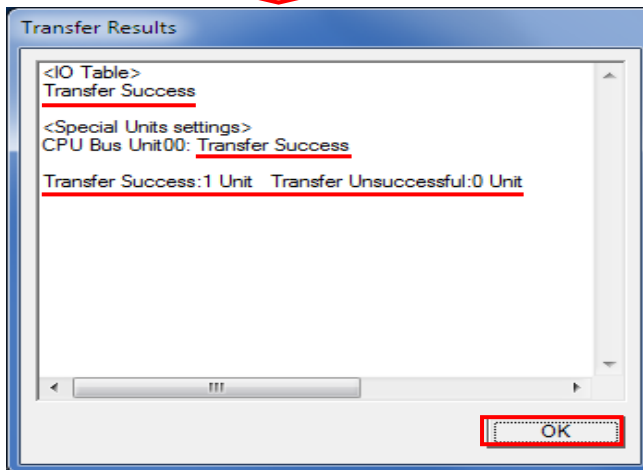

Click **OK**.

## 7.3.4. Parameter Settings

Set the parameters for Serial Communications Unit.

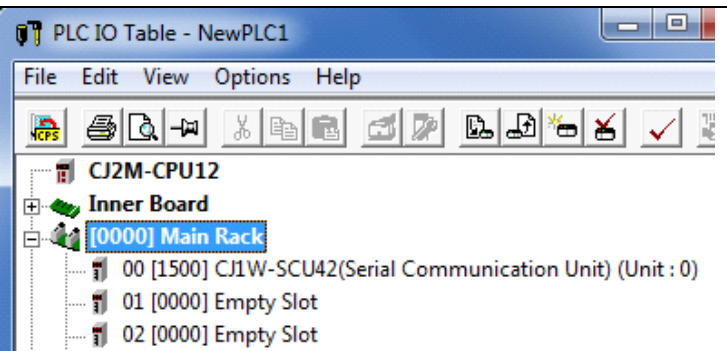
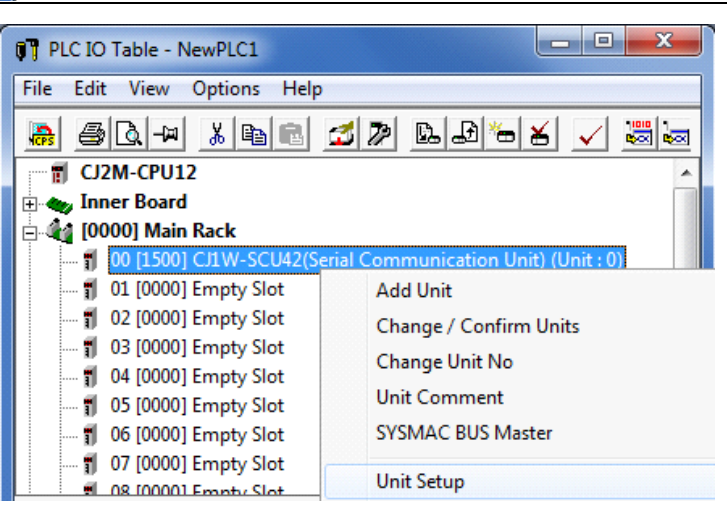
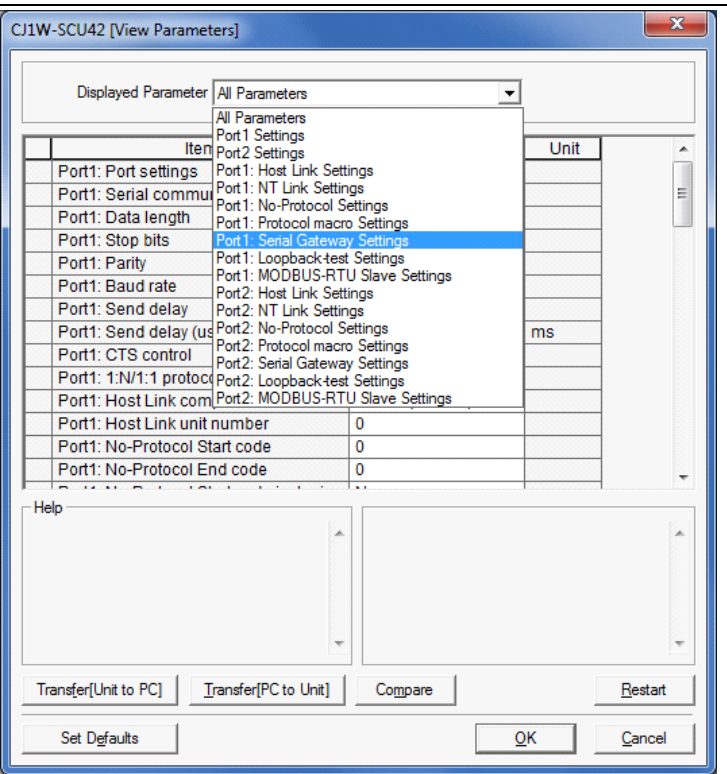
<p>1 Double-click <b>[0000] Main Rack</b> in the PLC IO Table Window to expand the tree.</p>	 <p>The screenshot shows the 'PLC IO Table - NewPLC1' window. The tree structure is expanded to show the '[0000] Main Rack' under the 'Inner Board' of the 'CJ2M-CPU12'. Below it, three slots are listed: '00 [1500] CJ1W-SCU42(Serial Communication Unit) (Unit : 0)', '01 [0000] Empty Slot', and '02 [0000] Empty Slot'.</p>
<p>2 Right-click <b>00 [1500] CJ1W-SCU42</b> and select <b>Unit Setup</b>.</p>	 <p>The screenshot shows the same window as above, but with a context menu open over the '00 [1500] CJ1W-SCU42(Serial Communication Unit) (Unit : 0)'. The menu options are: 'Add Unit', 'Change / Confirm Units', 'Change Unit No', 'Unit Comment', 'SYSMAC BUS Master', and 'Unit Setup' (which is highlighted).</p>
<p>3 The View Parameters Dialog Box is displayed. Select <b>Port1: Serial Gateway Settings</b> from the pull-down list of Displayed Parameter.</p>	 <p>The screenshot shows the 'C1W-SCU42 [View Parameters]' dialog box. The 'Displayed Parameter' dropdown menu is open, showing a list of parameters. 'Port1: Serial Gateway Settings' is selected and highlighted in blue. Other visible parameters include 'Port1: Port settings', 'Port1: Serial commu...', 'Port1: Data length', 'Port1: Stop bits', 'Port1: Parity', 'Port1: Baud rate', 'Port1: Send delay', 'Port1: Send delay (us)', 'Port1: CTS control', 'Port1: 1:N/1:1 protocol', 'Port1: Host Link com...', 'Port1: Host Link unit number', 'Port1: No-Protocol Start code', and 'Port1: No-Protocol End code'. The 'Unit' column shows 'ms' for the delay parameters. At the bottom, there are buttons for 'Transfer[Unit to PC]', 'Transfer[PC to Unit]', 'Compare', 'Restart', 'Set Defaults', 'OK', and 'Cancel'.</p>

4 The setting items of Port1: Serial Gateway Settings are listed as shown in the right figure. (The figure shows the default values.)

Item	Set Value	Unit
Port1: Port settings	Defaults	
Port1: Serial communications mode	Host Link(default)	
Port1: Data length	7 bits	
Port1: Stop bits	2 bits	
Port1: Parity	Even	
Port1: Baud rate	Default(9600bps)	
Port1: Send delay	Default (0 ms)	
Port1: Send delay (user-specified)	0	ms
Port1: CTS control	No	
Port1: Serial Gateway Response timeo	0	ms
Port1: Serial Gateway send start timeo	0	ms

5 Select **User settings** from the pull-down list of Set Value for Port1: Port Settings.

Item	Set Value	Unit
Port1: Port settings	Defaults	
Port1: Serial communications mode	Defaults	
Port1: Data length	User settings	
Port1: Stop bits	2 bits	
Port1: Parity	Even	
Port1: Baud rate	Default(9600bps)	
Port1: Send delay	Default (0 ms)	
Port1: Send delay (user-specified)	0	ms
Port1: CTS control	No	
Port1: Serial Gateway Response timeo	0	ms
Port1: Serial Gateway send start timeo	0	ms

6 Set the following parameters in the same way as step 5.

- Serial communications mode : *Serial Gateway*
- Data length: *8 bits*
- Stop bits: *1 bit*
- Parity: *None*
- Baud rate: *Default(9600bps)*

\*Use the default settings for other parameters.

Click **Transfer[PC to Unit]**.

Item	Set Value	Unit
Port1: Port settings	User settings	
Port1: Serial communications mode	Serial Gateway	
Port1: Data length	8 bits	
Port1: Stop bits	1 bit	
Port1: Parity	None	
Port1: Baud rate	Default(9600bps)	
Port1: Send delay	Default (0 ms)	
Port1: Send delay (user-specified)	0	ms
Port1: CTS control	No	
Port1: Serial Gateway Response timeo	0	ms
Port1: Serial Gateway send start timeo	0	ms

Help: <Default>Even  
<Address>Word:D30000, Bit:0-1  
<Type>List

Transfer[Unit to PC] **Transfer[PC to Unit]** Compare Restart

Set Defaults OK Cancel

7 A confirmation dialog box on the right is displayed. Check that there is no problem and click **Yes**.

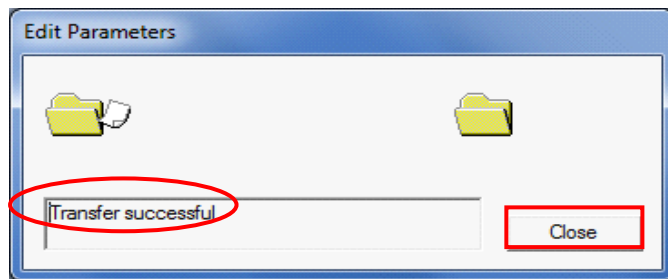
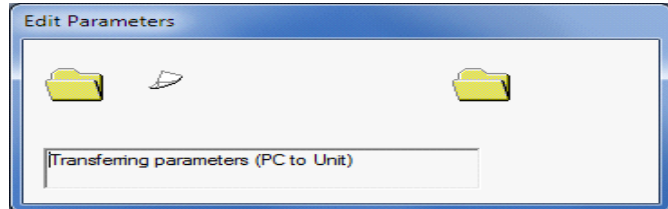
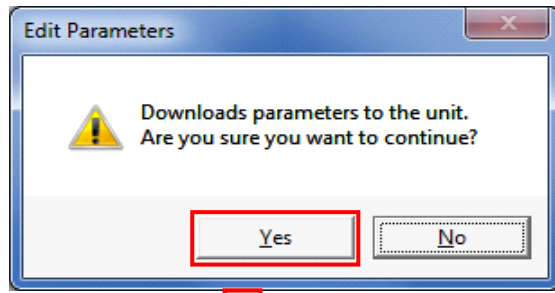

Check that the transfer is completed as shown in the right dialog box. Click **Close**.

8 A confirmation dialog box on the right is displayed. Check the contents and click **Yes**.

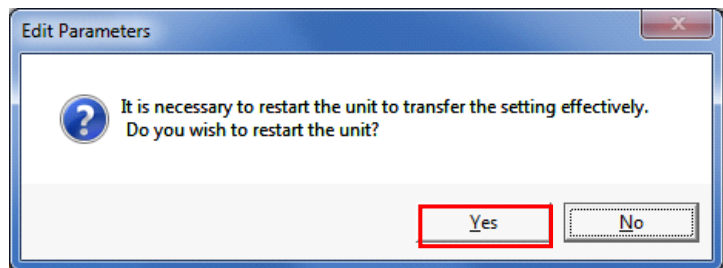

The Select Port Dialog Box is displayed.  
Select *All ports* and click **OK**.

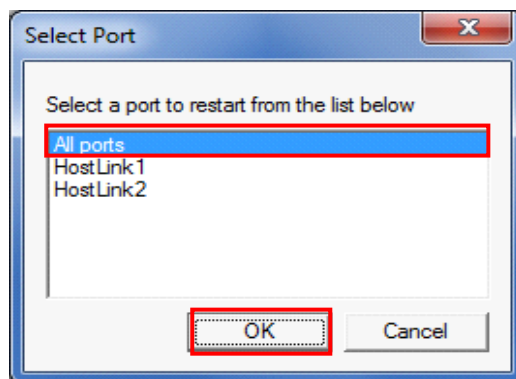

9 The dialog box on the right is displayed. Check the contents and click **OK**.

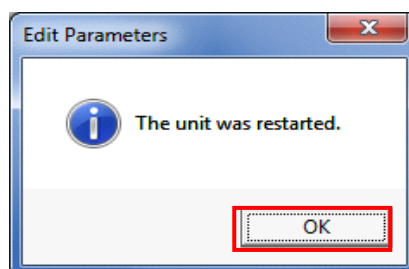

10 Click **Compare** on the View Parameters Dialog Box.

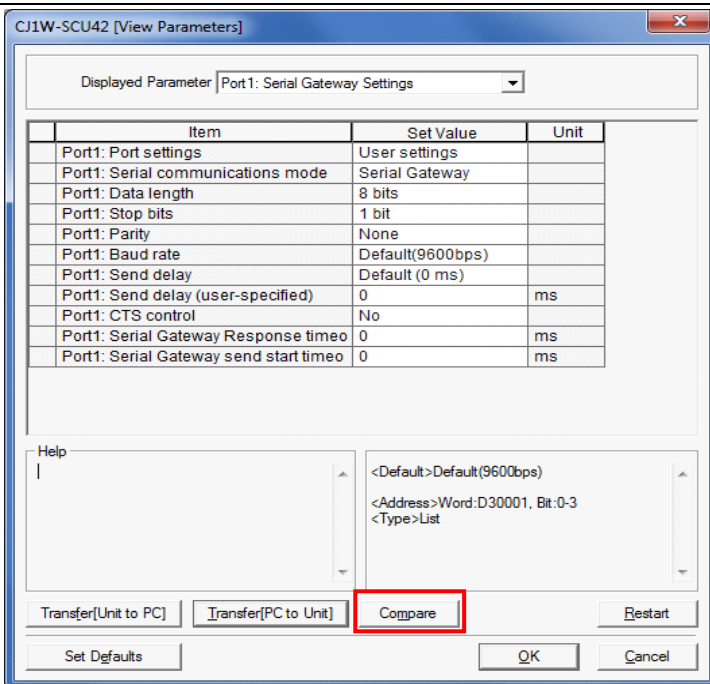

11 Check that a message "Compare successful" is displayed in the dialog box on the right. Click **Close**.

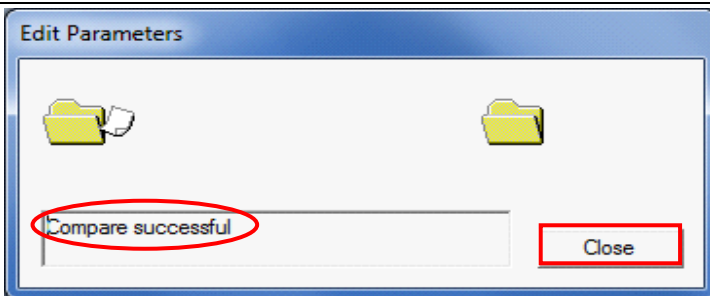

12 Click **OK** on the View Parameters Dialog Box.

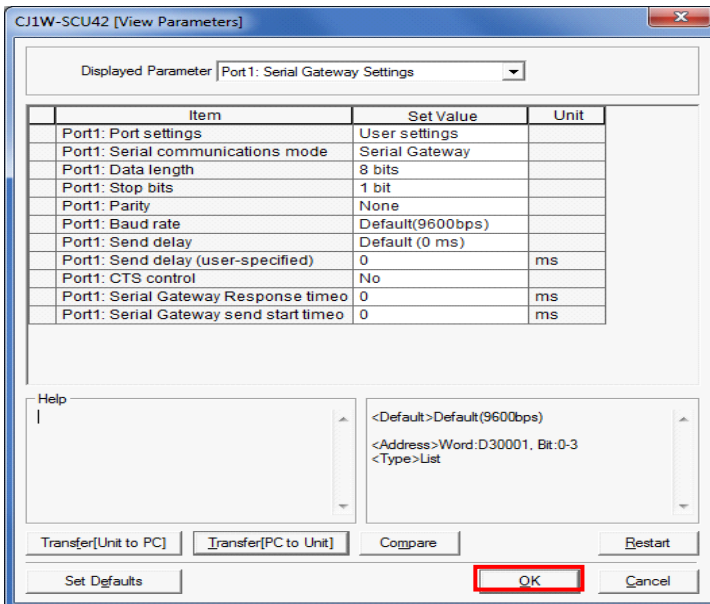

13 Select **Exit** from the File Menu of the PLC IO Table Window to close.

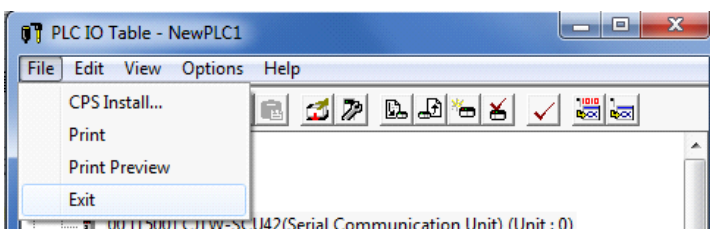

7.3.5. Transferring the Project Data

Transfer the project data to PLC.

1 Select **Programs** in the project workspace of CX-programmer.

Select **Transfer - To PLC** from the PLC Menu.

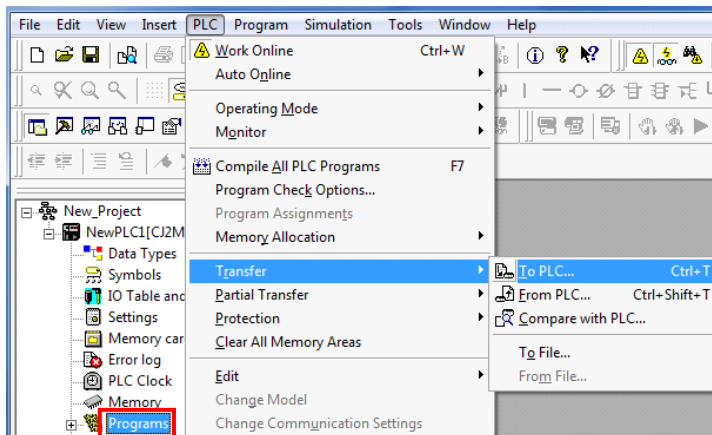

2 Select *Program(s)*, *Comments*, and *Program index*. Click **OK**.

\*The I/O table and Special Unit Setup are unnecessary to transfer here, because they are already set in 7.3.3. *Creating the I/O Table* and 7.3.4. *Parameter Settings*.

\*The *Comments* and the *Program index* Check Boxes may not be displayed depending on the device type. In such a case, select *Program(s)* only and transfer the project data.

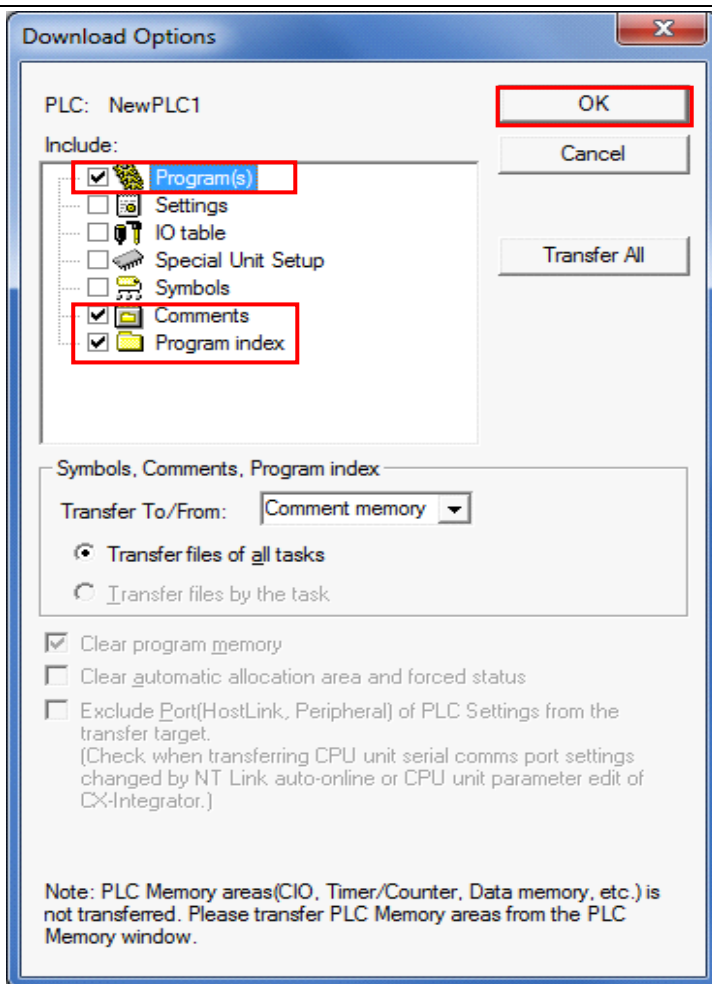

3 A confirmation dialog box on the right is displayed. Check that there is no problem and click **Yes**.

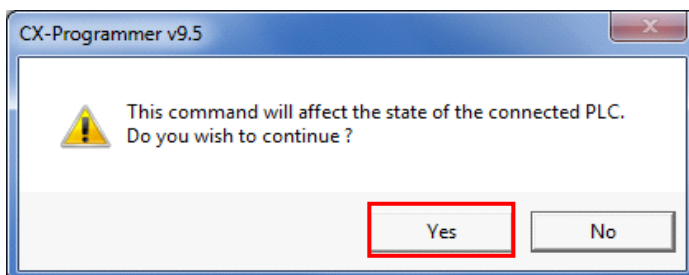

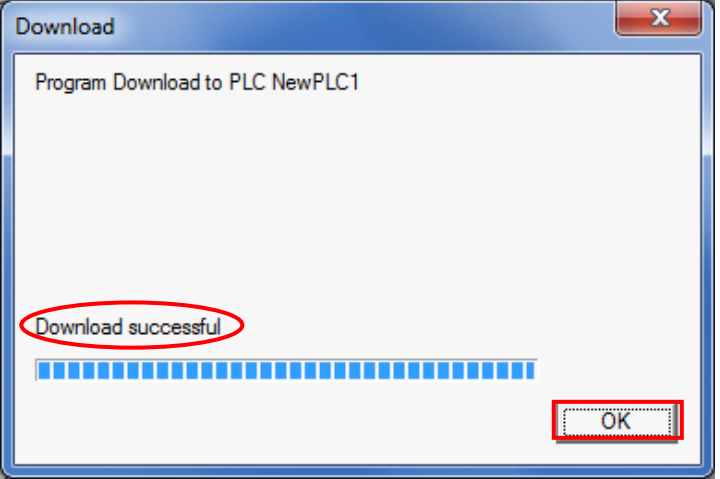
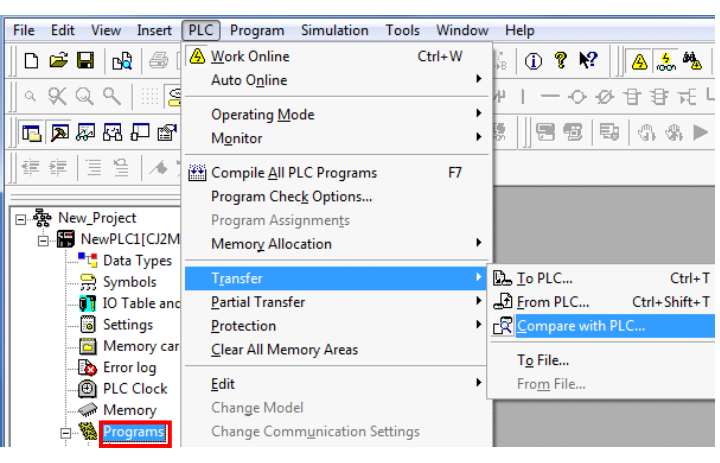
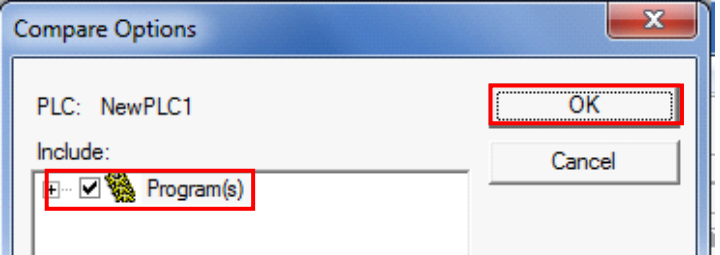
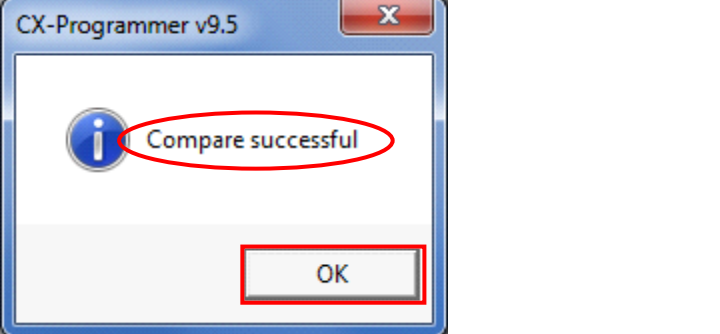

## 7. Serial Communications Connection Procedure

<p>4 The dialog box on the right is displayed (stating "Download successful") when the transfer is completed. Click <b>OK</b>.</p>	
<p>5 Select <b>Programs</b> in the project workspace. Select <b>Transfer - Compare with PLC</b> from the PLC Menu.</p>	
<p>6 Select <i>Program(s)</i> and click <b>OK</b>.</p>	
<p>7 Check that a message stating "Compare successful" is displayed. Click <b>OK</b>.</p>	

**7.4. Checking the Serial Communications**

Start the send/receive processing and check that serial communications are normally performed.

**Caution**

If the PLC memory is changed by malfunction during monitoring power flow and present value status in the Ladder Section Window or monitoring present values in the Watch Window, the devices connected to output units may malfunction, regardless of the operating mode of CPU Unit.

Confirm safety sufficiently before monitoring power flow and present value status in the Ladder Section Window or in the Watch Window.

**Precautions for Correct Use**

Check that a serial cable is connected before performing the following procedure.  
 If it is not connected, turn OFF the power supply to each device, and then connect a serial cable.

**7.4.1. Checking the Receive Data**

Check that the correct data is written to the I/O memory of PLC by using CX-Programmer.

1

Expand the Programs tree in the project workspace of CX-Programmer and double-click **Section1**. The Ladder Section Window shows the Section1 ladder.

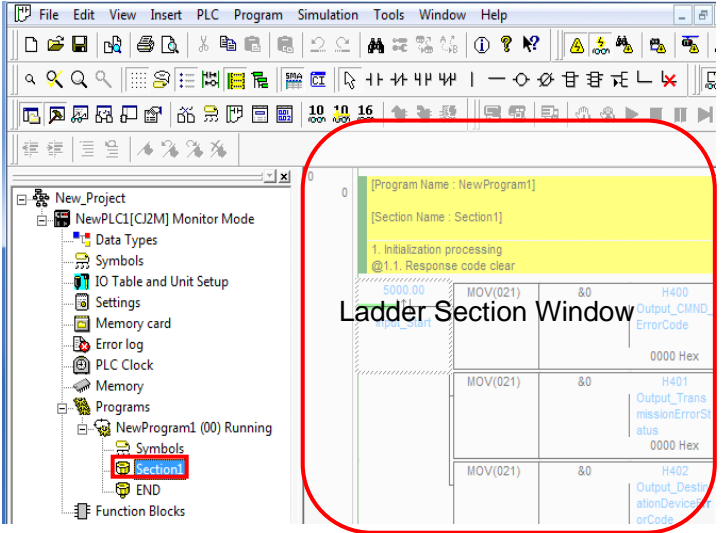

2

Select **Operating Mode - Monitor** from the PLC Menu.

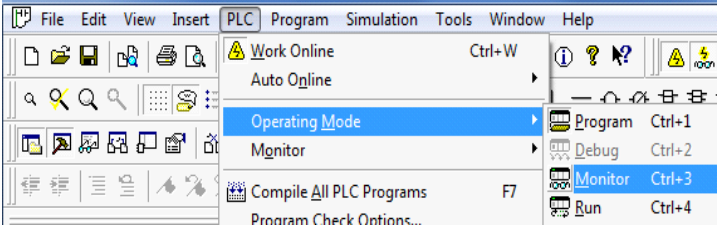

## 7. Serial Communications Connection Procedure

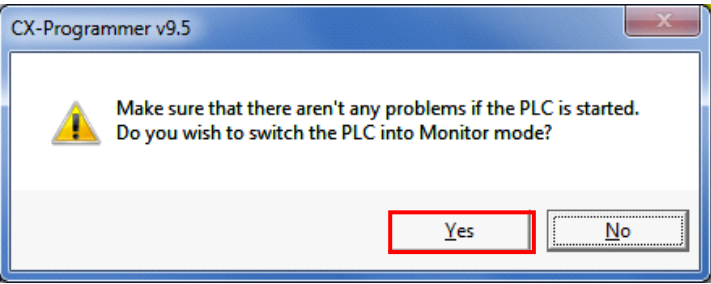
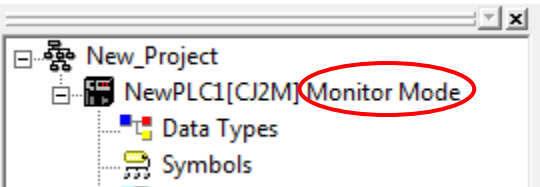
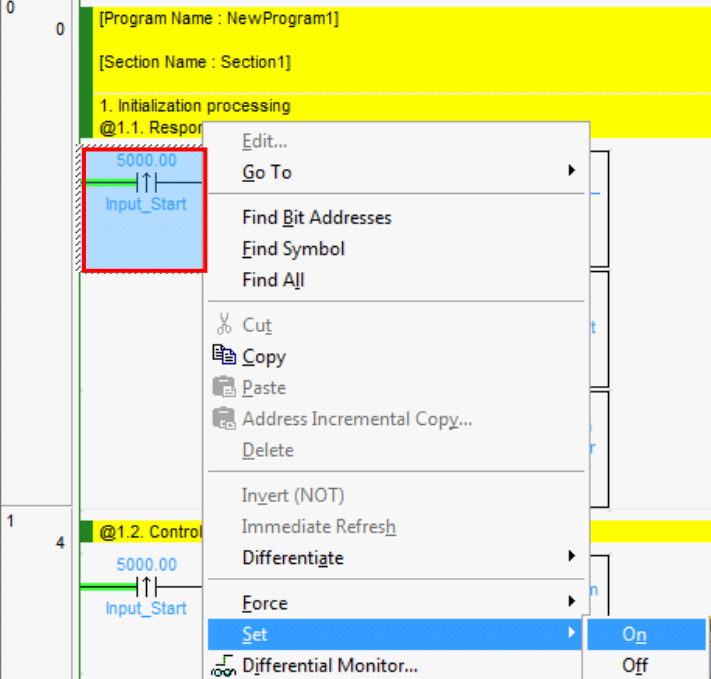
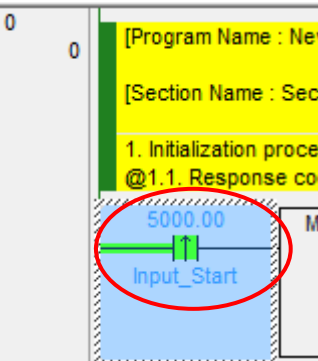
<p>3 A confirmation dialog box on the right is displayed. Check that there is no problem and click <b>Yes</b>.</p>	
<p>4 Check that the operating mode changes to Monitor Mode.</p>	
<p>5 In the Ladder Section Window, right-click <b>Input_Start</b> and select <b>Set - On</b>.</p>	
<p>6 Check that the Input_Start contact is turned ON as shown in the right figure.</p> <p>*When the Input_Start contact is turned ON, the send/receive processing starts.</p>	

## 7. Serial Communications Connection Procedure

- 7 Select **Edit - Memory** from the PLC Menu.

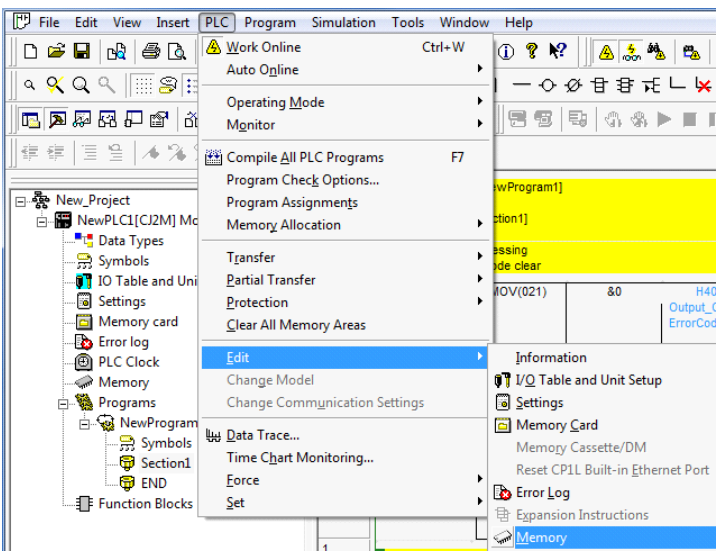
- 8 Double-click **CIO** from the list in the PLC Memory Window that is displayed.

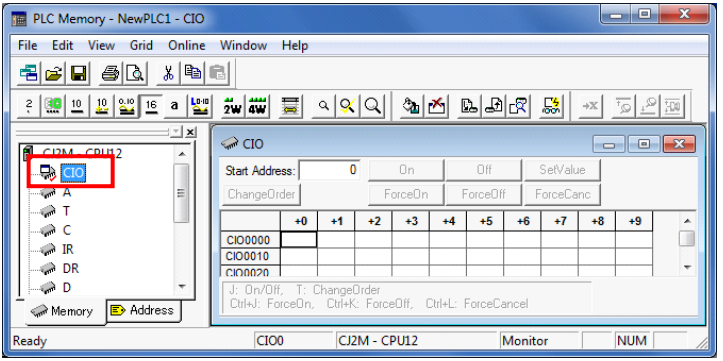
- 9 Enter **5500** in the **Start Address** Field in the displayed CIO Window.  
  
Check that the start address changes to CIO5500.

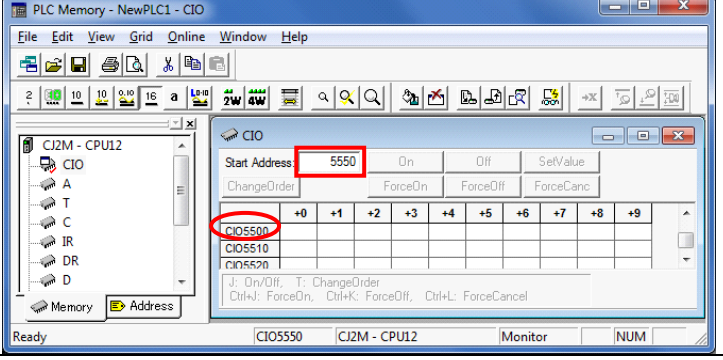
- 10 Select **Monitor** from the Online Menu.

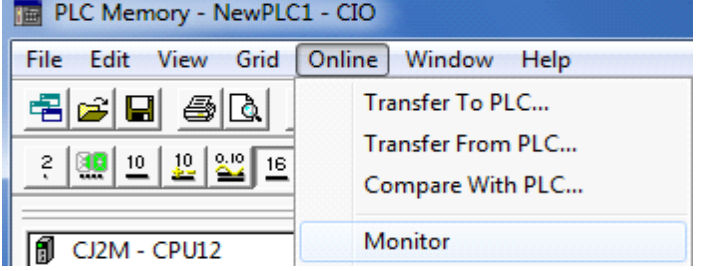
- 11 The Monitor Memory Areas Dialog Box is displayed. Select **CIO** and click **Monitor**.

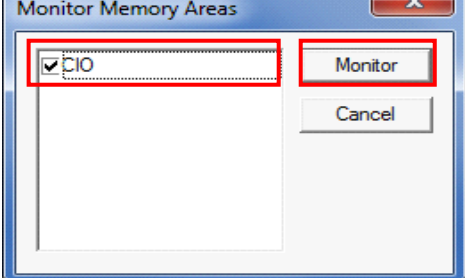

- 12 Check the received data in the CIO Window shown on the right. In the example on the right, the stored data starting from CIO5500 are in hexadecimal and are described as follows:
- 2804: Command code
  - 0000: End code
  - 01: Address number of Inverter
  - 03: Function code
  - 04: Number of bytes to read
  - 00, 00, 00, 62: Read data

	+0	+1	+2	+3	+4	+5	+6	+7	+8	+9
CIO5500	2804	0000	01	03	04	00	0000	0000	0000	0000
CIO5510	0000	0000	0000	0000	0000	0000	0000	0000	0000	0000
CIO5520	0000	0000	0000	0000	0000	0000	0000	0000	0000	0000
CIO5530	0000	0000	0000	0000	0000	0000	0000	0000	0000	0000
CIO5540	0000	0000	0000	0000	0000	0000	0000	0000	0000	0000
CIO5550	0000	0000	0000	0000	0000	0000	0000	0000	0000	0000
CIO5560	0000	0000	0000	0000	0000	0000	0000	0000	0000	0000
CIO5570	0000	0000	0000	0000	0000	0000	0000	0000	0000	0000
CIO5580	0000	0000	0000	0000	0000	0000	0000	0000	0000	0000
CIO5590	0000	0000	0000	0000	0000	0000	0000	0000	0000	0000
CIO5600	0000	0000	0000	0000	0000	0000	0000	0000	0000	0000
CIO5610	0000	0000	0000	0000	0000	0000	0000	0000	0000	0000
CIO5620	0000	0000	0000	0000	0000	0000	0000	0000	0000	0000
CIO5630	0000	0000	0000	0000	0000	0000	0000	0000	0000	0000

\*For details, refer to 9.2.2 Detailed Description of the Function.

- 13 On Digital Operator, check the values of Total Power ON Time Monitor that are already read out. Press the **Mode** Key to display the parameter of Monitor Mode "d".

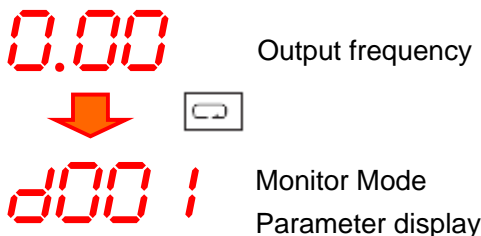

\*If the output frequency is not displayed in Data display, press and hold the **Mode** Key for 3 seconds or more to display the output frequency.

- 14 Press the **Increment** Key or the **Decrement** Key to display d017.

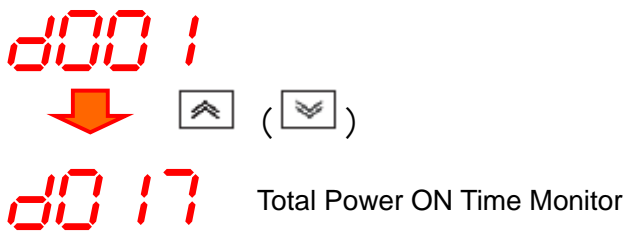

- 15 Press the **Enter** Key to display the total power ON time.

\*For information on the display of the total power ON time, refer to 7-1-16 Total Power ON Time Monitor [d017] of the Multi-function Compact Inverter MX2 Series Type V1 User's Manual (Cat. No. I585). In the example on the right, the total power ON time shows 98, and it accords with the read data (00000062 in hexadecimal) described in step 12.



## 8. Initialization Method

This document provides explanations of setting procedures based on the factory default settings.

Some settings may not be applicable as described in this document unless you use the devices with the factory default settings.

### 8.1. Initializing PLC

To initialize the settings of PLC, it is necessary to initialize Serial Communications Unit and CPU Unit. Change the operating mode of PLC to Program Mode before the initialization.

#### 8.1.1. Serial Communications Unit

To initialize the settings of Serial Communications Unit, select **Edit - I/O Table and Unit Setup** from the PLC Menu of CX-Programmer and perform the following steps.

- (1) On the PLC IO Table Dialog Box, right-click Serial Communications Unit and select **Unit Setup** from the menu that is displayed.

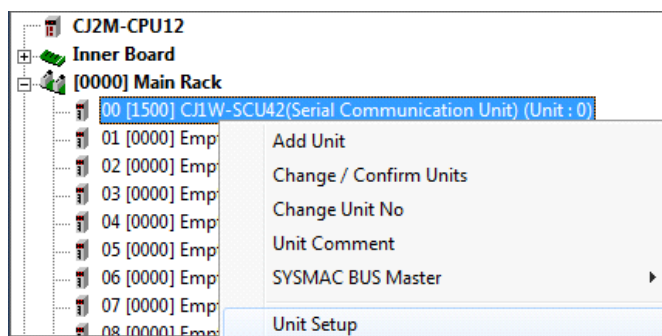

- (2) On the CJ1W-SCU42 [View Parameters] Dialog Box, click **Set Defaults** first, then click **Transfer[PC to Unit]**.

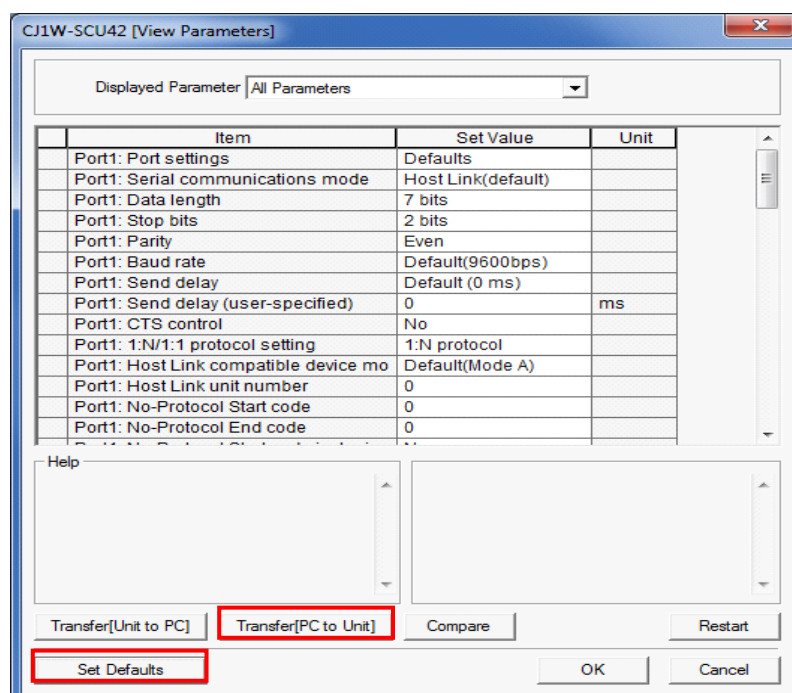

### 8.1.2. CPU Unit

To initialize the settings of CPU Unit, select **Clear All Memory Areas** from the PLC Menu of CX-Programmer. Select **Initialize** on the Confirm All Memory Area Clear Dialog Box and click **OK**.

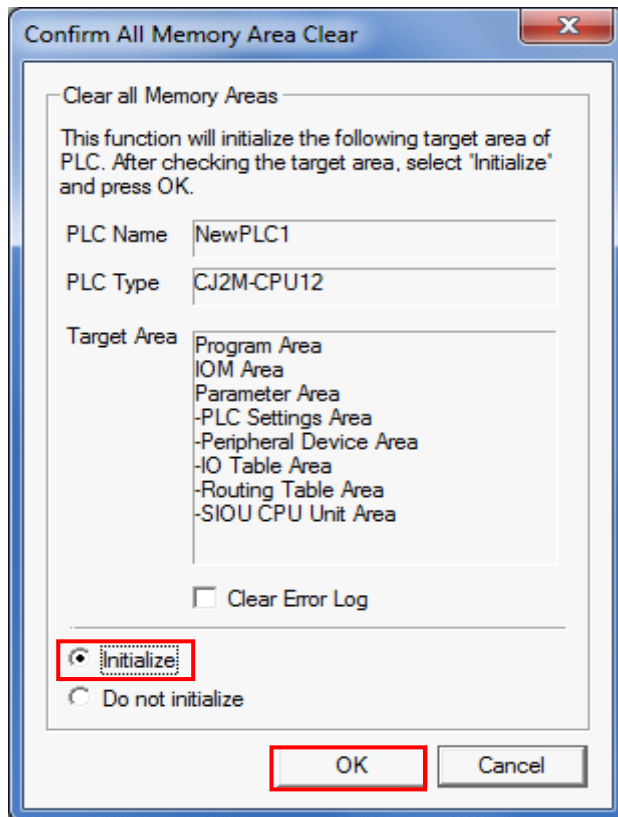

## 8.2. Initializing Inverter

For information on how to initialize Inverter, refer to 5-1-2 *Parameter Initialization* of the *Multi-function Compact Inverter MX2 Series Type V1 User's Manual* (Cat. No. I585).

## 9. Program

This section describes the details on the program used in this document.

### 9.1. Overview

---

The following explains specifications and functions of the program that are used to check the connection between OMRON Inverter (hereinafter referred to as Destination Device) and PLC (Serial Communications Unit (hereinafter referred to as SCU)).

This program performs the Modbus-RTU communication by CMND instruction (by using the Serial Gateway function for SCU) to send and receive the command for Total Power ON Time Monitor and detects a normal end or an error end.

A normal end of the send/receive processing means a normal end of the CMND instruction. An error end means an error end of the CMND instruction and an error of Destination Device (detected with the response data from Destination Device).

Here, the "&" prefix is added to decimal data and the "#" prefix is added to hexadecimal data when it is necessary to distinguish between decimal and hexadecimal data. (e.g., "&1000" for decimal data and "#03E8" for hexadecimal data)



#### Additional Information

---

OMRON have confirmed that normal communications can be performed using this program under 5.2. *Device Configuration*, however, we do not guarantee the normal operations under the disturbance such as electrical noise or the performance variation of the device.

---



### 9.1.1. Outline of Processing

The following figure shows the data flow from when PLC (SCU) issues command data to Destination Device by using serial communications (Modbus-RTU communication) until when it receives the response data from Destination Device.

- (1) The ladder program executes the deliver command instruction (CMND instruction) for which Modbus-RTU communication is specified.
- (2) The command data of Total Power ON Time Monitor is sent to Inverter by Modbus-RTU communication.
- (3) The Inverter executes the command by receiving the command data from PLC and returns the response data to PLC.
- (4) The PLC receives the response data from Inverter and stores in the specified address.

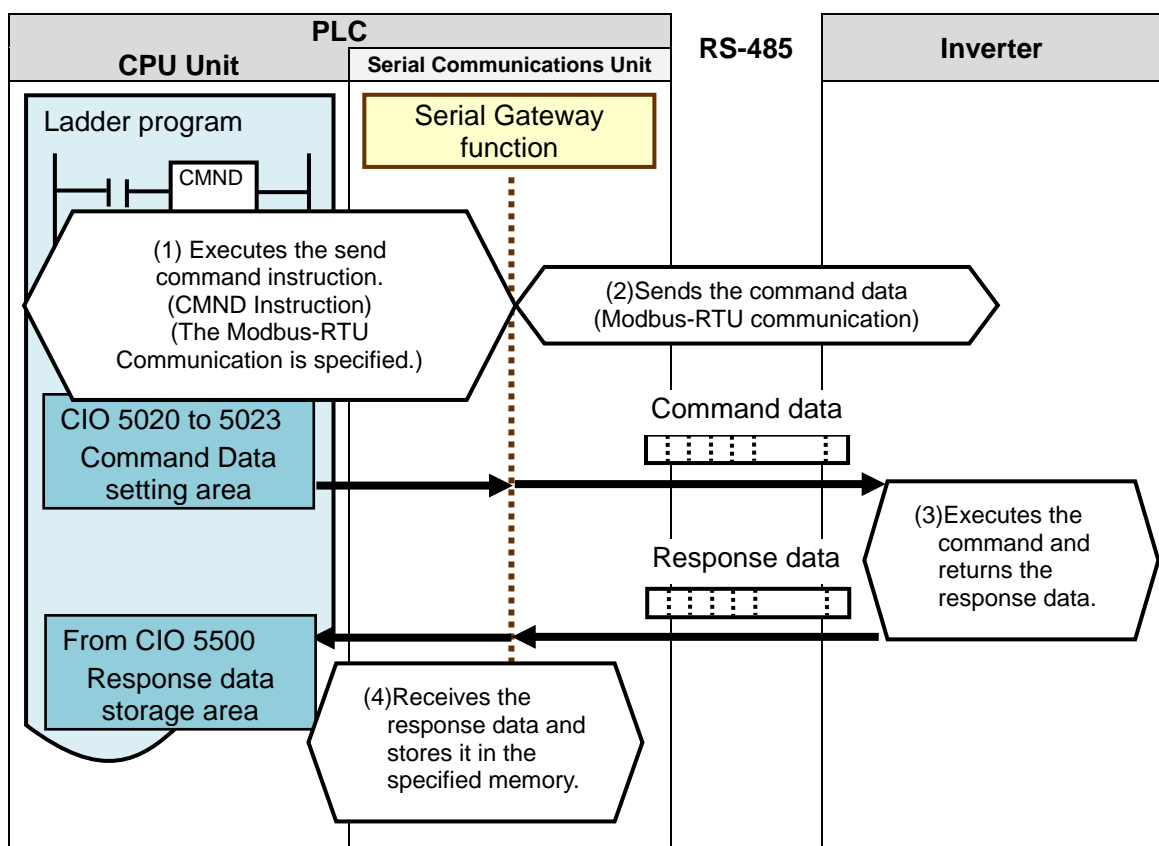

### 9.1.2. CMND Instructions and Send/Receive Messages

The following describes the network communications instruction (instruction word: CMND, hereinafter referred to as CMND instruction) and outlines the basic operations of the send/receive messages.



#### Additional Information

For details on the CMND instruction, refer to *Network Instructions* in *SECTION 3 Instructions* of the *CJ Series Programmable Controllers INSTRUCTIONS REFERENCE MANUAL* (Cat. No. W474).

#### ●CMND instruction operand data

Instruction	Mnemonic	Variations	Function code	Function
DELIVER COMMAND	CMND	@CMND	490	Sends an FINS command and receives the response.

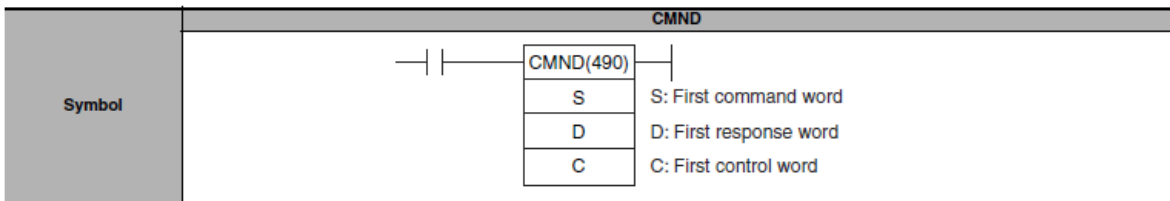

#### S: First command word

- The first address is specified to set the send command.
- Data is sent from the first command word in the following format.

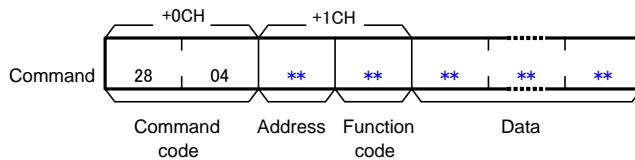

\*Command code #2804 is known as the FINS command for Modbus-RTU communication.

#### D: First response word

- The first address is specified to store the response.
- Data is received in the first response word in the following format.

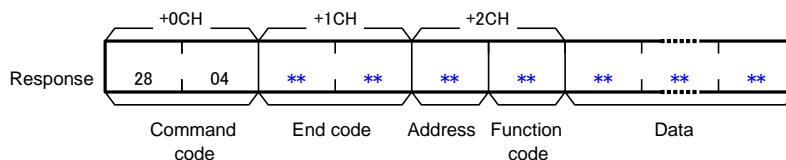

#### Additional Information

For an address and a function code in the first command word, a defined device number by Destination Device and a command code for a function in executable status are set. For details, refer to the manuals for Destination Device.

C: First control word

- The first address is specified to set the first control word.
- Data is set in the following format.

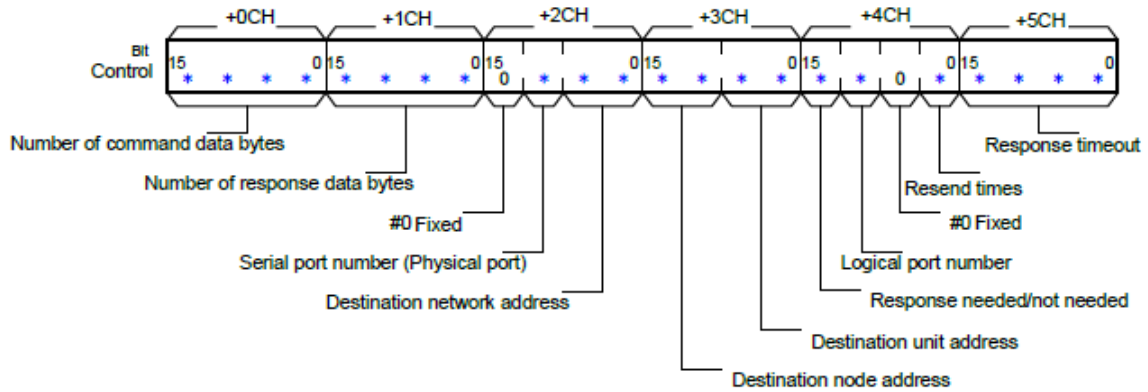

Item	Description
Number of command data bytes	The number of command data bytes is set. (#0002 to maximum data length)
Number of response data bytes	The number of response data bytes is set. (#0000 to maximum data length)
Serial port number (Physical port)	One from the range of #0 to #4 is set. (#0: Not used, #1: Port 1, #2: Port 2, #3: Reserved, #4: Reserved) *If you set the destination unit address to (2) Serial port's unit address as described below, set #0: Not used.
Destination network address	One from the range of #00 to 7F is set. (#00: Own network)
Destination node address	One from the range of #00 to the maximum node address is set. (#00: Transmit within the local node)
Destination unit address	The following (1) or (2) is set. (1)Unit address CPU Unit : #00 CPU Bus Units : #10 + unit number (e.g., for unit number (&5), Unit address = #10 + #05 = #15) Special I/O Unit : #20 + unit number (e.g., for unit number (&10), Unit address = #20 + #0A = #2A) (2)Unit address of serial port For SCU Port 1: #80 + #04 x unit number Port 2: #81 + #04 x unit number (e.g., for Port 2 of unit number (&10), Serial port's unit address = #81 + #04 x #0A(&10) = #81 + #28 = #A9)
Response needed/not needed	#0 or #8 is set. (#0: Response needed, #8: Response not needed)
Logical port number	One from the range of #0 to #7 is set.
Resend times	One from the range of #0 to F (0 to 15 times) is set.
Response timeout	One from the range of &1 to 65535 (#0001 to FFFF) (indicating 0.1 to 6553.5 seconds) is set. (#0000: 2s (default value))

●Send/Receive messages

Overview of send/receive messages

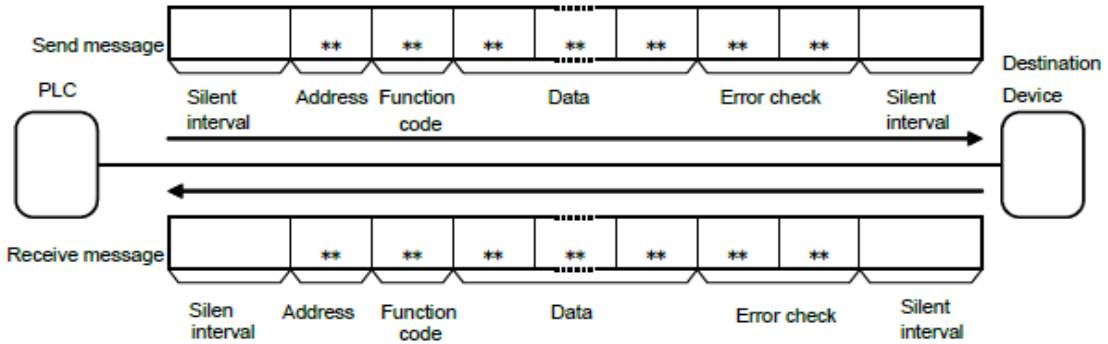

S: Relation between the first command word (CMND instruction operand) and the send messages

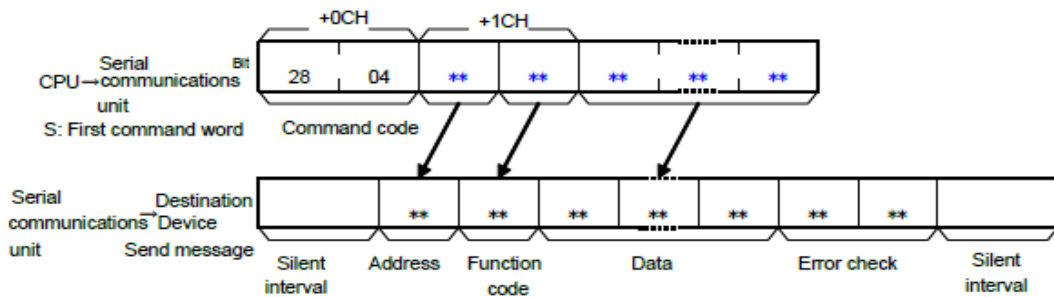

D: Relation between the receive messages and the first response word (CMND instruction operand)

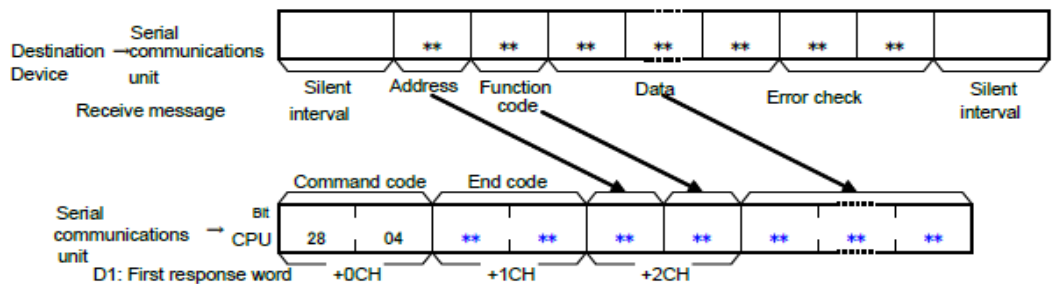

**Additional Information**

Silent interval: Waiting time to recognize the first frame using the Modbus-RTU communication. During the reception standby, the first received data is deemed as the first byte of frame after the waiting time of 3.5 characters with actual baud rate.



**Additional Information**

Error check: 16-bit data is expressed with two 8-bit data for the Modbus-RTU communication. Error check result is calculated by the calculation formula called CRC (Cyclical Redundancy Check).

## 9.2. Destination Device Command

The functions to read or write coils or registers are defined as "Modbus functions" in the Modbus-RTU communication. The Destination Device can be operated (command execution) by using the Modbus functions to read or write coils or registers defined by Destination Device.

### 9.2.1. Function Code List

In the Modbus functions, a function code is allocated for each function. The following function codes are available for Destination Device in this document.

This program performs Total Power ON Time Monitor by using the function "Read from Holding Register (function code: #03)".

Code (hex)	Function	Description
#01	Read Coil Status	Reads the coil status (ON/OFF).
#03	Read from Holding Register	Reads the contents of consecutive holding registers. From the specified holding register, the specified number of holding registers can be read.
#05	Write to Coil	Writes the ON/OFF status to a single coil.
#06	Write to Holding Register	Writes data to the specified holding register.
#08	Loop-back Test	Checks the communications between the master and the slave. Any value can be used for test data.
#0F	Write to Multiple Coils	Rewrites the ON/OFF status to consecutive multiple coils.
#10	Write to Multiple Holding Registers	Writes data to consecutive multiple holding registers.
#17	Read/Write from/to Multiple Holding Registers	Reads data from and writes data to consecutive multiple holding registers in a continuous manner.



#### Additional Information

For details on function codes, refer to *8-5 Explanation of Each Function Code* of the *Multi-function Compact Inverter MX2 Series Type V1 User's Manual* (Cat. No. I585).

### 9.2.2. Detailed Description of the Function

The following explains the details of Total Power ON Time Monitor (register number: #1017 to #1018) performed by using "Read from Holding Register (function code: #03)".



#### Additional Information

For details on register addresses and register numbers, refer to *8-9 Modbus Communication Data Lists of the Multi-function Compact Inverter MX2 Series Type V1 User's Manual* (Cat. No. I585).

#### ●CMND instruction operand

- Setting contents of the first control word C (C: CIO 5010)

CH	Contents		Data	Description
C	Number of command data bytes (4-digit hex)		#0008	8 bytes in S to S+3
C+1	Number of response data bytes (4-digit hex)		#000B	11 bytes from D to the upper byte of D+5
C+2	Upper	#0 (fixed)	#0000	#0 (fixed)
	Lower	Serial port number (1-digit hex)		Not used.
C+3	Upper	Destination network address (2-digit hex)	#0080	Own network
	Lower	Destination node address (2-digit hex)		Local node
C+4	Upper	Destination unit address (2-digit hex)	#0703	SCU number 0, Port 1
	Lower	Response needed/not needed (1-digit hex)		Response needed
C+5	Upper	Logical port number (1-digit hex)	#0703	No.7 to use
	Lower	#0 (fixed)		#0 (fixed)
C+5	Resend times (1-digit hex)		#0000	3 times
C+5	Response timeout (4-digit hex)		#0000	2s: Default value

- Setting contents of the first command word S (S: CIO 5020)

CH	Contents		Data	Description
S	Command code (4-digit hex)		#2804	Modbus-RTU communication command
S+1	Upper	Slave address (2-digit hex)	#0103	#01: Destination Device address
	Lower	Function code (2-digit hex)		#03: Read from Holding Register
S+2	Register address (4-digit hex) (= register number - 1).		#1016	Total Power ON Time Monitor
S+3	Number of read words (4-digit hex)		#0002	2 words

- Storing contents of the first response word D (D: CIO 5500)

CH	Contents		Data	Description
D	Command code (4-digit hex)		#2804	Command code for S
D+1	End code (4-digit hex)		#####	End code for FINS command
D+2	Upper	Slave address (2-digit hex)	#0103	#01: Slave address of S + 1
	Lower	Function code (2-digit hex)		#03: Function code of S+1
D+3	Upper	Number of bytes to read (2-digit hex)	#04**	#04: Twice the number of read words S+3
	Lower	Read data (first byte)		First byte of total power ON time
D+4	Upper	Read data (second byte)	#####	Second byte of total power ON time
	Lower	Read data (third byte)		Third byte of total power ON time
D+5	Upper	Read data (forth byte)	###00	Forth byte of total power ON time
	Lower	(Not used)		#00: (Not used)

#### ●Send/Receive messages

- Send message **Command data surrounded by bold lines above** + **CRC16 data (2 bytes)**
- Receive message **Response data surrounded by bold lines above** + **CRC16 data (2 bytes)**

\*CRC16: Error check code of send/receive data (When sending the data, the error check code is automatically added in the send data by Modbus-RTU communication command. After the error check code is automatically checked when receiving the data, the error check code is deleted from the receive data.)

### 9.3. Error Detection Processing

In this program, the error detection processing is performed by means of dividing the errors into the following areas (1) to (3).

For details on error codes, refer to 9.7. *Error Processing*.

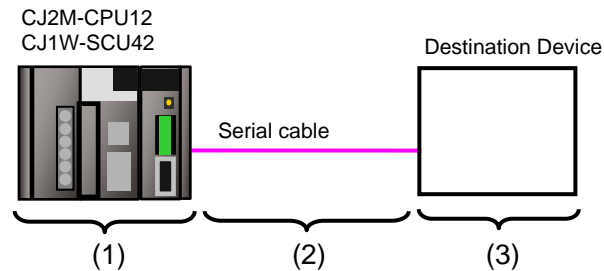

#### (1) Errors when executing the CMND instruction (CMND instruction error)

Errors such as the Unit error, the command format error, and the parameter error at the execution of the CMND instruction are detected as CMND instruction errors. An error is detected with Communications Port Error Flags (A219.07) of related auxiliary area when using the CMND instruction.

#### (2) Transmission errors when communicating with Destination Device (Communications error)

Errors occurred in communications with Destination Device, such as character corruption and transmission errors caused by unmatched baud rate settings, are detected in CMND instruction errors. Although the error is detected with (1), the allocated CIO area of SCU "TransmissionErrorStatus (1508)" is stored in the output area for the communication error check.

#### (3) Errors in Destination Device (Destination Device errors)

Destination Device errors include function code error, register address error, data error, and execution failure in Destination Device. An error is detected with the response data which is returned from Destination Device. If an error occurs in Destination Device, a function code that is obtained by adding #80 in the transmitted function code is returned (in this program, #83 is returned when #03 is sent). This program detects an error based on the difference between the send/receive function codes.

Send message	01	03	10	16	00	02	CRC16
	Slave address	Function code	Register address		Number of read words		
Receive message (at error)	01	83	**				CRC16
	Slave address	Function code + #80	Error code				



#### Additional Information

For information on the CIO area allocated to SCU, refer to 9.4.2 *List of Fixed Allocations*.

## 9.4. Memory Maps

The following is the memory maps of this program.

### 9.4.1. Lists of Addresses

The tables below list the addresses necessary to execute this program.

You can change the allocation below to any addresses.



#### Precautions for Correct Use

Make sure there is no duplicated address when changing an address.

#### •Input memory

The below address is used to operate this program.

Address	Data type	Variable name	Description
5000.00	BOOL	Input_Start	When this flag changes from OFF to ON, the send/receive processing starts.

#### •Output memory

The execution results of the program are stored in these addresses.

Address	Data type	Variable name	Description
5000.02	BOOL	Output_NormalEnd	Turns ON when the send/receive processing ends normally.
5000.03	BOOL	Output_ErrorEnd	Turns ON when one or more of the following errors occur. (1)CMND instruction error (2)Communications error (3)Destination Device error
5500	UINT	FirstResponseWord	The received data is stored.
5501	UINT	ResponseWord_1	The received data is stored.
5502	UINT	ResponseWord_2	The received data is stored.
5503	WORD	ResponseWord_3	The received data is stored.
5504	WORD	ResponseWord_4	The received data is stored.
5505	WORD	ResponseWord_5	The received data is stored.
H400	WORD	Output_CMND_ErrorCode	An Error code is stored when a CMND instruction error occurs.
H401	WORD	Output_TransmissionErrorStatus	Content of transmission error status "CIO 1508" is stored when a communication error occurs.
H402	WORD	Output_DestinationDeviceErrorCode	An error code received from Destination Device is stored when an error occurs in Destination Device.



- Internal memory

These addresses are used to operate this program only.

Address	Data type	Variable name	Description
5000.01	BOOL	Local_CMND_Executing	CMND instruction execution status is indicated. Turns ON when a CMND instruction is being executed, and turns OFF when a CMND instruction is not executed.
5000.04	BOOL	Local_CMND_NormalEnd	Turns ON when a CMND instruction ends normally.
5000.05	BOOL	Local_CMND_ErrorEnd	Turns ON when a CMND instruction error (including a communications error) occurs.
5000.06	BOOL	Local_DestinationDeviceError	Turns ON when a Destination Device error occurs.
5010	UINT	Local_FirstControlWord	Execution parameter of CMND instruction
5011	UINT	Local_ControlWord_1	Execution parameter of CMND instruction
5012	UINT	Local_ControlWord_2	Execution parameter of CMND instruction
5013	UINT	Local_ControlWord_3	Execution parameter of CMND instruction
5014	UINT	Local_ControlWord_4	Execution parameter of CMND instruction
5015	UINT	Local_ControlWord_5	Execution parameter of CMND instruction
5020	UINT	Local_FirstCommandWord	Send data of CMND instruction
5021	UINT	Local_CommandWord_1	Send data of CMND instruction
5022	UINT	Local_CommandWord_2	Send data of CMND instruction
5023	UINT	Local_CommandWord_3	Send data of CMND instruction

### 9.4.2. List of Fixed Allocations

The tables below list the addresses necessary to execute this program.

- Allocated CIO area

The following is the fixed addresses determined by the unit address (unit number) that is set for SCU. Therefore, you must not change these allocations.

Unit number 0 is used in this program.

Address	Data type	Variable name
1508.15	BOOL	TransmissionError_SCU_0_P1
1508	WORD	TransmissionErrorStatus_SCU_0_P1



#### Additional Information

For details on the allocated CIO area of SCU, refer to 2-3-2. *CIO Area* in 2-3. *I/O Memory Allocations* in *SECTION 2 Initial Settings and I/O Memory Allocations* of the *CJ Series Serial Communications Units OPERATION MANUAL* (Cat. No. W336).

- Related auxiliary area

The addresses of the following related auxiliary area are determined by the communications port (internal logical port) specified in the program (CMND operand). Therefore, you must not change these allocations.

This program uses communications port (internal logical port) No. 7.

Address	Data type	Variable name
A202.07	BOOL	CommPortEnabledFlag_P7
A219.07	BOOL	CommPortErrorFlag_P7
A210	WORD	CommPortCompletionCode_P7



#### Additional Information

For information on related auxiliary area for the CMND instruction, refer to *Related Auxiliary Area Words and Bits* in *Network Instructions (CMND)* in *SECTION 3. Instructions* of the *CJ Series Programmable Controllers INSTRUCTIONS REFERENCE MANUAL* (Cat. No. W474).

## 9.5. Ladder program

### 9.5.1. Functional Components of the Ladder Program

The functional components of this program are shown below.

Major classification	Minor classification	Description
1.Initialization processing	1.1. Response code clear 1.2. Control word setting for CMND instruction 1.3. Send/Receive symbol setting	The area of use is cleared and the initialization setting is performed as a preparation for communications.
2.CMND instruction execution management	2.1. CMND instruction executing 2.2. CMND instruction execution processing 2.3. Normal/Error detection processing.	CMND instruction (Modbus-RTU communication) is executed. A normal end or an error end is detected based on the related flags and receive data.
3.Normal end state management	3.1. Normal end processing 3.2. Response code setting	The normal completion flag is turned ON. The response code for a normal end is set.
4.Error end state management	4.1. Error end processing 4.2. Response code setting	The error end flag is turned ON. The response code corresponding to an error cause is set.

### 9.5.2. Detailed Description of Each Functional Component

The program configured in this document is shown below.

#### •1. Initialization processing



No.	Outline	Description
1.1.	Response code clear	The Error code storage area is initialized.

1.2. Control word setting for CMND instruction

5000.00 ↑↑ Input_Start	MOV(021)	#0008	5010 Local_FirstControlWord
	MOV(021)	#000B	5011 Local_ControlWord_1
	MOV(021)	#0000	5012 Local_ControlWord_2
	MOV(021)	#0080	5013 Local_ControlWord_3
	MOV(021)	#0703	5014 Local_ControlWord_4
	MOV(021)	#0000	5015 Local_ControlWord_5

1.3. Send/Receive symbol setting

5000.00 ↑↑ Input_Start	MOV(021)	#2804	5020 Local_FirstCommandWord
	MOV(021)	#0103	5021 Local_CommandWord_1
	MOV(021)	#1016	5022 Local_CommandWord_2
	MOV(021)	#0002	5023 Local_CommandWord_3
	BSET(071)	#0	5500 FirstResponseWord

No.	Outline	Description
1.2.	Control word setting for CMND instruction	The control word of CMND instruction is set. For details on the settings, refer to 9.2.2. <i>Detailed Description of the Function.</i>
1.3.	Send/Receive symbol setting	The FINS command and the Destination Device function are set to the send symbol, and the receive data storage area is initialized.

●2. CMND instruction execution management

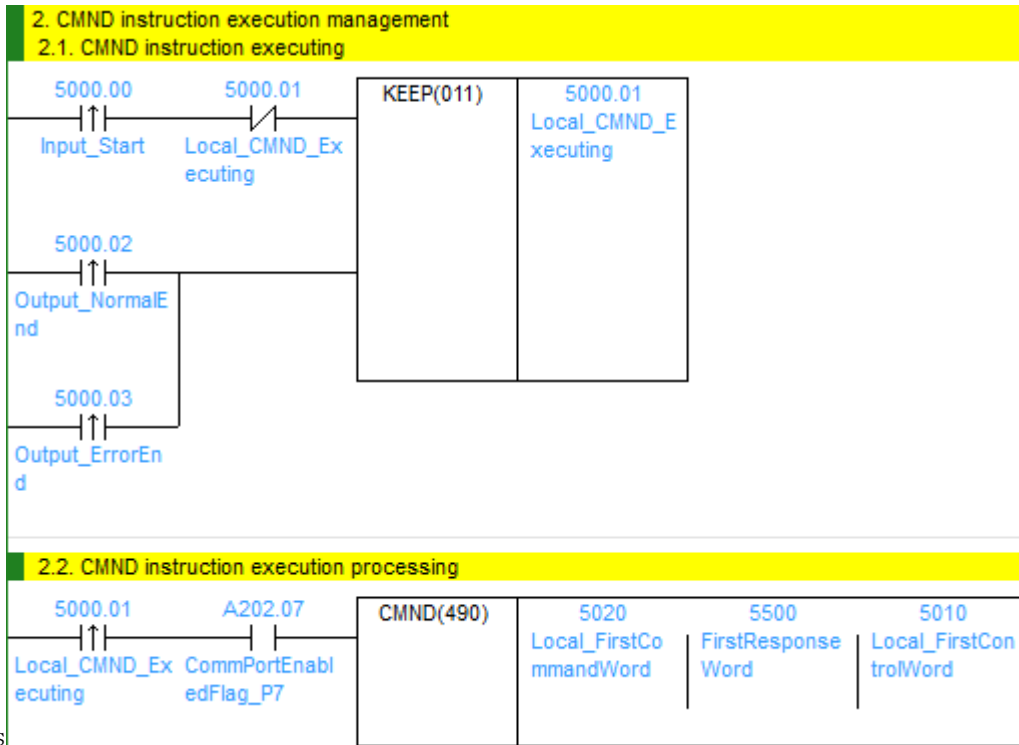

SS

No.	Outline	Description
2.1.	CMND instruction executing	CMND instruction executing status is entered. The executing state is reset at a normal end or an error end of the program.
2.2.	CMND instruction execution processing	CMND instruction is executed under the following conditions: Communications port No.7 can be used. CMND instruction is not being executed.



**Precautions for Safe Use**

Make sure to sufficiently check the overall program before specifying the area to store the receive data of the CMND instruction. Otherwise, the data may be written to an unintended memory area.



**Precautions for Correct Use**

This program uses communications port (internal logical port) No.7.  
Do not use communications port No.7 for other purpose. If you have no choice but to use communications port No. 7, check that Communications Port Enabled Flag (A202.07) is ON.

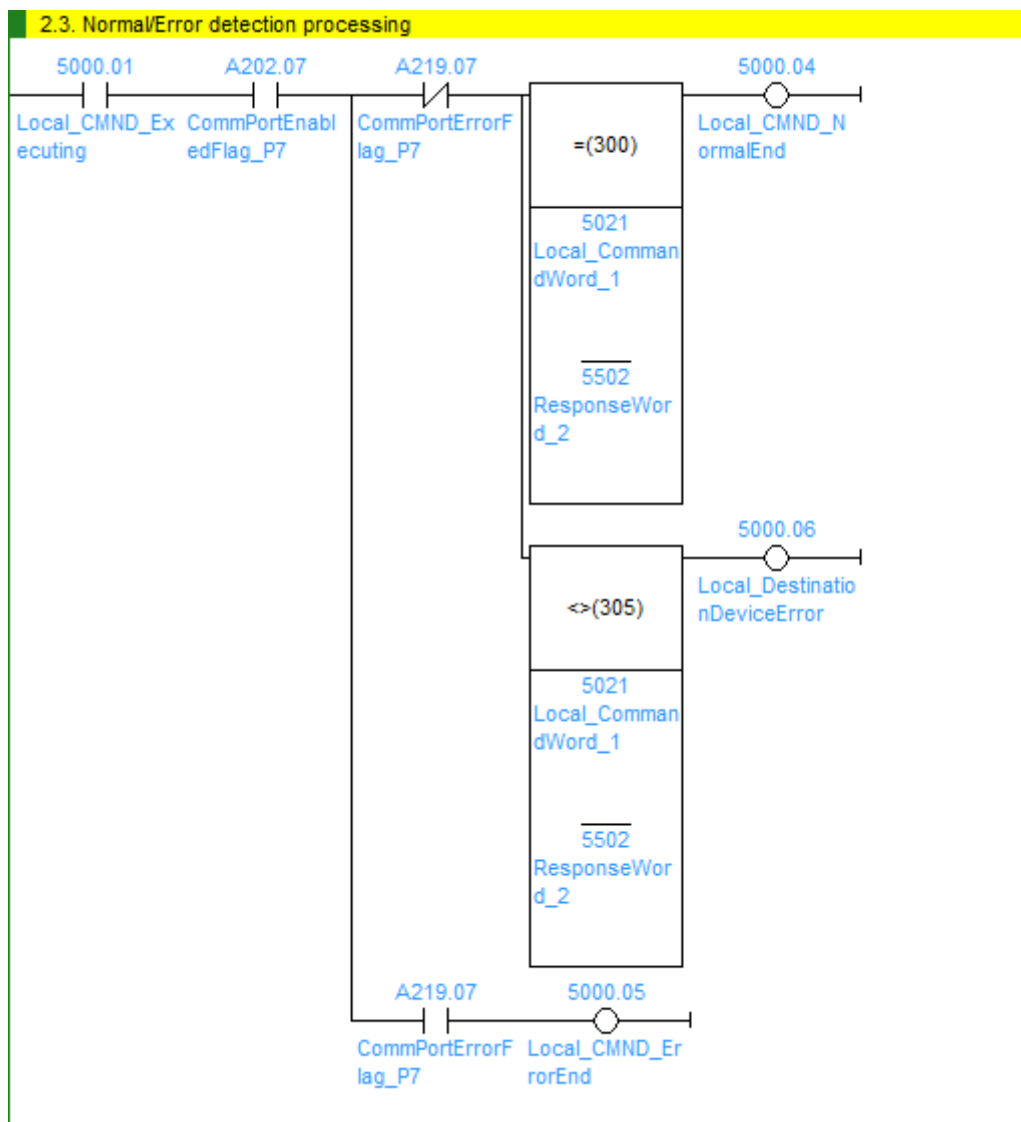

No.	Outline	Description
2.3.	Normal/Error Detection Processing	<p>Detects a normal end or an error end of the result of send/receive processing.</p> <p>It is identified as a normal end when all the following conditions are satisfied.</p> <ul style="list-style-type: none"> <li>• Normal end of CMND instruction (No CMND instruction error) (Condition of "No communication error" is included in (1).)</li> <li>• Receives normal messages from Destination Device (No Destination Device error)</li> </ul> <p>If any of the above errors occurs under the conditions above, the corresponding error flag will turn ON.</p>

●3. Normal end state management

3. Normal end state management  
 3.1. Normal end processing

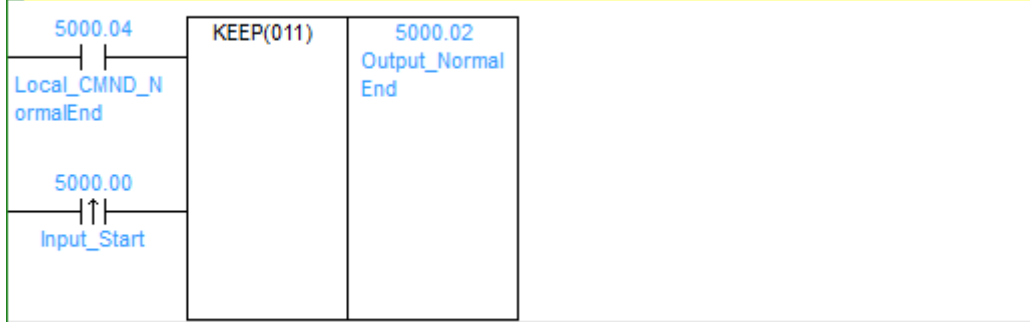

3.2. Response code setting

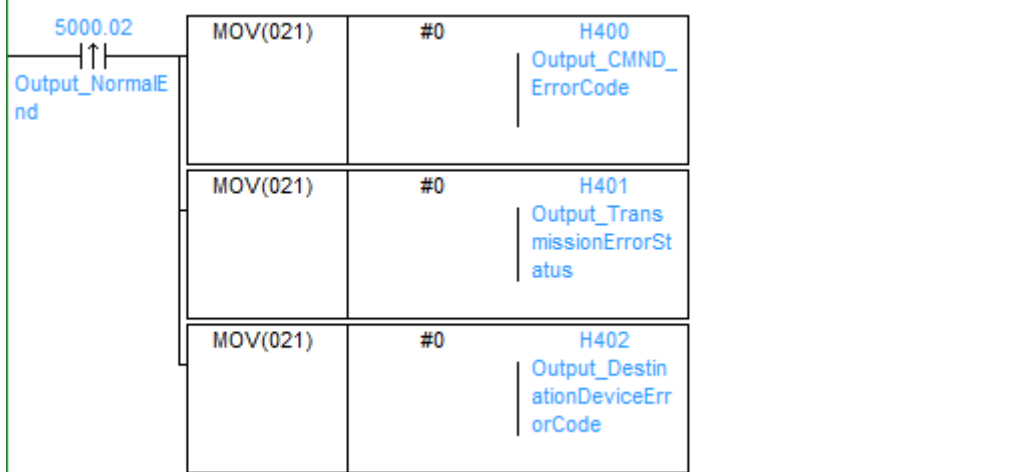

No.	Outline	Description
3.1.	Normal end processing	Turns ON the normal end flag if it is detected in 2.3. Normal/Error detection processing that the send/receive processing ends normally.
3.2.	Response code setting	Sets response code "#0000" for a normal end in the response code storage area.

●4. Error end state management

4. Error end state management  
4.1. Error end processing

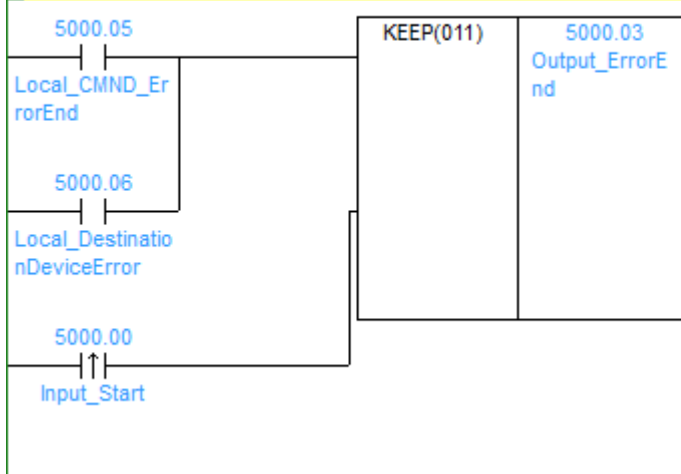

4.2. Response code setting

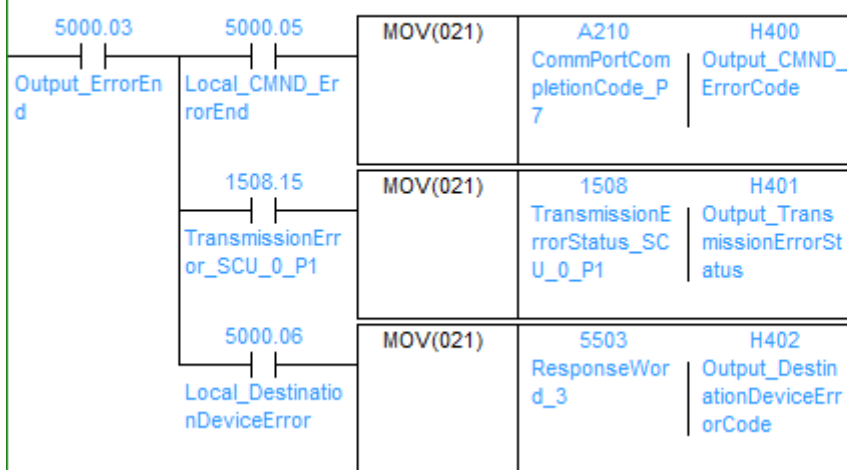

No.	Outline	Description
4.1.	Error end processing	Turns ON the error end flag if it is detected in 2.3. Normal/Error detection processing that the send/receive processing ends in an error.
4.2.	Response code setting	Sets the response code corresponding to the error in the response code storage area when an error occurs.



**Additional Information**

Refer to 9.7 *Error Processing* in this document for details on the response codes.



### 9.6. Timing Chart

The timing charts are shown below.

The definitions of the timing chart patterns are as follows:

Pattern	Normal end	Error end (1) CMND instruction error	Error end (2) Communications error	Error end (3) Destination Device error
Command	Normal	Error	Normal	Normal
Destination Device	Normal	Normal or error	Normal or error	Error
Response	Yes	No	No	Yes

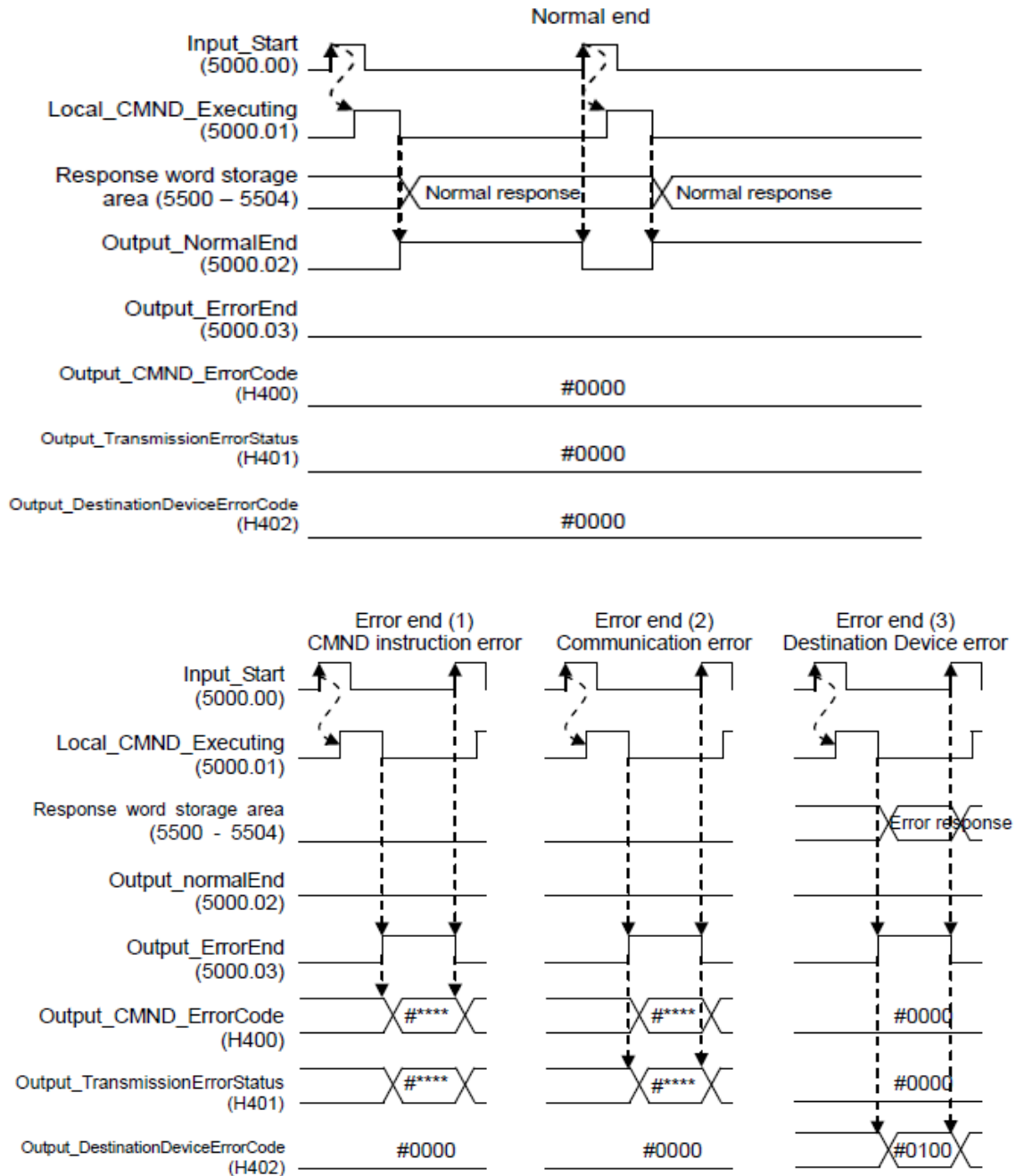

## 9.7. Error processing

The following tables list the errors that occur during executing this program.

### 9.7.1. CMND Instruction Error Code

H400 stores the end code of the network communications instruction.

[Format]

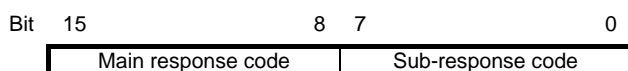

[Response codes (Excerpt)]

Main	Sub	Main response code	Sub-response code
02	05	Destination node error	Response timeout
10	04	Command format error	Command format error
25	05	Unit error	CPU Bus Error



#### Additional Information

For details, refer to *5-1-3 End Codes* in *5-1 Command Lists* in *SECTION 5 FINS Commands* of the *CJ Series Communications Commands REFERENCE MANUAL* (Cat. No. W342).



#### Additional Information

For details on the CMND instruction error and troubleshooting, refer to *12-3 Troubleshooting* in *SECTION 12 Troubleshooting and Maintenance* of the *CJ Series Serial Communications Units OPERATION MANUAL* (Cat. No. W336).

### 9.7.2. Transmission error status

H401 stores contents of the transmission error status "1508".

[Contents of each bit in the transmission error status]

Bit	Description
15	1: Transmission error    0: No transmission error
8 to 14	(Not used)
7	1: FCS check error    0: FCS check normal
6	(Not used)
5	1: Timeout error    0: Normal
4	1: Overrun error    0: Normal
3	1: Framing error    0: Normal
2	1: Parity error    0: Normal
0, 1	(Not used)

### 9.7.3. Destination Device Error Code

Upper byte of H402 stores the following error codes.

[Format]

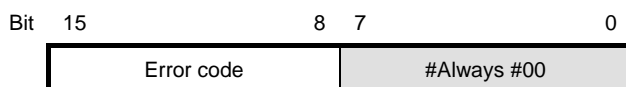

[Error code list]

Error code (hex)	Description
#01	An unsupported function is specified.
#02	The specified address does not exist.
#03	The specified data is in an unacceptable format.
#21	Writing to a holding register is specified, but the data is out of the range allowed for the inverter.
#22	<p>The inverter does not allow this function because:</p> <ul style="list-style-type: none"> <li>• Function attempts to change a register that cannot be changed during RUN.</li> <li>• Function attempts to issue the Enter command during RUN (UV <sup>*1</sup>).</li> <li>• Function attempts to write data to a register during trip (UV <sup>*1</sup>).</li> <li>• Function attempts to write data to a register on which the soft lock function is enabled.</li> <li>• Function attempts to change an I/O terminal that cannot be changed.</li> <li>• Function attempts to change the contact type of the terminal to which the RS (Reset) is allocated.</li> <li>• Function attempts to write data to a register when the auto-tuning function is enabled.</li> <li>• Function attempts to write data to a password-locked register when the password function is enabled.</li> </ul> <p>etc.</p> <p style="text-align: center;">*1. UV: Undervoltage</p>
#23	Function attempts to write data to a read-only register (coil).



#### Additional Information

For details and troubleshooting on the Destination Device errors, refer to *8-4-4 Abnormal Response* in *8-4 Modbus Communication Protocol* of the *Multi-function Compact Inverter MX2 Series Type V1 User's Manual* (Cat. No. I585).

## 10. Revision History

Revision code	Date of revision	Revision reason and revision page
01	November 16, 2015	First edition



**OMRON Corporation Industrial Automation Company**

Tokyo, JAPAN

Contact: [www.ia.omron.com](http://www.ia.omron.com)

**Regional Headquarters**

**OMRON EUROPE B.V.**

Wegalaan 67-69, 2132 JD Hoofddorp  
The Netherlands  
Tel: (31)2356-81-300/Fax: (31)2356-81-388

**OMRON ELECTRONICS LLC**

2895 Greenspoint Parkway, Suite 200  
Hoffman Estates, IL 60169 U.S.A  
Tel: (1) 847-843-7900/Fax: (1) 847-843-7787

**OMRON ASIA PACIFIC PTE. LTD.**

No. 438A Alexandra Road # 05-05/08 (Lobby 2),  
Alexandra Technopark,  
Singapore 119967  
Tel: (65) 6835-3011/Fax: (65) 6835-2711

**OMRON (CHINA) CO., LTD.**

Room 2211, Bank of China Tower,  
200 Yin Cheng Zhong Road,  
PuDong New Area, Shanghai, 200120, China  
Tel: (86) 21-5037-2222/Fax: (86) 21-5037-2200

Authorized Distributor:

© OMRON Corporation 2015 All Rights Reserved.  
In the interest of product improvement,  
specifications are subject to change without notice.

Cat. No. P641-E1-01

1115- (-)