



3G3MX2-□-E Multi-function Compact Inverter

INSTRUCTION MANUAL

Thank you for purchasing 3G3MX2 Inverter.
To ensure the safe operation, please be sure to read the safety precautions provided in this document along with all of the user manuals for the inverter. Please be sure you are using the most recent versions of the user manuals. Keep this instruction manual and all of the manuals in a safe location and be sure that they are readily available to the final user of the products.

| Manual Name | Cat.No. |
|--------------------------|---------|
| MX2 Series User's Manual | I570-E2 |

OMRON Corporation

©OMRON Corporation 2012 All Rights Reserved. 2272699-9B NT321XC-EN

Names of Parts

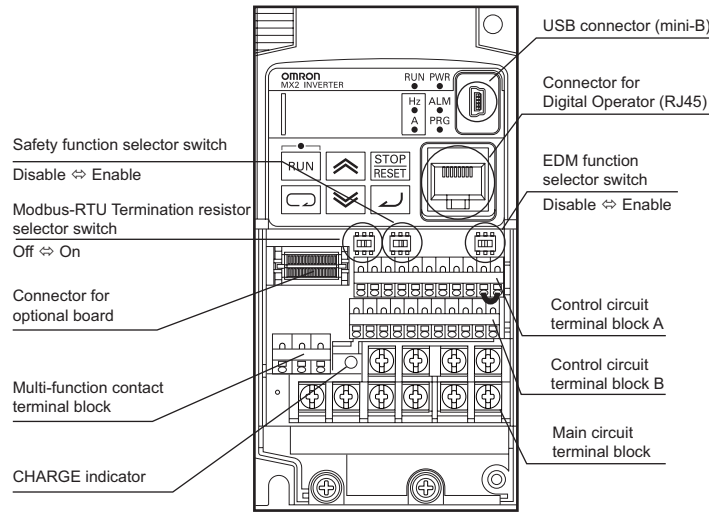

Installation and Wiring

■ Dimensions

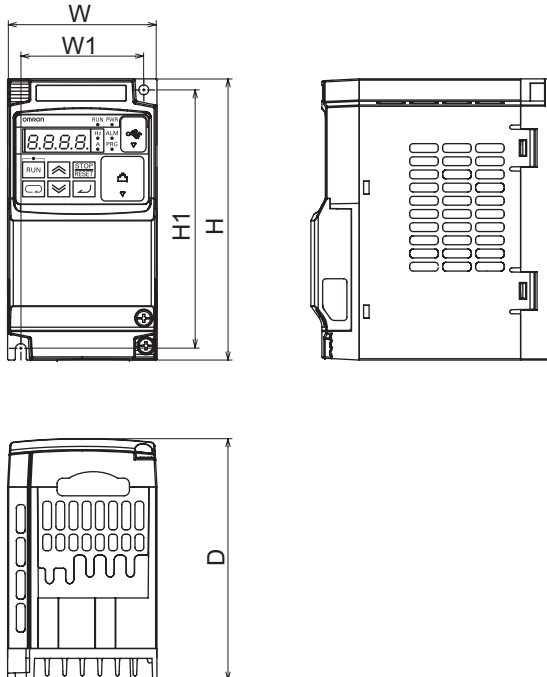

| 3G3MX2- | W | W1 | H | H1 | D |
|---|-----|-----|-----|-----|-------|
| AB001-E, AB002-E A2001-E, A2002-E | 68 | 56 | 128 | 118 | 109 |
| AB004-E A2004-E | | | | | 122.5 |
| A2007-E A4004-E | | | | | 145.5 |
| AB007-E, AB015-E, AB022-E A2015-E, A2022-E, A4007-E A4015-E, A4022-E, A4030-E | | | | | 170.5 |
| A2037-E A4040-E | 140 | 128 | 128 | 118 | 170.5 |
| A2055-E, A2075-E A4055-E, A4075-E | 140 | 122 | 260 | 248 | 155 |
| A2110-E A4110-E, A4150-E | 180 | 160 | 296 | 284 | 175 |
| A2150-E | 220 | 192 | 350 | 336 | 175 |

■ Standard Connection Diagram

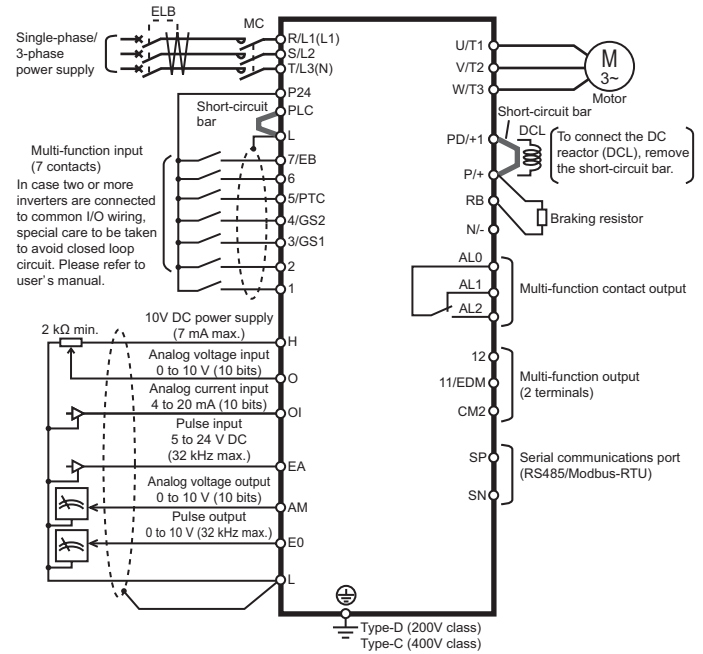

※Connect a single-phase 200V AC input to terminals R/L1 and T/L3(N).
※Factory default settings for relay output are NC contact for AL1 and NO contact for AL2.

Keys

| Name | Description |
|---------------|--|
| Mode key | Switches the function code group to next when function code is displayed. Switches to function code without data settings when data is displayed. ■ Status transition |
| Increment key | Changes the set values, parameters and Commands |
| Decrement key | |
| RUN | RUN key Starts the operation. Forward / Reverse rotation depends on the 'F004' setting. |
| STOP/RESET | STOP/RESET key Stops the operation. Functions as the Reset key if an error occurs. |
| Enter key | Enter key Enters and stores the data. |

| Parameter No. | Function name | Monitor or data range |
|---------------|---|---|
| d001 | Output frequency monitor | 0.00 to 400.0 |
| d002 | Output current monitor | 0.0 to 655.3 |
| d003 | Rotation direction monitor | F: forward /o: stop /r: reverse |
| d004 | PID feedback value monitor | 0.00 to 9999. |
| d007 | Output frequency monitor (after conversion) | 0.00 to 9999. |
| d008 | Real frequency monitor | -400. to 400. |
| d009 | Torque reference monitor | -200. to +200. |
| d010 | Torque bias monitor | -200. to +200. |
| d012 | Output torque monitor | -200. to +200. |
| d013 | Output voltage monitor | 0. to 600. |
| d014 | Input power monitor | 0.0 to 100.0 |
| d015 | Integrated power monitor | 0.0 to 9999. |
| d016 | Total RUN time | 0.0 to 9999. |
| d017 | Power ON time | 0.0 to 9999. |
| d018 | Fin temperature monitor | -20.0 to 150.0 |
| d029 | Position command monitor | -268435455 to 268435455 (Displays MSB 4 digits including) |
| d030 | Current position monitor | -268435455 to 268435455 (Displays MSB 4 digits including) |
| d080 | Fault counter | 0. to 9999. |
| d081 to d086 | Fault monitor1 (latest) ~ Fault monitor6 | Error code (condition of occurrence) →Output frequency →Output current →Internal DC voltage →RUN time →ON time |
| d090 | Warning monitor | Warning code |
| d102 | DC voltage monitor | 0.0 to 999.9 |
| d103 | Regenerative braking load rate monitor | 0.0 to 100.0 |
| d104 | Electronic thermal monitor | 0.0 to 100.0 |
| F001 | Output frequency setting | Starting frequency to max. frequency |
| F002 | Acceleration time1 | 0.01 to 3600. |
| F003 | Deceleration time1 | 0.01 to 3600. |
| F004 | Operator rotation direction selection | 00: forward 01: reverse |
| A001 | Frequency reference selection | 00: Digital Operator(volume) (Enable when 3G3AX-OP01 is used) / 01: Terminal /02: Digital Operator(F001) / 03: Modbus communication /04: Option / 06: Pulse train frequency /07: Drive Programming /10: Frequency operation result |
| A002 | RUN command selection | 01: Terminal /02: Digital Operator / 03: Modbus communication /04: Option |
| A003 | Base frequency | 30.0 to max. frequency |
| A004 | Maximum frequency | Base frequency to 400. |
| A005 | O/OI selection | 00: Switch between O and OI terminals 02: Switch between O terminal and keypad potentiometer /03: Switch between OI terminal and keypad potentiometer |
| A019 | Multi-step speed selection | 00: Binary (16-step selection with 4 terminals) 01: bit (8-step selection with 7 terminals) |
| A020 | Multi-step speed reference 0 | 0.00, /Starting frequency to max. frequency |
| A021 to A035 | Multi-step speed reference 1 to 15 | 0.00, /Starting frequency to max. frequency |
| A038 | Jogging frequency | Starting frequency to 9.99 |
| A039 | Jogging stop selection | 00: Free running on jogging stop, Disabled in operation /01: Deceleration stop on jogging stop, Disabled in operation /02: DC injection braking on jogging stop, Disabled in operation /03: Free running on jogging stop, Enabled in operation /04: Deceleration stop on jogging stop, Enabled in operation /05: DC injection braking on jogging stop, Enabled in operation |
| A045 | Output voltage gain | 20. to 100. |
| A097/A098 | Acceleration / Deceleration pattern selection | 00: Linear /01: S-shape curve /02: U-shape curve /03: Inverted U-shape curve / 04: EL-S-shape curve |
| b001 | Retry selection | 00: Alarm /01: 0Hz start /02: Frequency matching start /03: Trip after frequency matching deceleration stop /04: Active Frequency matching |
| b002 | Allowable momentary power interruption time | 0.3 to 25.0 |
| b083 | Carrier frequency | 2.0 to 15.0 / 10.0 |
| b084 | Initialization selection | 00: Disabling /01: Clearing the trip history / 02: Initializing the data /03: Clearing the trip history and initializing the data /04: Clearing the trip history and initializing the data and Drive Programming |
| b130 | Overvoltage LAD stop function | 00: Disable /01: DC voltage kept constant / 02: Acceleration enabled |
| b131 | Overvoltage LAD stop function level | 200V class: 330. to 395. 400V class: 660. to 790. |

| Parameter No. | Function name | Monitor or data range |
|--------------------|---|---|
| C001 to C007 | Multi-function input 1 to 7 selection | 00:FW(forward RUN/Stop) /01:RV(reverse RUN/Stop) /02:CF1(Multi-speed Select, Bit0(LSB)) / 03:CF2(Multi-speed Select, Bit1) /04: CF3 (Multi-speed Select, Bit2) /05:CF4(Multi-speed Select, Bit3(MSB)) / 06:JG(jogging) /07:DB(External DC braking) /08:SET(Set (select) 2nd Motor Data) /09:2CH(2-stage Acceleration and Deceleration) /11:F:RS (Freerun Stop) /12:EXT(External Trip) /13:USP(Unattended Start Protection) /14:CS(Commercial power source switchover) /15:SFT (Software Lock) /16:AT(Analog Input Voltage/Current Select) /18:RS (Reset Inverter) /19:PTC(PTC thermistor Thermal Protection(C005 only)) /20:STA(Start(3-wire interface)) /21:STP(Stop(3-wire interface)) / 22:F/R(FWD, REV(3-wire interface) /23:PID(PID Disable) /24:PIDC (PID Reset) /27:UP(UP/DWN function accelerated) /28:DWN(UP/DWN function decelerated) /29:UDC(Remote Control Data Clearing) / 31:OPE(Operator Control) /32:SF1(Multi-speed Selection, Bit operation Bit1) /33:SF2(Multi-speed Selection, Bit operation Bit2) /34:SF3 (Multi-speed Selection, Bit operation Bit3) /35:SF4(Multi-speed Selection, Bit operation Bit4) /36:SF5(Multi-speed Selection, Bit operation Bit5) /37:SF6(Multi-speed Selection, Bit operation Bit6) / 38:SF7(Multi-speed Selection, Bit operation Bit7) /39:OLR(Overload Restriction Source Changeover) /40:TL(Torque Limit Selection) / 41:TRQ1(Torque limit switch1) /42:TRQ2(Torque limit switch2) / 44:BOK(Brake confirmation) /46:LAC(LAD cancellation) /47:PCLR (Pulse counter clear) /50:ADD(ADD frequency enable) /51:F-TM (Force Terminal Mode) /52:ATR(Enable torque command Input) / 53:KHC(Clearance of cumulative power data) /56:M11(General purpose input1) /57:M12(General purpose input2) /58:M13(General purpose input3) /59:M14(General purpose input4) /60:M15(General purpose input5) /61:M16(General purpose input6) /62:M17(General purpose input7) /65:AHd(Analog command hold) /66:CP1(Multistage-position switch1) /67:CP2(Multistage-position switch2) /68:CP3 (Multistage-position switch3) /69:ORL(Limit signal of homing) / 70:ORG(Trigger signal of homing) /73:SPD(Speed/position changeover) /77:GS1(GS1 input(C003 only)) /78:GS2(GS2 input (C004 only)) /81:485(Start EzCOM) /82:PRG(Executing Drive Programming) /83:HLd(Retain output frequency) /84:ROK(Permission of Run command) /85:EB(Rotation direction detection(C007 only)) / 86:DISP(Display limitation) /91:PSET(Preset) |
| C011 to C017 | Multi-function input terminal operation selection | 00: NO 01: NC |
| C021 to C022 | Multi-function output 11-12 selection | 00:RUN(RUN Signal) /01:FA1(Frequency Arrival Type 1-Constant Speed) /02:FA2(Frequency Arrival Type 2-Over frequency) /03:OL (Overload Advance Notice Signal1) /04:OD(Overload Advance Notice Signal2) /05:AL(Alarm Signal) /06:FA3(Frequency Arrival Type 3-Set frequency) /07:OTQ(Over/under Torque Signal) /09:UV(Undervoltage) / 10:TRQ(Torque Limited Signal) /11:RNT(RUN Time Expired) /12:ONT (Power On time Expired) /13:THM(Thermal Warning) /19:BRK(Brake Release Signal) /20:BER(Brake Error Signal) /21:ZS(Zero Hz Speed Detection Signal) /22:DSE(Speed Deviation Excessive) /23:POK (Positioning Completion) /24:FA4(Frequency Arrival Type 4-Over frequency) /25:FA5(Frequency Arrival Type 5-Set frequency) /26:OL2 (Overload Advance Notice Signal2) /27:ODc(Analog Voltage Input Disconnect Detection) /28:OIDc(Analog Current Output Disconnect Detection) /31:FBV(PID Second Stage Output) /32:NDc(Network Disconnect Detection) /33:LOG1(Logic Output Function1) /34:LOG2 (Logic Output Function2) /35:LOG3(Logic Output Function3) /39:WAC (Capacitor Life Warning Signal) /40:WAF(Cooling Fan Warning Signal) / 41:FR(Starting Contact Signal) /42:OHF(Heat Sink Overheat Warning) / 43:LOC(Low load detection) /44:MO1(General Output1) /45:MO2 (General Output2) /46:MO3(General Output3) /50:IRDY(Inverter Ready Signal) /51:FWR(Forward Rotation) /52:RVR(Reverse Rotation) / 53:MAJ(Major Failure Signal) /54:WCO(Window Comparator for Analog Voltage Input) /55:WCOI(Window Comparator for Analog Current Input) /58:FREF(Frequency Command Source) /59:REF(Run Command Source) /60:SETM(2nd Motor Selection) /62:EDM(STO (Safe Torque Off) Performance Monitor(C021 only)) /63:OPO(Option card output) |
| C031 to C032, C036 | Multi-function Relay output | 00:NO contact at 11, 12, AL2, NC contact at AL1 01:NC contact at 11, 12, AL2, NO contact at AL1 |
| H003 | Motor Capacity | 0.1 / 0.2 / 0.4 / 0.55 / 0.75 / 1.1 / 1.5 / 2.2 / 3.0 / 3.7 / 4.0 / 5.5 / 7.5 / 11.0 / 15.0 / 18.5 [kW] |
| H004 | Motor pole number | 2 / 4 / 6 / 8 / 10 / 12 / 14 / 16 / 18 / 20 / 22 / 24 / 26 / 28 / 30 / 32 / 34 / 36 / 38 / 40 / 42 / 44 / 46 / 48 [pole] |



Safety Precautions

■Indications and Meanings of Safety Information









In this user's Manual, the following precautions and signal words are used to provide information to ensure the safe use of the 3G3MX2 Inverter.

The information provided here is vital to safety. Strictly observe the precautions provided.







■Meanings of Signal Words

| | | |
|--|----------------|--|
|  | WARNING | Indicates an imminently hazardous situation which, if not avoided, will result in minor or moderate injury, or may result in serious injury or death. Additionally there may be significant property damage. |
|  | CAUTION | Indicates a potentially hazardous situation which, if not avoided, may result in minor or moderate injury or in property damage. |

■Alert Symbols in this Document

| | |
|---|---|
|  | WARNING |
|  | Turn off the power supply and implement wiring correctly. Not doing so may result in a serious injury due to an electric shock. |
|  | Wiring work must be carried out only by qualified personnel. Not doing so may result in a serious injury due to an electric shock. |
|  | Be sure to ground the unit. Not doing so may result in a serious injury due to an electric shock or fire. (200V class:type-D grounding, 400V class:type-C grounding) |
|  | Do not remove the front cover during the power supply and 10 minutes after the power shutdown. Doing so may result in a serious injury due to an electric shock. |
|  | Do not operate the Operator or switches with wet hands. Doing so may result in a serious injury due to an electric shock. |
|  | Inspection of the Inverter must be conducted after the power supply has been turned off. Not doing so may result in a serious injury due to an electric shock. The main power supply is not necessarily shut off even if the emergency shut off function is activated. |
|  | Do not change wiring, slide switches, optional devices, or replace cooling fans while power is being supplied. Doing so may result in a serious injury due to an electric shock. |
|  | Do not touch the Inverter fins, braking resistors and the motor, which become too hot during the power supply and for some time after the power shutdown. Doing so may result in a burn. |

CAUTION

| | |
|--|---|
|  | Do not connect resistors to the terminals (PD/+1, P/+2, N/-) directly. Doing so might result in a small-scale fire, heat generation or damage to the unit. |
|  | Install a stop motion device to ensure safety. Not doing so might result in a minor injury. (A holding brake is not a stop motion device designed to ensure safety.) |
|  | Be sure to use a specified type of braking resistor / regenerative braking unit. In case of a braking resistor, install a thermal relay that monitors the temperature of the resistor. Not doing so might result in a moderate burn due to the heat generated in the braking resistor / regenerative braking unit. Configure a sequence that enables the Inverter power to turn off when unusual overheating is detected in the braking resistor / regenerative braking unit. |
|  | The Inverter has high voltage parts inside which, if short-circuited, might cause damage to itself or other property. Place covers on the openings or take other precautions to make sure that no metal objects such as cutting bits or lead wire scraps go inside when installing and wiring. |
|  | Take safety precautions such as setting up a molded-case circuit breaker(MCCB) that matches the Inverter capacity on the power supply side. Not doing so might result in damage to property due to the short circuit of the load. |
|  | Do not dismantle, repair or modify the product. Doing so may result in an injury. |

Precautions for Safe Use

■Installation and Storage

Do not store or use the product in the following places.

- Locations subject to direct sunlight.
- Locations subject to ambient temperature exceeding the specifications.
- Locations subject to relative humidity exceeding the specifications.
- Locations subject to condensation due to severe temperature fluctuations.
- Locations subject to corrosive or flammable gases.
- Locations subject to exposure to combustibles.
- Locations subject to dust (especially iron dust) or salts.
- Locations subject to exposure to water, oil, or chemicals.
- Locations subject to shock or vibration.

■Transporting, Installation and Wiring

- Do not drop or apply a strong impact on the product. Doing so may result in damaged parts or malfunction.
- Do not hold by the front cover, but hold by the fins during transportation.
- Do not connect an AC power supply voltage to the control input / output terminals. Doing so may result in damage to the product.
- Be sure to tighten the screws on the terminal block securely. Wiring work must be done after installing the unit body.
- Do not connect any load other than a three-phase inductive motor to the U, V and W output terminals.
- Take sufficient shielding measures when using the product in the following locations. Not doing so may result in damage to the product.
 - Locations subject to static electricity or other forms of noise.
 - Locations subject to strong magnetic fields.
 - Locations close to power lines.
- If a parameter is set incorrectly when starting up, adjusting, maintaining, or replacing, an unexpected operation may occur. Perform the operation after enough confirmation.
- When using DriveProgramming, confirm that the program data is downloaded normally before starting operation.

■Main Circuit Power Supply

- Confirm that the rated input voltage of the Inverter is the same as AC power supply voltage.

■Operation and Adjustment

- Be sure to confirm the permissible range of motors and machines before operation because the inverter speed can be changed easily from low to high.
- Provide a separate holding brake if necessary.
- If the DriveProgramming stops during multi-function output, the output status is held. Take safety precautions such as stopping peripheral devices.
- Even if the inverter power supply is turned off, the counter-electromotive force occurs while the PM motor rotates, which may result in electric shock.
Do not remove the terminal block cover of the inverter until the PM motor stops.

■Maintenance and Inspection

- Be sure to confirm safety before conducting maintenance, inspection or parts replacement.
- The life of the capacitor depends on the ambient temperatures. Refer to the product life curve shown in User's Manual. When the capacitor stops operating at the end of its service life, the Inverter must be replaced.

Precautions for Correct Use

■Installation

- Mount the product vertically on a wall with the product's longer sides upright.
The material of the wall has to be nonflammable such as a metal plate.

■Error Retry Function

- Do not come close to the machine when using the error retry function because the machine may abruptly start when stopped by an alarm.
- Be sure to confirm the RUN signal is turned off before resetting the alarm because the machine may abruptly start.

■Non-Stop Function at Momentary Power Interruption

- Do not come close to the machine when selecting reset in the non-stop function at momentary power interruption selection (b050) because the machine may abruptly start after the power is turned on.

■Operation Stop Command

- Provide a separate emergency stop switch because the STOP Key on the Operator is valid only when function settings are performed.
- When checking a signal during the power supply and the voltage is erroneously applied to the control input terminals, the motor may start abruptly. Be sure to confirm safety before checking a signal.

■Maintenance

- The Inverter consists of many parts, which must operate properly to maximize its capabilities. Some electronic parts require maintenance depending on their operating conditions. To ensure proper operation of the Inverter over a long period of time, be sure to perform periodic inspections and replace parts according to their service life. (Excerpt from "Recommendations for Periodic Inspections of General-purpose Inverters" issued by JEMA)

■Product Disposal

- Comply with the local ordinance and regulations when disposing of the product.

UL Cautions

The warnings and instructions in this section summarizes the procedures necessary to ensure an inverter installation complies with Underwriters Laboratories guidelines.

- Use 60/75°C Cu wire only.
(For models:3G3MX2-A2001, -A2002, -A2004, -A2007, -AB015, -AB022, -A4004, -A4007, -A4015, -A4022, and -A4030)
- Use 75°C Cu wire only.
(For models:3G3MX2-AB001, -AB002, -AB004, -AB007, -A2015, -A2022, -A2037, -A2055, -A2075, -A2110, -A2150, -A4040, -A4055,-A4075, -A4110 and -A4150)
- Suitable for use on a circuit capable of delivering not more than 100,000 rms Symmetrical Amperes, 240 or 480 Volts Maximum.
- When Protected by CC, G, J, or R Class Fuses, or when Protected By A Circuit Breaker Having An Interrupting Rating Not Less Than 100,000 rms Symmetrical Amperes, 240 or 480 Volts Maximum.
- Install device in pollution degree 2 environment.
- Maximum surrounding air temperature rating of 50°C
- Solid State motor overload protection reacts with max. 150 % of FLA.
- Integral solid state short circuit protection does not provide branch circuit protection. Branch circuit protection must be provided in accordance with the National Electric Code and any additional local codes.
- Motor over temperature protection is not provided by the drive.

| |
|--|
| AVERTISSEMENT: ne retirez pas le capot avant pendant l'alimentation et 10 minutes après l'arrêt de l'alimentation. Cela peut entraîner de grave blessure due à un choc électrique. |
|--|

■Fuse Size

The Inverter shall be connected with a UL Listed Cartridge Nonrenewable fuse, rated 600Vac with the current ratings as shown in the table below.

| Model No. | Type | Rating |
|--------------------------------------|---------|----------------|
| 3G3MX2-AB001, -AB002, -AB004 | Class J | 10A, AIC 200kA |
| 3G3MX2-AB007 | | 20A, AIC 200kA |
| 3G3MX2-AB015 | | 30A, AIC 200kA |
| 3G3MX2-AB022 | | 30A, AIC 200kA |
| 3G3MX2-A2001, -A2002, -A2004 | | 10A, AIC 200kA |
| 3G3MX2-A2007, -A2015 | | 15A, AIC 200kA |
| 3G3MX2-A2022 | | 20A, AIC 200kA |
| 3G3MX2-A2037 | | 30A, AIC 200kA |
| 3G3MX2-A2055, -A2075 | | 60A, AIC 200kA |
| 3G3MX2-A2110, -A2150 | | 80A, AIC 200kA |
| 3G3MX2-A4004, -A4007, -A4015, -A4022 | | 10A, AIC 200kA |
| 3G3MX2-A4030, -A4040 | | 15A, AIC 200kA |
| 3G3MX2-A4055, -A4075 | | 30A, AIC 200kA |
| 3G3MX2-A4110, -A4150 | | 50A, AIC 200kA |

■Terminal symbols and Screw size

| Model No. | Screw Size | Required Torque(N-m) | Wire Range |
|--------------------------------------|------------|----------------------|------------------------------|
| 3G3MX2-AB001, -AB002, -AB004 | M3.5 | 1.0 | AWG16 (1.3 mm ²) |
| 3G3MX2-AB007 | M4 | 1.4 | AWG12 (3.3 mm ²) |
| 3G3MX2-AB015, -AB022 | M4 | 1.4 | AWG10 (5.3 mm ²) |
| 3G3MX2-A2001, -A2002, -A2004, -A2007 | M3.5 | 1.0 | AWG16 (1.3 mm ²) |
| 3G3MX2-A2015 | M4 | 1.4 | AWG14 (2.1 mm ²) |
| 3G3MX2-A2022 | M4 | 1.4 | AWG12 (3.3 mm ²) |
| 3G3MX2-A2037 | M4 | 1.4 | AWG10 (5.3 mm ²) |
| 3G3MX2-A2055, -A2075 | M5 | 3.0 | AWG6 (13 mm ²) |
| 3G3MX2-A2110 | M6 | 3.9 to 5.1 | AWG4 (21 mm ²) |
| 3G3MX2-A2150 | M8 | 5.9 to 8.8 | AWG2 (34 mm ²) |
| 3G3MX2-A4004, -A4007, -A4015 | M4 | 1.4 | AWG16 (1.3 mm ²) |
| 3G3MX2-A4022, -A4030 | M4 | 1.4 | AWG14 (2.1 mm ²) |
| 3G3MX2-A4040 | M4 | 1.4 | AWG12 (3.3 mm ²) |
| 3G3MX2-A4055, -A4075 | M5 | 3.0 | AWG10 (5.3 mm ²) |
| 3G3MX2-A4110, -A4150 | M6 | 3.9 to 5.1 | AWG6 (13 mm ²) |

Conformance to EC Directives

- It is necessary to use optional EMC filter to comply with EMC directive (EN61800-3).
- For earthing, selection of cable, and any other conditions for EMC compliance, please refer to the manual for installation.

■OMRON Corporation

Shiokoji Horikawa, Shimogyo-ku, Kyoto, 600-8530, Japan

■Omron Europe B.V.

Wegalaan 67-69, NL-2132 JD Hoofddorp, The Netherlands

Safety

For use of the drive as a safety device, to meet the requirements of the ISO13849-1, please refer to user's manual.

For KC Marking Only

A 급 기기(업무용 방송통신기자재)
이 기기는 업무용(A 급) 전자파적합기기로서 판매자 또는 사용자는 이 점을 주의하시기 바라며, 가정외의 지역에서 사용하는 것을 목적으로 합니다.

| |
|--|
| SUITABILITY FOR USE |
| Omron Companies shall not be responsible for conformity with any standards, codes or regulations which apply to the combination of the product in the buyer's application or use of the product. At buyer's request, Omron will provide applicable third party certification documents identifying ratings and limitations of use which apply to the product. This information by itself is not sufficient for a complete determination of the suitability of the product in combination with the end product, machine, system, or other application or use. Buyer shall be solely responsible for determining appropriateness of the particular product with respect to Buyer's application, product or system. Buyer shall take application responsibility in all cases. NEVER USE THE PRODUCT FOR AN APPLICATION INVOLVING SERIOUS RISK TO LIFE OR PROPERTY OR IN LARGE QUANTITIES WITHOUT ENSURING THAT THE SYSTEM AS A WHOLE HAS BEEN DESIGNED TO ADDRESS THE RISKS, AND THAT THE OMRON PRODUCT(S) IS PROPERLY RATED AND INSTALLED FOR THE INTENDED USE WITHIN THE OVERALL EQUIPMENT OR SYSTEM. |

OMRON

OMRON Corporation Industrial Automation Company
Tokyo, JAPAN

Contact: www.ia.omron.com

Regional Headquarters

OMRON EUROPE B.V.

Wegalaan 67-69, NL-2132 JD Hoofddorp
The Netherlands
Tel: (31)2356-81-300
Fax: (31)2356-81-388

OMRON ELECTRONICS LLC

One Commerce Drive Schaumburg, IL 60173-5302 U.S.A.
Tel: (1) 847-843-7900
Fax: (1) 847-843-7787

OMRON (CHINA) CO., LTD.

OMRON ASIA PACIFIC PTE. LTD.
No. 438A Alexandra Road # 05-05/08 (Lobby 2), Alexandra Technopark, Singapore 119967
Tel: (65) 6835-3011
Fax: (65) 6835-2711

Room 2211, Bank of China Tower, 200 Yin Cheng Zhong Road, Pu Dong New Area, Shanghai, 200120, China
Tel: (86) 21-5037-2222
Fax: (86) 21-5037-2200

Note: Specifications subject to change without notice.