

**HITACHI**

Inspire the Next

# Instruction Manual

## HITACHI Inverter L300P Series - ... HFE

Three phase input 200/400V class

NB601EX

# SAFETY

For the Best Results with **L300P** Series inverter, read this manual and all of the warning sign attached to the inverter carefully before installing and operating it, and follow the instructions exactly. Keep this manual handy for your quick reference.

## Definitions and Symbols

A safety instruction (message) is given with a hazard alert symbol and a signal word;

**WARNING** or **CAUTION**. Each signal word has the following meaning throughout this manual.



This symbol means hazardous high voltage. It used to call your attention to items or operations that could be dangerous to you or other persons operating this equipment.  
Read these message and follow these instructions carefully.



This is the "Safety Alert Symbol" This symbol is used to call your attention to items or operations that could be dangerous to you or other persons operating this equipment.  
Read these messages and follow these instructions carefully.



**WARNING**

### **WARNING**

Indicates a potentially hazardous situation which, if not avoided, can result in serious injury or death.



**CAUTION**

### **CAUTION**

Indicates a potentially hazardous situation which, if not avoided, can result in minor to moderate injury, or serious damage of product.

The matters described under  **CAUTION** may, if not avoided, lead to serious results depending on the situation. Important matters are described in **CAUTION** ( as well as **WARNING** ), so be sure to observe them.

**NOTE**

### **NOTE**

Notes indicate an area or subject of special merit, emphasizing either the product's capabilities or common errors in operation or maintenance.



**HAZARDOUS HIGH VOLTAGE**

Motor control equipment and electronic controllers are connected to hazardous line voltages. When servicing drives and electronic controllers, there might be exposed components with cases or protrusions at or above line potential. Extreme care should be taken to product against shock.

Stand on an insulating pad and make it a habit to use only one hand when checking components. Always work with another person in case an emergency occurs. Disconnect power before checking controllers or performing maintenance. Be sure equipment is properly grounded. Wear safety glasses whenever working on an electronic controllers or rotating electrical equipment.

## PRECAUTION

**⚠ WARNING** : This is equipment should be installed, adjusted and serviced by qualified electrical maintenance personal familiar with the construction and operation of the equipment and the hazards involved. Failure to observe this precaution could results in bodily injury.

**⚠ WARNING** : The user is responsible for ensuring that all driven machinery, drive train mechanism not supplied by Hitachi, Ltd., and process line material are capable of safe operation at an applied frequency of 150% of the maximum selected frequency range to the AC motor. Failure to do so can result in destruction of equipment and injury to personnel should a single point failure occur.

**⚠ WARNING** : For protection, install an earth leakage breaker with a high frequency circuit capable of large currents to avoid an unnecessary operation. The ground faults protection circuit is not designed to protect personal injury.

**⚠ WARNING** : HAZARD OF ELECTRICAL SHOCK. DISCONNECT INCOMING POWER BEFORE WORKING ON THIS CONTROL.

**⚠ WARNING** : SEPARATE MOTOR OVERCURRENT, OVERLOAD AND OVERHEATING PROTECTION IS REQUIRED TO BE PROVIDED IN ACCORDANCE WITH THE SAFETY CODES REQUIRED BY JURISDICTIONAL AUTHORITIES.

**⚠ CAUTION** : These instructions should be read and clearly understood before working on L300P series equipment.

**⚠ CAUTION** : Proper grounds, disconnecting devices and other safety devices and their location are the responsibility of the user and are not provided by Hitachi, Ltd.

**⚠ CAUTION** : Be sure to connect a motor thermal switch or overload devices to the L300P series controller to assure that inverter will shut down in the event of an overload or an overheated motor.

**⚠ CAUTION** : DANGEROUS VOLTAGE EXISTS UNTIL CHARGE LAMP IS OFF.

**⚠ CAUTION** : Rotating shafts and above ground electrical potentials can be hazardous. Therefore, it is strongly recommended that all electrical work conform to the National Electrical Codes and local regulations. Installation, alignment and maintenance should be performed only by qualified personnel. Factory recommended test procedures, included in the instruction manual, should be followed. Always disconnect electrical power before working on the unit.

### **NOTE : POLLUTION DEGREE 2**

The inverter must be used environment of the degree 2.

Typical constructions that reduce the possibility of conductive pollution are;

- 1) The use of an un-ventilated enclosure
- 2) The use of a filtered ventilated enclosure when the ventilation is fan forced that is, ventilation is accomplished by one or more blowers within the enclosure that provide a positive intake and exhaust.

## Cautions for EMC (Electromagnetic Compatibility)

You are required to safety the EMC directive (89/336/EEC) when using the L300P inverter in a European country. To safety the EMC directive and to comply with standard, follows the checklist below.

**⚠ WARNING** : This equipment should be installed, adjusted, and serviced by qualified personal familiar with construction and operation of the equipment and the hazards involved. Failure to observe this precaution could result in bodily injury.

1. The power supply to L300P inverter must meet these specifications:
  - a. Voltage fluctuation +/-10% or less.
  - b. Voltage imbalance +/-3% or less.
  - c. Frequency variation +/-4% or less.
  - d. Voltage distortion THD = 10% or less.
2. Installation measure:
  - a. Use a filter designed for L300P inverter.
3. Wiring
  - a. Shielded wire (screened cable) is required for motor wiring, and the length must be less than 20 meters.
  - b. The carrier frequency setting must be less than 3 kHz to satisfy EMC requirements.
  - c. Separate the main circuit from the signal/process circuit wiring.
  - d. In case of remote operating with connector cable, the inverter does not conform to EMC.
4. Environmental conditions – when using a filter, follow these guidelines:
  - a. Ambient air temperature: -10 - +40 °C.
  - b. Humidity: 20 to 90% RH (non-condensing)
  - c. Vibration: 5.9 m/sec<sup>2</sup> (0.6 G) 10 – 55Hz. (L300P-110-300LF/110-300HF)  
2.94 m/sec<sup>2</sup> (0.3 G) 10 – 55Hz. (L300P-370-750LF/370-1320HF)
  - d. Location: 1000meters or less altitude, indoors (no corrosive gas or dust)

## Conformity to the Low Voltage Directive (LVD)

The protective enclosure must conform to the Low Voltage Directive.

The inverter can conform to the LVD by mounting into a cabinet or by adding covers as follows.

### 1. Cabinet and Cover

The inverter must be installed into a cabinet which has the protection degree of Type IP2X. In addition the top surfaces of cabinet that are easily accessible shall meet at least the requirements of the Protective Type IP4X, or which is constructed to prevent small objects from entering inverter.

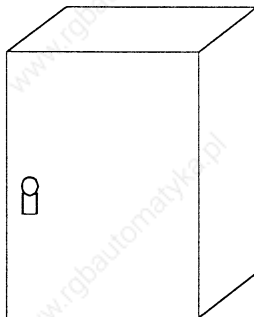

IP4X cabinet

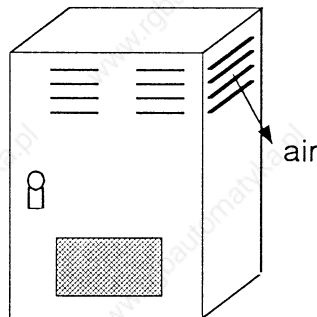

IP20 with louver

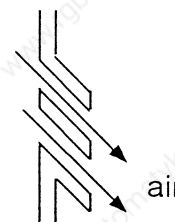





Fig. Inverter cabinet

# UL Warnings and Cautions Manual for L300P series

**This auxiliary instruction manual should be delivered to the end user.**

## 1. Wiring Warnings for Electrical Practices and Wire Specifications

- (1)  **WARNING :** "Use 60/75 °C CU wire only" or equivalent.
- (2)  **WARNING :** "Open Type Equipment."  
For models with L300P 900-1320H.
- (3)  **WARNING :** "Suitable for use on a circuit capable or delivering not more than 10,000 rms symmetrical amperes, 240 V maximum." For models with suffix L.
- (4)  **WARNING :** "Suitable for use on a circuit capable or delivering not more than 10,000 rms symmetrical amperes, 480 V maximum." For models with suffix H.

## 2. Tightening Torque and Wire Range

- (1)  **WARNING :** Tightening torque and wire range for field wiring terminals are marked adjacent to the terminal or on the wiring diagram.

Model Name	Tightening Torque [N•m]	Wire Range (AWG)
L300P-110L	4.9	4
L300P-150L	4.9	2
L300P-185L	4.9	1
L300P-220L	8.8	1/0
L300P-300L	8.8	2/0
L300P-370L	8.8	3/0 or 2 parallel of 1 AWG
L300P-450L	13.7	250kcmil or 2 parallel of 1 AWG (75°C)
L300P-550L	13.7	350kcmil or 2 parallel of 1/0 AWG
L300P-750L	13.7	350kcmil or 2 parallel of 1/0 AWG
L300P-110H	4.9	8
L300P-150H	4.9	6
L300P-185H	4.9	6
L300P-220H	4.9	4
L300P-300H	4.9	3
L300P-370H	4.9	1

L300P-450H	8.8	1
L300P-550H	8.8	1/0
L300P-750H	8.8	250kcmil or 2 parallel of 1 AWG (75°C)
L300P-900H	13.7	250kcmil or 2 parallel of 1 AWG (75°C)
L300P-1100H	13.7	350kcmil or 2 parallel of 1/0 AWG
L300P-1320H	13.7	350kcmil or 2 parallel of 1/0 AWG

### 3.Circuit Breaker / Fuse Size

- (1)  **WARNING :** Distribution fuse/circuit breaker size marking is included in the manual to indicate that the unit shall be connected with an UL Listed inverse time circuit breaker, rated 600 V with the current ratings or an UL Listed fuse as shown in the table below.

<u>Model Name</u>	<u>Tightening Torque [N•m]</u>	<u>Wire Range (AWG)</u>
L300P-110L	60	60
L300P-150L	70	70
L300P-185L	90	90
L300P-220L	100	100
L300P-300L	150	150
L300P-370L	175	175
L300P-450L	200	200
L300P-550L	250	250
L300P-750L	300	300
L300P-110H	30	30
L300P-150H	35	35
L300P-185H	50	50
L300P-220H	50	50
L300P-300H	70	70
L300P-370H	80	80
L300P-450H	100	100
L300P-550H	125	125
L300P-750H	150	150
L300P-900H	-	200
L300P-1100H	-	225
L300P-1320H	-	300

## 4.Others

- (1)  **WARNING :** "Field wiring connection must be made by an UL Listed and CSA Certified closed-loop terminal connector sized for the wire gauge involved. Connector must be fixed using the crimp tool specified by the connector manufacturer.", or equivalent wording included in the manual.

## Revision History Table

No.	Revision Contents	The Date of Issue	Operation Manual No.
1	Initial Release of Manual NB601AX	Sep. 1999	NB601AX
2	The data 02 of the command b004 was added The carrier frequency of the capacity 37kW and more was added.	Oct. 1999	NB601BX
3	The specification of the capacity 75kW and more was added.	Jun. 2000	NB601CX
4	A skipped number.		NB601DX
5	The specification of the capacity 90-132kW and more was added	Feb. 2001	NB601EX



## 1. Installation

 **CAUTION**

- |   |                    |
|---|--------------------|
| <ul style="list-style-type: none"> <li>• Be sure to install the unit on flame resistant material such as metal.<br/>Otherwise, there is a danger of fire.</li> </ul>  | <p>..... p.2-2</p> |
| <ul style="list-style-type: none"> <li>• Be sure not to place anything inflammable in the vicinity.<br/>Otherwise, there is a danger of fire.</li> </ul>  | <p>..... p.2-2</p> |
| <ul style="list-style-type: none"> <li>• Do not carry unit by top cover, always carry by supporting base of unit.<br/>There is a risk of falling and injury.</li> </ul>   | <p>..... p.2-2</p> |
| <ul style="list-style-type: none"> <li>• Be sure not to let the foreign matter enter such as cut wire refuse, spatter from welding, iron refuse, wire, dust, etc.<br/>Otherwise, there is a danger of fire.</li> </ul>  | <p>..... p.2-5</p> |
| <ul style="list-style-type: none"> <li>• Be sure to install it in a place which can bear the weight according to the specifications in the text. (Chapter 6. Specifications)<br/>Otherwise, it may fall and there is a danger of injury.</li> </ul>   | <p>..... p.2-1</p> |
| <ul style="list-style-type: none"> <li>• Be sure to install the unit on a perpendicular wall which is not subject to vibration.<br/>Otherwise, it may fall and there is a danger of injury.</li> </ul>  | <p>..... p.2-3</p> |
| <ul style="list-style-type: none"> <li>• Be sure not to install and operate an inverter which is damaged or parts of which are missing.<br/>Otherwise, there is a danger of injury.</li> </ul>  | <p>..... p.2-2</p> |
| <ul style="list-style-type: none"> <li>• Be sure to install it in a room which is not exposed to direct sunlight and is well ventilated. Avoid environments which tend to be high in temperature, high in humidity or to have dew condensation, as well as places with dust, corrosive gas, explosive gas, inflammable gas, grinding-fluid mist, salt damage, etc.<br/>Otherwise, there is a danger of fire.</li> </ul> | <p>..... p.2-2</p> |

## 2.Wiring

### **WARNING**

- Be sure to ground the unit.  
Otherwise, there is a danger of electric shock and/or fire. .... p.2-9
- Wiring work shall be carried out by electrical experts.  
Otherwise, there is a danger of electric shock and/or fire. .... p.2-6
- Implement wiring after checking that the power supply is off.  
It might incur electric shock and/or fire. .... p.2-8
- After installing the main body, carry out wiring.  
Otherwise, there is a danger of electric shock and/or injury. .... p.2-5
- Do not remove the rubber bush. (11 to 75kW)  
Due to the possibility that a wire may be damaged, shorted or may have  
a ground fault with the edge of the wiring cover. .... p.2-4

### **CAUTION**

- Make sure that the input voltage is:  
Three phase 200 to 240V 50/60Hz (for models with suffix L) .... p.2-6  
Three phase 380 to 480V 50/60Hz (for models with suffix H)
- Be sure not to input a single phase.  
Otherwise, there is a danger of fire. .... p.2-8
- Be sure not to connect AC power supply to the output terminals(U, V, W).  
Otherwise, there is a danger of injury and/or fire. .... p.2-5
- Be sure not to connect the resistor to DC terminals (PD,P and N) directly.  
Otherwise, there is a danger of fire. .... p.2-5
- Be sure to set the earth leakage breaker or the fuse(s) (the same phase as  
the main power supply) in the operation circuit. .... p.2-12  
Otherwise, there is a danger of fire.
- As for motor leads, earth leakage breakers and electromagnetic contactors,  
be sure to use the equivalent ones with the specified capacity (rated). .... p.2-12  
Otherwise, there is a danger of fire.
- Do not stop operation by switching off the electromagnetic contactors on the  
primary or secondary sides of the inverter. .... p.2-6  
Otherwise, there is a danger of injury and/or machine breakage.
- Fasten the screws with the specified fastening torque. Check so that there  
is no loosening of screws. .... p.2-12  
Otherwise, there is a danger of fire.

### 3. Control and operation

 **WARNING**

- While the inverter is energized, be sure not to touch the main terminal or to check the signal or put on/off wire and/or connector. . . . . p.3-1  
Otherwise, there is a danger of electric shock.
- Be sure to turn on the input power supply after closing the front case. . . . . p.3-1  
While being energized, be sure not to open the front case.  
Otherwise, there is a danger of electric shock.
- Be sure not to operate the switches with wet hands. . . . . p.3-1  
Otherwise, there is a danger of electric shock.
- While the inverter is energized, be sure not to touch the inverter terminals even during stoppage. . . . . p.3-1  
Otherwise, there is a danger of electric shock.
- If the retry mode is selected, it may suddenly restart during the trip stop. Be sure not to approach the machine. (Be sure to design the machine so that personnel safety will be secured even if it restarts.) . . . . . p.3-1  
Otherwise, there is a danger of injury.
- Be sure not to select retry mode for up and down equipment or traveling equipment, because there is output free-running mode in term of retry. . . . . p.3-1  
Otherwise, there is a danger of injury and/or machine breakage.
- Even if the power supply is cut for a short period of time, it may restart operation after the power supply is recovered if the operation command is given. If it may incur danger to personnel, be sure to make a circuit so that it will not restart after power recovery. . . . . p.3-1  
Otherwise, there is a danger of injury.
- The Stop Key is effective only when the function is set. Be sure to prepare the Key separately from the emergency stop. . . . . p.3-1  
Otherwise, there is a danger of injury.
- After the operation command is given, if the alarm reset is conducted, it will restart suddenly. Be sure to set the alarm reset after checking the operation command is off. . . . . p.3-1  
Otherwise, there is a danger of injury.
- Be sure not to touch the inside of the energized inverter or to put a bar into it. . . . . p.3-1  
Otherwise, there is a danger of electric shock and/or fire.

## SAFETY PRECAUTIONS

### CAUTION

- Cooling fin will have high temperature. Be sure not to touch them. .... p.3-2  
Otherwise, there is a danger of getting burned.
- Low to high speed operation of the inverter can be easily set. Be sure to operate it after checking the tolerance of the motor and machine. .... p.3-2  
Otherwise, there is a danger of injury.
- Install external break system if needed. .... p.3-2  
Otherwise, there is a danger of injury.
- If a motor is operated at a frequency higher than standard setting value(50Hz/60Hz),be sure to check the speeds of the motor and the machine with each manufacturer, and after getting their consent, operate them. .... p.3-2  
Otherwise, there is a danger of machine breakage.
- Check the following before and during the test run.  
Otherwise, there is a danger of machine breakage.
  - Was the direction of the motor correct? .... p.3-2
  - Was the inverter tripped during acceleration or deceleration? .... p.3-2
  - Were the rpm and frequency meter correct?
  - Were there any abnormal motor vibrations or noise?

## 4.Maintenance, inspection and part replacement

### WARNING

- After a lapse of more than 10 minutes after turning off the input power supply, perform the maintenance and inspection. .... p.5-1  
Otherwise, there is a danger of electric shock.
- Make sure that only qualified persons will perform maintenance, inspection and part replacement. (Before starting the work, remove metallic objects from your person (wristwatch, bracelet, etc.) .... p.5-1  
(Be sure to use tools protected with insulation.)  
Otherwise, there is a danger of electric shock and/or injury.

## 5.Others

### WARNING

- Never modify the unit.  
Otherwise, there is a danger of electric shock and/or injury.

**TABLE OF CONTENTS**

**Chapter 1 General Descriptions**

1.1 Inspection upon Unpacking..... 1-1

    1.1.1 Inspection of the unit..... 1-1

    1.1.2 Instruction manual..... 1-1

1.2 Question and Warranty of the Unit..... 1-2

    1.2.1 Request upon asking..... 1-2

    1.2.2 Warranty for the unit..... 1-2

1.3 Appearance..... 1-3

    1.3.1 Appearance and Names of Parts..... 1-3

**Chapter 2 Installation and Wiring**

2.1 Installation..... 2-1

    2.1.1 Installation..... 2-2

    2.1.2 Blind cover of wiring parts ..... 2-4

2.2 Wiring..... 2-5

    2.2.1 Terminal Connection Diagram..... 2-6

    2.2.2 Main circuit wiring..... 2-8

    2.2.3 Terminal Connection Diagram..... 2-13

    2.2.4 Digital operator wiring..... 2-15

**Chapter 3 Operation**

3.1 Operation..... 3-3

3.2 Test Run..... 3-4

**Chapter 4 Explanation of Function**

4.1 About Digital Operator (OPE-SR)..... 4-1

4.2 Code list..... 4-5

4.3 Explanation of function..... 4-10

    4.3.1 Monitor mode

        Output frequency monitor, Output current monitor, Operation direction monitor

        PID feedback monitor ..... 4-10

        Intelligent input monitor, Intelligent output monitor ..... 4-11

        Frequency conversion monitor, Output voltage monitor, Input electric power monitor....4-12

        Accumulated time monitor on Run, Power ON time monitor, Trip time monitor, Trip monitor.....4-13

4.3.2 Function mode

Setting of the output frequency, Operation direction, Selection with limits of operation direction,

Frequency command selection .....	4-14
Operation command selection, Selection on stop, Selection of the stop key .....	4-15
Adjustable time .....	4-16
Base frequency .....	4-17
Maximum frequency, Carrier frequency .....	4-18
External analog input .....	4-19
Input frequency Start/End .....	4-20
Setting analog input filter, Output voltage gain .....	4-21
Control system (V/f Characteristic) .....	4-22
Torque boost .....	4-24
Direct current braking (DB) .....	4-25
Frequency limiter .....	4-28
Frequency jump function, Acceleration stop function .....	4-29
PID function .....	4-30
Automatic energy-saving operation function .....	4-31
Two-stage acceleration and deceleration function (2CH) .....	4-32
Acceleration and deceleration pattern .....	4-33
Instantaneous power failure / under-voltage .....	4-34
Open phase protection function selection, Electronic thermal function .....	4-36
Overload restriction / Overload advance notice .....	4-38
Start frequency, Reduced voltage start selection .....	4-40
BRD (dynamic braking) function, Cooling fan operating selection .....	4-41
Intelligent input terminal setting, Input terminal a/b (NO/NC) selection .....	4-42
Multi-speed operation function .....	4-43
Jogging operation (JG) .....	4-44
Second control function (SET), Software lock mode selection (SFT) .....	4-45
Free-run stop (FRS) .....	4-46
Commercial power source switching (CS) .....	4-47
Reset (RS) .....	4-48
Unattended start protection (USP), UP / DOWN selection (UP/DWN).....	4-49
External trip (EXT), 3 Wire input function (STA, STP, F/R) .....	4-50
Intelligent output terminal setting .....	4-51
Intelligent output terminal a/b (NO/NC) selection .....	4-52
Signal during run (RUN), Frequency arrival signal (FA1, FA2, FA3) .....	4-53
RUN time/power ON time over (RNT/ONT), Force operation ope function .....	4-55
FM terminal .....	4-56

## Table of Contents

AM terminal, AML terminal, External thermistor (TH) .....	4-57
Initialization setting .....	4-58
Display selection .....	4-59
Stabilized factor, Operation selection on option error, Motor constant .....	4-60
Communication function .....	4-61
<b>4.4 Protection function list.....</b>	<b>4-75</b>
4.4.1 Protection function.....	4-75
4.4.2 Trip monitor display.....	4-78
4.4.3 Warning Monitor display.....	4-79
<b>Chapter 5 Maintenance, Inspection</b>	
<b>5.1 Precaution for Maintenance/Inspection.....</b>	<b>5-1</b>
5.1.1 Daily inspection.....	5-1
5.1.2 Cleaning.....	5-1
5.1.3 Regular inspection.....	5-1
<b>5.2 Daily inspection and regular inspection .....</b>	<b>5-2</b>
<b>5.3 Megger test.....</b>	<b>5-3</b>
<b>5.4 Withstand Voltage test.....</b>	<b>5-3</b>
<b>5.5 The method to check Inverter, converter part.....</b>	<b>5-4</b>
<b>5.6 Capacitor Life Curve.....</b>	<b>5-5</b>
<b>Chapter 6 Specification</b>	
<b>6.1 Standard specification list.....</b>	<b>6-1</b>
<b>6.2 Dimension.....</b>	<b>6-2</b>

## 1.1 Inspection upon Unpacking

### 1.1.1 Inspection of the unit

Open the package and pick out the inverter, please check the following item.

If you discover any unknown parts or the unit is in bad condition, please contact your supplier or the local Hitachi Distributor.

- (1) Make sure that there was no damage (injury, falling or dents in the body) during transportation of the unit.
- (2) After unpacking the unit, make sure that the package contains one operation manual for the Inverter.
- (3) Make sure that the product is the one you ordered by checking the specification label.

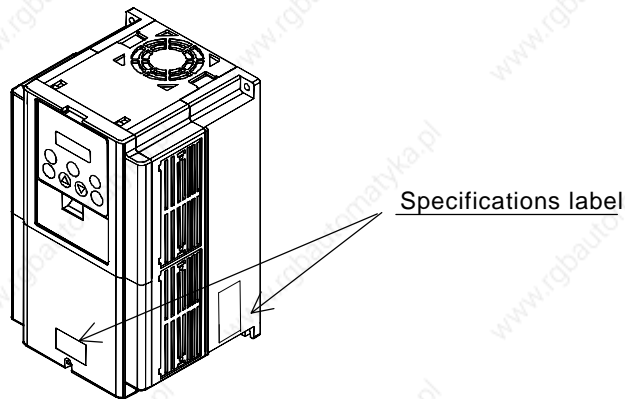

Picture 1-1 Position of specification label

		<b>HITACHI</b>			
Inverter model	→	Model: L300P-110HF			
Maximum applicable motor	→	kW/(HP): 15/(20)			
Input ratings	→	Input/Entrée: 50, 60Hz V 1 Ph A			
		50, 60Hz	400-480 V	3 Ph	25 A
Output ratings	→	Output/Sortie: 0, 1-400Hz 400-480 V 3 Ph 23 A			
Production number	→	MFG No. 94AT1234590001		Date: 9904	
		Hitachi, Ltd. MADE IN JAPAN NE16989 -29			

Picture 1-2 Contents of specifications label

### 1.1.2 Instruction manual

This instruction manual is the manual for the HITACHI Inverter L300P Series.

Before operation of the Inverter, read the manual carefully. After Reading this manual, keep it to hand for future reference.

When using optional units for this inverter; please refer to the instruction manuals packed with the optional units.

This instruction manual should be delivered to the end user.



### 1.2 Question and Warranty of the Unit

#### 1.2.1 Request upon asking

If you have any questions regarding damage to the unit, unknown parts or for general inquiries please contact your supplier or the local Hitachi Distributor with the following information.

- (1) Inverter Model
- (2) Production Number (MFG No.)
- (3) Date of Purchase
- (4) Reason for Calling
  - Damaged part and its condition etc.
  - Unknown parts and their contents etc.

#### 1.2.2 Warranty for the unit

The warranty period of the unit is one year after the purchase date.

However within the warranty period, the warranty will be void if the fault is due to;

- (1) Incorrect use as directed in this manual, or attempted repair by unauthorized personnel
- (2) Any damage sustained, other than from transportation (Which should be reported immediately)
- (3) Using the unit beyond the limits of the specification.
- (4) Natural Disasters: Earthquakes, Lightning, etc

The warranty is for the inverter only, any damage caused to other equipment by malfunction of the inverter is not covered by the warranty.

Any examination or repair after the warranty period (one year) is not covered. And within the warranty period any repair and examination which results in information showing the fault was caused by any of the items mentioned above, the repair and examination cost are not covered.

If you have any questions regarding the warranty please contact either your supplier or the local Hitachi Distributor.

Please refer to the back cover for a list of the local Hitachi Distributors.

1.3 Appearance

1.3.1 Appearance and Names of Parts

Appearance from the front

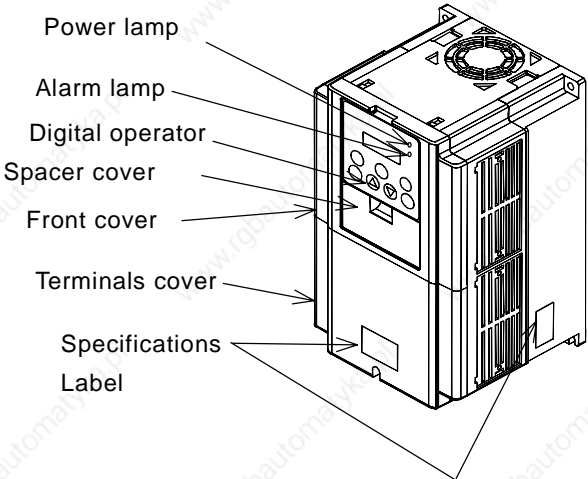

Front cover removed

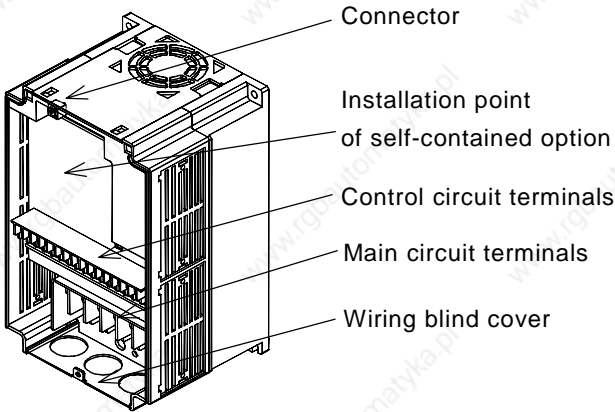

(Note)When you use cable for remote operation, please remove connector.

### 2.1 Installation

#### **CAUTION**

- Be sure to install the unit on flame resistant material such as metal.  
Otherwise, there is a danger of fire.
- Be sure not to place anything inflammable in the vicinity.  
Otherwise, there is a danger of fire.
- Do not carry unit by top cover, always carry by supporting base of unit.  
There is a risk of falling and injury.
- Be sure not to let the foreign matter enter such as cut wire refuse, spatter from welding, iron refuse, wire, dust, etc.  
Otherwise, there is a danger of fire.
- Be sure to install it in a place which can bear the weight according to the specifications in the text.  
(Chapter 6. Specifications)  
Otherwise, it may fall and there is a danger of injury.
- Be sure to install the unit on a perpendicular wall which is not subject to vibration.  
Otherwise, it may fall and there is a danger of injury.
- Be sure not to install and operate an inverter which is damaged or parts of which are missing.  
Otherwise, there is a danger of injury.
- Be sure to install it in a room which is not exposed to direct sunlight and is well ventilated. Avoid environments which tend to be high in temperature, high in humidity or to have dew condensation, as well as places with dust, corrosive gas, explosive gas, inflammable gas, grinding-fluid mist, salt damage, etc.  
Otherwise, there is a danger of fire.

### 2.1.1 Installation

#### 1. Transportation

This inverter has plastic parts. So handle with care.

Do not over tighten the wall mounting fixings as the mountings may crack, causing is a risk of falling.

Do not install or operate the inverter if there appears to be damage or parts missing.

#### 2. Surface for Mounting of Inverter

The temperature of the Inverter heatsink can become very high (the highest being about 150°C). The surface, which you are mounting the Inverter onto, must be made of a non-flammable material (i.e. steel) due to the possible risk of fire. Attention should also be made to the air gap surrounding the Inverter. Especially when there is a heat source such as a braking resistor or a reactor.

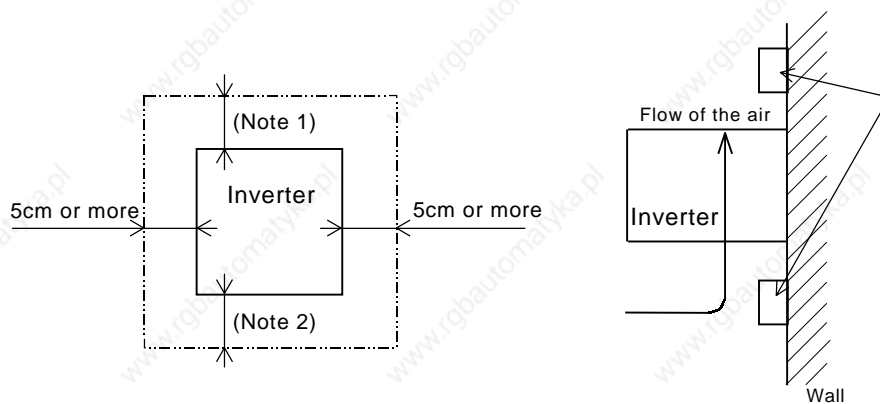

Keep the space enough not to be prevented the ventilation of cooling by up and down of wiring duct.

(Note 1) 10cm or more for 11 to 75kW

30cm or more for 90 to 132kW

(Note 2) 10cm or more for 11 to 75kW

30cm or more for 90 to 132kW

But for exchanging the DC bus capacitor, take a distance.

10cm or more for 11 to 15kW

22cm or more for 18.5 to 75kW

30cm or more for 90 to 132kW

#### 3. Operating Environment - Ambient Temperature

The ambient temperature surrounding the Inverter should not exceed the allowable temperature range (-10 to 40°C). When using at 50°C of ambient air temperature, the rated output current will be reduced. (P.4-18)

The temperature should be measured in the air gap surrounding the Inverter, shown in the diagram above. If the temperature exceeds the allowable temperature, the component life will become shortened especially in the case of the Capacitors.

#### 4. Operating Environment - Humidity

The humidity surrounding the Inverter should be within the limit of the allowable percentage range (20% to 90%). Under no circumstances should the Inverter be in an environment where there is the possibility of moisture entering the Inverter.

Also avoid having the Inverter mounted in a place that is exposed to the direct sunlight.

## Chapter 2 Installation and Wiring

### 5. Operating Environment - Air

Install the Inverter avoiding any place that has dust, corrosive gas, explosive gas, combustible gas, mist of coolant and sea damage.

### 6. Mounting Position

Mount the Inverter in a vertical position using screws or bolts. The surface you mount onto should also be free from vibration and can easily hold the weight of the Inverter.

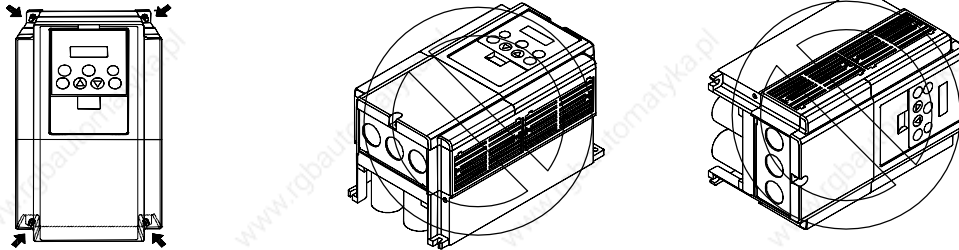

### 7. Ventilation within an Enclosure

If you are installing one or more Inverters in an enclosure a ventilation fan should be installed. Below is a guide to the positioning of the fan to take the airflow into consideration. The positioning of Inverter, cooling fans and air intake is very important. If these positions are wrong, airflow around the Inverter decreases and the temperature surrounding the Inverter will rise. So please make sure that the temperature around is within the limit of the allowable range.

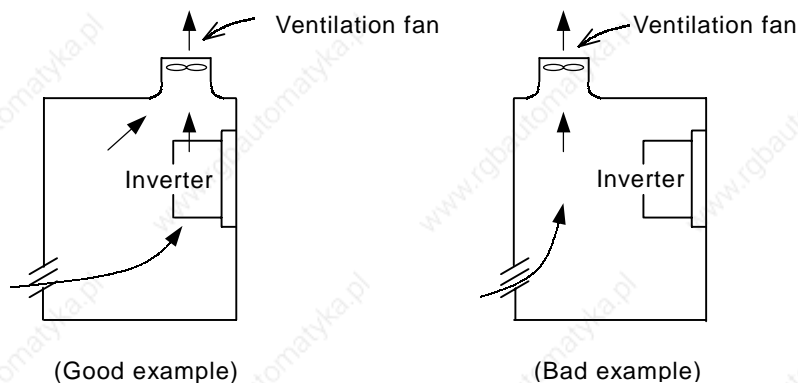

### 8. External cooling of Inverter

It is possible to install the inverter so that the heatsink is out of the back of the enclosure. This method has two advantages, cooling of the inverter is greatly increased and the size of the enclosure will be smaller.

To install it with the heatsink out of the enclosure, a metal fitting option is required to ensure heat transfer.

Do not install in a place where water, oil mist, flour and dust etc can come in contact with the inverter as there are cooling fans fitted to the heatsink.

### 9. Approximate loss for each capacity

Inverter capacity (kW)	11	15	18.5	22	30	37	45	55	75	90	110	132
70% of rated output (W)	435	575	698	820	1100	1345	1625	1975	2675	3375	3900	4670
100% of rated output (W)	600	800	975	1150	1550	1900	2300	2800	3800	4800	5550	6650
100% of rated efficiency(%)	94.8	94.9	95	95	95	95.1	95.1	95.1	95.2	95.2	95.2	95.2

### 2.1.2 Blind cover of wiring parts (11 to 75kW)

#### (1) Cable entry through Rubber Bushes

The wiring should be done after making a cut in the rubber bushes with nippers or cutters.

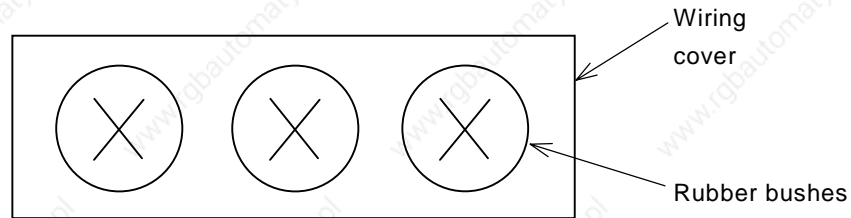

#### (2) Cable entry through Conduit

After taking out the rubber bushes, connect the conduit.

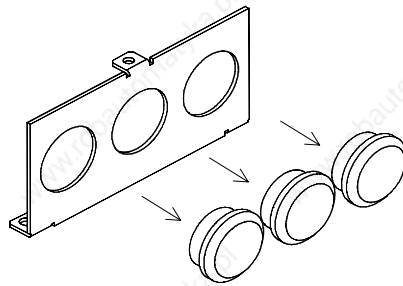

(Note) Except for when connecting conduit, Do not take out the rubber bushes. It is possible that the wiring insulation is broken and a possible earth fault is caused.

### 2.2 Wiring

#### **WARNING**

- Be sure to ground the unit.  
Otherwise, there is a danger of electric shock and/or fire.
- Wiring work shall be carried out by electrical experts.  
Otherwise, there is a danger of electric shock and/or fire.
- Implement wiring after checking that the power supply is off.  
It might incur electric shock and/or fire.
- After installing the main body, carry out wiring.  
Otherwise, there is a danger of electric shock and/or injury.
- Do not remove the rubber bush. (11 to 75kW)  
Due to the possibility that a wire may be damaged, shorted or may have a ground fault with the edge of the wiring cover.

#### **CAUTION**

- Make sure that the input voltage is:  
Three phase 200 to 240V 50/60Hz (for models with suffix L)  
Three phase 380 to 480V 50/60Hz (for models with suffix H)
- Be sure not to input a single phase.  
Otherwise, there is a danger of fire.
- Be sure not to connect AC power supply to the output terminals(U, V, W).  
Otherwise, there is a danger of injury and/or fire.
- Be sure not to connect the resistor to DC terminals (PD,P and N) directly.  
Otherwise, there is a danger of fire.
- Be sure to set the earth leakage breaker or the fuse(s) (the same phase as the main power supply) in the operation circuit.  
Otherwise, there is a danger of fire.
- As for motor leads, earth leakage breakers and electromagnetic contactors, be sure to use the equivalent ones with the specified capacity (rated).  
Otherwise, there is a danger of fire.
- Do not stop operation by switching off the electromagnetic contactors on the primary or secondary sides of the inverter.  
Otherwise, there is a danger of injury and/or machine breakage.
- Fasten the screws with the specified fastening torque. Check so that there is no loosening of screws.  
Otherwise, there is a danger of fire.

2.2.1 Terminal Connection Diagram (sink type)

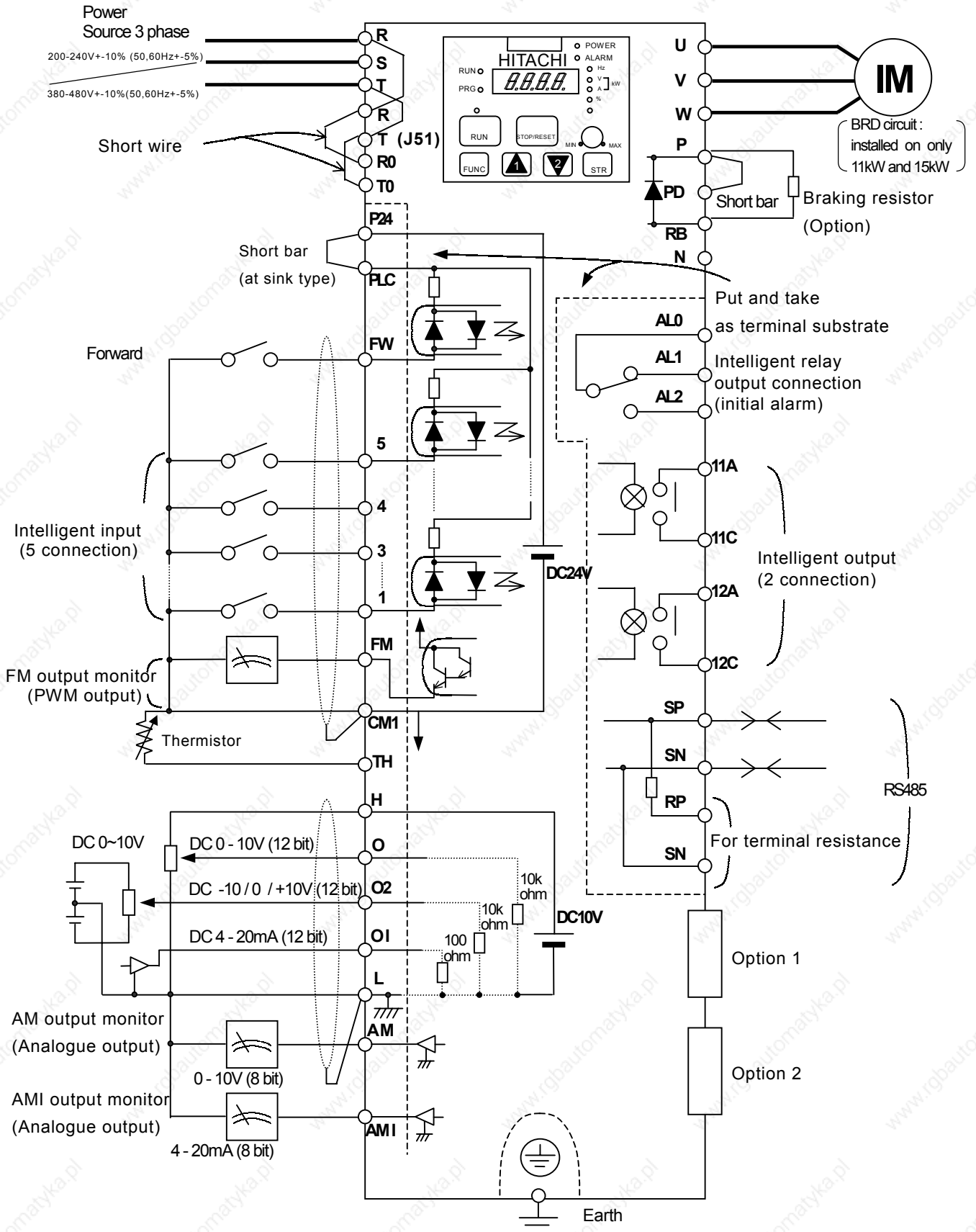



2.2.1 Terminal Connection Diagram (source type)

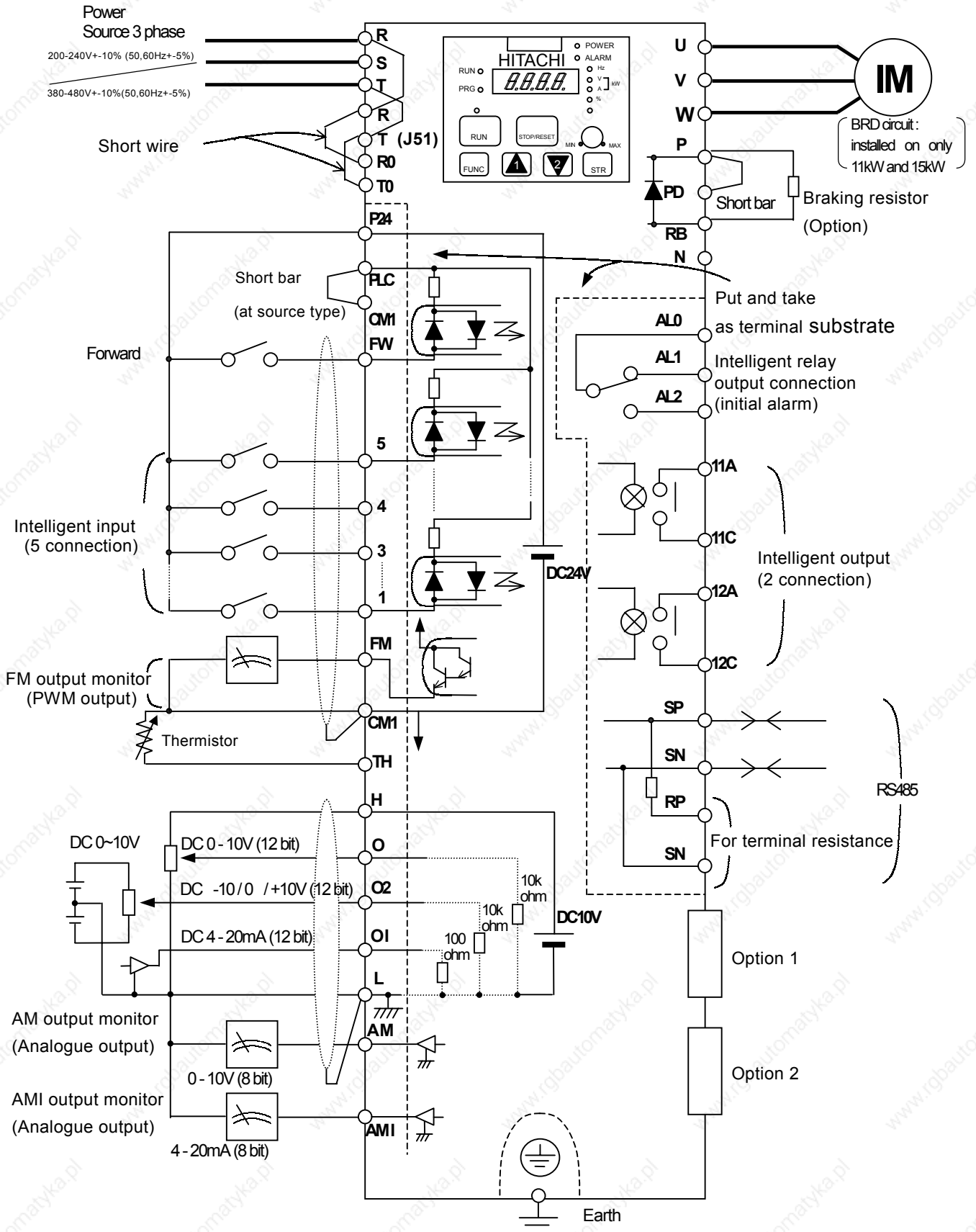

## Chapter 2 Installation and Wiring

### (1) Explanation of main circuit terminals

Symbol	Terminal Name	Explanation of contents
R, S, T (L1,L2,L3)	Main power	Connect alternating power supply. When using regenerative converter and HS900 series, don't connect.
U, V, W (T1,T2,T3)	Inverter output	Connect three-phase motor.
PD, P (+1,+)	D.C.reactior	Remove the short bar between PD and P, connect optional Power factor reactor (DCL-XX).
P, RB (+,RB)	External braking resistor	Connect optional External braking resistor. (Installed on 11kW and 15kW)
P, N (+,-)	External Regenerative unit	Connect optional Regenerative braking unit (BRD-XX).
G ⊕	Inverter earth terminals	It is earth terminals of inverter case.

### (2) Explanation of control circuit terminal

	Symbol	Terminal Name	Explanation of contents		
Analogue	Power Source	L	Analogue power common It is common terminal of frequency command signal (O, O2, OI) and analogue output, AM, AMI. Don't earth.		
		H	Frequency power It is the DC+10V power for terminals. Allowable load current 20mA		
	Frequency setting	O	Frequency command power terminal (voltage) When inputting DC 0 - 10V, it is maximum frequency on 10V. When maximum frequency is expected to be on being less than 10V, set with A014. Input Impedance 10k ohm Allowable maximum voltage 12V		
		O2	Frequency command support (voltage) When inputting DC 0 - +10V, this signal is added to frequency command of O or OI terminal. Input Impedance 10k ohm Allowable maximum load voltage +-12V		
		OI	Frequency command Terminal (current) When inputting DC 4 - 20mA, 20mA is maximum frequency. When only At terminal is ON, this input signal is effective. Input Impedance 100 ohm Allowable maximum current 24mA		
	Monitor	AM	Digital monitor (voltage) Output one selected from monitor item output frequency, output current, LAD frequency output voltage, input electric power, and electric thermal rate. Allowable maximum current 2mA		
		AMI	Analogue monitor (current) Allowable output less than Impedance 250 ohm		
		FM	Digital monitor (voltage) Output the output frequency with digital besides above monitor. Allowable maximum current 1.2mA Maximum frequency 3.6kHz		
	Digital (connection)	Power Source	P24	Interface power It is DC24V power for connection input signal. When selecting source logic, it's for connection input common. Allowable maximum output current 100mA	
			CM1	Interface power common The common terminal is FW terminal, 1 - 5 terminal, TH terminal, FM terminal, Don't earth.	
PLC			Intelligent input common Change sink type and source type by short bar on control terminals. P24-PLC : Sink type CM1-PLC : Source type		
Input Signal Operation/function /Setting etc.		Setting	FW	Forward command About FW signal, ON is Forward and OFF is stop command. Allowable maximum voltage 27V Input ON condition of terminal voltage Over 18V Input OFF condition of terminal voltage Under 3V Input impedance 4.7k ohm	
			1 2 3 4 5	Intelligent input Select 5 functions from 33 functions, and divide between 1 terminal and 5 terminals.	
		Output Signal Condition/Alarm	11A	Intelligent output terminal 11 Select output function and assign it output terminal 11	Contact specification Maximum AC250V,5A (R load) 1A (L load)
			11C	Common terminal It is common terminal of intelligent output terminal 11.	
			12A	Intelligent output terminal 12 Select output function and assign it output terminal 12	DC30V,5A,(R load) 1A (L load) minimum DC1V,1mA
12C			Common terminal It is common terminal of intelligent output terminal 12		
AL1 AL2		Alarm output terminal Assign output function. Output is c contact. Contact specification Maximum AL1-AL0 AC250V,2A (R load) 0.2A (L load)	AL2-AL0 AC250V,1A,(R load) 0.2A (L load) minimum AC100V,10mA		
AL0	Common terminal It is common terminal of alarm output terminal.				
Analogue Sensor	TH	Thermistor input terminal When a Thermistor signal is inputted to terminals TH and CM1, the Inverter checks for over-temperature and will cause trip event and turn off output motor Allowable maximum resistance 10k ohm ,minimum power 100mW			

### 2.2.2 Main circuit wiring

#### (1) Warning on wiring

When carrying out work on the Inverter wiring make sure to wait for at least ten minutes before you remove the cover. Making sure to check that the charge lamp is not illuminated. A final check should always be made with a voltage meter. After removing the power supply, there is a time delay before the capacitors will dissipate their charge.

#### 1. Main power terminals(R, S, T)

- Connect the main power terminals (R, S, and T) to the power supply through a electromagnetic contactor or an earth-leakage breaker.
- We recommend connecting the electromagnetic contactor to the main power terminals. Because when the protective function of inverter operates, it isolates the powers supply and prevent the spread of damages and accidents.
- This unit is for the three-phase power supply. It isn't for the single-phase power supply. If you require a single-phase power supply unit, please contact us.
- Don't operate with on/off of the switch set up in the converter side and the inverter side. Do an operation stop by the operation order (FW/RV) terminals
- This inverter becomes the following condition at the time of open phase because open phase protection is being made ineffective by the early data.

R phase or T phase, open phase condition: The power isn't turned on, and it doesn't operate.

S phase, open phase condition: It becomes single-phase operation condition. Trip operation such as a deficiency voltage or over current may be done.

Don't use it under open phase condition.

- A converter module may be damaged in the case shown below. Be careful.

When an unbalance of the power supply voltage is more than 3%.

Power supply capacity, 10 times of the capacity of inverter and a case beyond 500kVA.

When a change in the rapid power supply voltage occur.

(Example) When inverter of the plural is installed with the common electric wire whose it is short by each other.

When there is insertion of the condenser or a removal.

- On/off of the power supply isn't to do it more than three times in one minute. It has the possibility that inverter is damaged.

#### 2. Inverter output terminals (U, V, and W)

- Wire with thicker wire than the applicable wire to control the voltage drop. Particularly when outputting low frequencies, the torque of the motor will reduce by the voltage drop of the wire.
- Do not install power factor correction capacitors or a surge absorber to the output. The inverter will trip or sustain damage to the capacitors or the surge absorber.
- In the case of the cable length being more than 20 meters, it is possible that a surge voltage will be generated and damage to the motor is caused by the floating capacity or the inductance in the wire (400V especially). An EMC Mains Filter is available, please contact us.
- In the case of two or more motors, install a thermal relay to each motor.
- Make the RC value of the thermal relay the value of 1.1 times of motor rated electric current. Install output ACL when a life becomes short by the length of wiring.

#### 3. Direct current reactor (DCL) connection terminals (PD, P)

- These are the terminals to connect the current reactor DCL (Option) to help improve the power factor.
- The short bar is connected to the terminals when shipped from the factory, if you are to connect a DCL you

## Chapter 2 Installation and Wiring

will need to disconnect the short bar first.

- When you don't use a DCL, don't disconnect the short bar.

### 4. External braking resistor connection terminals (P, RB)

- The regenerative braking circuit (BRD) is built-in as standard up to the 15kW Inverter. When braking is required, install an external-braking resistor to these terminals.
- The cable length should be less than 5 meters, and twist the two connecting wires to reduce inductance.
- Don't connect any other device other than the external braking resistor to these terminals.
- When installing an external braking resistor make sure that the resistance is correctly rated to limit the current drawn through the BRD.

### 5. Regenerative braking unit connection terminals (P, N)

- The Inverters rated more than 18.5kW don't contain a BRD circuit. If regenerative braking is required an external BRD circuit (Option) is required along with the resistor (Option).
- Connect external regenerative braking unit terminals (P, N) to terminals (P,N) on the inverter. The braking resistor is then wired into the External Braking unit and not directly to the Inverter.
- The cable length should be less than 5 meters, and twist the two connecting wires to reduce inductance.

### 6. Earth (G $\oplus$ )

- Make sure that you securely ground the Inverter and motor for prevention of electric shock.
- The inverter and motor must be connected to an appropriate safety earth and follow the local standard. Failure to do so constitutes an electrical shock hazard.

## Chapter 2 Installation and Wiring

### (2) Wiring of main circuit terminals

The wiring of main circuit terminals for inverter is the following picture.

Wiring of terminals	Corresponding type
<p>Wiring diagram showing terminals: R (L1), S (L2), T (L3), U (T1), V (T2), W (T3) in the top row; PD (+1), P (+), N (-), RB, G (⊕), G (⊕) in the bottom row. A short bar is shown below the terminals. A charge lamp is connected to terminals RB and G (⊕).</p>	<p>L300P-110,150LF/HF</p> <p>R0-T0 : M4 Other : M6</p>
<p>Wiring diagram showing terminals: R (L1), S (L2), T (L3), PD (+1), P (+), N (-), U (T1), V (T2), W (T3) in the top row; G (⊕), G (⊕) in the bottom row. A short bar is shown below the terminals. A charge lamp is connected to terminals U and V.</p>	<p>L300P-185LF L300P-185-370HF</p> <p>R0-T0 : M4 Other : M6</p>
<p>Wiring diagram showing terminals: R (L1), S (L2), T (L3), PD (+1), P (+), N (-), U (T1), V (T2), W (T3) in the top row; G (⊕), G (⊕) in the bottom row. A short bar is shown below the terminals. A charge lamp is connected to terminals U and V.</p>	<p>L300P-370LF L300P-450,550,750HF</p> <p>R0-T0 : M4 Other : M8</p>
<p>Wiring diagram showing terminals: R (L1), S (L2), T (L3), PD (+1), P (+), N (-), U (T1), V (T2), W (T3) in the top row. A short bar is shown below the terminals. A charge lamp is connected to terminals U and V.</p>	<p>L300P-220,300LF</p> <p>R0-T0 : M4 Earth terminal : M6 Other : M8</p>
<p>Wiring diagram showing terminals: R (L1), S (L2), T (L3), PD (+1), P (+), N (-), U (T1), V (T2), W (T3) in the top row. A short bar is shown below the terminals. A charge lamp is connected to terminals U and V.</p>	<p>L300P-450,550LF</p> <p>R0-T0 : M4 Earth terminal : M6 Other : M10</p>
<p>Wiring diagram showing terminals: R (L1), S (L2), T (L3), PD (+1), P (+), N (-), U (T1), V (T2), W (T3) in the top row. A short bar is shown below the terminals. A charge lamp is connected to terminals U and V.</p>	<p>L300P-750LF L300P-900-1320HF</p> <p>R0-T0 : M4 Earth terminal : M8 Other : M10</p>

### (3) Wiring Equipment

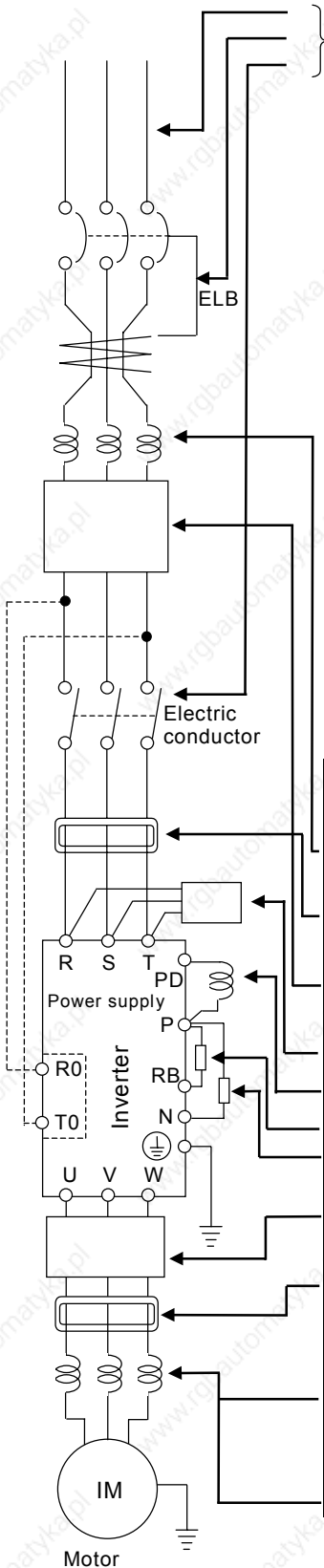

Refer to “(4) Common applicable tools”

(Note 1) The applicable tools indicate for Hitachi standard four-pole squirrel-cage Motor.

(Note 2) Select applicable tools for breakers examining the capacity of breakers.(Use Inverter type.)

(Note 3) Use earth-leakage breakers (ELB) for safety.

(Note 4) Use 60/75°C copper electric wire.

(Note 5) It needs bigger wires for power lines, if the distance exceeds 20m.

(Note 6) 0.75mm<sup>2</sup> for Alarm output contact.

(Note 7) Separate by the sum wiring distance from Inverter to power supply, from inverter to motor for the sensitive current of leak breaker (ELB).

(Note 8) When using CV wire and wiring by rigid metal conduit, leak flows.

(Note 9) IV wire is high dielectric constant. So the current increase 8 times.

Therefore, use the sensitive current 8 times as large as that of the left list. And if the distance of wire is over 100m, use CV wire.

Wiring distance	Sensitive Current(mA)
100m and less	50
300m and less	100

Name	Function
Input reactor (harmonic control,electrical coordination, power-factor improvement) (AL-***)	This part is used when the unbalance voltage rate is 3% or more and power supply is 500 kVA or more, and there is a rapid change in the power supply. It also improves the power factor.
Radio noise filter (zero-phase reactor) (ZCL-***)(FC-**)	Using the inverter may cause noise on the peripheral radio through the power lines. This part reduces noise.
Noise filter for Inverter (NF-***)	This part reduces common noise generated between the power supply and the ground, as well as normal noise. Put it in the primary side of inverter.
Input radio noise filter (capacitor filter) (CFI-*)	This part reduces radiation noise emitted from wire at the input.
Direct reactor (DCL-*..**)	This part control harmonic from inverter.
Breaking resistor Regenerative braking unit	This part is used for applications that need to increase the brake torque of the inverter or to frequently turn on and off and to run high inertia load.
Output noise filter (ACF-C*)	This part reduces radiation noise emitted from wire by setting between inverter and motor. And it reduces wave fault to radio and TV, it is used for preventing malfunction of sensor and measuring instruments.
Radio noise filter(zero-phase reactor) (ZCL-***)	This part reduces noise generated at the output of the inverter. (It is possible to use for both input and output.)
Output alternation reactor Reducing vibration, Thermal relay, preventing misapplication (ACL-*..**)	Running motors with the inverter generates vibration greater than that with commercial power supply. This part installed between the inverter and motor reduces torque ripple. When the cable length between the inverter and motor is long (10m or more), a countermeasure for a malfunction of the thermal relay by harmonic due to switching on inverter is taken by inserting reactor. There is the way to use current sensor in stead of thermal relay.
LCR filter	Sine-wave filter at the output.

## Chapter 2 Installation and Wiring

### (4) Common applicable tools

	Motor Output (kW)	Applicable Inverter model	Power lines R, S, T, U, V, W, P, PD, N		Earth line G			External resistor between P and RB		Screw size of terminal	Terminal	Tightning Torque max (N*m)	Applicable tools		
			mm <sup>2</sup> or more	AWG or more	mm <sup>2</sup> or more	AWG or more	AWG or more (#5)	mm <sup>2</sup>	AWG				Leak breaker (ELB)	Circuit breaker or fuse	Electro-magnetic controller (Mg)
200V class	11	L300P-110LF	14	4	14	4	10	5.5	8	M6	14-6	4.9	RX100(75A)	60A	H50
	15	L300P-150LF	22 (Note 1)	2	22	3	8	5.5	8	M6	22-6	4.9	RX100(100A)	70A	H65
	18.5	L300P-185LF	30	1	22	3	8	-	-	M6	38-6	4.9	RX100(100A)	90A	H80
	22	L300P-220LF	38	1/0	30	2	8	-	-	M8	38-8	8.8	RX225B(150A)	100A	H100
	30	L300P-300LF	60 (Note 1)	2/0	30	2	6	-	-	M8	60-8	8.8	RX225B(200A)	150A	H125
	37	L300P-370LF	100 (38 x 2) (Note 1)	(#1)	50	1/0	6	-	-	M8	100-8 (38-8)	8.8	RX225B(225A)	175A	H150
	45	L300P-450LF	100 (38 x 2)	(#2)	80	3/0	6	-	-	M10	100-10 (38-10)	13.7	RX225B(225A)	200A	H200
	55	L300P-550LF	150 (60 x 2) (Note 1)	(#3)	80	3/0	4	-	-	M10	150-10 (60-10)	13.7	RX400B(350A)	250A	H250
400V class	75	L300P-750LF	150 (60 x 2) (Note 1)	(#3)	100	4/0	4	-	-	M10	150-10 (60-10)	13.7	RX400B(350A)	300A	H300
	11	L300P-110HF	5.5	8	5.5	8	10	5.5	8	M6	5.5-6	4.9	EX50C(50A)	30A	H25
	15	L300P-150HF	8	6	8	8	10	5.5	8	M6	8-6	4.9	EX60B(60A)	35A	H35
	18.5	L300P-185HF	14	6	14	4	10	-	-	M6	14-6	4.9	EX60B(60A)	50A	H50
	22	L300P-220HF	14	4	14	4	10	-	-	M6	14-6	4.9	RX100(75A)	50A	H50
	30	L300P-300HF	22	3	22	3	10	-	-	M6	22-6	4.9	RX100(100A)	70A	H65
	37	L300P-370HF	38	1	22	3	8	-	-	M6	38-6	4.9	RX100(100A)	80A	H80
	45	L300P-450HF	38	1	22	1	8	-	-	M8	38-8	8.8	RX225B(150A)	100A	H100
	55	L300P-550HF	60	1/0	30	1	6	-	-	M8	60-8	8.8	RX225B(175A)	125A	H125
	75	L300P-750HF	100 (38 x 2)	(#2)	50	1/0	6	-	-	M8	100-8 (38-8)	8.8	RX225B(225A)	150A	H150
	90	L300P-900HF	38 x 2	(#2)	50	3/0	6	-	-	M10	38-10	13.7	RX225B(225A)	200A	H200
	110	L300P-1100HF	60 x 2	(#3)	80	3/0	4	-	-	M10	60-10	13.7	RX400B(350A)	250A	H250
132	L300P-1320HF	80 x 2	(#3)	100	4/0	4	-	-	M10	80-10	13.7	RX400B(350A)	300A	H300	

**#1** 3/0 or 2 parallel of 1 AWG **#2** 250kcmil or 2 parallel of 1 AWG(75°C) **#3** 350kcmil or 2 parallel of 1/0 AWG

**#4** Use suitable fuse with an UL-listed for UL. **#5** Conformity to the UL

**(Note)** Field wiring must be made by an UL-listed and CSA-certified closed-loop terminal connector sized for the wire gauge involved. Connector must be fixed by using the crimping tool specified by the connector manufacture or equivalent wording included in the manual.

**(Note 1)** If wires are shorter than 10m and are located within an enclosure, it is possible to use following power lines.

Inverter Model	Power lines			Terminal
	mm <sup>2</sup> or more	AWG or more	Heat resistant	
150LF	14	4	110°C	14-6
300LF	38	1/0	110°C	38-8
370LF	60	2/0	110°C	60-8
550LF,750LF	100	(#2)	110°C	100-10

### ⚠ WARNING

Use suitable circuit breaker or fuse listed in this manual for UL's listing purpose.  
Otherwise, there is a danger of fire.

#### 5) Connecting power to the control circuit, separating from main power

When the protection circuit of inverter is activated and the electromagnetic contactor on the input supply to the inverter isolates the power supply, the control circuit power supply from the inverter will also switch off and the alarm output signal will not be hold. The power terminals R0 and T0 are designed to allow a supply to go direct to the control circuit and therefore keep the alarm output signal on. In this case, please connect power terminals R0 and T0, to the primary side of the electromagnetic contactor. ( inverter unit side of ACL, EMI filter, on using input ACL, EMI filter).

(Connection)

[3] Connect power supply for control circuit to power terminals.

The specification of the receiving voltage  
 200~240V±10%(50/60Hz±5%)  
 (DC282~339V)  
 380~480V±10%(50/60Hz±5%)  
 (DC537~678V)

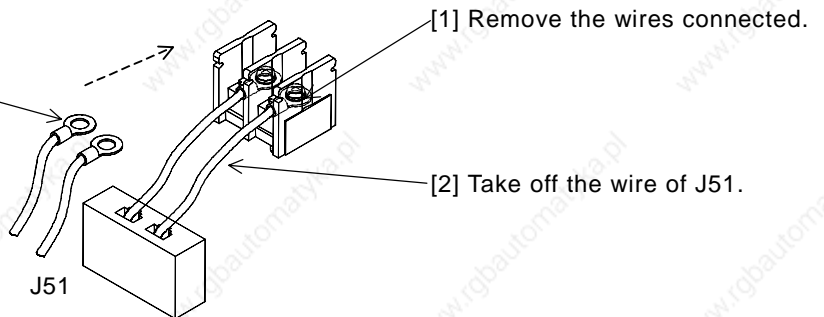

### 2.2.3 Terminal Connection Diagram

#### (1) Wiring

1. Both the CM1 and L terminal is insulated to both the common terminal of the input and output signals. Do not short or earth these common terminals.
2. Use twisted screened cable, for the input and output wires of the control circuit terminals. Connect the screen to the common terminal.
3. Limit connection wires to 20m. When it is necessary to wire over 20m, use a VX applied controller RCD-A (Remoter operation bar) or a CVD-E (Insulated signal transducer).
4. Separate the control circuit wiring from the main power and relay control wiring.
5. If control and power wires must cross make sure they cross at 90 degrees to each other.
6. When connecting a thermistor to the TH and CM1 terminal, twist the thermistor cables separate from the rests.

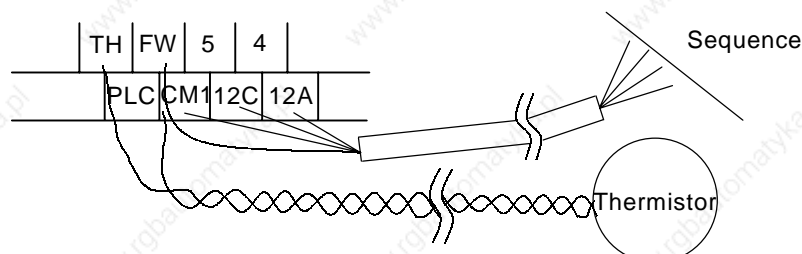

7. When using relays for the FW terminal or an intelligent input terminal uses a control relay as they are designed to work with 24Vdc.
8. When the relay is used as an intelligent output, connect a diode for surge protection parallel to the coil.
9. Do not short the analogue voltage terminals H and L or the internal power terminals PV24 and CM1. There is risk of Inverter damage.



## Chapter 2 Installation and Wiring

### (2) Layout of control circuit terminals

H	O2	AM	FM	TH	FW	5	4	3	2	1	AL1	
L	O	OI	AMI	P24	PLC	CM1	12C	12A	11C	11A	ALO	AL2

The terminal screw size; M3

### (3) Change of input logic type

The logic type of intelligent input terminals is sink type (Factory Default). To change the input logic type into source type, take off the short bar between P24 and PLC on the control terminal and connect it between PLC and CM1.

### (4) The connection to the input programmable logic controller (sequencer)

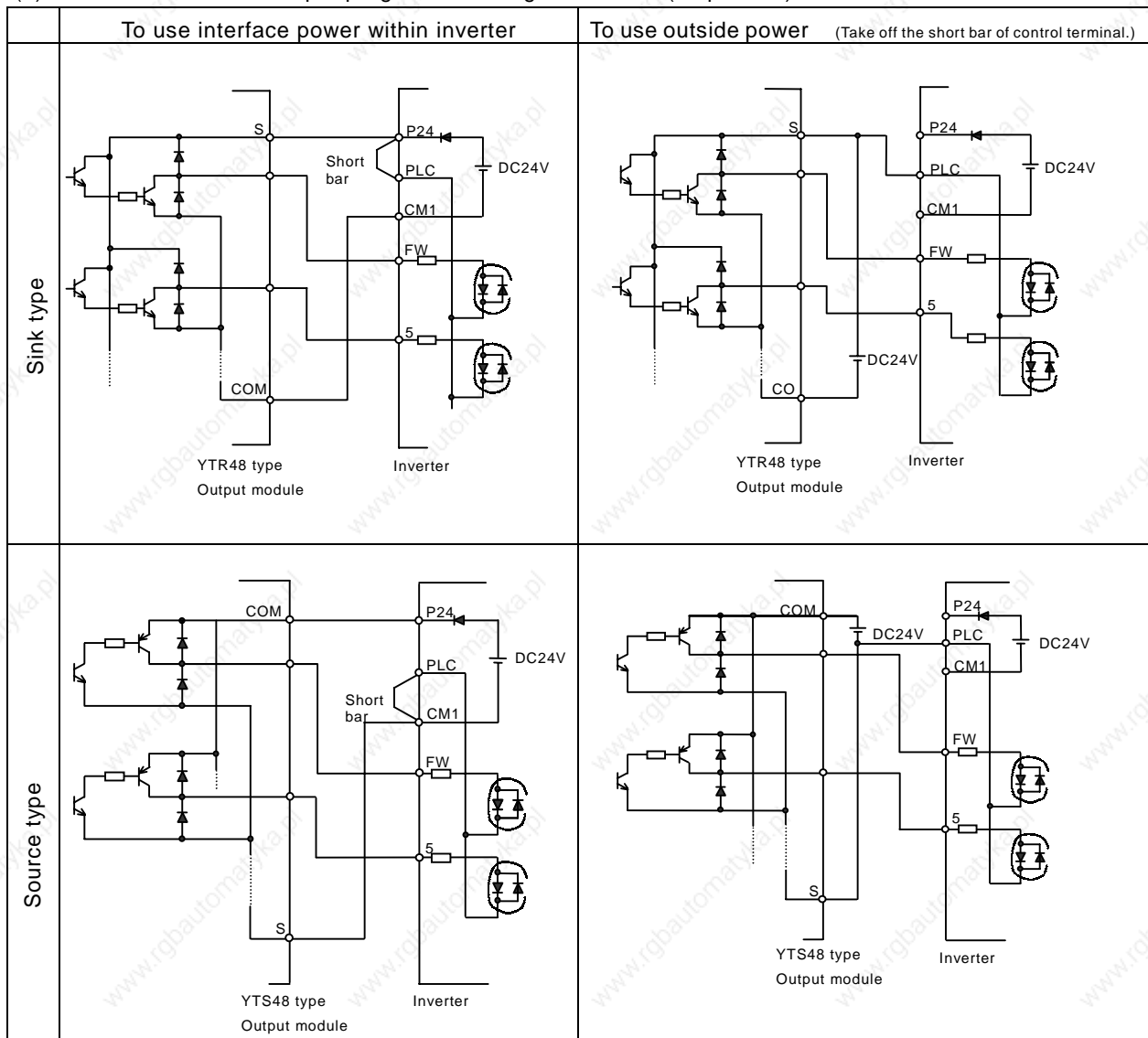

### 2.2.4 Digital operator wiring

For operating this inverter, it can use digital operator OPE-SR , OPE-SRE, OPE-S, SRW-0J and SRW-0EX. For remote operating, put off digital operator from inverter and use connector cable ICS-1(1m) or ICS-3(3m).

(Note 1) When using connector cable, be sure to use less than 3m length. Otherwise, there is a danger of malfunction.

(Note 2) In case of remote operating with connector cable, the inverter does not conform to EMC.

### **WARNING**

- Be sure not to touch the main terminal or to check the signal or put on/off wire and/or connector.  
Otherwise, there is a danger of electric shock.
- Be sure to turn on the input power supply after closing the front cover.  
While being energized, be sure not to open the front cover.  
Otherwise, there is a danger of electric shock.
- Be sure not to operate the switches with wet hands.  
Otherwise, there is a danger of electric shock.
- While the inverter is energized, be sure not to touch the inverter terminals even during stoppage.  
Otherwise, there is a danger of electric shock.
- If the retry mode is selected, it may suddenly restart during the trip stop. Be sure not to approach the machine.  
(Be sure to design the machine so that personnel safety will be secured even if it restarts.)  
Otherwise, there is a danger of injury.
- Be sure not to select retry mode for up and down equipment or traveling equipment, because there is output free-running mode in term of retry.  
Otherwise, there is a danger of injury and/or machine breakage.
- Even if the power supply is cut for a short period of time, it may restart operation after the power supply is recovered if the operation command is given. If it may incur danger to personnel, be sure to make a circuit so that it will not restart after power recovery.  
Otherwise, there is a danger of injury.
- The Stop Key is effective only when the function is set. Be sure to prepare the Key separately from the emergency stop.  
Otherwise, there is a danger of injury.
- After the operation command is given, if the alarm reset is conducted, it will restart suddenly. Be sure to set the alarm reset after checking the operation command is off.  
Otherwise, there is a danger of injury.
- Be sure not to touch the inside of the energized inverter or to put a bar into it.  
Otherwise, there is a danger of electric shock and/or fire.

### CAUTION

- Cooling fin will have high temperature. Be sure not to touch them.  
Otherwise, there is a danger of getting burned.
- Low to high speed operation of the inverter can be easily set. Be sure to operate it after checking the tolerance of the motor and machine.  
Otherwise, there is a danger of injury.
- Install external break system if needed.  
Otherwise, there is a danger of injury.
- If a motor is operated at a frequency higher than standard setting value(50Hz/60Hz),be sure to check the speeds of the motor and the machine with each manufacturer, and after getting their consent, operate them.  
Otherwise, there is a danger of machine breakage.
- Check the following before and during the test run.  
Otherwise, there is a danger of machine breakage.
  - Was the direction of the motor correct?
  - Was the inverter tripped during acceleration or deceleration?
  - Were the rpm and frequency meter correct?
  - Were there any abnormal motor vibrations or noise?

### 3.1 Operation

This inverter requires two different signals in order for the Inverter to operate correctly. The Inverter requires both an operation setting and a frequency setting.

The following indicates the details of each method of operation and the necessary instructions for operation.

(1) Operation setting and a frequency setting by the terminal control.

This is the method by connecting signals from the outside (the frequency setting, the starting switch etc.) with the control circuit terminals.

The operation is started when the operation setting (FW, RV) is turned ON while the input power is turned ON.

(Note) The methods of the setting frequency with terminal are the voltage setting and the electric setting. And they are selective by each system. The control circuit terminal list shows this in detail.

(Necessary things for operation)

[1] The operation setting: switch, relay etc.

[2] The frequency setting: signals from volume or external (DC0-10V, DC-10-10V, 4-20mA etc.)

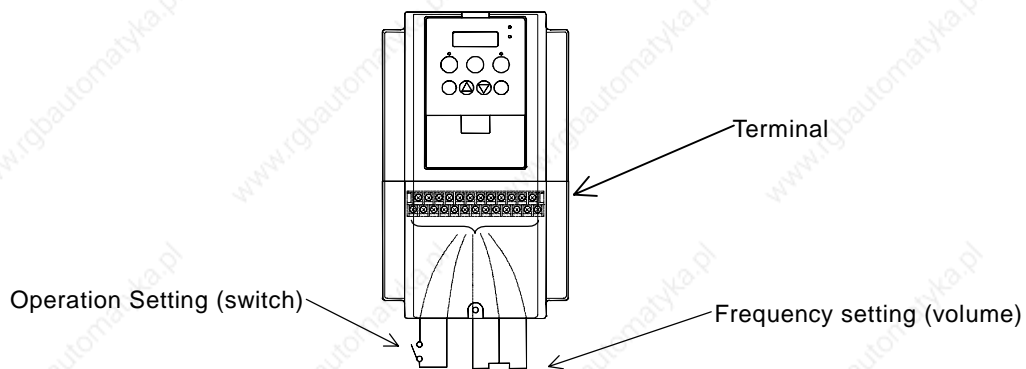

(2) Operation setting and frequency setting with the digital operator.

This is the method for operation from the digital operator, which comes equipped with the inverter as standard, or the remote operator (SRW) keypad.

When the digital operator sets the operation, the terminals (FW, RV) don't need to be linked.

And it is possible to select frequency from the digital operator as a method of the frequency setting too.

(Necessary things for operation)

[1] Remote Operator (SRW) (It's unnecessary in case of digital operator operation)

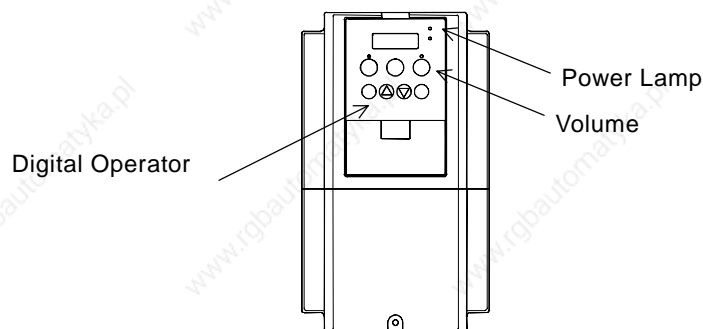

(3) Operation setting and frequency setting from both digital operator and terminal operator

This is the method of inverter operating from both of the above two operating methods

It is possible that the operation setting and the frequency setting can be selected for both the digital operator and the terminal operator each separately.

## 3.2 Test Run

This is the common connection example. Please refer to 4.1 Digital Operator, for the detailed use of the digital operator (OPE-SR).

- (1) To input the operation setting and the frequency setting from terminal control.

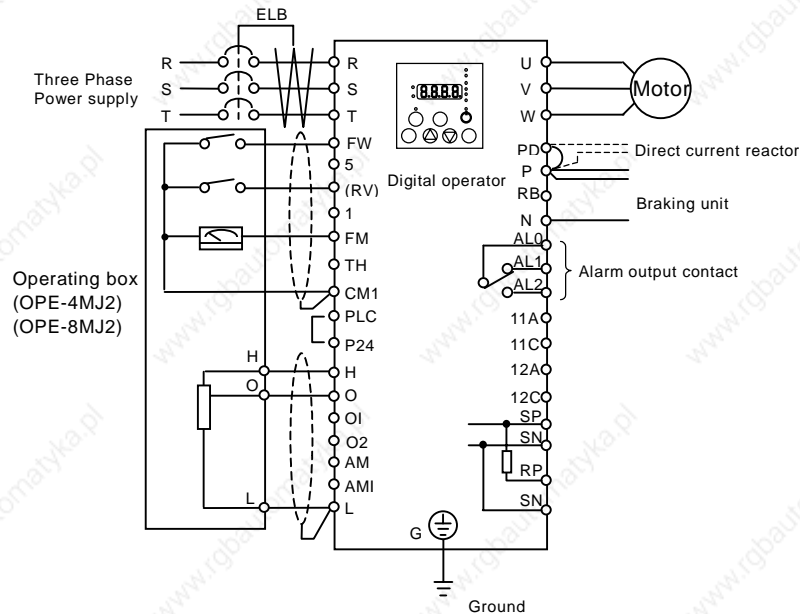

### (Arrangements)

- [1] Please make sure that the connections are correctly secure.
- [2] Turn the ELB ON to supply power to the inverter.  
(The red LED "POWER" on the digital operator should illuminate.)
- [3] Set terminal with the frequency setting selection.  
Set A001 as indication code, press the **(FUNC)** key once. (Two figures are shown.)  
Set 01 with the **(1)** key or the **(2)** key, press the **(STR)** key once to set the frequency setting for terminal. (Indication code turns back to A001.)
- [4] Set terminal with the operation setting selection.  
Set A002 as indication code, press the **(FUNC)** key once. (Two figures are shown.)  
Set 01 with the **(1)** key or the **(2)** key; press the **(STR)** key once to set the operation setting for terminal.  
(Indication code turns back to A002.)
- [5] Set monitor mode.  
When monitoring the output frequency, set indication code to d001, and press the **(FUNC)** key once.  
Or when monitoring the operating direction, set indication code to d003, press the **(FUNC)** key once.
- [6] Input starting operation setting.  
Turn ON between [FW] and [CM1] of terminal.  
Impress voltage between [O] and [L] of terminal to start operation.
- [7] Input ending operation setting.  
Turn OFF between [FW] and [CM1] to stop slowly down.

- (2) Operation setting and the frequency setting from the digital operator  
(Remote Operator (SRW) is also same use.)

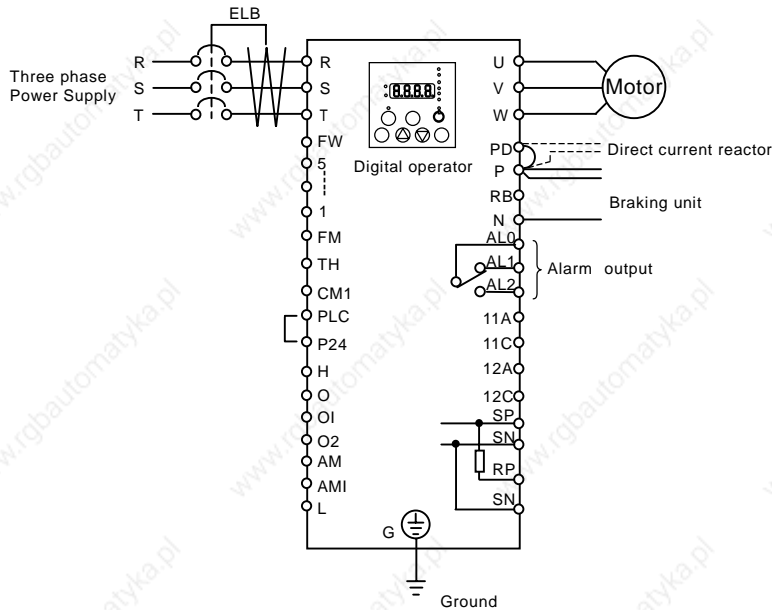

**(Arrangements)**

[1] Please make sure that there isn't matter about the connection.

[2] Turn the ELB on to supply power to the inverter.  
(The red LED "POWER" on the digital operator should illuminate.)

[3] Set operator with the frequency setting selection.  
Set A001 as indication code, press the **(FUNC)** key once.  
(Two figures are shown.)

Set 02 with the **(1)** key or the **(2)** key, press the **(STR)** key once to set the frequency setting for the operator.  
(Indication code turns back to A001.)

[4] Set operator with the operation setting selection.  
Set A002 as indication code, press the **(FUNC)** key once.  
(Two figures are shown.)

Set 02 with the **(1)** key or the **(2)** key, press the **(STR)** key once to set the operation setting for the operator.  
(Indication code turns back to A002.)

[5] Set the output frequency



Set F001 as indication code, as press the  key once.  
(Indication code of four figures is shown.)

Set to the desired output frequency with the  key or the  key, press the  key once to store it.



(Indication code turns back to F001.)



[6] Set the operation direction.

Set F004 as indication code, press the  key once.  
(00 or 01 is shown.)

Set operation direction to 00 in case of forward, or to 01 in case of reverse with the  key or the  key. Press the  key once to establish it.  
(Indication code turns back to F004.)

[7] Set monitor mode.

When monitoring the output frequency, set indication code to d001, and press the  key once.  
Or when monitoring the operation direction, set indication code to d003, press the  key once.

(Indication code are  forward,  reverse or  stop.)

[8] Press the  key to start operating.

(The green LED "RUN" turns on a light, and the indication changes in response to the monitor mode set.)

[9] Press the  key to decelerate to a stop.

(When the frequency turn back to 0, the green LED "RUN" light will switch off.)



### CAUTION

Make sure that the direction of the motor is correct. It is in danger of injury or machine damage.  
Make sure there is no abnormal noise and vibration. It is in danger of injury or machine damage.

Make sure that there is no tripping during the acceleration and deceleration and check that the revolution per minute and the frequency meter are correct.

When overcurrent tripping or overvoltage tripping occurs during the test run, increase the acceleration time or the deceleration time.



## 4.1 About Digital Operator (OPE-SR)

Explanation of operating the digital operator (OPE-SR)

L300P series operates by using the digital operator, which is fitted as standard.

### 1. Name and contents of each part of the digital operator

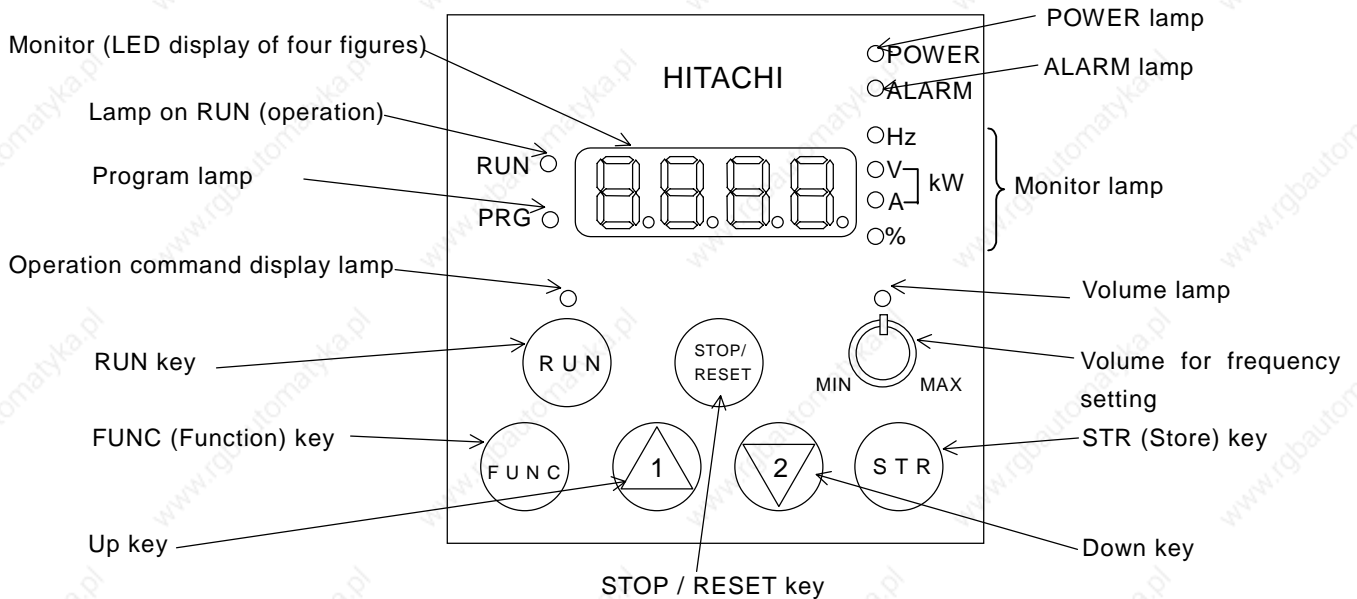

Name	Contents
Monitor	Display of frequency, output current and set value
Lamp on RUN (Operation)	Light on when the inverter is running
Program lamp	Light on when displaying set value of each function in monitor section Light will flash On and Off as a warning (when set value is incorrect)
POWER lamp	Power lamp of control circuit
ALARM lamp	Light on when the Inverter trips
Monitor lamp	Lamp display state of monitor section. Hz : Frequency V : Voltage A : Current kW : Electric power % : Rate
Volume lamp	Light on when the frequency can be set by the volume for frequency setting
Operation command Display lamp	Light on only when operating command (RUN/STOP) is set in operator
RUN key	Run command to start the motor. But this is only valid when operation command is from the operator. (Be sure that the operation command display lamp is illuminated.)
STOP (STOP/RESET) key	This key is used to stop motor, or reset an alarm.
Volume for frequency setting	This can be used to set the output frequency. But this is only valid when the frequency command part is set in volume.
FUNC (Function) key	The key containing monitor mode, basic setting mode, extension functions mode.
STR (Store) key	The key to store the data set. (On changing set value, must be pushed or value is lost.)
UP/DOWN key	The keys to change extension function mode, function mode and set value.

# Chapter 4 Explanation of function

## 2. Operating method

### (1) Method to display monitor mode, basic setting mode, extension function mode

Power on

[1] Display of monitor contents set  
(Display 0.00 in initial state)

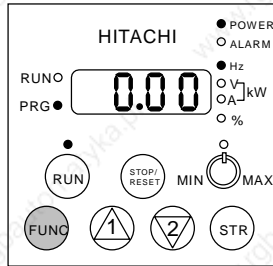

[5] Display monitor code No.  
(Display d001)

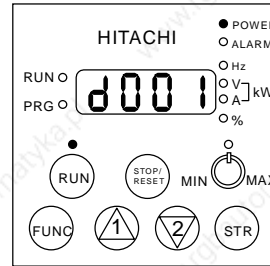

When power is turned off while the basic setting mode or the extension setting mode is displayed. The display will be different from the one above when the power is restored.

Return to the state of [2].

Push the **FUNC** key.

Push the **1** key. (6 times)

Push the **2** key. (6 times)

[2] Display monitor code No.  
(Display d001)

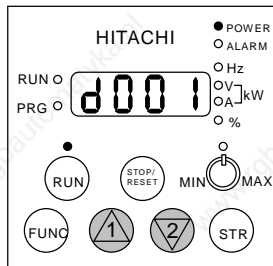

[4] Display extension function mode  
(Display A - - -)

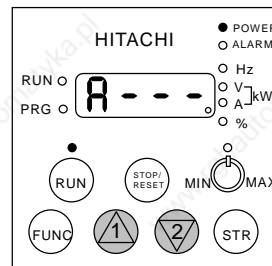

Monitor mode is displayed by pushing **FUNC** (Function) key once when display of Monitor mode No.

Extension function mode  
Display in the order of  
**A ← b ↔ C ↔ H ↔ P ↔ U.**

Push the **2** key. Push the **1** key.

Push the **1** key. (6 times) Push the **2** key.

(Display d002)

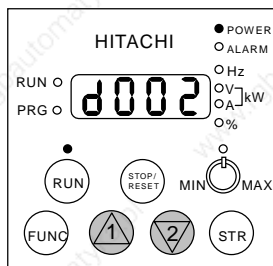

(Note 1)  
Push the **1** key. (18 times)

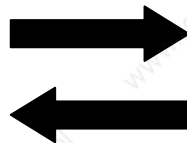

[3] Display code No. of basic setting mode.  
(Display F001)

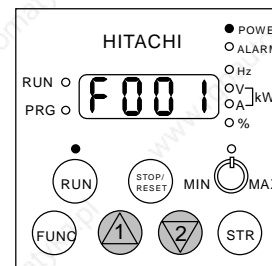

Push the **2** key. (18 times)

(Note) Refer to setting (3) method of function code.

## Chapter 4 Explanation of function

### (2) Setting method of function

Change operation command part. (Operator → Control terminal)

#### [1] Display extension function mode

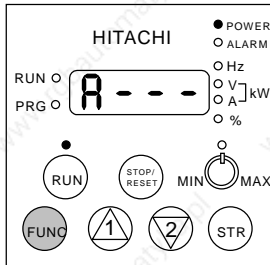

Make monitor display "A - - -" by referring to (1) displaying method.

Now operating command part is by the operator, so operating command display lamp should illuminate.

↓ Push the **FUNC** key.

#### [2] Display code No. of function mode.

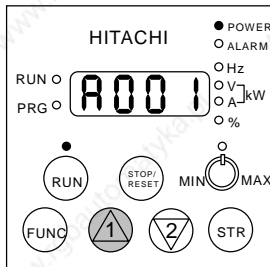

↓ Push the **1** key.

(Display A002)

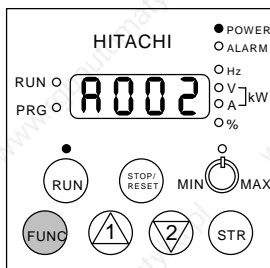

↓ Push the **FUNC** key.

#### [3] Display contents of function mode

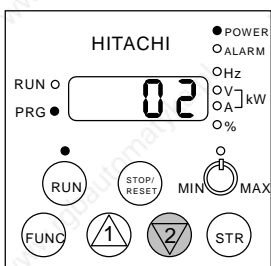

Push the **2** key.

Operation command part displays 02(operator).

Program (PRG) light on by displaying contents of function mode

#### [5] Display extension function mode (Display A - - -)

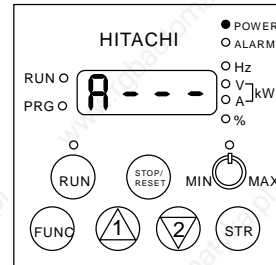

It is possible to shift to other extension function modes, monitor modes and basic modes in this state.

↑ Push the **FUNC** key.

#### [4] Display code No. of monitor mode. (Display A002)

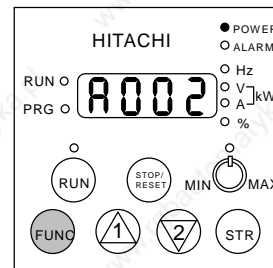

The changed set value is confirmed by pushing the STR key.

Operation command display lamp will switch off so that operation command is now changed to the control terminal.

↑ Push the **STR** key.

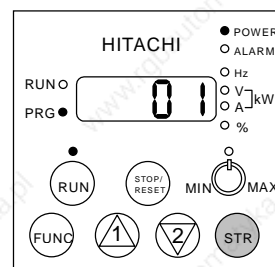

Change operation command part to control terminal 01.

## Chapter 4 Explanation of function

### (3) Setting method of function code

Code No. of monitor modes, basic setting modes and extension function codes can be set easily.

Indicate the method to change code No. d001 of monitor mode to function code No. A029 simply.

[1] Display code No. of monitor mode.

(Display d001)

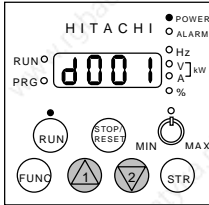

↓ Push the key together.

[2] Change extension function mode

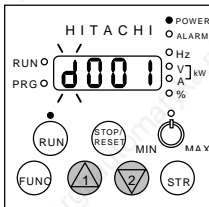

"d" blinks.

↓ Push the key. (2 times)

(Display A001)

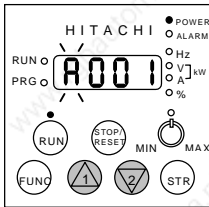

"A" blinks.

The figure lighting is decided by pushing STR key.

↓ Push the key. (Confirm "A")

[3] Change third figure of function code No.

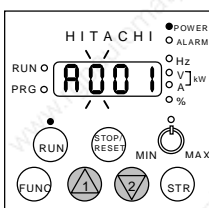

Third figure "0" blinks.

Don't change third figure and push the STR key and confirm 0.

→ Push the key.

(Confirm "0")

(Display A029)

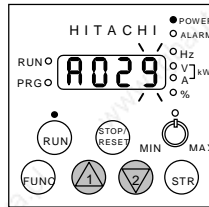

"9" of first figure blinks.

[5] Change first figure of function code No.

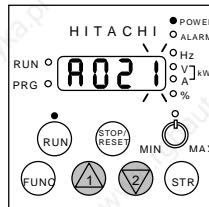

First figure, "1" blinks.

(Display A021)



Second figures, "2" blinks.

[4] Change second figure of function code No.

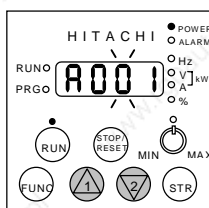

Second figure, "0" blinks.

→ Push the Key  
(Decide "9")

[6] Finish setting

function code No.

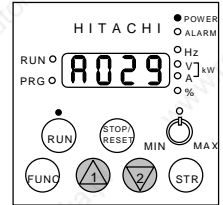

Finish setting A029

(Note) When you input code No. there isn't in the code list, "A" of left end blinks again. Confirm code No. and input it again.

## Chapter 4 Explanation of function

### 4.2 Code list

Monitor code

(Note 1)

Display code	Function name	L300P monitor or data range (digital operator)	Initial data	Setting on running	Change mode during running	Page
d001	Output frequency monitor	0.00-99.99/100.0-400.0(Hz)	-	-	-	4-10
d002	Output current monitor	0.0-999.9(A)	-	-	-	4-10
d003	Operation direction monitor	F(forward)/o(stop)/r(reverse)	-	-	-	4-10
d004	PID feedback monitor	0.00-99.99/100.0-999.9/1000. -9999. / 1000-9999/100-1999 (10000-99900)	-	-	-	4-10
d005	Intelligent input terminal monitor	(Example) FW, terminal2, and 1: ON Terminal 5, 4, 3 :OFF 	-	-	-	4-11
d006	Intelligent output terminal monitor	(Example) Terminal2, 1:ON AL :OFF 	-	-	-	4-11
d007	Frequency conversion monitor	0.00-99.99/100.0-999.9/1000. -9999. / 1000-3996	-	-	-	4-12
d013	Output voltage monitor	0.0-600.0 V	-	-	-	4-12
d014	Electric power monitor	0.0-999.9 kW	-	-	-	4-12
d016	Accumulated time monitor during RUN	0.-9999./1000-9999/100-1999 h	-	-	-	4-13
d017	Power ON time monitor	0.-9999./1000-9999/100-1999 h	-	-	-	4-13
d080	Number of trip time monitor	0.-9999./1000-6553(10000-65530) (time)	-	-	-	4-13
d081	Trip monitor 1	Trip Code, frequency(Hz), current(A), voltage(V),RUN time(h) power ON time(h)	-	-	-	4-13
d082	Trip monitor 2	Trip Code, frequency(Hz), current(A), voltage(V),RUN time(h) power ON time(h)	-	-	-	4-13
d083	Trip monitor 3	Trip Code, frequency(Hz), current(A), voltage(V),RUN time(h) power ON time(h)	-	-	-	4-13
d084	Trip monitor 4	Trip Code, frequency(Hz), current(A), voltage(V),RUN time(h) power ON time(h)	-	-	-	4-13
d085	Trip monitor 5	Trip Code, frequency(Hz), current(A), voltage(V),RUN time(h) power ON time(h)	-	-	-	4-13
d086	Trip monitor 6	Trip Code, frequency(Hz), current(A), voltage(V),RUN time(h) power ON time(h)	-	-	-	4-13
d090	Warning monitor	Warning code	-	-	-	4-78
F001	Output frequency setting	0.0, starting frequency-Max. frequency (2 <sup>nd</sup> max. frequency)(Hz)	0.00	✓	✓	4-14
F002	1 <sup>st</sup> acceleration time	0.01-99.99/100.0-999.9/1000.-3600.(s)	30.00	✓	✓	4-16
F202	2 <sup>nd</sup> acceleration time	0.01-99.99/100.0-999.9/1000.-3600. (s)	30.00	✓	✓	4-16
F003	1 <sup>st</sup> deceleration time	0.01-99.99/100.0-999.9/1000.-3600. (s)	30.00	✓	✓	4-16
F203	2 <sup>nd</sup> deceleration time	0.01-99.99/100.0-999.9/1000.-3600. (s)	30.00	✓	✓	4-16
F004	Operation direction selection	00(forward)/01(reverse)	00			4-15

(Note 1) Change mode during run by selection of b031 (software lock selection).

(Note) Do not forget to press "STR" key when you change the display.

## Chapter 4 Explanation of function

### Function Mode

	Code	Function name	Setting range	Initial data -FE/-FU/-FR	Setting on run	Change mode on run	Page
Base setting	A001	Frequency setting selection	00(VR)/01(terminal)/02(operator)/03(RS485)/ 04(option1)/05(option2)	01/01/00			4-14
	A002	Operation setting selection	01(terminal)/02(operator)/03(RS485)/04(option1)/05(option2)	01/01/02			4-15
	A003	Base frequency	30. - Maximum. frequency(Hz)	50./60./60.			4-17
	A203	Base frequency, 2nd motor	30. - 2 <sup>nd</sup> Maximum. frequency (Hz)	50./60./60.			4-17
	A004	Maximum frequency	30. - 400. (Hz)	50./60./60.			4-18
	A204	Maximum frequency, 2nd motor	30. - 400. (Hz)	50./60./60.			4-18
Analog input setting	A005	AT terminal selection	00( Changing of O and OI with AT terminal)/01(Changing of O and O2 with AT terminal)	00			4-19
	A006	O2 selection	00(single)/01(auxiliary speed of O, OI) [no reversible] /02(auxiliary speed of O, OI [reversible]	00			4-19
	A011	0 start	0.00-99.99/100.0-400.0 (Hz)	0.00		✓	4-20
	A012	0 end	0.00-99.99/100.0-400.0 (Hz)	0.00		✓	4-20
	A013	0 start rate	0.-100.0 (%)	0.		✓	4-20
	A014	0 end rate	0.-100.0(%)	100.		✓	4-20
	A015	0 start selection	00 (external starting frequency)/01(0Hz)	01		✓	4-20
A016	O, OI, O2 sampling	1.-30.(times)	8.		✓	4-21	
Multistage speed • jogging frequency setting	A019	Multi-speed selection	00(binary : range is to 16 stage speed with 4 terminals)/01(bit : range is to 6 stage speed with 5 terminals)	00			4-43
	A020	Multi-speed 0	0.00, starting frequency-maximum. frequency(Hz)	0.00	✓	✓	4-43
	A220	Multi-speed 0, 2 <sup>nd</sup> motor	0.00, starting frequency-2 <sup>nd</sup> maximum frequency(Hz)	0.00	✓	✓	4-43
	A021	Multi-speed1	0.00, starting frequency-maximum frequency(Hz)	0.00	✓	✓	4-43
	A022	Multi-speed2	0.00, starting frequency-maximum frequency(Hz)	0.00	✓	✓	4-43
	A023	Multi-speed3	0.00, starting frequency-maximum frequency(Hz)	0.00	✓	✓	4-43
	A024	Multi-speed4	0.00, starting frequency-maximum frequency(Hz)	0.00	✓	✓	4-43
	A025	Multi-speed5	0.00, starting frequency-maximum frequency(Hz)	0.00	✓	✓	4-43
	A026	Multi-speed6	0.00, starting frequency-maximum frequency(Hz)	0.00	✓	✓	4-43
	A027	Multi-speed7	0.00, starting frequency-maximum frequency(Hz)	0.00	✓	✓	4-43
	A028	Multi-speed8	0.00, starting frequency-maximum frequency(Hz)	0.00	✓	✓	4-43
	A029	Multi-speed9	0.00, starting frequency-maximum frequency(Hz)	0.00	✓	✓	4-43
	A030	Multi-speed10	0.00, starting frequency-maximum frequency(Hz)	0.00	✓	✓	4-43
	A031	Multi-speed11	0.00, starting frequency-maximum frequency(Hz)	0.00	✓	✓	4-43
	A032	Multi-speed12	0.00, starting frequency-maximum frequency(Hz)	0.00	✓	✓	4-43
	A033	Multi-speed13	0.00, starting frequency-maximum frequency(Hz)	0.00	✓	✓	4-43
	A034	Multi-speed14	0.00, starting frequency-maximum frequency(Hz)	0.00	✓	✓	4-43
	A035	Multi-speed15	0.00, starting frequency-maximum frequency(Hz)	0.00	✓	✓	4-43
	A038	Jogging frequency	0.00, starting frequency-9.99(Hz)	1.00	✓	✓	4-44
A039	Jogging selection	00(free-run on JG stop / invalid on running) / 01(stop decelerating on JG stop / invalid on running) / 02(DC braking on JG stop/invalid on running) / 03(free-run on JG stop/valid on running[JG after stop decelerating]) / 04 (stop decelerating on JG stop/valid on running) / 05 (DC braking on JG stop/valid on operating)	00		✓	4-44	
V/f characteristic	A041	Torque boost selection	00 (manual torque boost) / 01 (automatic torque boost)	00			4-24
	A241	Torque boost selection, 2 <sup>nd</sup> motor	00 (manual torque boost) / 01 (automatic torque boost)	00			4-24
	A042	Manual torque boost	0.0-20.0(%)	1.0	✓	✓	4-24
	A242	Manual torque boost, 2 <sup>nd</sup> motor	0.0-20.0(%)	1.0	✓	✓	4-24
	A043	Manual torque boost point	0.0-50.0(%)	5.0	✓	✓	4-24
	A243	Manual torque boost point, 2 <sup>nd</sup> motor	0.0-50.0(%)	5.0	✓	✓	4-24
	A044	1 <sup>st</sup> control	00/(VC)/01(VP1.7power)/02(free V/f setting)	00			4-22
	A244	2 <sup>nd</sup> control	00/(VC)/01(VP1.7power)/02(free V/f setting)	00			4-22
A045	Output voltage gain	20. - 100. (%)	100.	✓	✓	4-21	
Direct current braking	A051	DC braking selection	00(invalid)/01(valid)	00		✓	4-25
	A052	DC braking frequency	0.00-60.00(Hz)	0.50		✓	4-25
	A053	DC braking wait time	0.0 - 5.0(s)	0.0		✓	4-25
	A054	DC braking power	0. - 70. (%)	0.		✓	4-25
	A055	DC braking time	0.0 - 60.0(s)	0.0		✓	4-25
	A056	DC braking edge/level selection	00(edge action)/01(level action)	01		✓	4-25
	A057	DC braking power (starting time)	0. - 70. (%)	0.		✓	4-25
	A058	DC braking time (starting time)	0.00-60.0(s)	0.0		✓	4-25
	A059	DC carrier frequency	0.5-12(kHz) Derating <0.5-8(kHz)>	3.0			4-25

(Note)<>indicate the setting range of 90 to 132kW

## Chapter 4 Explanation of function

### Function Mode

	Code	Function name	Setting range	Initial data -FE/-FU/-FR	Setting on run	Change mode on run	Page	
Upper and lower limiter • jump frequency	A061	1 <sup>st</sup> frequency upper limiter	0.00, 1 <sup>st</sup> frequency lower limiter-maximum frequency(Hz)	0.00		✓	4-28	
	A261	2 <sup>nd</sup> frequency upper limiter	0.00, 2 <sup>nd</sup> frequency lower limiter-2 <sup>nd</sup> setting maximum frequency(Hz)	0.00		✓	4-28	
	A062	1 <sup>st</sup> frequency lower limiter	0.00, start frequency-1 <sup>st</sup> frequency maximum limiter(Hz)	0.00		✓	4-28	
	A262	2 <sup>nd</sup> frequency lower limiter	0.00, start frequency-2 <sup>nd</sup> frequency maximum limiter(Hz)	0.00		✓	4-28	
	A063	Jump frequency1	0.00-99.99/100.0-400.0(Hz)	0.00		✓	4-29	
	A064	Jump frequency Width 1	0.00-10.00(Hz)	0.50		✓	4-29	
	A065	Jump frequency2	0.00-99.99/100.0-400.0(Hz)	0.00		✓	4-29	
	A066	Jump frequency Width 2	0.00-10.00(Hz)	0.50		✓	4-29	
	A067	Jump frequency3	0.00-99.99/100.0-400.0(Hz)	0.00		✓	4-29	
	A068	Jump frequency Width 3	0.00-10.00(Hz)	0.50		✓	4-29	
PID control	A069	Acceleration stop frequency	0.00-99.99/100.0-400.0(Hz)	0.00		✓	4-29	
	A070	Acceleration stop time	0.00-60.0(s)	0.0		✓	4-29	
	A071	PID selection	00(invalid)/01(valid)	00		✓	4-30	
	A072	PID-P gain	0.2-5.0	1.0	✓	✓	4-30	
	A073	PID-I gain	0.0-3600.(s)	1.0	✓	✓	4-30	
	A074	PID-D gain	0.00-100.0(s)	0.00	✓	✓	4-30	
	A075	PID scale	0.01-99.99	1.00		✓	4-30	
	A076	PID feedback selection	00(feedback : OI)/01(feedback : O)	00		✓	4-30	
	A081	AVR selection	00(ON always)/01(OFF always)/02(OFF on decelerating)	00		-	4-17	
	AVR	A082	Motor voltage selection	200/215/220/230/240, 380/400/415/440/460/480	(230/400) (230/460) (200/400)		-	4-17
Operation mode • adjustable function	A085	Operation mode selection	00(normal operation)/01(energy-saving operation)	00		-	4-31	
	A086	Energy-saving response-accuracy adjustment	0.0-100.0	50.0	✓	✓	4-31	
	A092	Acceleration time2	0.01-99.99/100.0-999.9/1000.-3600.(s)	15.00	✓	✓	4-32	
	A292	2 <sup>nd</sup> acceleration time2	0.01-99.99/100.0-999.9/1000.-3600.(s)	15.00	✓	✓	4-32	
	A093	Deceleration time2	0.01-99.99/100.0-999.9/1000.-3600.(s)	15.00	✓	✓	4-32	
	A293	2 <sup>nd</sup> deceleration time2	0.01-99.99/100.0-999.9/1000.-3600.(s)	15.00	✓	✓	4-32	
	A094	2 <sup>nd</sup> stage adjustable selection	00(change with 2CH terminal)/01(change with setting)	00		-	4-32	
	A294	2 <sup>nd</sup> stage adjustable selection(2 <sup>nd</sup> motor)	00(change with 2CH terminal)/01(change with setting)	00		-	4-32	
	A095	2 <sup>nd</sup> acceleration frequency	0.00-99.99/100.0-400.0(Hz)	0.00		-	4-32	
	A295	2 <sup>nd</sup> acceleration frequency(2 <sup>nd</sup> motor)	0.00-99.99/100.0-400.0(Hz)	0.00		-	4-32	
External frequency adjustment	A096	2 <sup>nd</sup> deceleration frequency	0.00-99.99/100.0-400.0(Hz)	0.00		-	4-32	
	A296	2 <sup>nd</sup> deceleration frequency (2 <sup>nd</sup> motor)	0.00-99.99/100.0-400.0(Hz)	0.00		-	4-32	
	A097	Acceleration pattern selection	00(straight line)/01(S-curve)/02(U-curve)/03(reverse U-curve)	00		-	4-33	
	A098	Deceleration pattern selection	00(straight line)/01(S-curve)/02(U-curve)/03(reverse U-curve)	00		-	4-33	
	A101	OI start	0.00-99.99/100.0-400.0(Hz)	0.00		✓	4-20	
	A102	OI end	0.00-99.99/100.0-400.0(Hz)	0.00		✓	4-20	
	A103	OI start rate	0.-100. (%)	20.		✓	4-20	
	A104	OI end rate	0.-100. (%)	100.		✓	4-20	
	A105	OI start selection	00(external start frequency)/01(0Hz)	01		✓	4-20	
	A111	O2 start	-400.-100./-99.9-0.00-99.9/100.-400.(Hz)	0.00		✓	4-20	
Accel/Decel	A112	O2 end	-400.-100./-99.9-0.00-99.9/100.-400.(Hz)	0.00		✓	4-20	
	A113	O2 start rate	-100. - 100. (%)	-100.		✓	4-20	
	A114	O2 end rate	-100. - 100. (%)	100.		✓	4-20	
	A131	Acceleration curve constant	01(small swelling)-10(large swelling)	02		✓	4-33	
	A132	Deceleration curve constant	01(small swelling)-10(large swelling)	02		✓	4-33	
	Instantaneous power failure restart	b001	Retry selection	00(trip)/01(0Hz start)/02(start after equal frequency)/03(trip after equaling frequency and deceleration stop)	00		✓	4-34
		b002	Allowable under-voltage power failure time	0.3-1.0(s)	1.0		✓	4-34
		b003	Retry wait time	0.3-100.(s)	1.0		✓	4-34
		b004	Instantaneous power-failure/under-voltage trip during stop	00(invalid)/01(valid)/02(invalid during stop and deceleration by stop command)	00		✓	4-34
		b005	Instantaneous power-failure/under-voltage retry time selection	00(16 times)/01(free)	00		✓	4-34
b006		Open-phase selection	00(invalid)/01(valid)	00		✓	4-36	
b007		Frequency setting to match	0.00-99.99/100.0-400.0(Hz)	0.00		✓	4-34	
Electronic thermal	b012	Electronic thermal level	0.2*constant current-1.20*constant current(A)	Rated Current of inverter		✓	4-36	
	b212	Electronic thermal level (2 <sup>nd</sup> motor)	0.2*constant current-1.20*constant current(A)	Rated Current of inverter		✓	4-36	
	b013	Electronic thermal characteristic selection	00/(reduced characteristic)/01(constant torque characteristic)/02(free setting)	01/01/00		✓	4-36	
	b213	Electronic thermal characteristic selection (2 <sup>nd</sup> motor)	00/(reduced characteristic)/01(constant torque characteristic)/02(free setting)	01/01/00		✓	4-36	
	b015	Free electronic thermal frequency 1	0.-400.(Hz)	0.		✓	4-37	
	b016	Free electronic thermal current 1	0.0-1000.(A)	0.0		✓	4-37	
	b017	Free electronic thermal frequency 2	0.-400.(Hz)	0.		✓	4-37	
	b018	Free electronic thermal current 2	0.0-1000. (A)	0.0		✓	4-37	
	b019	Free electronic thermal frequency 3	0.-400.(Hz)	0.		✓	4-37	
	b020	Free electronic thermal current 3	0.0-1000.(A)	0.0		✓	4-37	

## Chapter 4 Explanation of function

### Function Mode

	Code	Function name	Setting range	Initial data -FE/-FU/-FR	Setting on run	Change mode on run	Page
Overload limit	b021	Overload restriction selection	00(Invalid)/01(enabled on acceleration / constant speed)/02(enabled on constant speed)	01		✓	4-38
	b022	Overload restriction level	0.50* rated current-1.50* rated current(A)	Rated current of inverter x 1.20		✓	4-38
	b023	Overload restriction limit constant	0.10-30.00(s)	1.00		✓	4-38
	b024	Overload restriction 2 selection	00(Invalid)/01(valid on acceleration / constant speed)/02(valid on constant speed)	01		✓	4-38
	b025	Overload restriction level 2	0.50*rated current-1.50*rated current(A)	Rated current of inverter x1.20		✓	4-38
	b026	Overload restriction constant 2	0.10-30.00(s)	1.00		✓	4-38
Lock	b031	Software lock mode selection	00(impossible to change the data except this item when SFT terminal is ON)/01(impossible to change the data except setting frequency item when SFT terminal is ON)/02(impossible to change the data except this item)/03(impossible to change the data except setting frequency item)/10(possible to change data on operating)	01		✓	4-45
Free V/f setting	b100	Free V/f frequency 1	0.- Free V/f frequency2(Hz)	0.			4-23
	b101	Free V/f voltage 1	0.-800.0(V)	0.0			4-23
	b102	Free V/f frequency 2	0.- Free V/f frequency3(Hz)	0.			4-23
	b103	Free V/f voltage 2	0.-800.0(V)	0.0			4-23
	b104	Free V/f frequency 3	0.- Free V/f frequency4(Hz)	0.			4-23
	b105	Free V/f voltage 3	0.-800.0(V)	0.0			4-23
	b106	Free V/f frequency 4	0.- Free V/f frequency5(Hz)	0.			4-23
	b107	Free V/f voltage 4	0.-800.0(V)	0.0			4-23
	b108	Free V/f frequency 5	0.- Free V/f frequency6(Hz)	0.			4-23
	b109	Free V/f voltage 5	0.-800.0(V)	0.0			4-23
	b110	Free V/f frequency 6	0.- Free V/f frequency7(Hz)	0.			4-23
	b111	Free V/f voltage 6	0.-800.0(V)	0.0			4-23
	b112	Free V/f frequency 7	0.-400.(Hz)	0.			4-23
b113	Free V/f voltage 7	0.-800.0(V)	0.0			4-23	
Intelligent input terminal setting	C001	Intelligent input 1 setting	01/(RV:Reverse is valid)/02(CF1:Multi-speed1)/ 03(CF2:Multi-speed2)/ 04(CF3:Multi-speed3)/ 05(CF4:Multi-speed4)/ 06(JG:Jogging)/ 07(DB:External DC braking)/08(SET:2 <sup>nd</sup> control)/ 09(2CH:two-stage adjustable speed)/11(FRS:Free-run)/ 12(EXT:External trip)/13(USP:Unattended start protection)/ 14(CS:commercial change)/15(SFT:software lock)/ 16(AT:Analog input voltage/current select)/18(RS:Reset inverter)/ 20(STA:3wire run)/ 21(STP:3wire keep)/22(F/R:3wire forward/reverse)/ 23(PID:PID selection valid/invalid)/24(PIDC:PID integrating reset)/ 27(UP:Remote control UP function)/ 28(DWN:Remote control DOWN function)/ 29(UDC:Remote control data clear)/31(OPE:Force operate ope)/ 32(SF1:Multi-speed bit1)/ 33(SF2:Multi-speed bit2)/34(SF3:Multi-speed bit3)/ 35(SF4:Multi-speed bit4)/36(SF5:Multi speed bit5)/ 37(SF6:Multi-speed bit6)/38(SF7:Multi-speed bit7)/ 39(OLR:Overload restriction change)/no:NO assign)	18		✓	4-42
	C002	Intelligent input 2 setting		16		✓	4-42
	C003	Intelligent input 3 setting		03/13/03		✓	4-42
	C004	Intelligent input 4 setting		02		✓	4-42
	C005	Intelligent input 5 setting		01		✓	4-42
Input terminal setting intelligent	C011	Intelligent input1 a/b (NO/NC) selection	00(NO)/01(NC)	00		✓	4-42
	C012	Intelligent input2 a/b (NO/NC) selection	00(NO)/01(NC)	00		✓	4-42
	C013	Intelligent input3 a/b (NO/NC) selection	00(NO)/01(NC)	00/01/00		✓	4-42
	C014	Intelligent input4 a/b (NO/NC) selection	00(NO)/01(NC)	00		✓	4-42
	C015	Intelligent input5 a/b (NO/NC) selection	00(NO)/01(NC)	00		✓	4-42
	C019	Input FW a/b (NO/NC) Selection	00(NO)/01(NC)	00		✓	4-42
Intelligent output terminal setting	C021	Intelligent output 11 setting	00(RUN:running)/01(FA1:Frequency arrival type1 signal)/ 02(FA2:frequency arrival type2 signal)/03(OL:Overload advance notice signal)/04(OD:Output deviation for PID control)/05(AL:Alarm signal)/06(FA3:Only setting frequency)/08(IP:On instantaneous stop/ 09(UV:Under voltage)/11(RNT:RUN time over)/12(ONT:ON time over)/13(THM:thermal caution)	01		✓	4-51
	C022	Intelligent output 12 setting		00		✓	4-51
	C026	Alarm relay output		05		✓	4-51
	C027	FM selection	00(Output frequency)/01(Output current) / 03(Digital output frequency)/04(Output voltage)/ 05(Input electric power)/06(thermal load rate)/07(LAD frequency)	00		✓	4-56
	C028	AM selection	00(Output frequency)/01(Output current)/04(Output voltage)/ 05(Input electric power)/06(thermal load rate)/07(LAD frequency)	00		✓	4-57
C029	AMI selection	00(Output frequency)/01(Output current)/04(Output voltage)/ 05(Input electric power)/06(Thermal load rate)/07(LAD frequency)	00		✓	4-57	
Output terminal state setting	C031	Intelligent output 11 a/b	00(NO)/01(NC)	00		✓	4-52
	C032	Intelligent output 12 a/b	00(NO)/01(NC)	00		✓	4-52
	C036	Alarm relay output a/b	00(NO)/01(NC)	01		✓	4-52
	C040	Overload advance notice signal output mode	00(On accel. And decel, constant speed)/01(Only constant speed)	01		✓	4-39
	C041	Overload advance notice level	0.0-2.0*rated current(A)	Inverter rated current		✓	4-38
	C042	Frequency arrival setting for acceleration.	0.00-99.99/100.0-400.0(Hz)	0.00		✓	4-53
	C043	Arrival frequency setting for deceleration.	0.00-99.99/100.0-400.0(Hz)	0.00		✓	4-53
C044	PID deviation setting level	0.0-100.0(%)	3.0		✓	4-31	



## Chapter 4 Explanation of function

### Function Mode

	Code	Function name	Setting range	Initial data -FE/-FU/-FR	Setting on run	Change mode on run	Page
Communication function	C070	Data command	02(operator)/03(RS485)/04(option1)/05(option2)	02			4-61
	C071	Communicating transmission speed	02(loop-back test)/03(2400bps)/04(4800bps)/ 05(9600bps)/06(19200bps)	04		✓	4-61
	C072	Communication code	1. -32.	1.		✓	4-61
	C073	Communication bit	7(7bit)/8(8bit)	7		✓	4-61
	C074	Communication parity	00(no parity name)/01(even parity)/02(odd parity)	00		✓	4-61
	C075	Communication stop bit	1(bit)/2(bit)	1		✓	4-61
	C078	Communication waiting time	0.-1000.(ms)	0.		✓	4-61
	Analog meter setting	C081	O adjustment	0.-9999./1000-6553(10000-65530)	Set on forwarding	✓	✓
C082		OI adjustment	0.-9999./1000-6553(10000-65530)	Set on forwarding	✓	✓	-
C083		O2 adjustment	0.-9999./1000-6553(10000-65530)	Set on forwarding	✓	✓	-
C085		Thermistor adjustment	0.0 - 1000.	105.0	✓	✓	4-57
C086		AM offset adjustment	0.0 - 10.0(V)	0.0	✓	✓	4-57
C087		AMI adjustment	0. - 255	80	✓	✓	4-57
C088		AMI offset adjustment	0. - 20.0(mA)	Set on forwarding	✓	✓	4-57
The others		b034	RUN time/Power ON time level	0.-9999./1000-6553(10000-65530)hr	0.		✓
	b035	Operation reduced restrict	00(Reverse is valid)/01(Only forward)/02(Only reverse)	00		✓	4-14
	b036	Start reduced voltage	00(Start reduced voltage time small) -06(Start reduced voltage time large)	06		✓	4-40
	b037	Display selection	00(all display)/01(each function display)/ 02(User setting / main setting)	00		✓	4-59
	b080	AM adjustment	0. - 255.	180	✓	✓	4-57
	b081	FM adjustment	0. - 255.	60	✓	✓	4-56
	b082	Start frequency adjustment	0.10-9.99(Hz)	0.50		✓	4-40
	b083	Carrier frequency setting	0.5-12.0(kHz) Derating enable<0.5 - 8> (Note 1)	3.0		✓	4-18
	b084	Initialize mode	00(Trip history clear)/01(Data initialization)/ 02(Trip history clear + data initialization)	00		✓	4-58
	b085	Country code for initialization	00(Interior)/01(EC)/02(USA)	01/02/00		✓	4-58
	b086	Frequency scalar conversion factor	0.1-99.9	1.0	✓	✓	4-12
	b087	STOP key enable	00(valid)/01(invalid)	00		✓	4-15
	b088	Resume on FRS cancellation mode	00(0Hz start)/01(Start f-equaling)	00		✓	4-46
	b090	BRD usage ratio	0.0-100.0(%)	0.0		✓	4-41
	b091	Stop mode selection	00(deceleration stop)/01(Free-run stop)	00		✓	4-15
	b092	Cooling fan control	00(Always ON)/01(ON during run, After power ON, then for 5 minutes on stop is implied.)	00		✓	4-41
	b095	BRD selection	00(Invalid)/01(valid<invalid during stop>)/ 02(valid<valid during stop>)	00		✓	4-41
	b096	BRD ON level	330-380/660-760(V)	360/720		✓	4-41
	b098	Thermistor selection	00(Invalid)/01(Positive temperature coefficient enable)/ 02 (NTC enable)	00		✓	4-57
	b099	Thermistor error level	0. - 9999. (ohm)	3000.		✓	4-57
	C061	Thermal warning level	0. - 100. (%)	80		✓	4-36
	C091	Debug mode selection	00(No display)/01(Display)	00		✓	-
	C101	UP/DWN selection	00(No frequency data)/01(Keep frequency data)	00		✓	4-49
	C102	Reset selection	00(Trip cancel during ON)/01(Trip cancel during OFF)/ 02(Valid only during trip<Cancel during ON>)	00	✓	✓	4-48
	C103	Reset f frequency matching selection	00(0Hz start)/01(Start f-equaling)	00		✓	4-48
	C121	O zero adjustment	0.-9999./1000-6553(10000-65530)	Set on forwarding	✓	✓	-
	C122	OI zero adjustment	0.-9999./1000-6553(10000-65530)	Set on forwarding	✓	✓	-
	C123	O2 zero adjustment	0.-9999./1000-6553(10000-65530)	Set on forwarding	✓	✓	-
	H003	1 <sup>st</sup> allowable motor selection	0.20-90.0(kW) <0.2-160 kW> (Note 1)	Set on forwarding			4-60
	H203	2 <sup>nd</sup> allowable motor selection	0.20-90.0(kW) <0.2-160 kW> (Note 1)	Set on forwarding			4-60
	H004	1 <sup>st</sup> motor pole selection	2/4/6/8(pole)	4		✓	4-60
	H204	2 <sup>nd</sup> motor pole selection	2/4/6/8(pole)	4		✓	4-60
	H006	1 <sup>st</sup> stabilized factor	0. - 255.	100.	✓	✓	4-60
	H206	2 <sup>nd</sup> stabilized factor	0. - 255.	100.	✓	✓	4-60
	P001	Option1 operation selection on error	00(TRP)/01(RUN)	00		✓	4-60
	P002	Option2 operation selection on error	00(TRP)/01(RUN)	00		✓	4-60
	P031	Digital input option input mode selection(Acc/Dec)	00(operation)/01(option1)/02(option2)	00		✓	-
	<P044>	DeviceNet running order of monitoring timer setting	0.00-99.99s	1.00			(Note 2)
	<P045>	Setting in action of abnormal communication	00(trip)/01(trip after deceleration stop)/02(Invalid)/ 03(free-run)/04(deceleration stop)	01			(Note 2)
	<P046>	Output assemble instance Number setting	20, 21, 100	21			(Note 2)
<P047>	Input assemble instance Number setting	70, 71, 101	71			(Note 2)	
<P048>	Detect of idol mode for motion setting	00(trip)/01(trip after deceleration stop)/02(Invalid)/ 03(free-run)/04(deceleration stop)	01			(Note 2)	
<P049>	Pole setting of rotation speed	0-38(even only)	0			(Note 2)	
U001	User1 selection	no/d001-P031	no		✓	4-59	
U002	User2 selection	no/d001-P031	no		✓	4-59	
U003	User3 selection	no/d001-P031	no		✓	4-59	
U004	User4 selection	no/d001-P031	no		✓	4-59	
U005	User5 selection	no/d001-P031	no		✓	4-59	
U006	User6 selection	no/d001-P031	no		✓	4-59	
U007	User7 selection	no/d001-P031	no		✓	4-59	
U008	User8 selection	no/d001-P031	no		✓	4-59	
U009	User9 selection	no/d001-P031	no		✓	4-59	
U010	User10 selection	no/d001-P031	no		✓	4-59	
U011	User11 selection	no/d001-P031	no		✓	4-59	
U012	User12 selection	no/d001-P031	no		✓	4-59	

(Note 1) <> indicate the setting range of 90 to 132kW

(Note 2) <> indicate the setting range of 11 to 75kW

### 4.3 Explanation of function

#### 4.3.1 Monitor mode

##### Output frequency monitor

Indication code d001 displays the frequency the inverter outputs.

The data is displayed as follows.

When d001 is displayed, the monitor lamp "Hz" is illuminated.

(Display)

0.00 - 99.99 : Display is in 0.01Hz unit.

100.0 - 400.0 : Display is in 0.1Hz unit.

(Note) When with digital operator, setting frequency output frequency is adjustable by changing this mode.

Relation code

d001: Output frequency  
monitor

##### Output current monitor

Indication code d002 displays the output current value.

The data is displayed as follows.

In case of displaying d002, the monitor lamp "A" is illuminated.

(Display)

0.0 - 999.9 : Display is in 0.1A unit.

Relation code

d002: Output current  
monitor

##### Operation direction monitor

Indication code d003 displays the direction that the Inverter output is rotating. Forward, reverse or stop.

On operating the inverter (in case of forward or reverse), the RUN lamp will illuminate.

(Display)

F : Forward

o : Stop

r : Reverse

Relation code

d003: Operation direction  
monitor

##### PID feedback monitor

When you select PID function (01) in A071, the inverter displays the feedback value changed by A075 (PID scale).

" Display of monitor part " = " Feedback quantity " x " PID scale "

(Frequency command value) (A075)

(Setting)

A071 : 0.1(PID is effective)

A075 : 0.01-99.99(Display is 0.01-99.99(Set with the 0.01 unit)

Relation code

d004: PID feedback monitor  
A071: PID selection  
A075: PID scale

(Display)

0.00 - 99.99 : Display is in 0.01 unit.

100.0 - 999.9 : Display is in 0.1 unit.

1000 - 9999 : Display is in 1 unit.

┌100 - ┌999 : Display is in 100 unit.

## Chapter 4 Explanation of function

### Intelligent input monitor

The LED display will monitor the state of the intelligent inputs.

Relation code  
d005: Intelligent input monitor

(Example)

FW; input intelligent terminal 2,1:ON

Input intelligent terminal 5, 4, 3:OFF

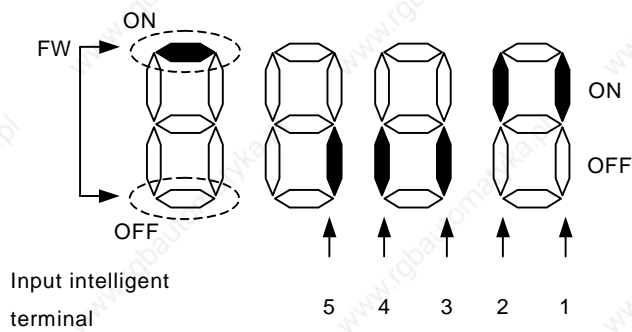

Display

(Black): Lights up  
(White): Lights out

### Intelligent output monitor

The LED display will monitor the state of the intelligent outputs.

Relation code  
d006: Intelligent output monitor

(Example)

Output intelligent terminal 12, 11: ON

Output alarm AL : OFF

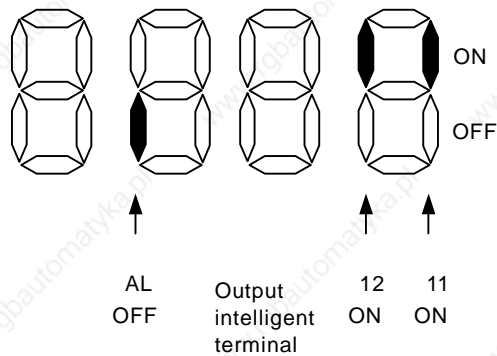

Display

(Black): Lights up  
(White): Lights out

### Frequency conversion monitor

This inverter displays the value changed by the Inverter output frequency and the value set in b086 on the monitor part.

“Monitor part of display” = “ output frequency(d001)” x “ output frequency factor(b086)”

(Display) Display of d007

0.00 - 99.99: Display is in 0.01 unit.

100.0 - 999.9: Display is in 0.1 unit.

100. - 9999.: Display is in 1 unit.

1000 - 3996 :Display is in 10 unit.

(Range of setting) The setting range of b086

0.1 - 99.9 :Set it with the 0.1 unit.

(Example)Output frequency (d001):50.00Hz

When the frequency conversion factor (b086) is 1.1,

the frequency conversion monitor (d007) displays “55.00” as “50 x 1.1 = 55.00”.

(Note)Output frequency of FM terminal becomes same as d007 at the time of setting up the digital output frequency to the FM terminal.

#### Relation code

d007: Frequency conversion monitor

b086: Frequency conversion factor

### Output voltage monitor

This inverter displays the output voltage of the inverter converted into the alternating Voltage.

The monitor lamp “V” should illuminate while the contents of d013 are displayed.

(Display)

0.0 – 600.0 :Display is in 0.1V unit.

#### Relation code

d013: Output voltage monitor

### Input electric power monitor

Display input electric power from inverter.

The monitor lamp “kW” (“V” and “A”) should illuminate while the contents of d014 is displayed.

(Display)

0.0 – 999.9 :Display is in 0.1kW unit.

#### Relation code

d014: Input electric power monitor

### Accumulated time monitor on RUN

The operation time of inverter is accumulated and the value is displayed.  
(Display)

- 0. - 9999. : Display is in 1 hour units.
- 1000 - 9999 : Display is in 10 hour units.
- ┌100 - ┌999 : Display is in 1000 hour units.

Relation code  
d016: Accumulated time  
monitor on RUN

### Power ON time monitor

This accumulates the time running to the inverter and displays the value.  
(Display)

- 0. - 9999. : Display is in 1 hour units.
- 1000 - 9999 : Display is in 10 hour units.
- ┌100 - ┌999 : Display is in 1000 hour units.

Relation code  
d017: Power ON time  
monitor

### Trip time monitor

This displays the number of inverter trips.  
(Display)

- 0. - 9999. : Display is in 1 times unit.
- 1000 - 6553 : Display is in 10 times unit.

Relation code  
d080: Trip time monitor

### Trip monitor 1-6

This displays the details for the last six protective trips.

The trip monitor 1 displayed the details of the last trip.

(Display contents)

- [1] Trip Code (Display anything from E01 to E79.)(Note 1)
- [2] Output frequency on tripping (Hz)
- [3] Output current on tripping (A)
- [4] The direct voltage (between P and N) on tripping (V)
- [5] The accumulated time inverter was operating until tripping (h)
- [6] The accumulated time inverter was run until tripping (h)

(Note 1) Please refer to the pages 4.4 Protection function list (2) Trip monitor display.

Relation code  
d081: Trip monitor 1  
d082: Trip monitor 2  
d083: Trip monitor 3  
d084: Trip monitor 4  
d085: Trip monitor 5  
d086: Trip monitor 6

The methods of trip monitor

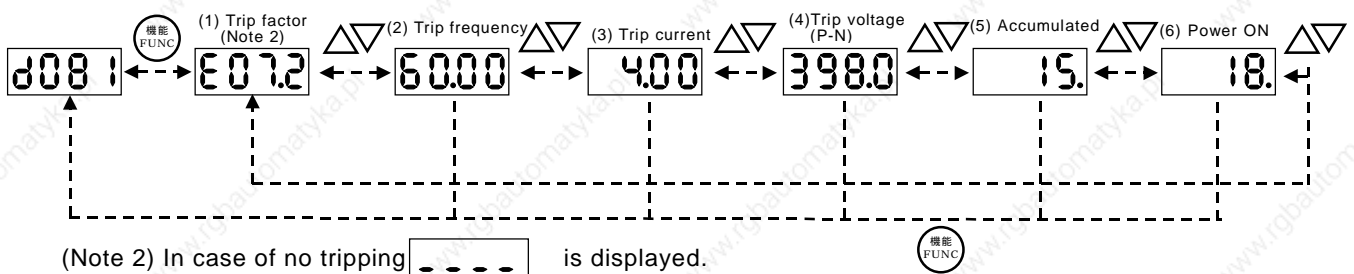

### 4.3.2 Function mode

#### Setting of the output frequency

Setting the output frequency of the motor.

The output frequency is set by F001, when the frequency command select (A001) is set to 02.

Please refer to the frequency command select (A001) about other methods of frequency setting.

When a frequency is set in F001, the same value is automatically set in both Multispeed 0 (A020) and the second set of motor data multispeed 0 (A220) when the SET terminal is ON.

In the case of using SET, you will need to assign 08(SET) to an intelligent input terminal.

Relation code	
F001	:Output frequency setting
A001	:Frequency command select
A020/A220:	1 <sup>st</sup> /2 <sup>nd</sup> multistage speed zero
C001-C005:	Intelligent input terminal

Set item	Function code	Data	Contents
Output frequency setting	F001	0.0, start frequency-First/Second maximum frequency	Unit : Hz "F001" = "A020"
Multistage speed zero	A020/A220		Second control setting of "F001" = "A220"

#### Operation direction

This is effective when the operating command is set by the digital operator.

Relation code	
F004:	Operation direction select

Function code	Data	Contents
F004	00	Forward
	01	Reverse

#### Selection with limits of operation direction

The direction of the motor can be restricted.

Relation code	
b035:	Selection with limits of operation direction

Function code	Data	Contents
b035	00	Forward/reverse is effective.
	01	Only forward
	02	Only reverse

#### Frequency command selection

Select the method of frequency command.

When 0-10Vdc is inputted to the frequency command by 02-L terminal, operation direction of motor reverses.

Relation code	
A001:	Frequency command selection

On output frequency monitor d001, you can't get information about forward/reverse. So be sure with operation direction monitor d002.

Function code	Data	Contents
A001	00	Setting frequency with the potentiometer the digital operator has.
	01	Setting frequency with control terminals (Terminals: O-L, OI-L, O2-L)
	02	Setting frequency with digital operator(F001), remote operator.
	03	Setting frequency with RS485 terminals for communication.
	04	Setting frequency with option board 1.
	05	Setting frequency with option board 2.

## Chapter4 Explanation of function

### Operation command selection

Select the control of RUN/STOP commands.

Operation command from the control terminals (Terminal)

Start/Stop by ON/OFF of control terminals.

Forward : FW-CM1 terminal

Reverse : RV-CM1 terminal

Put 01(RV) to an intelligent Input terminal.

When using the FW terminal, it is possible to change the contact from NO to NC by setting a or b (respectively) in C019. When operating from the digital operator, set operation direction in F004. Or operate Start/Stop with RUN key/STOP key on the digital operator. It becomes stop command when proper forward command and reverse command are inputted at the same time.

#### Relation code

A002 : Operation command selection  
 C001-C005: Input intelligent terminal  
 C019 : Inputting FW a/b (NO/NC) selection  
 F004 : Operation direction select

Set item	Function code	Data	Contents
Operation command selection	A002	01	Start/Stop with control terminals(Terminal).(FW, RV)
		02	Start/Stop with digital operator, remote operator.
		03	Start/Stop with RS485 terminals for communications.
		04	Start/Stop with option board 1.
		05	Start/Stop with option board 2.
Input FW a/b (NO/NC) selection	C019 C011-C015	00	a contact (NO)
		01	b contact (NC)

### Selection on stop

When stop is commanded from the digital operator or the control terminals (Terminal), select the stop after slowing-down according to slowing-down time or the free run stop.

When the second cycle is started while in free run stop, the inverter follows the free-run stop selection b088 and restarts.

(Refer to the item of free-run stop.)

#### Relation code

b091 : Selection on stop  
 F003/F203: 1<sup>st</sup> /2<sup>nd</sup> deceleration time  
 b003 : Waiting time for retrying  
 b007 : Frequency setting to match  
 b088 : Select for free-run stop

Set item	Function code	Data	Contents
Selection on Stop	b091	00	Normal stop (Decelerated stop)
		01	Free-run stop
Selection of free-run stop	b088	00	0Hz start
		01	Start frequency matching
Frequency setting to match	b007	0.00-400.0	Unit : Hz
Waiting time for retrying	b003	0.3-100.	Unit : second

### Selection of Stop key

Even though the control terminals are selected for the operation command, you can still set whether the stop key of operator (digital operator etc) is effective or not. Trip reset functions by the stop key follows this establishment, too.

#### Relation code

b087: Selection of stop key

Function code	Data	Contents
b087	00	The stop key is effective.
	01	The stop key is ineffective.

### Adjustable time

The acceleration and deceleration time can be set.

Set a long time to accelerate or decelerate slowly or set a short time to accelerate or decelerate quickly.

The time setting is the time it takes to accelerate from zero to the maximum frequency and to decelerate from the maximum frequency to zero.

Switching of the 1<sup>st</sup>/2<sup>nd</sup>/3<sup>rd</sup> acceleration time and the 1<sup>st</sup>/2<sup>nd</sup>/3<sup>rd</sup> deceleration time can be controlled with intelligent input terminal assigned to 08 (SET)/17(SET3).

#### Relation code

F002/F202: 1<sup>st</sup> /2<sup>nd</sup> acceleration time

F003/F203: 1<sup>st</sup> /2<sup>nd</sup> deceleration time

A004/A204: 1<sup>st</sup> /2<sup>nd</sup> maximum frequency

Set item	Function code	Limit of setting	Contents
Acceleration time	F002/F202	0.01-3600.	Unit : second Setting acceleration time from zero to maximum frequency.
Deceleration time	F003/F203	0.01-3600.	Unit : second Setting deceleration time from maximum frequency to zero.

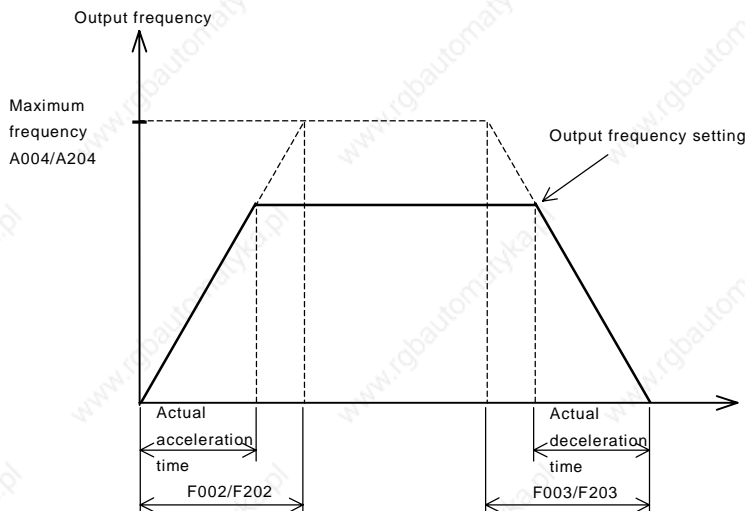

However short you set the adjustable time, the adjustable time of the actual motor can't be shorter than the shortest adjustable time determined by the inertial Effect J of the mechanical system and motor torque.

If you set the time shorter than the shortest adjustable time, a protection trip of OC or OV may occur.

#### Acceleration time $t_s$

$$t_s = \frac{(J_L + J_M) \times N_M}{9.55 \times (T_s - T_L)}$$

$J_L$ : J of the load converted into motor shaft ( $\text{kg}\cdot\text{m}^2$ )

$J_M$ : J of the motor ( $\text{kg}\cdot\text{m}^2$ )

$N_M$ : Motor revolving (r/min)

$T_s$ : The maximum motor acceleration torque on inverter driving ( $\text{N}\cdot\text{m}$ )

$T_b$ : The maximum motor deceleration torque on inverter driving ( $\text{N}\cdot\text{m}$ )

$T_L$ : Needed transit torque ( $\text{N}\cdot\text{m}$ )

#### Deceleration time $t_b$

$$t_b = \frac{(J_L + J_M) \times N_M}{9.55 \times (T_b + T_L)}$$



### Base frequency

- Base frequency and motor voltage
- AVR function

#### (1) Base frequency and motor voltage

On selection of base frequency and motor voltage, set the output of the inverter (frequency voltage) to the motor rating.

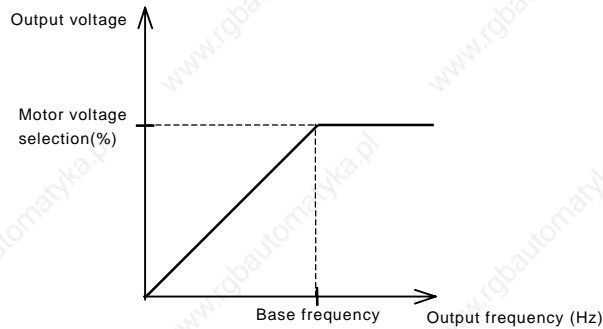

- Relation code

  - A003/A203: 1<sup>st</sup> /2<sup>nd</sup> base frequency
  - A081: AVR selection
  - A082: Motor voltage selection

The Base frequency is the nominal frequency of the motor, this value can be found on the nameplate of the motor. It is important to match the Base frequency (A003) to this nominal value or there is risk of damage to the motor.

If a motor has a base frequency higher than 60Hz, it is considered to be a special motor. In this situation, it is important to make sure the maximum output current of the inverter is higher than the FLC of the motor.

The Motor Voltage Selection is the nominal voltage of the motor, this value can be found on the nameplate of the motor. It is important to match the Motor Voltage (A082) to this nominal value or there is risk of damage to the motor.

When changing second base frequency (A203) an intelligent input terminal must be set to 08(SET) and switched on.

Set item	Function code	Setting limit	Contents
Base frequency	A003/A203	30.-1 <sup>st</sup> /2 <sup>nd</sup> maximum frequency	Unit:Hz
Motor voltage selection	A082	200/215/220/230/240	Unit:V When inverter is 200V class, selection is possible.
		380/400/415/440/460/480	Unit:V When inverter is 400V class, selection is possible.

#### (2) AVR function

Even if the incoming voltage changes, this function will keep the output voltage and a constant voltage level. The output voltage to the motor in this function references to the voltage selected on motor voltage selection. Select Yes/No of this function on A081 AVR selection.

Function code	Data	Contents	Description
A081	00	Always ON	This function is effective on acceleration, constant speed, deceleration.
	01	Always OFF	This function is ineffective on acceleration, constant speed, deceleration.
	02	On decelerating OFF	This increases a loss of motor and reduces the energy regenerated to inverter on decelerating.

## Chapter4 Explanation of function

### Maximum frequency

Set the maximum frequency value of the inverter.

This set value is the maximum frequency that the inverter will achieve when it receives top speed reference from the control terminals or the digital operator.

To change the 1<sup>st</sup>/2<sup>nd</sup> maximum frequency, set an intelligent input terminal to 08(SET) and switch the input ON.

The inverter output voltage from the base frequency to the maximum frequency is the same level as the voltage selected on the motor voltage selection.

Function code	Limit of setting	Contents
A004/A204	30.-400.	Unit : Hz

Relation code  
A004/A204: 1<sup>st</sup> /2<sup>nd</sup> maximum frequency

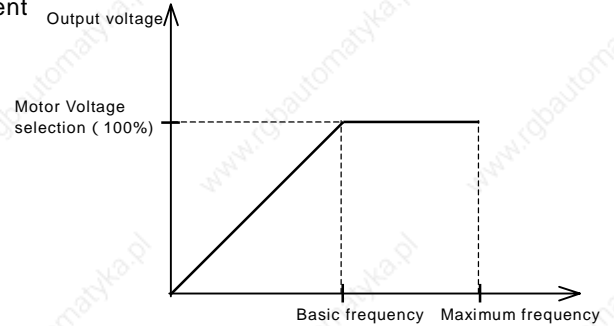

### Carrier frequency

The carrier frequency of the PWM wave-form output from the inverter is adjustable by changing b083.

If the carrier frequency is set higher, the audible noise from the motor will be reduced

but the RFI noise and the leakage current may be increased.

This function may help to avoid the resonant frequency of the motor or the mechanical system.

Function code	Limit of setting	Contents
b083	0.5-12.0(Note 1)	Unit: kHz (11 to 75kW)
	0.5-8.0(Note 1)	Unit: kHz (90 to 132kW)

Relation code  
b083: Carrier frequency

(Note 1) The maximum value of the carrier frequency in order to achieve full output current is different depending on the capacity. When raising the carrier frequency, the rated output current will be reduced.

Voltage class	200V class		400V class	
	Contents (kW)	Maximum carrier frequency (kHz)	Maximum carrier frequency (kHz)	Derating on carrier frequency = 12kHz
				Derating on carrier frequency = 12kHz (8kHz 90kW to 132kW)
	11	12	12	100%
	15	12	12	100%
	18.5	10	12	100%
	22	4	12	100%
	30	3	8	90%
	37	8	10	80%
	45	10	10	95%
	55	6	10	95%
	75	3	5	60%
	90	-	6	95%
	110	-	6	85%
	132	-	6	85%



### CAUTION

: Be sure to keep the above-mentioned table.

Otherwise, there is a danger of inverter unit breakage.

When using at 50°C of ambient air temperature, the rated output current will be reduced as below (Fig.reference).

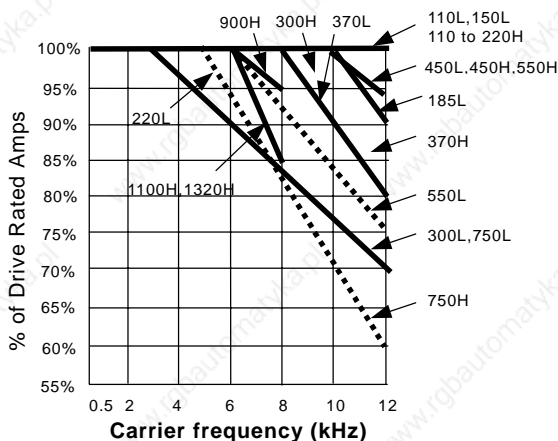
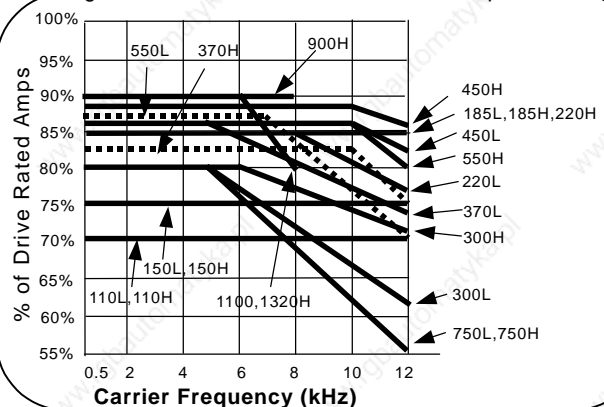

Fig.reference: at 50°C of ambient air temperature



## Chapter4 Explanation of function

### External analog input

This inverter has three kinds of external analog input terminals.

O-L terminal : 0 - 10Vdc      OI-L terminal : 4 - 20mA  
 O2-L terminal : -10 / 0 / +10V

Relation code

A005: AT terminal selection  
 A006: O2 Selection  
 C001-C005: Intelligent input terminal

The setting contents of this function is as follows.

Set item	Function code	Data	Contents
AT terminal selection	A005	00	Change of O/OI with AT terminal [ AT terminal ON : OI-L valid ] [ AT terminal OFF : O-L valid ]
		01	Change of O/O2 with AT terminal [ AT terminal ON : O2-L valid ] [ AT terminal OFF : O-L valid ]
O2 selection	A006	00	Single
		01	Auxiliary frequency command of O, OI(No reverse)
		02	Auxiliary frequency command of O, OI(Reverse)

Assign 16(AT) to intelligent input terminal. The frequency setting is the values from terminals O, OI and O2 when 16(AT) isn't assigned. The frequency set up when A006 is "00" becomes the value of O2. And, the frequency set up when A006 is "01" or "02" becomes the value which OI and O2 were added to. The following frequency command methods are available by combining A005, A006 with the intelligent input AT terminal.

In the case that reverse and FW(forward) terminals are ON, the inverter operates reversely when (main frequency command + auxiliary frequency command) < 0.

	A006	A005	AT terminal	Main frequency command	Existence of Auxiliary frequency command(O2-L)	Existence Of Reverse
Intelligent input terminal on assigning AT	00	00	OFF	O-L	No	No
			ON	OI-L	No	
		01	OFF	O-L	No	Yes
			ON	O2-L	No	
	01	00 (Example 1)	OFF	O-L	Yes	No
			ON	OI-L	Yes	
		01	OFF	O-L	Yes	Yes
			ON	O2-L	No	
02	00 (Example 2)	OFF	O-L	Yes	Yes	
		ON	OI-L	Yes		
	01	OFF	O-L	Yes	Yes	
		ON	O2-L	No		
Intelligent input Terminal when Don't assign AT	00	-	-	O2-L	No	Yes
	01	-	-	Adding O-L and OI-L	Yes	No
	02	-	-	Adding O-L and OI-L	Yes	Yes

(Example 1)

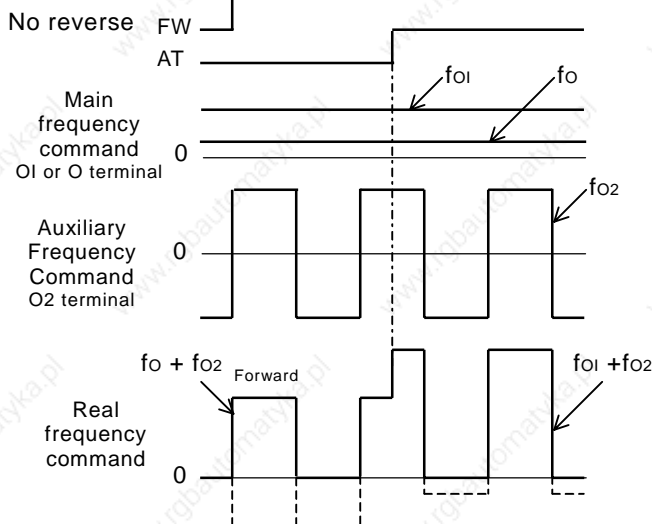

(Example 2)

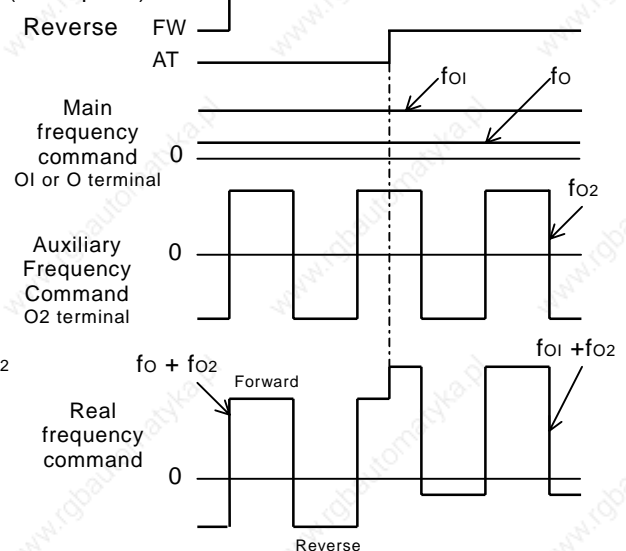

## Chapter4 Explanation of function

### Input frequency Start/End

External analog signal from the control terminals  
(frequency command)

O-L terminal : 0 - 10V

OI-L terminal : 4 - 20mA

O2-L terminal : -10 / 0 / +10V

Set output frequency for one of the above

(1) Start, End of O-L terminal, OI-L terminal

#### Relation code

A011: O start	A103: OI start rate
A012: O end	A104: OI end rate
A013: O start rate	A105: OI start selection
A014: O end rate	A111: O2 start
A015: O start selection	A112: O2 end
A101 : OI start	A113: O2 start rate
A102 : OI end	A114: O2 end rate

Set item	Function code	Data	Contents
O/OI start	A011/A101	0.00-400.0	Unit : Hz Set starting frequency
O/OI end	A012/A102	0.00-400.0	Unit : Hz Set ending frequency
O/OI start rate	A013/A103	0.-100.	Unit : % Set start rate for external frequency command 0-10V, 4-20mA
O/OI end rate	A014/A104	0.-100.	Unit : % Set end rate for external frequency command 0-10V, 4-20mA
O/OI start Selection	A015/A105	00	External start frequency Output frequency from 0 to A013/A103 outputs the value of A011/A101
		01	0Hz Output frequency from 0 to A013/A103 outputs the value of 0Hz

When the input is from 0 to 5V with O-L terminal, set A014 to 50%.

(Example 1) A015/A105 : 00

(Example 2) A015/A105 : 01

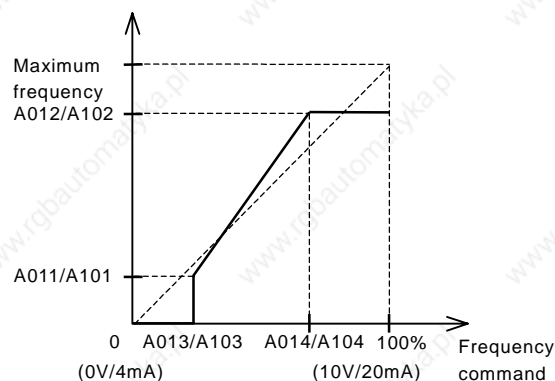
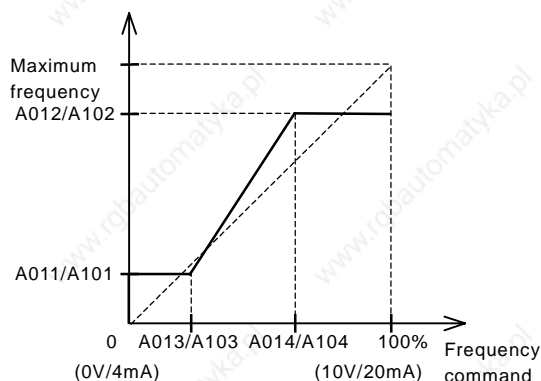

(2) Start, End of O2-L terminal

Set item	Function code	Data	Contents	Notes
O2 start	A111	-400.- 400.	Unit : Hz Set starting frequency	(Example 3)
O2 end	A112	-400.- 400.	Unit : Hz Set ending frequency	
O2 start rate	A113	-100.- 100.	Unit : % Set starting rate for external frequency command -10-10V (Note 1)	
O2 end rate	A114	-100.- 100.	Unit : % Set ending rate for external frequency command -10-10V (Note 1)	

(Note 1) The rates of -10V-10V is following.

-10V- 0V:-100-0%

0V-10V:0-100%

For example, in case of use with O2-L terminal, set -50% to A113, 50% to A114.

(Example 3)

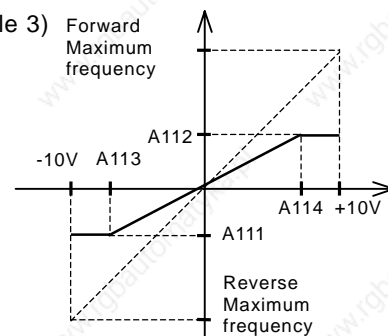

## Chapter4 Explanation of function

### Setting analog input filter

Set the internal filter of the frequency setting signal of voltage or current from the control terminals

It is important to first remove the source of the noise to the system.

When stable operation can not be achieved due to the effect of electrical noise, set a larger value.

The response will be slower by setting a larger value. The limit of setting is about 2ms-60ms( set value : 1-30)

Relation code  
A016: O, OI, O2 filter

Function code	Limit to set	Contents
A016	1.-30.	Can set with the 1 unit.

### Output voltage gain

Regarding the voltage selected on A082 motor voltage selection as 100 %, set the rate of the voltage which the inverter outputs for the voltage selected.

Relation code  
A045: Output voltage gain  
A082: Motor voltage selection

Function code	Limit to set	Contents
A045	20.-100.	Unit:%

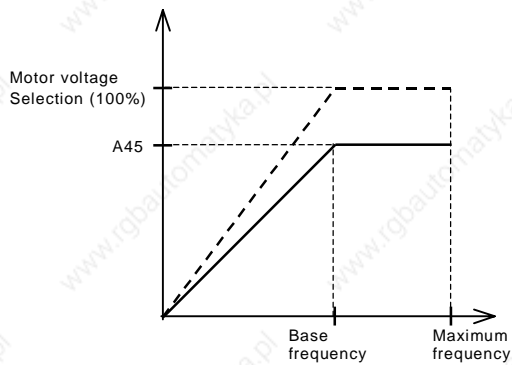



## Chapter4 Explanation of function

### (3) Free V/f setting

The free V/f setting sets optional V/f characteristics by setting the voltage and frequency in seven parts.(b100-b113)

The setting of free V/f setting operates always to be  $1 \leq 2 \leq 3 \leq 4 \leq 5 \leq 6 \leq 7$ .

Please set first free V/f setting 7 because the initial value is all 0Hz.

When the free V/f setting is valid, the function of torque boost(A041/A241), base frequency(A003/A203), maximum frequency(A004/A204) is invalid. (Free V/f frequency7 is treated as maximum frequency.)

Set item	Function code	Data	Contents
Free V/f frequency7	b112	0.- 400.	Unit : Hz
Free V/f frequency6	b110	0.- Free V/f frequency7	
Free V/f frequency5	b108	0.- Free V/f frequency6	
Free V/f frequency4	b106	0.- Free V/f frequency5	
Free V/f frequency3	b104	0.- Free V/f frequency4	
Free V/f frequency2	b102	0.- Free V/f frequency3	
Free V/f frequency1	b100	0.- Free V/f frequency2	
Free V/f voltage7	b113	0.0 - 800.0	Unit : V (Note 1)
Free V/f voltage6	b111		
Free V/f voltage5	b109		
Free V/f voltage4	b107		
Free V/f voltage3	b105		
Free V/f voltage2	b103		
Free V/f voltage1	b101		

(Example)

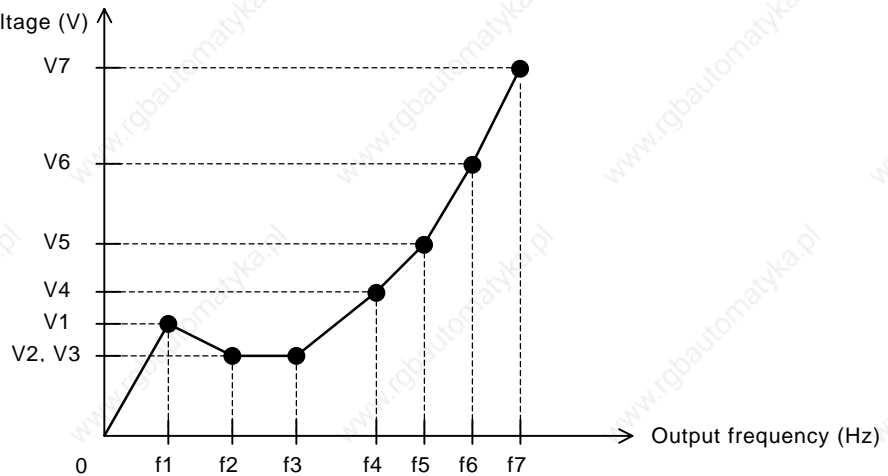

(Note 1) Even if you set 800V for free V/f voltage1-7, output of inverter can't be more than the input voltage or the AVR setting voltage.

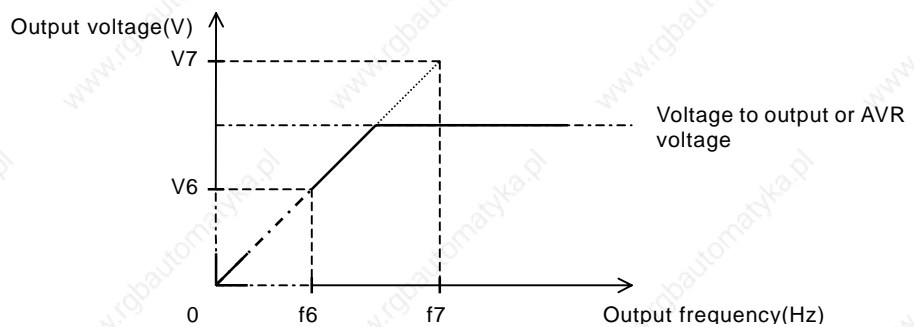

### Torque boost

A correctly installed motor and careful attention to voltage drop in the wiring will improve the motor torque at low speed. Setting of A041/A241 will select between manual torque boost and automatic torque boost, the level of torque boost corresponds to the set motor capacity selection (H003/H203) and the motor pole selection (H004/H204).

#### Relation code

A041/A241: 1<sup>st</sup>/2<sup>nd</sup> torque boost selection  
 A042/A242: 1<sup>st</sup>/2<sup>nd</sup> manual operation torque boost  
 A043/A243: 1<sup>st</sup> /2<sup>nd</sup> manual operation torque boost break point  
 H003/H203: 1<sup>st</sup>/2<sup>nd</sup> motor capacity selection  
 H004/H204: 1<sup>st</sup>/2<sup>nd</sup> motor pole selection

Set item	Function code	Data	Contents
Torque boost	A041/A241	00	Manual torque boost
		01	Automatic torque boost
Manual torque boost	A042/A242	0.0-20.0	Unit:% Level corresponding to output Voltage (100%)
Manual torque boost break point	A043/A243	0.0-50.0	Unit:% Level corresponding to base frequency

#### (1) Manual torque boost

The values set up with A042/A242 and A043/A243 is outputted.

A042/A242 sets a percentage level where the base frequency voltage is 100%.

The level set is the value of torque boost output voltage at 0 Hz.

When using the manual torque boost, it should be noted that overuse will cause saturation of the motor and may cause damage.

The manual torque boost break point is the frequency at which the voltage torque boost is switched off and normal operation resumes.

To change from A041 and A042 to A241 and A242 an intelligent input needs to be set to 08 (SET) and switched on.

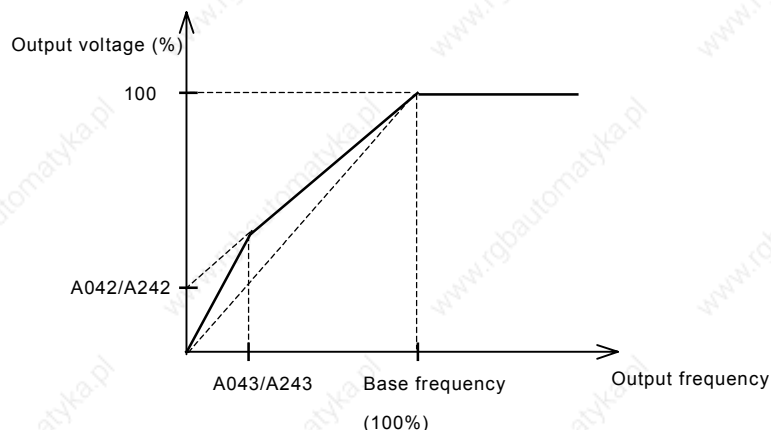

#### (2) Automatic torque boost

The output voltage is adjusted automatically by the condition of the load.

When using automatic torque boost it is important that the following two parameters are set correctly.

Set item	Function code	Setting limit	Contents
Motor capacity selection	H003/H203	0.20-75.0(11 to 75kW)	Unit : kW
		0.20-160.0(90 to 132kW)	
Motor pole selection	H004/H204	2/4/6/8	Unit : pole



## Chapter4 Explanation of function

### Direct current braking(DB)

A dc voltage can be applied to the motor windings in order to lock the motor shaft and avoid overrun at low speeds.

There are two methods of activating the dc braking,

Outside which is through the intelligent input terminals and Inside which is automatically started at a specific frequency.

#### Relation code

- A051: DC braking selection
- A052: DC braking frequency
- A053: DC braking late time
- A054: DC braking power
- A055: DC braking time
- A056: DC braking edge/level selection
- A057: Starting DC braking power
- A058: Starting DC braking time
- A059: DC braking carrier frequency

Set item	Functin code	Data	Contents
DC braking selection	A051	00	Inside DC braking : invalid
		01	Inside DC braking : valid
DC braking frequency	A052	0.00-60.00	Unit : Hz When the output reaches the set frequency and Inside DC braking is valid, DC braking is started.
DC braking late time	A053	0.0-5.0	Unit : second After DC braking time is reached, or DB terminal is ON, the late time is a delay before DC braking is started.
DC braking power/ Starting DC braking power	A054/A057	0.-70.	Unt : % Weak (Zero current) – Strong (Inverter rating fairly 70% the DC current)
DC braking time	A055	0.0-60.0	Unit : second The DC braking is stopped after this time delay has elapsed. The time is tarted when the late time has elapsed.
DC braking edge/level selection	A056	00	Edge movement (Example 1-6-a)
		01	Level movement (Example 1-6-b)
Starting DC braking time	A058	0.0-60.0	Unit : second It is valid for inside DC braking. When operating command is ON, DC current is started.
DC braking carrier Frequency	A059	0.5-12	Unit : kHz (11 to 75kW)
		0.5-8	Unit : kHz (90 to 132kW)

#### (1) DC braking carrier frequency

It is possible to alter the DC braking carrier frequency. However, if the DC braking carrier frequency is set higher than 3kHz, the value of maximum braking power level is automatically reduced as follows.

Set DC braking carrier frequency with A059.

##### i) 11 to 75kW

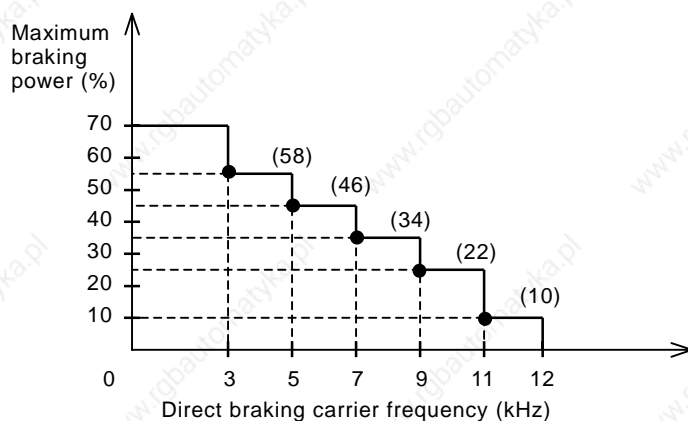

##### ii) 90 to 132kW

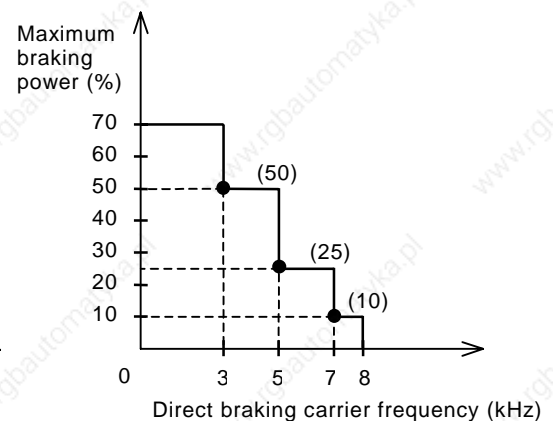

Direct braking power limiter

## Chapter4 Explanation of function

### (2) Outside DC braking

Set 07(DB) to an intelligent input terminal.

DC braking is then switched by ON/OFF of DB terminal irrespective of DC braking selection A051.

Set strength of DC braking power with A054.

If DC braking late time A053 is set, the Inverter output is cut off for this time period, the motor will be free running.

After the late time passes, DC braking is started.

Please set DC braking time A055 or DC braking time by DB terminal paying attention to the heat of the motor.

Please set each setting in accordance with the system, after level action or edge action are selected with A056.

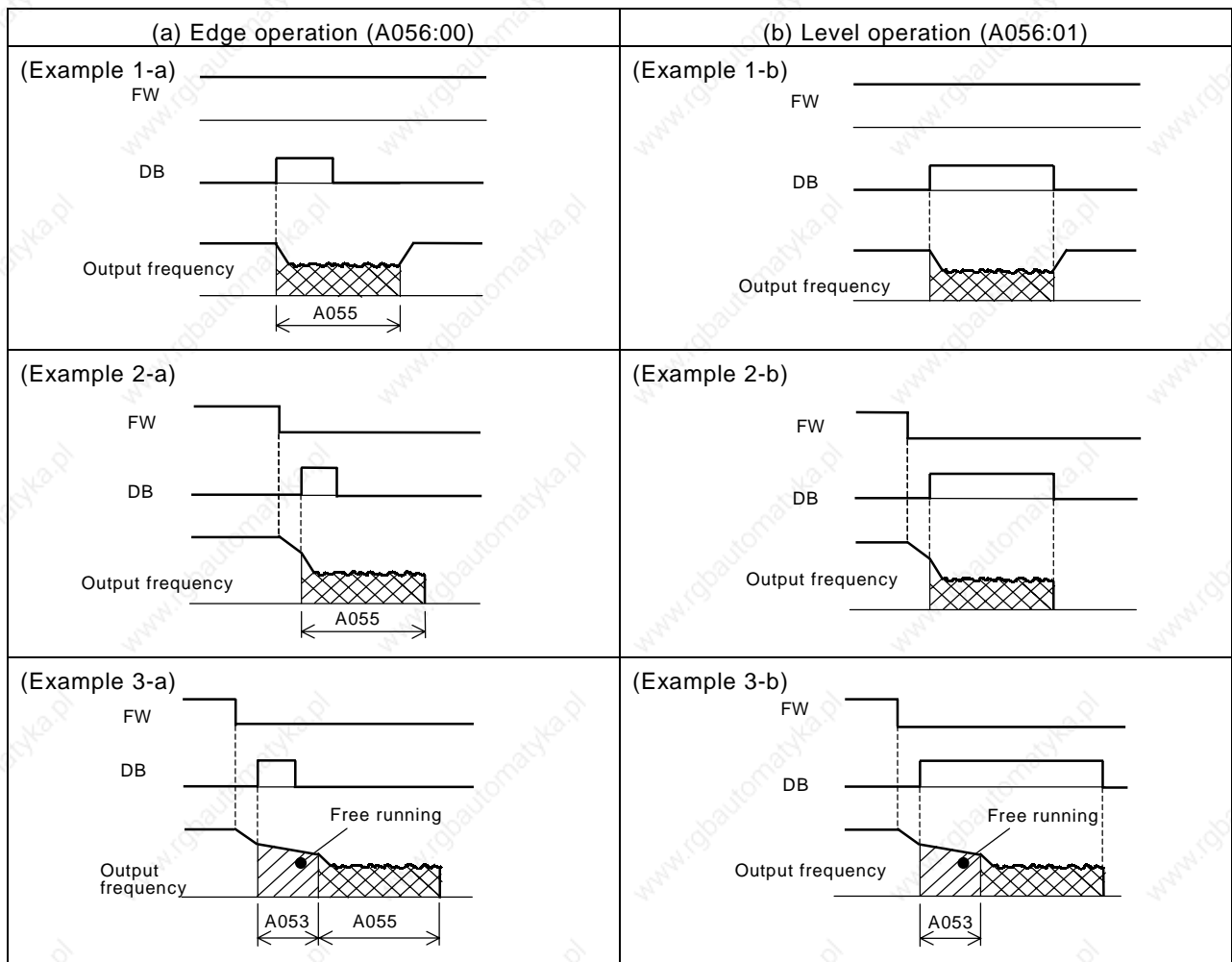

### (3) Inside DC braking

When the inverter starts, and the DB terminal is not ON the inverter can operate dc braking.

When using inside DC braking, the DC braking selection A051 should be set 01.

Starting DC braking power is set with A057, DC braking time at starting is set with A058.

Braking power setting except starting time, set with A054.

If DC braking late time A053 is set and the dc braking frequency is reached, the operating command (FW) is switched OFF. The inverter cuts the output and for the set time of A053, free running of the motor will occur.

After finishing the set time in A053, DC braking is started.

Set the frequency at which the DC braking will operate at with A052.

The operation of Edge/Level selection when using inside DC braking is different.

Edge action: Give priority to A055 DC braking action time, operate DC braking according to set time.

After turning operating command (FW) OFF, when output frequency reaches the set value of A052, during setting A055 DC braking is run. Even if operation command is turned ON, during setting time of A055, DC braking is run. (Example 5-a), (Example 6-a)

Level action: Give priority to operating command, ignore DC braking time A055 and move to normal operation. When operation command is turned ON during DC braking, set time of A055 is ignored and normal operation is restored. (Example 5-b), (Example 6-b)

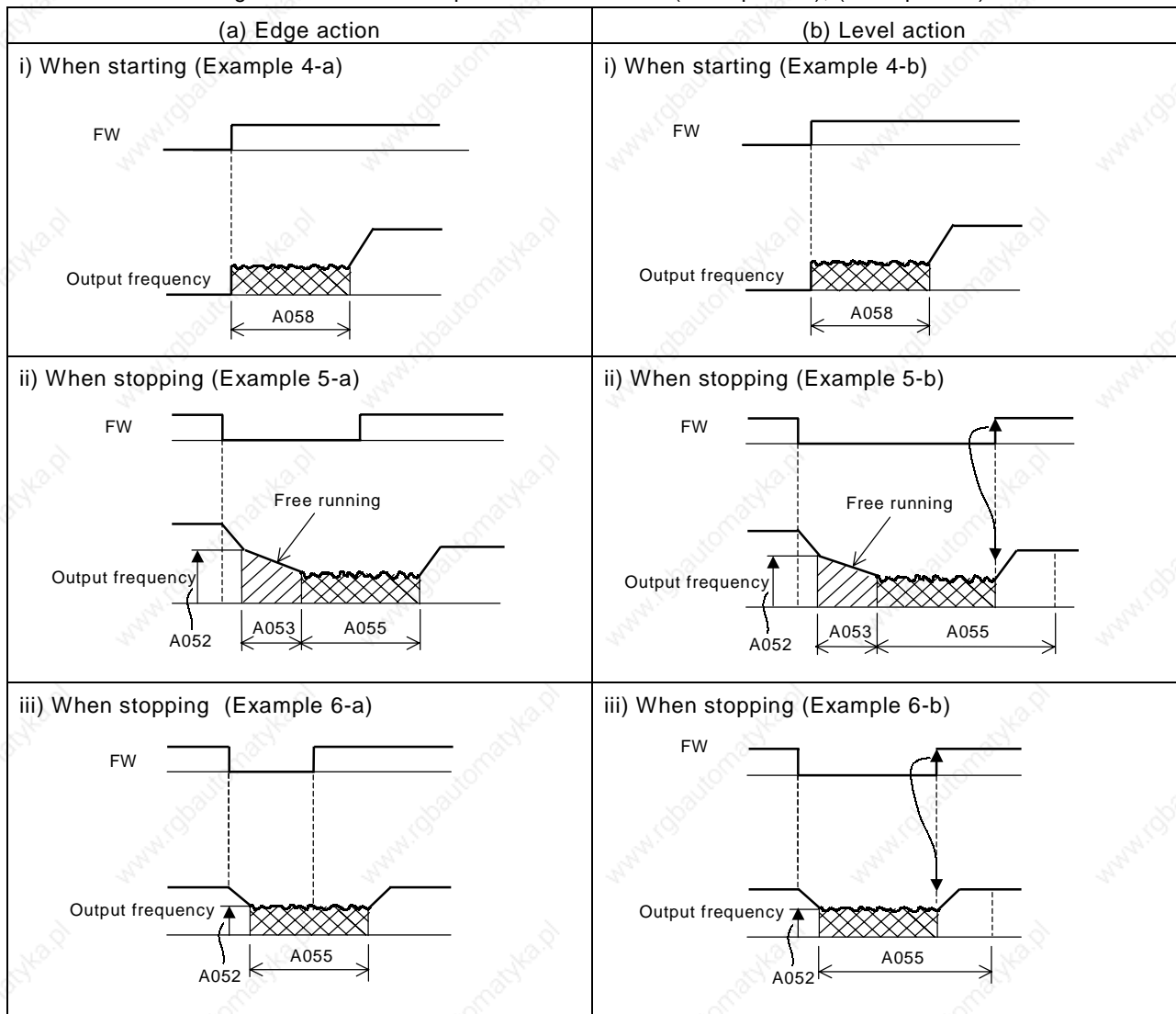

## Chapter 4 Explanation of function

### Frequency limiter

This function can set a maximum and minimum limit of the output frequency.

Even if a frequency command exceeds the maximum and minimum limiter the inverter will ignore this value and stop at the values set.

Set first maximum limiter on setting.

Be sure that the maximum limiter (A061/A261) > minimum limiter (A062/A262).

The maximum and minimum limiter will not operate if 0Hz is set.

Relation code
A061/A261: 1st/2 <sup>nd</sup> frequency maximum limiter
A062/A262: 1st/2 <sup>nd</sup> frequency minimum limiter

Set item	Function code	Setting limit	Contents
Frequency max. limiter	A061/A261	0.00, frequency min. limiter - max. frequency	Unit : Hz Setting max. of output frequency
Frequency min. limiter	A062/A262	0.00, starting frequency - max. limiter frequency	Unit : Hz Setting min. of output frequency

#### (1) In use O-L, OI-L case

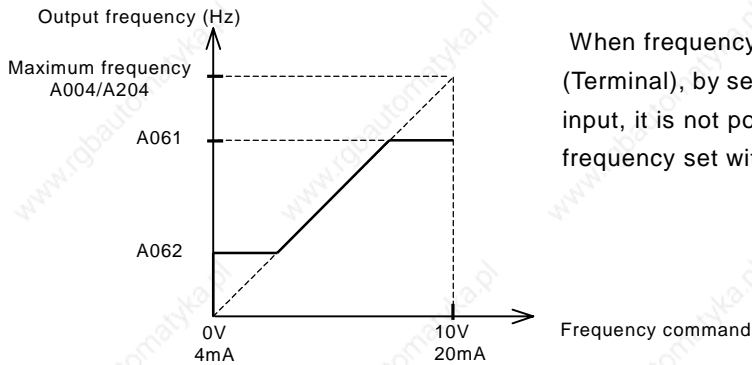

When frequency command is control terminal (Terminal), by setting Min. limiter, even if 0V is input, it is not possible to output less than the frequency set with Min. limiter.

#### (2) In use O2-L case

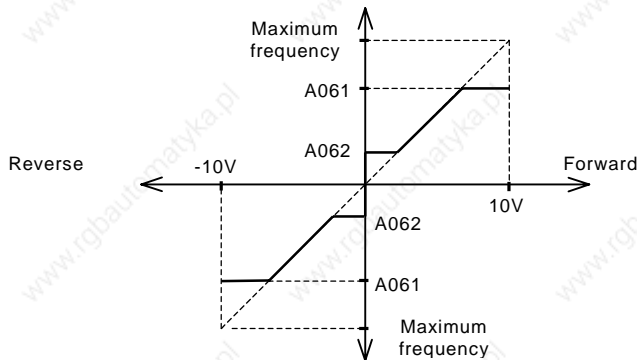

When using the minimum frequency limiter and 0v is inputted into O2 terminal, A062 applies to both forward and reverse directions.

#### (a) When operation command is control terminal (Terminal)(A002:01)

Terminal	Revolution when O2 is 0V
FW(ON)	A062 on forward side
RV(ON)	A062 on reverse side

#### (b) When operation command is operator (A002:02)

F004	Revolution when O2 is 0V
00	A062 on forward side
01	A062 on reverse side

## Chapter 4 Explanation of function

### Frequency jump function

Frequency jump can be used to avoid resonance points on machinery. Frequency jump is to jump the frequency command and avoid usual operation within the limit of the jump frequency. Output frequency changes continuously according to adjustable time. It is possible three different points are set for the jump frequency.

#### Relation code

A063: Jump frequency1  
 A064: Jump frequency band1  
 A065: Jump frequency2  
 A066: Jump frequency band2  
 A067: Jump frequency 3  
 A068: Jump frequency band3

Set item	Function code	Setting limit	Contents
Jump frequency 1/2/3	A063/A065/A067	0.00-400.0	Unit: Hz Set the frequency $f_j$ of center to jump.(Note)
Jump frequency Width 1/2/3	A064/A066/A068	0.00-10.00	Unit:Hz Set 1/2 value of frequency width to jump (Note)

(Note) The frequency to jump is  $f_j + 2$  (Hz).

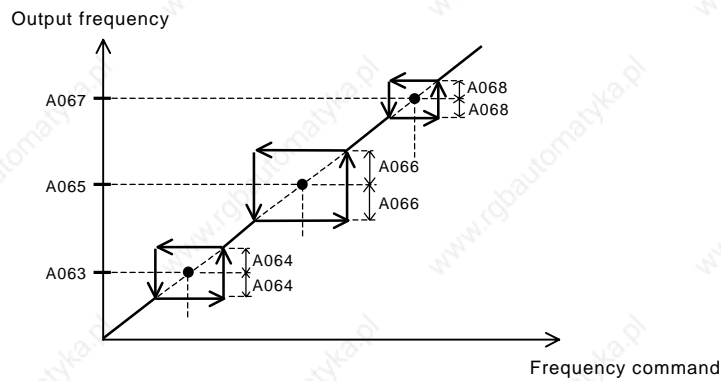

### Acceleration stop function

When the inertial moment of a load is high, this is the function to wait until the slip of the motor on starting becomes smaller. Use when the overcurrent trip occurs on starting.

#### Relation code

A069: Acceleration stop frequency  
 A070: Acceleration stop time

Set item	Function code	Data	Contents
Acceleration stop frequency	A069	0.00-400.0	Unit: Hz Set the frequency to be held.
Acceleration stop time	A070	0.0-60.0	Unit: second Set the time to hold the frequency.

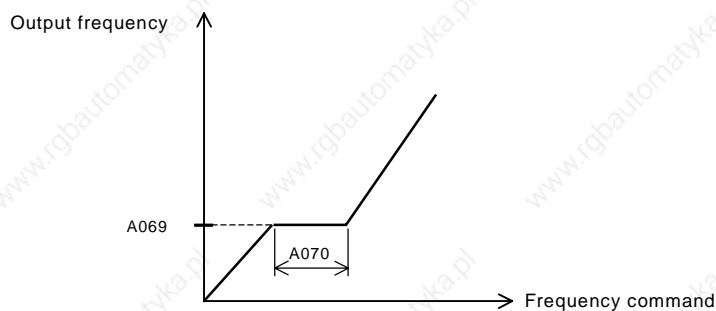

## Chapter 4 Explanation of function

### PID function

This integrated process control function can be used for controls such as constant flow and control for fan and pump applications.

When using this function set A071 to 01 and assign an intelligent input terminal to 23(PID terminal: (OFF)valid / (ON)invalid).

Set item	Function code	Data	Contents
PID selection	A071	00	Invalid
		01	Valid
PID P gain	A072	0.2-5.0	Proportional gain
PID I gain	A073	0.0-3600.	Integration Gain Unit: seconds
PID D gain	A074	0.00-100.0	Derivative gain Unit: seconds
PID scale	A075	0.01-99.99	Unit :times
PID feedback selection	A076	00	OI-L:4-20mA
		01	O-L :0-10V
Maximum PID Deviation level	C044	0.0-100.0	Unit :%

#### Relation code

A001	:Frequency command selection
A005	:AT selection
A006	:O2 selection
A071	:PID selection
A072	:PID P gain
A073	:PID I gain
A074	:PID D gain
A075	:PID scale
A076	:PID feedback selection
d004	:PID feedback monitor
C001-C005	:Intelligent input terminal
C021-C022	:Intelligent output terminal
C044	:PID deviation setting level

#### (1) Feedback selection

Select which analogue input terminals will be the feedback reference (A076).

Set the set frequency command selection with A001. (It should not be the same as the terminals selected with A076). Or when the control terminal 01 is set with A001, the setting of AT selection A005 is invalid.

The contents changes when O2 is selected with A006.

#### (2) Basic operation of PID control

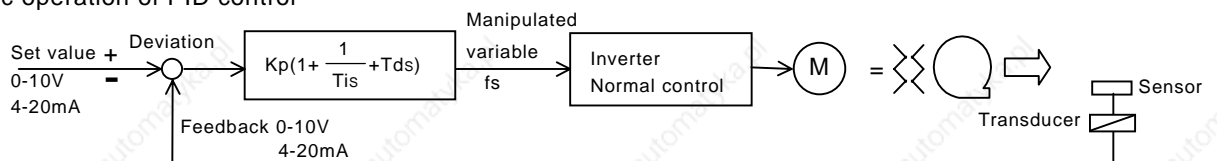

#### (3) Components of PID

Kp:Proportional gain, Ti:Reset time, Td:Rate time, s:Operator,  $\epsilon$  :Deviation

[1] P action This is the action that the manipulated variable is in proportion to the command.

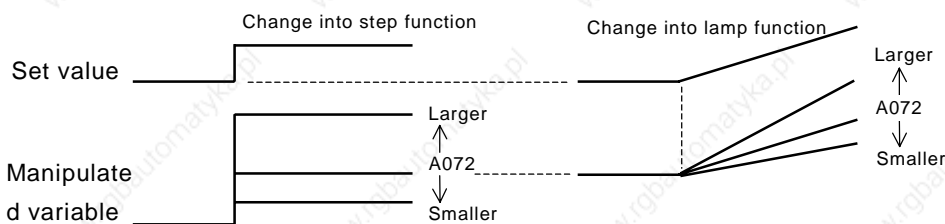

[2] I action This is the action that the manipulated variable increases with time in a straight line.

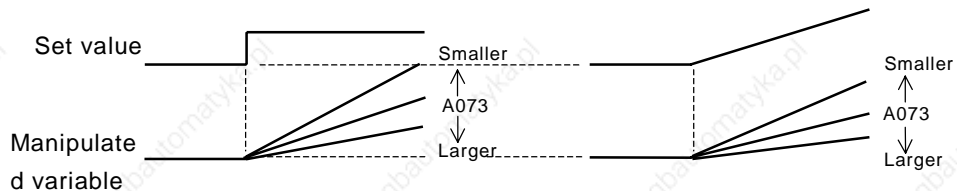

[3] D action This is the action that the manipulated variable is in proportion to the changing rate of command.

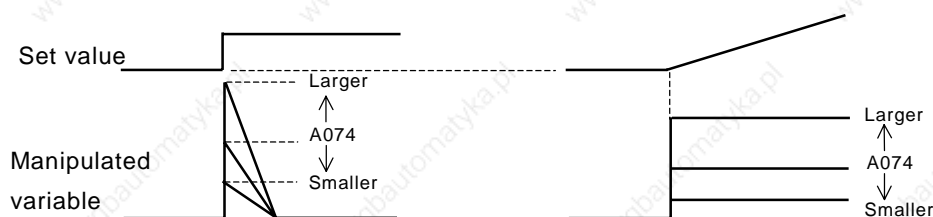

PI action combines above [1] and [2], PD action does [1] and [3], PID action does [1], [2] and [3].

### (4) The adjustment of gain

Please adjust each gain according to the state as the following, when the response on the functional operation PID is not stable.

- In spite of changing command, the change of feedback signal is slow.      —————>      Raise P gain.
- The feedback signal changes instantly but is not stable.      —————>      Lower P gain.
- The command and feedback signal doesn't coincide instantly.      —————>      Lower I gain.
- The feedback signal oscillates and is not stable.      —————>      Raise I gain.
- In spite of raising of P gain, the response is slow.      —————>      Raise D gain.
- When P gain is raised, the feedback signal oscillates and is not stable.      —————>      Lower D gain.

### (5) The Maximum PID Deviation Level/Output

It is possible to establish the maximum deviation level C044 on PID control. When the PID deviation amount reaches the set level C044, it is possible to set an intelligent output.

C044 can be set from 0 to 100 and corresponds with the command; from 0 to maximum.

Assign 04 (OD) to intelligent output terminal 11, 12(C021, C022).

### (6) Feedback monitor of PID

Feedback signal of PID can be monitored.

The monitor value can be displayed by the product of PID scale A075.

$$\text{"Monitor display"} = \text{"Feedback (\%)" } \times \text{"A075 setting"}$$

### (7) PID integral reset

This is the function to clear integral value of PID action.

Assign 24(PIDC) to intelligent input terminal.

It is cleared whenever PIDC is turned ON.

Don't turn absolutely ON PID terminal during PID action, because there is a possibility of overcurrent trip.

Turn ON PIDC terminal after turning OFF PID action.

## Automatic energy-saving operation function

This function regulates the inverter output power automatically to a minimum while operating at constant speed.

This fits for the load of reduced torque characteristic of fans or pumps.

In case of operating by this function, set A085 to "01".

A086 can adjust the automatic operation, response time.

#### Relation code

A085: Operation mode selection

A086: Energy-saving response-accuracy adjustment

Set item	Function code	Data	Contents
Operation mode selection	A085	00	Normal operation
		01	Energy-saving operation

Set item	Function code	Data	Response	Accuracy
Energy saving response / accuracy adjustment	A086	0 ↕ 100	Slow ↕ Fast	High ↕ Low

## Chapter 4 Explanation of function

### Two-stage acceleration and deceleration function (2CH)

By setting this function, it is possible to change the rate of acceleration and deceleration.

As methods to change the rate of acceleration and deceleration, you can select the method of changing by intelligent input terminal and the method of automatic changing by optional frequency.

In case of changing by intelligent input terminal, assign 09(2CH) to an Intelligent input terminal.

#### Relation code

F002/F202: 1<sup>st</sup> /2<sup>nd</sup> acceleration 1  
 F003/F203: 1<sup>st</sup> /2<sup>nd</sup> deceleration time 1  
 A092/A292: 1<sup>st</sup> /2<sup>nd</sup> acceleration time 2  
 A093/A294: 1<sup>st</sup> /2<sup>nd</sup> deceleration time 2  
 A094/A294: 1<sup>st</sup> /2<sup>nd</sup> two-stage acceleration and deceleration selection  
 A095/A295: 1<sup>st</sup> /2<sup>nd</sup> two-stage acceleration frequency  
 A096/A296: 1<sup>st</sup> /2<sup>nd</sup> two-stage deceleration frequency  
 C001-C005: Intelligent input terminal

Set item	Function code	Data	Contents
Acceleration time 2	A092/A292	0.01-3600.	Unit : second (Example 1,2)
Deceleration time 2	A093/A293	0.01-3600.	Unit : second (Example 1,2)
Two-stage acceleration and deceleration selection	A094/A294	00	Changing by intelligent input terminal 09 (2CH) (Example 1)
		01	Changing by two-stage acceleration and deceleration frequency (A095/A295, A096/A296) (Example 2)
Two-stage acceleration frequency	A095/A295	0.00-400.0	Unit: Hz It is valid when two-stage acceleration and deceleration selection (A094/A294) is 01. (Example 2)
Two-stage deceleration frequency	A096/A296	0.00-400.0	Unit: Hz It is valid when two-stage acceleration and deceleration selection (A094/A294) is 01. (Example 2)

(Example 1) In to set A094/A294 to 00 case

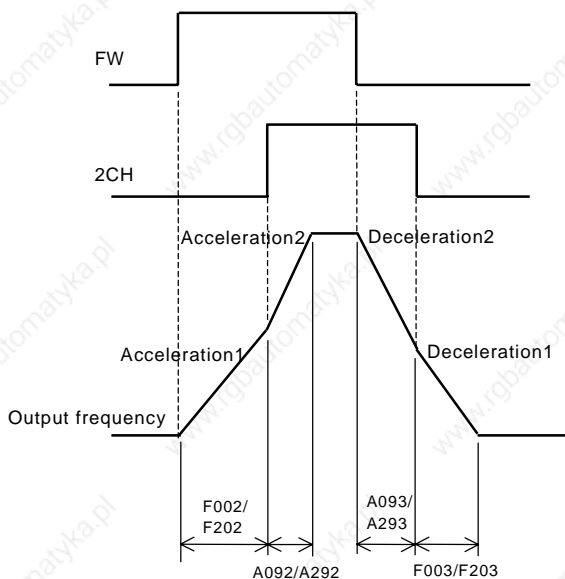

(Example 2) In to set A094/A294 to 01 case

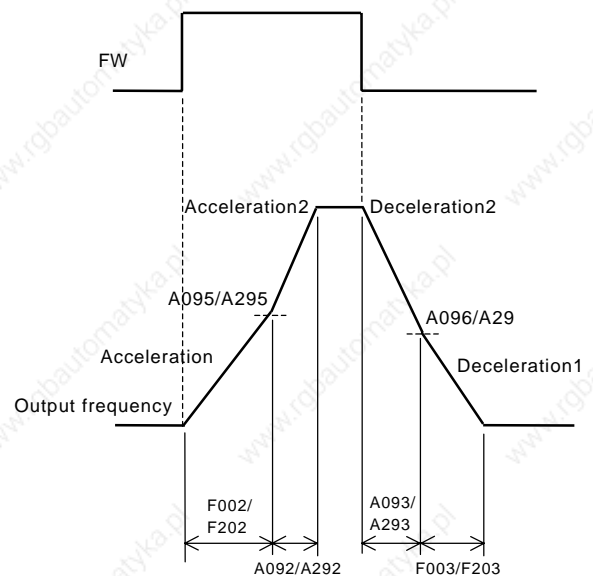



## Chapter4 Explanation of function

### Acceleration and deceleration pattern

#### (1) Selection of pattern

Pattern of acceleration and deceleration speed is possible to set up corresponding to each system.

Select the pattern of acceleration and deceleration with A097 and A098.

#### Relation code

A097: Acceleration pattern selection

A098: Deceleration pattern selection

A131: Acceleration curve constant

A132: Deceleration curve constant

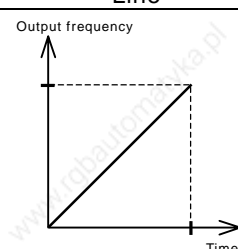
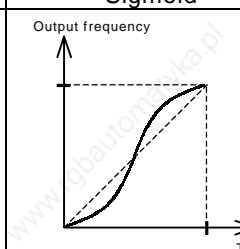
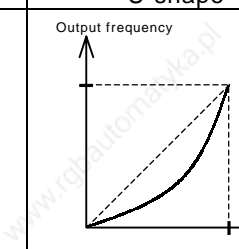
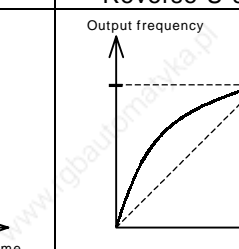
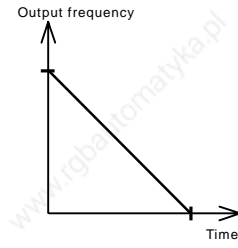
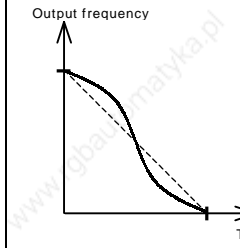
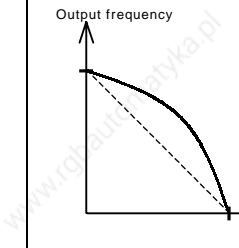
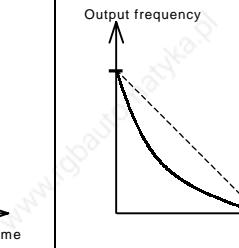
Set value	00	01	02	03
Curve	Line	Sigmoid	U-shape	Reverse U-shape
A097 (Acceleration)				
A098 (Deceleration)				
Contents	Accelerate and decelerate in line until output frequency set value.	Collapsing the cargo such as the going up and down machine, conveyor it uses it for prevention.	Cutting the tension control, rolled book such as the volume collector machine it uses it for prevention.	

It is possible to set the pattern of both acceleration, deceleration.

#### (2) The curve constant (the swelling degree)

It makes the rough sketch reference and please decide the swelling degree.

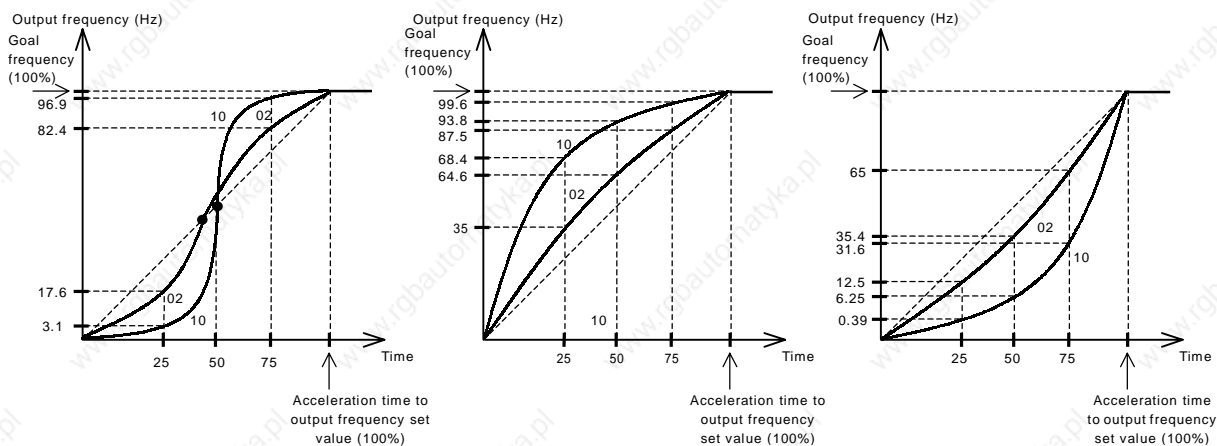

There is the range which the midway adjustable-speed time becomes fast in the S character pattern.

### Instantaneous power failure / under-voltage

Instantaneous stop and start

(1) You can select whether the inverter trips or retries (restart) when an instantaneous power failure/under-voltage occurs.

When retry function is selected with b001, and an instantaneous Stop/under-voltage trip occurs restart is tried 16 times and a trip will occur after 17 times.

And when retry function is selected, and an over-current or an over-voltage occurs, restart is tried 3 times and a trip will occur on the fourth time.

When an instantaneous power failure/under-voltage occurs, you can select execution of trip with b004.

To select a retry function with b001, set the following retry mode correspondent to each system.

Relation code	
b001	:Retry selection
b002	:Allowable under-voltage power failure time
b003	:Retry delay time
b004	:Instantaneous power failure under-voltage trip during stop
b005	:Instantaneous power failure under-voltage retry time time selection
b007	:frequency setting to match
C021-C022	:Intelligent output terminal
C026	:Alarm relay output

Set item	Function code	Data	Description
Retry selection	b001	00	Trip.
		01	Restart from 0Hz on retry.
		02	Start equaling frequency on retry. (Example 1)
		03	Start f-equaling and stop decelerating on retry. After stop, start trip. (Note 1)
Allowable under-voltage power failure time	b002	0.3-1.0	Units : second If the instantaneous power failure time is shorter than the set time, a restart will occur. (Example 1) If the instantaneous stop time is longer than set time, trip. (Example2)
Retry wait time	b003	0.3-100.	Units : second Delay before motor restart time.
Instantaneous power failure/under-voltage trip during stop (Note 2)	b004	00	Invalid Trip isn't caused and alarm isn't output.
		01	Valid Trip is cause and alarm is output.
		02	Invalid Trip isn't caused and alarm isn't output during stop and deceleration by stop command.
Instantaneous power failure/under-voltage retry time selection	b005	00	Restart to 16 times on instantaneous stop under-voltage.
		01	Restart freely on instantaneous stop under-voltage.
Frequency setting to match	b007	0.00-400.0	Units : Hz When the frequency of the motor during free-run is less than this set frequency, restart with 0Hz is caused. (Example 3,4)

(Note 1) When trip of the over voltage or over current etc. occurs in the deceleration midway an instantaneous power failure error (E16) is displayed and operates free-run. In this case make the deceleration time of long

(Note 2) When using control power supply terminal R0-T0 and connecting DC voltage (P-N) to R0-T0, an under-voltage may be detected at power off and give trip signal. If this may cause any problem to your system, set data in 00 or 02.

F-equaling start: The inverter reads the motor r/m and direction and restarts the inverter to match these readings.

## Chapter 4 Explanation of function

Retry function (b001: 02): The timing chart in case of selection is following.

- t0 : Instantaneous stop power failure
- t1 : Allowable under-voltage power failure time(b002)
- t2 : Retry waits time(b003)

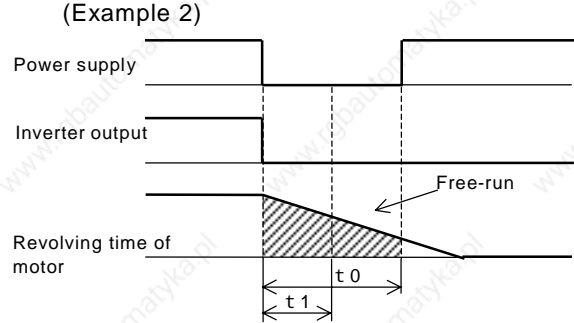
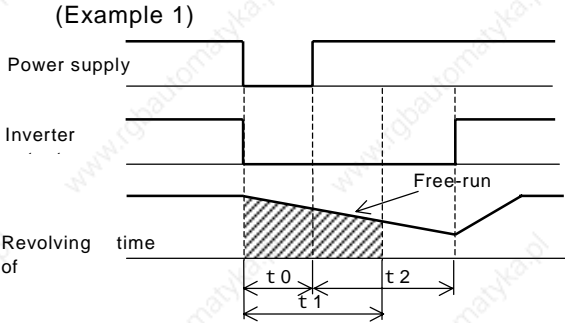

After wait for t2 seconds according to  $t_0 < t_1$ , restart.

Trip according to  $t_0 > t_1$ .

(Example 3) Motor frequency (revolution time) > b007

(Example 4) Motor frequency (revolution time) < b007

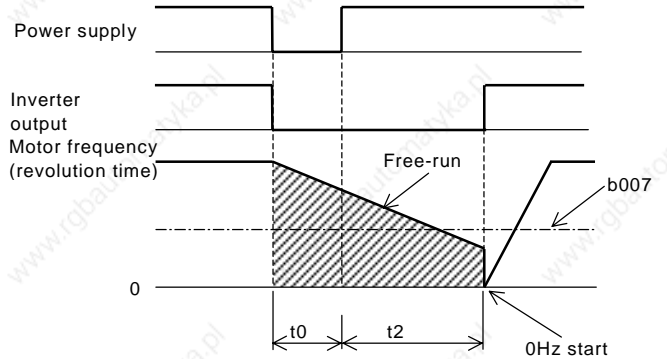
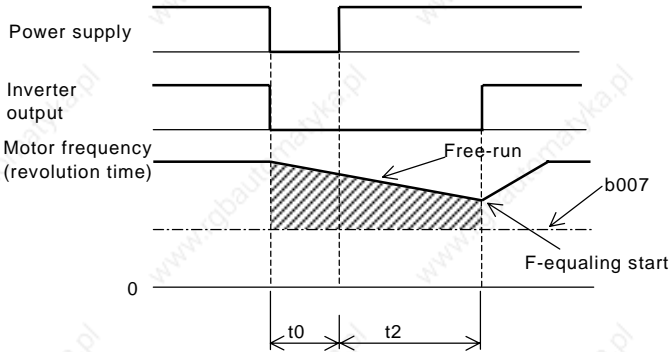

(2) Instantaneous power failure during stop alarm output during under-voltage

Select yes/no of alarm output when instantaneous power failure or under-voltage occurs with b004.

Alarm outputs while control power of inverter remains.

- Alarm output at an instantaneous power failure and under-voltage during standstill.

Standard (Example 5-7).

Alarm signal performance when connecting DC voltage (P-N) to R0-T0 terminal. (Example 8-10).

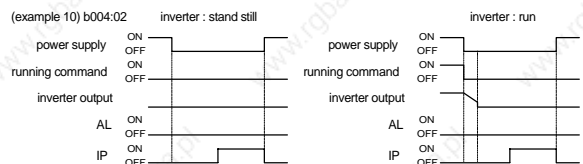
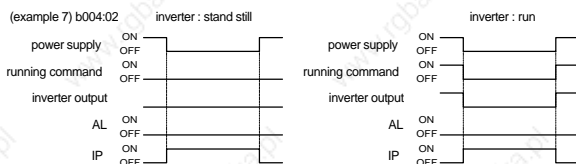
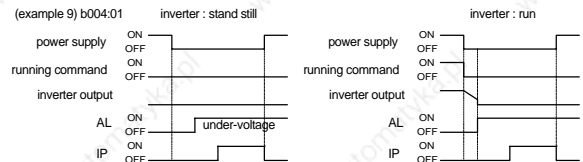
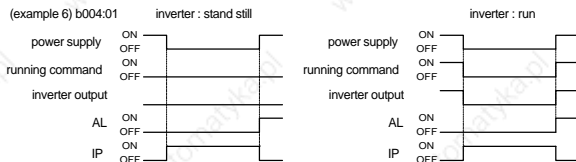
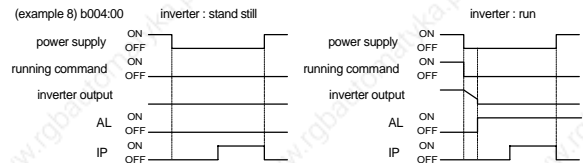
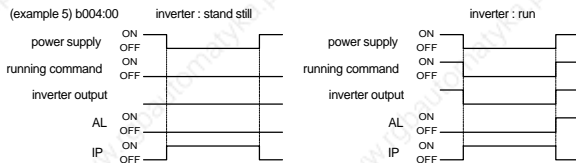

(3) It is possible to use an output by assigning the signal (IP: 08) during instantaneous stop, by setting (UV: 09) during under-voltage to an intelligent output terminal 11, 12(C021, C022) or alarm relay output terminal (C026).

(4) If the instantaneous power failure time is longer than 1 second, please refer to the pages 4-48 Reset (RS).

### Open phase protection function selection

This is the function to warn when the inverter input supplies opens.

Relation code  
b006:Open phase selection

Function code	Data	Description
b006	00	Invalid Don't trip when the input supplies opens.
	01	Valid Trip when the input supplies opens.

When an open phase occurs, there is a danger that the inverter could produce one of the following states;

- (1) Ripple current of main capacitor increases, life of main capacitor shortens remarkably.
- (2) In case of load, there is danger that the capacitors or thyristors inside the inverter could be damaged.
- (3) There is a risk that the in-rush resistor to limit the current inside the inverter may burn out.

### Electronic thermal function

Set the Inverter according to motor rated current to protect the motor from overloading, overheating and damage.

A warning signal is outputted before tripping on electronic thermal protection.

Relation code

- b012/b212:1<sup>st</sup>/2<sup>nd</sup> electric thermal level
- b013/b213:1<sup>st</sup>/2<sup>nd</sup> electric thermal characteristic selection
- b015/b017/b019:free electric thermal frequency 1/2/3
- b016/b018/b020:Free thermal current 1/2/3
- C021-C022: Intelligent output terminal
- C026: Alarm relay output terminal
- C061: Thermal warning level

#### (1) Electronic thermal level

Function code	Setting range	Description
b012/b212	Rated Current x 0.2 to Rated Current x 1.2	Units:A

(Example) L300P-110LFU

Motor current:44A

Setting range:8.8 to 52.8A

When electronic thermal level b012=44A,  
time limit characteristic is right diagram.

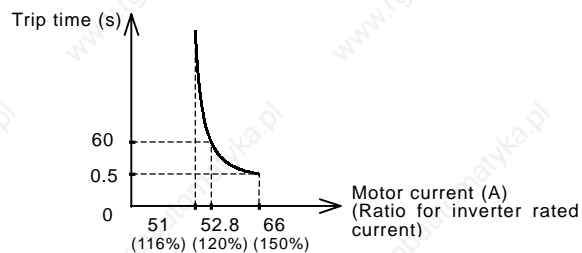

#### (2) Electronic thermal characteristic

Frequency characteristic is added up to set value of b012.

Function code	Data	Electronic thermal characteristic
b013/b213	00	Reduced torque characteristic
	01	Constant torque characteristic
	02	Free setting

When output frequency of general motor decreases, cooling function of self-cooled fan will fall.

Reduced torque characteristic is calculated according to heat of a HITACHI general motor.

## Chapter 4 Explanation of function

### (a) Reduced torque characteristic

To add to the time limit characteristic set with the reduced time rate b012/b212 by each frequency.

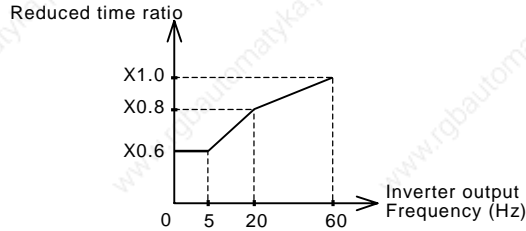

(Example) b012 = 44(A), when output frequency = 20Hz

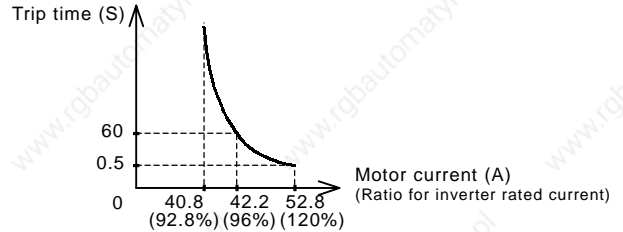

### (b) Constant torque characteristic

Set this in to use constant torque motor case.

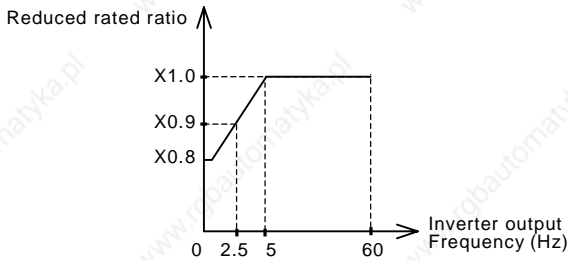

(Example) b012 = 44(A), when output frequency=2.5Hz.

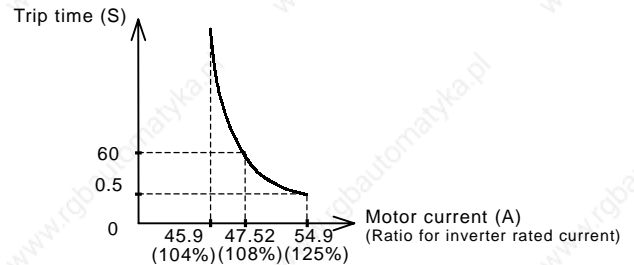

### (3) Free/thermal characteristic

It is possible to set the electronic thermal characteristic freely according to the load in order to protect the motor and the Inverter.

Setting range is shown as follows;

Set item	Function code	Set range	Description
Free electronic thermal frequency 1/2/3	b015/b017/b019	0 to 400	Units : Hz
Free electronic thermal current 1/2/3	b016/b018/b020	0.0 0.1 to 999.9	disable Units : A

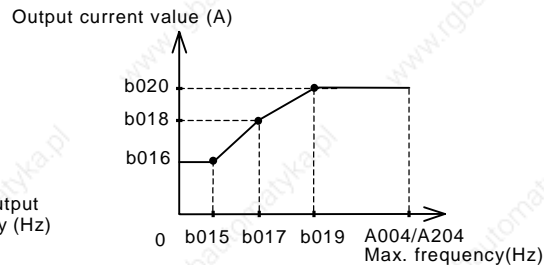
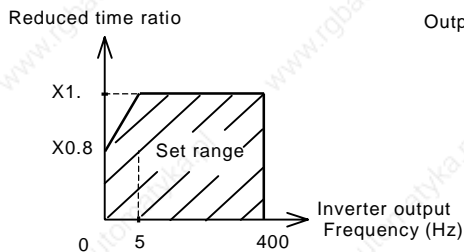

(Example) b012=44(A), output frequency=b017

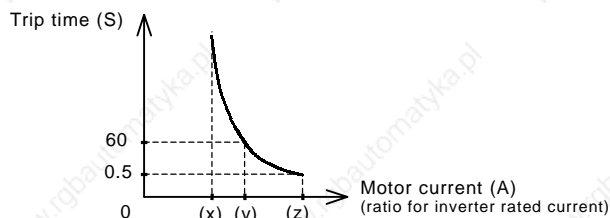

(x):b018x116%

(y):b018x120%

(z):b018x150%

### (3) Thermal warning

A warning signal is outputted before overheat protection by the electronic thermal protection occurs.

Warning level is set with C061.

Assign 13(THM) to an intelligent output terminal (C021, C022) or the alarm relay output (C061).

Function code	Data	Description
C061	0. 1.-100.	Thermal warning is noneffective Units : %

### Overload restriction/Overload advance notice

#### (1) Overload restriction

The Inverter monitors the motor current on acceleration and constant speed,

When the inverter reaches the overload restriction level, the Inverter will reduce the output frequency automatically to restrict the overload.

This function prevents an over-current trip by inertia during acceleration or radical changes in load at constant speed.

Two kinds of overload restriction function are set with b021, b022, b023 and b024, b025, b026.

To change b021, b022, b023 and b024, b025, b026, assign 39(OLR) to an intelligent input terminal.

The current value this function operates at is set in overload restriction level.

The overload restriction constant is the time to decelerate to 0Hz from max. frequency.

b021, b022, b023 and b024, b025, b026 is changed with OLR.

As this function operates, the acceleration time is longer than setting time.

If the overload restriction constant is set too short, in spite of accelerating, an over-voltage trip is caused with regenerative energy from the motor on automatic deceleration by this function.

When this function operates in the midst of accelerating, the frequency will not reach the goal frequency, the Inverter will adjust in the following way.

- Make acceleration time longer.
- Raise torque boost.
- Raise overload restriction level.

#### Relation code

b021:Overload restriction selection  
 b022:Overload restriction level  
 b023:Overload restriction constant  
 b024:Overload restriction 2 selection  
 b025:Overload restriction level2  
 b026:Overload restriction constant2  
 C001-C005: Intelligent input terminal  
 C021-C022: Intelligent output terminal  
 C026: Alarm relay output setting  
 C040: Overload advance notice signal output mode  
 C041: Overload notices level

Set item	Function code	Data	Description
Overload restriction Selection.	b021/b024	00	Invalid
		01	Acceleration/valid on constant speed.
		02	Valid on constant speed.
Overload restriction Level.	b022/b025	Rated current x 0.5 to Rated current x 1.5	Units :A Current value overload restriction operates.
Overload restriction Constant.	b023/b026	0.1 to 30.0	Units :second Deceleration time when overload restriction Operates.



### Start frequency

This frequency is the value the operator must set before the Inverter will give an output.

Mainly used when an operator adjusts the start torque.

By setting the start frequency higher, direct starting is caused and the starting current increases. Therefore an overload is within the restriction range and the inverter has a tendency to trip on over-current protection.

Relation code

b082:Start frequency

Function code	Set range	Description
b082	0.10 to 9.99	Units : Hz

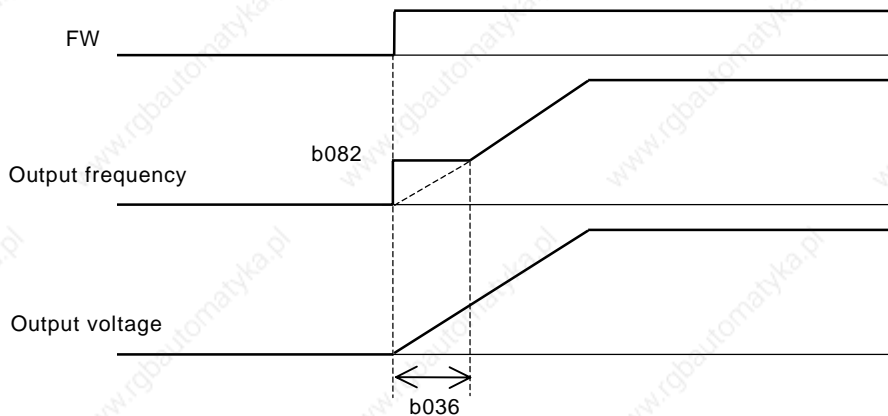

### Reduced voltage start selection

This function is to raise the voltage slowly on motor starting.

The lower this value the more torque is available on starting.

However, by making this value lower, the inverter has a tendency of tripping on over-current protection, because of almost direct starting.

Relation code

b036:Reduced voltage

start selection

b082:Start frequency

Function code	Data	Time to take for reduced voltage starting
b036	00	No reduced voltage start
	01	Short (about 6ms)
	06	Long (about 36ms)

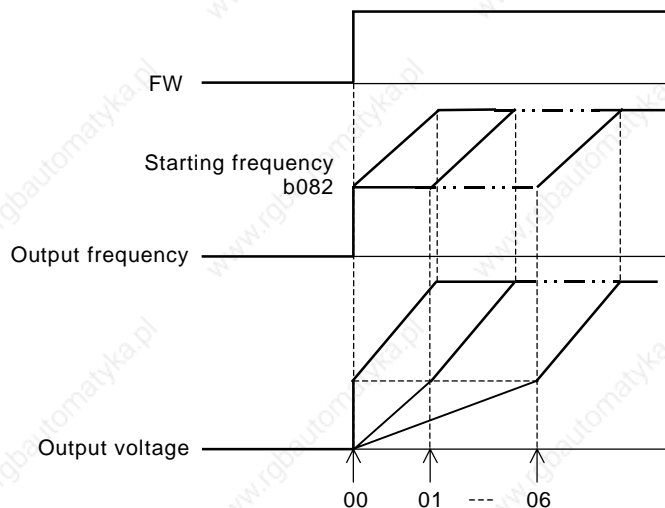



## Chapter 4 Explanation of function

### BRD (dynamic braking) function

This function only operates with the L300P - 15kW and lower, as they have the built-in BRD.

This function is to consume regenerative energy from the motor as heat by the use of an external resistor.

Regeneration occurs when the motor is decelerated to quickly and the motor turns into a generator and voltage flows back into the Inverter.

To use the BRD function, set following condition.

#### Relation code

b090: BRD usage ratio  
b095: BRD selection  
b096: BRD On level

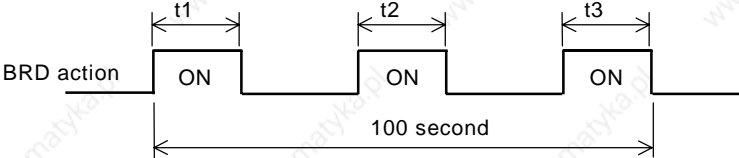
Set item	Function code	Data	Description
BRD usage Ratio	b090	0.0	BRD don't operate.
		0.1-100.0	<p>The usage ratio of BRD is set by 0.1% unit. When inverter exceeds the usage ratio, trip.</p>  $\text{Usage ratio (\%)} = \frac{(t1+t2+t3)}{100 \text{ second}} \times 100$
Selection of BRD	b095	00	BRD don't operate.
		01	During run: valid (BRD operates.) During stop: invalid (BRD doesn't operate.)
		02	During run, stop, valid (BRD operates.)
BRD ON Level	b096	(Note 1) 330-380	Units: V In case of 200V class inverter, setting is valid.
		(Note 1) 660-760	Units: V In case of 400V class inverter, setting is valid.

(Note 1) BRD ON level is the voltage setting of the DC (direct current) voltage of the inverter.

### Cooling fan operating selection

You can select whether the fan operates continuously or operates only when the inverter is in the running operation.

#### Relation code

b092: Cooling fan operation selection

Function code	Data	Description
b092	00	Always run
	01	Only during run However, inverter operates for five minutes after power ON, and for five minutes after inverter operation stops.

## Chapter 4 Explanation of function

### Intelligent input terminal setting

It is possible to operate functions by assigning those functions to the intelligent input terminals 1-5 (C001-C005).

Relation code  
C001-C005: Intelligent input terminal

The intelligent input terminals 1-5 can be selected individually whether the contact input specification is either a NO or a NC contact.

Two or more intelligent input terminals can't be assigned to be the same function.

If an intelligent input is assigned a function which is already assigned to another terminal it will automatically be restored back to the setting before.

Function Code	Data	Description	Reference item	Page
C001- C005	01	RV:Reverse command	Operation run	4-14
	02	CF1:Multi-speed 1 (binary operation)	Multi-speed operation function	4-43
	03	CF2:Multi-speed 2 (binary operation)		
	04	CF3:Multi-speed 3 (binary operation)		
	05	CF4:Multi-speed 4 (binary operation)		
	06	JG:Jogging	Jogging operation	4-44
	07	DB:External DC braking	DC braking(external DC braking)	4-26
	08	SET:2 <sup>nd</sup> Set of Motor Data	2 <sup>nd</sup> Set of Motor Data	4-45
	09	2CH:Two-stage adjustable-speed	Two-stage adjustable-speed function	4-32
	11	FRS:Free-run stop	Free-run stop	4-46
	12	EXT:External trip	External trip	4-50
	13	USP:Unattended start protection	Unattended start protection function	4-49
	14	CS:Commercial change	Commercial change	4-47
	15	SFT:Software lock (control terminal)	Software lock	4-45
	16	AT:analog input voltage/current select	Analog external input	4-19
	18	RS:Reset inverter	Reset inverter	4-48
	20	STA:3 wire start	3 wire input function	4-50
	21	STP:3 wire stop		
	22	F/R:3 wire direction		
	23	PID:PID selection (valid/invalid)	PID function	4-30
	24	PIDC:PID integrating reset		
	27	UP:Remote control UP function	UP/DOWN function	4-49
	28	DWN:Remote control DOWN function		
	29	UDC:Remote control data clear		
	31	OPE:force operation ope	force operation ope function	4-55
	32	SF1:Multi-speed 1 (bit run)	Multi-speed operation function	4-43
	33	SF2:Multi-speed 2 (bit run)		
	34	SF3:Multi-speed 3 (bit run)		
	35	SF4:Multi-speed 4 (bit run)		
	36	SF5:Multi-speed 5 (bit run)		
37	SF6:Multi-speed 6 (bit run)			
38	SF7:Multi-speed 7 (bit run)			
39	OLR:Overload restriction change	Overload restriction	4-38	
no	NO:No assign	-	-	

### Input terminal a/b (NO/NC) selection

It is possible to set a contact input or b contact input to intelligent input terminals 1-5 and FW terminals individually.

Set item	Function code	Data	Description
Intelligent input 1-5 a/b(NO/NC)selection	C011-C015	00	A contact(NO)
		01	B contact(NC)
Input FW a/b(NO/NC)selection	C019	00	A contact(NO)
		01	B contact(NC)

Relation code  
C011-C015: Intelligent input a/b (NO/NC) selection  
C019 :Input FW a/b (NO/NC) selection

a contact: "ON" with Close, "OFF" with Open  
b contact: "ON" with Open, "OFF" with Close  
RS terminal can set only a contact.

### Multi-speed operation function

It is possible to set multiple operation speeds and switch between the speeds with the terminals.

Multi-speed operation can be selected by binary operation(max. 16 speeds) with 4 terminals or by bit operation (max. 6 speeds) with 5 terminals.

#### Relation code

A019: Multi-speed selection  
 A020/A220: 1st/2<sup>nd</sup>/multi-stage speed zero speed  
 A021-A035: Multi-speed 1-15  
 C001-C005: Intelligent input terminal

Set item	Function code	Set value	Description
Multi-speed selection	A019	00	Change to binary operation 16 speed.
		01	Change to bit operation 6 speed
Multi-speed 0-15	A020/A220-A035	0.00, start frequency-max. frequency	Units:Hz

#### (1) Binary operation

It is possible to set multi-speed 0 to 15 by selecting 02 to 05 (CF1 to CF4) on the intelligent input terminals.

Set frequency setting for speed 1 to 15 with A021-A035.

Set 0 speed with A020/A220 or F001 when frequency command is operator.

Or when frequency command is control terminal (Terminal), set with O, OI, O2 terminal.

Multi-speed	CF4	CF3	CF2	CF1
0 speed	OFF	OFF	OFF	OFF
1 speed	OFF	OFF	OFF	ON
2 speed	OFF	OFF	ON	OFF
3 speed	OFF	OFF	ON	ON
4 speed	OFF	ON	OFF	OFF
5 speed	OFF	ON	OFF	ON
6 speed	OFF	ON	ON	OFF
7 speed	OFF	ON	ON	ON
8 speed	ON	OFF	OFF	OFF
9 speed	ON	OFF	OFF	ON
10 speed	ON	OFF	ON	OFF
11 speed	ON	OFF	ON	ON
12 speed	ON	ON	OFF	OFF
13 speed	ON	ON	OFF	ON
14 speed	ON	ON	ON	OFF
15 speed	ON	ON	ON	ON

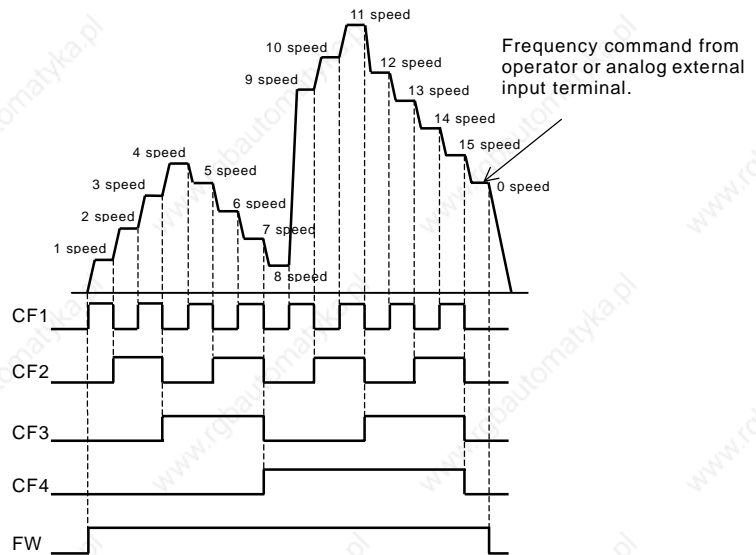

#### (2) Bit operation

It is possible to set multi-speed 0 to 5 by assigning 32 to 38 (SF1-SF7) to the intelligent input terminals.

Set frequency SF1-SF7 to A021-A027.

Multi-speed	SF7	SF6	SF5	SF4	SF3	SF2	SF1
0 speed	OFF	OFF	OFF	OFF	OFF	OFF	OFF
1 speed	-	-	-	-	-	-	ON
2 speed	-	-	-	-	-	ON	OFF
3 speed	-	-	-	-	ON	OFF	OFF
4 speed	-	-	-	ON	OFF	OFF	OFF
5 speed	-	-	ON	OFF	OFF	OFF	OFF
6 speed	-	ON	OFF	OFF	OFF	OFF	OFF
7 speed	ON	OFF	OFF	OFF	OFF	OFF	OFF

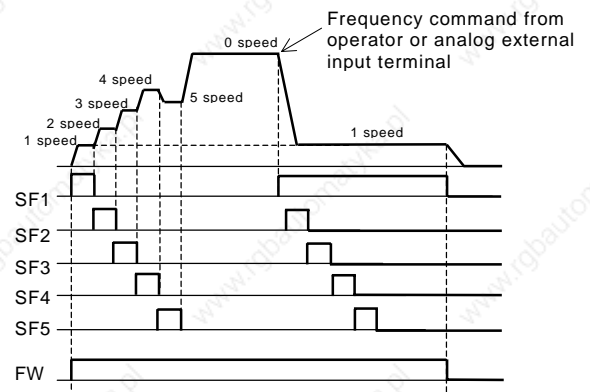

When each terminal turns ON simultaneously, the lower number has priority. In order for the inverter to operate both the frequency and the RUN operation (FW,RV) must be applied.

The L300P series can allocate it to 5 biggest terminals simultaneously.

### Jogging operation(JG)

This function can be used to rotate the motor in small steps to allow fine-tuning.

Set an intelligent input terminal to 06(JG).

#### Relation code

A038	: Jogging frequency
A039	: Jogging selection
C001-C005	: Intelligent input setting

#### (1) Jogging frequency

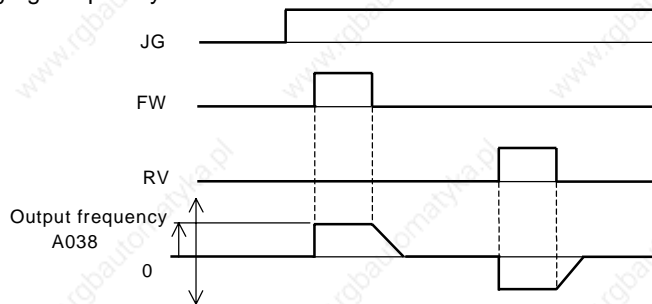

The jogging operation does not use acceleration, therefore it would be advisable to set the jogging frequency to limit the starting current to a minimum or tripping may occur. Adjust A038 to the jogging frequency required.

Function code	Data	Description
A038	0.0, start frequency-9.99	Units:Hz

#### (2) Jogging operation selection

Function code	Data	Description	Jogging operation during run Valid / Invalid
A039 (Note 2)	00	Free-run on jogging stop	Invalid (Example 1) (Note 1)
	01	Decelerating stop on jogging stop.	
	02	Direct braking on jogging stop.	
	03	Free-run on jogging stop.(example2)	Valid (Example 2) (Note 1)
	04	Decelerating stop on jogging stop.	
	05	Direct braking on jogging stop.	

(Note 1) When using the jogging function, turn FW terminal or RV terminal ON after the JG terminal is turned ON. (It is the same when the operation command point is from the operator.)

##### (Example 1)

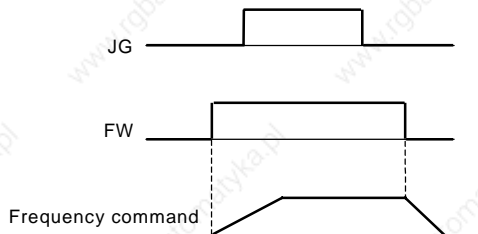

When setting of A039 is 00,01 or 02 and FW signal is turned ON beforehand, the inverter doesn't operate jogging.

##### (Example 2)

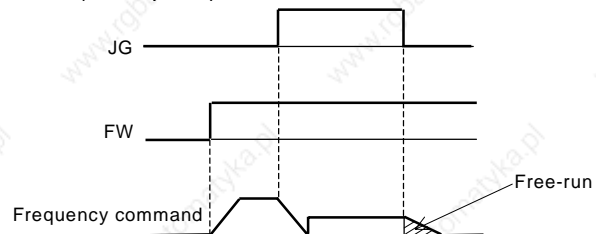

When setting of A039 is 03,04 or 05 and FW terminal is turned ON beforehand, the inverter operates jogging. But jogging terminal is turned ON beforehand, the inverter output is cut off.

(Note 2) In the case that the setting of A039 is 02 or 05, data setting of DB is necessary.

When DB data is not setting,the inverter operates Free-run.

### Second control function(SET)

This control function is used when the Inverter is connected to two different types of motors. By assigning 08(SET) to an intelligent input terminal and turning SET terminal ON/OFF you can switch between two different Inverter set-ups.

Select 2<sup>nd</sup> control function while the Inverter is in the STOP condition.

The functions which can change with SET terminal

- F002/F202 : 1<sup>st</sup> / 2<sup>nd</sup> acceleration time
- F003/F203:1<sup>st</sup> / 2<sup>nd</sup> deceleration time
- A003/A203:1<sup>st</sup> / 2<sup>nd</sup> base frequency
- A004/A204:1<sup>st</sup> / 2<sup>nd</sup> max. frequency
- A20/A220:1<sup>st</sup> / 2<sup>nd</sup> multi-speed 0 setting
- A041/A241:1<sup>st</sup> / 2<sup>nd</sup> torque boost selection
- A042/A242:1<sup>st</sup> / 2<sup>nd</sup> manual torque boost
- A043/A243:1<sup>st</sup> / 2<sup>nd</sup> manual torque boost point
- A044/A244:1<sup>st</sup> / 2<sup>nd</sup> control system
- A061/A261:1<sup>st</sup> / 2<sup>nd</sup> frequency maximum limiter
- A062/A262:1<sup>st</sup> / 2<sup>nd</sup> frequency minimum limiter
- A092/A292:1<sup>st</sup> / 2<sup>nd</sup> acceleration time 2
- A093/A293:1<sup>st</sup> / 2<sup>nd</sup> deceleration time 2
- A094/A294:1<sup>st</sup> / 2<sup>nd</sup> two-stage adjustable speed selection
- A095/A295:1<sup>st</sup> / 2<sup>nd</sup> two-stage acceleration frequency
- A096/A296:1<sup>st</sup> / 2<sup>nd</sup> two-stage deceleration frequency
- b012/b212:1<sup>st</sup> / 2<sup>nd</sup> electronic thermal level
- b013/b213:1<sup>st</sup> / 2<sup>nd</sup> electronic thermal characteristic selection
- H003/H203:1<sup>st</sup> / 2<sup>nd</sup> allowable motor selection
- H004/H204:1<sup>st</sup> / 2<sup>nd</sup> allowable motor pole selection
- H006/H206:1<sup>st</sup> / 2<sup>nd</sup> stabilized constant

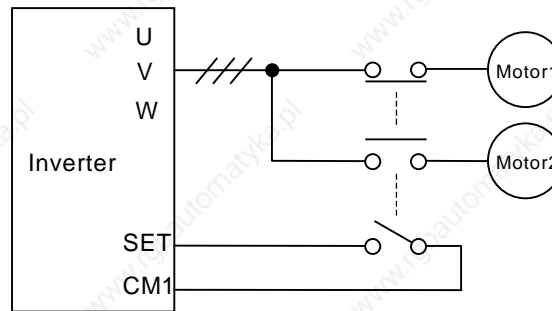

Display during setting isn't differentiated between the 1<sup>st</sup> control function or the 2<sup>nd</sup> control function. So confirm it in the state of ON/OFF of terminal.

Even if 1<sup>st</sup> / 2<sup>nd</sup> control is changed during run, it will not be active until the inverter is stopped.

### Software lock mode selection(SFT)

This function is used to prevent changing data by mistake.

When you want to use an intelligent input terminal, assign 15(SFT).

Below is the software lock code selection.

Relation code

b031 :Software lock mode selection

C001-C005: Intelligent input setting

Function code	Data	SFT terminal	Description
b031	00	ON/OFF	Write disable except for b031/write enable
	01	ON/OFF	Write disable except for b031,F001,A020,A220, A021~A035,A038 / write enable
	02	-	Write disable except for b031
	03	-	Write disable except for b031,F001,A020,A220, A021~A035,A038
	10	-	Write disable except for change mode during running (code list reference)

### Free-run stop (FRS)

By operating the free-run stop (FRS) function, the inverter output is cut off.

The motors will free wheel under its own momentum.

This function is used when the motor is to be stopped by the use of a brake, like an electromagnetic brake.

If you stop the motor with a machine brake while the inverter is still

Outputting to the motor an over-current trip may occur.

Assign 11(FRS) to an intelligent input terminal.

This free-run stop function will operate when the FRS terminal is ON.

If you turn FRS terminal OFF the inverter will restart after the retry wait time b003 passes.

However when the operation command selection A002 is set to control terminal (01), the inverter restarts during free-running.

This function will only operate when the FW terminal is ON.

On restart it is possible to select 0Hz start or matching frequency start as output methods with the free-run stop selection b088. (Example 1, 2)

When you set the frequency setting b007 to match and the frequency detected is under this setting when the free-run stop is released, the inverter is restarted from 0Hz.

The setting of this function is valid for selection b091 on stopping.

#### Relation code

b088	: Free-run stop selection
b003	: Retry wait time
b007	: frequency setting to match
b091	: Stop mode selection
C001-C005	: intelligent input terminal

Set item	Function code	Data	Description
Free-run stop Selection	b088	00	0Hz start (Example 1)
		01	Equaling frequency start (Example 2)
Retry wait time	b003	0.3-100.	Units : second Time until restart after FRS terminal is OFF. (This is also used for Instantaneous restart.)
Frequency setting to match	b007	0.00-400.0	Units : Hz (instantaneous stop, reference to item of insufficiency) This sets the level to match frequency. (Refer to item of instantaneous stop and restart.)

(Example 1) 0Hz start

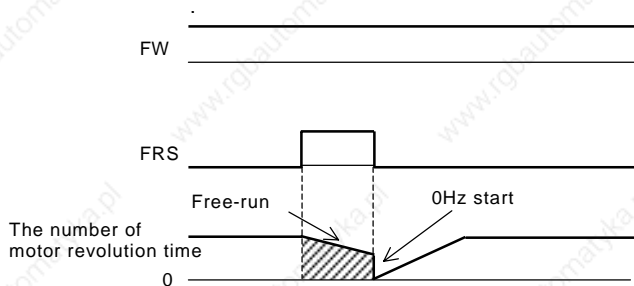

Start 0Hz regardless of the motor speed.  
On 0Hz start, the retry wait time is disregarded.  
When 0Hz start is used and the motor speed is still high there is the possibility of over-current trips.

(Example 2) Equaling start

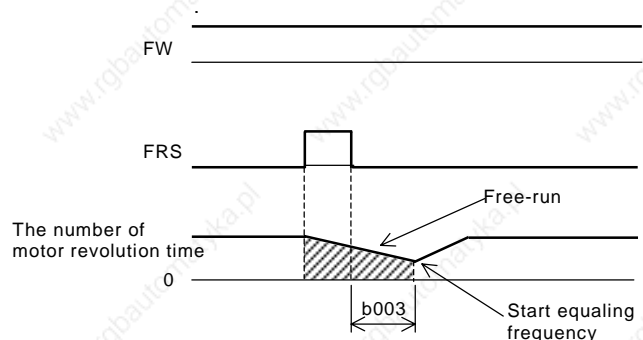

After FRS terminal is switched OFF, the Inverter reads the frequency of the motor and when it reaches the value in b007 the Inverter will begin to RUN again.

On frequency matching start if an over-current trip occurs, try extending the retry time.

## Chapter 4 Explanation of function

### Commercial power source switching(CS)

This function is used for systems with an excessive amount of starting torque requirements. The motor would be started direct-on-line and then when the motor had started the inverter would take over. This function is commonly used to reduce the costing of the inverter. For example, a system may

require 55kW to start but only 15kW to run at constant speed. Therefore, a 15kW rated inverter would be sufficient when using the commercial power source switching. Assign 14(CS) to an intelligent input terminal. Using the example below. When the motor has been started direct-on-line, Mg2 is switched OFF and Mg3 is switched on. With the Forward command to the inverter already on the CS terminal is switched on and Mg1 is closed. The Inverter will then read the motor RPM and when the CS terminal is switched OFF the retry wait time (b003) is started.

Once the wait time has elapsed the inverter will then start and match the frequency which is set (b007).

When the Earth Leakage Breaker (ELB) trips on ground fault, the commercial circuit will not operate. When a backup is required, take the supply from the commercial circuit ELBC.

For FWY, RVY, CSY, use control relays. The sequence above is reference to the circuit and timing diagram below.

If an over-current trip occurs when frequency matching, extend the retry wait time (b003).

When the power is supplied to the inverter, also it is possible to activate retry operation too. In this case, following CS terminal is out of necessary. For more information, refer to Reset(RS).

Relation code	
b003	: retry waiting time
b007	: frequency setting to match
C001-C005	: Intelligent input terminal

Connection figure example and timing on commercial power source switching

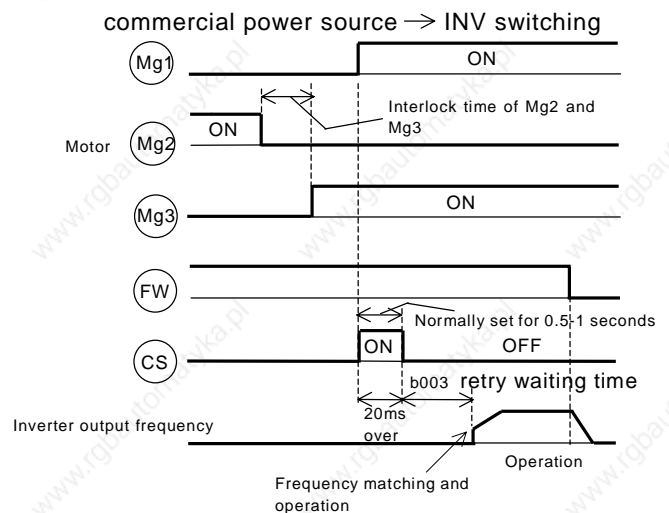
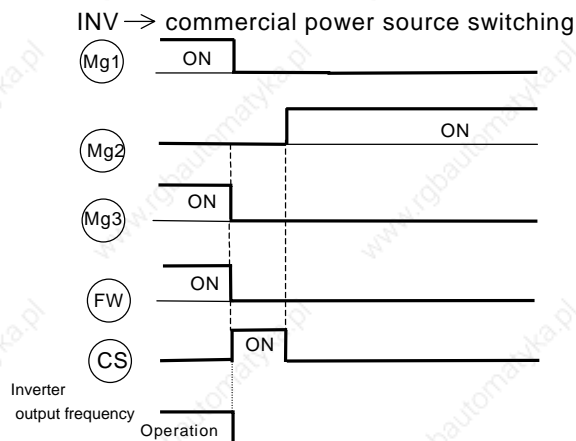
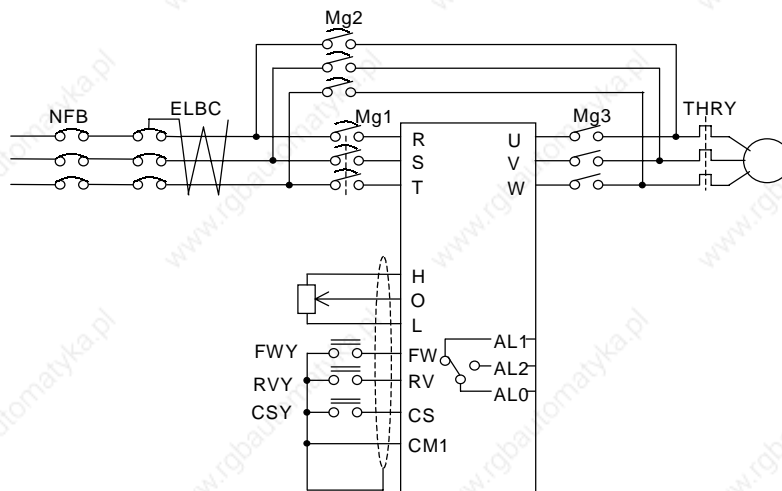

## Chapter 4 Explanation of function

### Reset (RS)

This function resets the inverter when a protective trip has occurred. The method of reset is to either push the STOP/RESET key on the digital operator or to switch the RS terminal ON.

To reset the inverter with the control terminal, assign 18(RS) to an intelligent input terminal.

Reset frequency matching selection C103 selects whether the inverter restarts at 0Hz or the inverter matches the output frequency after the reset operation is complete.

Reset selection C102 selects when the alarm signal is cancelled and whether it is valid or invalid in normal operation.

The RS terminal is valid only when the contact is set to NO.

#### Relation code

b003 : Retry waiting time  
 b007 : Frequency setting to match  
 C102 : Reset selection  
 C103 : Reset frequency matching selection

Set item	Function code	Data	Description
Retry waiting time	b003	0.3-100.	Units : seconds (Reference to items of instantaneous power failure or under-voltage) After reset, time until restart is tried.
Frequency setting to match	b007	0.00-400.0	Units : Hz (Reference to items of instantaneous stop/under-voltage)
Reset selection	C102	00	On ON signal, trip cancel (Example 1) On normal, this is valid (output cuts off).
		01	On OFF signal, trip cancel (Example 2) On normal, valid (output cuts off)
		02	On ON signal, trip cancel (Example 1) On normal, this is invalid. (only trip cancel)
Reset frequency matching selection	C103	00	0Hz start
		01	Frequency matching start. (Example 3)

(Example 1)

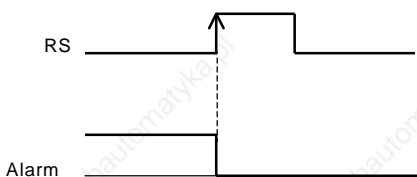

(Example 2)

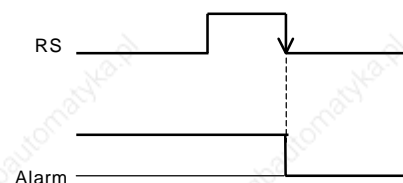

(Example 3) When 01 (frequency matching) is selected with reset frequency matching selection C103,

it is also possible to operate frequency start on power ON again. And retry waiting time is disregarded at the time of the setting C103:00 (0Hz start).

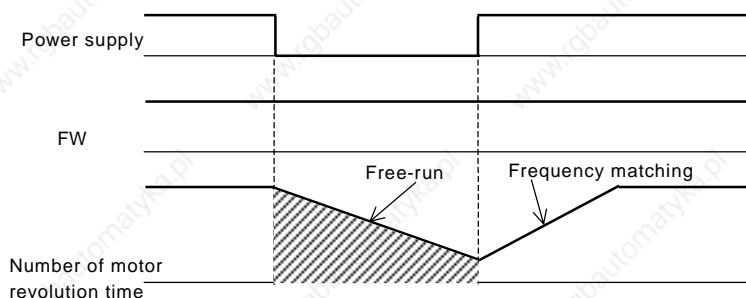



### Unattended start protection (USP)

Relation code

C001-C005: Intelligent input terminal

The USP function is designed as a fail safe to prevent accidental starting of the Inverter if the RUN signal is ON when the power is restored to the Inverter. When this function worked E13 is displayed. Either resetting the Inverter or turning the RUN signal OFF can clear the trip

This function is able to disarm when the operation command is turned off. (Example 1)

If the trip is cancelled while the RUN signal is still ON then the inverter will restart automatically. (Example 2)

When the operation command is turned on after the power supply input, the inverter drives normal. (Example 3)

Assign 13(USP) to an intelligent input terminal. Unattended start protection is shown as follows;

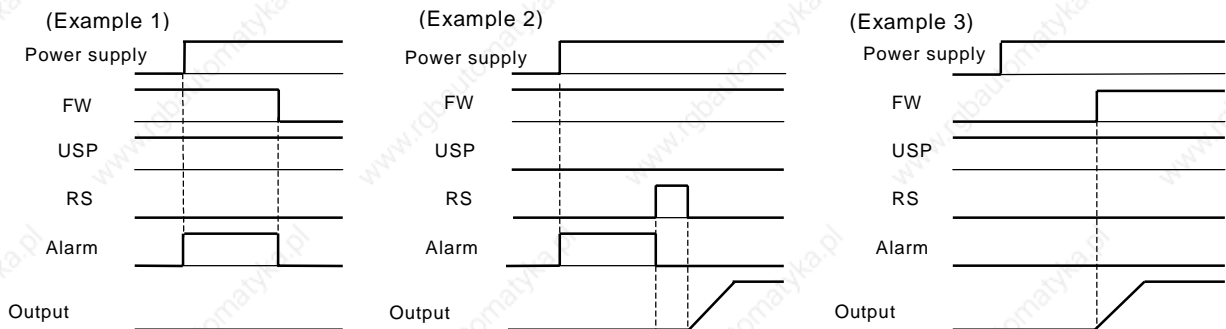

### UP/DOWN selection(UP/DWN)

Relation code

C101 :UP/DOWN memory selection  
C001-C005: Intelligent input terminal

The Inverter output frequency can be changed with the UP and DWN intelligent input terminals.

Assign 27(UP) and 28(DWN) to two of the intelligent input terminals 1-5.

This function is valid only when the frequency command selection A001 is set to 01 or 02. However, when 01 (control terminal) is set, this can only be used for multi-speed operation.

This function will not operate when the external analog frequency command or the jogging operation is used.

Acceleration time operates according to F002, F003/F202, F203 when UP/DWN terminal is ON.

To change 1<sup>st</sup> /2<sup>nd</sup> control, assign 08(SET) to an intelligent input terminal, change with SET terminal.

It is possible for the Inverter to retain the frequency setting value from the UP/DWN terminals. Parameter C101 switches the memory On or OFF. It is also possible to clear the memory and return to the original set frequency.

Assign 29(UDC) to an intelligent input terminal and switch it on to clear the memory.

Function code	Data	Description
C101	00	This will not memorize the frequency command adjusted with UP/DWN. When power is turned ON again, set value is returned to the value before it was adjusted with UP/DWN.
	01	This memorizes the frequency command adjusted with UP/DWN. When power is turned ON again, set value is kept the value after it was adjusted with UP/DWN.

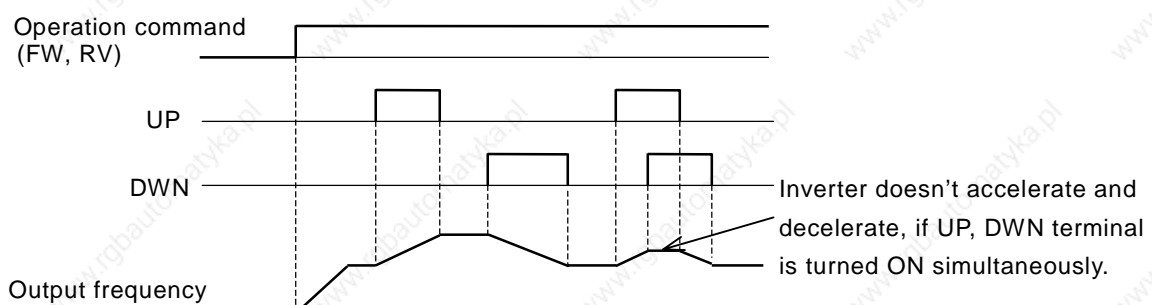

### External trip (EXT)

This function can be used to force the Inverter into a trip situation which is switched by an external input, i.e. PLC or relay contact.

Relation code  
C001-C005: Intelligent input terminal

When the EXT terminal is switched ON, the inverter trips on an E12 error and the outputs are switched OFF.

Assign 12(EXT) to an intelligent input terminal.

The trip will not be canceled when the terminal is turned OFF.

To cancel the trip, the reset signal must be applied or the Inverter switched OFF and ON again at the supply.

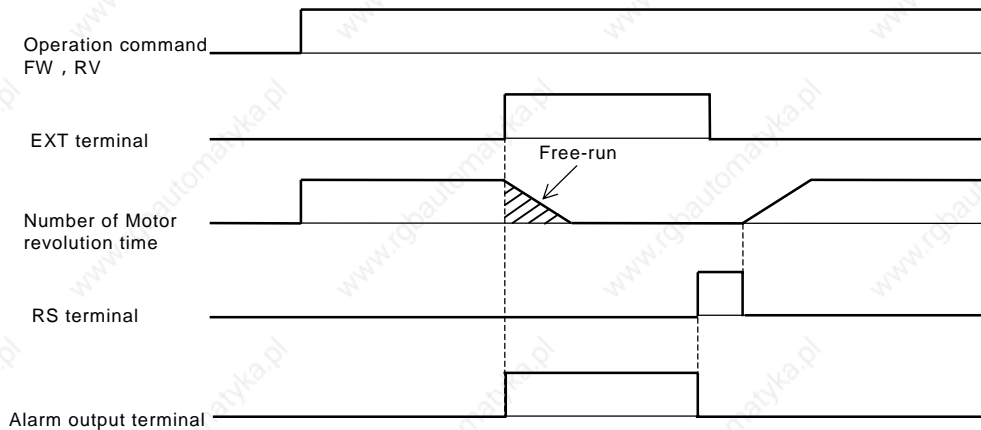

### 3 Wire input function (STA, STP, F/R)

This function is used when a momentary push start/stop control is required.

Relation code  
C001-C005: Intelligent input terminal

Set the operation command selection A002 to control terminal (01).

Assign 20 (STA), 21 (STP) and 22 (F/R) to three of the intelligent input terminals, and the operation becomes possible as follows. When the terminal is assigned STP terminal, FW terminal and also RV terminal become invalid. If all three inputs are not assigned this function will not operate.

The FW terminal and RV terminal become redundant when the 3 wire control is assigned to the intelligent input terminals. Output from the 3 wire control terminal is as follows;

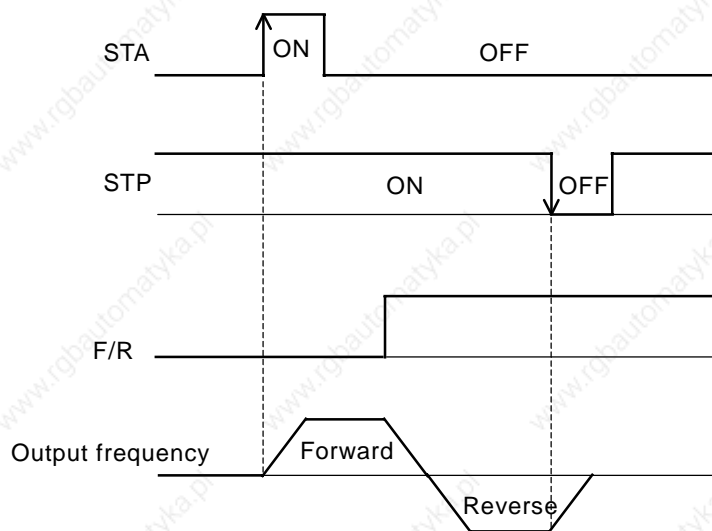

### Intelligent output terminal setting

Any of the following functions can be assigned to the intelligent Output terminals (11 or 12) or the alarm relay.

Both intelligent output terminals 11 and 12 and the alarm relay are all relay outputs.

All three output relays can be selected to be either NO or NC (a or b).

#### Relation code

C021-C022 : Intelligent output terminal

C026 : Alarm relay output terminal setting

Data	Description	Reference item	Page
00	RUN:Signal during run	Signal during run	4-53
01	FA1:Frequency arrival signal at the time of constant speed	Frequency arrival signal	4-53
02	FA2:Frequency arrival signal at the time of over setting frequency		
03	OL:Overload advance notice signal	Overload advance notice signal	4-38
04	OD:output deviation for PID control	PID function	4-30
05	AL:Alarm signal	Protection function	-
06	FA3:Arrival signal for only setting frequency	Frequency arrival signal	4-53
08	IP:Instantaneous stop signal	Instantaneous stop/under-voltage	4-34
09	UV:Under voltage signal		
11	RNT:RUN time over	RUN time over	4-55
12	ONT:ON time over	Power ON time over	4-55
13	THM:Thermal caution	Electric thermal function	4-38

## Chapter 4 Explanation of function

### Intelligent output terminal a/b (NO/NC)selection

This sets the intelligent output terminal 11,12 and alarm relay output terminal contact condition to either NO or NC, (a or b).

Each output is changeable individually.

Both intelligent output terminals 11 and 12 and the alarm relay are all relay outputs.

Set item	Function code	Data	Description	
Intelligent output 11,12 A/b(NO/NC) selection	C031-C032	00	A contact(NO)	Contact specification AC 250V 5Amax
		01	B contact(NC)	
Alarm relay output A/b(NO/NC)selection	C036	00	A contact(NO)	Contact specification AL1-AL0:AC 250V 5Amax
		01	B contact(NC)	AL2-AL0:AC 250V 2Amax

Relation code  
 C031-C032: Intelligent output 11,12a/b (NO/NC) selection  
 C036 : Alarm relay output a/b (NO/NC) selection

a contact: Close with {ON}, open with {OFF}.

b contact: Open with {ON}, close with {OFF}.

#### (1) Specification of the intelligent output terminals 11 and 12

Specification of the intelligent output terminals 11 and 12 is as follows;

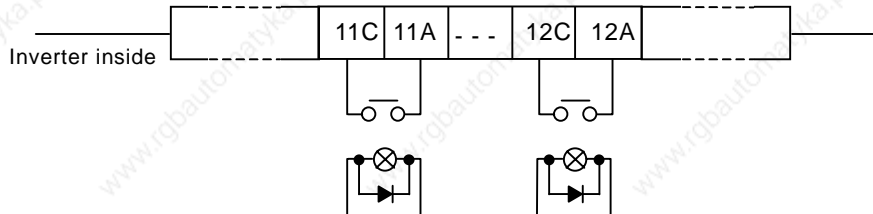

Contact Specification

C031, C032 Set value	Power supply	Output description	State of output terminal 11 or 12 terminal
00 (a contact)	On	ON	Close
		OFF	Open
	Off	-	Open
01 (b contact)	On	ON	Open
		OFF	Close
	Off	-	Open

	Resistor load	Inductor load
Maximum	AC250V, 5A DC30V, 5A	AC250V, 1A DC30V, 1A
Minimum	DC1V 1mA	

#### (2) Specification of the alarm relay output terminal

The specifications of the alarm relay output terminal is a changeover contact. Action is as follows.

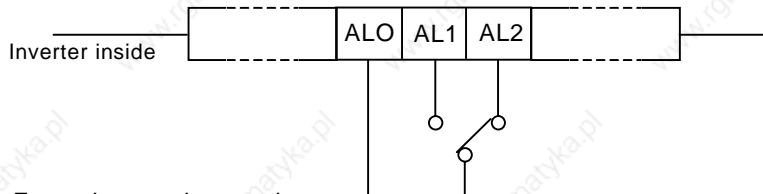

Example on using as alarm

C036 Set value	Power source	State of inverter	State of output terminal	
			AL1-AL0	AL2-AL0
00 (a contact)	On	On abnormal	Close	Open
		On normal	Open	Close
	Off	-	Open	Close
01 (b contact)	On	On abnormal	Open	Close
		On normal	Close	Open
	Off	-	Open	Close

Contact Specification		Resistor load	Inductor load
AL1-AL0	Maximum	AC250V, 2A DC30V, 8A	AC250V, 0.2A DC30V, 0.6A
	Minimum	AC100V, 10mA DC5V, 100mA	
AL2-AL0	Maximum	AC250V, 1A DC30V, 1A	AC250V, 0.2A DC30V, 0.2A
	Minimum	AC100V, 10mA DC5V, 100mA	

### Signal during run (RUN)

This function is to provide an output signal when the Inverter is in a running condition.

Assign 00(RUN: signal during run) to an intelligent output terminal 11,12 or the alarm relay output terminal.

The signal is still outputted when the dc braking operates.

The signal is not outputted when the output frequency is 0Hz , and when the status of the inverter is retry.

Operation is as follows;

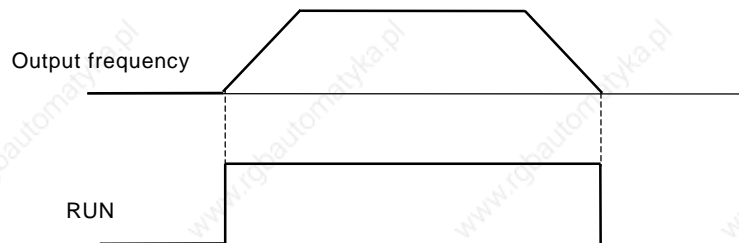

#### Relation code

C001-C005: Intelligent input terminal  
 C021,C022: Intelligent output terminal  
 C026: Alarm relay output

### Frequency arrival signal (FA1, FA2, FA3)

When the output frequency arrives at the set frequency, an arrival signal is outputted.

Assign 01(FA1:constant speed arrival signal), 02(FA2:over setting frequency) or 06(FA3: only setting frequency) to an intelligent output terminal 11, 12 or the alarm relay output terminal.

Hysteresis frequency arrival signal is the following.

When ON : ON with (1% of setting frequency – maximum frequency)(Hz)

When OFF: OFF with (2% of setting frequency – maximum frequency)(Hz)

However in to set 06(FA3) case when inverter accelerate.

When ON : (1% of setting frequency – maximum frequency)(Hz)

When OFF: (2% of setting frequency + maximum frequency)(Hz)

When inverter decelerates

When ON : (1% of setting frequency + maximum frequency)(Hz)

When OFF: (2% of setting frequency – maximum frequency)(Hz)

#### Relation code

C021,C022: Intelligent output terminal  
 C026 : Alarm relay output  
 C042 :Acceleration arrival frequency  
 C043 :Deceleration arrival frequency

Set item	Function code	Data (Hz)	Description
Acceleration arrival frequency	C042	0.0	Arrival signal at acceleration is OFF.
		0.01-400.0	Arrival signal at acceleration is ON.
Deceleration arrival frequency	C043	0.0	Arrival signal at deceleration is OFF.
		0.01-400.0	Arrival signal at deceleration is ON.

## Chapter 4 Explanation of function

### (1) Output on constant speed arrival (01:FA1)

When the inverter arrives at the set frequency with frequency setting (F001, A020,A220) or multi-speed (A021-A035), the output relay is switched.

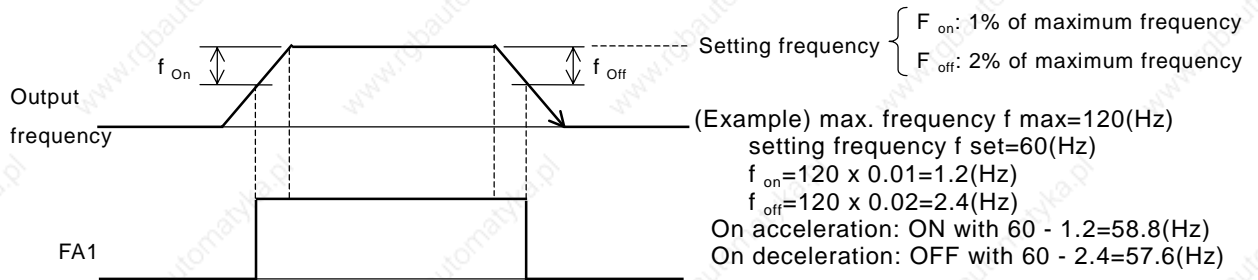

### (2) Output over setting frequency (02:FA2)

When the output is over the arrival frequency set in C042, C043 on adjustable speed time, the output relay is switched.

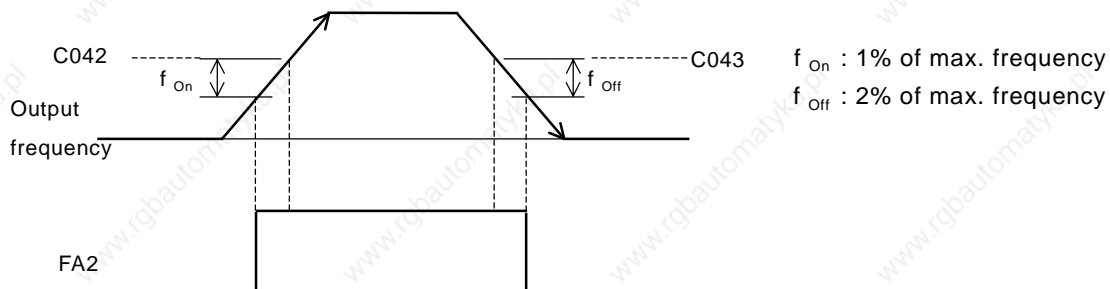

### (3) Output setting frequency (06:FA3)

The signal is switched only when the output frequency matches the arrival frequency set in C042, C043 on adjustable speed time.

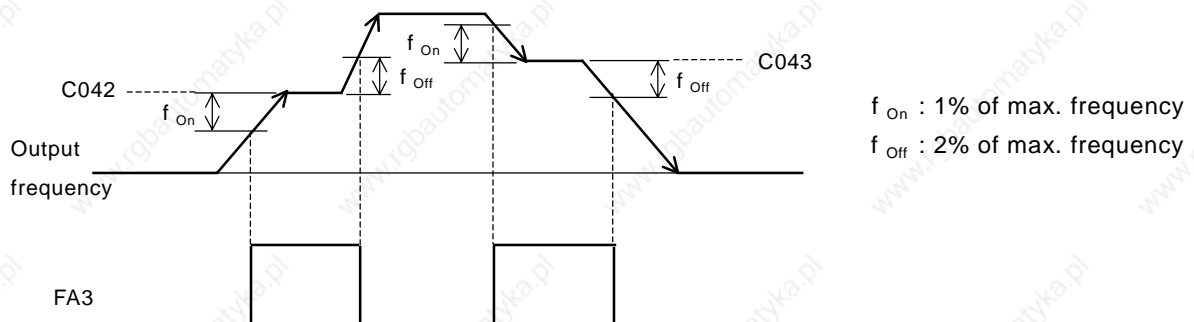

## Chapter 4 Explanation of function

### RUN time / power ON time over (RNT/ONT)

When the accumulated operation time reaches or is over the Setting time in b034, RUN time/power ON time over (RNT/ONT) output is switched.

#### Relation code

b034 : Warning time level  
 C021,C022: Intelligent output terminal  
 C026 : Alarm relay output terminal  
 d016 : Accumulation time monitor during RUN  
 d017 : Power ON time monitor

Function code	Data	Description
b034	0.	Don't operate.
	1. -9999.	Set by 10-hour unit.
	1000-6553	Set by 100 hours unit. (10000-65530 hours)

#### (1) Run time over (RNT)

Assign 11(RNT) to an intelligent output terminal 11, 12 (C021, C022) or the alarm relay output terminal (C026).

Set ON time level with b034.

#### (2) Power ON time over (ONT)

Assign 12(ONT) to an intelligent output terminal 11, 12 (C021, C022) or the alarm output terminal, (C026).

Set ON time level with b034.

### Force operation ope function

This function is used to operate from the operator forcibly by on/off of an intelligent terminal when frequency and operation command is selected other than the operator.

Becoming the operation from the frequency and operation command that was selected by A001 and A002 if the signal is off, and becoming the frequency and operation command from an operator forcibly if the signal is on when the compulsion operation function is selected by an intelligent input selection.

When changed the operation command while driving, operation command is canceled and become stoppage at first.

Operation command from each command input the operation command once again as the stoppage at first for driving once again.

#### Relation code

A001: Frequency setting selection  
 A002: Operation command selection  
 C001-C005: Intelligent input terminal

Setting item	Function cord	Setting value	Contents
Frequency command selection	A001	00	Potentiometer the digital operator has
		01	Terminal
		02	Operator
		03	RS485
		04	Option 1
		05	Option 2
Operation command selection	A002	01	Terminal
		02	Operator
		03	RS485
		04	Option 1
		05	Option 2
Intelligent input selection	C001-C005	31	OPE : Compulsion operation

## Chapter 4 Explanation of function

### FM terminal

The FM control terminal can monitor the output frequency and output current.  
FM terminal is a PWM (Pulse Width Modulation) output.

Relation code

C027: FM selection

b081: FM adjustment

#### (1) FM selection

Select a signal to output from the following options.

When 03(digital frequency) is set a digital frequency counter meter is required.

Use an analog meter for all other output signals.

Function code	Data	Description	Full scale value
C027	00	Output frequency (Example 1)	0-Max. frequency(Hz)
	01	Output current (Example 1)	0-200%
	03	Digital output frequency (Example 2)	0-Max. frequency(Hz)
	04	Output voltage (Example 1)	0-100%
	05	Input electric power (Example 1)	0-200%
	06	Thermal load ratio (Example 1)	0-100%
	07	LAD frequency (Example 1)	0-Max. frequency(Hz)

(Example 1) Set value:00, 01, 04, 05, 06, 07

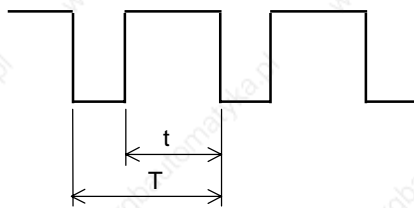

Period T: constant (6.4ms)  
Duty  $t/T$  : change

(Example 2) Set value: 03

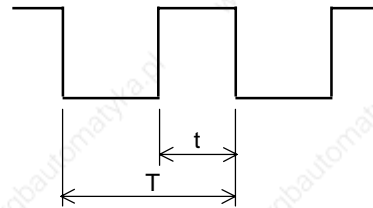

Period T: change  
Duty  $t/T$  : 50%fixed

#### (2) FM adjustment

This function is used to calibrate a meter connected to the FM terminal.

Function code	Set range	Description
b081	0. -255.	Change one by one.

(Calibration methods)

(1) Connect meter to FM-CM1.

(2) Adjust b081 so that the meter is reading the same as the output frequency on your scale.

(Example) When output frequency is 60Hz, change value of b081 so that meter is 60Hz.



## Chapter 4 Explanation of function

### AM terminal, AMI terminal

The AM terminal and the AMI terminal can monitor the output frequency or the output current.

The AM terminal has an analog output of 0-10V.

The AMI terminal has an analog output of 4-20mA.

#### (1) AM, AMI selection

Select a signal to output from the following options;

Set item	Function code	Data	Contents	Full scale value
AM selection/ AMI selection	C028/C029	00	Output frequency	0-Max. frequency(Hz)
		01	Output current	0-200%
		04	Output voltage	0-100%
		05	Input electric power	0-200%
		06	Thermal load ratio	0-100%
		07	LAD frequency	0-Max. frequency(Hz)

#### Relation code

b080 : AM adjustment  
C028 : AM selection  
C029 : AMI selection  
C086 : AM offset adjustment  
C087 : AMI adjustment  
C088 : AMI offset adjustment

#### (2) AM adjustment, AMI adjustment

This function is used to calibrate a meter connected to the AM and AMI terminal.

Set item	Function code	Data	Description
AM adjustment	b080	0. -255.	After offset adjustment with C086, adjust according to memory.
AM offset Adjustment	C086	0.0-10.0	Units : V
AMI adjustment	C087	0. -255.	After offset adjustment with C088, adjust according to memory.
AMI offset adjustment	C088	0.0-20.0	Units : mA

### External thermistor(TH)

Temperature protection of the external machine is possible by the use of a Thermistor fitted to your motor.

Wire the thermistor between control terminals TH and CM1.

Set the following function according to the thermistor specification.

#### Relation code

b098: Thermistor selection  
b099: Thermistor error level  
C085: Thermistor adjustment

Set item	Function code	Set value	Contents
Thermistor selection	b098	00	Invalid (No temperature protection by external thermistor)
		01	Valid normal temperature/factor resistance element (For PTC)
		02	Valid (For NTC)
Thermistor error level	b099	0. -9999.	Units : OHM Set the resistance value of temperature for trip according to thermistor methods.
Thermistor adjustment	C085	0.0-1000.	Use this as gain adjustment.

### Initialization setting

It is possible at any time to reinitialize the Inverter parameters back to their factory default. The trip history can also be cleared at any time, however, if problems occur it will be difficult to fault find without the trip history for reference.

Initialization details are as follows;

Relation code

b084: Initialization selection  
b085: Initial data selection

Set item	Function mode	Data	Description
Initialization selection	b084	00	This clears only trip history.
		01	This only initializes setting value. Setting value becomes the state on factory forwarding.
		02	This clears trip history and initializes setting.
Initial data selection	b085	00	Initializing setting for Japan.
		01	Initializing setting for Europe
		02	Initializing setting for America.

(Initialization methods)

After setting the above parameters, initialize as follows;

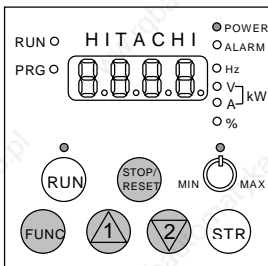

(1) Hold down the FUNC, UP and DOWN key and then press the STR key. When the display starts to flash and rotate release all the keys.

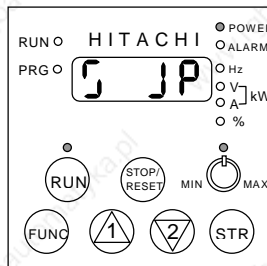

(2) During initializing  
Above display is for Japan.  
Other displays are below.

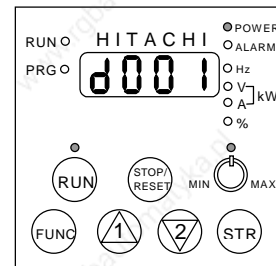

(3) When "d001" is displayed in the monitor, initialization is complete.

During initializing for Europe.



During initializing for America.



During initializing of trip history.

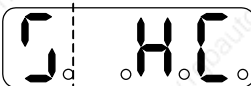

The display revolves on the left.

## Chapter 4 Explanation of function

### Display selection

This function can be used to limit what the digital operator can display.

Relation code

b037 : Display selection  
U001-U012 : User selection

Set item	Function code	Data	Description
Display selection	b037	00	All display
		01	Function individual display (Display, no display by item set)(Example 1)
		02	User setting and b037 Only item set by user selection of U001-U012 is displayed. (Set U001-U012 first.)
User selection	U001-U012	no	No assignment.
		d001-P031	Select the code to display. (All code is an object.)

(Example 1) When the Display selection (b037) is set to 02, only the programmed parameters are displayed.  
To set which parameters are displayed insert code groups in parameter U001-U012.

The table below shows which parameter groups can be displayed and what code is used in U001-U012.

No	Function to restrict display	Data	Code to be restricted display	Note
1	A001	01	A005,A006,A011-A016,A101-A105, A111-A114,C081-C083,C121-C123	O,O1,O2 terminal function
2	A002	01 , 03 , 04 , 05	b087	Stop key function
3	A019	00	A028-A035 (Note)	Multi-speed function
	C001-C005	02,03,04,05		
4	A044,A244	02	b100-b113	Control methods
5	A051	01	A052-A059	DC control
6	A071	01	A072-A076,C044	PID function
7	A094	01	A095-A096	2 stage adjustable frequency
8	b013,b213	02	b015-b020	Electric thermal characteristic
9	b021	01,02	b022,b023	Overload restriction
10	b024	01,02	b025,b026	Overload restriction2
11	b095	01,02	b090,b096	BRD function
12	C001-C005	08	A203,A204,A220,A241-A244,A261,A262 A292,A293,A294-A296, b212,b213,H203 H204,H206	2 <sup>nd</sup> control
13		11	b088	Free-run stop
14	C021,C022,C026	02,06	C042 ~ C043	Frequency arrival signal
15	A094	01	A095,A096	2 <sup>nd</sup> two adjustable frequency
16	A294	01	A295,A296	
17	b098	01,02	b099,C085	Thermistor function
18	C001-C005	06	A038,A039	jogging function
19	A097	01,02,03	A131	Acceleration curve constant
20	A098	01,02,03	A132	Deceleration curve constant
21	C001-C005	27,28,29	C101	UP/DWN selection
22		18	C102	Reset selection

(Note) If attach all the spite individually data, of A019, C001-C005 and do not do the setting A028-A035 is not displayed.

## Chapter 4 Explanation of function

### Stabilized factor

When the motor is hunting or unstable, this function can be adjusted to help stabilize the motor.

Relation code  
H006/H206: 1<sup>st</sup> /2<sup>nd</sup> stabilized factor

When the motor is unstable, check the allowable motor selection (H003/H203) and motor pole selection (H004/H204) with your motor. If their code data is different from your motor specification, set the right data.

When R1 of usage motor is less than R1 of regular motor, raise the set value of H006/H206 gradually.

When you operate greater motor than rated capacity of inverter, lower the set value of H006/H206.

The following two functions can also assist to reduce hunting or rattling of a motor.

- (1) Lower the carrier frequency (b083).
- (2) Lower the output voltage gain (A045).

Set item	Function code	Data	Description
Output gain	A045	20. -100.	Units :% Lower this when hunting occurs.
Carrier frequency	b083	0.5-12.0 (11 to 75kW)	Units :kHz Lower this when hunting occurs.
		0.5-8.0 (90 to 132kW)	
Stabilized factor	H006/H206	0. -255.	Raise or lower when hunting occurs.

### Operation selection on option error

When an add-in option is the cause of a protective trip this function can be used to switch the trip facility off and allow the Inverter to carry on in it's operation.

Relation code  
P001: Option1 operation selection on error  
P002: Option 2 operation selection on error

Set item	Function code	Data	Description
Operation selection on optional error	P001/P002	00	TRP: inverter trip and output alarm when option error occurs.
		01	RUN: inverter ignores this and continues operation when option error occurs.

### Motor constant

Set each constant according to the motor you use.

In case of using several motors in parallel, set the constant values that are closest to the total capacity of the belonging motor.

Reduced torque or instability may occur while using auto torque boost function if these settings are incorrect.

Relation code  
H003/H203: 1<sup>st</sup> /2<sup>nd</sup> allowable motor selection  
H004/H204: 1<sup>st</sup> /2<sup>nd</sup> motor pole selection

## Chapter 4 Explanation of function

### Communication function

Serial communication is possible from the Inverter to any external equipment using RS485 protocol. This function is built-in as standard and is controlled by the TM2 control terminals.

#### Relation code

A001: Frequency selection  
 A002: Operation command selection  
 C070: Data command  
 C071: Communication transmission speed  
 C072: Communication code  
 C073: Communication bit  
 C074: Communication parity  
 C075: Communication stop bit  
 C078: Communication waiting time

#### (1) Communication specification

Item	Specification	Notes
Transmission speed	2400/4800/9600/19200 bps	Selection with operator
Communication methods	Half duplex communication methods	
Synchronizing methods	Direct current transmission	
Transmission code	ASCII code	
Transmission methods	Transmission from lower bit	
Communication interface	RS485	
Data bit	7/8 bit	Selection with Operator
Parity	No parity/even/odd	Selection with Operator
Stop bit	1/2 bit	Selection with Operator
Start methods	One-way start form by command of host side	
Waiting time	0-1000[ms]	Setting with operator
Connect form	1:N (N = Maximum 32)	Station number is selected with operator.
Error check	Overrun / Fleming / BCC / Vertical / Horizontal parity	

<RS485 port specification and connection>

Use TM2 of controls terminal PCB for RS485 communication function.

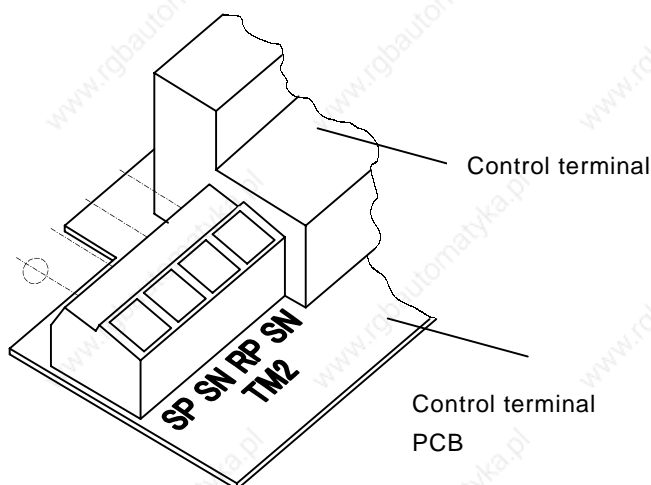

Abbreviation name	Description
S P	Transmission and reception + side
S N	Transmission and reception - side
R P	Terminal resistance valid terminal
S N	Terminal resistance valid terminal

## Chapter 4 Explanation of function

Connect each inverter in parallel as shown below. It is necessary to short terminals RP and SN on the last inverter in the link (even if communication is to only one inverter the link should still be made).

By shorting between RP and SN, the terminal resistance is increased and controls the reflection of the signal.

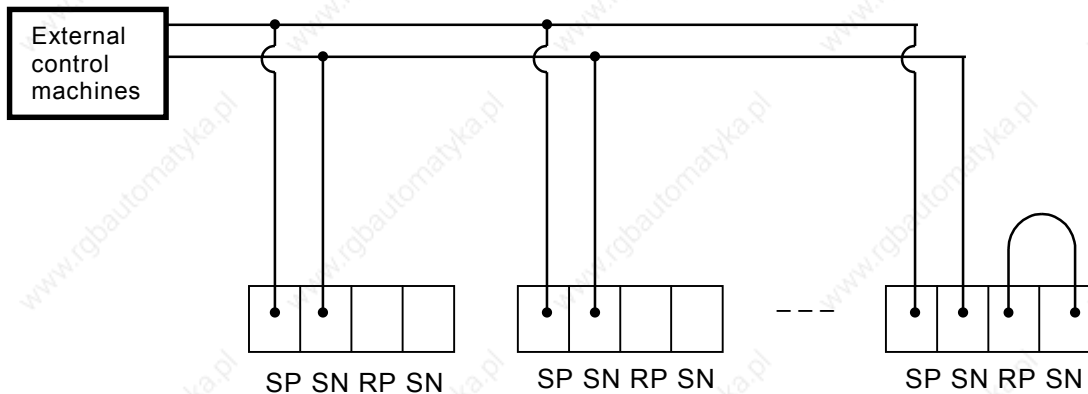

### (2) Setting

The following settings are required to operate RS485 communication.

Set item	Function code	Set value	Description
Data command	C070	02	Operator
		03	RS485
		04	Option 1
		05	Option 2
Communicating transmission speed	C071	02	Loop-back test
		03	2400 bps
		04	4800 bps
		05	9600 bps
		06	19200 bps
Communication code	C072	1 to 32	This assigns the station number of the inverter. This is used when you control more than one simultaneously.
Communication bit	C073	7	7 bit
		8	8 bit
Communication parity	C074	00	No parity
		01	Even parity
		02	Odd parity
Communication bit	C075	1	1 bit
		2	2 bit
Communication waiting time	C078	0 to 1000	Units :ms (3) Communication procedure reference

### (3) Communication protocol

The method of the communication protocol is shown below in the time diagram.

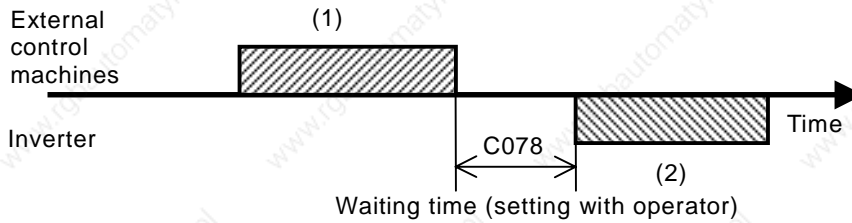

The following is indicated.

(1): Frame transmitted from external control machines to the inverter

(2): Frame replied from inverter to the external control machines

Frame (2) from the inverter is a reply to frame (1) from the external control machine, the active output is not operated.

The commands are shown below;

#### Command list

Command	Command description	Advisability of all code	Notes
00	Forward / backward / stop command	✓	This doesn't operate unless b084 is set to (01 or 02). (Clear of the trip origin)
01	Setting of frequency command	✓	
02	Setting of intelligent terminal state	✓	
03	Collective reading of monitor data	-	
04	Reading of inverter state	-	
05	Reading of trip history	-	
06	Reading of 1 setting item	-	
07	Setting of 1 set item	✓	
08	Returning of each set value to initial value	✓	
09	This checks whether set value can be Conserved to EEPROM or not.	-	
0A	This conserves set value to EEPROM	✓	
0B	Recalculation of internal constant.	✓	

## Chapter 4 Explanation of function

Explanation of each command is the following.

(i) 00 command : This controls the forward, backward and stop command. (Set up A002 in 03 in the case that this command is used.)

- Transmission frame

Frame format

STX	Code	Command	Data	BCC	CR
-----	------	---------	------	-----	----

	Explanation	Data size	Value
STX	Control code (Start of TeXt)	1 byte	STX (0x02)
Code	Station number of inverter	2 byte	01-32, and FF(broadcast)
Command	Transmission command	2 byte	00
Data	Transmission data	1 byte	(Note 1) Reference
BCC	Bloc check code	2 byte	Exclusive OR of Code, Command and Data
CR	Control code (Carriage Return)	1 byte	CR (0x0D)

(Note 1)

Data	Description	Note
0	Stop command	
1	Forward command	
2	Reverse command	

(Example) When you transmit forward command to code 01

(STX)|01|00|1|(BCC)|(CR)  $\xrightarrow{\text{ASCII converter}}$  02|30 31|30 30|31|33 30|0D

Reply frame

On normal reply : (4) - (i) reference

On abnormal reply : (4) - (ii) reference

(ii) 01 command: This is to set frequency command. (Set up A001 in 03 in the case that this command is used.)

- Transmission frame

Frame format

STX	Code	Command	Data	BCC	CR
-----	------	---------	------	-----	----

	Explanation	Data size	Value
STX	Control code (Start of TeXt)	1 byte	STX (0x02)
Code	Station number of inverter	2 byte	01-32, and FF (broadcast)
Command	Transmission command	2 byte	01
Data	Transmission data (tenth ASCII code)	6 byte	(Note 2) Reference
BCC	Block check code	2 byte	Exclusive OR of Code, Command and Data
CR	Control code (Carriage Return)	1 byte	CR (0x0D)

(Note 2) When you set code 01 for 5Hz

(STX)|01|01|000500|(BCC)|(CR)

$\xrightarrow{\text{ASCII conversion}}$  02|30 31|30 31|30 30 30 35 30 30|30 35|0D

(Note) The data is 100 times as big as set value.

(Example) 5(Hz)  $\rightarrow$  500  $\rightarrow$  000500  $\xrightarrow{\text{ASCII}}$  30 30 30 35 30 30

Reply frame

On normal reply : (4) - (i) Reference

On abnormal reply : (4) - (ii) reference



## Chapter 4 Explanation of function

(iii) 02 command: This sets the state of the intelligent terminals.

- Transmission frame

Frame format

STX	Code	Command	Data	BCC	CR
		Explanation	Data size	Value	
STX		Control code (Start of TeXt)	1 byte	STX (0x02)	
Code		Station number of inverter	2 byte	01-32, and FF (broadcast)	
Command		Transmission command	2 byte	02	
Data		Transmission data	16 byte	(Note 3) reference	
BCC		Block check code	2 byte	Exclusive OR of Code, Command and Data (5) Reference	
CR		Control code (Carriage Return)	1 byte	CR (0x0D)	

(Note 3) Data (sixteenth) of intelligent terminal and contents

(The details refer to intelligent input terminal function.)

Data (sixteenth)	Description	Data (sixteenth)	Description
0000000000000001	FW: forward command	000000000100000	STA: 3 wire start
0000000000000002	RV: reverse command	000000000200000	STP: 3 wire stop
0000000000000004	CF1: multi-speed1(binary operation)	000000000400000	F/R: 3 wire direction
0000000000000008	CF2: multi-speed2(binary operation)	000000000800000	PID:PID selection (valid/invalid)
0000000000000010	CF3: multi-speed3(binary operation)	000000001000000	PIDC: PID integral reset
0000000000000020	CF4: multi-speed4(binary operation)	000000002000000	-
0000000000000040	JG: jogging(inching operation)	000000004000000	-
0000000000000080	DB: external DC control	000000008000000	UP: remote operation Accelerating speed
0000000000000100	SET: 2 <sup>nd</sup> control	000000001000000	DWN: remote operation Decelerate speed
0000000000000200	2CH: two stage adjustable speed	000000002000000	UDC: remote operation data clear
0000000000000400	-	000000004000000	-
0000000000000800	FRS: free-run stop	000000008000000	OPE:Force operation ope
0000000000001000	EXP: external trip	000000010000000	SF1: multi-speed(bit run)
0000000000002000	USP: unattended start protection	000000020000000	SF2: multi-speed(bit run)
0000000000004000	CS: commercial change	000000040000000	SF3: multi-speed(bit run)
0000000000008000	SFT: software lock (control terminal)	000000080000000	SF4: multi-speed(bit run)
0000000000010000	AT: analog input voltage/current select	000000100000000	SF5: multi-speed(bit run)
0000000000020000	-	000000200000000	SF6: multi-speed(bit run)
0000000000040000	RS: reset	000000400000000	SF7: multi-speed(bit run)
0000000000080000	-	000000800000000	OLR: overload restriction setting

(Example) When you make (forward), (multi-speed1) and (multi-speed2) active on inverter setting of code 01, the calculation of data is

$$0x0000000000000001+0x0000000000000004+0x0000000000000008 = 0x000000000000000D$$

so transmission frame is

(STX)|01|02|000000000000000D|(BCC)|(CR)

Reply frame

On normal reply: Refer to (4) - (i)

On abnormal reply: Refer to (4) - (ii)

## Chapter 4 Explanation of function

(iv) 03 command: This reads monitor data collectively.

- Transmission frame

Frame format

STX	Code	Command	BCC	CR
-----	------	---------	-----	----

Replay frame

	Explanation	Data size	Value
STX	Control code(Start of TeXt)	1 byte	STX (0x02)
Code	Station number of inverter	2 byte	01-32
Command	Transmission command	2 byte	03
BCC	Block check code	2 byte	Exclusive OR of Code, Command and Data(5) Reference
CR	Control code (Carriage Return)	1 byte	CR (0x0D)

Frame format

STX	Code	Data	BCC	CR
-----	------	------	-----	----

	Explanation	Data size	Value
STX	Control code (Start of TeXt)	1 byte	STX (0x02)
Code	Station number of inverter	2 byte	01-32
Data	Data	104 byte	(Note 4) reference
BCC	Block check code	2 byte	Exclusive OR of Code, Command and Data (5) Reference
CR	Control code (Carriage Return)	1 byte	CR (0x0D)

(Note 4) Each monitor value

Monitor item	Units	Compe- titive rate	Data size	Explanation	Upper bite-----lower bite
Output frequency	Hz	x100	8 byte	Tenth ASCII code	
Output current	A	x10	8 byte	Tenth ASCII code	
Revolution direction	-	-	8 byte	0: stop, 1: forward, 2:backward	
PID feedback monitor	%	x100	8 byte	Tenth ASCII code	
Intelligent input monitor	-	-	8 byte	(Note 5) reference	
Intelligent output monitor	-	-	8 byte	(Note 6) reference	
Frequency converting monitor	-	x100	8 byte	Tenth ASCII code	
-	-	-	8 byte	(00000000)padding data	
Output voltage monitor	V	x10	8 byte	Tenth ASCII code	
Electric power monitor	kW	x10	8 byte	Tenth ASCII code	
-	-	-	8 byte	(00000000) padding data	
RUN time monitor	h	x1	8 byte	Tenth ASCII code	
ON time monitor	h	x1	8 byte	Tenth ASCII code	

(Note 5) Intelligent input terminal monitor

Item	Data
FW (Forward terminal)	00000001
1 (1 <sup>st</sup> terminal)	00000002
2 (2 <sup>nd</sup> terminal)	00000004
3 (3 <sup>rd</sup> terminal)	00000008
4 (4 <sup>th</sup> terminal)	00000010
5 (5 <sup>th</sup> terminal)	00000020

(Note 6) Intelligent output terminal monitor

Item	Data
AL (Alarm terminal)	00000001
11 (11 <sup>th</sup> terminal)	00000002
12 (12 <sup>th</sup> terminal)	00000004

## Chapter 4 Explanation of function

(v) 04 command: This reads the state of the inverter.

- Transmission frame

Frame format

STX	Code	Command	BCC	CR
-----	------	---------	-----	----

	Explanation	Data size	Value
STX	Control code(Start of TeXt)	1 byte	STX (0x02)
Code	Station number of inverter	2 byte	01-32
Command	Transmission command	2 byte	04
BCC	Block check code	2 byte	Exclusive OR of Code, Command and Data (5) Reference
CR	Control code(Carriage Return)	1 byte	CR (0x0D)

Replay frame

Frame format

STX	Code	Data	BCC	CR
-----	------	------	-----	----

	Explanation	Data size	Value
STX	Control code(Start of TeXt)	1 byte	STX (0x02)
Code	Station number of inverter	2 byte	01-32
Data	Data on trip	8 byte	(Note 7) reference
BCC	Block check code	2 byte	Exclusive OR of Code, Command and Data (5) Reference
CR	Control code(Carriage Return)	1 byte	CR (0x0D)

(Note 7)The data to indicate status contents of inverter is constructed from the following three factors [A), B), C)].

Data	Status A	Status B	Status C	00 (reservation)
------	----------	----------	----------	------------------

Inverter status A)

Code	Status
00	Initial status
01	Vdc on waiting settlement
02	On stopping
03	On running
04	On FRS
05	On JG
06	On DB
07	On reading frequency
08	On retrying
09	On UV
10	On TRIP
11	On waiting reset

Inverter status C)

Code	Status
00	---
01	Stop
02	Deceleration speed
03	Constant speed
04	Acceleration speed
05	Forward
06	Reverse
07	Reverse from forward
08	Forward from reverse
09	Forward start
10	Reverse start

Inverter status B)

Code	Status
00	On stopping
01	On running
02	On tripping

## Chapter 4 Explanation of function

(vi) 05 command: This reads trip history data.

- Transmission frame

Frame format

STX	Code	Command	BCC	CR
-----	------	---------	-----	----

	Explanation	Data size	Value
STX	Control code(Start of TeXt)	1 byte	STX (0x02)
Cord	Station number of inverter	2 byte	01-32
Command	Transmission command	2 byte	05
BCC	Block check code	2 byte	Exclusive OR of Code, Command and Data (5) Reference
CR	Control code(Carriage Return)	1 byte	CR (0x0D)

Replay frame

Frame format:

STX	Code	Data	BCC	CR
-----	------	------	-----	----

	Explanation	Data size	Value
STX	Control code(Start of TeXt)	1 byte	STX (0x02)
Code	Station number of inverter	2 byte	01-32
Data	Each monitor data on trip	440 byte	(Note 8) reference
BCC	Block check code	2 byte	Exclusive OR of Code, Command and Data (5) Reference
CR	Control code(Carriage Return)	1 byte	CR (0x0D)

Note 8) The monitor data (trip history) on trip memorizes the last six errors with an accumulated count number (8byte).

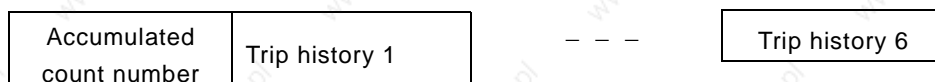

Monitor item	Units	Magnification	Data size	Notes	
Trip factor	-	-	8byte	Cord display 04 command Note 7 reference	Upper
Inverter status A)	-	-	8byte		
Inverter status B)	-	-	8byte		
Inverter status C)	-	-	8byte		
Output frequency	Hz	x10	8byte	Tenth ASCII code	Lower
Output current	A	x10	8byte	Tenth ASCII code	
Current voltage	V	x10	8byte	Tenth ASCII code	
Accumulated RUN time	hour	x 1	8byte	Tenth ASCII code	
Power source ON time	hour	x1	8byte	Tenth ASCII code	

## Chapter 4 Explanation of function

(vii) 06 command: This reads 1 set item.

- Transmission frame

Frame format

STX	Code	Command	Parameter	BCC	CR
		Explanation		Data size	Value
STX		Control code(Start of TeXt)		1 byte	STX (0x02)
Code		Station number of inverter		2 byte	01-32
Command		Transmission command		2 byte	06
Parameter		Parameter number of data		4 byte	(Note 9)
BCC		Block check code		2 byte	Exclusive OR of Code, Command and Data (5) Reference
CR		Control code(Carriage Return)		1 byte	CR (0x0D)

(Note 9) The range of parameter to get,

F002-, A001-, b001-, C001-, H003-, P001- (F001 uses 01 command.)

Replay frame

Frame format

On normal reply : (4) - (i) Reference

STX	Code	ACK	Data	BCC	CR
		Explanation		Data size	Value
STX		Control code(Start of TeXt)		1 byte	STX (0x02)
Code		Station number of inverter		2 byte	01-32
ACK		Control code(ACKnowledge)		1 byte	ACK (0x06)
Data		Data (tenth ASCII code)		8 byte	(Note 10)
BCC		Block check code		2 byte	Exclusive OR of Code, Command and Data (5) Reference
CR		Control code(Carriage Return)		1 byte	CR (0x0D)

(Note 10) When data is the selected item, this transmits and receives corresponding to station number.

On abnormal reply : (4) - (ii) reference

(viii) 07 command: This sets 1 set item.

- Transmission frame

Frame format

STX	Code	Command	Parameter	Data	BCC	CR
		Explanation		Data size	Value	
STX		Control code(Start of TeXt)		1 byte	STX (0x02)	
Code		Station number of inverter		2 byte	01-32, FF(broadcast)	
Command		Transmission command		2 byte	07	
Parameter		Parameter number of data		4 byte	(Note 9)	
Data		Data of parameter (Tenth ASCII code)		8 byte	(Note 10)	
BCC		Block check code		2 byte	Exclusive OR of Code, Command and Data (5) Reference	
CR		Control code(Carriage Return)		1 byte	CR (0x0D)	

Reply frame

On normal reply : (4) - (i) Reference

On abnormal reply : (4) - (ii) Reference

## Chapter 4 Explanation of function

(ix) 08 command: This returns each set value to initial value.

This works in conjunction with initial selection (b084). If b084 is 00, the trip history is cleared.

- Transmission frame

Frame format

STX	Code	Command	BCC	CR
-----	------	---------	-----	----

	Explanation	Data size	Value
STX	Control code(Start of TeXt)	1 byte	STX (0x02)
Code	Station number of inverter	2 byte	01-32, FF(broadcast)
Command	Transmission command	2 byte	08
BCC	Block check code	2 byte	Exclusive OR of Code, Command and Data (5) Reference
CR	Control code(Carriage Return)	1 byte	CR (0x0D)

Replay frame

On normal reply : (4) - (i) Reference

On abnormal reply : (4) - (ii) Reference

(x) 09 command: This checks whether it is possible to store set value to EEPROM or not.

- Transmission frame

Frame format

STX	Code	Command	BCC	CR
-----	------	---------	-----	----

	Explanation	Data size	Value
STX	Control code(Start of TeXt)	1 byte	STX (0x02)
Code	Station number of inverter	2 byte	01-32
Command	Transmission command	2 byte	09
BCC	Block check code	2 byte	Exclusive OR of Code, Command and Data (5) Reference
CR	Control code(Carriage Return)	1 byte	CR (0x0D)

- Transmission frame

Frame format

STX	Code	ACK	Data	BCC	CR
-----	------	-----	------	-----	----

	Explanation	Data size	Value
STX	Control code(Start of TeXt)	1 byte	STX (0x02)
Code	Station number of inverter	2 byte	01-32
ACK	Control code(ACKnowledge)	1 byte	ACK (0x06)
Data	Data	2 byte	Allowance with 01 00: Prohibition
BCC	Block check code	2 byte	Exclusive OR of Code, Command and Data (5) Reference
CR	Control code(Carriage Return)	1 byte	CR (0x0D)

On normal reply : (4) - (i) Reference

## Chapter 4 Explanation of function

(xi) 0A command: This stores the set value to the EEPROM.

- Transmission frame

Frame format

STX	Code	Command	BCC	CR
-----	------	---------	-----	----

	Explanation	Data size	Value
STX	Control code(Start of TeXt)	1 byte	STX (0x02)
Code	Station number of inverter	2 byte	01-32
Command	Transmission command	2 byte	0A
BCC	Block check code	2 byte	Exclusive OR of Code, Command and Data (5) Reference
CR	Control code(Carriage Return)	1 byte	CR (0x0D)

Replay frame

On normal reply: (4) - (i) Reference

On abnormal reply: (4) - (ii) Reference

(xii) 0B command: This recalculates the internal motor constants.

This function is required when base frequency and parameter of H... is changed by RS485 communication.

- Transmission frame

Frame format

STX	Code	Command	BCC	CR
-----	------	---------	-----	----

	Explanation	Data size	Value
STX	Control code(Start of TeXt)	1 byte	STX (0x02)
Code	Station number of inverter	2 byte	01-32
Command	Transmission command	2 byte	0B
BCC	Block check code	2 byte	Exclusive OR of Code, Command and Data (5) Reference
CR	Control code(Carriage Return)	1 byte	CR (0x0D)

Replay frame

On normal reply : (4) - (i) Reference

On abnormal reply : (4) - (ii) Reference

## Chapter 4 Explanation of function

### (4) Acknowledge / Negative acknowledge response

#### (i) Acknowledge response

Reply frame

Frame format

STX	Code	ACK	BCC	CR
-----	------	-----	-----	----

	Explanation	Data size	Value
STX	Control code(Start of TeXt)	1 byte	STX (0x02)
Code	Station number of inverter	2 byte	01-32
ACK	Control code(ACKnowledge)	1 byte	ACK(0x06)
BCC	Block check code	2 byte	Exclusive OR of Code, Command and Data (5) Reference
CR	Control code(Carriage Return)	1 byte	CR (0x0D)

#### (ii) Negative acknowledge response

Reply frame

Frame format

STX	Code	NAK	Error code	BCC	CR
-----	------	-----	------------	-----	----

	Explanation	Data size	Value
STX	Control code(Start of TeXt)	1 byte	STX (0x02)
Code	Station number of inverter	2 byte	01-32
NAK	Control code (Negative ACKnowledge)	1 byte	NCK(0x06)
Error code	Error contents of Communication	2 byte	(Note 11)
BCC	Block check code	2 byte	Exclusive OR of Code, Command and Data (5) Reference
CR	Control code (Carriage Return)	1 byte	CR (0x0D)

#### (Note 11) Error code list

Error code	Contents
01H	Parity error
02H	Sum check error
03H	Framing error
04H	Overrun error
05H	Protocol error
06H	ASCII code error
07H	Reception buffer overrun error
08H	Reception time out error
-	-
-	-
11H	Error for abnormal command
12H	-
13H	Practice disapproval error
14H	-
15H	-
16H	Parameter abnormal error
17H	-

Inverter doesn't reply on all code communication.



## Chapter 4 Explanation of function

(5) About the calculation method of BCC (the Block Check Code)

(Example) 5Hz is set up by using 01 commands (the setting of the frequency command). (when the code of the inverter of the object is "01" )

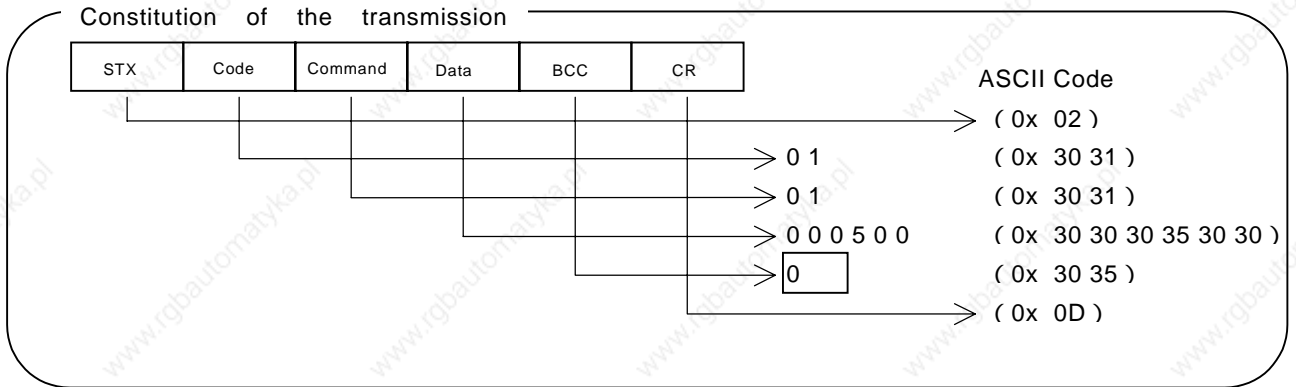

BCC is the result that transforms the Code ~ Data into ASCII Code and took an EXCLUSIVE OR (Xor) every 1byte. In the case of the above transmission frame, BCC calculates it as follows.

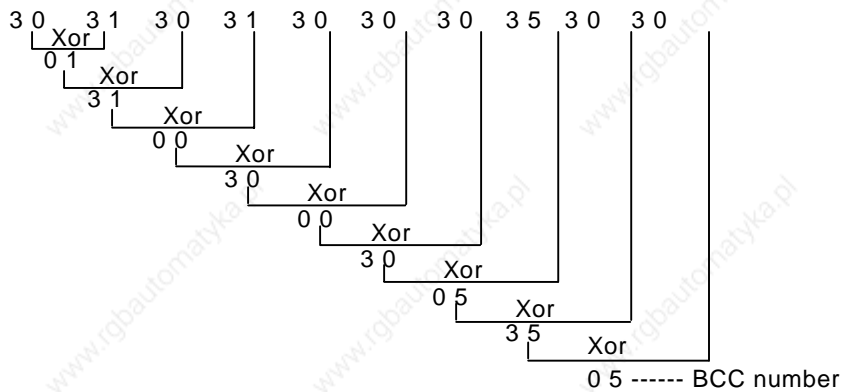

( Appendix ) ASCII code transformation table

Character data	ASCII code
STX	0 2
ACK	06
CR	0 D
NCK	15
0	3 0
1	3 1
2	3 2
3	3 3
4	3 4
5	3 5
6	3 6
7	3 7
8	3 8
9	3 9

Character data	ASCII code
A	4 1
B	4 2
C	4 3
D	4 4
E	4 5
F	4 6
H	4 8
P	5 0

### (6) Communication test mode

The communication test mode checks the communication line of RS485.

(The communication test mode procedure)

- (i) Please remove the wiring of terminal unit TM2 of the control terminal unit foundation, to do the loop back check.
- (ii) Please set up the following with the operator of the inverter.  
Please set up C071 (Communication transmission speed selection) to 02 (Loop Back Test).
- (iii) Shut the power supply of the inverter at first and please turn on the power supply once again.  
The check is started.

(iv) When the check ends the display is as follows.

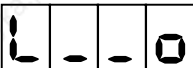
Normal : 

Abnormal : 

- (v) Please push the reset button of the digital operator or copy unit. And, the setting of C071 is returned to the setting of an original request.

## 4.4 Protection function list

### 4.4.1 Protection function

Name	Description	Display of digital panel·digital operator	Display of remote operator/ Copy unit [ERR1***]
Over-current protection	Motor is restricted and decelerates rapidly, excessive current is drawn through the inverter and there is a risk of damage. Current protection circuit operates and the inverter output is switched off.	At constant Speed	[E01] [OC. Drive]
		On deceleration speed	[E02] [OC. Decel]
		On acceleration speed	[E03] [OC. Accel]
		Other	[E04] [Over. C]
Overload protection (note 1)	When the Inverter detects an overload in the motor, the internal electronic thermal overload operates and the inverter output is switched off.	[E05]	[Over. L]
Braking resistor overload Protection	When BRD exceeds the usage ratio of the regenerative braking resistor, the over-voltage circuit operates and the inverter output is switched off.	[E06]	[OL. BRD]
Over-voltage protection	When regenerative energy from the motor exceeds the maximum level, the over-voltage circuit operates and the inverter output is switched off.	[E07]	[Over. V]
EEPROM error (note 2)	When EEPROM in the inverter is subject to radiated noise or unusual temperature rises, the inverter output is switched off.	[E08]	[EEPROM]
Under-voltage	When the incoming voltage of inverter is low, the control circuit can't operate correctly. The under-voltage circuit operates and the inverter output is switched off.	[E09]	[Under. V]
CT error	When an abnormality occurs to a CT (current detector) in the inverter, the inverter output is switched off.	[E10]	[CT]
CPU error	When a mistaken action causes an error to the built-in CPU, the inverter output is switched off.	[E11]	[CPU]
External trip	When a signal is given to the EXT intelligent input terminal, the inverter output is switched off. (on external trip function select)	[E12]	[EXTERNAL]
USP error	This is the error displayed when the inverter power is restored while still in the RUN mode. (Valid when the USP function is selected)	[E13]	[USP]
Ground fault protection	When power is turned ON, this detects ground faults between the inverter output and the motor.	[E14]	[GND. Fit]
Incoming over-voltage protection	When the incoming voltage is higher than the specification value, this detects it for 100 seconds then the over-voltage circuit operates and the inverter output is switched off.	[E15]	[OV. SRC]
Temporary power loss protection	When an instantaneous power failure occurs for more than 15ms, the inverter output is switched off. Once the instantaneous power failure wait time has elapsed and the power has not been restored it is regarded as a normal power failure. However, when the operation command is still ON with restart selection the inverter will restart. So please be careful of this.	[E16]	[Inst. P-F]
Abnormal temperature	When main circuit temperature raises by stopping of cooling fan, the inverter output is switched off.	[E21]	[OH. FIN]
Gate Array error	Communication error between CPU and gate array indicate	[E23]	[GA]
Open-phase protection	When an open-phase on the input supply occurs the inverter output is switched off.	[E24]	[PH. Fail]
IGBT error	When an instantaneous over-current is detected on the output the inverter output is switched off to protect the main devices.	[E30]	[IGBT]

## Chapter 4 Explanation of function

Name	Description	Display of digital panel digital operator	Display of remote operator/ Copy unit <span style="border: 1px solid black; padding: 2px;">ERR1***</span>
Thermistor error	When the Inverter detects a high resistance on the thermistor input from the motor the inverter output is switched off.	<span style="border: 1px solid black; padding: 2px;">E35</span>	<span style="border: 1px solid black; padding: 2px;">TH</span>
Option 1 error 0-9	These indicate the error of option 1. You can realize the details each instruction manual.	<span style="border: 1px solid black; padding: 2px;">E60</span> - <span style="border: 1px solid black; padding: 2px;">E69</span>	<span style="border: 1px solid black; padding: 2px;">OP1 0-9</span>
Option 2 error 0-9	These indicate the error of option 2. You can realize the details by each instruction manual.	<span style="border: 1px solid black; padding: 2px;">E70</span> - <span style="border: 1px solid black; padding: 2px;">E79</span>	<span style="border: 1px solid black; padding: 2px;">OP2 0-9</span>
During under-voltage waiting	When the incoming voltage of the inverter has dropped, the inverter output is switched off and the inverter waits.	<span style="border: 1px solid black; padding: 2px;">- - - -</span>	<span style="border: 1px solid black; padding: 2px;">UV. WAIT</span>

(Note 1) After a trip occurs and 10 second pass, restart with reset operation.

(Note 2) When EEPROM error E08 occurs, confirm the setting data again.

(Note 3) Protection function list of optional board.

(1) Digital-input option board (SJ-DG)

Item	Contents	Display of digital panel.	Display of remote operator <span style="border: 1px solid black; padding: 2px;">ERR1***</span>
SJ-DG Error	Detect abnormal connection between the inverter main body and SJ-DG	<span style="border: 1px solid black; padding: 2px;">E60</span> , <span style="border: 1px solid black; padding: 2px;">E70</span>	<span style="border: 1px solid black; padding: 2px;">OP1-0</span> , <span style="border: 1px solid black; padding: 2px;">OP2-0</span>

(2) DeviceNet option board (SJ-DN)

Item	Contents	Display of digital panel.	Display of remote operator <span style="border: 1px solid black; padding: 2px;">ERR1***</span>
DeviceNet communication error	This error is displayed, disconnection occurs when BusOff or timeout is occurred, while the inverter is operating with DeviceNet. (Trip is caused by P045 and P048 setting)	<span style="border: 1px solid black; padding: 2px;">E60</span> , <span style="border: 1px solid black; padding: 2px;">E70</span>	<span style="border: 1px solid black; padding: 2px;">OP1-0</span> <span style="border: 1px solid black; padding: 2px;">OP2-0</span>
Duplicate MACID	This error indicates that component have the same MACID, which exist on the same network.	<span style="border: 1px solid black; padding: 2px;">E61</span> , <span style="border: 1px solid black; padding: 2px;">E71</span>	<span style="border: 1px solid black; padding: 2px;">OP1-1</span> <span style="border: 1px solid black; padding: 2px;">OP2-1</span>
External trip	This error is displayed, when Fault / Trip is set to 1 toward control supervisor object data: Instance 1, Attribute 17.	<span style="border: 1px solid black; padding: 2px;">E62</span> , <span style="border: 1px solid black; padding: 2px;">E72</span>	<span style="border: 1px solid black; padding: 2px;">OP1-2</span> <span style="border: 1px solid black; padding: 2px;">OP2-2</span>
Inverter communication error	This error is displayed, when communication timeout occurs between the inverter and the option board.	<span style="border: 1px solid black; padding: 2px;">E69</span> , <span style="border: 1px solid black; padding: 2px;">E79</span>	<span style="border: 1px solid black; padding: 2px;">OP1-9</span> <span style="border: 1px solid black; padding: 2px;">OP2-9</span>

## Chapter 4 Explanation of function

(Note 4) If the inverter doesn't run normally or the inverter trips, check the dip switch and/or rotary switch setting on optional board.

(1) Digital-input option board (SJ-DG)

Dip switch		Rotary switch	Setting frequency				Acceleration and deceleration time setting			Torque limit setting	Position setting	
TYPE		CODE	Setting resolution									
Switch No.		Setting code	0.01Hz	0.1Hz	1Hz	Rate	0.01sec	0.1sec	1sec	1%	1pulse	
1	2											
<b>BIN</b> (Binary input at OFF) / <b>BCD</b> (BCD input at ON)	<b>PAC</b> (One time input mode at OFF)	0	<input type="radio"/>									
		1		<input type="radio"/>								
		2			<input type="radio"/>							
		3				<input type="radio"/>						
		4								<input type="radio"/>		
		5										
	6										<input type="radio"/>	
	<b>DIV</b> (Dividing input mode at ON)	0						<input type="radio"/>				
		1	<input type="radio"/>						<input type="radio"/>			
		2								<input type="radio"/>		
		3						<input type="radio"/>				
		4			<input type="radio"/>				<input type="radio"/>			
		5								<input type="radio"/>		
		6					<input type="radio"/>				<input type="radio"/>	
7								<input type="radio"/>				
8								<input type="radio"/>				
9						<input type="radio"/>						
A					<input type="radio"/>		<input type="radio"/>					
B								<input type="radio"/>				

(2) DeviceNet option board (SJ-DN)

The table below is the setting method of Baud rate (Front view of the option board.).

( ↓, ↑ indicate direction for switch of Dip switch )

Baud rate	125kbps	250kbps	500kbps
Dip switch Setting			

(Note) Do not switch on DR1 and DR0 at the same time.

The table below is the setting method of MAC ID (Front view of the option board)

MAC ID	Dip switch setting
	<p>Figure left describes the direction of Dip switches. See below. Bottom: 0 Upper: 1 Bit increases from right to left switches. Therefore, figure left becomes formula below. <math>1 \cdot 2^5 + 0 \cdot 2^4 + 1 \cdot 2^3 + 0 \cdot 2^2 + 0 \cdot 2^1 + 1 \cdot 2^0 = 29(\text{Hex}) = 41(\text{dec})</math> NA32 NA16 NA8 NA4 NA2 NA1</p>

## 4.4.2 Trip monitor display

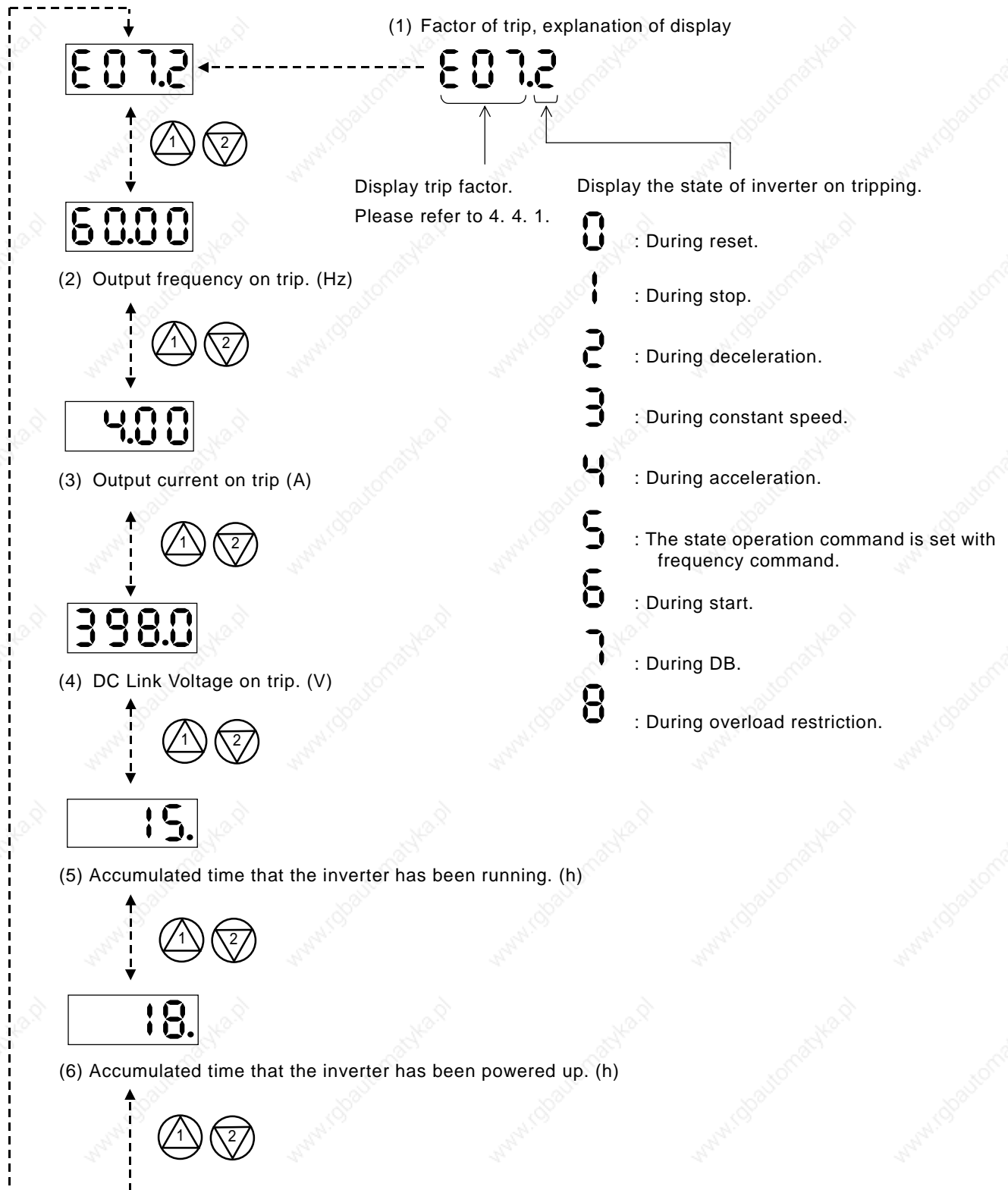

## Chapter 4 Explanation of function

### 4.4.3 Warning Monitor display

Warning messages will appear when the data set is contradicting to others.  
Program lamp (PRG) turns ON during the warning (until the data is changed).

Relation code  
d090 : Warning Monitor

Below is the description of the warnings.

Warning	Codes	<, >	Basic code
001/ 201	frequency upper limiter A061/A261	>	Maximum frequency A004/A204
	frequency lower limiter A062/A262	>	
	Base frequency A003/A203 (Note 1)	>	
	Output frequency F001, Multi stage speed 0 A020/A220	>	
	Multi stage speed 1~15 A021~A035	>	
012/ 212	frequency upper limiter A062/A262	>	frequency upper limiter A061/A261
	Output frequency F001, Multi stage speed 0 A020/A220	>	
	Multi stage speed 1~15 A021~A035	>	
021/ 221	frequency upper limiter A061/A261	<	frequency lower limiter A062/A262
	Output frequency F001, Multi stage speed 0 A020/A220	<	
031/ 231	frequency upper limiter A061/A261	<	Starting frequency b082
	frequency lower limiter A062/A262	<	
	Output frequency F001, Multi stage speed 0 A020/A220	<	
	Multi stage speed 1~15 A021~A035	<	
	Jogging frequency A038	<	
085/ 285	Output frequency F001, Multi stage speed 0 A020/A220	<>	Jump frequency 1/2/3 +- Jump width A063+-A064 A065+-A066 A067+-A068 (Note 2)
	Multi stage speed 1~15 A021~A035	<>	
091/ 291	frequency upper limiter A061/A261	>	Free v/f frequency 7 b112
	frequency lower limiter A062/A262	>	
	Output frequency F001, Multi stage speed 0 A020/A220	>	
	Multi stage speed 1~15 A021~A035	>	
110	Free v/f frequency 1~6 b100, b102, b104, b106, b108, b110	>	Free v/f frequency 1 b100
	Free v/f frequency 2~6 b102, b104, b106, b108, b110	<	
	Free v/f frequency 1 b100	>	Free v/f frequency 2 b102
	Free v/f frequency 3~6 b104, b106, b108, b110	<	
	Free v/f frequency 1, 2 b100, b102	>	Free v/f frequency 3 b104
	Free v/f frequency 4~6 b106, b108, b110	<	
	Free v/f frequency 1~3 b100, b102, b104	>	Free v/f frequency 4 b106
	Free v/f frequency 5, 6 b108~b110	<	
	Free v/f frequency 1~4 b100, b102, b104, b106	>	Free v/f frequency 5 b108
	Free v/f frequency 6 b110	<	
	Free v/f frequency 1~5 b100, b102, b104, b106, b108	>	Free v/f frequency 6 b110
	120	Free electronic thermal frequency 2, 3 b017, b019	<
Free electronic thermal frequency 1 b015		>	Free electronic thermal frequency 2 b017
Free electronic thermal frequency 3 b019		<	
Free electronic thermal frequency 1, 2 b015, b017		>	Free electronic thermal frequency 3 b019

Warning is cleared when the setting fulfils the above condition.

Data will be changed automatically to the basic code.

(Note 1) In case of this, the Base frequency will be changed to Maximum frequency. Because it has the possibility that the motor is damaged according to the value, please set the correct data when the |004/|204 will appear.

(Note 2) The jump frequency will be automatically re-written to the lowest jump frequency (= Jump frequency – jump width)

### **WARNING**

- After a lapse of more than 10 minutes after turning off the input power supply, perform the maintenance and inspection.  
Otherwise, there is a danger of electric shock.
- Make sure that only qualified persons will perform maintenance, inspection and part replacement. (Before starting the work, remove metallic objects from your person (wristwatch, bracelet, etc.)  
(Be sure to use tools protected with insulation.)  
Otherwise, there is a danger of electric shock and/or injury.

## 5.1 Precautions for Maintenance/Inspection

### 5.1.1 Daily inspection

Every day before operation check the following;

- [1] Does the motor operate according to the settings?
- [2] Is there any trouble with the surroundings of the installation?
- [3] Is there any trouble with the cooling or ventilation system?
- [4] Is there any abnormal vibration or sound?
- [5] Are there any signs of over-current or discoloration?
- [6] Is there any unusual odour present?

Check the input voltage to the inverter by using a meter during running

- [1] Is the supply voltage constant?
- [2] Are all the phases of the supply balanced?

### 5.1.2 Cleaning

Make sure that the inverter is not dirty when operating.

Wipe clean with a soft cloth and synthetic detergent or ethanol.

(Note) Don't use solvents containing any of the following, acetone, benzene, toluene, alcohol etc. as they can cause melting of the inverter surface, peeling of paint.

Never clean the display part of the digital operator with detergent or alcohol.

### 5.1.3 Regular inspection

Inspections should be regularly carried out on the parts that can't be inspected while the inverter is running.

- [1] Is there any trouble with the cooling system? - - - Cleaning of air filter etc.
- [2] Check that all screw terminals and fixings are tight as they may loosen due to vibration or temperature change etc.
- [3] Is there any corrosion, damage to insulators?
- [4] Measurement of insulation resistance.
- [5] Check of cooling fan, smoothing capacitor, relay and exchange if necessary.



## Chapter 5 Maintenance, Inspection

### 5.2 Daily inspection and regular inspection

Inspection parts	Inspection item	Inspection item	Inspection cycle		Inspection methods	Decision standard	Meter	
			Daily	Regular 1 year 2 year				
Whole	Surroundings	Check temperature of surrounding, humidity, dust.	<input type="radio"/>		Refer to 2.1 Installing.	Temperature range is between -10 and 40 degrees. No dew present and humidity is below 90%.	Thermometer, hygrometer, recorder	
	Whole equipment	Is there abnormal vibration, abnormal sound?	<input type="radio"/>		By watching, hearing.	No trouble.		
	Power voltage	Is main circuit voltage normal?	<input type="radio"/>		Measurement of inverter terminal R, S, T phase voltage	Within alternating voltage allowable change.	Tester, digital multi-meter	
Main circuit	Whole	(1)Megger check Between circuit terminal and earth terminal (2)Are all screws terminals tight? (3)Is there any sign of over-voltage? (4)cleaning		<input type="radio"/>	<input type="radio"/>	(1)After you remove connector J61 from inside the inverter take out the wiring of input/output of inverter main circuit terminal and control terminal, measure between parts shortened terminal R, S, T, U, V, W, P, PD, N, RB and earth terminal with megger. (2)Incremental clamping. (3)Watch.	(1)To be over 5M ohm. (2)(3) No abnormality .	DC500V class megger
	Connection conductor/ electric line	(1)Is there warp in conductor? (2)Is there any damage of coating of wires?		<input type="radio"/>		(1)(2) By watching	(1)(2) No abnormality	
	Terminals	Is there any damage?		<input type="radio"/>		By watching.	No abnormality.	
	Inverter parts Converter parts	Resistance check between each terminal.			<input type="radio"/>	Take out connect of inverter, measure terminal between R, S, T and P, N, between U, V, W and P, N with tester x 1 Ohm range.	Refer to check method of 5.5 inverter, converter parts.	Analog form tester
	Smoothing capacitor	(1)Is there any liquid? (2)Does relief valve come out? Is there any swell? (3)Measure of allowable static-electricity.	<input type="radio"/>			(1),(2) By watching.  (3)Measure with capacity measure.	(1),(2) No abnormality  (3) Over 80% of rated capacity.	Capacity meter
	Relay	(1)Is there abnormal sound in operation? (2)Is there damage to the contacts?		<input type="radio"/>		(1)By hearing (2)By watching	(1),(2) No abnormality	
	Resistor	(1)Is there any crack, discoloration of resistance insulator. (2)Confirm existance of breaking of wire.		<input type="radio"/>		(1)By watching.cementing resistance. Curl type resistance. (2)Take out connection to other side, measure it with tester.	(1)No abnormality Error to be within 10% of Display resistance.	Tester, Digital multi-meter
Control circuit, Protection circuit	Operation check	(1)Confirm balance of each output phase voltage with inverter single operation. (2)Operate sequence protection moving test. And no abnormality.		<input type="radio"/>		(1)Measure inverter output terminal U, V, W phase voltage.  (2)Short or open protection circuit output of inverter.	(1)Phase voltage balance 200V/400V class is within 4V/8V.  (2)On sequence, to operate abnormality.	Digital multi-meter, rectification type voltmeter
Cooling system	Cooling fan	(1)Is there abnormal vibration, abnormal sound? (2)Is there loosening of connecting parts?	<input type="radio"/>			(1)Revolve by hands in the state of tone-on idle.  (2) By watching.	(1)Revolving smooth. (2)No abnormality.	
Display	Display	(1)Is the LED lamp illuminated? (2) Cleaning.	<input type="radio"/>			(1)Lamp indicates lamp on operator. (2) Cleaning with cloth.	(1)Confirm light.	
	Meter	Is direction value normal?	<input type="radio"/>	<input type="radio"/>		Confirm indication value of board meter.	Satisfy normal value, control value.	Voltage meter, current meter
Motor	Whole	(1)Is there abnormal signal, abnormal sound? (2)Is there any abnormal odour?	<input type="radio"/>			(1)By hearing, feeling, watching. (2)Abnormal odour from overheat, damage etc. confirmation.	(1)(2) No abnormality.	
	Insulated resistance	(1)Megger check (terminal collection - earth terminal)			<input type="radio"/>	Remove connection to U, V and W and disconnect motor wiring.	(1) To be over 5M ohm.	DC500V class megger

(Note) Life time of the capacitors depends on the ambient temperature.

### 5.3 Megger test

When executing a megger test on the inverter remove all wires to R, S, T, PD, P, N, RB, U, V and W.

Do not use a megger or buzzer on the control circuit only use a digital multi-meter.

(Megger Voltage 500V DC)

Execute megger test of main circuit after the J61 connector has been removed. Short terminals of R, S, T, PD, P, N, RB, U, V and W.

After the megger test is complete, reconnect the J61 connector as before.

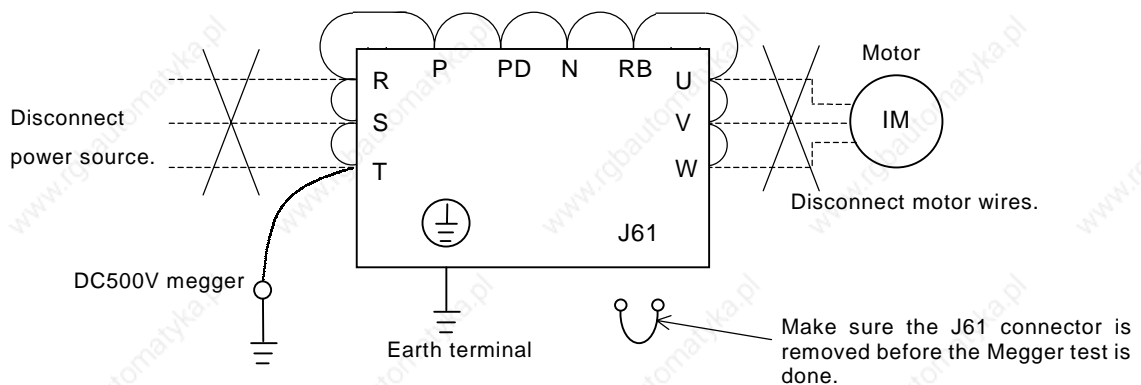

### 5.4 Withstand Voltage test

Never perform withstand voltage test on the inverter.

The inverter main circuit uses semiconductors. Semiconductors can deteriorate when a withstand voltage test is performed.

## 5.5 The method to check Inverter, converter part

A test is possible to check quality.

(Preparation)

[1] Take out the power lines (R, S and T) connected to the inverter, the motor connection lines (U, V and W) and the regenerative control resistance (P and RB).

[2] Prepare tester. (Using range of 1 ohm resistance measure range.)

(How to check)

It is possible to check the quality of the charging state of the terminals R, S, T, U, V, W, RB, P and N of the inverter and the pole of the tester by measuring the charging state.

(Note 1) Before you measure the voltage between P and N with DC current range, confirm that the smoothing capacitor is discharged fully, execute checks.

(Note 2) Almost infinite value is indicated on no conducting.

With the effect of the smoothing capacitor, the inverter conducts instantly and an infinite value isn't indicated. Ohm-number 10 ohms is indicated on conducting.

The values indicated will not be exactly the same for each terminal, however they will be very close together. If there is a significant difference a problem may exist.

		Pole of tester		Measure value
		⊕ (Red)	⊖ (Black)	
Converter	D1	R	PD	No-conduct
		PD	R	Conduct
	D2	S	PD	No-conduct
		PD	S	Conduct
	D3	T	PD	No-conduct
		PD	T	Conduct
	D4	R	N	Conduct
		N	R	No-conduct
	D5	S	N	Conduct
		N	S	No-conduct
	D6	T	N	Conduct
		N	T	No-conduct
Inverter	TR1	U	P	No-conduct
		P	U	Conduct
	TR2	V	P	No-conduct
		P	V	Conduct
	TR3	W	P	No-conduct
		P	W	Conduct
	TR4	U	N	Conduct
		N	U	No-conduct
	TR5	V	N	Conduct
		N	V	No-conduct
	TR6	W	N	Conduct
		N	W	No-conduct
BR part	TR7	RB	P	No-conduct
		P	RB	Conduct
		RB	N	No-conduct
		N	RB	No-conduct

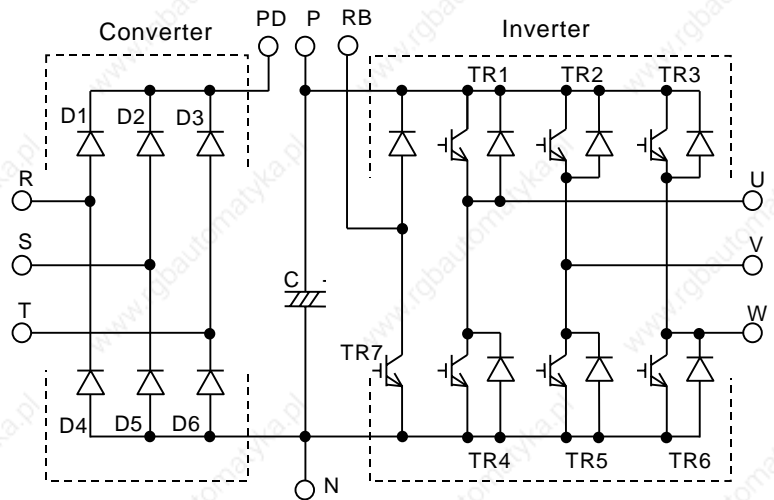

### 5.6 Capacitor Life Curve

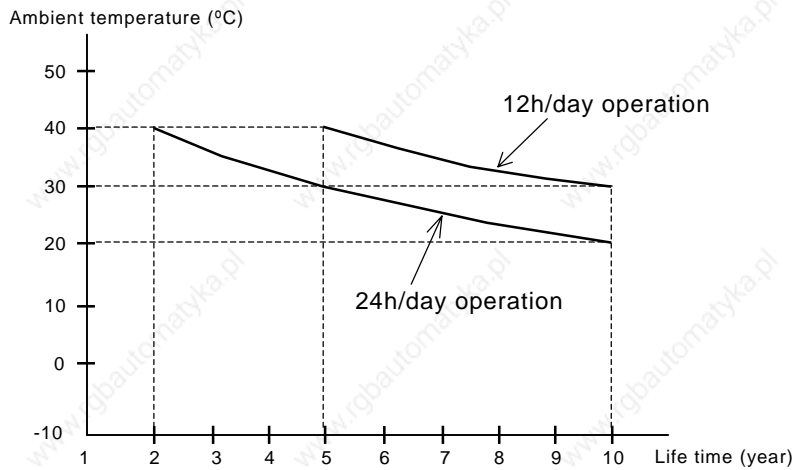

(Note 1)

Ambient air temperature means the surrounding temperature of the inverter. In case the inverter is installed in a cabinet, ambient air temperature is the temperature of the internal air of the cabinet.

(Note 2)

DC bus capacitors are recommended to be replacing every 5 years. And if the inverter is used in a worse condition, this recommended replacing period is reduced.

## 6.1 Standard specification list

		200V class									
Inverter Model		L300P 110LF	L300P 150LF	L300P 185LF	L300P 220LF	L300P 300LF	L300P 370LF	L300P 450LF	L300P 550LF	L300P 750LF	
Enclosure (Note 1)		IP20(NEMA1)									
Max. Applicable Motor 4P (kW) (Note 2)		11	15	18.5	22	30	37	45	55	75	
Rated input Alternating voltage(kVA)	200V	15.2	20.0	25.2	29.4	39.1	48.4	58.5	72.7	93.5	
	240V	18.2	24.1	30.3	35.3	46.9	58.1	70.2	87.2	112.2	
Rated input alternating voltage		Three-phase 200-240V (±10%) 50Hz/60Hz									
Rated output voltage (Note 3)		Three-phase 200-240V (This corresponds to receiving voltage.)									
Rated output current (A)		44	58	73	85	113	140	169	210	270	
Control system		Sine-wave modulation PWM system.									
Output frequency range (Note 4)		0.1-400Hz									
Frequency accuracy		Digital command ±0.01% for Max. frequency, analog frequency ±0.2%(25±10°C)									
Frequency resolving power		Digital setting: 0.01Hz, analog setting:Max. frequency /4000									
Voltage/frequency characteristic		V/f option variable, V/f control, (constant torque, reduced torque)									
Overload current rate		120% for 60 seconds, 150% for 0.5second									
Acceleration/ deceleration time		0.01-3,600seconds (straight or S-Curve on acceleration, deceleration is optional setting individually), 2 <sup>nd</sup> adjustable setting is possible.									
Control	Regenerative Control (short duration) (Note 5)	BRD circuit built-in (Discharge resistance is required.)			Regenerative unit is required.						
	DC Braking	On starting and decelerating by stop command, inverter operates under operation setting frequency. Or inverter operates with external input (Braking power, time, frequency can be set.)									
Input signal	Frequency	Operator	Setting by   keys								
		Volume	Setting with potentiometer on the digital operator (Built-in as standard) (Analog setting)								
		External Signal	DC 0 to 10V, -10 to +10V (input impedance 10k ohm), 4 to 20mA (input impedance 100 ohm)								
	Run/ Stop	External port	Setting with RS485 communication								
		Operator	Run/Stop (forward changes with code)								
		External signal	Forward Run/Stop (1a connect), reverse command is impossible on assigning of terminal (selection of 1a, 1b is possible), input of 3 wires is possible.								
Intelligent input terminal	External port	Setting with RS485.									
		Use by selecting terminals from; Reverse command (RV), multi-speed 1-4 (CF1-CF4), jogging (JG), external dc braking (DB), 2 <sup>nd</sup> control (SET), 2 <sup>nd</sup> acceleration (2CH), free-run stop (FRS), external trip (EXT), USP function (USP), commercial change (CS), software lock (SFT), analog input voltage / current / select (AT), reset inverter (RS), 3 wire run (STA), 3 wire keep (STP), 3 wire direction selection (F/R), PID selection valid/invalid (PID), PID integrating reset (PIDC), remote control up function (UP), remote control down function (DWN), remote control data clear (UDC), multi-speed bit 1-7(SF1-SF7), overload restriction change (OLR), no assign (NO)									
Thermistor input terminal		1 terminal									
Output	Intelligent output terminal	2 relay outputs (1a contact), relay(1c contact), output relay selection as follows; (selection from during running, on arrival with constant speed, over setting frequency, PID over-deviation)									
	Intelligent monitor output terminal	Analog voltage output, analog current output, pulse line output									
Display monitor		Output frequency, output current, frequency conversion value, trip history, input output terminal state, input electric power, output voltage.									
Other function		V/f free setting (5 points), Upper / lower frequency limiter, Frequency jump, Curve adjustable speed, Manual torque boost level / Braking point, Analog meter adjustment, Starting frequency, Carrier frequency adjustment, Electronic thermal free setting, External start/end (frequency/rate), Analog input selection, Trip retry, Reduced voltage start, Overload restriction									
Carrier frequency range		0.5-12 kHz									
Protection function		Over-current, over-voltage, under-voltage, electronic thermal level, abnormal trouble, ground fault current on starting, instantaneous stop, USP error, open-phase error, control resistor overload, CT error, external trip, communication error									
Usage surroundings	Frequency temperature /Preservation temperature (Note 6)/humidity	-10 to 40°C (Note 10) / -20 to 65°C / 20 to 90% RH (installed with no dew condensation)									
	Vibration (Note 7)	5.9m <sup>2</sup> /S (0.6G), 10-55Hz					2.94m <sup>2</sup> /S (0.3G), 10-55Hz				
	Using place	Under 1,000m above sea level, indoors (installed away from corrosive gasses, dust)(Note 8)									
Paint color		Blue (D.I.C14 version No.436)					Gray(MUNSELL 8.5YR6.2/0.2)				
Options		Operator with copy function, cable for operator, braking resistor, regenerative control unit, alternating reactor, D.C. reactor, EMC Mains filter, higher harmonic control unit, LCR filter, applied control installation									
Remote operator		OPE-SR, cable for remote operation ICS-1(1m), ICS3(3m) (Note 9)									
Schematic mass (kg)		5	5	12	12	12	20	30	30	50	

(Note 1) Protective system bases on JME1030.

(Note 2) Applicable motor indicates HITACHI three-phase motor. When you use other motor, set so that the motor current doesn't exceed the rated current of the inverter.

(Note 3) Output voltage will reduce when the power voltage is reduced. (Except when AVR function is selected.)

(Note 4) When you operate motor over 50/60Hz, inquire about the allowable max.revolution time of motor etc. from motor manufacturer.

(Note 5) Braking resistance isn't installed in the inverter. When the inverter requires a high regenerative torque, use optional braking resistance and regenerative braking unit.

(Note 6) Protective temperature is temperature during transportation.

(Note 7) This bases on the test methods of JIS C0911(1984).

(Note 8) When the inverter is used in a place with dust, we recommend the optional varnish coating specification. Before it is required.

(Note 9) When you use cable for remote operation, please remove connector. Please refer to 1.3 Appearance.

(Note 10) When using at 50°C of ambient air temperature, the rated output current will be reduced. (P.4-18)

(Note) Insulation distance is based on UL, CE standard.

## Chapter 6 Specification

400V class													
Inverter Model	L300P 110HF	L300P 150HF	L300P 185HF	L300P 220HF	L300P 300HF	L300P 370HF	L300P 450HF	L300P 550HF	L300P 750HF	L300P 900HF	L300P 1100HF	L300P 1320HF	
Enclosure (Note 1)	IP20(NEMA1)										IP00		
Max. Applicable Motor 4P (kW) (Note 2)	11	15	18.5	22	30	37	45	55	75	90	110	132	
Rated input Alternating voltage(kVA)	400V	15.2	20.0	25.6	29.7	39.4	48.4	58.8	72.7	93.5	110.8	135.0	
	480V	18.2	24.1	30.7	35.7	47.3	58.1	70.1	87.2	112.2	133.0	162.1	
Rated input alternating Voltage	Three-phase 380-480V (±10%) 50Hz/60Hz												
Rated output voltage (Note 3)	Three-phase 380-480V (This corresponds to receiving voltage.)												
Rated output current (A)	22	29	37	43	57	70	85	105	135	160	195	230	
Control system	Sine-wave modulation PWM system.												
Output frequency range (Note 4)	0.1-400Hz												
Frequency accuracy	Digital command ±0.01% for Max. frequency, analog frequency ±0.2%(25±10°C)												
Frequency resolving Power	Digital setting: 0.01Hz, analog setting: Max. frequency /4000												
Voltage/frequency characteristic	V/f option variable, V/f control, (constant torque, reduced torque)												
Overload current rate	120% for 60 seconds, 150% for 0.5second												
Acceleration/Deceleration time	0.01-3,600seconds (straight or S-Curve on acceleration, deceleration is optional setting individually), 2 <sup>nd</sup> adjustable setting is possible.												
Control	Regenerative Control (short duration) (Note 5)	BRD circuit built-in (Discharge resistance is required.)  Regenerative unit is required.											
	DC Braking	On starting and decelerating by stop command, inverter operates under operation setting frequency. Or inverter operates with external input (Braking power, time, frequency can be set.)											
Input signal	Frequency	Operator	Setting by   keys										
		Volume	Setting with potentiometer on the digital operator (Built-in as standard) (Analog setting)										
		External Signal	DC 0 to 10V, -10 to +10V (input impedance 10k ohm), 4 to 20mA (input impedance 100 ohm)										
	Run/ Stop	External port	Setting with RS485 communication										
		Operator	Run/Stop (forward changes with code)										
		External signal	Forward Run/Stop (1a connect), reverse command is impossible on assigning of terminal (selection of 1a, 1b is possible), input of 3 wires is possible.										
Output	External port	Setting with RS485.											
	Intelligent input Terminal	Use by selecting terminals from; Reverse command (RV), multi-speed1-4 (CF1-CF4), jogging (JG), external dc braking (DB), 2 <sup>nd</sup> control (SET), 2 <sup>nd</sup> acceleration (2CH), free-run stop (FRS), external trip (EXT), USP function (USP), commercial change (CS), software lock (SFT), analog input voltage / current / select (AT), reset inverter (RS), 3 wire run (STA), 3 wire keep (STP), 3 wire direction selection (F/R), PID selection valid/invalid (PID), PID integrating reset (PIDC), remote control up function (JP), remote control down function (DWN), remote control data clear (UDC), multi-speed bit 1-7(SF1-SF7), overload restriction change (OLR), no assign (NO)											
	Thermistor input Terminal	1 terminal											
Intelligent output Terminal	Intelligent output Terminal	2 relay outputs (1a contact), relay(1c contact), output relay selection as follows; (selection from during running, on arrival with constant speed, over setting frequency, PID over-deviation)											
	Intelligent monitor Output terminal	Analog voltage output, analog current output, pulse line output											
Display monitor	Output frequency, output current, frequency conversion value, trip history, input output terminal state, input electric power, output voltage.												
Other function	V/f free setting (5 points), Upper / lower frequency limiter, Frequency jump, Curve adjustable speed, Manual torque boost level / Braking point, Analog meter adjustment, Starting frequency, Carrier frequency adjustment, Electronic thermal free setting, External start/end (frequency/rate), Analog input selection, Trip retry, Reduced voltage start, Overload restriction												
Carrier frequency Range	0.5-12 kHz										0.5-8 kHz		
Protection function	Over-current, over-voltage, under-voltage, electronic thermal level, abnormal trouble, ground fault current on starting, instantaneous stop, USP error, open-phase error, control resistor overload, CT error, external trip, communication error												
Usage surroundings	Frequency temperature /Preservation temperature (Note 6) /humidity	-10 to 40°C (Note 10) / -20 to 65°C / 20 to 90% RH (installed with no dew condensation)											
	Vibration (Note 7)	5.9m <sup>2</sup> /S (0.6G), 10-55Hz						2.94m <sup>2</sup> /S (0.3G), 10-55Hz					
	Using place	Under 1,000m above sea level, indoors (installed away from corrosive gasses, dust)(Note 8)											
Paint color	Blue (D.I.C14 version No.436)						Gray (MUNSELL 8.5YR6.2/0.2)						
Options	Operator with copy function, cable for operator, braking resistor, regenerative control unit, alternating reactor, D.C. reactor, EMC Mains filter, higher harmonic control unit, LCR filter, applied control installation												
Remote operator	OPE-SR, cable for remote operation ICS-1(1m), ICS-3(3m) (Note 9)												
Schematic mass (kg)	5	5	12	12	12	20	30	30	60	60	80	80	

(Note 1) Protective system bases on JME1030.

(Note 2) Applicable motor indicates HITACHI three-phase motor. When you use other motor, set so that the motor current doesn't exceed the rated current of the inverter.

(Note 3) Output voltage will reduce when the power voltage is reduced. (Except when AVR function is selected.)

(Note 4) When you operate motor over 50/60Hz, inquire about the allowable max.revolution time of motor etc. from motor manufacturer.

(Note 5) Braking resistance isn't installed in the inverter. When the inverter requires a high regenerative torque, use optional braking resistance and regenerative braking unit.

(Note 6) Protective temperature is temperature during transportation.

(Note 7) This bases on the test methods of JIS C0911(1984).

(Note 8) When the inverter is used in a place with dust, we recommend the optional varnish coating specification. Before it is required.

(Note 9) When you use cable for remote operation, please remove connector. Please refer to 1.3 Appearance.

(Note 10) When using at 50°C of ambient air temperature, the rated output current will be reduced. (P.4-18)

(Note) Insulation distance is based on UL, CE standard.

6.2 Dimension

L300P-110, 150LF/HF

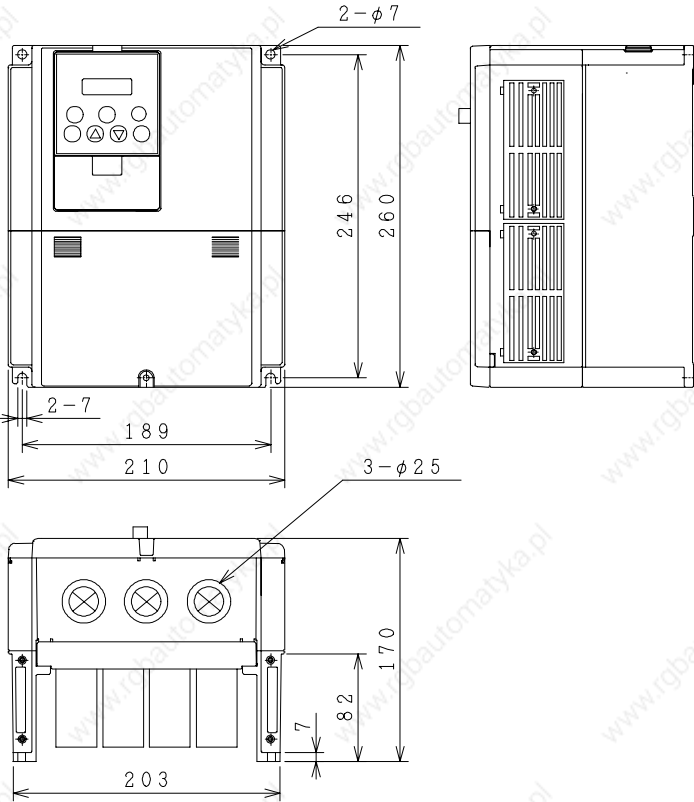

L300P-185-300LF/HF

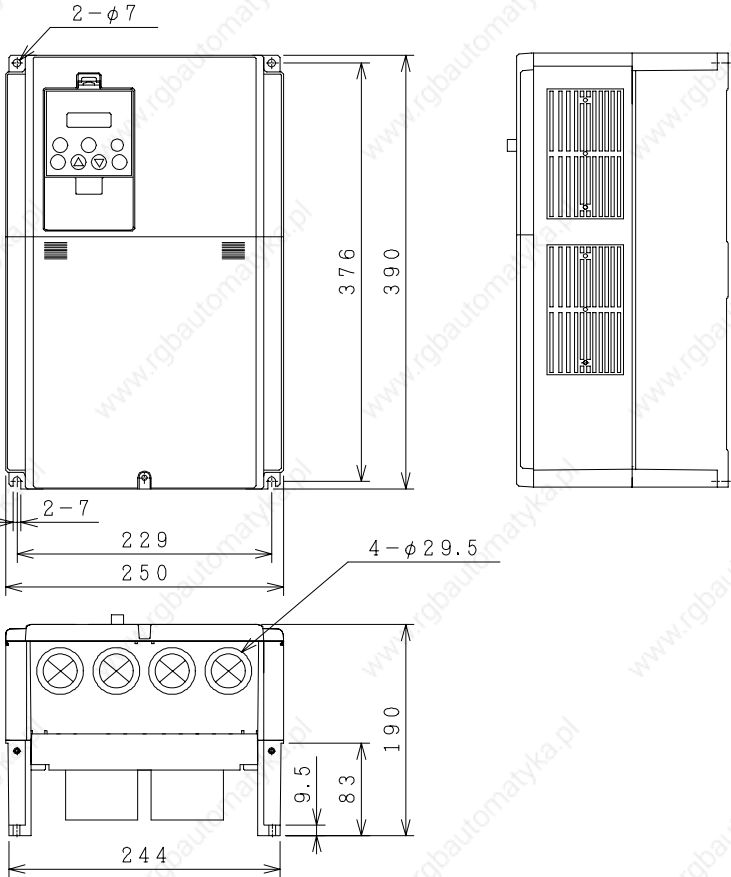

L300P-370LF/HF

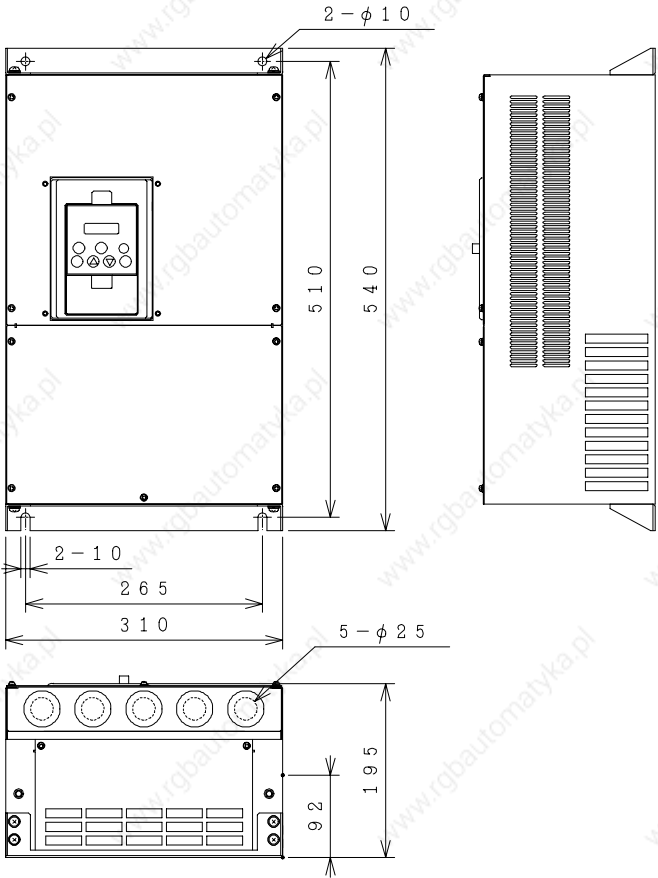

L300P-450, 550LF/HF, 750HF

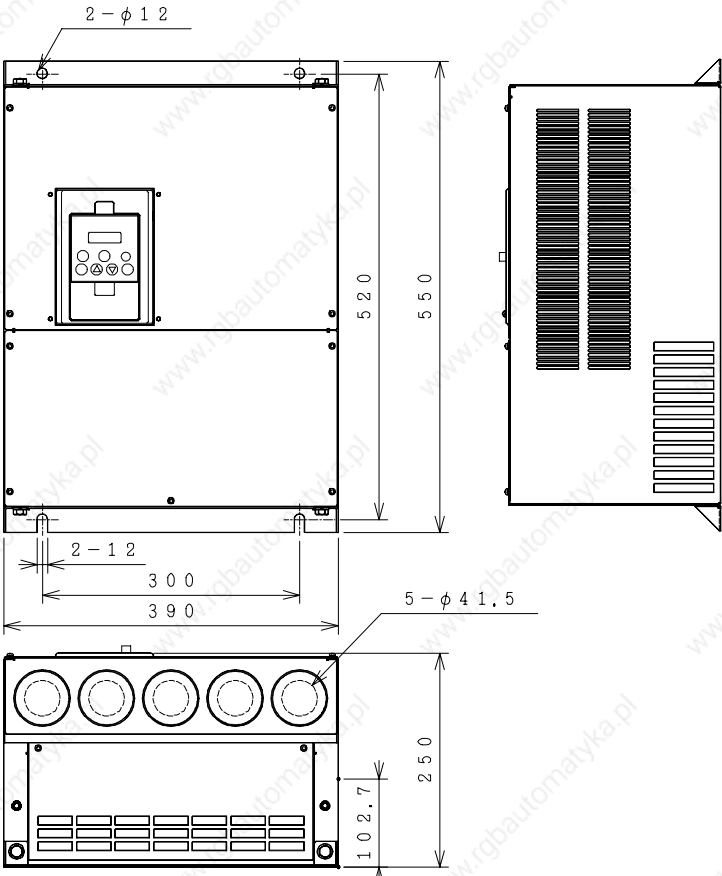



L300P-750LF

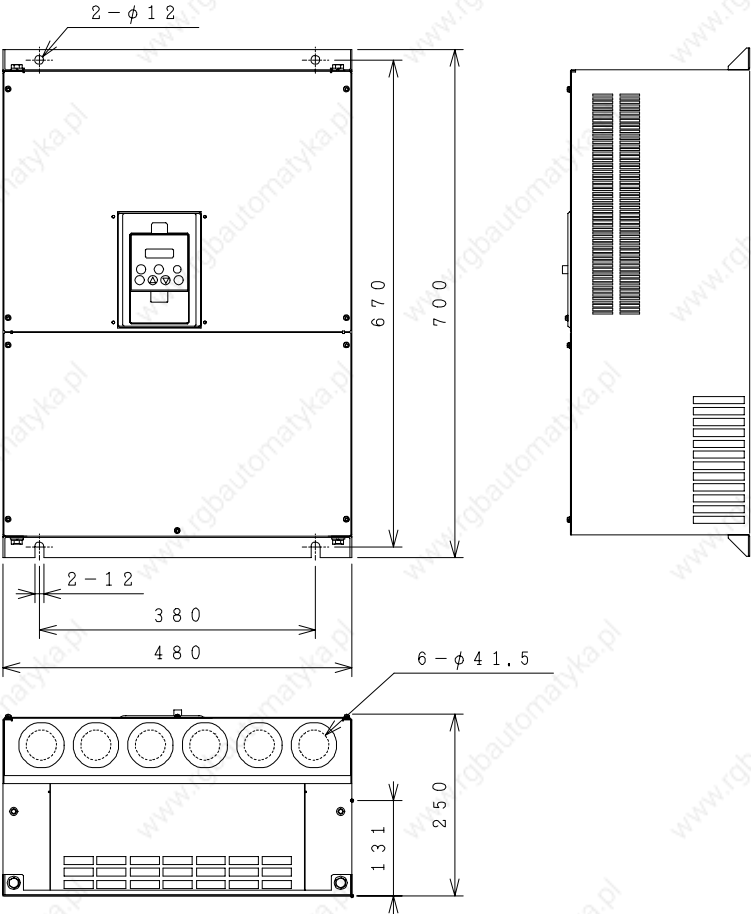

L300P-900H, 1100H

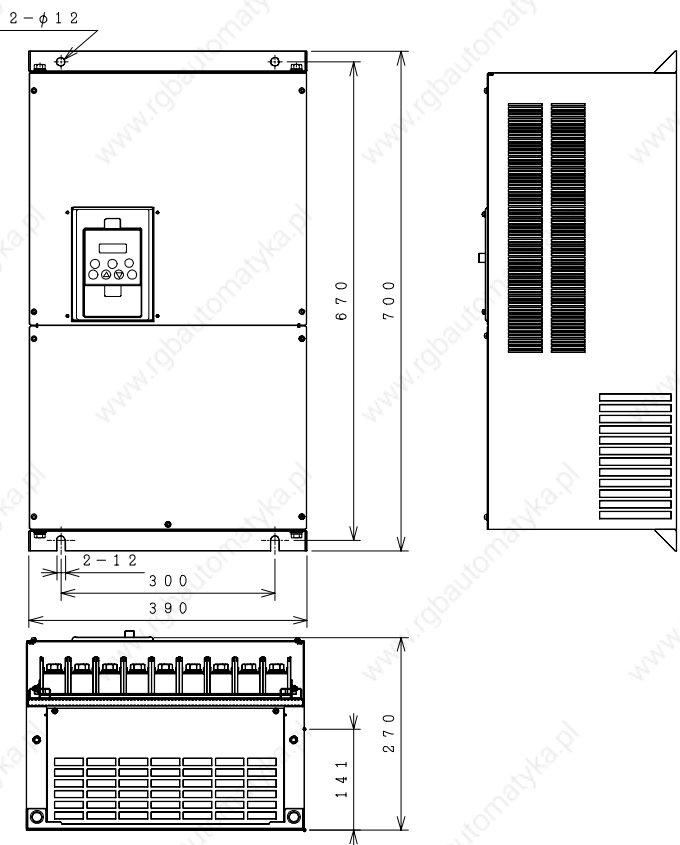

L300P-1320HF

