

4855452 INTERNATIONAL RECTIFIER

55C 05187 D

Data Sheet No. PD-4.007D

T-23-09

INTERNATIONAL RECTIFIER 

**100JB, 250JB, 26MB, 35MB
AND 36MB SERIES**
10 to 35 amp rectifier bridges

Major Ratings and Characteristics

	100JB	250JB & 26MB	35MB & 36MB	Units
I_O	10	25	35	A
I_{FSM}	@ 50 Hz	125	335	A
	@ 60 Hz	130	350	
V_{RRM}	50-1200	50-1200	50-1200	V

Description/Features

Three groups of Diode Bridge Rectifier Assemblies rated from 10 to 35 Amperes and 50 to 1,200 volts. Widely used for new circuits and for replacement.

- Ease of assembly, installation, inventory.
- High surge rating.
- For new applications.
- Broad replacement capacity.
- Universal, 3-way terminals; snap-on, wrap-around or solder.
- High thermal conductivity, electrically insulated case.

NOW
U. L. Recognized
10-35 Amp "JB" & "MB"
Series Bridges

NOTE: Fast recovery version also available. Contact your local IR sales office for information.

CASE STYLE AND DIMENSIONS

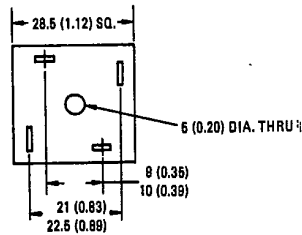
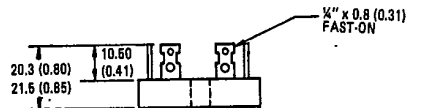
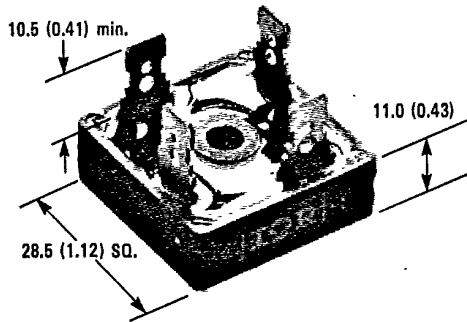

Case Style D-34

All Dimensions in Millimeters and (Inches)

D

4855452 INTERNATIONAL RECTIFIER
100JB, 250JB, 26MB, 35MB and 36MB Series

55C 05188 D
INTERNATIONAL RECTIFIER 

T-23-09

VOLTAGE RATINGS

Part Numbers ①					V _{RRM} - Max. Peak Reverse Voltage (V)	V _{RSM} - Max. Non-Repetitive Peak Reverse Voltage (V)
100JB05L	250JB05L	26MB05A	35MB05A	36MB05A	50	75
100JB1L	250JB1L	26MB10A	35MB10A	36MB10A	100	150
100JB2L	250JB2L	26MB20A	35MB20A	36MB20A	200	275
100JB4L	250JB4L	26MB40A	35MB40A	36MB40A	400	500
100JB6L	250JB6L	26MB60A	35MB60A	36MB60A	600	725
100JB8L	250JB8L	26MB80A	35MB80A	36MB80A	800	900
100JB10L	250JB10L	26MB100A	35MB100A	36MB100A	1000	1100
100JB12L	250JB12L	26MB120A	35MB120A	36MB120A	1200	1300

ELECTRICAL SPECIFICATIONS

	100JB	250JB 26MB-A	35MB-A 36MB-A	Units	Conditions
I _O Max. DC output current	10	25	35	A	Resistive or inductive load
	8	20	28		Capacitive load
I _{FSM} Max. peak one cycle, non-repetitive surge current	125	335	400	A	50 Hz half cycle sine wave or 6 ms rectangular pulse
	130	350	420		60 Hz half cycle sine wave or 5 ms rectangular pulse
i ² t Max. i ² t capability for fusing	77	560	800	A ² s	t = 10 ms Rated V _{RRM} applied following surge, initial T _J = max. operating junction temperature.
	70	510	735	A ² s	t = 8.3 ms
	109	790	1130	A ² s	t = 10 ms V _{RRM} = 0 following surge, initial T _J = max. operating junction temperature.
	99	720	1030	A ² s	t = 8.3 ms
i ² √t Max. i ² √t capability for fusing ②	1090	7910	11310	A ² √s	V _{RRM} following surge = 0, t = 0.1 to 10 ms.
V _{FM} Max. peak forward voltage	1.3	-	-	V	I _O = 10A (15.7A pk)
	-	1.1	-		I _O = 25A (39.3A pk)
	-	-	1.2		I _O = 35A (55A pk)
I _{RM} Max. peak reverse current	10			μA	T _J = 25°C
	2000				T _J = T _J max.
V _{ins} RMS isolation voltage	2700			V _{RMS}	Base plate to any terminal

② i²t for time t_x = i²√t • √t_x.

THERMAL-MECHANICAL SPECIFICATIONS

T _J Operating junction temperature range	-40 to 150	-40 to 170	°C	V _{RRM} = 50 to 600V
	-40 to 150	-40 to 150		V _{RRM} = 800 to 1200V
T _{stg} Storage temperature range	-40 to 150			°C
R _{thJC} Max. thermal resistance, junction-to-case	3.5	1.8	1.4	deg. C/W
	-	1.4	1.15	
R _{thCS} Thermal resistance, case-to-sink	0.2			deg. C/W
f Operating frequency range	40 to 1000			Hz
wt Approximate weight	20 (0.71)			g (oz.)
Case Style	D-34			

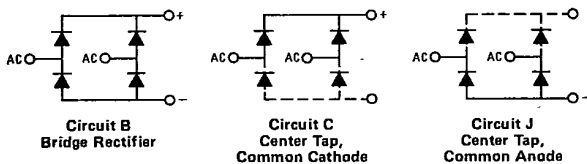

To use as a Center Tap assembly connect load either to positive or negative output terminal, as desired.

Current ratings are the same for all three applications.

4855452 INTERNATIONAL RECTIFIER
IOR INTERNATIONAL RECTIFIER

55C 05189 D

100JB, 250JB, 26MB, 35MB, and 36MB Series

T-23-09

100JB Series

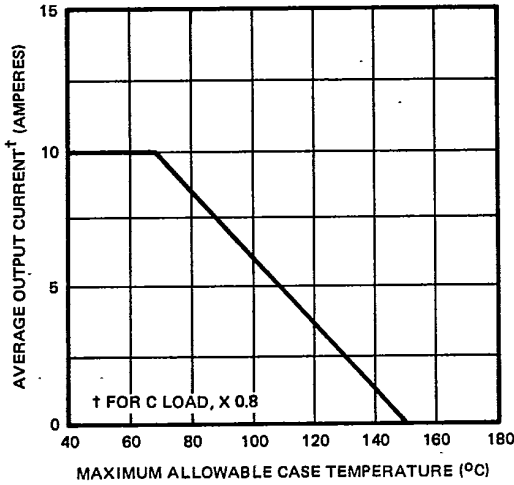

Fig. 1 – Average (DC) Output Current Vs. Maximum Allowable Case Temperature, 100JB Series

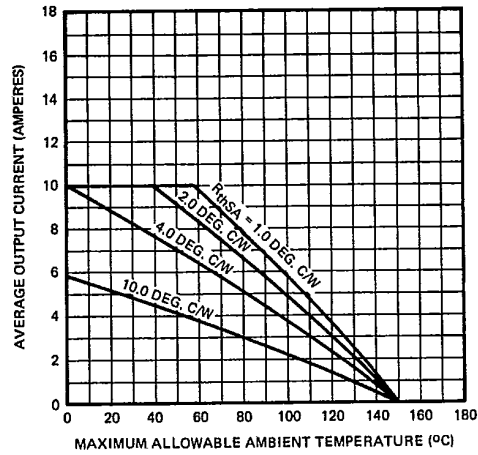

Fig. 2 – Average Output Current Vs. Maximum Allowable Ambient Temperature, 100JB Series

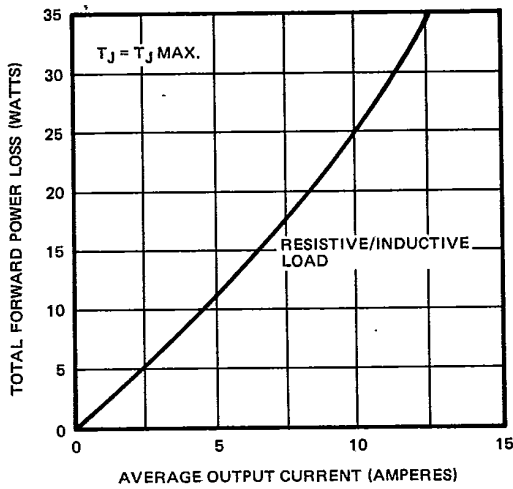

Fig. 3 – Maximum Power Loss Vs. Average Output Current, 100JB Series

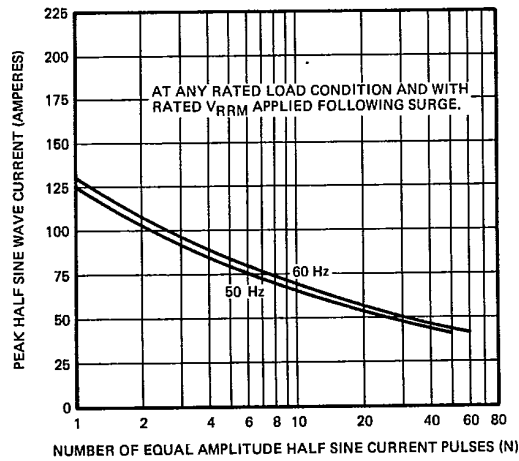

Fig. 4 – Maximum Non-Repetitive Surge Current Vs. Number of Current Pulses, 100JB Series

D

4855452 INTERNATIONAL RECTIFIER

55C 05190 D

100JB, 250JB, 26MB, 35MB and 36MB Series

INTERNATIONAL RECTIFIER 

250JB Series

T-23-09

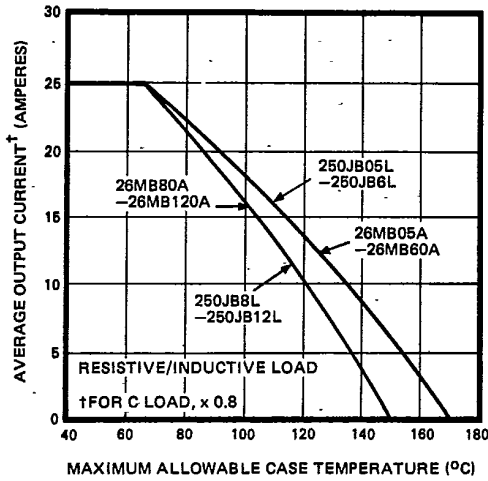

Fig. 5 - Average (DC) Output Current Vs. Maximum Allowable Case Temperature, 250JB and 26MB Series

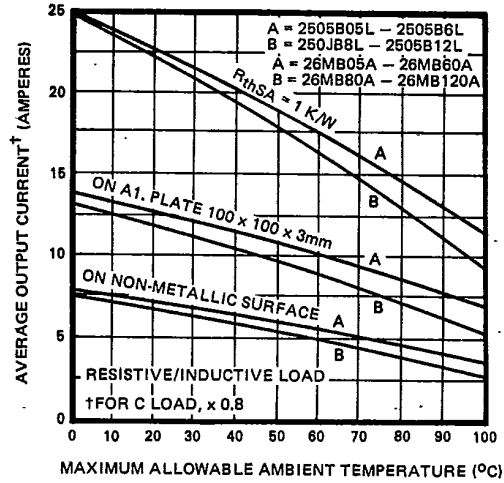

Fig. 6 - Average Output Current Vs. Maximum Allowable Ambient Temperature, 250JB and 26MB Series

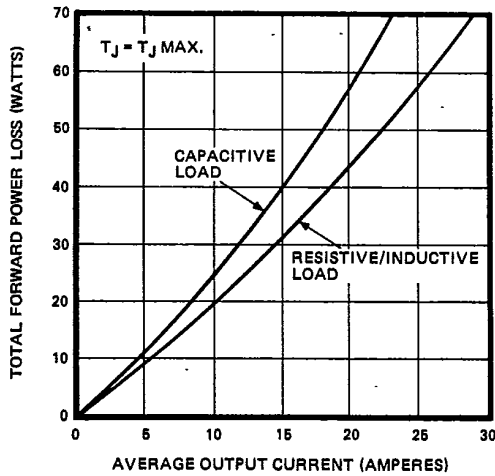

Fig. 7 - Maximum Power Loss Vs. Average Output Current, 250JB and 26MB Series

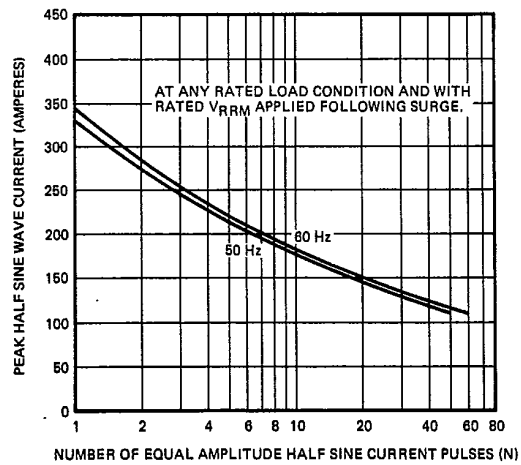

Fig. 8 - Maximum Non-Repetitive Surge Current Vs. Number of Current Pulses, 250JB and 26MB Series

4855452 INTERNATIONAL RECTIFIER



55C 05191 D

100JB, 250JB, 26MB, 35MB and 36MB Series

T-23-09

35MB and 36MB Series

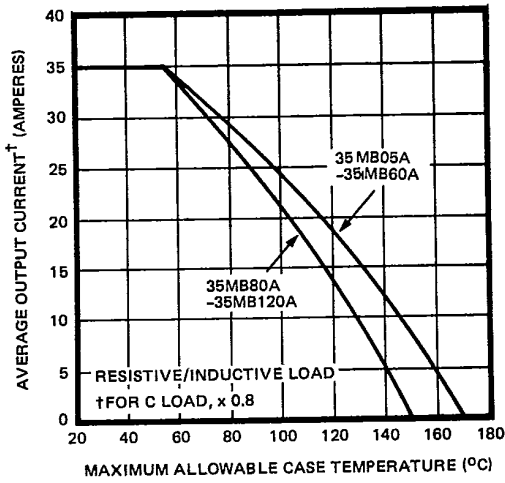

Fig. 9 – Average (DC) Output Current Vs. Maximum Allowable Case Temperature, 35MB and 36MB Series

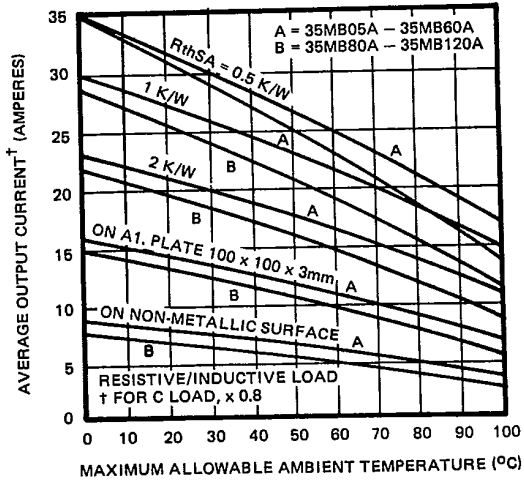

Fig. 10 – Average Output Current Vs. Maximum Allowable Ambient Temperature, 35MB and 36MB Series

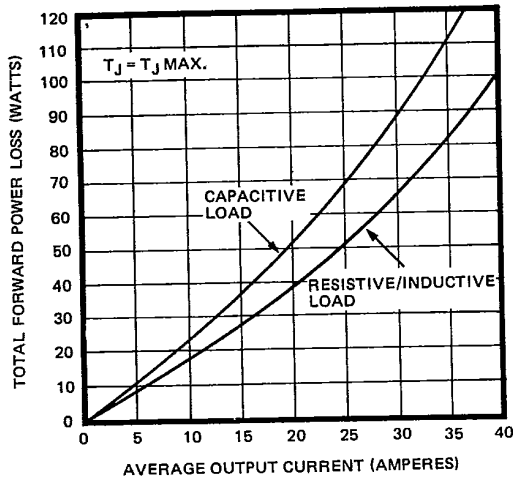

Fig. 11 – Maximum Power Loss Vs. Average Output Current, 35MB and 36MB Series

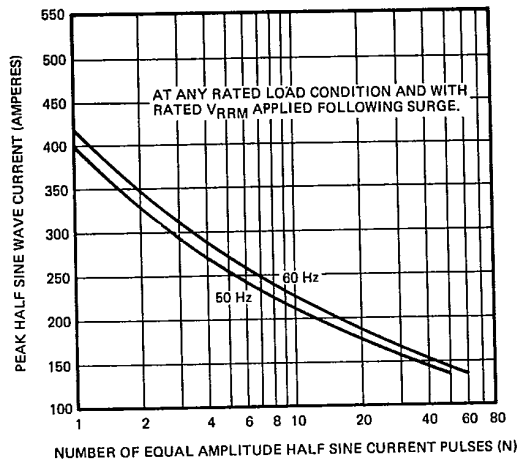

Fig. 12 – Maximum Non-Repetitive Surge Current Vs. Number of Current Pulses, 35MB and 36MB Series

