

H4D-M

Mill CNC Controller

Manual

Ver : Dec. , 2013

HUST Automation Inc.
No. 80 Kon Yei Road, Toufen, Miaoli, Taiwan
Tel: 886-37-623242
Fax: 886-37- 623241

TABLE OF CONTENTS

1	MAIN FEATURES OF MILL CNC CONTROLLER	1-1
2	OPERATION	2-1
2.1	Basic Instructions	2-1
	Power-On Display	2-1
	Standby Display	2-1
	Auto Mode Display	2-2
	MDI Mode Display	2-3
	Home Origin Mode Display	2-4
	Jog Mode display	2-5
	Edit Mode display	2-6
	Program Mode Display	2-6
	I/O Mode Display	2-8
	Tool Compensation Display	2-8
	Graph Mode Display	2-10
2.2	Programming Introduction	2-11
2.2.1	Part Program	2-11
2.2.2	Methods Of Programming	2-11
2.2.3	The Composition of A Part Program	2-13
2.2.4	Coordinate System	2-16
2.2.5	Mill CNC Control Range	2-21
2.3	Program Editing	2-21
2.3.1	Program Selection	2-22
2.3.2	New Program Edition	2-22
2.3.3	Old Program Revision	2-25
2.3.4	Delete a Program	2-28
2.3.5	Decimal Points Entering	2-28
2.3.6	Notes For Edition	2-29
2.3.7	Circular Entering	2-31
2.3.7.1	Single Drilling	2-31
2.3.7.2	Grooving	2-32
2.3.7.3	Canned Cycle	2-34
2.3.7.4	Program Edit by TEACH mode	2-35

3	Programming and Command Code	3-1
3.1	Types of Command Codes	3-1
3.1.1	One-shot G-codes	3-1
3.1.2	Modal G-codes	3-1
3.2	Fast Positioning, G00	3-4
3.3	Linear Cutting, G01	3-5
3.4	CNC and Master/Slave Mode	3-7
3.5	Arc Cutting, G02, G03	3-13
3.6	Dwell Command, G04	3-17
3.7	Clear Machine Coordinates, G08	3-18
3.8	Exact Stop Check, G09, G61, G62	3-18
3.9	Data Setting, G10	3-20
3.9.1	Set the Work Origin Using G10, G10	3-20
3.9.2	Set the Tool Length Compensation Using G10	3-21
3.9.3	Set G01 Acceleration/Deceleration time Using G10	3-23
3.10	Servo Spindle Positioning Command, G15	3-25
3.11	Cylindrical Plane, G16	3-25
3.12	Thread Cutting, G17~G18	3-29
3.13	Imperial/Metric Measuring Modes, G20, G21	3-32
3.14	G22 Linear Groove	3-32
3.15	G23 Arc Groove Milling	3-34
3.16	G24 Square Groove Milling	3-35
3.17	G25 Round Groove Milling	3-36
3.18	Return to the First Reference Point, G28	3-37
3.19	Return to Previous Position from Reference Point, G29	3-37
3.20	Return to the Second Reference Point, G30	3-38
3.21	Skip Function, G31	3-38
3.22	Coordinates Rotate Command, G38, G39	3-40
3.23	Tool Compensation	3-41
3.23.1	Tool Radius and Radius Wear Compensation, G40~G42	3-42
3.23.2	Notes on Tool Radius Compensation	3-60
3.23.3	Tool Length Compensation, G43, G44, G49	3-62
3.24	Local Coordinate System Setting, G52	3-65
3.25	Basic Machine Coordinate System, G53	3-66
3.26	Work Coordinate System Setting, G54~G59	3-68
3.26.1	Machine Coordinate System (Home)	3-68
3.26.2	Work Coordinate System Setting, G54~G59	3-69
3.27	Mirror Effect Cutting, G68, G69	3-72

3.28	Absolute and Incremental Coordinate Setting, G90, G91	3-73
3.29	Canned Cycle Functions, G81~G89	3-74
3.30	Canned Cycle Commands, G80, G81~G89	3-76
3.31	G80 Cancellation of Canned Cycle	3-76
3.32	G81 Drilling Canned Cycle	3-77
3.33	G82 Drilling Canned Cycle	3-78
3.34	G83 Deep Drilling Canned (Pack Drill) Cycle	3-79
3.35	G84 Rigid Tapping	3-80
3.36	G85 Boring Canned Cycle	3-83
3.37	G86 Boring Canned Cycle (Spindle Stop at Home Bottom)	3-84
3.38	G89 Boring Canned Cycle with Dwell at Hole Bottom	3-85
3.39	G34 Circular Drilling Canned Cycle	3-86
3.40	G35 Angular Linear Drilling Canned Cycle	3-87
3.41	G36 Arc Drilling Canned Cycle	3-87
3.42	G37 Grid Drilling Canned Cycle	3-88
3.43	G90 or G92-Absolute or Incremental Coordinates Setting	3-88
3.44	G94 or G95-Feedrate Setting	3-89
3.45	G98 or G99-Cutting Feed-Rate Setting	3-89
3.46	Auxiliary Function, M-code, S-code	3-90
3.47	Subprogram	3-91
3.47.1	Subprogram Structure	3-91
3.47.2	Execution of Subprogram	3-92
3.48	Customized Program Group [MACRO] Command, G65	3-93

4 MCM PARAMETERS 4-1

4.1	MCM Parameter	4-1
4.2	Description of MCM Machine Constants	4-32

5 CONNECTIONS 5-1

5.1	Connecting System Descriptions	5-1
5.2	System Installation	5-2
5.2.1	Ambient Surroundings	5-2
5.2.2	Cabinet Considerations	5-2
5.2.3	Thermal Design in the Cabinet	5-3
5.2.4	H4D-M External Dimensions	5-4

5.2.4	H4D-M Accessories Dimensions	5-6
5.3	Connector Type	5-8
5.4	Connector Name	5-8
5.5	Connector Pin-out Definition	5-9
	X-AXIS	5-9
	Y-AXIS	5-10
	Z-AXIS	5-11
	A-AXIS	5-12
	B-AXIS	5-13
	C-AXIS	5-14
	MPG (H4D / H6D)	5-15
	MPG (H9D)	5-16
	Axial Control, pin assignment and wiring	5-17
	MPG Hand-Wheel Connecting Diagram	5-18
	G31 INPUT Control Signals	5-19
	AD/DA Analog Signal Wiring	5-20
	Wiring of Spindle control	5-21
	AC Power System Connection	5-23
	RS232 Connector Pin Assignment and Connection Diagram	5-24

6 ERROR MESSAGES 6-1

7 APPENDIX A 7-1

	Input Arrangement (for H4D-M-3)	7-1
	Input Planning (for H4D-M-4)	7-2
	INPUT planning (for H4D-M-4)	7-3
	Output Arrangement	7-4
	M-code Versus I/O	7-4
	Others	7-4

8 APPENDIX B – z DNC Operating Instructions 8-1

8.1	Using USB Device in H4D-M	8-1
8.2	ZDNC Operation	8-4

9	APPENDIX C – Master Axis Settings and G84 Mode	9-1
----------	---	------------

1 MAIN FEATURES OF MILL CNC CONTROLLER

- Controlled Axis: X,Y,Z and Spindle Encoder Feedback
- Program Designed by CAD/CAM on PC. Program input and DNC on-line execution from PC through RS232C interface.
- Memory Capacity for CNC main board - 1024k.
- Battery Backup for CNC program storage in case of power-off.
- Backlash error compensation for worn lead screw.
- Provide 40 sets of tool length offset.
- Self-designed MACRO Program.
- Single block and continuous commands.
- Option Skip functions.
- Option Stop and Feed hold functions.
- Simultaneous use of absolute and incremental coordinate in the program.
- Self-diagnostic and error signaling function.
- Direct use of “ R”, “ I” and “ J” incremental value for radius in circular cutting.
- MPG hand-wheel test and collision free function for cutting product at the speed controller by MPG.
- Equipped with 24 standard programmable inputs and 16 outputs.

This operator's manual includes program editing, G/M code, parameter settings, connections and maintenance (plus warn descriptions) with examples and explanations for each command instruction.

If there are any problems in application, please fill out a problem sheet indicating the natures of the problem. Send it by either fax or mail. We will respond to you as soon as possible.

2 OPERATION

2.1 Basic Instructions

Operating Diagrams

- **Power-on Display**

You will see this image after the power is on like the illustration below:

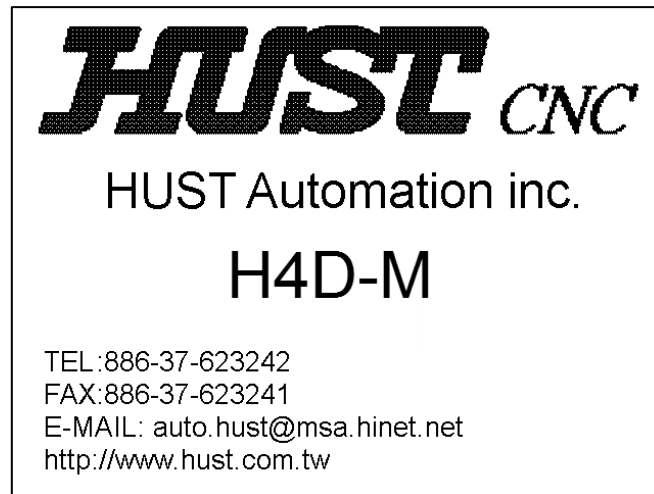

Fig.2-1

- **Standby Display**

After 3 seconds, you will enter the standby display. You can also obtain the same image when you press "Reset" key like the image below:

WORK-POS G54 PGM NO 000 _			
PROGRAM-POS	FL_ERR	G00 MFO 000 % M:00000	
X: -0000.000	-0000	G01 MFO 000 % T:00000	
Y: -0000.000	-0000	SSO MFO 000 % S:00000	
Z: -0000.000	-0000	F:0000000 Fc: 0000000	
A: -0000.000	-0000	SP-RPM 0000000	
SP: -000.00			
OFFSET	X -0000.000	Y -0000.000	
	Z -0000.000	A -0000.000	
MOTOR NOT HOME COUNT MAX		TIME: 0000000 S	
AUTO — HOLD			
MPG-TEST	SINGLE	DRYRUN	OP-STOP Feed-Hold

Fig.2-2

● **Auto Mode Display**

Press key “Auto/ MDI” to enter the auto mode, the display is shown below:

WORK-POS G54 PGM NO 000 _				
PROGRAM-POS	FL ERR.	G00 MFO 000 % M:00000		
X: -0000.000	-0000	G01 MFO 000 % T:00000		
Y: -0000.000	-0000	SSO MFO 000 % S:00000		
Z: -0000.000	-0000	F:0000000 Fc: 0000000		
A: -0000.000	-0000	SP-RPM 0000000		
SP: -000.00				
OFFSET	X -0000.000	Y -0000.000		
	Z -0000.000	A -0000.000		
MOTOR NOT HOME COUNT MAX		TIME: 0000000 S		
AUTO — HOLD				
MPG-TEST	SINGLE	DRYRUN	OP-STOP	Feed-Hold

Fig. 2-3

Soft keys under the auto mode:

1. Program Feed-Hold: only valid during the program operation.
In the program operation, press the key and the program will stop immediately. You can continue operating the program by press this soft key again or CYCST key.
2. Single Step Execution: users can select the function any time without being limited in the state of operation or stop. This function can only carry one step by each key press of restart instead of executing the whole program continuously.
3. Program Dry Run: only can be selected before the program execution, however, it can be canceled anytime during the execution. When the program dry run is being selected, the speed of F values in the program is in valid if it is executed in the highest speed (MCM79~81).
4. MPG - TEST: users can select the function any time without being limited in the state of operation or stop. When the function is being selected, the movement of all the axis in the program can only be controlled by MPG. If there is no input of MPG, the axis will stop moving.
5. Option Stop: only can be selected before the program execution. When option stop is being selected, M01 commend in the program will be considered as a stop commend. It is meaningless if M01 is not selected.
6. Re_start: This function needs to be selected before the program runs.
When the "Re_start" function is selected, program operation proceeds with the execution from the position interrupted.

Pressing the next key can switch over the function key and select .

Part numbers: each execution to M02, M30, M99 will add on one. If users need to return to zero manually, please press the “0” key twice immediately to return zero.

Part time: show the current executing time. After each program end or stop, it will automatically return to zero when it restarts.

● MDI Mode Display

Press 『 Auto/ MDI 』key twice to enter the MDI mode, the display is shown below:

WORK-POS G54 PGM NO 000_			
PROGRAM-POS	FL_ERR	G00 MFO 000 % M:00000	
X: -0000.000	-0000	G01 MFO 000 % T:00000	
Y: -0000.000	-0000	SS0 MFO 000 % S:00000	
Z: -0000.000	-0000	F:0000000 Fc: 0000000	
A: -0000.000	-0000	SP-RPM 0000000	
SP: -000.00			
OFFSET	X -0000.000	Y -0000.000	
	Z -0000.000	A -0000.000	
MOTOR NOT HOME COUNT MAX		TIME: 0000000 S	
MDI — HOLD			

Fig.2-4

● Home Origin Mode Display

Press 『 JOG/HOME 』 key twice to enter the home origin mode, the display is shown below:

WORK-POS G54 PGM NO 000			
PROGRAM-POS	FL-ERR.	MACHINE-POS	RELATIVE-POS
X: -0000.000	-0000	-0000.000	-0000.000
Y: -0000.000	-0000	-0000.000	-0000.000
Z: -0000.000	-0000	-0000.000	-0000.000
A: -0000.000	-0000	-0000.000	-0000.000
SP: -000.00			
G00 MFO 000 %	M:00000	MPG X: 000	
G01 MFO 000 %	T:00000	SP-RPM: 0000000	
SSO MFO 000 %	S:00000	F:0000000	Fc: 0000000
TIME: 0000000 S			
HOME — STOP			
		Relative-Pos	Z>XYA

Fig.2-5

Methods for returning the origin:

1. Select the axis: there are some ways to select the axis. You can either press the English letter “ X ”, “ Y ”, “ Z ” on the right of the screen directly or press the key button “ X+ ”, “ X- ”, “ Y+ ”, “ Y- ”, “ Z+ ”, “ Z- ” to make your selection.
2. Press “ CYCST ” key

Note: if the three axes come back to its origin at the same time, press the key “Home” in 3 seconds.

- Jog Mode display

Press 『JOG/HOME』 key to enter jog mode, the display is shown below:

WORK-POS G54 PGM NO 000			
PROGRAM-POS	FL-ERR.	MACHINE-POS	RELATIVE-POS
X: -0000.000	-0000	-0000.000	-0000.000
Y: -0000.000	-0000	-0000.000	-0000.000
Z: -0000.000	-0000	-0000.000	-0000.000
A: -0000.000	-0000	-0000.000	-0000.000
SP: -000.00			
G00 MFO 000 %	M:00000	MPG X: 000	
G01 MFO 000 %	T:00000	SP-RPM: 0000000	
SSO MFO 000 %	S:00000	F:0000000	Fc: 0000000
TIME: 0000000 S			
JOG — HOLD			
WORKPOS	DRILL	Relative-Pos	USB-H

Fig.2-6

There are several functions under the jog mode:

1. Axis positioning:
 - a. Continuous movement: (Single step function is not on)
Continuously press “X+” key and X-axis will do positive movement, X-axis will do negative movement. Z-axis is followed the same way.
 - b. Move single step:
Select your desired distance for each single step such as 0.001,0.01,0.1,1 and press X+, X-,Y+,Y-, Z+,Z-. The system will follow the selection to make the step.
2. Manual Switch (Soft_Key):
 - a. Spindle: Clockwise, Counter Clockwise, Stop.
 - b. Coolant: Press on and off key
 - c. Lubricant: Press the key and it will be provided after 1 second.
LED is the indicator for the operation.

- a. Use cursor up and down or page up and down to select the note numbers.
- b. Enter the English letter or number.
- c. Press enter key.
3. Program Delete:
 - a. Use cursor up and down or page up and down to select the delete numbers.
 - b. Press delete key, the dialogue box will appear to confirm your command. Press soft key YES or Y to clear the program. Press NO or N key to cancel the delete program.
4. Program Copy:
 - a. Press "copy" key, it shows as follows:

PGM NO 000 _				
>0000 :				
0001 :				
0002 :			EMPTY	
0003 :			EMPTY	
0004 :			EMPTY	
0005 :			EMPTY	
0006 :			EMPTY	
0007 :			EMPTY	
0008 :			EMPTY	
0009 :			EMPTY	
0010 :			EMPTY	
0011 :			EMPTY	
FROM 000 NO-PRG COPY TO 000 NO-PRG				
			A	-0000.000
X	-0000.000	Y	-0000.000	Z -0000.000
PRNO — STOP				
SOURCE		TARGET		COPY

Fig.2-9

- b. Use cursor up and down or page up and down to point at the source program numbers.
- c. Press Source key
- d. Use cursor up and down or page up and down to select the purpose numbers.
- e. Press purpose key
- f. After confirmation for both source and purpose of program numbers, and press executing key. The copy is complete.

● I/O Mode Display

Press 『 I/O / MCM 』 key to enter I/O mode, the display is shown below:

I00	E-STOP	I12	MPG X10
I01	X HOME	I13	MPG X100
I02	Y HOME	I14	X SERVO READY
I03	Z HOME	I15	Y SERVO READY
I04	CYCST	I16	Z SERVO READY
I05	UNCLAMP KEY	I17	SP SERVO READY
I06	A HOME	I18	X OT +
I07	A SERVO READY	I19	X OT -
I08	MPG A	I20	Y OT +
I09	MPG X	I21	Y OT -
I10	MPG Y	I22	Z OT +
I11	MPG Z	I23	Z OT -

OUTPUT	IOCSA	VAR	System data	
--------	-------	-----	-------------	--

Fig.2-10

Press 『 F1 』 key to show the output status.

Press 『 F2 』 key to show the IOCSA status.

Press ←



PAGE



IBIT	0	1	2	3	4	5	6	7	8	9	A	B	C	D	E	F
0000	0	0	0	0	0	0	0	0	0	0	0	0	0	0	0	0
0016	0	0	0	0	0	0	0	0	0	0	0	0	0	0	0	0
0032	0	0	0	0	0	0	0	0	0	0	0	0	0	0	0	0
0048	0	0	0	0	0	0	0	0	0	0	0	0	0	0	0	0
0064	0	0	0	0	0	0	0	0	0	0	0	0	0	0	0	0
0080	0	0	0	0	0	0	0	0	0	0	0	0	0	0	0	0
0096	0	0	0	0	0	0	0	0	0	0	0	0	0	0	0	0
0112	0	0	0	0	0	0	0	0	0	0	0	0	0	0	0	0
0128	0	0	0	0	0	0	0	0	0	0	0	0	0	0	0	0
0144	0	0	0	0	0	0	0	0	0	0	0	0	0	0	0	0
0160	0	0	0	0	0	0	0	0	0	0	0	0	0	0	0	0
0176	0	0	0	0	0	0	0	0	0	0	0	0	0	0	0	0
0192	0	0	0	0	0	0	0	0	0	0	0	0	0	0	0	0
0208	0	0	0	0	0	0	0	0	0	0	0	0	0	0	0	0
0224	0	0	0	0	0	0	0	0	0	0	0	0	0	0	0	0
0240	0	0	0	0	0	0	0	0	0	0	0	0	0	0	0	0

to change the status

OUTPUT	IOCSA	VAR	System data	
--------	-------	-----	-------------	--

Fig.2-11

Press 『 F3 』 key to show the Customer-specific variables.

Press 『 F4 』 key to show the controller system data.

● Tool Compensation Display

Press 『 TOOL.Radius / TOOL.Offset 』 to enter wear compensation directly in the tool compensation mode.

● **Graph Mode Display**

Single press the key “ Graph “ to enter the graph mode display as follows:

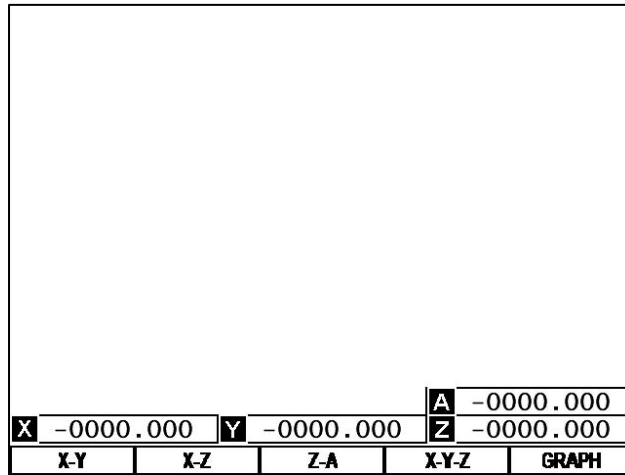

Fig. 2-14

Sign “ + “ in the center of the display shows the zero location. Use cursors to move the zero location.

On the bottom right corner of the screen shows the current coordinate. There are 5 selections to choose 3 different coordinates such as X-Y, Y-Z, X-Z, X-Y-Z.

Number 123 on the bottom right corner of the display shows the current graph of horizontal ratio setting. The ratio can also be changed by page up and down.

The image can be cleared by press the “ CLEAR “ key.

Note that it will automatically switch to auto mode after entering graph mode to operate programs.

2.2 Programming Introduction

2.2.1 A Part Program

Prior to cutting a machine part by using a CNC cutting tool, a computer program, called a part program, must be created to describe the shape of the parts, which is based on some kind of coordinate system. The cutting tool will then follow these coordinates to do exact cutting. To create a part program, a concise machining plan is a necessity, which includes the coordinates for the machine part, coolant, spindle speed, tool type, I/O-bit, etc.. When design a machining plan, the following factors must be considered:

1. Determine the machining range requirement and select the suitable CNC machine tool.
2. Determine the work-piece loading method and select the appropriate cutting tool and the tool holder.
3. Determine the machining sequence and the tool path.
4. Determine the cutting conditions such as spindle speed (S), federate (F), coolant, etc.

A part program is a group of sequential instructions formulated according to the machining plan. It can be edited either on a personal computer (PC), then transmitted to the CNC controller through RS232C interface or directly on the CNC controller using the editing keys. Lathe can do both. They will be discussed later.

2.2.2 Methods Of Programming

A CNC controller will execute the commands exactly in accordance with the instructions of the part program. So, the program design is the most important task in the whole CNC machining process. There are two ways to design a CNC part program and are to be briefly described as bellows:

1. Manual Programming

Manual programming is a process that the whole process is manually done by hand including the coordinate calculations. It follows this sequence.

- Machine part drawing.
- Part shape description includes coordinate calculations.
- Computer program design includes spindle speed, feed rate, M-code, etc..
- Keying in the program instructions into the CNC controller or transmitted from PC.
- Testing the program.

The coordinate calculation is a simple process if the part shape is composed of straight lines or 90-degree angles. For curve cutting, however, the calculation will be more complicate and trigonometry will be required for correct answers. Once all calculations have been completed, the CNC part program is written in the formats to be discussed later.

The main disadvantage of manual programming, particularly when designing for a very complicated part, is time consuming and prone to making errors. In this case, automatic programming becomes more advantageous than the manual methods.

2. Automatic Programming

Automatic programming is a process in which the design work included coordinate calculation that is done by computer. It follows this sequence.

- Computer added design for part drawing (CAD)
- Computer added manufacturing for CNC part program (CAM)
- Transferring program to CNC controller.
- Testing the program.

By making use of computer's high speed calculating capability, program designer can communicate with the computer in simple language, to describe the shape, size and cutting sequence of the part. The computer will transfer the motions to the machine tool into a part program, which is then transferred into CNC controller through RS232C interface. This process is called CAD/CAM. It is a necessary tool when designing a part program for a 3-D work-piece.

2.2.3 The Composition of A Part Program

A complete part program is composed of program blocks, starting with a program number Oxxx, ended with M2, M30, or M99, and in between with a series of CNC instructions. A CNC instruction is a command to order the cutting tool to move from one location to another with the specified speed, or the peripheral equipment to do some mechanical work. The cutting is done when the cutting tool moves.

An example of a complete part program containing 10 blocks is as follows:

```
N10 G00 X0.000 Y0.000 Z0.000
N20 M3 S1000
N30 G01 X10.000 Y10.000 Z10.000 F200
N40 X20.000
N50 Y20.000
N60 Z20.000
N80 G0 X0.000 Y0.000 Z0.000
N90 M5
N100 M2
```

A block of program can have one to several instructions and it has a general form as follow. The block sequence number "Nxx" can be omitted. If you do not key in the block number, Lathe has a special function "Auto-N" to automatically generate the number for you during or after program editing (see chapter 6). The program execution starts from top to bottom block and has nothing to do with the order of block sequence number. Each instruction starts with an English letter (A~Z), followed by a integer or floating number, depending on what type of instruction the number is associated with. If the number represents a coordinate, it can be positive (+) or negative (-).

N ___ G ___ X (U) ___ Y(V) ___ Z(W) ___ F ___ S ___ D(H) ___ M ___

N : block sequence
 G : function command
 X, Y, Z : coordinate position command (absolute position command)
 U, V, W : coordinate position command (incremental position command)
 F : Feed rate

- S : Spindle speed
- D, H : Tool numbers.
- M : Auxiliary command (machine control codes)

In general, the program instructions can be divided into four categories.

1. Function command :
G-code. A CNC command to instruct the cutting tool to do an action, such as straight, circular or thread cut, compound cut, etc.
2. Position command:
X,Y, Z, U,V, W--a coordinate command to instruct the cutting (Motion command) tool to stop the cutting action at the location specified -- an end point. The end point of the current block is the starting point of the next block.
3. Feed-rate command:
F-code. A command to instruct the cutting tool how fast to do the cutting.
4. Auxiliary command :
M, S, D, L, etc. A command to instruct the peripheral equipment to do an action, such as spindle speed, coolant on/off, program stop, etc.

Note that not every block is composed from these four parts. Some have only one command. We will have further discussions in chapter 3. In the single block format, most of them are command functions except the series number "N____" of single block. Command function is composed of letters, \pm signs and numbers.

Basic command format (similar with position command):

X-10.000

- X : command code
- "-" : positive and negative signs(sign + can be omitted)
- 10.000 : destination point for tool position

Each command code has a fixed format and a special meaning to the CNC controller and it must be strictly followed when designing a program. The system will not accept the command if the format is in error. Otherwise, a machine error will result. Followings are the command codes that are used in H4D-M.

D	: Tool radius compensation number.
F	: Feed-rate in mm/min or mm/revolution, a decimal.
G	: Function G-code, an integer.
H	: Tool offset compensation number.
I	: The X-axis component of the arc radius @ the start point, a decimal.
J	: The Y-axis component of the arc radius @ the start point, a decimal.
K	: The Z-axis component of the arc radius @ the start point, a decimal.
K, L	: Repetition counter, integer.
M	: Control code for peripheral machine tool, integer.
N	: Program block (sequence) number, integer.
O	: Program numbers.
P	: Dwell time; subprogram code; or parameter in canned cycles, integer.
Q	: Parameter in canned cycles, integer.
R	: Arc radius or "R" point in canned cycles, decimal.
S	: Spindle speed, integer.
U	: Incremental coordinate in X-axis, decimal.
V	: Incremental coordinate in Y-axis, decimal.
W	: Incremental coordinate in Z-axis, decimal.
X	: Absolute coordinate in X-axis, decimal.
Y	: Absolute coordinate in Y-axis, decimal.
Z	: Absolute coordinate in Z-axis, decimal.

In program making, each single block has fixed format. Program designing must follow the format. If the format is wrong, the system will not accept. Otherwise, it will cause a great error.

Each serial number of program represents a block. Although it is not necessary to use it, it is recommended to utilize the serial numbers for program searching. Mill has a special function "Auto-N" to automatically generate the number for you during or after program editing (see chapter 6). The program execution starts from top to bottom block and has nothing to do with the order of block sequence number.

Example: N10.....(1) program execution order

- N30.....(2)
- N20.....(3)
- N50.....(4)
- N40.....(5)

2.2.4 Coordinate System

The machining action of a cutting tool is accomplished when the tool is moving along a specific path from point A to point B, which represents the shape or the contour of a machine part. In order for the tool to follow the specific path, a computer program describing the shape of the machine part must be created and the shape or the contour is described by the Cartesian coordinate system.

1. Cartesian Coordinate System

H4D-M uses the customarily 2-D/3-D Cartesian coordinate system as shown in Fig 2-16, with Z-axis being the center of and parallel to the spindle axis and defined as $x=0$. The other axis is X-axis and $Z=0$ can be anywhere along the Z-axis at some convenient location for coordinate calculation. The intersecting point of the two axis is the origin, $X=0, Z=0$. Depending on the location of the cutting tool with respect to the spindle axis, the sign convention of the coordinate system is shown in Fig.2-15

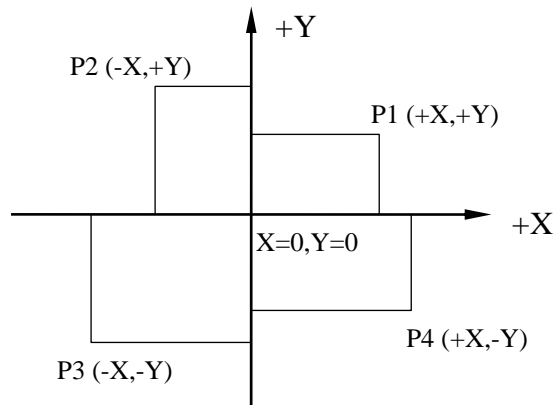

Fig 2-15 Cartesian Coordinate System of CNC Mill

Fig 2-16 is 3-D system (right-hand rule) with the intersecting point designated as origin $X=Y=Z=0$. The direction of normal rotation for each axis is indicated by the direction of the four fingers when you grab the axis by the right hand with your thumb pointing to the (+) direction of that axis.

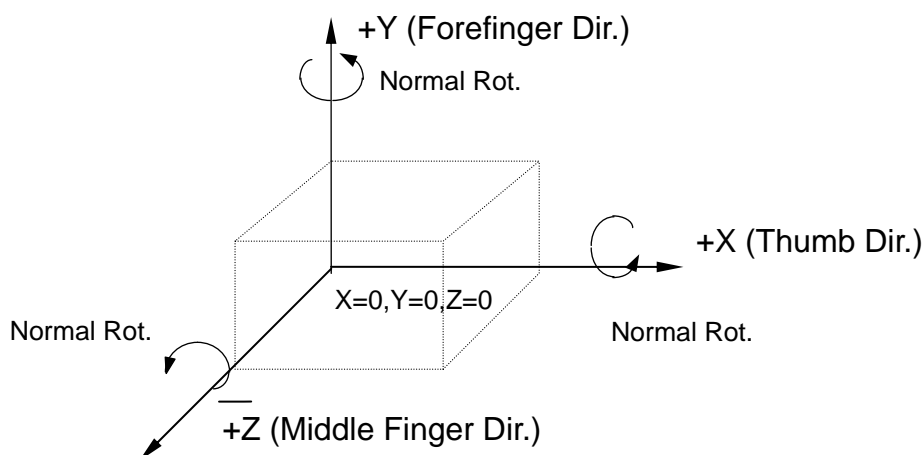

Fig.2-16

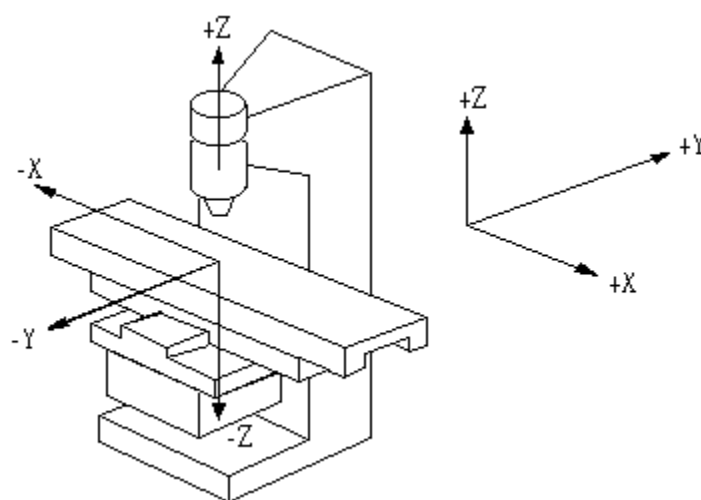

Fig 2-16-1

2. Coordinate of Tool Position Command (Coordinate)

The instruction for tool position command in H4D-M series can be in either absolute coordinate or incremental coordinate as follows:

X, Y, Z : Absolute coordinate command. The cutting tool moves to the position specified by the absolute coordinate X, Y, Z.

U, V, W : Incremental coordinate command. The cutting tool moves to the position with an incremental amount specified by U, V, W.

3. Absolute Coordinate

The origin is the reference. The coordinates of all points describing the shape of the work-piece (machine part) are calculated from the origin. The coordinates can be positive (+) or negative (-), depending on its relative position with respect to the origin.

4. Incremental Coordinate

The coordinates of all points describing the shape of the work-piece (machine part) are calculated from the end point of the previous block. They are the amount of coordinate increase from the last point. The incremental coordinates can be either positive (+) or negative (-), depending on its relative position with respect to the end point of the previous block. They are positive (+) if the cutting tool is going in the direction of U, V, W increment, negative (-), otherwise is in the direction of U, V, W decrement.

X, Y, Z, U, V, W can be mixed in the program. The methods are described below:

Absolute Command:

```

N10 G00 X0.000 Y0.000 ..... Position to work origin
N20 G90 ..... Set program to absolute value
N30 G1 X12.000 Y12.000 F300.00 ..... P0 to P1
N40 X26.000 Y16.000 ..... P0 to P2
N50 X38.000 Y30.000 ..... P2 to P3
N60 M2 ..... Program end
    
```

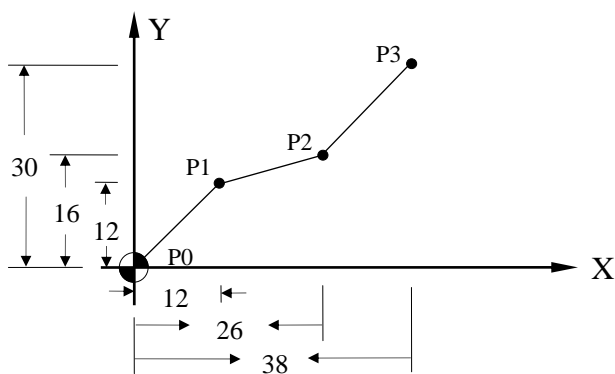

Fig.2-17 Absolute Command

Increment Command:

```

N10 G00 X0.000 Y0.000 ..... Position to work origin
N20 G91 ..... Set program to increment value
N30 G1 X12.000 Y12.000 F300.00 ..... P0 to P1
N40 X14.000 Y4.000 ..... P0 to P2
N50 X12.000 Y14.000 ..... P2 to P3
N60 M2 ..... Program end
    
```

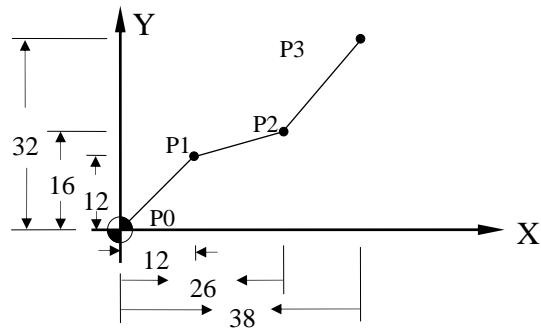

Fig.2-18 Increment Command

Please note that the command G91 sets the X, Y, Z-coordinate as incremental values and the U, V, W will be rendered ineffective with G91. The increment command U, V, W can only be rendered effective with G90.

The power-on setting of H4D-M series is in absolute mode, the above program can be re-written as:

```

N10 G00 X0.000 Y0.000 ..... Position to work origin
N20 G1 U12.000 V12.000 F300.00 ..... P0 to P1
N30 U14.000 V4.000 ..... P1 to P2
N40 U12.000 V14.000 ..... P2 to P3
N60 M2 ..... Program end

```

Mixed Usage:

```

N10 G00 X0.000 Y0.000 ..... Position to work origin
N30 G1 U12.000 V12.000 F300.00 ..... P0 to P1
N40 U26.000 V4.000 ..... P1 to P2
N50 U38.000 V14.000 ..... P2 to P3
N60 M2 ..... Program end

```

Or

```

N10 G00 X0.000 Y0.000 ..... Position to work origin
N30 G1 U12.000 V12.000 F300.00 ..... P0 to P1
N40 U14.000 V16.000 ..... P1 to P2
N50 U12.000 V30.000 ..... P2 to P3
N60 M2 ..... Program end

```

In the absolute coordinate, the calculation error of one point will not affect the positioning of next point. In the incremental coordinate, however, an error of a point will affect the positioning of all subsequent points. There isn't any rule as to when to use the incremental or the absolute coordinate. If the each point and home are related, it is better to adopt absolute coordinate.

In the command of diagonal or circular movement, it is better to notice the matter of errors in the increment system under the result of trigonometry in each axis value. Basically, we could follow the analysis of part sizes and the need of program design to adopt absolute or increment coordinate.

5. Work Origin/Work Coordinate

The work origin is the coordinate origin as described before. It is also called the program origin. This is the reference point for all coordinate calculations and the coordinate so obtained is called work coordinate. The selection of work origin location needs to be determined by program designers. It can be any point on the table of Mill or tool chucks. Using the coordinate of the part diagram is easier to read.

6. Machine Origin

The machine origin is the HOME location for the cutting tool. This is the reference point for the coordinate determination of the work origin and the tool offset compensation. The coordinate obtained using the machine origin as calculation base is called the machine coordinate.

The exact location of the machine origin is determined by the location of the home limit switch on each axis. When user executes X, Y , Z Home on a Mill CNC controller, the cutting tool will move to the machine origin. The exact distances between the machine origin and the work origin must be accurately measured using a fine instrument, such as a linear scale. Otherwise, the completed part will be in an error.

When the electric power is interrupted for any reasons, execute HOME on each axis before resuming any cutting.

2.2.5 Control Range

The minimum/maximum programmable range for Mill CNC controller is as follows. Please note that the control range may be limited by the working range of user's machine.

	Metric, mm
Min. setting unit	0.001
Max. setting unit	8000.000
Min. moving unit	0.001
Max. moving unit	8000.000
Min. Time	0.1
Max. Time	8000.000

	Metric Unit / English Unit
G-code	G00~G99 (G01=G1)
M-code	M00~M999 (M01=M1)
S-code	S1~S9999 rpm
F-code	0.01~8000.00mm/spin
X, Z, U, W, I, K, R	0.001~+/- 8000.000 mm
R (Radius)	0.001~+/- 4000.000 mm
G04	0~8000.000 seconds
Memory capacity	320 K
Lead screw compensation	0~255 pulses (related to tool resolution)
Max. Response Speed	500 KPPS

2.3 Program Editing

The following topics will be discussed in this section.

1. Select a program for editing.
2. Edit a new program.
3. Revise an existing program.

2.3.1 Program Selection

H4D-M controller can store a maximum of 999 programs with number O0~O999. You can select any one of the programs for editing or execution. The program selection process is described as follow.

Press 『EDIT/PRNO』 key twice in 0.5 seconds to enter PRNO mode, move the cursor to the desired program and press the input key. The LCD display is shown as

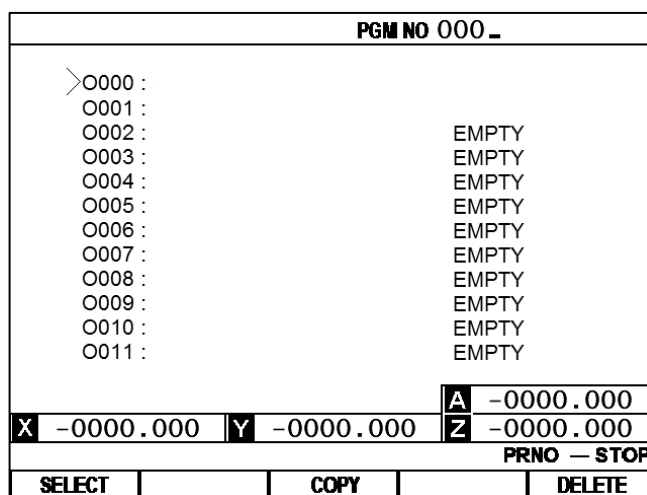

Fig.2-20

Under PRNO mode, the program note can be entered up to 12 different letters and numbers.

Example: If you put the note “TYPE-201” after 001, the instruction is as follows.

1. Move the cursor to 0001
2. Enter the letters and numbers as T Y P E 2 - 0 1
3. Press input

2.3.2 New Program Edition

When a new program has been selected, press EDIT key to be in editing mode. The LCD screen will be blank with cursor pointing at the first line to be entered as in Fig.2-21.

PGM NO 000 _				
M03S3000				
M07				
T101				
G00X50.Z80.				
➔ G90X30.Z30.F0.2				
X25.				
X20.				
G00X100.Z100.				
M09				
X -0000.000		Y -0000.000		A -0000.000
				Z -0000.000
EDIT — STOP				
G81~G89	G22~G25	G34~G37	N-Search	⇒

Fig.2-21

During program editing, the following keys will be used.

1. Function keys.
2. Numeric keys, 0~9
3. CURSOR ← and CURSOR → keys for data inspection in the same block.
4. PAGE↑ and PAGE↓ keys for data inspection between lines.
5. NEW LINE key -- Establishing or inserting a new block anywhere in the program.
Key in a function code, then press NEW LINE to establish a new line.
6. INPUT -- For entering a data or a function in the established block.
Key in a function code, then use INPUT to enter more data into the established line.
7. DEL -- For deleting a block (line) of program.

You can edit a program with or without block number. Following is an **example program** to explain the keystrokes required to edit a new program in the controller.

Ex: Program 1
 N10 G0 X0. Y0.
 N20 G4 X1.
 N30 G0 U480. V-480.
 N40 G4 X1
 N50 M99

Keystrokes: (Ignore the sign "-" below. It's there for clarity)

1. Please confirm the edit status and press Edit key to enter in the controller.

N1 G0 X0. Y0.

2. Enter first block information G – 0 – NEW LINE

It is a new establishing block. Thus, users need to enter NEW LINE key.
After this step, the LCD screen is shown as Fig 2-22.

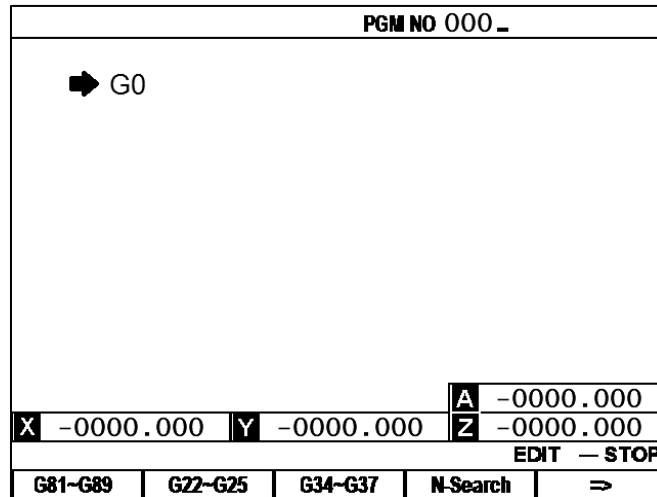

Fig.2-22

And enter:

X 0 • INPUT

Y 0 • INPUT

Key-strokes for the remaining blocks are as follows.

2. N20 G4 X1.

(A) G - 4 - NEW LINE

(B) X - 1 - • - INPUT

3. N30 G0 U480. W-480.

(A) G - 0 - NEW LINE

(B) U - 4 - 8 - 0 - • - INPUT

V- "-" 4 - 8 - 0 - • -INPUT

(The negative sign "-" here can be input anywhere before pressing INPUT key)

4. N40 G4 X1.

(A) G - 4 - NEW LINE

(B) X - 1 - • - INPUT

5. N50 M99

(A) M - 99 - NEW LINE

During program editing, you can use CURSOR ←, CURSOR → key to check the input data within the block. Use PAGE↑, PAGE↓ to move up and down the block (line). When you finish editing the entire program, press RESET key to exit.

2.3.3 Old Program Revision

Let's use Program O001 of previous section as our example for program revision.

Revise or Add a Function

To revise or add a function, simply key in the function code and the correct number, then press INPUT key.

Ex: Revise N3 U480. V-480.
To N3 U480. V-480. F300

1. Make sure the system in EDIT mode.
2. Use PAGE↑, PAGE↓ key to move cursor to N3 block.
3. Add a function of F300 by entering data below and LCD will display as in

PGM NO 000 _				
N1 X0. Y0. Z0.				
N220				
➡ N3 U480. V-480. F300				
N4 Z15				
			A	-0000.000
X	-0000.000	Y	-0000.000	Z -0000.000
EDIT - STOP				
G81~G89	G22~G25	G34~G37	N-Search	⇒

Fig 2-23

- F- 3 0 0 - INPUT
4. Revise U480. to U360. by keying in
U - 3 - 6 - 0 - • - INPUT

Delete a Function

To delete a function, simply key in the function to be deleted without number, then press INPUT key.

Ex: Revise N30 U480. V-480. F300
 To N30 U480. V-480.

1. Make sure the system in EDIT mode.
2. Use PAGE↑, PAGE↓ key to move cursor to N3 block.
3. Key "F" without numbers and press INPUT key, LCD displays as Fig 2-24.

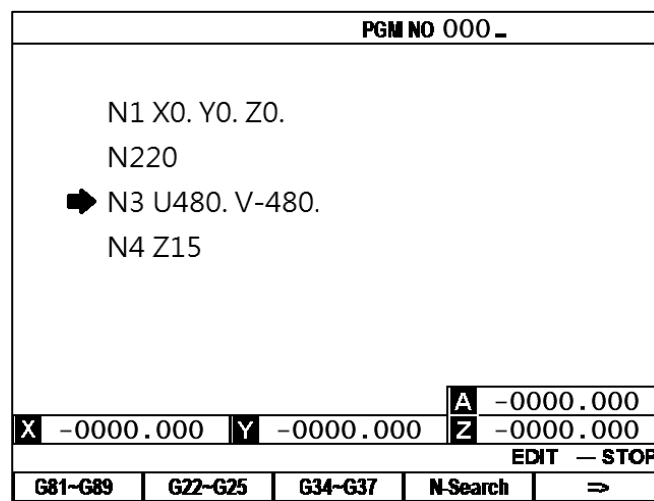

Fig.2-24

Insert a Program Block

To insert a program block, key in the block number (or any function) and use NEW LINE key to establish the block. Then use INPUT key to input the rest of data for the block.

Ex: Insert N31 U20. V-20.
 between N3 G0 U480. V-480. and
 N4Z15

1. Make sure the system in EDIT mode.
2. Use PAGE↑, PAGE↓ key to move cursor to N30 block.
3. Enter
 N 3 1 new line
 U 2 0 . input

V- 2 0 . input

The LCD display is shown as Fig.2-25.

PGM NO 000 _				
N1 X0. Y0. Z0.				
N220				
➡ N3 U480. V-480. F3000				
N31 U20. V-20.				
N4 Z15.				
N02				
			A	-0000.000
X	-0000.000	Y	-0000.000	Z -0000.000
EDIT — STOP				
G81~G89	G22~G25	G34~G37	N-Search	⇒

Fig.2-25

Delete a Program Block

To delete a block, use PAGE↑, PAGE↓ key to move cursor to the block that you want to delete and press DEL key. For example: Delete N31 U480 V-480. from last example.

1. Make sure the system in EDIT mode.
2. Use PAGE↑, PAGE↓ key to move cursor to N31 block.
3. Press DEL key and the LCD display is as shown in Fig 2-26 (Block N4)

PGM NO 000 _				
N1 X0. Y0. Z0.				
N220				
➡ N4 Z15.				
N02				
			A	-0000.000
X	-0000.000	Y	-0000.000	Z -0000.000
EDIT — STOP				
G81~G89	G22~G25	G34~G37	N-Search	⇒

Fig.2-26

2.3.4 Delete a Program

Move the cursor to the program that you want to delete it in PRNO mode and press DEL. The LCD display is shown as Fig.2-27

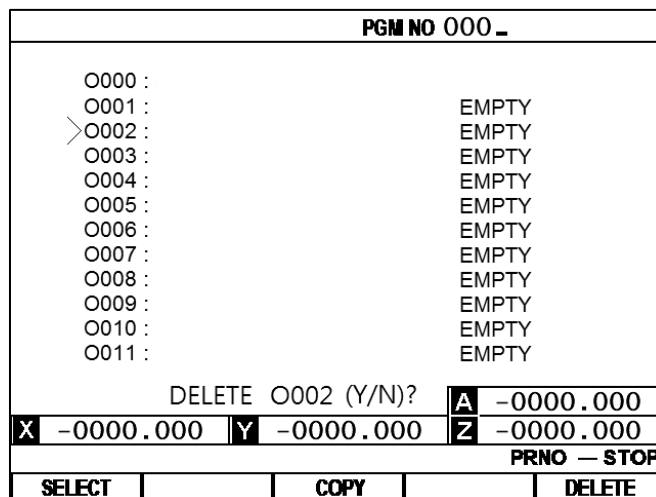

Fig.2-27

In the meantime, press Y and clear the content of the 002 program. The key N remains the same.

If you want to delete all programs- 0~999, follow the procedures below:

Enter MDI mode, and give G10 P2001 command.

Then all the content of the program are cleared immediately.

Note: After completing the procedure, all the program data in memory will be vanished. Therefore, do not use this program if it is not necessary.

2.3.5 Decimal Points Entering

Numerical input has two formats such as integer and decimal with a maximum of 7 digits. If you input the numbers in accordance with the format required by the controller, the number will be entered correctly. You cannot enter a decimal point for a number that requires an integer format. So, the only occasion that may cause error input is the one that you enter an integer for a decimal format. Described more in detail below.

The decimal input such as X, Y, I, J is left blank, the content of the controller will automatically move back to the decimal points of last format with dot at front.

The table below shows the decimal numbers recognized by the controller after internal process for some integer inputs.

Input	4/3 Format
X2	X0.002 mm
Y250	Y0.0250mm
Z35	Z0.035mm
U2500	U0.500 mm
V25	V25.0000mm
W125.	W125.000mm
F300	F0.3 mm/min

The numerical formats for the function codes used in Lathe system are listed below. To avoid any potential error, please use the specified format as follow when key in data. The number "0" after decimal point can be omitted.

G, M, N, S-code: Variables	Integer input
X, Y, Z, U, V, W, I, J-code	Decimal input
F-code	Integer input

Note: TO avoid the confusion, apart from integer inputs such G, M, N, S, the rest of the inputs should be entered by decimal points. The number "0" after decimal point can be omitted.

2.3.6 Notes For Edition

Program Block Number

1. Block number N can be omitted, but it's better to have it for the convenience of program inspection later.
2. Block number N is recognized by the editing order not by the block sequence or its value. The numbers by the letter N are merely symbols. For instance, inserting block N35 in Block N30. It will become the following result.

Program 1

N10 G0 X0 Y0	first block
N20 G4 X1	second block
N30 U480 V-480	third block
N35 U20 V-20	fourth block
N40 G4 X1	fifth block
N50 M99	sixth block

If block N35 is changed to block N350, the arrangement of program execution remains the same.

3. Block number is recognized by the number of characters, not by its value. Therefore, N10, N010, N0010 are three different block number.

Program Block

1. Do not use two G-codes in the same block. If more than one G-code exists in a block, only the last one is effective.
2. Do not repeat any position code in the same block. The position codes are X, Y, Z, U, V, I W, J and R.
3. If you specify absolute coordinate and incremental coordinate for the same axis in a block, only the incremental coordinate will be executed.
Example: G1 X100. U50. -- U50 will be executed.
4. Do not exceed 80 bytes of data input for a single block. Otherwise, the CNC controller will show an error message Err-18 at the bottom of the screen.

2.3.7 Circular Entering

There are three functions on the Edit Screen. These are single drilling, grooving and canned cycle.

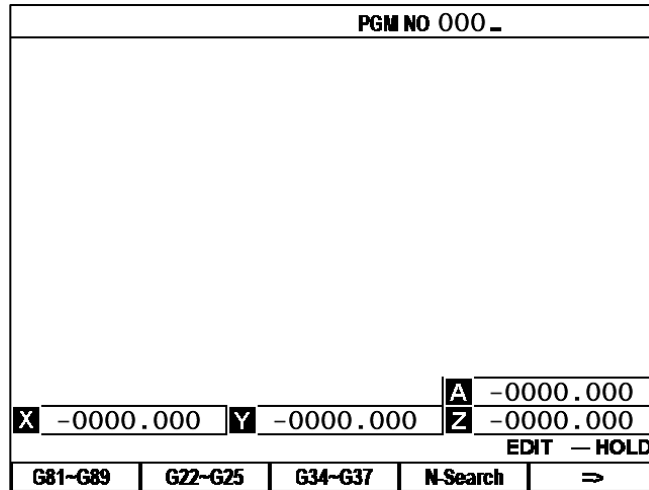

Fig.2-28

2.3.7.1 Single Drilling

After selecting single drilling, the next screen display shows below:

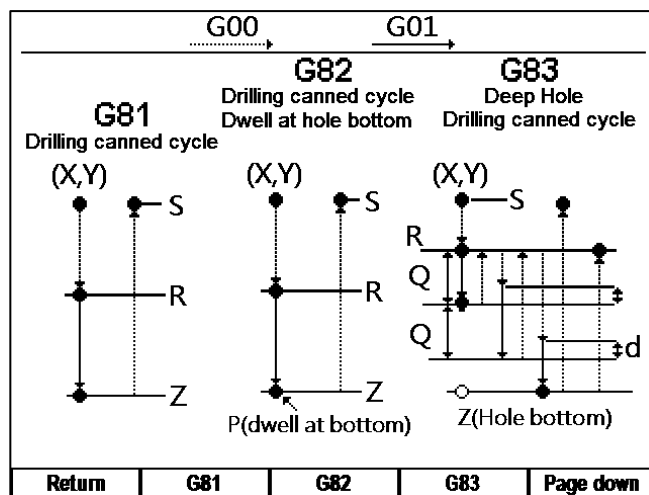

Fig.2-29

Follow the direction of the figure and choose the required function to enter (G81, G83, G85, G86, G89). For example: choose G81 to enter the display below:

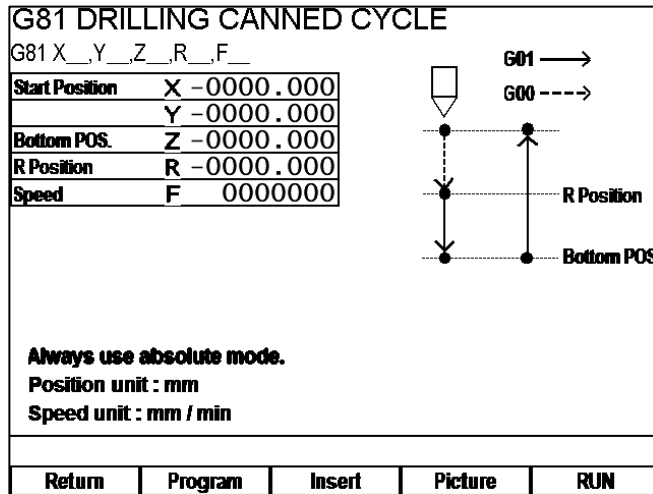

Fig.2-30

And enter the required input value from the format. After the confirmation, and press < Program Newline >. The controller can automatically create a new program from new format values. Use the key “ Program Check” to review the information and check whether there is a program being created.

If the user needs to execute the drilling function directly, press “Direct Execution” key for 3 seconds, it will switch to the auto mode and execute this single step (Non Edit Program). After the execution, it will switch back to the display again. The figure on the right is a brief format. The user can follow the figure and enter parameters.

Please check the G-functions and descriptions in the format.

2.3.7.2 Grooving

After selecting the function, display shows below:

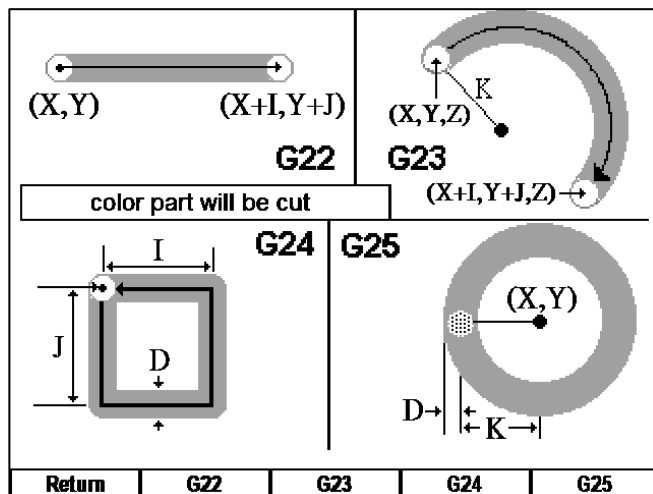

Fig.2-31

Follow the direction of the figure and choose the required functions. For example: choose the circular grooving to enter the display below:

G25 CIRCULAR GROOVING	
G25 X__Y__Z__R__K__D__T__F__	
Start POS.	X -0000.000
	Y -0000.000
Bottom POS.	Z -0000.000
R Position	R -0000.000
Arc Radius	K -0000.000
Tool Radius	D 0000.000
Cutting type	T 0000000
Speed	F 0000000
<p>Always use absolute mode. Position unit : mm Speed unit : mm / min</p>	
Return	Program
Insert	Picture
RUN	

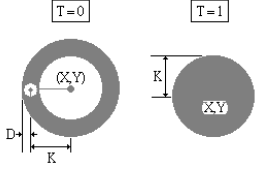

Fig.2-32

And enter the required input value from the format. After the confirmation, and press < Program Newline >. The controller can automatically create a new program from new format values. Use the key “ Program Check” to review the information and check whether there is a program being created.

If the user needs to execute the drilling function directly, press “Direct Execution” key for 3 seconds, it will switch to the auto mode and execute this single step (Non Edit Program). After the execution, it will switch back to the display again.

The figure on the right is a brief format. The user can follow the figure and enter parameters.

Please check the G-functions and descriptions in the format.

2.3.7.3 Canned Cycle

After selecting < canned cycle>, the display shows below:

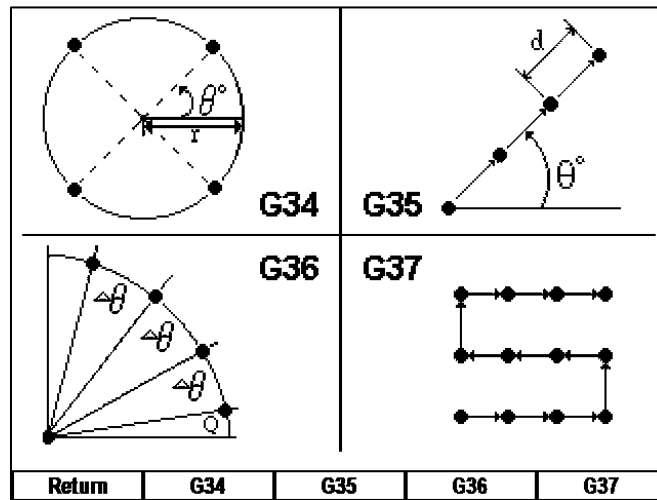

Fig.2-33

Following the direction of the diagram and choose the required function. For example: choose the grid of canned cycle to enter the display below:

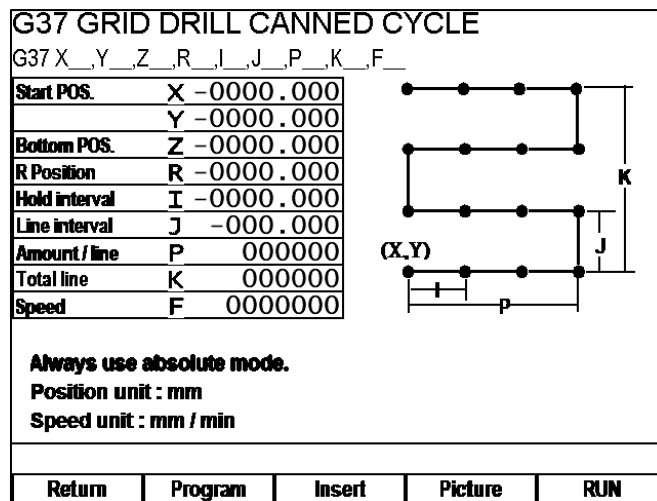

Fig.2-34

And enter the required input value from the format. After the confirmation, and press < Program Newline >. The controller can automatically create a new program from new format values. Use the key “ Program Check” to review the information and check whether there is a program being created.

If the user needs to execute the drilling function directly, press “Direct Execution” key for 3 seconds, it will switch to the auto mode and execute this single step (Non Edit Program). After the execution, it will switch back to the display again.

The figure on the right is a brief format. The user can follow the figure and enter parameters.

Please check the G-functions and descriptions in the format.

2.3.7.4 Program Edit by TEACH mode

Occasionally during program editing, it's difficult to obtain the X or Y coordinate. One easy way to solve this problem is to use the TEACH function in HUST H4D-M controller. When the system is in TEACH mode, you can use MPG hand-wheel to move the tool to the desired location.

Then press  key to transfer the coordinates to the program. TEACH function is similar with EDIT except that you use MPG hand-wheel to find the coordinates in TEACH mode. Therefore, all the keys used in EDIT mode as discussed in last section are also used for editing program in TEACH mode.



When use TEACH function for a large and long work-piece, it's more convenient to make a hand-carry type TEACH box that contains a MPG

hand-wheel, , , and  keys.

(Please refer to Chapter 6 of HUST H4D-M Connecting Manual)

Note that every time the  key is pressed, the current tool coordinate will be transferred into the program when in TEACH mode. If TEACH function will be required for part of your program, it's advisable to do your entire program in TEACH mode to avoid confusions or mistakes. Followings are steps to edit (or revise) a program in TEACH mode.

1. Press  key twice in 0.5 seconds to get in TEACH mode.

2. Enter relevant commands in both  and  keys.

3. Use MPG hand wheel to move to the desired location and press  key.

Use CURSOR↑, CURSOR↓ key to select X-axis for input. Use MPG hand-wheel to move tool to the desired X-axis location. Then press INPUT key. Repeat this step for Y-axis if desired. Use PAGE↓ to display the current tool coordinate on LCD screen.

4. Repeat Steps 2~3 to complete the whole program. Finish the program with M02, M30 or M99 function.

EX: G01 X100.000 (100.000 use MPG hand-wheel input coordinate)
M02

1. Enter Teach mode

2. Enter    

3. Move the tool to the location 100.000 coordinate by using MPG hand-wheel and press the  key.

4. Enter    

3 Programming and Command Code

3.1 Types of Command Codes

This chapter definitely describes the command codes of H4D-M series and provides simple examples for each command to explain its applications.

The definition of G-codes in the H4D-M series is similar to other controllers. They are classified into two groups: (Table 3-1).

3.1.1 One Shot G-code

A One-shot G-code (has no * mark in the table) is valid only in the specified program block.

Ex: N10 G0 X30.000 Y40.000 . . . G0 is Modal G-code
 N20 G4 X2.000 . . . G4 is a one-shot G-code and only valid
 in this block.
 N30 X20.000 Y50.000 . . . No G-code specified; G0 code of the
 N10 block is valid here.

3.1.2 Modal G-code

A Modal G-code (has a * mark in the table) is valid until it is replaced by another G-code of the same group.

G00, G01, G02, G03 Same group

G17, G18, G19 Same group

G40, G41, G42 same group. G43, G44, G49 same group.

G54, G59 Same group

G80, G89 Same group G90, G91 Same group

G98, G99 Same group

Ex: N10 G0 X30.000 Y5.000 . . . G0 is specified.
 N20 X50.000 Z10.000 . . . No G-code specified, G0 remains valid.
 N30 Y20.000 . . . No G-code specified, G0 remains valid.
 N30 G1 X30.000 F200 . . . G1 replaces G0 and becomes valid,

The G-codes of H4D-M controller are listed in Table 3-1. Only one G-code of the same group can be set for one program block. If more than one G-code is set, only the last G-code is valid.

Table 3-1 H4D-M Code Definitions

G-code List	
G- code	Function
* 00	Fast positioning (fast feeding)
* 01 #	Linear cutting (cutting feeding)
* 02	Arc cutting, CW
* 03	Arc cutting, CCW
04	Dwell command (the interval is determined by X-axis)
08	Clear the machine coordinate of each axis
09	Exact Stop Check
10	MCM data input
15	Servo spindle positioning
16	Cylindrical Plane
* 17	Thread cutting, X-Y
* 18	Thread cutting, Z-X
* 19	Thread cutting, Y-Z
* 20	Measurement in INCH mode
* 21	Measurement in METRIC mode
22 \$	Linear grooving
23 \$	Arc grooving
24 \$	Rectangular grooving
25 \$	Circular grooving
28	Tool moves to the 1st reference point
29	Return to the previous position from the ref. point
30	Tool moves to the 2nd reference point (a total of 10 groups)
31	%Skip function
34 \$	Circular drilling canned cycle
35 \$	Angular linear drilling canned cycle
36 \$	Arc drilling canned cycle
37 \$	Grid drilling canned cycle
38 \$	Coordinates rotation function
39 \$	Coordinates rotation function cancellation
* 40 #	Tool radius compensation cancellation
* 41	Tool radius compensation setting (left)
* 42	Tool radius compensation setting (right)

G-code List	
* 43	Tool length compensation (+) direction
* 44	Tool length compensation (-) direction
* 49	Tool length compensation cancellation
* 52	Local Coordinate System Setting
53	Basic machine coordinate system
* 54 #	First work coordinates
* 55	Second work coordinates
* 56	Third work coordinates
* 57	Fourth work coordinates
* 58	Fifth work coordinates
* 59	Sixth work coordinates
61	Enable Precision Positioning mode
62	Disable Precision Positioning mode
* 68	X-axis mirror-effect cutting
* 69	Y-axis mirror-effect cutting
* 80 \$	Drilling canned cycle cancellation
* 81 \$	Drilling canned cycle setting
* 82 \$	Drilling canned cycle (dwell at bottom)
* 83 \$	Deep hole drilling canned cycle
* 84 \$	Tap Cutting canned cycle
* 85 \$	Boring canned cycle
* 86 \$	Boring canned cycle (spindle stop at hole bottom)
* 89 \$	Boring canned cycle with dwell at hole bottom)
* 90	Absolute coordinate command
* 91	Incremental coordinate command
* 93	Inverse time feed mode
* 94	Feed-rate specified by mm/min
* 95 #	Feed-rate specified by mm/revolution
* 98	Feed-rate per minute
* 99	Feed-rate per revolution
·	* -- Modal G-codes
·	# -- Default settings upon power-on of the controller
·	\$ -- Special functions of H4D-M Series.
·	% -- Optional functions

3.2 Fast Positioning, G00

Format:

G00 X(U)____Y(V)____Z(W)____ A____ B____ C____

X, Y, Z . A . B . C : Positioned end point in absolute coordinate.

U,V, W : Positioned end point in incremental coordinates relative to the block starting point.

G00 (or G0) is used to instruct the tool to move to the specified end point of a program block at the maximum speed of MCM #221(X-axis)~#225(B-axis). The start point is the position at which the tool is located before it moves. This command can control the movement of 1~5 axes simultaneously. The axis that is not set by the command does not execute any movement.

The path of the tool movement is straight. Where the distance of movement is different among axes, the controller selects the axis that has the longest movement distance for fast positioning. The feed-rate of other axes is determined based on their movement distance and the components of the axis with the longest movement distance. If the calculated speed of any axis exceeds the MCM setting value, the controller will re-calculate the feed-rate of other axes based on the feed-rate of the overrun axis.

Ex: Fig 3-1 S point moves to E point rapidly.

G90

G00 X100.000 Y50.000 Z20.000

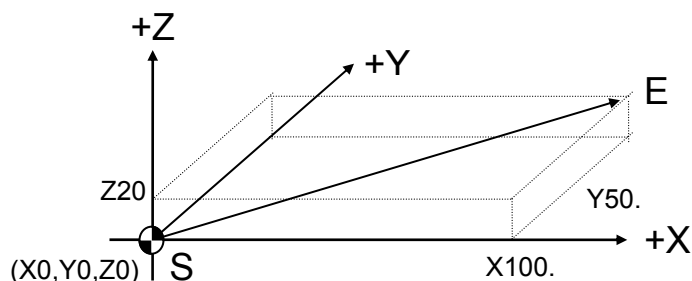

Fig 3-1 G00 Programming Example

The distances to move are 100.000 (X-axis), 50.000 (Y-axis), and 20.000

(Z-axis). Since the movement distance of each axis is different, the controller selects the axis with the longest movement distance for fast positioning at the speed set in MCM #79. Assume that the speed of MCM #221 is set to 10000 mm/minute, the movement speed of each axis in the above figure is :

X-axis – Movement distance 100.000mm. Since X-axis moves farthest, the controller specifies 10000 of MCM #221 as the feed-rate of the X-axis.

Y-axis – Movement distance 50.000mm. It is divided by the distance of the longest movement distance 100.000mm and multiplied by the highest feed-rate 10000 of MCM #222 to acquire 5000 (i.e. $50.000/100.000*10000=5000$)

The actual feed-rate of Y-axis is 5000 mm/min

Z-axis – Movement distance 20.000mm. It is divided by the longest movement distance 100.000mm and multiplied by the highest feed-rate 10000 of MCM #223 to acquire 2000 (i.e. $20.000/100.000*10000 = 2000$)

The actual feed-rate of Z-axis is 2000 mm/min.

3.3 Linear Cutting · G01

Format:

G01 X(U)____Y(V)____Z(W)____A____ B____ C____F____

X,Y,Z,A,B,C : End point in absolute coordinates

U,V,W : End point in incremental coordinates relative to the start point of the program block.

F : Cutting feed-rate (F-code can be used in combination with any G-code)

The F-code can be used in the G00 block without affecting the fast positioning movement.

G01 (or G1) is used for linear cutting work. It can control the 1~5 axes simultaneously. The cutting speed is determined by the F-code. The smallest setting value of the F-code is 1 mm/min.

The starting point is the coordinate of the tool when the command is given. The feed-rate specified after an F-code (Modal code) remains valid until it is replaced

by a new feed-rate.

After the feed-rate (F-code) is determined, the cutting feed-rate of X, Y, Z, A and B axis is calculated as follows:

(U, V, and W are actual incremental values.)

$$\text{X feed-rate, } F_x = \frac{U}{\sqrt{U^2 + V^2 + W^2}} * F \quad (1)$$

$$\text{Y feed-rate, } F_y = \frac{V}{\sqrt{U^2 + V^2 + W^2}} * F \quad (2)$$

$$\text{Z feed-rate, } F_z = \frac{W}{\sqrt{U^2 + V^2 + W^2}} * F \quad (3)$$

Three G01 programming examples are described below. These programs are different in settings but execute the same linear cutting work.

1. G90 absolute program (Fig 3-2)

```

N1 G90
N2 G01 X25.000 Y20.000 Z10.000 F100.00 ... P1
N3 X60.000 Y50.000 Z40.000 ... P2
            
```

2. G91 incremental program (Fig 3-2)

```

N1 G91
N2 G01 X25.000 Y20.000 Z10.000 F100.00 ... P1
N3 X35.000 Y30.000 Z30.000 ... P2
            
```

3. G90 increment program (Fig 3-2)

```

N1 G90
N2 G01 U25.000 V20.000 W10.000 F100.00 ... P1
N3 U35.000 V30.000 W30.000 ... P2
            
```

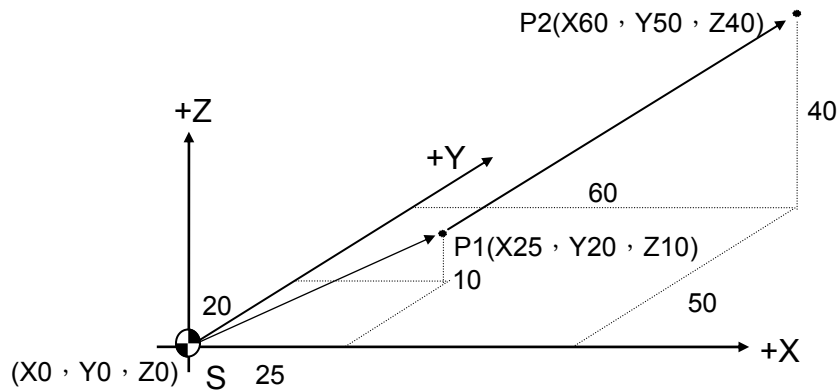

Fig 3-2 G01 Program Example

3.4 CNC ans Master / Slave mode

When the part program is running, every block has a feed-rate (F), including the G0 block. When a feeding command is given in the CNC mode, the motor starts accelerating to the specified feed-rate. It maintains this speed and decelerates to zero when the tool approaches to the positioning point. When a feeding command is given to the next block, the motor repeats the acceleration and deceleration actions. The speed of the motor is reset to zero between blocks.

Master/Slave mode— In the master/slave mode, an axis is selected as the master axis and the rest axes are automatically set to slave axes. The motor speed of the master and all slave axes remains at the feed-rate and is not reset between blocks. In case that two adjoining blocks have different feed-rates, the motors of the master and all slave axes perform the acceleration and deceleration actions and the motor speed is adjusted to the feed-rate of the next block without being reset to zero. If the feed-rate of the master axis is zero, the controller will select the feed-fate of the slave axes.

MCM #501 is used to set CNC and master/slave modes: 0 = CNC mode, 1 = master/slave mode with the X-axis as the master, 2 = master/slave mode with the Y-axis as the master, 3 = master/slave mode with the Z-axis as the master, 256 = No-dwell Mode. The CNC and Master/Slave modes are exemplified below.

CNC Mode: MCM #501 is set to 0

In the CNC mode, the speed of the motor decelerates to zero at the end point of each block. The acceleration/deceleration of the motor is determined by MCM #502.

Table 3-2

MCM parmeter	MCM parameter	G00 Acc/Dec	G01, G02 Acc/DeC
Parameter #501 = 0	Parameter #501 = 1	Liinar curve	Linear curve
Parameter #501 = 0	Parameter #501 = 2	"S" curve	"S" curve

Ex 1: Fig 3-3 shows the feed-rate adjustment between blocks when the G01 command is given in CNC mode. Acceleration/deceleration of the motor is executed in an exponential curve. The coordinates in this example are absolute coordinates.

```

N05 G00 X0. Y0. Z0.
N10 G01 X100. F1000.
N20 G01 X200. Y100. Z50. F500.
N30 G01 X300. F250.
N35 G01 X350. F100.
    
```

Explanation:

- N10 -- X-axis feed-rate F1000; Y-axis and Z-axis 0 feed-rate
- N20 -- Same X and Y increment (100) with the same F500 feed-rate; Z increment = 50 with F250 feed-rate
- N30 -- X feed-rate F250; Y and Z feed-rate 0
- N35 -- X feed-rate F100; Y and Z feed-rate 0

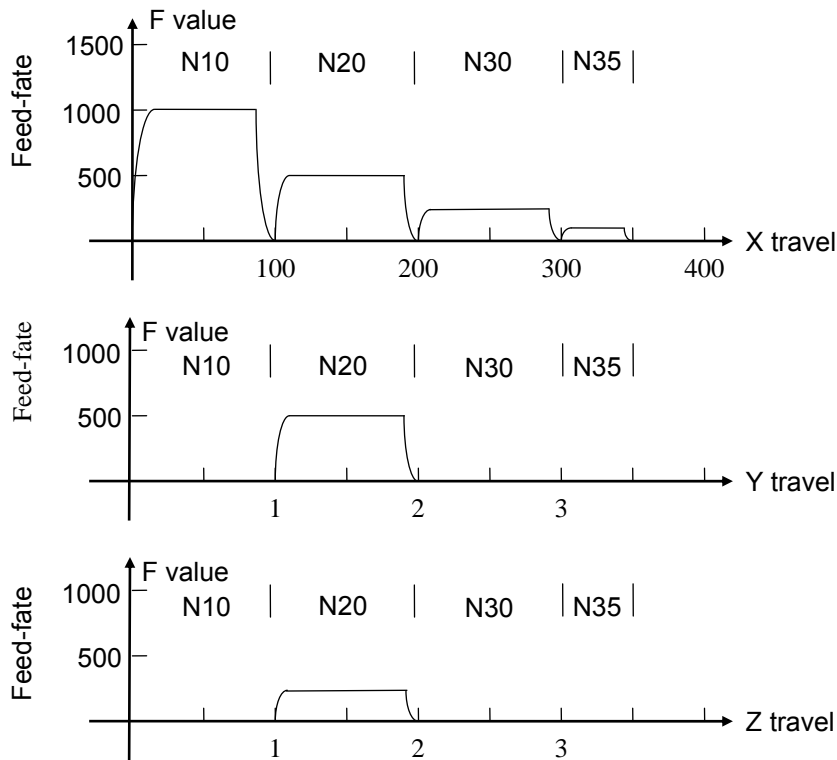

Fig 3-3 G01 CNC Mode with G01 exponential curve Acc/Dcc

Ex.2 and Ex.3 show how to calculate X and Y feed-rate in CNC mode using formulae (1) and (2). In the examples, assuming that the highest feed-rate set in G00 MCM #221~224 of G00 is:

TRX=2000 mm/min (X-axis), TRY=1000 mm/min (Y-axis)

EX2:G1 U100.0 V50.0 F1500

U.V composite vector = $(100^2 + 50^2)^{1/2} = 111.8$, so

X feed-rate, $F_x = (100/111.8) * 1500 = 1341.6$

Y-feed-rate, $F_y = (50/111.8) * 1500 = 670.8$

Both axes are within the G00 parameter and, thus, valid for feeding.

EX3:G1 X100.0 Y200.0 F2000

X.Y composite vector = $(100^2 + 200^2)^{1/2} = 223.6$, so

X-feed-rate, $F_x = 2000 * (100/223.6) = 894.4$

Y-feed rate, $F_y = 2000 * (200/223.6) = 1788.9$

Since $F_y > TRY(1000)$, the feed-rate is limited to:

$$F_x = (894.4/1788.9) * 1000 = 500 ,$$

$$F_y = (1788.9/1788.9) * 1000 = 1000$$

Master/Slave Mode: MCM #93 is not set to 0

If MCM #501 is set to 1 with the X-axis as the master and the other axes as slaves, the speed between blocks is not reset to 0 but adjusted to the feed-rate of the next block. The specified rate of a single block(F) is the feed-rate of the master axis. The controller adjusts the rate of the slave axes based on the rate of the master axis and MCM parameters. The example below demonstrates this relationship, assuming that the feed-rate does not exceed the G00 value. The acceleration/deceleration type of the motor is determined by MCM #502.

Table 3-3

MCM parameter	MCM parameter	G00 Acc/Dec	G01, G02 Acc/DeC
Parameter #501 = 0	Parameter #501 = 1	Linear curve	Linear curve
Parameter #501 = 0	Parameter #501 = 2	"S" curve	"S" curve

EX1: N10 G01 X100. F1000
 N20 X200. Y100. Z50. F500
 N30 X300. F250

X-master axis, Y, Z-slave axes. The feed-rate of each block depends on the master axis, The feed-rate of each slave axis (Y, Z) adjusts according to the incremental ratio of X/Y, X/Z. The motor accelerates or decelerates linearly. The acceleration/deceleration status between blocks is shown in Fig 3-4.

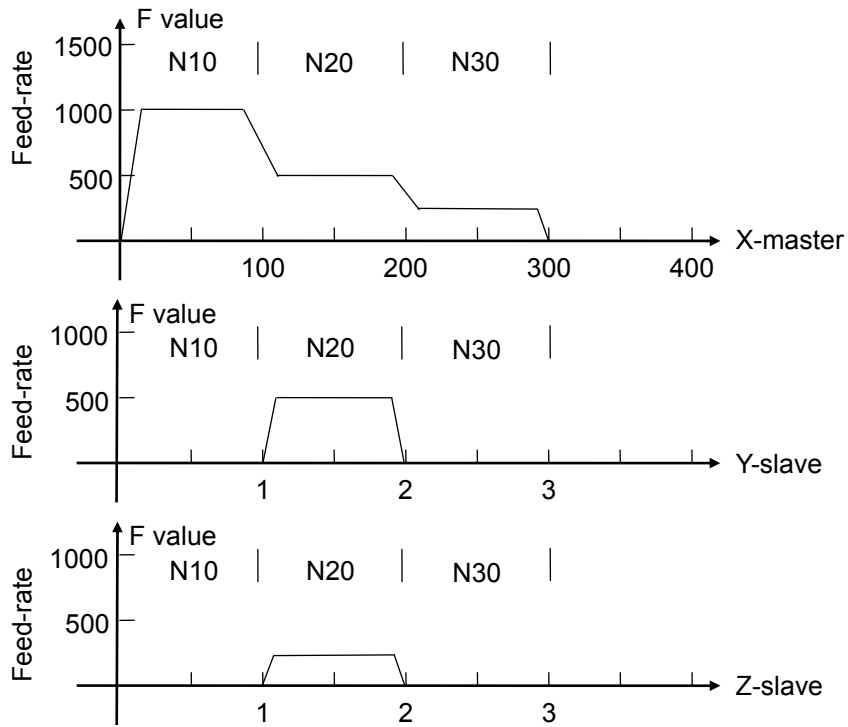

Fig 3-4 Master/Slave Mode-linear Acc/Dec

If the motor accelerates or decelerates in “S” curve, the acceleration/deceleration status between blocks is shown in Fig 3-4A:

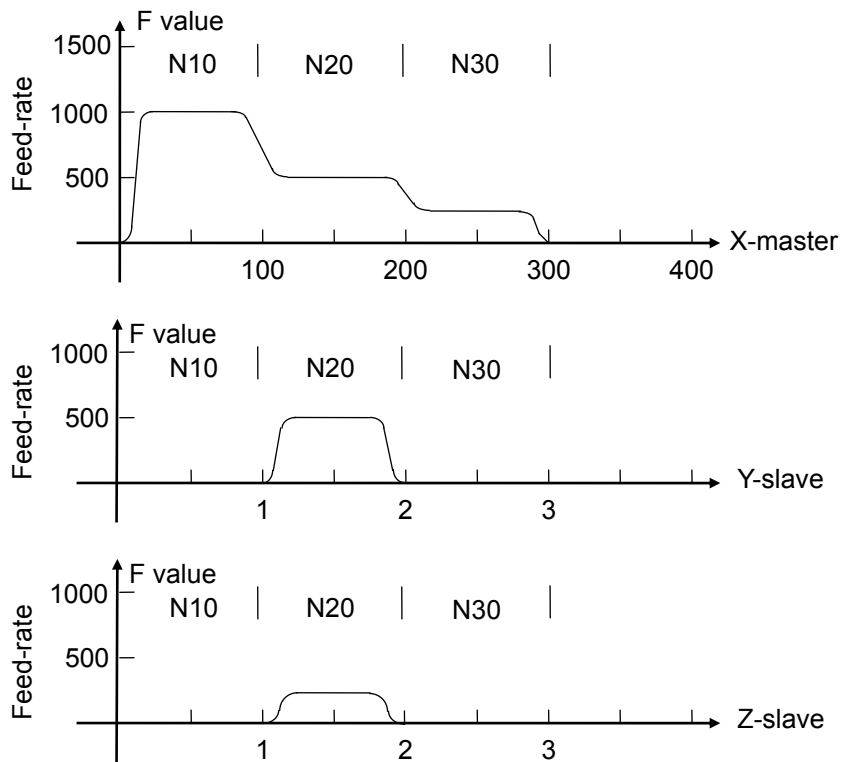

Fig 3-4A Master/ slave mode-S curve

Ex2: As shown in Fig 3-5, X is the master while Y and Z are the slaves. The feed-rate of the master axis (X) in each block doesn't change, but the feed-rate of the slave axes (Y, Z) changes along with the incremental slope ratio.

```
N10 G01 X100. Y50. Z0. F1000
N20 X200. Y75. Z50.
N30 X300. Y175. Z100.
```

In Example 2, the feed-rate of Y-slave changes along with the incremental slope rate of X, Y and is not reset to zero. Since both increments of the Z-axis are 50, the feed-rate remains the same. Note that there is a small interval between blocks during acceleration/deceleration. (Fig. 3-5)

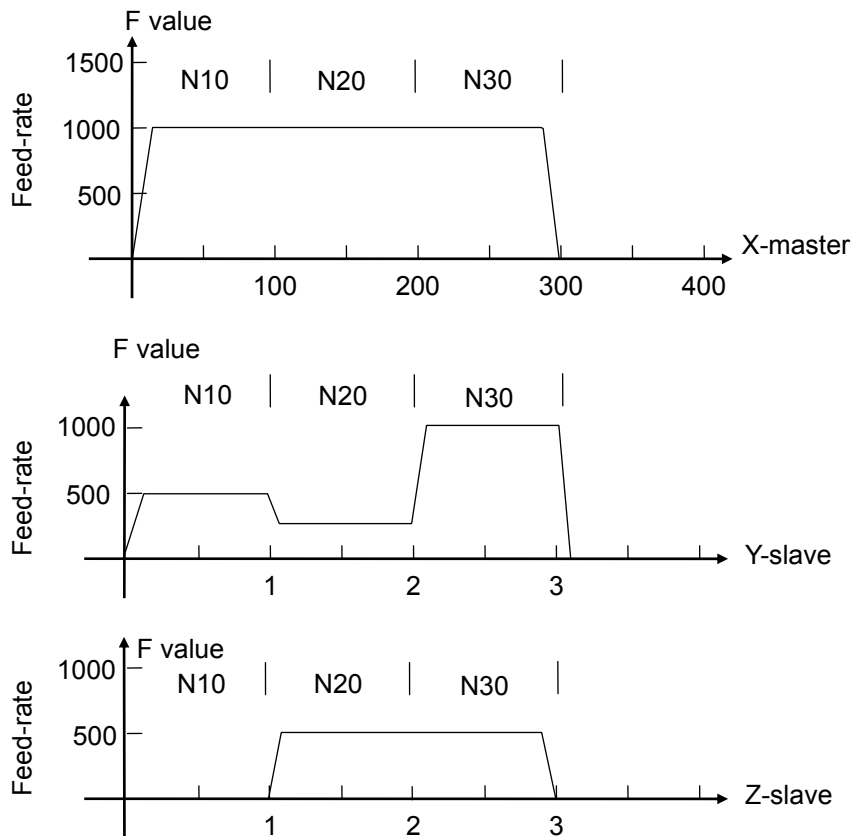

Fig 3-5 Mater/Slave mode – Master Speed unchanged

The examples below show how to calculate the feed-rate of the master and slave axes (assuming MCM 221(TRX) = 2000, MCM 222(TRY) = 4000 mm/min). The relationship between the feed-rate and the max. feed-rate setting (MCM #221 – 225) is taken into consideration during the calculation.

EX3:G0 U100.0 V50.0 (X-axis is the master; MCM #93 is set to 1)

Master feed-rate $F_x = 2000$

Slave feed-rate $F_y = (50/100) * 2000.00 = 1000$

$F_y < \text{TRY} (4000)$,

So, the feed-rate is determined by the TRX value of MCM#221 (X-axis).

EX4:G0 U100.0 V300.0 (X-axis as Master , MCM#501 = 1)

Master feed-rate $F_x = 2000$

Slave feed-rate $F_y = (300/100) * 2000 = 6000$

$F_y > \text{TRY} (4000)$, thus the speed is limited to:

Master feed-rate $F_x = (4000/6000) * 2000 = 1333.33$

Slave feed-rate $F_y = 4000$

The feed-rate is determined by the TRY value of MCM#222 (Y-axis).

3.5 Arc Cutting , G02 , G03

Table 3-4

G02, G03 Arc Cutting	
	Arc or Cycle
Radius	G17 G02(G03) X_Y_R_F_ (G17 P256 for X A Surface)
	G18 G02(G03) X_Z_R_F_ (G18 P256 for A Z Surface)
	G19 G02(G03) Y_Z_R_F_ (G19 P256 for A Y Surface)
Center	G17 G02(G03) X_Y_I_J_F_ (G17 P256 for X A Surface)
	G18 G02(G03) X_Z_I_K_F_ (G18 P256 for A Z Surface)
	G19 G02(G03) Y_Z_J_K_F_ (G19 P256 for A Y Surface)

Format:

G17 <----- power-on default

G02 (or G03) X____ Y____ I____ J____ F____ (1)

(R can replace I , J)

G17 P256

G02 (orG03) X____ A____ I____ J____ F____

(R can replace I , J)

G18

G02 (orG03) X____ Z____ I____ K____ F____ (2)

(R can replace I , K)

G18 P256

G02 (orG03) A____ Z____ I____ K____ F____

(R can replace I , K)

G19

G02 (orG03) Y____ Z____ J____ K____ F____ (3)

(R can replace J , K)

G19 P256

G02 (orG03) Y____ A____ J____ K____ F____

The three command groups control arc cutting on the X-Y (1), X-Z (2), Y-Z (3) plane. The dimension is controlled by G17, G18, and G19, and G17 is the default power-on dimension. When executing arc cutting in the X-Y dimension, G17 can be omitted. The function of G17, G18, and G19 will be described in the next sections. The format of these command groups is a special thread cutting (refer to the next sections) format. Arc cutting is then executed when the linear axis does not move during the thread cutting. Definitions of other commands are described below:

X(U), Y(V), X(W):

The end point coordinates of arc cutting. The start point is the coordinates of the tool when G02 or G03 execute.

I, J and K are the increment or decrement from the start point of the arc to the center of the circle. If the coordinates from the start point to the center of the circle are incremental, the value is positive. Otherwise, it is negative. The definition of this increment/decrement is the same as the incremental commands U, V, and W. All these commands can be replaced by the R command.

F: The feed-rate for arc cutting is determined by F-value. The minimum value

is 1mm/min

The path and the direction of the tool are determined by G02, G03 and G17~19(Fig 3-6).

G02:clockwise (cw)

G03:counter - clockwise (ccw)

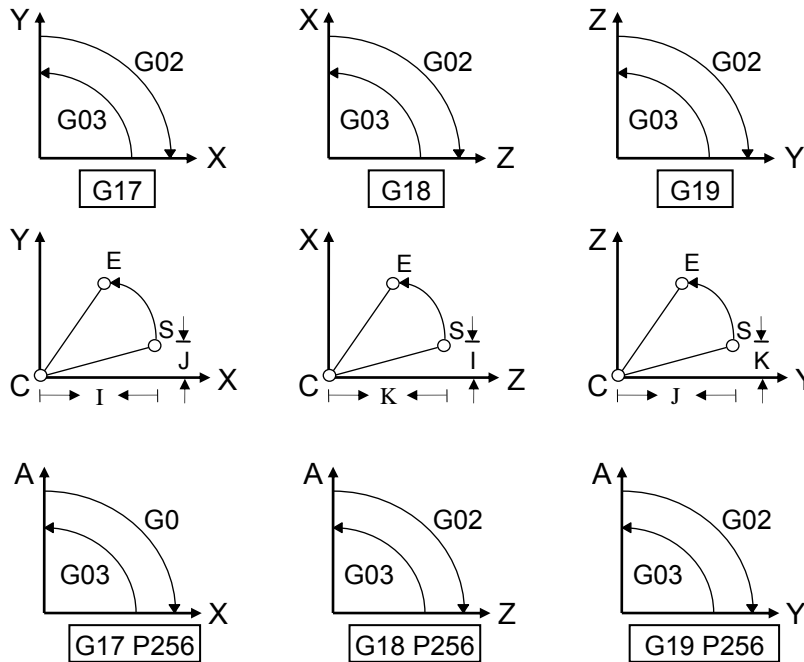

Fig 3-6 Arc cutting

If the angle of an arc is between $-1^\circ \sim 1^\circ$ or $179^\circ \sim 181^\circ$, I, J, K cannot be replaced by R. Fig 3-7 is the example showing the replacement of the I, J, K value with the radius R-value.

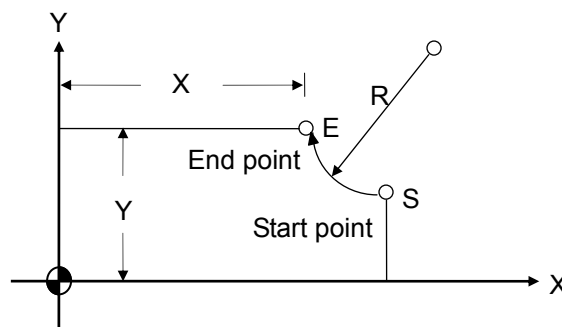

Fig 3-7 Arc Cutting Indicated by the Radius R Value

As shown in Fig. 3-8, R-value is either positive (+) or negative (-) during the arc

cutting. R-value ranges from -4000. mm to +4000.mm.

1. R values must be positive when an arc less than 180° is cut
2. R values must be negative when an arc greater than 180° is cut .

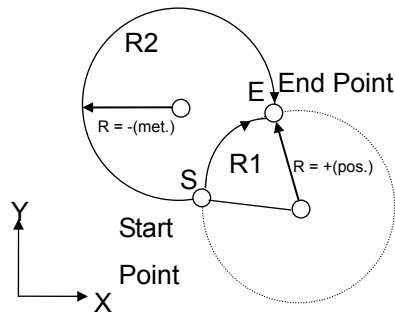

Fig 3-8 Arc cutting (+/- R)

Programming Example: The following four commands are different in settings but execute the same arc cutting work.

Start point X=50.000 , Y=15.000 ,

End point X=30.000 , Y=25.000 ,

Radius R=25.000 , or I=0.000 , J=25.000。

1. G02 X30.000 Y25.000 J25.000 F200.
2. G02 U-20.000 V10.000 J25.000 F200.
3. G02 X30.000 Y25.000 R25.000 F200.
4. G02 U-20.000 V10.000 R25.000 F200.

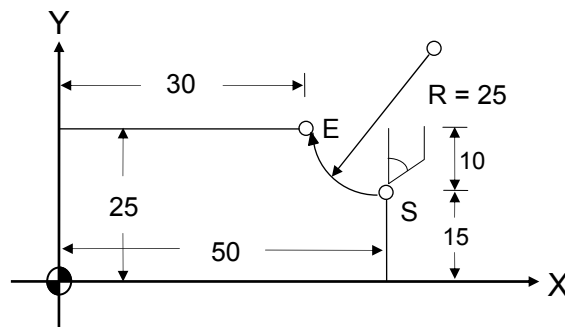

Fig 3-9

When cutting a full circle, only the I, J, K values, rather than the R-value, can be used.

EX: G90
 G00 X40.000 Y0.000
 G03 X40.000 Y0.000 I50. F100.

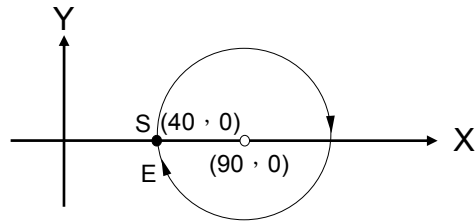

Fig 3-10 Cutting a full cirde

Please note the followings when executing an arc cutting:

1. The F value (i.e. the feed-rate) of G02, G03 is the tangential cutting speed. This speed is subject to the radius of the arc and the F value of the program because H4D-M system uses a fixed $1\mu\text{m}$ chord height error. (Chord Height Error is the maximum distance between the arc and chord)
2. When the calculated tangential cutting speed of the arc is greater than the F value of the program, the F-value is used as the tangential cutting speed. Otherwise, the calculated value prevails.
3. The maximum tangential cutting speed is estimated with the following formula:

$$F_c = 85 * \sqrt{R * 1000} \quad \text{mm/min}$$

Where R= Arc radius in mm.

3.6 Dwell Command , G04

Format:

G04 X_____

G04 P_____

X: Dwell time in seconds (the X here indicates time rather than coordinates).

P: Dwell time in 1/1000 seconds.

To meet machining requirements, the axial movement may need to hold for a while when the execution of a program block is completed before the command for the next block is executed. This command can be used for this purpose.

The minimum dwell time is 0.01 second. It can be set up to 8000.0 seconds.

Ex.: N1 G1 X10.000 Y10.000 F100.
 N2 G4 X2.000 · · · Hold 2 seconds,
 N3 G0 X0.000 Y0.000

3.7 Clear Machine Coordinates , G08

Format:

- G08 ... Clear machine coordinates for all axes, X, Y, Z
- or G08 X___Y___ ... Clear the machine coordinates of X and Y axes
- or G08 Z___ ... Clear the machine coordinates of Z-axis.
- or G08 X___Y___A___ ... Clear the machine coordinates of X, Y, A axes.
- or any combination of X, Y, Z, A, B

X, Y, Z values in the format are meaningless. They only indicate the machine coordinates of the axis to be cleared. If G08 is set to an independent block, the X, Y, and Z machine coordinates are cleared. If X (or Y or Z) command is given, only the machine coordinates of that axis will be cleared regardless of its value.

3.8 Exact Stop Check, G09, G61, G62

Functions and Purposes:

This command provides the option of precision positioning for certain blocks (MCM#114 = 256, Turning Corner Round Angle Connection), if so required, when M300 (round-angle connection between blocks) is enabled.

Program Format:

G09 Exact stop check (effective between 2 blocks posterior to a G09 command)

- G61 Exact stop check mode (modal command, to be disabled by a G62 command when enabled).
- G62 Exact stop check mode cancel (modal command, to disable an enabled G61)

Program Example: (MCM#114 = 256, Turning Corner Round Angle Connection)

```

M03 S1000
G01 X20. F1000
U10.
N10 U50.
    G09 ----- N20 and N21 Precision Positioning between blocks, on
                  completion of N20 block, X-axis speed decelerates to 0.
N20 U50.
N21 U50.
    G61 ----- Precision Positioning between blocks enable (N30---N50)
N30 U50.
N40 U50.
N50 U50.
    G62 ----- Precision Positioning between blocks disable
... ..
... ..
... ..
G00 X0.
M30

```

3.9 Data Setting , G10

Table 3-5 HUST H4D-M G10 Command Code List

G10 Command Code List	
G10 X * * Y * * Z * * A * *	Set the work origin on the G54~G59 work coordinates system
G10 X * * Y * * Z * * P * *	Set the tool length compensation
G10 P510 L38400	Set the baud rate of RS232 interface on the controller to 38400
G10 P510 L57600	Set the baud rate of RS232 interface on the controller to 57600
G10 P510 L1152200	Set the baud rate of RS232 interface on the controller to 115200
G10 P600 L01	Burn the downloaded part program into FLASHROM
G10 P600 L02	Burn the downloaded MCM parameters into FLASHROM
G10 P600 L03	Burn the downloaded ladder program into FLASHROM
G10 P600 L05	Burn the downloaded system data into FLASHROM
G10 P801 B__	Set G01 Accel./Decel. time,
G10 P1000	Load MCM parameters from FLASHROM
G10 P2000	Clear the current program of the controller
G10 P2001	Clear all programs in the memory of the controller
G10 P2002	Clear all variables #1 ~ #9999 to zero
G10 P2100	Load the part program from FLASHROM to memory.

3.9.1 Set the Work Origin Using G10 (Recommended), G10

Set the work origin on the G54~G59 work coordinate system using G10 command. The user may use the MDI key on the HUST H4D-M CNC controller or execute the function through build-in PLC by customization.

Format:

G10 X__ Y__ Z__ A__ B__. Select an axis or all three axes.

Steps for setting the work origin (G54~G59) using G10:

1. Return to Home manually.

2. Enter JOG mode.
3. Move the tool to the desired position where the work origin is to be set.
4. Enter the MDI mode, input G54, and press CYCST.
- 5A. If the coordinates of the tool in Step 3 is the desired position for the work origin, do the following:

Press G10 Input,
 X0. Input,
 Y0. Input,
 Z0. Input,

Press the CYCST key to finish the setting.
- 5B. If the coordinates of the tool in Step 3 is at some distance (say X=20, Y=100, Z=15) away from the desired work origin, do the following:

Press G10 Input,
 X20. Input,
 Y100. Input.
 Z15. Input.

Press the CYCST key to finish the setting.

The following precautions should be observed when using G10 to set the work origin.

1. Do not add P__ to the G10 block, otherwise, it becomes a tool length (movement) compensation command.
2. The same procedure is applicable to the G55~G59 coordinate system, except that G54 is replaced by G55~G59 in Step 4. If no coordinates from G54 to G59 are specified in step 4, the work origin data will be entered into the currently valid work coordinate system.
3. The G10 command can also be applied in the program.
4. When G54~G59 is selected by G10, the machine position data of the origin will be entered into MCM #1~#120.

3.9.2 Set the Tool Length Compensation Using G10

Format :

1. G10 X___ Y___ Z___ P1XX
2. G10 U___ V___ W___ P1XX
3. G10 I___ J___ K___ P1XX

- P1XX : XX=01 ~ 40 , 1~40 represents the tool group number.
- X/Y/Z : Setting the tool length compensation data to the corresponding X, Y, Z of MCM #1431~#1620.
- U/V/W : Setting the tool wear compensation data to the corresponding U, V, W of the MCM #1621~#1900.
- I/J/K : Adding the tool wear compensation data to the corresponding I, J, K of the MCM #1621~#1900.

※ Only can use for the H4D-M / H6D-M . Can't use for the H9D-M.

Table 3-6

P -tool group number	X -axis Tool length compensation	Y -axis Tool length compensation	Z -axis Tool length compensation	R -Tool radius compensation
1	VAR1342	VAR1543	VAR1344	VAR1341
2	VAR1349	VAR1350	VAR1351	VAR1348
3	VAR1356	VAR1357	VAR1358	VAR1359
4	VAR1363	VAR1364	VAR1365	VAR1362
.
.
39	VAR1608	VAR1609	VAR1610	VAR1607
40	VAR1615	VAR1616	VAR1617	VAR15614

Table 3-7

P -tool group number	X -axis Tool wear compensation	Y -axis Tool wear compensation	Z -axis Tool wear compensation	R -Tool radius wear compensation
1	VAR1622	VAR1623	VAR1624	VAR1621
2	VAR1629	VAR1630	VAR1631	VAR1628
3	VAR15636	VAR1637	VAR1638	VAR1635
4	VAR1643	VAR1644	VAR1645	VAR1642
.
.
39	VAR1888	VAR1889	VAR1890	VAR1887
40	VAR1895	VAR1896	VAR1897	VAR1894

Ex 1: Execute command G10 X0.02 Y0.03 P101 → set the length compensation value for the first tool group.

>> MCM#1342 = 0.02, A MCM#1343 = 0.03

Ex 2: Assume: The original MCM#1349~1351 settings are X=0.02, AY=0.03, AZ=1.25

Execute G10 U0.01 V0.02 W1.72 P102 → Set the tool wear compensation value for the second tool group.

>> MCM#1349 = 0.01, MCM#1350 = 0.02, MCM#1351 = 1.72

Ex 3: Assume: The original MCM#1349~1351 settings are X=0.02, AY=0.03, AZ=1.25

Execute G10 I0.01 J0.02 K1.72 P102 → Add the tool wear compensation value to the second tool group.

>> MCM#1349 = 0.02+0.01 = 0.03

MCM#1350 = 0.03+0.05 = 0.08

MCM#1351 = 1.25+1.72 = +2.97

3.9.3 Set G01 Acceleration/Deceleration time Using G10

The acceleration/deceleration time is stored in MCM #505. This setting can be adjusted using one of the following 3 methods.

1. Change the setting directly in the MCM EDIT mode.
2. Execute G10 P801 B___ in the MDI mode
3. Change the setting by executing the work program in AUTO mode.

Note: 1.The "RESET" key must be pressed before the new setting is valid.
2. Press 【 RESET 】 .Settings will return to mcm.

Format :

G10 P801 L_____ -- Set the G01 acceleration/deceleration time (msec)
of MCM #505

Ex1: Change the G01 acceleration/deceleration time in the MDI mode.

Step 1: Double-click AUTO to enter the MDI mode

Step 2: Execute the command G10 P800 L100

G - 1 - 0 INPUT

P - 8 - 0 - 1 INPUT

B - 1 - 0 - 0 INPUT

Step 3: Click CYCST

Step 4: Finish

※ This command is not correct the MCM#505 data, it just temporary executed the register values of system that you setting, after RESET or PROWER ON/OFF that system will run the values of MCM#505 when auto-run.

Ex2: Adjust G01 acceleration/deceleration time based on the travel distance in the AUTO mode,

A/D time = 100 milliseconds if $200.000 \geq \#1$

A/D time = 50 milliseconds if $100.000 < \#1 \leq 200.000$

A/D time = 30 milliseconds if $\#1 \leq 100.00$

Step 1: Edit the work program 0001

O001

N001 G65 L85 P005 A#1 B100

N002 G10 P801 B30

N003 M02

N005 G65 L85 P008 A#1 B200

N006 G10 P801 B50

N007 M02

N008 G10 P801 B100

N010 M02

Step 2: Enter AUTO mode and execute O001

※ it just temporary executed the register values of system that you setting, after RESET or PROWER ON/OFF that system will run the values of MCM#505 when auto-run.

3.10 Servo spindle positioning command , G15

Format:

G15 R_____

R : Servo spindle position

Description:

1. This G-code is only applicable to the servo spindle.
2. Ranging 0.000°~359.999°

EX :

G15 R90.000 <----- to position the master axis at 90 deg.

3.11 Cylindrical Plane, G16

Functions and Purposes:

Using the angular movement of an angle command, convert it internally into a linear distance of the axis on the outer surface, for performing a linear interpolation or arc interpolation with another axis. After the interpolation, this distance is again converted into the movement of the rotating axis.

Program Format:

1. Directly specify a cylinder interpolation axis and cylinder radius.
 G16 Yxxx.xxx: Set Y-axis as the cylinder interpolation axis, xxx.xxx as value of cylinder radius.
 G16 Axxx.xxx: Set A-axis as the cylinder interpolation axis, xxx.xxx as value of cylinder radius.
 G16 Bxxx.xxx: Set B-axis as the cylinder interpolation axis, xxx.xxx as value of cylinder radius.
 G16 Cxxx.xxx: Set C-axis as the cylinder interpolation axis, xxx.xxx as value of cylinder radius.

2. Only set the value of cylinder radius; the cylinder interpolation axis to be determined by the currently used spindle. (I.e., the axial direction for switching from the spindle mode to the servo axis mode.)

G16 Hxxxx.xxx : Set xxxx.xxx as the value of cylinder radius.

When set with this method, the cylinder interpolation axis to be determined by the currently using spindle, and the current spindle must be converted into servo axis for performing cylinder interpolation.

Ex: First Spindle (C-axis) to be switched over to servo spindle mode for performing cylinder interpolation.

```

.....
N01 M50          ... First spindle switched into servo mode
N10 G01 C0.     ... Positioning
N20 G18 Z0 C0   ... Select Z-C plane
N30 G16 H20.    ... Cylinder interpolation enable, C-axis is
                  cylinder interpolation axis; cylinder
                  radius 20mm.

N40 G42 Z10.F1.0 ... Interpolate Tool Tip Radius Offset
N50 G01 Z10.C30. ... Linear Interpolation
N60 G03 Z40.C60.R30. ... Arc Interpolation
N70 G01 Z60.C90. ... Linear Interpolation
N80 G40 Z90.    ... Tool Tip Radius Offset disable
N90 G16 C0      ... Cylinder Interpolation disable
N100 M51        ... Switch into spindle mode
.....

```

Note

1. If xxxx.xxx ≠ 0, cylinder interpolation function is enabled.
If xxxx.xxx=0, cylinder interpolation function is disabled.
2. Specifies G-code selection plane; for this plane, the rotation axis is the specified linear axis.
3. EX.: If the rotation axis is parallel to an X-axis, G17 must specify an X-Y plane which is defined by the rotation axis and Y-axis, or a plane that is parallel to the Y-axis.
4. Feed speed specified in cylinder interpolation is the speed upon the spread surface of the cylinder.
5. In cylinder interpolation mode, arc radius in G02/G03 can only be specified with R parameter instead of I, J, or K.

EX:Cylinder interpolation mode (Cylinder interpolation in Z-axis and C-axis)

G18 Z____ C____

G02 (03) Z____ C____ R____

6. Tool-tip compensation is possible in cylinder interpolation mode. In order to carry out tool compensation in cylinder interpolation, any other in-progress tool compensation must be disabled before entering cylinder interpolation, then start and end tool compensation in cylinder interpolation mode.
7. If cylinder interpolation is started when a tool-tip compensation is in application, an arc interpolation cannot be accomplished correctly in cylinder interpolation.
8. In cylinder interpolation, the movement of a rotating axis activated by an angular command is transformed as a distance in a linear axis for carrying out linear interpolation or arc interpolation with another axis. After interpolation, this distance is transformed back to an angle. For this transformation, input of displacement is the minimum incremental unit. When the cylinder has a small radius, the actual displacement is not equal to the specified displacement; however this error is not accumulative.
9. Cylinder interpolation function ends when a reset is activated.
10. A cylinder interpolation axis must be set as a rotation axis, and only one rotation axis shall be set.

Program Example:

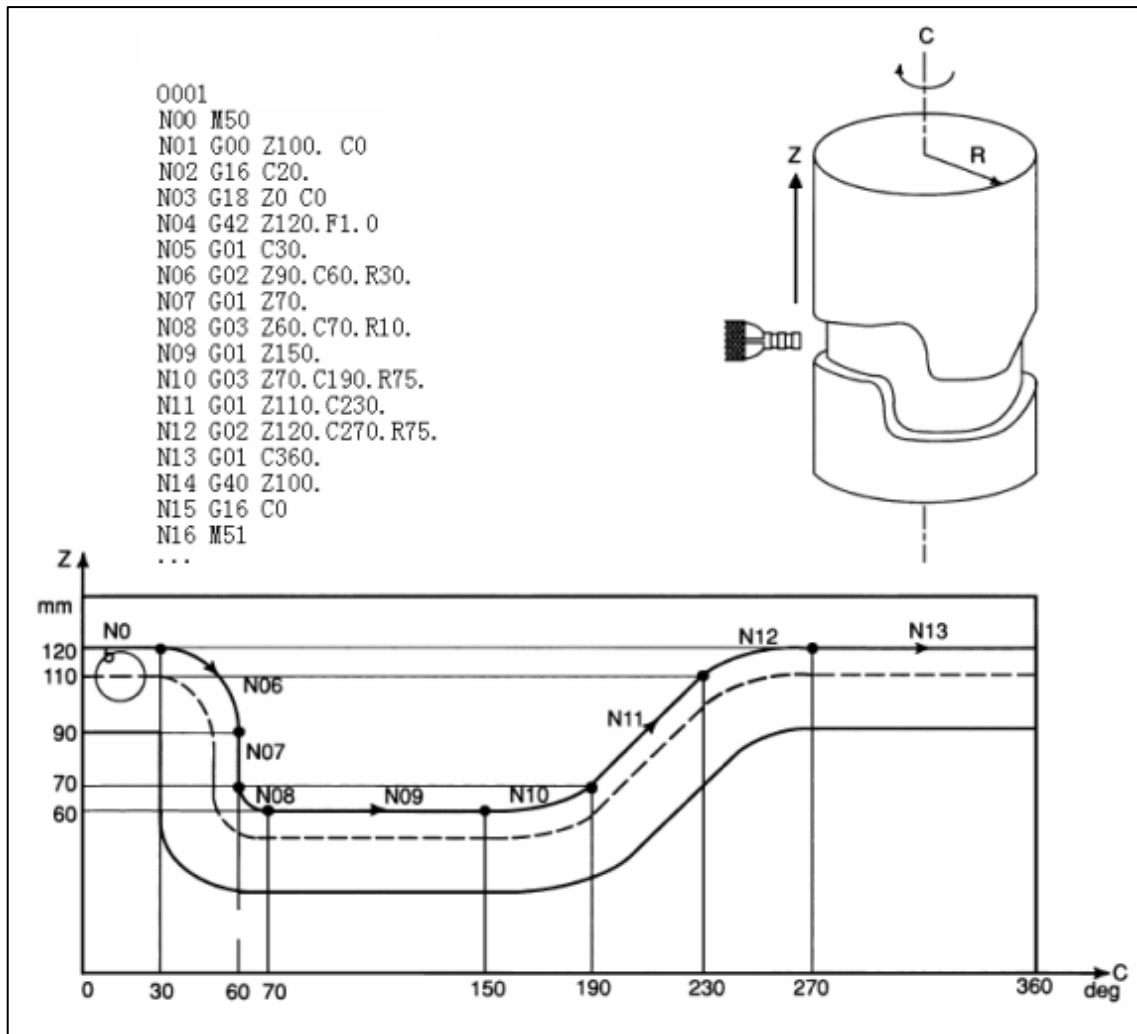

Fig. 3-11 Cylinder Interpolation

3.12 Thread Cutting , G17 , G18 , G19

This command is set as an independent block before the arc cutting command. It executes an arc cutting on a plane specified by G17, G18, G19 and perform a linear cutting on a third axis along the path same as the path of a constant-diameter spring. The dimension of the arc cutting is determined by G17, G18, G19 and the size of the arc are determined by G02, G03 plus the end coordinates of the linear cutting. The tool radius compensation function is only available for the specified cutting plans. Details are described below

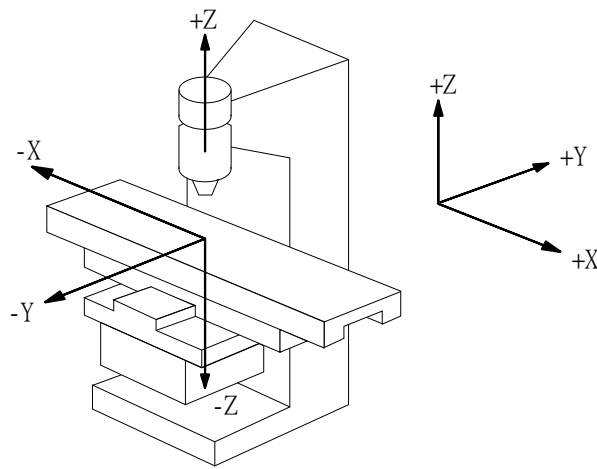

Fig 3-12 X Y Z axes 3D Diagram

Table 3-8

G02 、 G03 Arc(thread)	
	thread
Radius	G17 G02(G03) X_Y_R_Z_F_ (G17 P256 for X A Z Thread)
	G18 G02(G03) X_Z_R_Y_F_ (G18 P256 for A Z Y Thread)
	G19 G02(G03) Y_Z_R_X_F_ (G19 P256 for A Z X Thread)
Center	G17 G02(G03) X_Y_I_J_Z_F_ (G17 P256 for X A Z Thread)
	G18 G02(G03) X_Z_I_K_Y_F_ (G18 P256 for A Z Y Thread)
	G19 G02(G03) Y_Z_J_K_X_F_ (G19 P256 for A Z X Thread)

G17 , X-Y Arc Cutting Plane

As shown in Fig 3-13, if you look down at the machine from the above (along the Z-axis toward the negative direction), you have the X-Y arc cutting plane with Z-axis as the linear axis. Clockwise is G02 and counter-clockwise is G03.

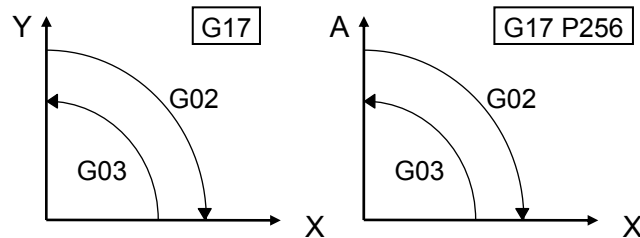

Fig 3-13

Format:

```

N1 G17
N2 G02 (or G03) X___ Y___ I___ J___ Z___ F___
N1 G17 P256
N2 G02 (or G03) X___ A___ I___ J___ Z___ F___
    
```

G18 , Z-X Arc Cutting Plane

If you look at the machine from the back (along the Y-axis toward the negative direction), you have a Z-X arc cutting plane with Y-axis as the linear axis. Clockwise is G02 and counter-clockwise is G03.

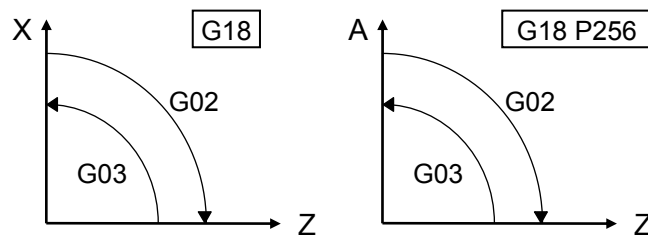

Fig 3-14

Format:

```

N1 G18
N2 G02 (or G03) Z___ X___ K___ I___ Y___ F___
N1 G18 P256
N2 G02 (or G03) Z___ A___ K___ I___ Y___ F___
    
```

G19 , Y-Z Arc Cutting Plane

If you look at the machine from the right side (along the X-axis toward the negative direction), you have Y-Z arc cutting plane with X-axis as the linear axis. Clockwise is G02 and counter-clockwise is G03.

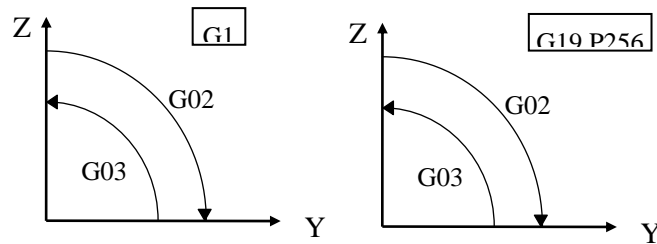

Fig 3-15

Format:

```

N1 G19
N2 G02 (or G03) Y___ Z___ J___ K___ X___ F___
N1 G19 P256
N2 G02 (or G03) Y___ A___ J___ K___ X___ F___

```

EX: X-Y arc cutting plane with Z-axis as the linear axis. (Fig 3-16)

```

N1 G17
N2 G03 X80.000 Y30.000 R30.000 Z40.000 F100

```

EX : A axis Parallel Y axis , X-A arc cutting plane with Z-axis as the linear axis

(Fig 3-16-1)。

```

N1 G17 P256
N2 G03 X80.000 A30.000 R30.000 Z40.000 F100

```

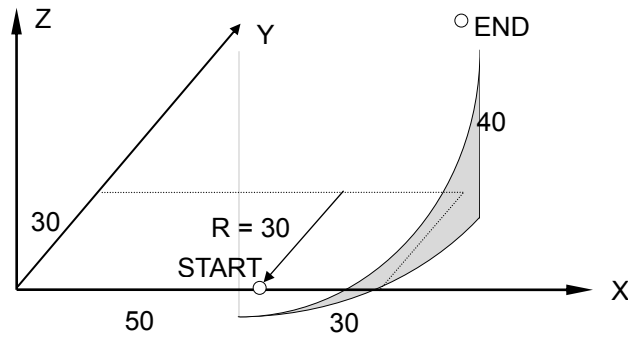

Fig 3-16

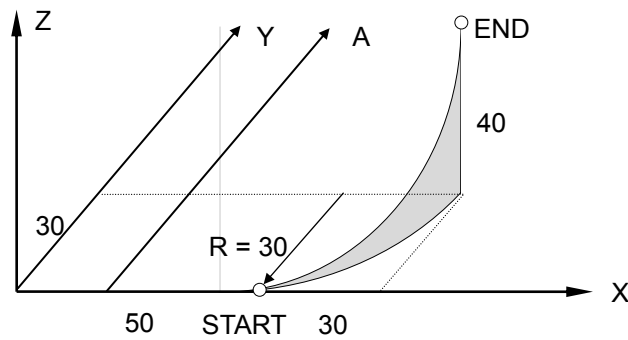

Fig 3-16-1

3.13 Imperial/Metric Measuring Modes , G20 , G21

Format:

- G20 -- System measurements use Imperial units.
- G21 -- System measurements use Metric units.

3.14 G22 Linear Groove (Only available in absolute mode)

Format:

G22 X__ Y__ Z__ R__ I__ J__ F__

- X : Start point of coordinate X
- Y : Start point of coordinate Y
- Z : Grooving depth
- R : Height of outer part
- I : The X-axis incremental coordinate with an end point relative to the start point.
- J : The Y-axis incremental coordinate with an end point relative to the

start point.

F : Grooving speed

Explanation:

1. G00 X(x) Y(y)
2. G00 Z(r)
3. G01 Z(z) F(f)
4. G01 X(x+l) Y(y+j)
5. G00 Z(r)

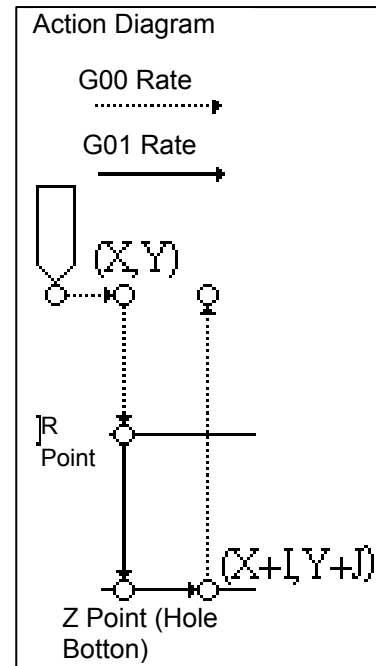

3.15 G23 Arc Groove Milling (Only available in absolute mode)

Format:

G23 X__Y__Z__R__I__J__K__T__F__

- X : Start point coordinate
- Y : Start point coordinate
- Z : Groove depth
- R : Height of outer part
- I : X-axis incremental coordinates with an end point relative to the start point.
- J : Y-axis incremental coordinates with an end point relative to the start point.
- K : Radius of circle
- T : Grooving type (0~1)
- F : Grooving speed

Explanation:

1. G00 X(x) Y(y)
2. G00 Z(r)
3. G01 Z(z) F(f)
4. T=0; G02 U(i) V(j) R(k) F(f)
T=1; G03 U(i) V(j) R(k) F(f)
5. G00 Z(r)

The gray area shows the cutting trajectory.

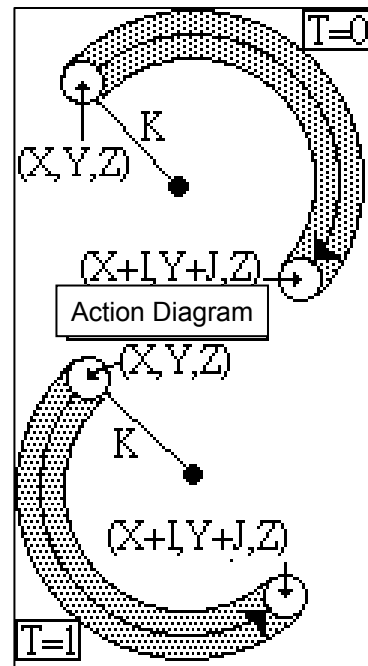

PS. R-value is positive when an arc less than 180-degrees is cut.

R-value is negative when an arc greater than 180-degrees is cut.

3.16 G24 Square Groove Milling (Only available in absolute mode)

Format:

G24 X__Y__Z__R__I__J__D__T__F__

- X : Start point coordinate
- Y : Start point coordinate
- Z : Groove depth
- R : Height of outer part
- I : Groove width
- J : Groove length
- D : Tool radius
- T : Groove type (0~1)
- F : Groove Speed

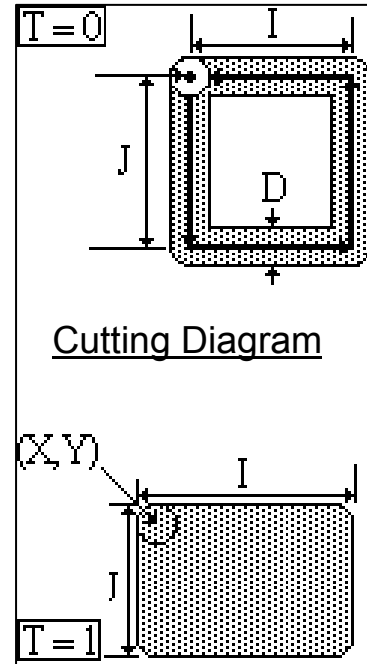

Explanation:

T=0:

1. G00 X(x) Y(y)
2. G00 Z(r)
3. G01 Z(z)
4. G01 U(i)
5. G01 V()
6. G01-U(i)
7. G01-V(j)
8. G00 Z(r)

T=1:

As shown in the above figure, an inner square is cut in a S-shaped groove-milling manner. Then cut again along the side to remove the part that is not cut during the S-shaped groove milling process.

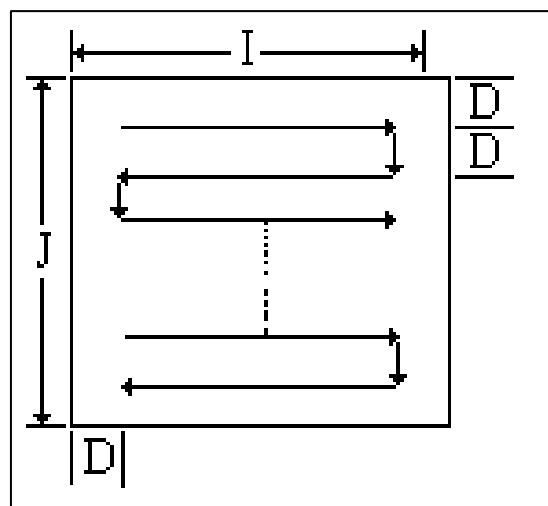

3.17 G25 Round Groove Milling (Only available in absolute mode)

Format:

G25 X__Y__Z__R__K__D__T__F__

- X : Center coordinate
- Y : Center coordinate
- Z : Groove depth
- R : Height of outer part
- K : Radius of circle
- D : Tool diameter
- T : Groove type
- F : Groove speed

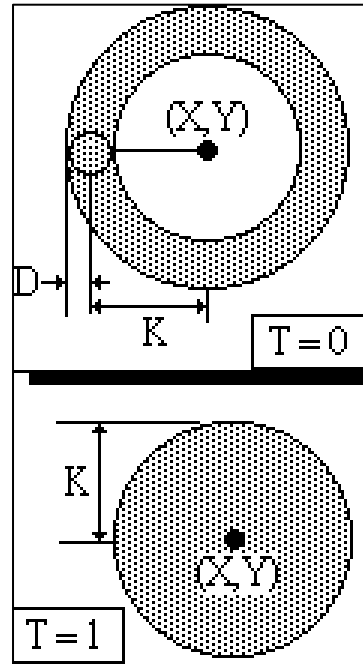

Explanation:

T=0:

1. G00 X(x-k) Y(y)
2. G00 Z(r)
3. G01 Z(z) F(f)
4. G02 I(k) J(0) R(k) F(f)
5. G00 Z(r)

T=1:

1. G00 X(x-k) Y(y)
2. G00 Z(r)
3. G01 U(d) F(f)
4. G01 Z(z) F(f)
5. G02 I(k) J(0) R(k) F(f)
6. IF (k>d) THEN {[k=k-d]and[goto N3]}
7. G00 Z(r)

3.18 Return to the First Reference Point , G28

Format:

G28
 or G28 X____Y____Z____A____B____

The first reference point coordinates are set based on the X, Y, Z, A, B ,Bsettings in MCM #121~125. The X, Y, Z, A, B values in this format are meaningless. They only indicate which axis is to return to the reference point. Therefore, regardless of whether G28 is an independent block or contains X, Y, Z, A, B commands simultaneously, the tools return to the reference point based on the X, Y, Z, A, B settings in MCM #121~125.

One to three axis coordinate commands can be specified after G28, and the tool returns to the reference point of the corresponding axis set in the MCM #121-125 accordingly no matter what the value of the command is. The axis, which is not specified via the command, does not execute any motion. The examples of axial coordinate commands are shown as follows. Users can set the axes when required.

G28	Three axes return simultaneously.
G28 X____	One axis returns.
G28 X____Y____	Two axes return simultaneously.

Note that prior to executing the G28 command, the tool compensation command must be canceled.

Ex: G40	Tool compensation is canceled (<u>it can not co-exist with G28 in the same block</u>)
G28 X10.	Tool returns to the 1st reference point on the X-axis, while the Y and Z axes do not move.

3.19 Return to Previous Position from Reference Point , G29

Format:

- X、Y、Z、A、B : Predicted end point in absolute coordinates.
 U、V、W : Predicted end point in incremental coordinates
 relative to the starting point.
 P : set Skip input sensor ◦ (P1=I01)

To ensure valid skip function G31, it must be used in combination with an I/O signal. G31 functions same as G01 until the skip function is established' i.e. G31 executes linear cutting in the X, Y, Z, B coordinates. Once an I/O signal is detected during cutting, the G31 skip function establishes and the block G31 skips from the current operation to the next block.

When G31 is performing linear cutting, the feed-rate is determined by the currently effective F-value (G00 or G01). G31 is a one-shot G-code and only valid in the specified block.

EX:

```
N40 G40
N50 G31 U100.000 F100.P1
N60 G01 V25.000
N70 X90. Y30.
```

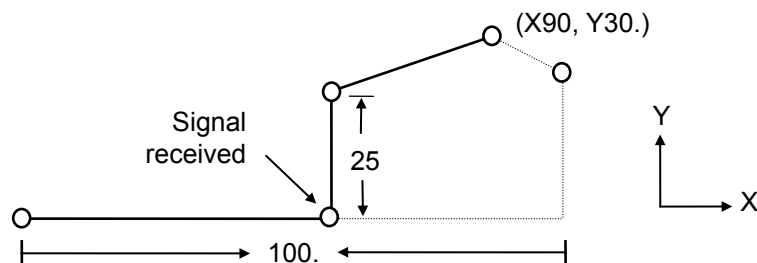

Fig 3-17 G31 skip function

In Fig 3-17, the dotted line represents the original path without the Skip function and the solid line is the actual tool path when the Skip function signal is received. Note that G31 cannot be used in the tool radius compensation state. G40 must be executed to cancel the tool radius compensation before G31 can be used. The Skip function is invalid during program dry run, feed-rate adjustment or auto acceleration/deceleration.

3.22 Coordinates rotate command, G38, G39

Command syntax:

G38 A_____ B_____ R_____	Enable the coordinates rotate function.
G39	Disable the coordinates rotate function.

A_____ B_____: Set up the rotate center. Parameter A and B represent the two axes of the current rotating plane respectively. For rotating plane G17, the command becomes G38 X_ Y_ R_ and G38 X_ Z_ R_ for rotating plane G18.

Note:

1. You can select plane G17, G18, or G19 with the proper command before enabling the coordinates rotate function with command G38. If a plane selection (G17, G18, or G19) command is given after the coordinates rotate function has been enabled, the system prompts you with an error message ERR13.G.
2. If the next command after the G38 one is an incremental command G91, then the coordinate position given by the command preceding G38 is taken as the rotating center. If the next command after the G38 one is an absolute command G90, then the coordinate position given by command G38 is taken as the rotating center.
3. The command takes its default format of G38 a0 b0 if a__ b__ is left blank.
4. After the coordinates rotate function is enabled, you cannot specify the reference point specific G code (e.g. G28, G29, and G30) and the coordinates system change command (G10 X__ Y__, G50, and 52~G59) or the error message ERR13.G prompts.

Example 1:

```
G00 X0. Y0.
G38 X0. Y0. R45.
G01 X20. Y20. F1500
X40.
Y40.
X20.
Y20.
G39
M30
```

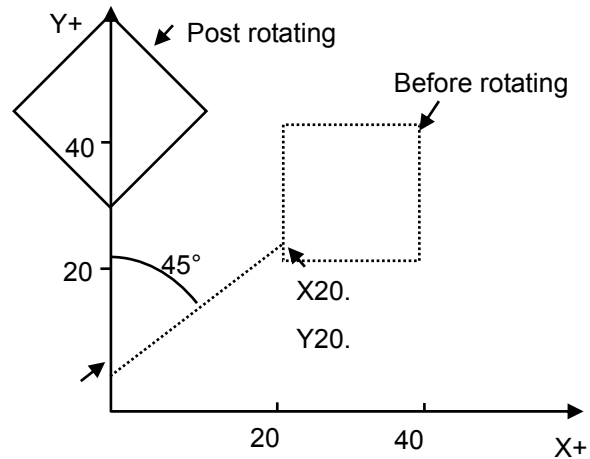

Fig 3-18

Example 2:

```
G00 X0. Y40.
G01 X20. Y40. F1500
G38 X0. Y0. R-45.
G91
G01 X20. Y0. F150
0
G39
M30
```

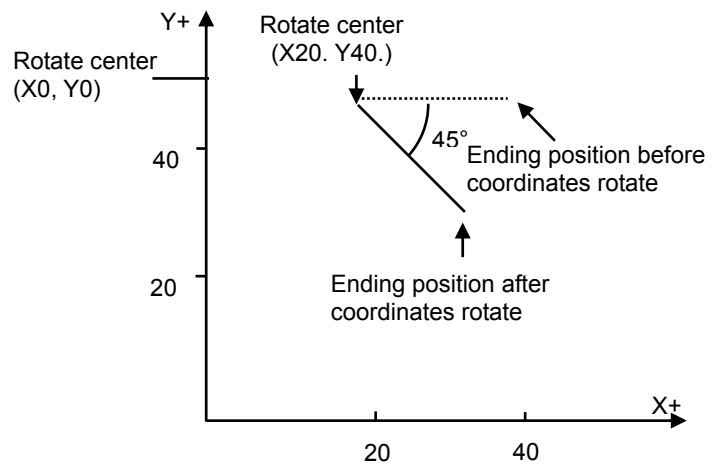

Fig 3-19

3.23 Tool Compensation

The tool compensations of HUST H4D-M CNC have three types. The data of tool compensation are stored in the tool length compensation and tool radius wear compensation, and can store 40 tool compensation data. These data can be called by G41, G42, G43, G44 commands. Use G40, G49 to cancel the

1. Tool radius wear compensation

To compensate the error in x or y-axis resulting from tool radius wear after use. This compensation is usually used in combination with the tool radius compensation. The compensation data are stored in the length wear radius compensation.

2. Tool length radius compensation

To compensate the error in the tool axis (Z-axis) resulting from differences in tool lengths.

The compensation data are stored in the tool length radius compensation.

3. Tool measure compensation

Set the zero point of work position and the compensation's data will storage in MCM (Tool-Offset)

3.23.1 Tool radius and radius wear compensation , G40 , G41 , G42

Format:

G41 D__ X__ Y__	Tool radius compensation - <u>Left</u>
G42 D__ X__ Y__	Tool radius compensation - <u>Right</u>
G40	Tool radius compensation - <u>cancel</u>

D : Tool number of tool radius and radius wear compensation, no.1~40

X, Y : Insert the coordinates of tool radius compensation.

Description :

Where the tool-tip is used to cut along the profile of the work-piece during the execution of the part program, an over-cutting of the radius will occur on each processing path. With the tool radius compensation function, a tool radius value can be offset based on the actual travel of the tool and the specified path of the command to ensure that the processing result conform to the specifications of the drawing. Therefore, correct product size can be ensured by writing the work program based on the specifications of the drawing and the compensation function of the system. The tool radius does not need to be taken into account for the program.

The tool size of a milling machine varies significantly from 1mm to 50mm, and the tool radius compensation G41, G42 can be used to ensure that the tool cuts along the profile of the design plan.

Whether G41 or G42 is used depends on the relative position between the tool direction and the tool-tip. To the direction of the arrow in Fig. 3-20, G42 is used

when the central point of the tool radius is located at the right side of the tool path (radius offset to the right). G41 is used when the central point radius is located at the left side of the tool path (radius offset to the left). G41 and G42 are Model G-codes and can only be cancelled using G40.

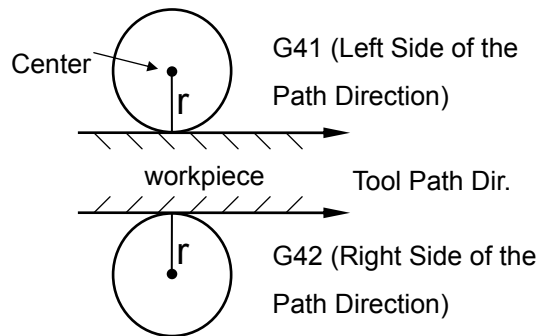

Fig 3-20 G41 and G42 Applications

Execution of Tool Radius Wear Compensation

Tool radius wear compensation is executed in the same way as the tool radius compensation is. When the G41/G42 command is calling the tool number for radius compensation using the N-code, the HUST controller simultaneously selects the tool radius length and radius wear compensation values for the called tool number and compensation the program.

Ex: The D3 tool compensation value is
 Radius compensation=2.000 mm, radius wear compensation=-0.010mm
 Tool radius compensation=2.000-0.010=1.990mm

Please note that the radius wear compensation value is input with a (-) sign. The radius compensation and radius wear compensation are only valid on the X, Y plane, not on the Z-axis.

Starting of tool-tip radius compensation:

With the G41.G42 command alone, the tool will not perform a movement according to tool-tip radius compensation. A tool-tip radius compensation does not start on G00; it only starts on a G01, G02, or G03 command.

When a G41.G42 command exists in the same block with a move command, the move command is processed as a G01 command.

1. In the case of a single command of Chamfer inside G41.G42:

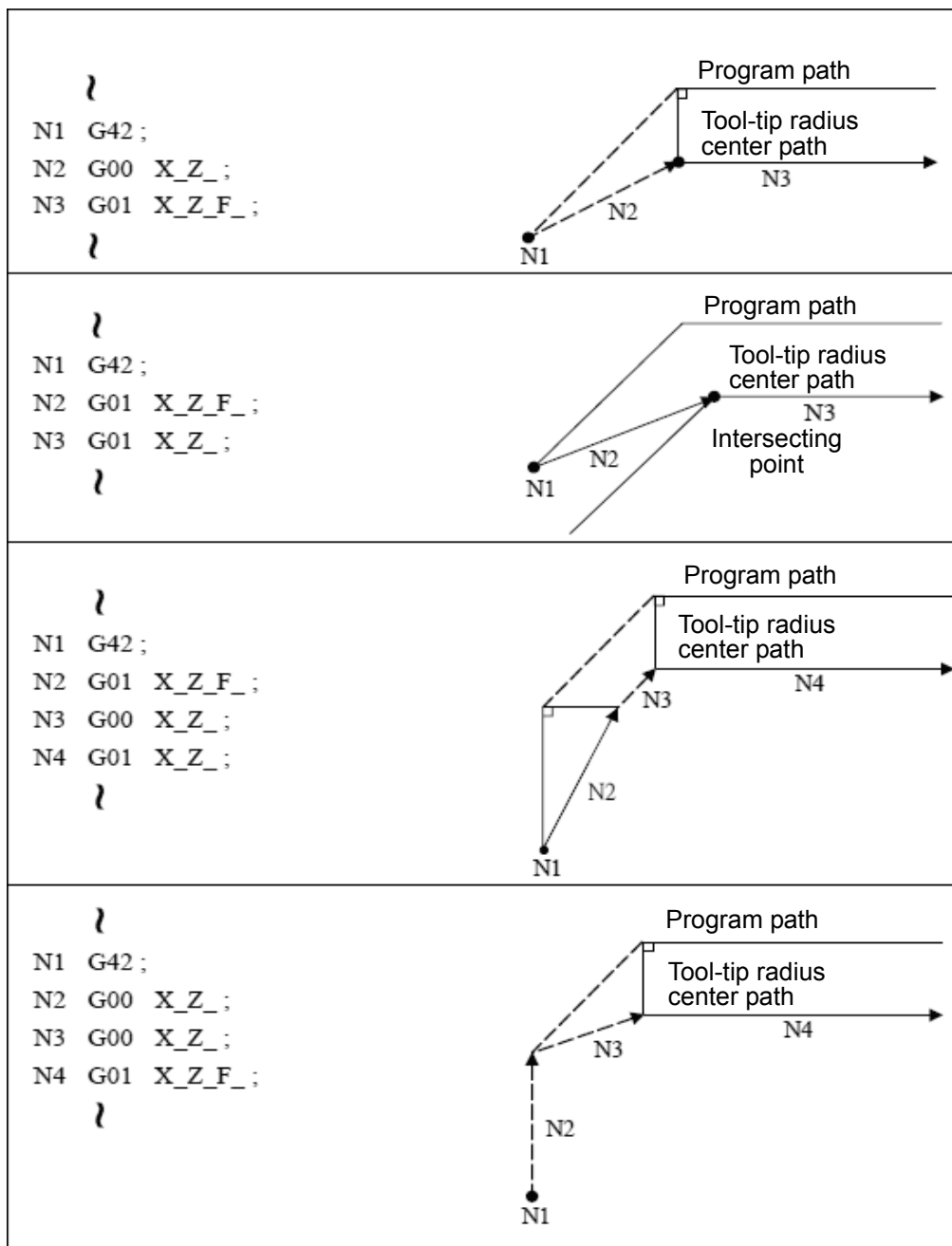

Fig 3-21

```

~
N1 G42
N2 G00 X_ Z_
N3 G03 I_ K_ F_
~

```

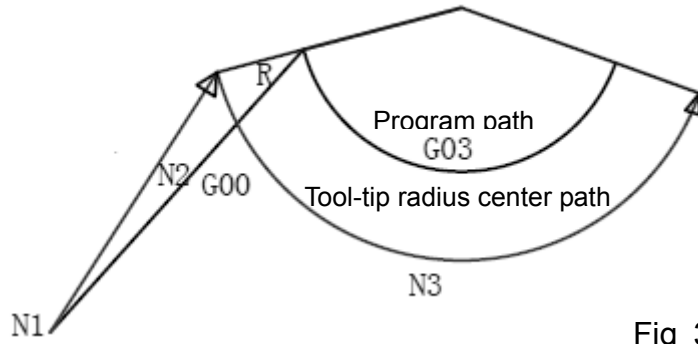

Fig 3-22

```

~
N1 G42
N2 G01 X_ Z_
N3 G03 I_ K_ F_
~

```

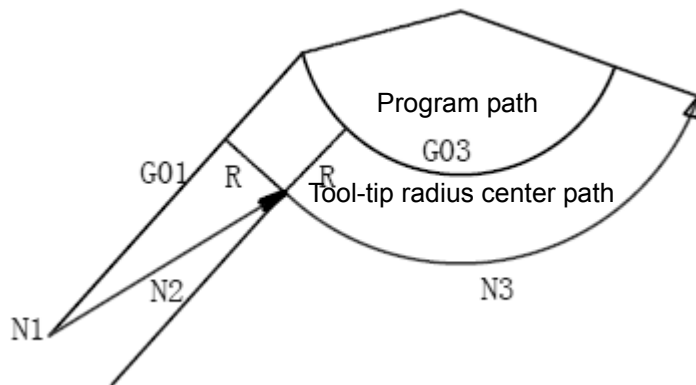

Fig 3-23

- When chamfer inside G41.G42 exists in the same block with a move command:

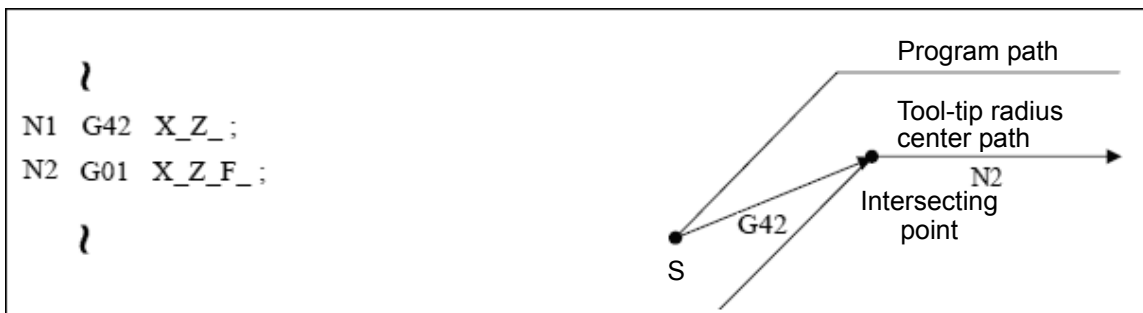

Fig 3-24

3. Chamfer outside (obtuse angle) G41.G42 command only:

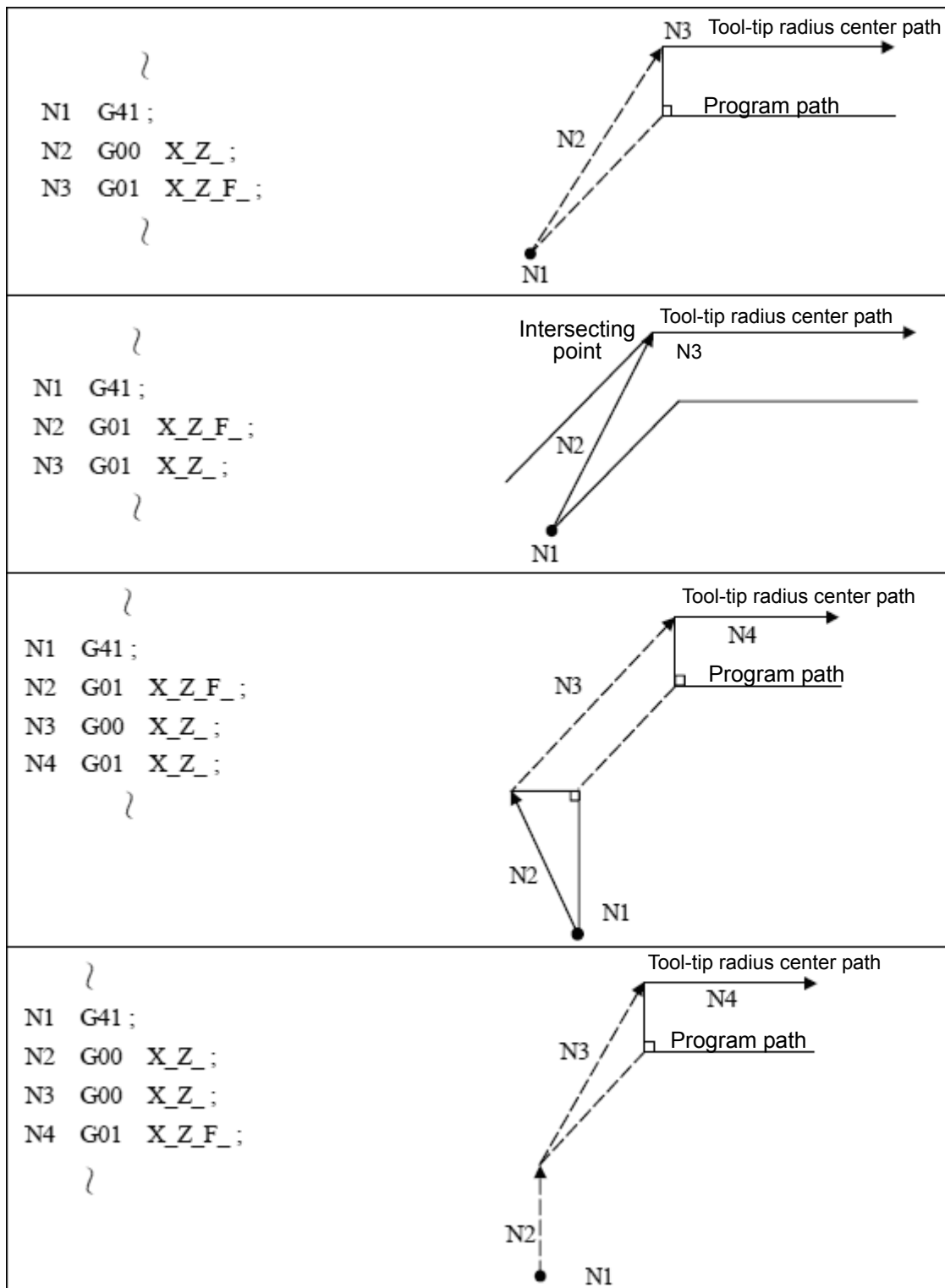

Fig 3-25

4. Chamfer outside (obtuse angle) G41.G42 exists in the same block with a move command:

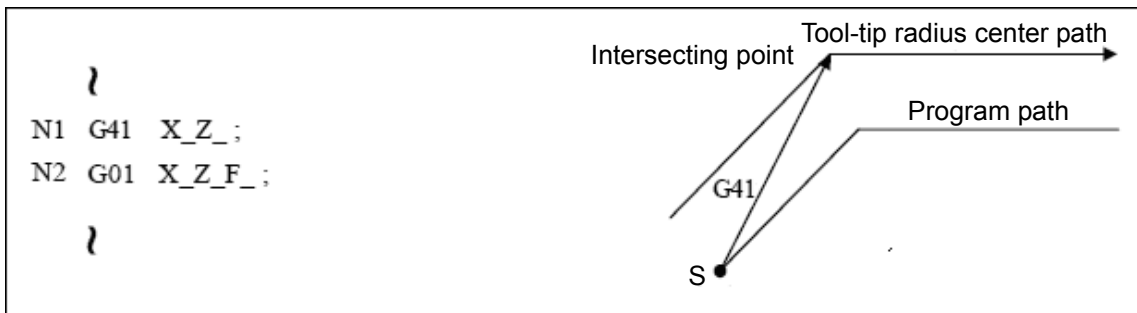

Fig 3-26

5. Chamfer outside (acute angle) G41.G42 command only:

	Type A	Type B
<pre> } N1 G41 ; N2 G00 X_Z_ ; N3 G01 X_Z_F_ ; } </pre>	<p>Tool-tip radius center path</p>	<p>Tool-tip radius center path</p>
<pre> } N1 G41 ; N2 G01 X_Z_F_ ; N3 G01 X_Z_ ; } </pre>	<p>Tool-tip radius center path</p>	<p>Tool-tip radius center path</p>
<pre> } N1 G41 ; N2 G01 X_Z_F_ ; N3 G00 X_Z_ ; N4 G01 X_Z_ ; } </pre>	<p>Tool-tip radius center path</p>	<p>Tool-tip radius center path</p>
<pre> } N1 G41 ; N2 G00 X_Z_ ; N3 G00 X_Z_ ; N4 G01 X_Z_F_ ; } </pre>	<p>Tool-tip radius center path</p>	<p>Tool-tip radius center path</p>

Fig 3-27

6. Chamfer outside (acute angle) G41.G42 exists in the same block with a move command:

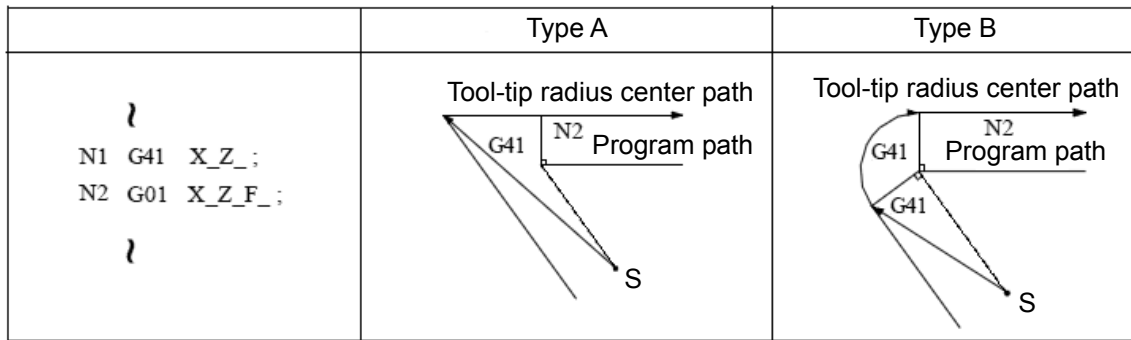

Fig 3-28

Operation in a tool-tip compensation mode:

In the tool-tip radius compensation (G41,G42) mode, a tool-tip radius compensation command having the same content is not valid. Pre-reading is prohibited if a G65 L50 command is included in the tool-tip radius compensation.

1. Rotation of chamfer inside:

Line→Line (obtuse angle)

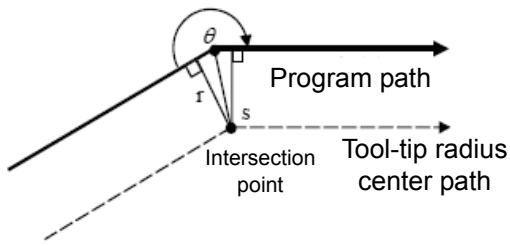

Line→Line (acute angle)

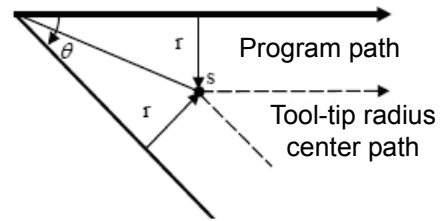

Line→Arc (obtuse angle)

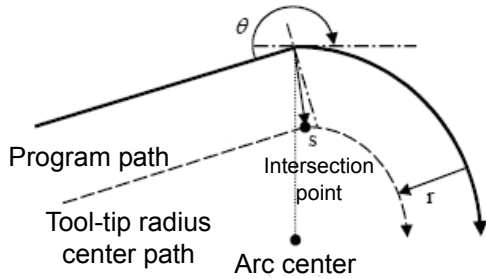

Line→Arc (acute angle)

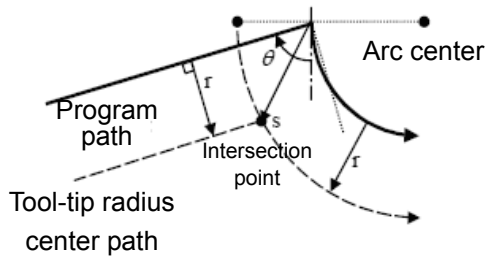

Arc→Line (obtuse angle)

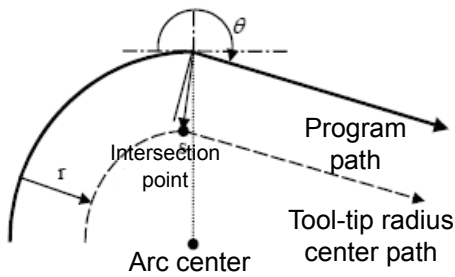

Arc→Line (acute angle)

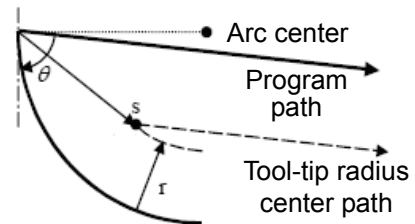

Arc→Arc (obtuse angle)

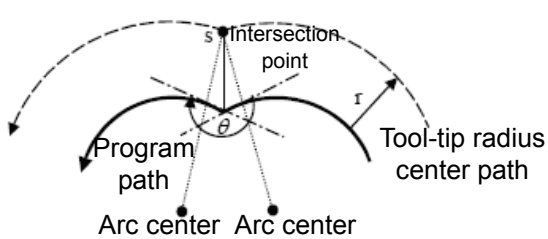

Arc→Arc (acute angle)

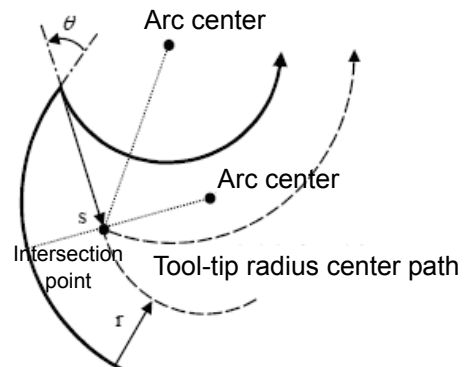
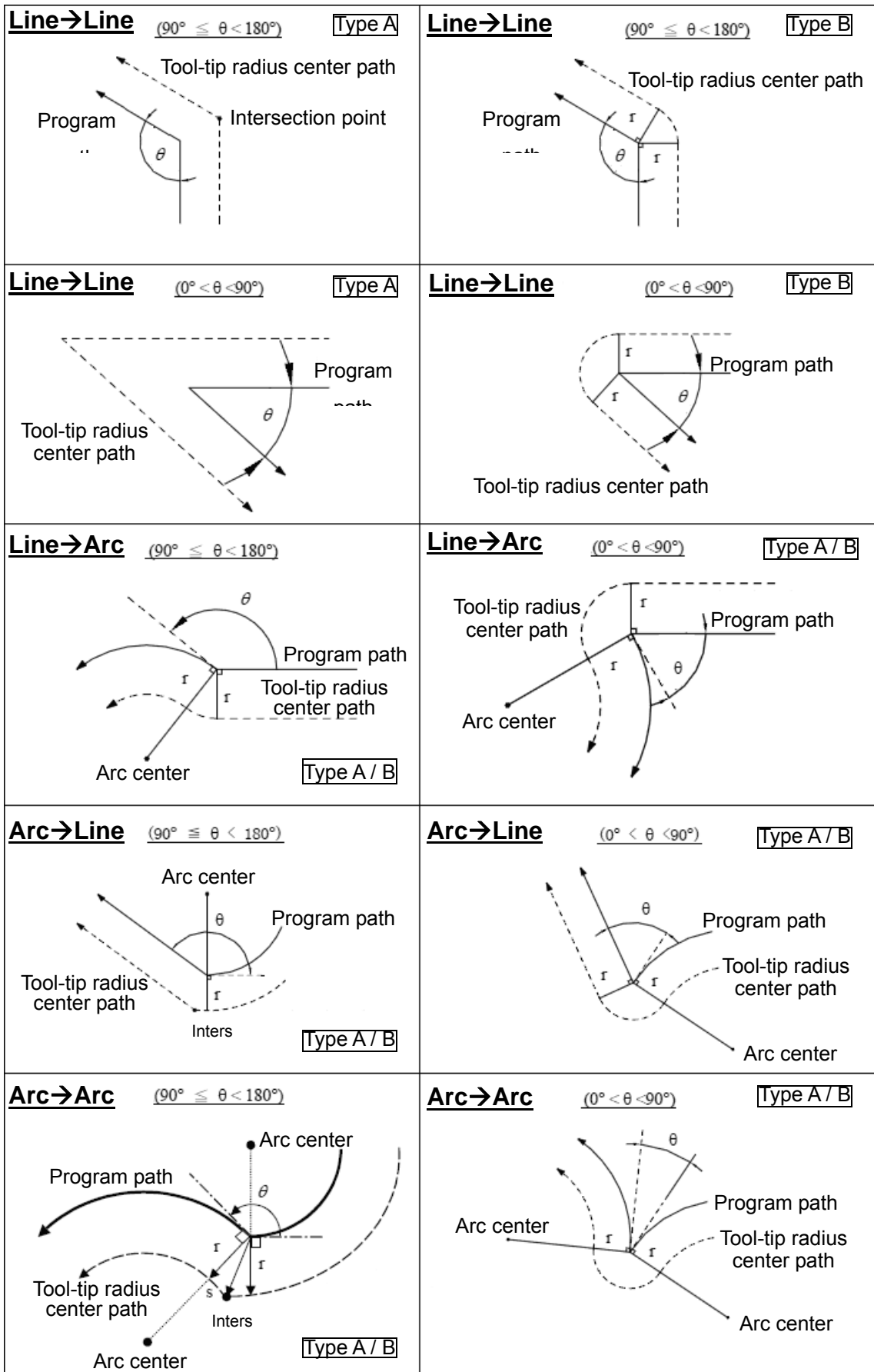

Fig 3-29

2. Rotation of Chamfer outside:, Fig 3-30



Direction change of tool-tip compensation

Direction of compensation is determined by tool-tip radius compensation command (G41, G42).

During compensation mode, without a cancellation command of the compensation, a change of the compensation command may change the direction of compensation. But the change does not change the starting section of the compensation, nor of the subsequent section of the program.

Line→Line

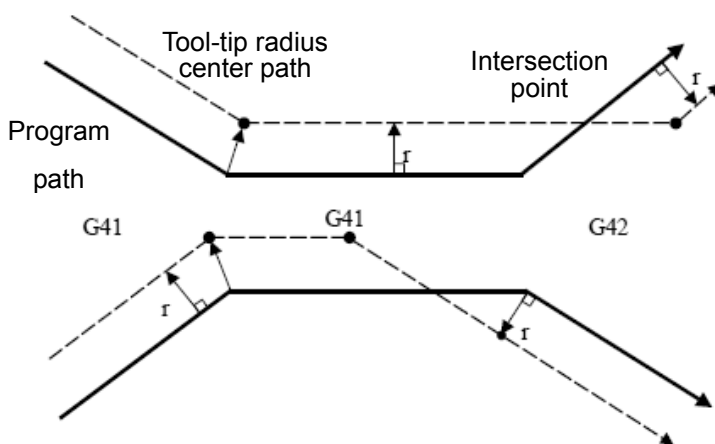

Line→Arc

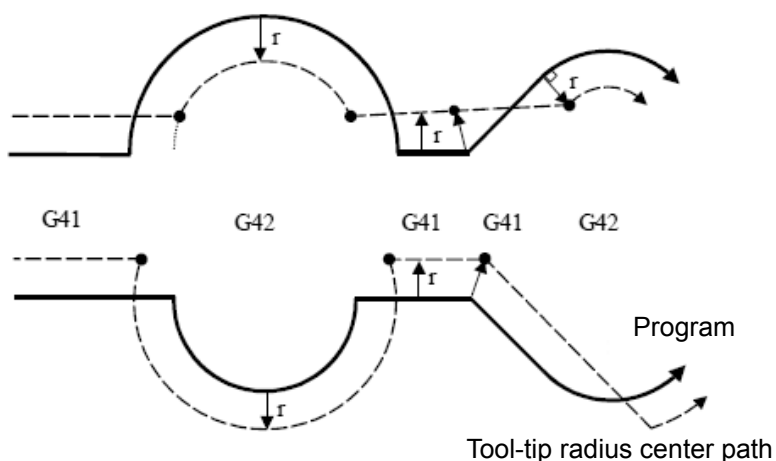

Fig 3-31 Change of compensating direction in a tool-tip radius compensation

Disabling a tool-tip radius compensation:

When tool-tip radius compensation is enabled and all the following conditions are met, the tool-tip radius compensation can be disabled:

1. A G40 command is executed.
2. Executing a move command excluding the arc command.

After reading-in the disable command of compensation, the program switches into (compensation) disabled mode which comprises the following 3 conditions:

1. A tool-tip radius compensation ends, G40 alone disables tool compensation, and a G00 precedes G40, tool compensation is disabled in the block of a G00 move command.
2. A tool-tip radius compensation ends, G40 alone disables tool compensation, and a G01/G02/G03 precedes G40, tool stops at the center of tool-tip radius vertically, tool compensation remains enabled until the first move command after G40. If no move command follows G40, tool compensation remains enabled on the encounter of an end command M02/M30; the compensation is disabled when the program is re-started, without an operation for disabling tool compensation.
3. A tool-tip radius compensation ends, if G40 command is in the same command line with a move command, tool compensation is disabled in the G40 command block.

Disabling tool radius compensation:

1. Chamfer inside G40 command only:

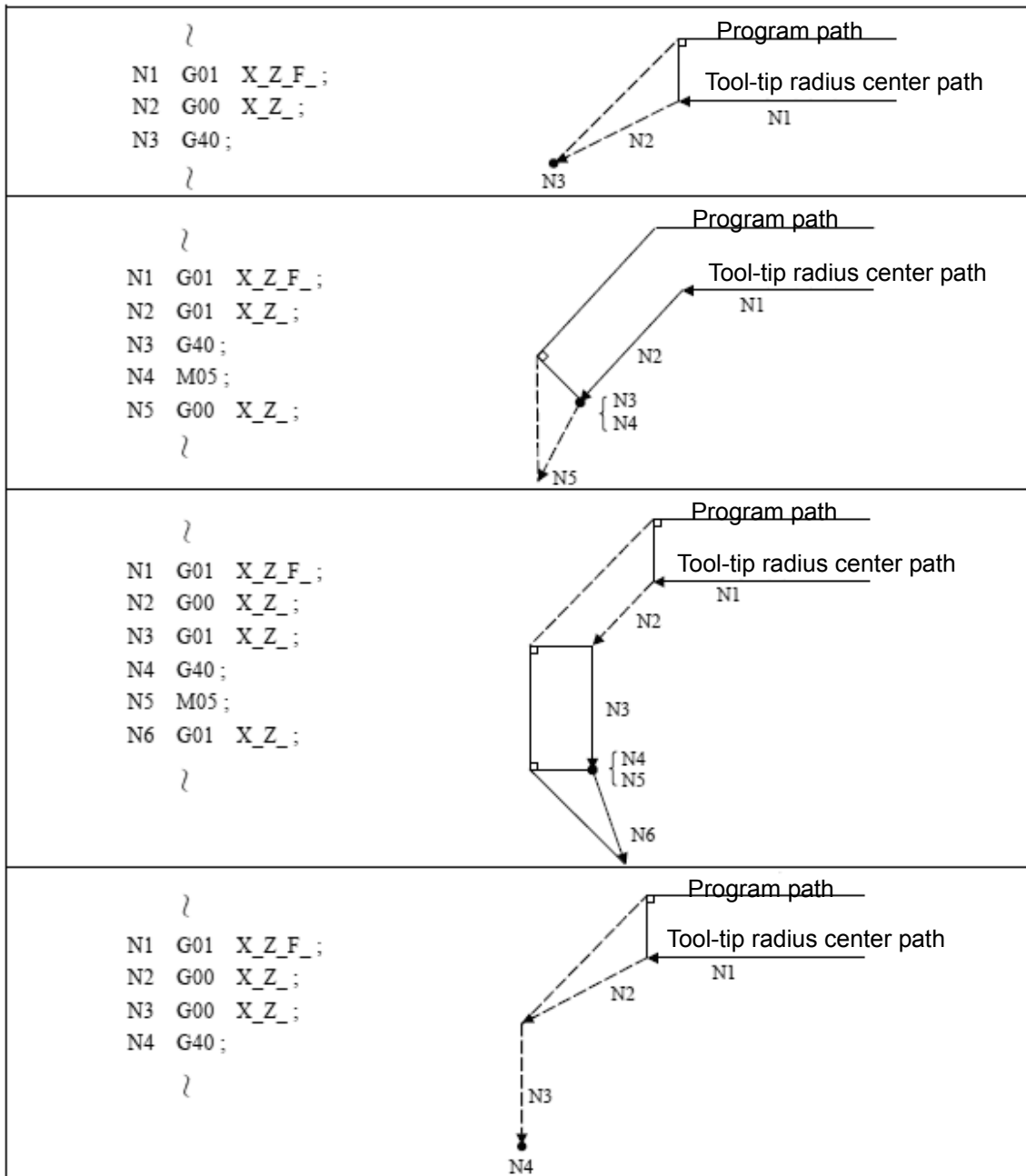
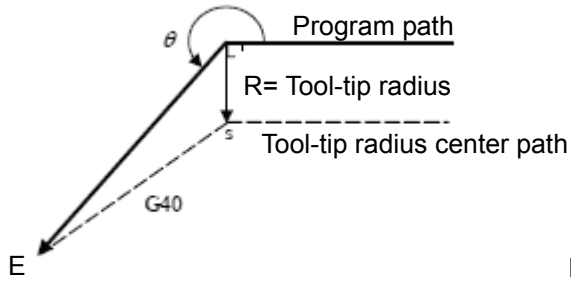

Fig 3-32

2. Chamfer inside G40 is in the same block as a move command:

Line→Line



Arc→Line

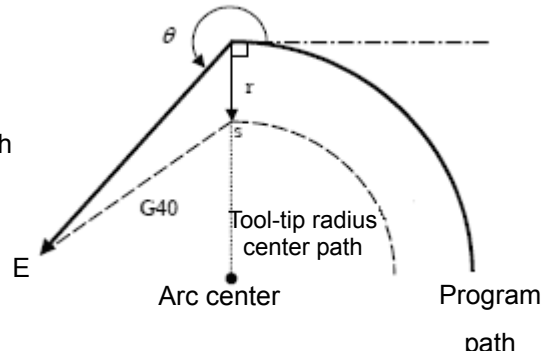

Fig 3-33

3. Chamfer outside (obtuse angle) G40 command only:

	Type A	Type B
<pre> } N1 G01 X_Z_F_; N2 G00 X_Z_; N3 G40; } </pre>		
<pre> } N1 G01 X_Z_F_; N2 G01 X_Z_; N3 G40; N4 M05; N5 G00 X_Z_; } </pre>		
<pre> } N1 G01 X_Z_F_; N2 G00 X_Z_; N3 G01 X_Z_; N4 G40; N5 M05; N6 G01 X_Z_; } </pre>		
<pre> } N1 G01 X_Z_F_; N2 G00 X_Z_; N3 G00 X_Z_; N4 G40; } </pre>		

Fig 3-34

4. Chamfer outside (obtuse angle) G40 and move command in the same block:

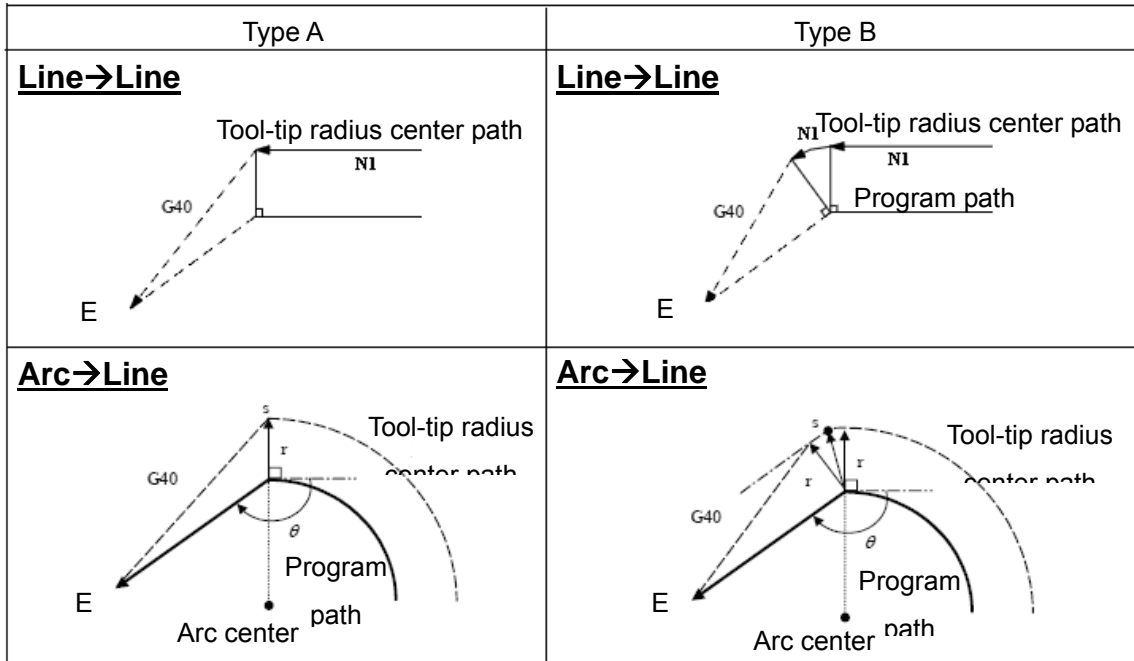

Fig. 3-35

5. Chamfer outside (acute angle) G40 command only:

	Type A	Type B
<pre> } N1 G01 X_Z_F_; N2 G00 X_Z_; N3 G40; } </pre>	<p>Tool-tip radius center path</p>	<p>Tool-tip radius center path</p>
<pre> } N1 G01 X_Z_F_; N2 G01 X_Z_; N3 G40; N4 M05; N5 G00 X_Z_; } </pre>	<p>Tool-tip radius center path</p>	<p>Tool-tip radius center path</p>
<pre> } N1 G01 X_Z_F_; N2 G00 X_Z_; N3 G01 X_Z_; N4 G40; N5 M05; N6 G01 X_Z_; } </pre>	<p>Tool-tip radius center path</p>	<p>Tool-tip radius center path</p>
<pre> } N1 G01 X_Z_F_; N2 G00 X_Z_; N3 G00 X_Z_; N4 G40; } </pre>	<p>Tool-tip radius center path</p>	<p>Tool-tip radius center path</p>

Fig. 3-36

6. Chamfer outside (acute angle) G40 and move command in the same block:

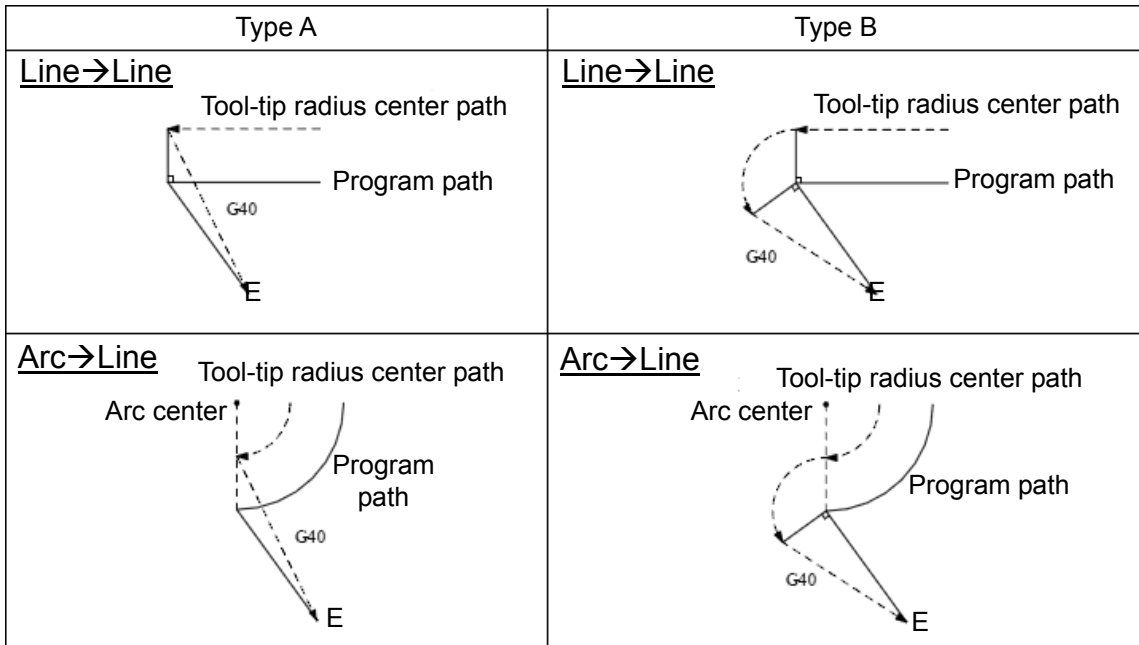

Fig 3-37

3.23.2 Notes on Tool Radius Compensation

1. When cutting around an inside corner, the arc radius of the inside corner must be equal to or greater than the tool radius (r). Otherwise an alarm will generate an alarm signal. The arc cutting around an outside corner is not subject to this regulation.
2. G41, G42 commands are not applicable to canned cycles (G80~G89). They must be cancelled using G40 before a canned cycle can be executed.
3. Where an arc cutting command exists during the tool radius compensation (G41,42), the writing method of the radius value "R" is applicable.
4. Where multiple axes are controlled simultaneously, the tool radius compensation of the HUST H4D-M is only valid on the X, Y plane not on the Z- axis.
5. The tool radius compensation function is not available for MDI operation.
6. When cutting a stepwise work-piece with a step value smaller than the tool radius, over-cutting many occur as shown in Figure 3-38

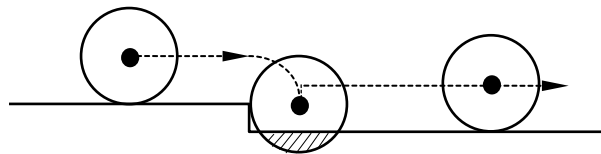

Fig 3-38 Over-Cutting (Shaded area)

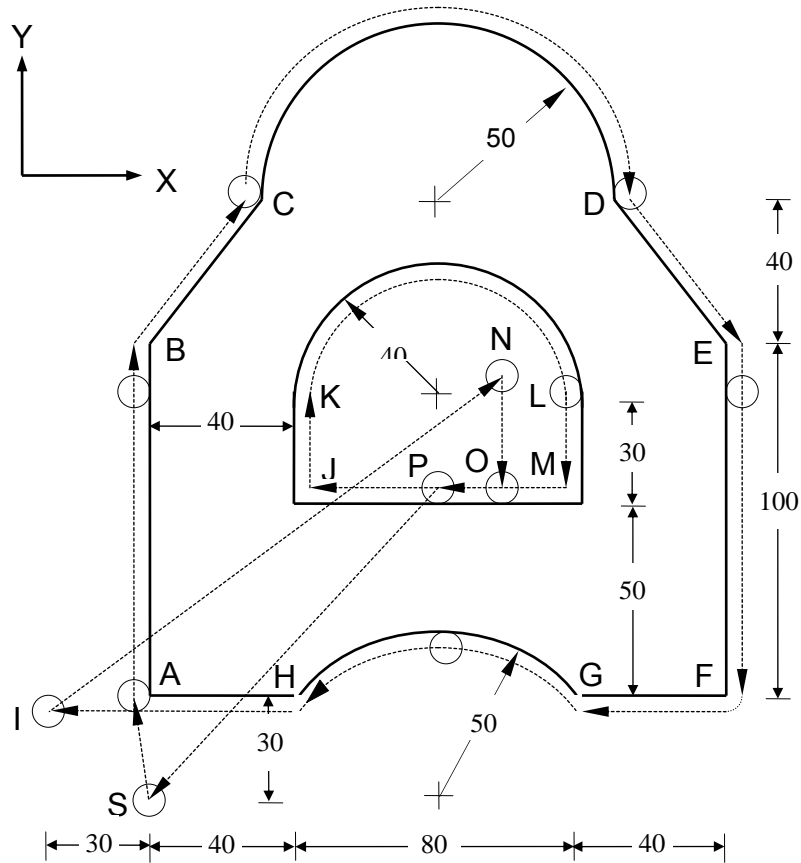

Fig 3-39 Programming examples

Programming Examples of Tool Radius Compensation:

N1 G91	... Incremental coordinates setting
N2 G01 Z-2.500 F150.	... Z-axis cutting by 2.5mm
N3 G17 F300.	... X-Y cutting plane setting
N4 G41 D10 Y30.000	... Point A, initial setting of tool radius compensation
N5 Y100.000	... Linear cutting from A~B
N6 X30.000 Y40.000	... Linear cutting from B~C
N7 G02 X100.000 I50.000	... Half-circle cutting from C~D
N8 G01 X30.000 Y-40.000	... Linear cutting from D~E
N9 Y-100.000	... Linear cutting from E~F
N10 X-40.000	... Linear cutting from F~G
N11 G03 X-80.000 R50.000	... Arc cutting from G~H
N12 G01 X-70.000	... Linear cutting from H~I
N14 Z2.500	... Z-axis rising by 2.5mm
N15 G40	... Compensation cancelled, ready for direction change

N16 M01	...	Program suspension.
N17 G0 X130. Y90. F200.	...	Positioning to N
N18 G01 Z-2.500 F150.	...	Z-axis cutting by 2.5mm
N19 G42 Y-40.000 F300.	...	Linear cutting from N~O Compensation direction change
N20 X-60.000	...	Linear cutting from O~J
N21 Y30.000	...	Linear cutting from J~K
N22 G02 X80.000 I40.000	...	Arc cutting from K~L
N23 G01 Y-30.000	...	Linear cutting from L~M
N24 X-60.000	...	Linear cutting from M~P
N25 Z2.500	...	Z-axis rising by 2.5mm
N26 G40 X-60.00 Y-80.00	...	Tool compensation cancelled; tool returning to S point.
N27 M02	...	Program end.

3.23.3 Tool length compensation ,G43,G44,G49

Tool length compensation is available for the position of Z-axis to correct the error of the tool length. The length compensation data up to 40 sets are stored in the tool length compensation. Refer to 3.3.9 for entering the length compensation data using G10.

Format:

G43(G44) Z_____ H_____	Length compensation setting
or G43(G44) H_____	Length compensation setting
G49	Length compensation <u>cancellation</u>

Z : Initial compensation coordinates

H : Tool number for which the length compensation is executed.

Explanation: Different tools are used for processing of work-pieces on a milling machine or machining center. Since the length is different among tools, the distance from the tool-tip to the work-piece varies to a significant extent. When the tool is changed during the execution of the program, the difference in the length of the tools before and after the change will cause an error in Z-axis. The purpose of the tool length compensation (G43/G44) is to correct the error of the

tool length along the Z-axis.

Length Compensation Setting:

Method 1: Manually move a tool downward from the machine origin of the Z-axis until it touches the surface of the work-piece. Measure the distance of the movement and enter the tool length compensation value for each tool number. Set the tool number required for compensation within the H value of the command format.

Method 2: Choose a tool via the operation interface of the controller and calibrate its length in the G54 work coordinate system. This tool will be used as a reference for determination of the length difference and compensation value of other tools.

When G43 is executed, the controller selects the specified compensation value and adds it directly to the Z-axis.

When G44 is executed, the controller selects the specified compensation value and adds it to the Z-axis for compensation after changing direction.

Compensation direction is defined based on the direction of the Z-axis. A positive compensation means that the tool moves positively along the Z-axis after compensation. A negative compensation means that the tool moves negatively along the Z-axis after compensation. The relationship between the compensation direction and the positive/negative value of the length compensation under the G43/G44 command is described as follows:

Fig 3-9

	MCM, positive value	MCM, negative value
G43	Positive compensation	Negative compensation
G44	Negative compensation	Positive compensation

```

EX1: N1 G00 Z0.000
      N2 G0 X1.000 Y2.000
      N3 G43 Z-20.000 H10 (Length compensation-3.000)
      N4 G01 Z-30.000 F200
      N5 G49 Z0.000
    
```

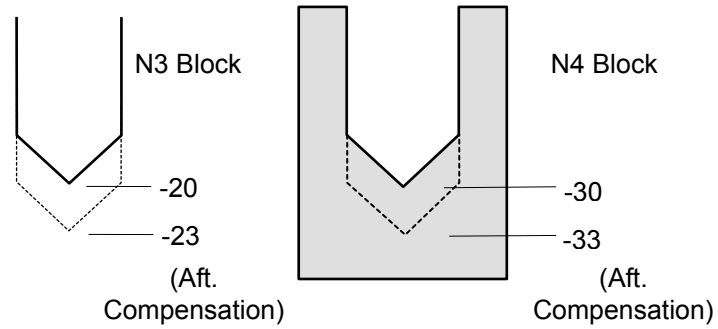

Fig 3-40

```

EX2: N1 G00 X-2.000 Y-2.000
      N2 G44 Z-30.000 H1 (Length compensation 4,000)
      N3 G01 Z-40.000
      N4 G49 Z0.000
    
```

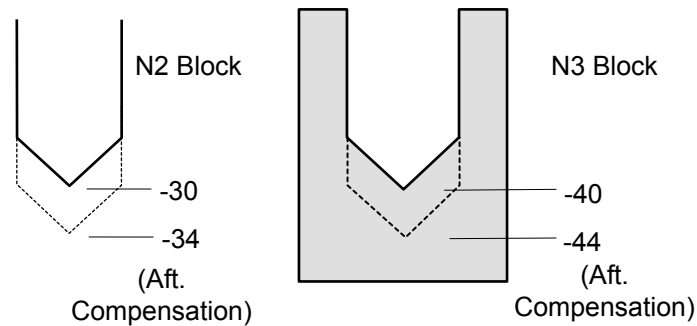

Fig 3-41

```

EX3: N0 G91
      N1 G00 X120.000 Y80.000
      N2 G43 Z-32.000 H01
      N3 G01 Z-21.000 F100.
      N4 G04 X2.000
      N5 G00 Z21.000
      N6 X30.000 Y-50.000
      N7 G01 Z-41.000
      N8 G00 Z41.000
      N9 X50.000 Y30.000
      N10 G01 Z-25.000
    
```

```

N11 G04 X2.000
N12 G00 Z57.000
N13 G49 X-200.000 Y-60.000
N14 M02

```

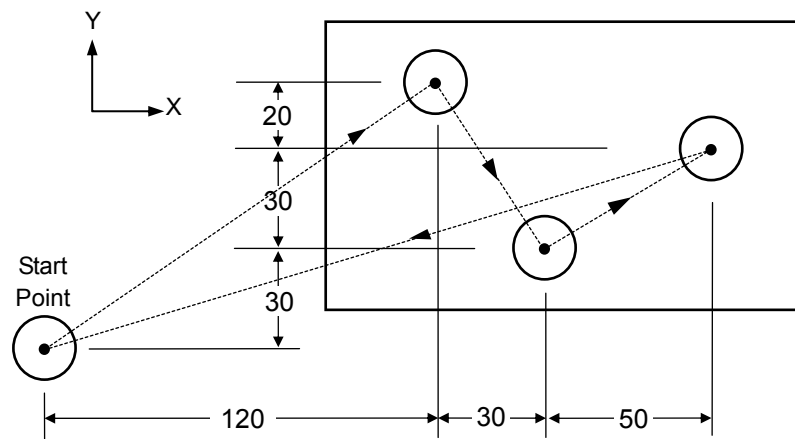

Fig 3-42

3.24 Local Coordinate System Setting , G52

Format:

```
G52 X___ Y___ Z___
```

Description:

If it is required to set another sub-coordinate system for the geometric shape of the Workpiece being processed under previous Working Coordinate System (G54..G59), then the said sub-coordinate system will be regarded as the Local Coordinate System.

G52 X0.0 Y0.0 Z0.0: Cancel Local Coordinate System

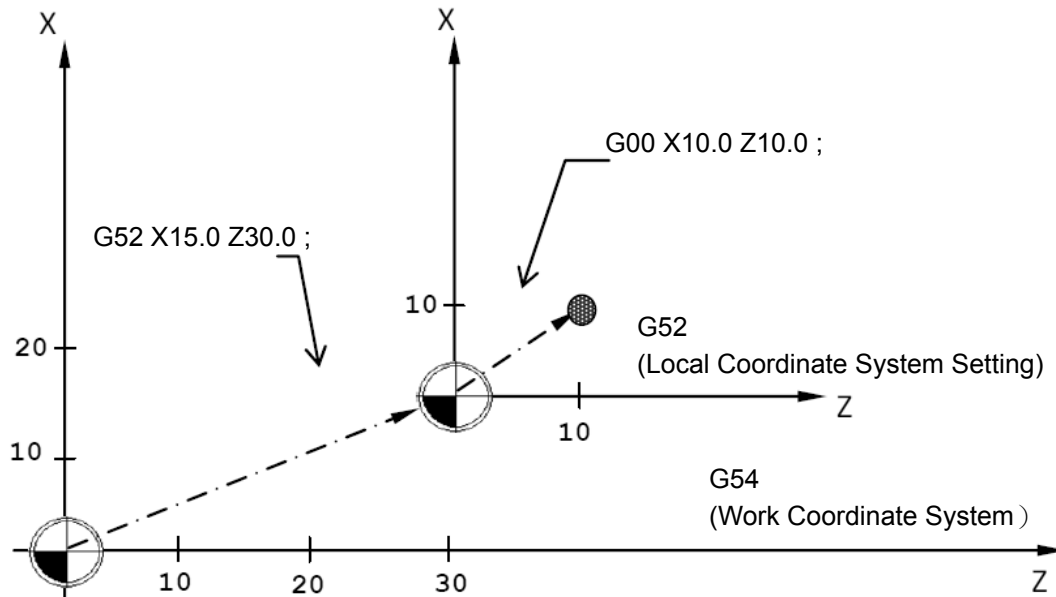

Fig 3-43

EX :

- G54 : Designate the Working Coordinate System as G54.
- G52 X19.0 Z30.0 : Designate Local Coordinate System to X15.0 Z30.0 position of the current working coordinate system.
- G00 X10. Z10 : Quickly move to X10.0 Z10.0 position of Local Coordinate System.
- G52 X0.0 Z0.0 : Cancel the Local Coordinate System setting.

Remark:

1. The Resume Signal will override the Local Coordinate System.
2. When switching G54_ _G59 Working Coordinate System, the Local Coordinate System will be cancelled.

3.25 Basic machine coordinate system , G53

Format :

G53 X__ Y__ Z__ A__ B__ C__ P0
 or G53 X__ Y__ Z__ A__ B__ C__

- X : X-axis moves to the designated Machine Coordinate X position with G00 speed.
- Y : Y-axis moves to the designated Machine Coordinate Y position with G00 speed.
- Z : Z-axis moves to the designated Machine Coordinate Z position with G00 speed.
- A : A-axis moves to the designated Machine Coordinate A position with G00 speed.
- B : B-axis moves to the designated Machine Coordinate B position with G00 speed.
- C : C-axis moves to the designated Machine Coordinate C position with G00 speed.

G53 X__ Y__ Z__ A__ B__ C__ P1

- X : X-axis moves to the designated Machine Coordinate X position with G01 speed of previous node.
- Y : Y-axis moves to the designated Machine Coordinate Y position with G01 speed of previous node.
- Z : Z-axis moves to the designated Machine Coordinate Z position with G01 speed of previous node.
- A : A-axis moves to the designated Machine Coordinate A position with G01 speed of previous node.
- B : B-axis moves to the designated Machine Coordinate B position with G01 speed of previous node.
- C : C-axis moves to the designated Machine Coordinate C position with G01 speed of previous node.

Description :

The Home Position of the machine is the fixed home position being set by the manufacturer when manufacturing the CNC machine and such Coordinate System belongs to a fixed system. When designated by G53 Command and coordinate command, the Tool will move to the position designated for the basic coordinate system of the machine. Soon as the Tool returns to zero point (0, 0, 0) of the machine, it means the Home Position of the machine's coordinate system.

Notice :

1. G53 Command will be valid for the designate node.

2. Before giving the G53 Command, the Tool offsetting must be cancelled (length, wearing, tip radius offsetting).
3. The command shall be valid under absolute value programming status, and will not avail under incremental value programming.

3.26 Work Coordinate System Setting , G54~G59

There are two coordinate systems for CNC machine tools. This section describes how to use these coordinate systems.

1. Machine Coordinate System (Home)
2. Work Coordinate System
 Work Coordinate System (G54~G59) --Set by To in MCM parameters
 (Recommended)

3.26.1 Machine Coordinate System (Home)

The origin of the machine coordinate system is fixed in the machine. When you press HOME from the control panel, the tool or machine table returns to the home limit switch, and detects the encoder GRID signal. When it locates the GRID, the tool stops. This location is the HOME position or Machine origin. The Machine origin is the calculation basis of all work and reference point coordinates. Its position is normally determined by the position of the travel-measuring rule on the machine table and the position of the over-travel limit switches (OTLS). Before any cutting, be sure to execute HOME to determine the position of the machine origin.

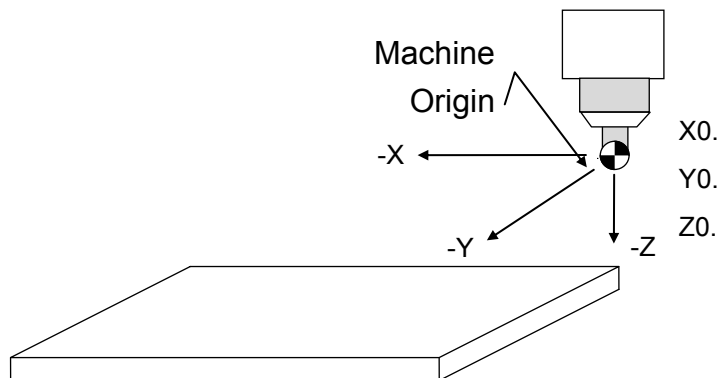

Fig 3-44 Machine Origin

Another origin may be required for cutting convenience. This origin is slightly shifted from the machine origin and, thus, is called HOME SHIFT. The shift amount is configured in MCM #183~385. When you execute HOME, the tool returns to the HOME position but the machine coordinate shows the shift value of MCM #381-385. If the shift value of MCM #183~385 is set to zero (0), the HOME SHIFT is the HOME position.

The methods to return to the HOME position are:

1. Manually return to the HOME position.
2. Use G28 or G30 to home the tools when the reference coordinates in MCM is set to zero for the X, Y, Z, A, B axes.

3.26.2 Work Coordinate System Setting ,G54~G59

H4D-M series provides 6 sets of work origins. The coordinate system comprising these work origins is called Work Coordinate System. The 6 sets of work origins are located relative to the position of the machine origin. Their coordinates are called machine coordinates and stored in MCM #1~120 Coordinate data can be entered via:

1. G10 command in the MDI mode
2. Direct modification in MCM mode
3. Manual jog mode

The application of these work origins in the program is executed by the G54~G59 command codes. Depending on processing requirements and programming, the user can select up to six sets of work origins to work with. The most advantage of this work coordinate system is to simplify the coordinate operation of the part program. See the following examples:

- G54 represents the work coordinate system using MCM #1~6.
- G55 represents the work coordinate system using MCM #21~26
- G56 represents the work coordinate system using MCM #41~46
- G57 represents the work coordinate system using MCM #61~66
- G58 represents the work coordinate system using MCM #81~86
- G59 represents the work coordinate system using MCM #101~106.

Fig 3-45 shows the association of the G54~G59 work coordinate system with the

6 settings in the first item of MCM parameters. These coordinate parameters are determined depending on the machine origin. The G54-G59 work origin parameter settings are described as follows. (The XY drawing is used for illustration.)

- G54 work coordinate system using MCM #1~6 with a setting of X-70,000, Y-10,000
- G55 work coordinate system using MCM #21~26 with a setting of X-80,000, Y-30,000
- G56 work coordinate system using MCM #41~46 with a setting of X-80,000, Y-50,000
- G57 work coordinate system using MCM #61~66 with a setting of X-70,000, Y-50,000
- G58 work coordinate system using MCM #81~86 with a setting of X-40,000, Y-60,000
- G59 work coordinate system using MCM #101~106 with a setting of X-20,000, Y-40,000

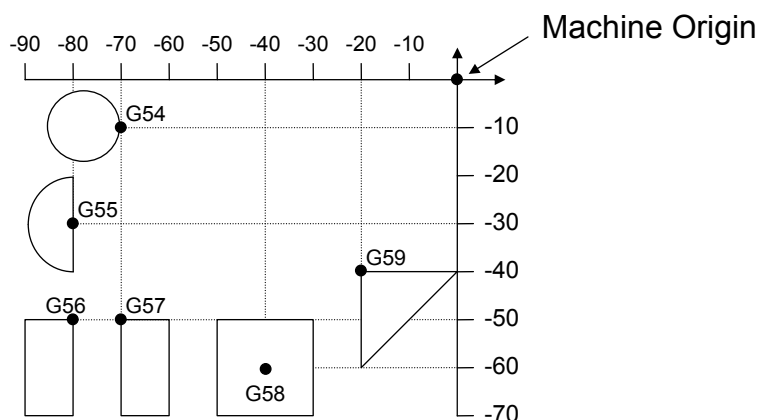

Fig 3-45 G54~G59 Work Coordinate System

Note that the program coordinates are changed when the work coordinate system is selected. The changed coordinates are determined based on the selected work coordinate system. When the action of cutting a circle or semi-circle is added to the above program, the application of G54 and G55 can be illustrated as follows. (Fig. 3-46)

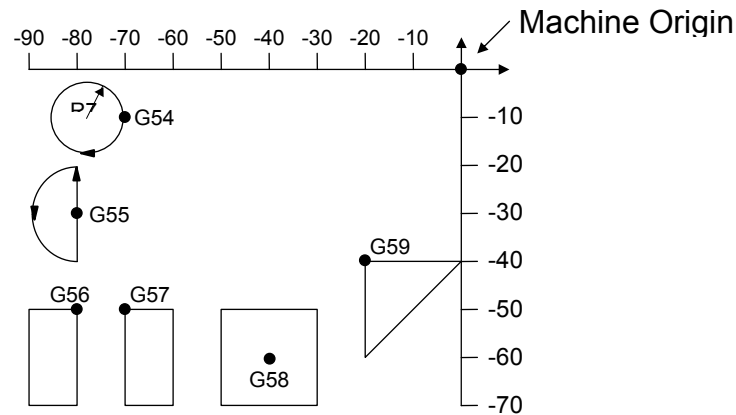

Fig 3-46 G54~G59 Applications

Ex: Application of G54 and G55

N1 G0	... Feed-rate set to fast move mode
N2 G54 X0. Y0.	... Set to program coordinates X0, Y0 (machine coordinates X-70.,Y-10.)
N3 G2 I-7.0 F200.0	... Cut a circle in CW with R=7.0
N4 G0	... Feed-rate set to fast move mode
N5 G55 X0. Y0.	... Move to coordinates X0, Y0 of the second work-piece (Machine coordinates X-80.,Y-30.)
N6 G1 V10.0 F300.	... Y-axis feeding (incremental command) travels to +10.0
N7 G3 V-20.0 R10.0 F300.	... Cut a semi-circle in CCW with R=10.0
N8 G1 V10.0 F300.	... Y-axis feeding (incremental command) travels to +10.0
N9 G28	... If the first reference point = 0, the program backs to the machine origin.
N10 M2	... Program end

1. Power-on default is the G54 work coordinate system.
2. The work coordinate system is selected by executing G54~G59. If the X, Y, Z coordinates after executing the command are zero, the tool moves to the origin of the work coordinate system. If the X, Y, Z coordinates after executing the command are not zero, the tool moves the position corresponding to the X, Y, Z coordinates of the work coordinate system.
3. After executing G54~59, the machine coordinates of the work origin changes along with the setting of new coordinates.

3.27 Mirror Effect Cutting , G68 , G69

Format:

G68 -- X-axis mirror-effect cutting, with Y-axis as the mirror
 G69 -- Y-axis mirror-effect cutting, with X-axis as the mirror

Mirror-effect cutting uses a subprogram (referring to the last section of this chapter) to design a cutting pattern, and then executes G68 and G69 to accomplish the mirror-effect cutting, as shown in Fig 3-47.

G 68 and G69 are used as a single program block in application. The sign of the X-coordinates behind the G68 block is inverted (+ changes to -, - changes to +) by executing G68 while the Y-coordinates are not affected. The sign of the Y-coordinates behind the G69 block is inverted by executing G69 while the X-coordinates are not affected. Therefore, all you need to do to cut the pattern of Fig 3-47 is to write a subprogram for pattern 1, then execute G68 and G69 for cutting patterns 2, 3, and 4. The program is written as follows:

```

M98 P___    -- Cut pattern 1 (P___ subprogram code)
G68         -- Invert the sign of X-coordinates behind G68 block
M98 P___    -- Cut pattern 2 (P___ subprogram code)
G69         -- Invert the sign of Y-coordinates behind G69 block
M98 P___    -- Cut pattern 3 (P___ subprogram code)
G68         -- Invert the sign of X-coordinates behind G68 block
M98 P___    -- Cut pattern 4 (P___ subprogram code)
G69         -- Invert the sign of Y-coordinates behind G69 block.
M02
  
```

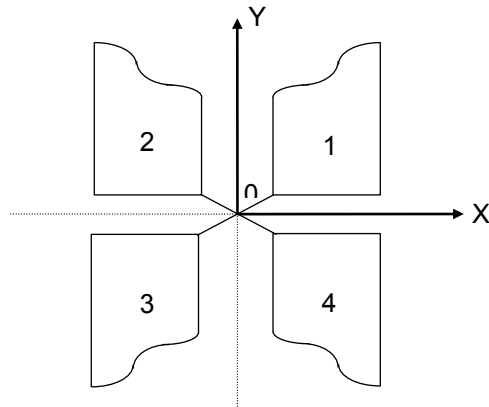

Fig 3-47 Mirror-effect Cutting

Note that G68 and G69 are modal G-codes.

Whenever G68 or G69 is executed: $+X \rightarrow -X$ or $+Y \rightarrow -Y$

When G68 or G69 is executed next time: $-X \rightarrow +X$, or $-Y \rightarrow +Y$

Thus, if only patterns 1 and 2 need to be cut, G68 must be executed again to restore the sign of X-coordinates, as described below:

```

M98 P___    -- Cut pattern 1 (P___ subprogram code)
G68         -- Invert the sign of X-coordinates behind G68 block
M98 P___    -- Cut pattern 2 (P___ subprogram code)
G68         -- Invert the sign of X-coordinates behind G68 block
M02

```

The RESET key can also cancel mirror-effect cutting. During mirror-effect cutting, the "X-MIRROR" or "Y-MIRROR" is shown at the top of the CRT screen. The display disappears when the mirror-effect cutting is canceled.

3.28 Absolute and Incremental Coordinate Settings , G90 , G91

The absolute and incremental coordinate can be set via the following two approaches:

1. Mode -- Use G90 and G91 commands to specify a mode.
2. Incremental bit-code -- Use U.V.W commands to specify an incremental bit-code. (Refer to Chapter II)

Mode specification format:

G90 Absolute coordinates setting
 G91 Incremental coordinates setting

The absolute coordinates system is the default power-on of the H4D-M Series. Use G90 and G91 to set the absolute or incremental coordinates in the program. The incremental bit-code U,V,W are only valid in the G90 status. They are invalid in the G91 status. X, Y, Z stand for incremental coordinates in the G91 status.

Ex 1: Setting absolute coordinates (Fig. 3-48)

```

N1 G90
N2 G1 X20.000 Y15.000      ....P0 to P1
N3 X35.000 Y25.000        ....P1 to P2
N4 X60.000 Y30.000        ....P2 to P3
    
```

Ex 2: Setting incremental coordinates (Fig 3-48)

```

N1 G91
N2 G1 X20.000 Y15.000      ....P0 to P1
N3 X15.000 Y10.000        ....P1 to P2
N4 X25.000 Y5.000         ....P2 to P3
    
```

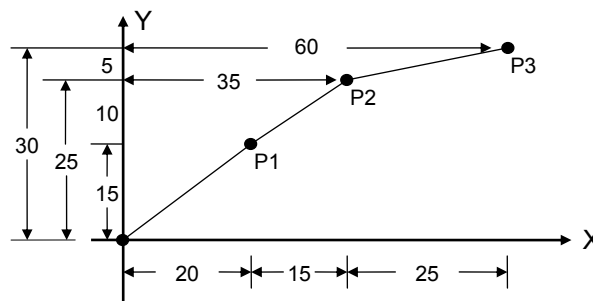

Fig 3-48 G90 , G91 Example

3.29 Canned cycle Functions , G81~G89 , G80 (H4D-M / H6D-M only)

These G-code commands are for the H4D-M milling machine only, and NOT for other HUST CNC controllers.

H4D-M provides a number of canned cycle cutting functions for processing. They form a command group and are executed using a specified G-code. The H4D-M series provides several canned cycle functions to simplify program

design. The cutting sequence controlled by the canned cycle command group of H4D-M is illustrated in Fig. 3-49 below.

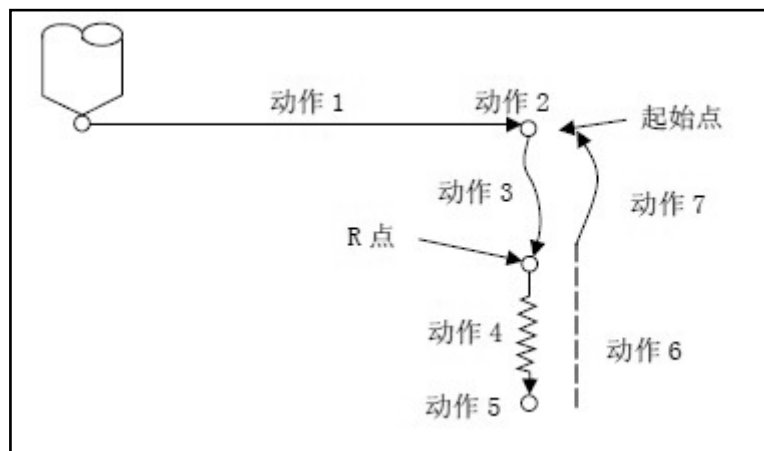

Fig 3-49 Canned Cycle Cutting Sequence

1. Step 1: Fast positioning to the start (S) point on X-Y plane.
2. Step 3: Fast positioning to the reference point for drilling start (R) along Z-axis.
3. Step 4: Hole drilling to at the bottom (Z) along the Z-axis.
4. Step 5: Mechanical action at the hole bottom – tool waits or spindle rotation reverses.
5. Step 6: Drill bit retracted to R-point. The moving speed depends on the command specified.
6. Step 7: Move back to the start point S at G00 feed-rate.

When applying the canned cycle function, M03 is used for normal spindle rotation, M04 is used for reverse spindle rotation, and M05 is used for spindle stop.

Basic Format For Canned Cycle Functions:

```
G90 or G91
G98
G81~G89 X___Y___Z___P___Q___D___R___F___K___
G80 or G00 or G01
```

Explanation

X, Y : Specify absolute or incremental coordinates for the hole.

- Z : Specify absolute or incremental depth or coordinates for the hole.
- P : Dwell at the hole bottom. Unit: ms; i.e. 1000 stands for one second.
- Q : G83 amount of feed for each cut, in μm .
- D : Retract amount whenever peck drilling or peck tapping.
- R : Specify the absolute or incremental coordinates of R-point. R is the reference point of feeding/retraction.
- F : Feed-rate setting.
- K : Processing repetition setting.

During the drilling operation, parameters such as specified drilling mode (such as G81, G82, and so on), feeding/retraction reference point, and hole depth or coordinates (Z) are mode codes. They will not change before other command codes of the same group are set up. The single block command of each basic format with respect to the canned cycle function is described in detailed below.

3.30 Canned Cycle Commands , G80 , G81~G89

Definition of each parameter for canned cycle commands has been described above. The work-piece cutting application of G80~G89 is tabulated in Table 3-10.

Table 3-10 G80~G89 Work-piece Cutting Application

G- code	Application	Drill Rate	Action at Bottom	Retraction Rate
G80	Cycle canceled	---	----	---
G81	Drilling Canned Cycle	G01 Feed rate	---	G00 Fast
G82	Drilling Canned Cycle	G01 Feed rate	Dwell	G00 Fast
G83	Deep Hole Drilling (peck drill)	G01 Feed rate	---	G00 Fast
G84	Steel threading	G01 FeedRate		G01 Feed
G85	Boring Canned Cycle	G01 Feed rate	---	G01 Rate
G86	Boring Canned Cycle	G01 Feed rate	Master axis stop	G01 Fast
G89	Boring Canned Cycle	G01 Feed rate	Dwell	G01 Rate

3.31 G80 Cancellation of Canned Cycle

All canned cycle commands are cancelled by executing G80, G00 or G01.

3.32 G81 Drilling Canned Cycle

Format:

G81 Xx1___Yy1___Zz1___Rr1___Ff1___

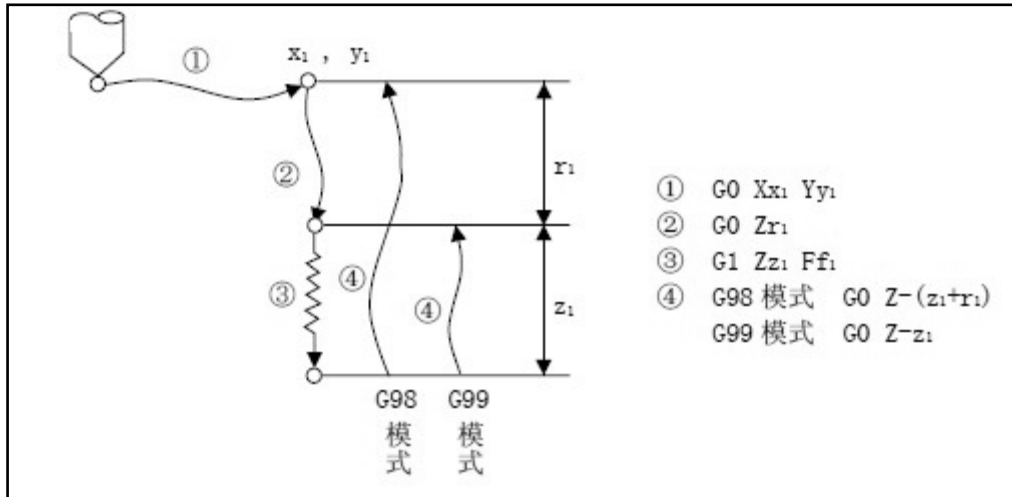

Fig 3-50 G81 Drilling Canned Cycle

EX :

```

M3 S500
G1 Z10.
G81 X10. Y10. Z-20. R0. F500
X0.
G80
M5
M30

```

3.33 G82 Drilling Canned Cycle

Format:

G82 Xx1___ Yy1___ Zz1___ Pp1___ Rr1___ Ff1___

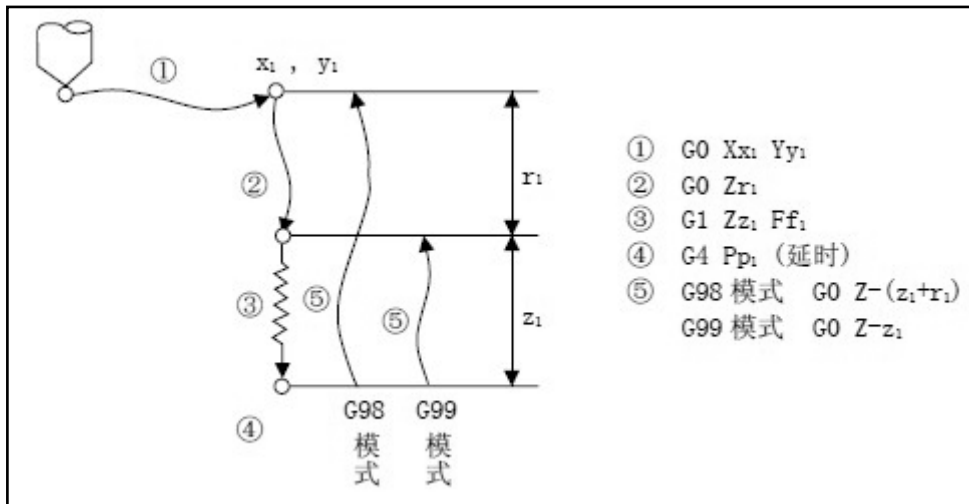

Fig 3-51 G82 Drilling Canned Cycle

EX :

```
M3 S500
G1 Z10.
G82 X10. Y10.Z-20.R0.P2000 F500
X10.
G80
M5
M30
```

The difference between G81 and G82 is that G82 has a wait time (P) before retraction when the drill bit reaches the bottom. The wait time (P) is input as an integer in milliseconds.

3.34 G83 Deep Drilling Canned (Peck drill) Cycle

Format:

G83 Xx1___ Yy1___ Zz1___ Qq1___ Rr1___ Ff1___ Dm___

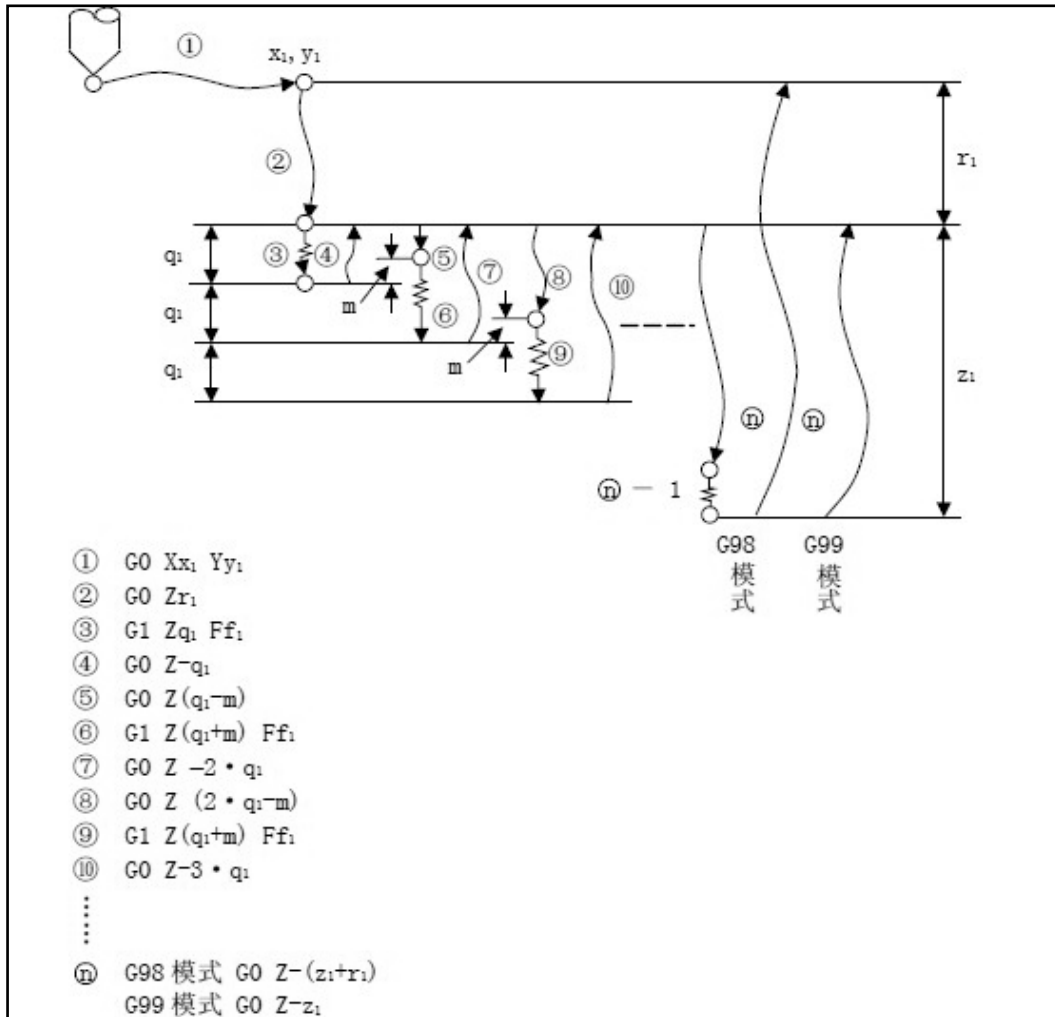

Fig 3-52 G83 Deep Drilling Canned (peck drill) Cycle

EX :

```
M3 S500
G1 Z10.
G83 X10. Y10. Z-20. R0. Q10000 D2000 F500
X10.
G80
M5
```

M30

In Fig. 3-52, Q is the depth of each drilling and d is the reservation for the change of the feed-rate from G00 to G01 after the second feeding. This data is set in MCM parameter #532. (The d value can be changed in the graphics input form.)

3.35 G84 Rigid Tapping

Format:

G84 Xx1___Yy1___Zz1___Pp1___Qq1___Dm___Rr1___Ff1___

- X, Y : Tapping points (absolute coordinates); the U and W incremental coordinates can also be used.
- Z : Hole bottom position during tapping
- R : Point R
- Q : Cutting amount per peck drilling and tapping (incremental value specified)
- F : Tapping pitch, the feed amount of Z axis per spindle revolution
- P : Dwell time at hole bottom
- D : Rigid tapping without full retract, each retract amount

- ★ When G84 is running, the **Dwell Command** and Hand Wheel Test Mode are disabled. Auto tapping is enabled, and **spindle speed and cutting speed are set to 100%**.
- ★ For tapping, the spindle positioning function shall be used. **If there is no encoder feedback for the spindle, do not use this function.**
- ★ **Confirm that the spindle settings, parameters, and feedback are correct before tapping.**
- ★ For rigid tapping, Q indicates the depth per tapping while d indicates to the retract distance when the retract settings are enabled. The feed (retract) rate is determined by the rotational speed; the retract type and distance is determined by the parameters; and the **F value indicates pitch in 0.001mm.**
- ★ Enter Page 4 of parameter settings to set the retract type and retract distance (d).
- ★ **When value Q is used to set the travel of <R-Z>, the travel shall be a continuous one.**

★ If you use the **inverter spindle** and its positioning is controlled via external signals, its input point and outputs point must be configured and PLC must be programmed. Contact the dealer or us for assistance.

Single tapping type; the inverter spindle and servo spindle are available for tapping.

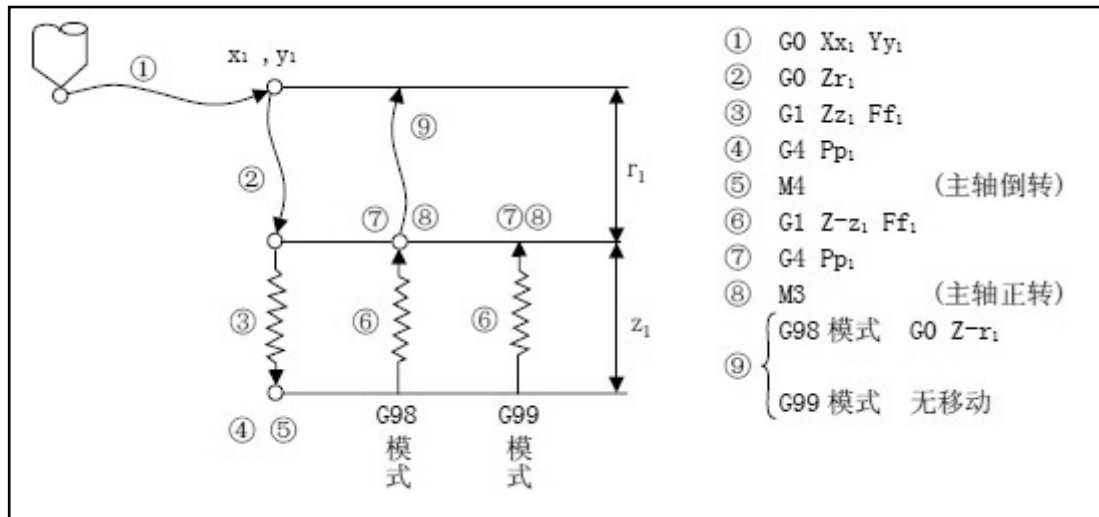

Fig 3-53-1 Tapping, G84

Peck drilling and tapping; only the servo spindle is available for rigid tapping.

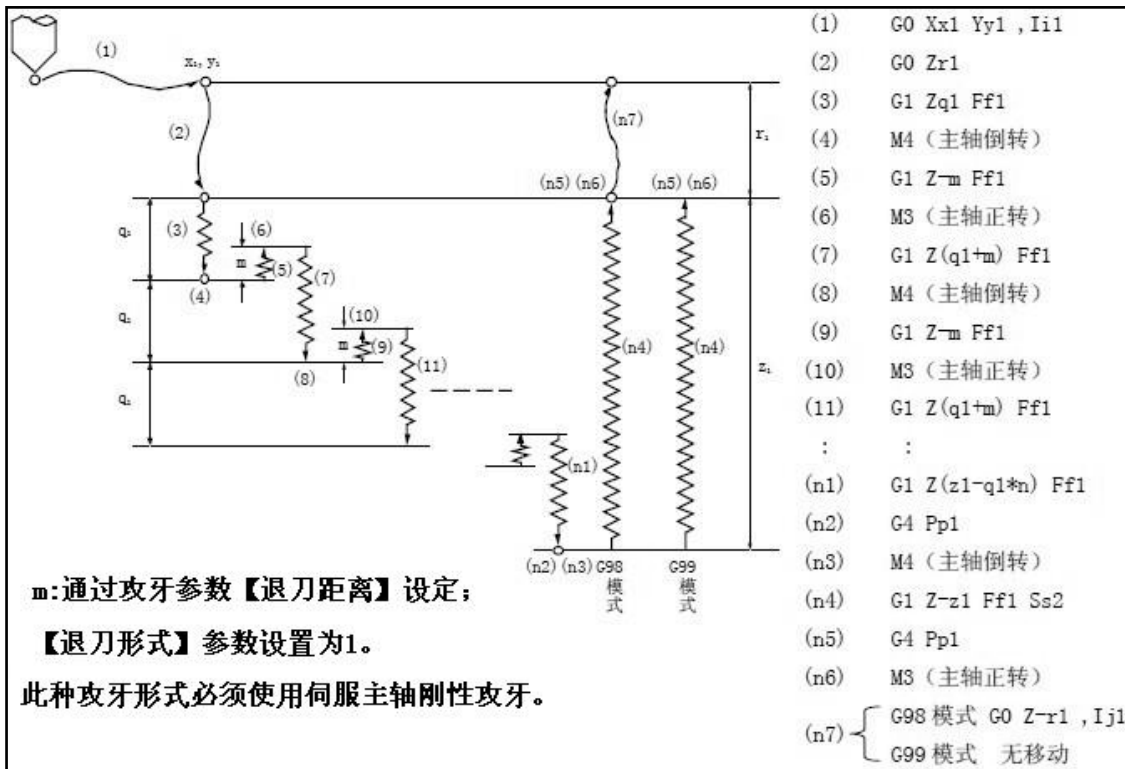

Fig. 3-53-2 Rigid Tapping, G84

Peck drilling and tapping; the inverter spindle and servo spindle are available for tapping.

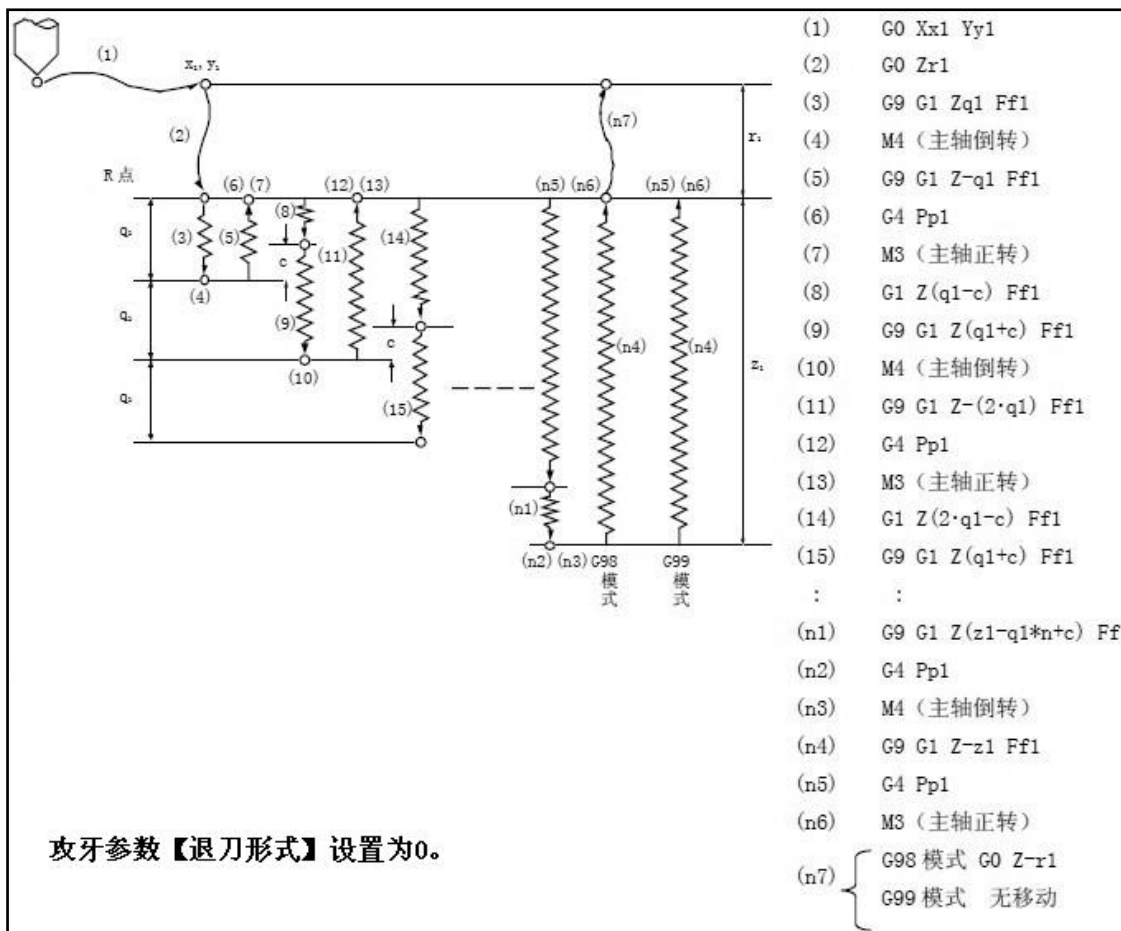

Fig. 3-53-3 Tapping, G84

EX :

```

M3 S500
G1 Z10.
{ G84 X10. Y10.Z-20.R0.P500 F500 <---Fig. 3-41-1 攻牙方式
  G84 X10. Y10.Z-20.R0.Q10000 D2000 F500 <---Fig. 3-41-2 攻牙方式
  G84 X10. Y10.Z-20.R0.Q10000 F500 <---Fig. 3-41-3 攻牙方式
X10.
G80
M5 S0
M30
    
```

3.36 G85 Boring Canned Cycle

Format:

G85 Xx1___ Yy1___ Zz1___ Rr1___ Ff1___

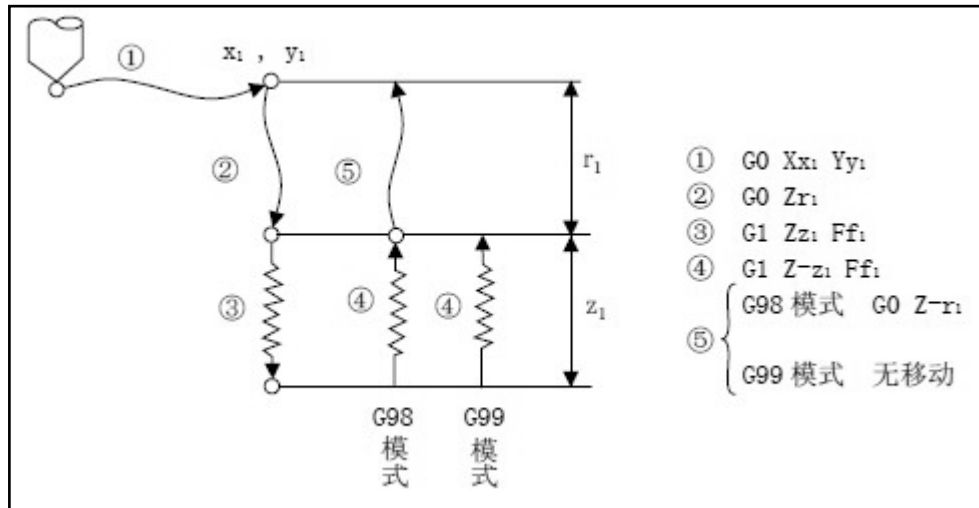

Fig 3-54 G85 Boring Canned Cycle

EX :

```
M3 S500
G1 Z10.
G85 X10. Y10. Z-20. R0. F500
X10.
G80
M5
M30
```

3.37 G86 Boring Canned Cycle (Spindle Stop at Home Bottom)

Format:

G86 Xx1___ Yy1___ Zz1___ Rr1___ Ff1___

The difference between G85 and G86 is that the G86 spindle stops before retraction when the drill bit reaches the hole bottom.

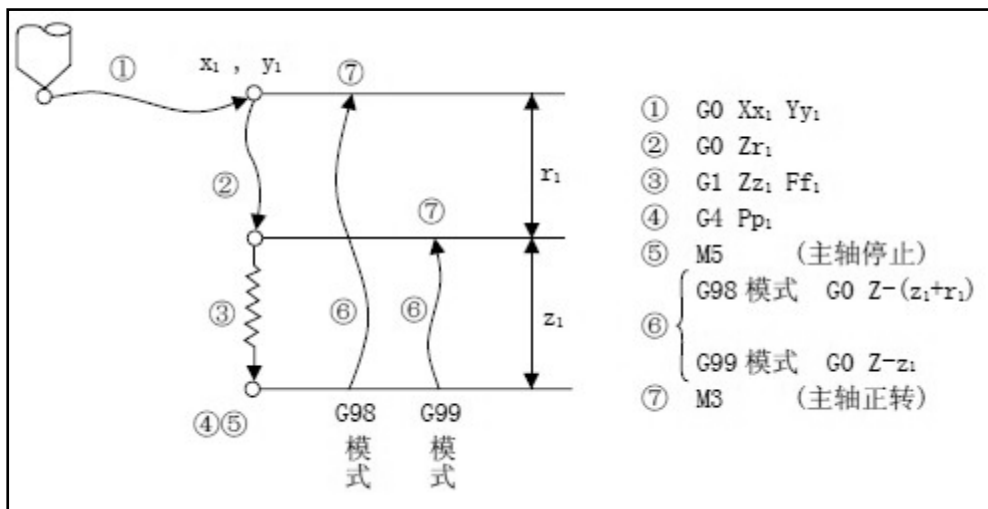

Fig 3-55 G86 Boring Canned Cycle

EX :

```

M3 S500
G1 Z10.
G86 X10. Y10. Z-20. R0. F500
X10.
G80
M5
M30
    
```

3.38 G89 Boring Canned Cycle with Dwell at Hole Bottom

Format:

G89 Xx1___ Yy1___ Zz1___ Pp1___ Rr1___ Ff1___

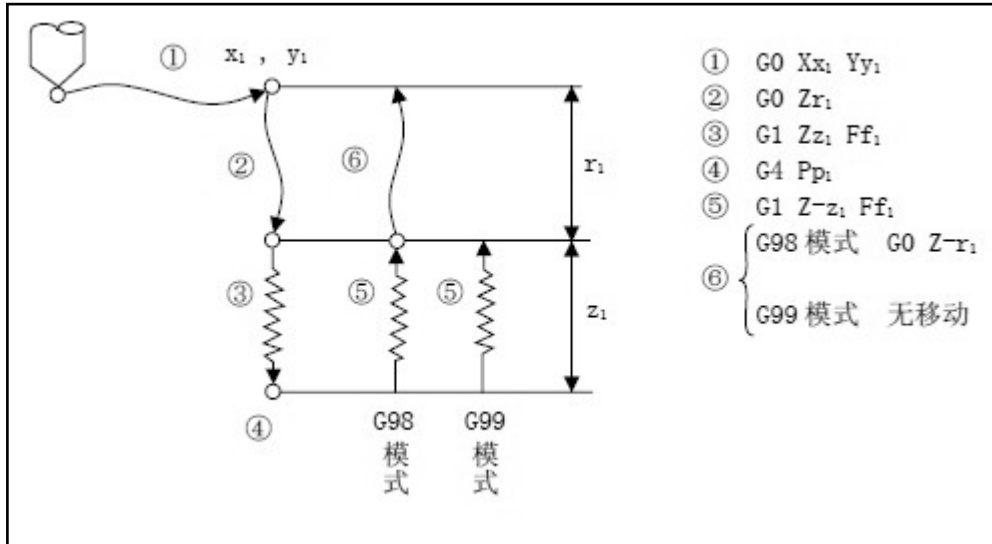

Fig 3-56 G89 Boring Canned Cycle

The difference between G85 and G89 is that G89 has a wait time (P) before retraction when the drill bit reaches bottom. The wait time (P) is input as an integer in milliseconds.

EX:

```
M3 S500
G1 Z10.
G89 X10. Y10. Z-20. R0. P2000 F500
X10.
G80
M5 S0
M30
```

Special Canned Cycle

The special canned cycle should be used in conjunction with canned cycle commands (G81~G89).

Before using the special canned cycle, the commands should be used to specify the hole processing data.

If no hole processing data is specified by Executing the canned cycle commands, the special canned cycle command only provides the positioning function without drilling.

Tools travel between holes at the highest speed (G00).

3.39 G34 Circular Drilling Canned Cycle

Format:

G34 X__Y__ I__J__K__F__

- X : Center coordinates
- Y : Center coordinates
- I : Radius of circle r
- J : Angle of the first hole $-\theta$
- K : The amount of circular holes – n
- F : Drilling speed

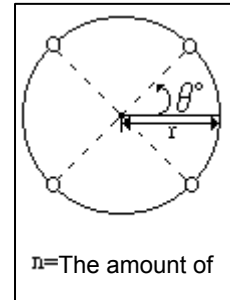

EX :

N001 G81 Z-100. R-50.K0 F100 ←Definition of drilling resource

N002 G34 X100. Y100. I50. J45. K4

N003 G80 ←Canned cycle command canceled

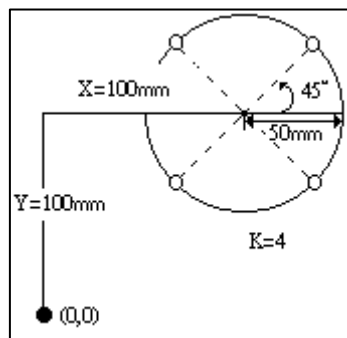

3.40 G35 Angular Linear Drilling Canned Cycle

Format:

G35 X__Y__ I__J__K__F__

- X : Start point coordinate
- Y : Start point coordinate
- I : Drilling distance d
- J : Angle – θ
- K : The amount of linear holes – n
- F : Drilling speed

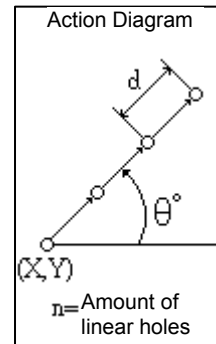

EX :

N001 G81 Z-100. R-50.K0 F100 ←Definition of drilling data
 N002 G35 X100. Y100. I50. J45. K4
 N003 G80 Canned cycle command canceled

3.41 G36 Arc Drilling Canned Cycle

Format:

G36 X__Y__ I__J__P__K__F__

- X : Center coordinate
- Y : Center coordinate
- I : Circle radius
- J : Angle of the first hole – θ
- P : Angle of each drilling
- K : The number of arc holes
- F : F Drilling speed

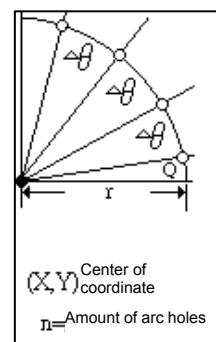

EX :

N001 G81 Z-100. R-50.K0 F100 ←Definition of drilling data
 N002 G36 X100. Y100. I50. J10.P30. K4
 N003 G80 ←Canned cycle command

3.42 G37 Grid Drilling Canned Cycle

Format:

G37 X__Y__ I__P__J__K__F__

- X : Start point coordinate
- Y : Start point coordinate
- I : X-axis space
- P : Drilling Numbers of X-axis
- J : Y-axis space
- K : Drilling Numbers of Y-axis
- F : Number of grid holes

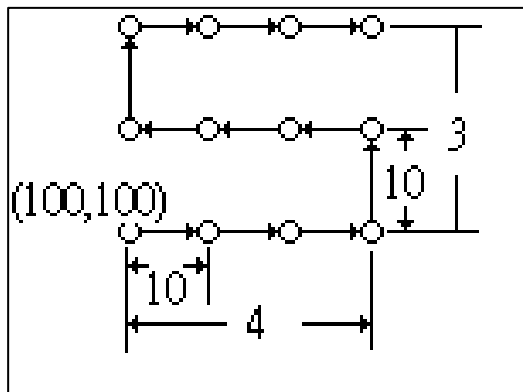

Example:

```

N001 G81 Z-100. R-50.K0 F100      ←Definition of drilling data
N002 G37 X100. Y100. I10.P4 J10. K3
N003 G80                          ←Canned cycle command canceled
    
```

3.43 G90 or G91 – Absolute or Incremental Coordinates Setting

These commands were described in the previous section. In the canned cycle program, R and Z are coordinates relative to the zero point of Z-axis in the absolute coordinates system, while Z is an incremental coordinate relative to R-point in the incremental coordinates system. Though the R and Z coordinates remain unchanged in the program, their displacement coordinates are different (Fig. 3-57) when executing different commands (G90/G91).

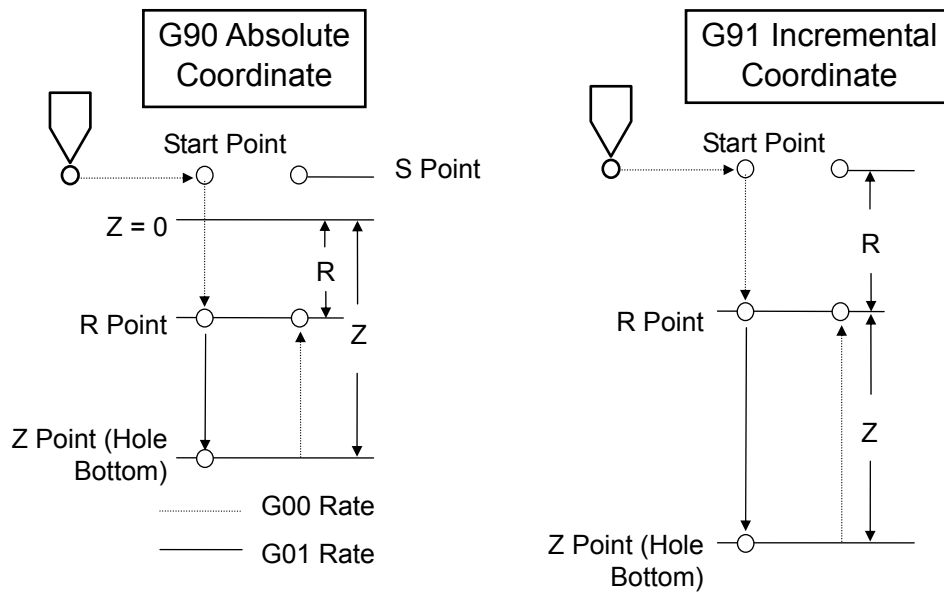

Fig 3-57

3.44 G94 or G95 – Feedrate setting

G94: Feed per minute (mm/min)

G95: Feed per revolution of master axis (mm/rev)

FeedRate of H4D-M miller, F , is defined by G94 and G95, where G94 is for start up. Conversion between the two is:

$$F_m = F_r * S$$

F_m : Feed-rate per minute, mm/min

F_r : Feed-rate per revolution, um/rev

S : Spindle speed, rev/min.

3.45 G98 or G99 – Cutting Feed-rate Setting

G98 : Feed-rate per minute, mm/min

G99 : Feed-rate per revolution, mm/rev

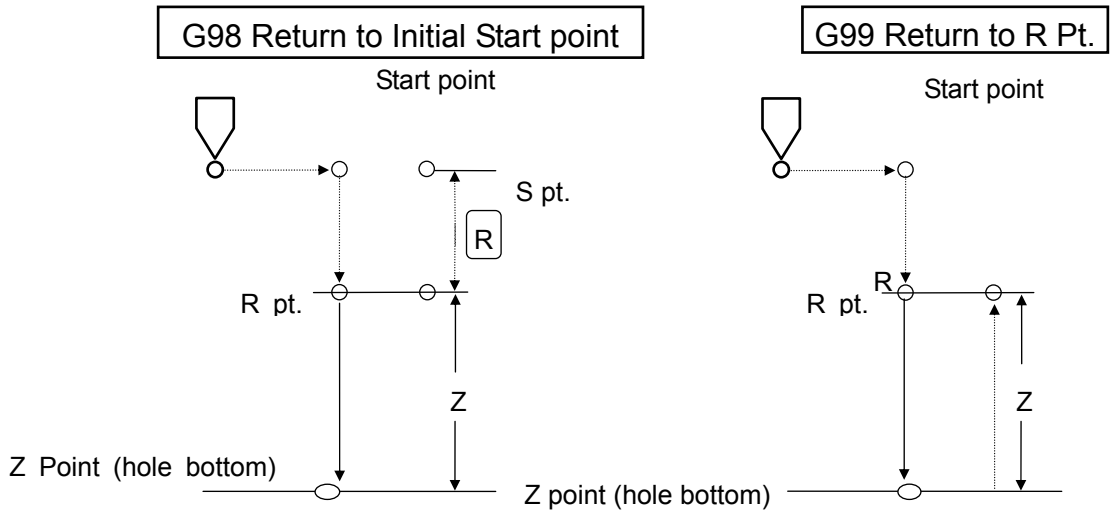

Fig 3-58

EX :

M3 S1000	; Master Axis forward revolution
G00 X10.Y10.Z10.	; Set to initial point
G99	; G99 reset
G81 X10. Y10.Z-30.R0.Q10.F500	; G81 1st point in drill cycle (back to R)
X20.Y20.	; 2nd point (back to R)
X30.	; 3rd point (back to R)
G98 X40.	; 4th point (back to initial point)
G80	; end of drill cycle
M5 S0	; Master axis stopped
M30	; end of program

3.46 Auxiliary Function,M-code,S-code

The auxiliary function M-code (referred to as M-code) consists of a capital letter M followed by a 2-digit number. The M-code ranges 00~99 and each code represents a different action. The following M-codes are used by H4D-M system and no customers are allowed access.

M00 Program Stop.

When the program runs to this point, all processing actions stop, including spindle and coolant. Press the "CYCST" key to restart the program from where it stopped.

M01 Optional Stop.

See more details in Sec.6 of Chap 8.

M02 Program End.

M30 Program Finished.

The program finishes at this point and returns to the start point.

M98 Subprogram Call.

M99 Subprogram End.

Except for the above M-codes that cannot be changed, customers may define other M-codes in the PLC if required. Examples of some general settings are shown below. These examples are also parts of the H4D-M standard PLC Ladder.

M03 Spindle rotation in normal direction.

M04 Spindle rotation in reversed direction.

M05 Spindle rotation stops.

M08 Coolant ON.

M09 Coolant OFF.

The auxiliary function S-code is used to control the rpm of the spindle. The maximum setting is S999999.

Ex: S1000 means that the spindle rotates at 1000 rev/min

3.47 Subprogram

If there are some program or command groups requiring repeated execution, you can store these program or command groups in memory as a subprogram. This can simplify the design of the program and make the structure of the main program more succinct. The subprogram can be executed during automatic operation and a subprogram can call another subprogram.

3.47.1 Subprogram Structure

The structure of the subprogram is pretty much the same as the main program except that the subprogram ends with M99.

```
PROGRAM 05      . . . . . Subprogram code
                  . . . . . Program content
```

3.48 Customized program Group [MACRO] Command G65

G65 can be used to do some mathematical operations as shown in Table 3-12. It can be applied in the main or sub-program or it can be formed as an independent group of program, to be called upon (M98) from a main program. If you become a master of it, its application is unlimited.

G65 Format: G65 Lm P#i A#j B#k

L, P, A, B : Mathematical command codes in capital letters for G65.

- m : 'm' is an integer ranging 1~99. 'Lm' represents mathematical operation codes, such as L2 for addition (+), L3 for subtraction (-), L4 for multiplication (*), etc. See Table 3-3 for all 'Lm' definitions.
- #i : User defined **variables**, ranging #1~#9999, which are saved when power-off. Variables #10000 and above are controller system variables which you can call out for use but can not change their contents.
1. **P#i** is the location to store the result of mathematical operation. For example P#10=A+B, the result of A+B is stored as variable #10.
 2. **Pi** (when 'i' is used without a '#' sign) represents the block number for the program execution to branch to if the logic operation is true.
- #j : Mathematical operand 1. It can be used as either a constant without a '#' sign, i.e. A10, or a variable with a '#' sign, i.e. A#2.
1. **A#j** represents a variable number ranging 1 ~ 9999.
 2. **Aj** (when 'j' is used without a '#' sign) represents a constant ranging from "-" 9999999 to "+" 9999999.
- #k : Mathematical operand 2. It can be used as either a constant without a '#' sign, i.e. B15, or a variable with a '#' sign, i.e. B#7.
1. **A#k** represents a variable number ranging 1 ~ 9999.
 2. **Ak** (when 'k' is used without a '#' sign) represents a constant ranging from "-" 9999999 to "+" 9999999.

More Explanations for Variables:

1. Variable #i

#1~#9999 : User defined **variables**, which are saved when power-off.

#10000> : Variables #10000 and above are controller system variables which you can call out for use but can not change their contents.

2. All variables '#i, #j, #k' must be integer. '#i' must be positive (+). '#j, #k' can be (+) or (-). If it is negative (-), it means the content value of the variable is reversed before operation.

Ex: If variable #2 = 99, the operation “G65 L01 P#1 A-#2” will result in #1 = -99.

Ex: If variable #2 = 25, #3 = 5, the operation “G65 L04 P#1 A#2 B-#3” will result in #1 * -#3 = -125.

3. The content values of #j, #k must be integer (max 7 digits, + or -). The input unit is depending on decimal format in effect. Refer to Sec. 6.5.

Table 3-11

Decimal Point	1 (6/1 format)	2 (5/2 format)	3 (4/3 format)	4 (3/4 format)
Unit	100μm	10μm	1μm	0.1μm
250	25000μm	2500μm	250μm	25μm

Table 3-12 Mathematical Operator Definitions For HUST G65 Command

G-code	L-code	L-code Function	Mathematical Definitions
G65	L1	Equal, Substitution	$\#i = \#j$
G65	L2	Addition	$\#i = \#j + \#k$
G65	L3	Subtraction	$\#i = \#j - \#k$
G65	L4	Multiplication	$\#i = \#j \times \#k$
G65	L5	Division	$\#i = \#j / \#k$
G65	L6	Place Data into Variables	$\#i = \#j$
G65	L7	Copy Variables	
G65	L11	Logic OR	$\#i = \#j .OR. \#k$
G65	L12	Logic AND	$\#i = \#j .AND. \#k$
G65	L13	Logic exclusive XOR	$\#i = \#j .XOR. \#k$
G65	L14	ROL, rotate to left	
G65	L15	ROR, rotate to right	
G65	L16	LSL, shift to left	
G65	L17	LSR, shift to right	
G65	L21	Square Root	$\#i = \sqrt{\#j}$
G65	L22	Absolute	$\#i = \#j $
G65	L23	Remainder	$\#i = \#j - \text{trunc}(\#j/\#k) \times \#k$ trunc:(Discard result that is less than 1)
G65	L26	Combined Mul/Div Operation	$\#i = (\#i \times \#j) / \#k$
G65	L27	Root of the sum of square	$I = \sqrt{I^2 + J^2}$
G65	L28	Root of the difference of square	$I = \sqrt{I^2 - J^2}$
G65	L30	Conversion of setting length to numbers of circle (round shape)	$\frac{-b + \sqrt{b^2 - 4ac}}{2a}$
G65	L31	Sine of an angle (Sin)	$\#i = \#j \times \text{Sin} (\#k)$
G65	L32	Cosine of an angle (Cos)	$\#i = \#j \times \text{Cos} (\#k)$
G65	L33	Tan	$\#i = \#j \times \tan (\#k)$
G65	L34	Arctangent of a value (Tan ⁻¹)	
G65	L50	Obtain Data in Register #j	$\#i = \#j$
G65	L51	Obtain & move I-Bit data to #i	$\#i = \#j$
G65	L52	Obtain & move O-Bit data to #i	$\#i = \#j$
G65	L53	Obtain & move C-Bit data to #i	$\#i = \#j$
G65	L54	Obtain & move S-Bit data to #i	$\#i = \#j$
G65	L55	Obtain & move A-Bit data to #i	$\#i = \#j$

G-code	L-code	L-code Function	Mathematical Definitions
G65	L56	Obtain & move CNT. Operation	#i = #j
G65	L60	Store Data into Register	#i = #j
G65	L66	Store Data into Counter	#i = #j
G65	L70	Inspect the status of IOCSA Bit and do the conditional Branching	
G65	L80	Unconditional Branching	Execution jumps to block number 'n'
G65	L81	Conditional Branching 1	If #j = #k, Go To n
G65	L82	Conditional Branching 2	If #j ≠ #k, Go To n
G65	L83	Conditional Branching 3	If #j > #k, Go To n
G65	L84	Conditional Branching 4	If #j < #k, Go To n
G65	L85	Conditional Branching 5	If #j ≥ #k, Go To n
G65	L86	Conditional Branching 6	If #j ≤ #k, Go To n
G65	L88	Conditional Branching 7	If #j ≤ n ≤ (#j + #k) , go to n
G65	L89	Conditional Branching 8	Test the variable bit if "0" or not
G65	L90	Conditional Branching 9	Test the variable bit if "1" or not
G65	L99	User Designated Error Signals	Error display = i+50 (i=1~49)

Note: The range of computation is from (-9999.999) to (+9999.999).

Mathematical Operation Examples (See Table 3-4)

1. Equal or Substitution, $\#i = \#j$

G65 L1 P#i A#j

Ex: G65 L1 P#10 A150 ($\#10 = 150$)
 G65 L1 P#10 A#5 ($\#10 = \#5$. If #5=1200, the result #10=1200.)
 G65 L1 P#10 A-#5 ($\#10 = -\#5$, If #5=1200, the result #10=-1200)

2. Addition, $\#i = \#j + \#k$

G65 L2 P#i A#j B#k

Ex: G65 L2 P#1 A#10 B#5
 If #10=1200 and #5=99, the result #1=1299.

3. Subtraction, $\#i = \#j - \#k$

G65 L3 P#i A#j B#k

Ex1: G65 L3 P#1 A#10 B#5

If #10=1200 and #5=99, the result #1=1101.

Ex2: G65 L3 P#10 A#10 B5

If #10=1200 before subtraction, then after subtraction
#10=1200-5=1195.

4. Multiplication, $\#i = \#j * \#k$

G65 L4 P#i A#j B#k I#m J#n K#l ;

(#m,#i) = (#n,#j) × (#l,#k)

Explanation: #i, #j, #k are low 32-bit operands;
#m, #n, #l are high 32-bit operands.

Ex1 : #4 initial value=10, #30 initial value=25, Set #10 = #4 × #30

Program commands: G65 L4 P#10 A#4 B#30

Result: #10 = #4 × #30 = 250

Ex2 : #4 initial value=100000, #30 initial value=25000,

Set (#20, #10) = #4 × #30

Program commands: G65 L4 P#10 A#4 B#30 I#20

Result: #10 = 3525163520 (Result - low 32-bit)

#20 = 5 (Result - high 32-bit)

5. Division, $\#i = \#j / \#k$

G65 L5 P#i A#j B#k I#m J#n K#l ;

(#m,#i) = (#n,#j) / (#l,#k)

Explanation: #i,#j,#k are low 32-bit operands.
#m,#n,#l are high 32-bit operands.

Result that is less than 1 will be discarded.

Ex: G65 L5 P#10 A#4 B#30

If #4=130, #30=25, then #10=#4 / #30=5 (the decimal 5.2 is discarded)

6. Simultaneously setting of several consecutive variables

G65 L6 P# i A#j B#k ; # i A#j#(i+k) = # j

Ex. 1: The initial values #10=100, #11=20, #13=50, #5=99

Target values #10 = #11 = #12 = #13 = #14 = #5

Program command : G65 L6 P#10 A#5 B5

Result : #10 = #11 = #12 = #13 = #14 = #5 = 99

Ex. 2: To set #10 B5#(10+N-1) = 100, N = #3 = 4

Program command : G65 L6 P#10 A100 B#3

Result : #10 = #11 = #12 = #13 = 100

G65 L06 P#a A#b B#c I#d J#e

#a: initial value of the variable to be configured

#b: starting value to be set

#c: number of variables to be configured

#d: constant difference between the variables to be configured

#e: constant difference between the values to be set

Ex. A: Simultaneously set a series of variables to be of the same value

G65 L06 P#11 A7 B5

Result: #11 ~ #15 = 7

G65 L06 P#29 A0 B7

Result: #29 ~ #35 = 0

Ex. B: Simultaneously set a series of variables to be of a series of values with a constant difference

G65 L06 P#11 A1 B5 J2

Result:

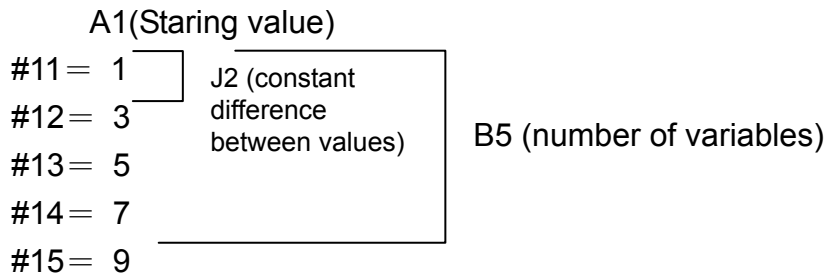

Ex. C: Simultaneously set a series of variables to be of a series of same values

G65 L06 P#11 A7 B5 I5

Result:

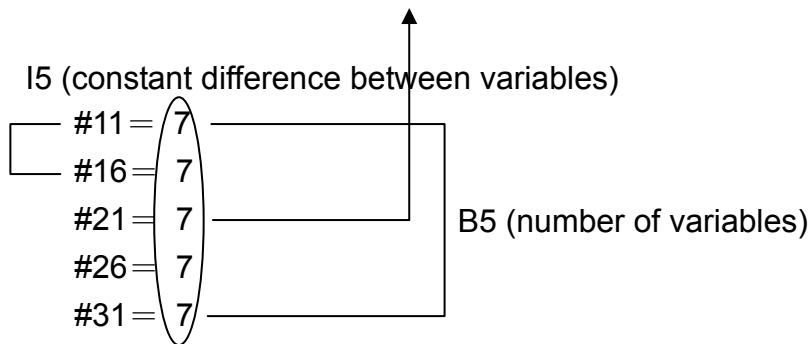

Ex. D: Simultaneously set a series of variables to be of a series of values with a constant difference

G65 L06 P#11 A2 B6 I5 J2

Result:

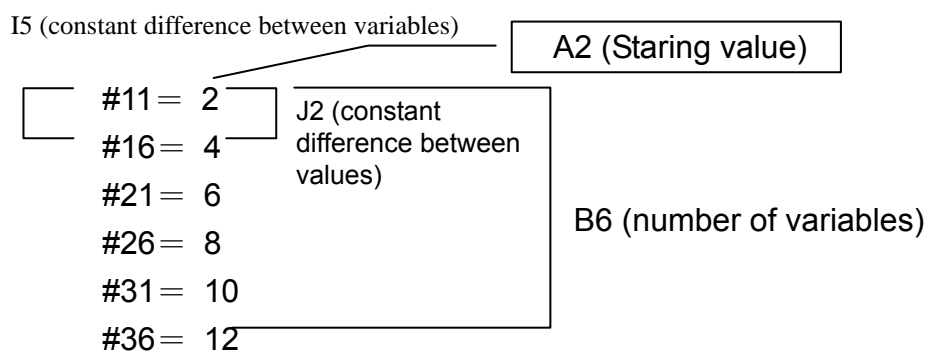

Note 1: #b, #c, #d, #e can be values or variables

Note 2: If A is not specified, it will be regarded as blank.

EXP: G65 L06 P#11 B5

Result: #11 = #12 = #13 = #14 = #15 = bbbbbbb (Blank)

It will appear as blanks on the screen (different from 0)

Ex.: #5 = 10000 #6 = blank

In the program, G00 X#5 Y#6 is regarded as that Y is not specified, which is equivalent to G00 X#5.

7. Simultaneously copy several consecutive variables

G65 L7 P#i A#j B#k ; #i = #j ; #(i+1)=#(j+1) A#j

If #i is added with 900000 ; #(#i) = #j ; #(#i)+1=#(j+1)) s

Note: 0 < #k < 1024

Ex. 1: Copy the values of #10 #(#i) ve variables135

Program command : G65 L7 P#125 A#10 B11

Result : #125=#10, #126=#11, #127=#12, #128=#13
 #129=#14, #130=#15, #131=#16, #132=#17
 #133=#18, #134=#19, #135=#20

Ex. 2: Copy the values of #1 25 A#10 B11256 2: CopyThe initial value :

#256 = 101, #1 = 301

Program command : G65 L7 P#256 A#1 B5

Result : #256 = #1 = 301, #257 = #2, #258 = #3,
 #259 = #4, #260 = #5

Ex. 3: Copy the values of #1 56 A#1 B5 #101: Copy tThe initial value :

#256 = 101, #1 = 301

Program command : G65 L7 P#900256 A#1 B5

Result : #101 = #1 = 301, #102 = #2, #103 = #3,
 #104 = #4, #105 = #5

8. Logic OR, #i = #j .OR. #k (operate in binary format)

G65 L11 P#i A#j B#k ; #i = #j .OR. #k

Ex. 1: To set #10 = #5 .OR. #20, #5 = 12, #20=100

Program command : G65 L11 P#10 A#5 B#20

Result : #10 = 12 .OR. 100 = 108

Ex. 2: To set #10 = #10 .OR. 10, #10 = 15
 Program command : G65 L11 P#10 A#10 B10
 Result : #10 = 15 .OR. 10 = 15

9. Logic AND, $\#i = \#j .AND. \#k$ (operate in binary format)

G65 L12 P#i A#j B#k ; #i = #j .AND. #k

Ex. 1: To set #10 = #5 .AND. #20, #5 = 12, #20 = 100
 Program command : G65 L12 P#10 A#5 B#20
 Result : #10 = 12 .AND. 100 = 4

Ex. 2: To set #10 = #10 .AND. 10, #10 = 15
 Program command : G65 L12 P#10 A#10 B10
 Result : #10 = 15 .AND. 10 = 10

10. Logic XOR, $\#i = \#j .XOR. \#k$ (operate in binary format)

G65 L13 P#i A#j B#k ; #i = #j .XOR. #k

Ex. 1: To set #10 = #5 .XOR. #20, #5 = 4, #20 = 100
 Program command : G65 L13 P#10 A#5 B#20
 Result : #10 = 4 .XOR. 100 = 96

Ex. 2: To set #10 = #10 .XOR. 10, #10 = 15
 Program command : G65 L11 P#10 A#10 B10
 Result : #10 = 15 .XOR. 10 = 5

11. .ROL. $\#i = \#j .ROL. \#k$ (Rotate Left)

G65 L14 P#i A#j B#k

Using 32 Bit (Bit31 – Bit0) as a unit, when shifting toward the left once, Bit31 shifts to Bit0. When calculating a function value that exceeds Bit31, those beyond Bit32 are rounded off.

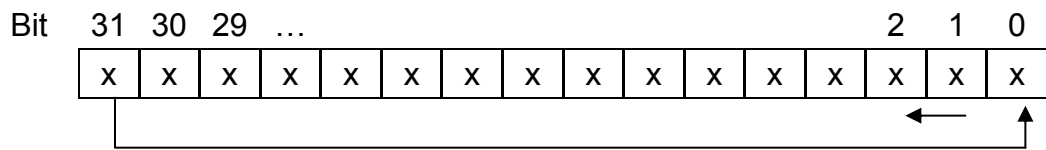

Ex 1: Before G65, variable #10 = 49152
 G65 L14 P#12 A#10 B1 (ROL by 1 position)
 After G65, variable #12 = 32769

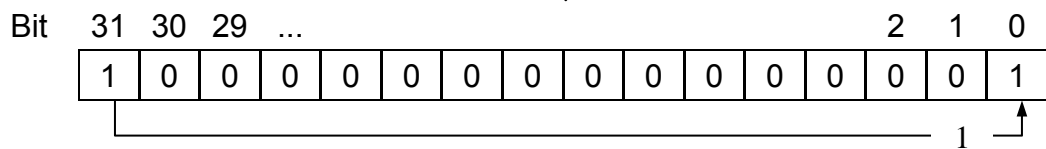
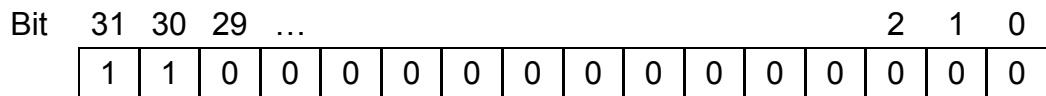

Ex 2: Before G65, variable #10 = 7
 G65 L14 P#12 A#10 B1 (ROL by 1 position)
 After G65, variable #12 = 14

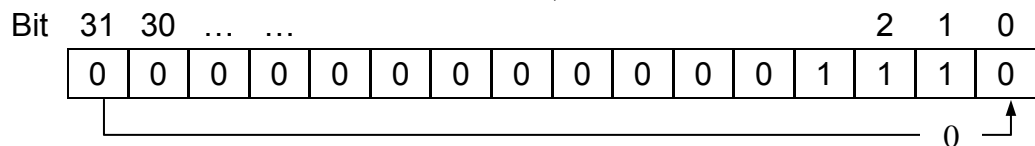
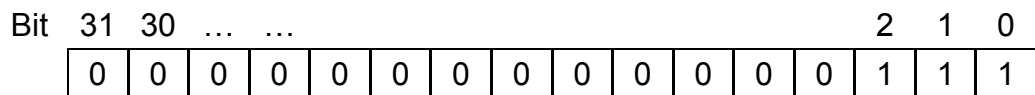

Ex 3: Before G65, variable #10 = -2
 G65 L14 P#12 A#10 B1 (ROL by 1 position)
 After G65, variable #12 = -3

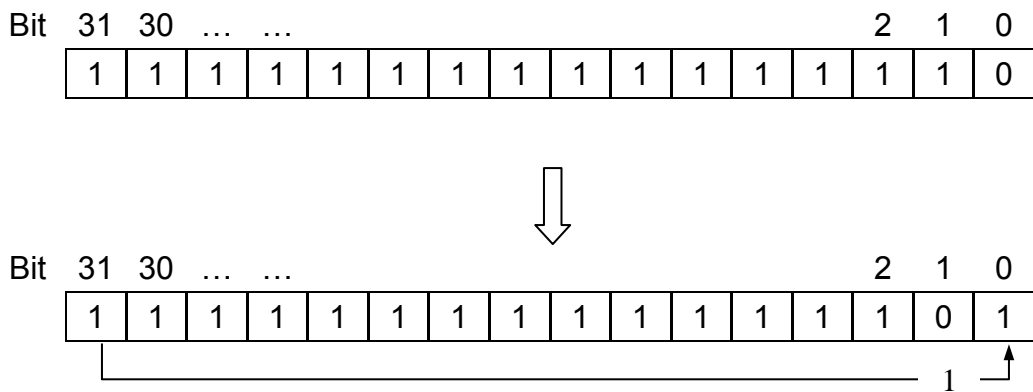

12. .ROR.

#i = #j .ROR. #k (Rotate Right)

G65 L15 P#i A#j B#k

Using 32 Bit (Bit31 – Bit0) as a unit, when shifting toward the right once, Bit0 shifts to Bit31. When calculating the function value exceeding Bit31, those beyond Bit32 are rounded off.

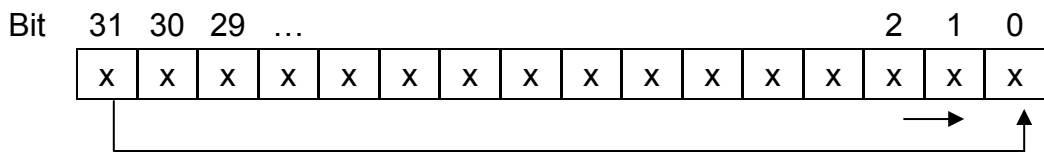

Ex 1: Before G65, variable #10 = 3
 G65 L15 P#12 A#10 B1 (ROR by 1 position)
 After G65, variable #12 = 32769

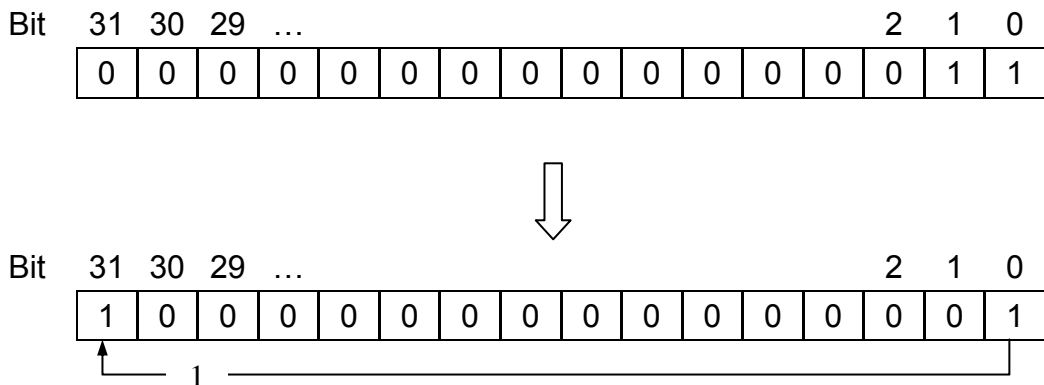

Ex2: Before G65, variable #10 = 6
 G65 L15 P#12 A#10 B1 (ROR by 1 position)
 After G65, variable #12 = 3

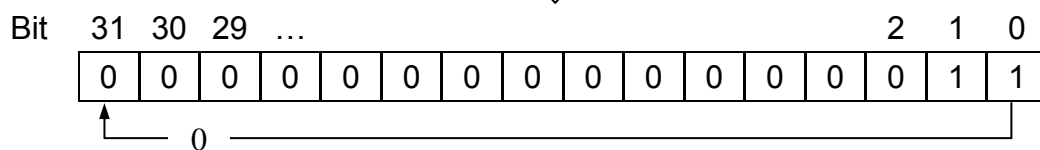
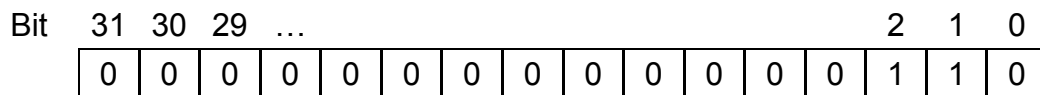

13. .LSL. #i = #j .LSL. #k (Move Left)

G65 L16 P#i A#j B#k

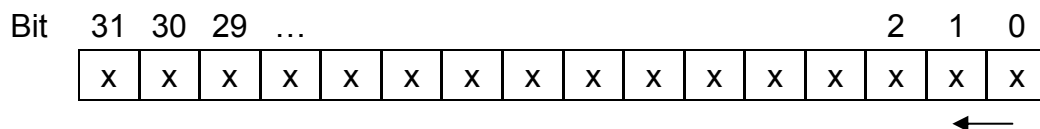

Ex 1: Before G65, variable #10 = 13
 G65 L16 P#12 A#10 B2 (LSL by 2 positions)
 After G65, variable #12 = 52

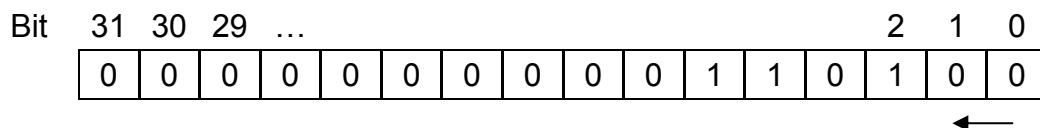
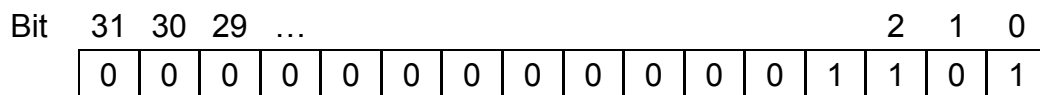

14. .LSR #i = #j .LSR. #k (Move Right)

G65 L17 P#i A#j B#k

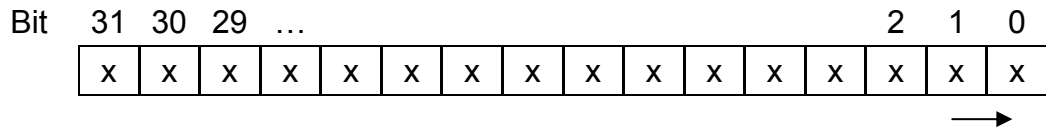

Ex 1: Before G65, variable #10 = 13
 G65 L17 P#12 A#10 B2 (LSR by 2 positions)
 After G65, variable #12 = 3

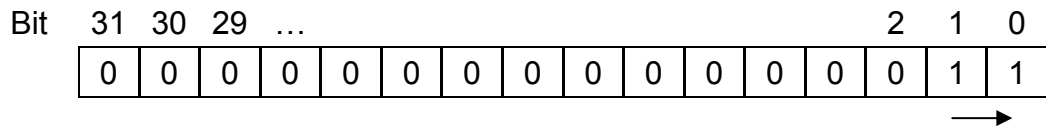
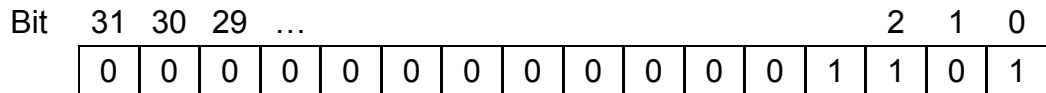

15. Square Root, $\#i = \sqrt{\#j}$

G65 L21 P#i A#j (Result that is less than 1 will be discarded)

Ex: G65 L21 P#10 A#5 ($\#10 = \sqrt{\#5}$)
 If #5 = 30, #10 = 5 after G65 operation.

16. Absolute, $\#i = |\#j|$

G65 L22 P#i A#j

Ex: G65 L22 P#10 A#5 ($\#10 = |\#5|$)
 If #5 = -30, #10 = 30 after G65 operation.

17. Remainder, $\#i = \#j - \text{trunc}(\#j / \#k) \times \#k$

trunc: (Discard result that is less than 1)

G65 L23 P#i A#j B#k

Ex: Find the remainder of (#5/12) with #5 = 99
 G65 L23 P#10 A#5 B12 ($\#10 = \#5 - \text{trunc}(\#5 / 12) \times 12$)
 $\#10 = 99 - \text{trunc}(99 / 12) \times 12 = 99 - (8 \times 12) = 3$

18. Combined Multiplying then Dividing Operation, $\#i = (\#i * \#j) / \#k$

G65 L26 P#i A#j B#k

HUST H4D controller can not handle the multiplied value greater than 9999.999. However, if you use G65 L26 function, the number of digits can exceed 7 digits for the first multiplication operation so long as the final result after division is less than 7 digits. For example, #1=10000, #2=30000, #3=1000, to get the result for $(\#1)*(\#2)/(\#3)$, you thought you could use G65 L04 P#5 A#1 B#2 first, then use G65 L05 P#6 A#5 B#3. But the first operation would yield more than 7 digits and the result would be incorrect. In this case, L26 function can be used as follow to get correct answer.

G65 L26 P#1 A#2 B#3

P#1 = $(\#1) * (\#2) / (\#3) = 300000$

Ex: G65 L26 P#5 A#10 B#15 (#5=120, #2=15000, #3=3000)

#5 = $(\#5 * \#10) / \#15 = (120 * 15000) / 3000 = 600$

Ex 1: #5 = 12, #10 = 15, #15 = 3

Program command :G65 L26 P#5 A#10 B#15

Result :#5 = $(\#5 * \#10) / \#15$
 = $(12 * \#10) / \#15 = 60$

Ex 2: #5 = 120, #10 = 15000, #15 = 3000

Program command :G65 L26 P#5 A#10 B#15

Result :#5 = $(\#5 * \#10) / \#15$
 = $(120 * 15000) / 3000$
 = 600

19. The root of the sum of the square

G65 L27 P#i A#j B#k ; $\#i = \sqrt{(\#j^2 + \#k^2)}$

EX1:#10 = 15 , #15 = 3

Program Command : G65 L27 P#5 A#10 B#15

$$\begin{aligned}
 \text{Ans : \#5} &= \sqrt{(\#10^2 + \#15^2)} \\
 &= \sqrt{(15^2 + 3^2)} \\
 &= 15.297 \text{ (round off)} \\
 &= 15
 \end{aligned}$$

EX2 : #10 = 10 , #15 = 30

Program Command : G65 L27 P#5 A#10 B#15

$$\begin{aligned}
 \text{Ans : \#5} &= \sqrt{(\#10^2 + \#15^2)} \\
 &= \sqrt{(10^2 + 30^2)} \\
 &= 31.622 \text{ (round off)} \\
 &= 32
 \end{aligned}$$

20. The root of the difference of the square

G65 L28 P#i A#j B#k ; #i = $\sqrt{(\#j^2 - \#k^2)}$

EX1: #10 = 15 , #15 = 3

Program Command : G65 L27 P#5 A#10 B#15

$$\begin{aligned}
 \text{Ans : \#5} &= \sqrt{(\#10^2 - \#15^2)} \\
 &= \sqrt{(15^2 - 3^2)} \\
 &= 14.696 \text{ (round off)} \\
 &= 15
 \end{aligned}$$

EX2 : #10 = 25 , #15 = 5

Program Command : G65 L27 P#5 A#10 B#15

$$\begin{aligned}
 \text{Ans : \#5} &= \sqrt{(\#10^2 - \#15^2)} \\
 &= \sqrt{(25^2 - 5^2)} \\
 &= 24.494 \text{ (round off)}
 \end{aligned}$$

1. The angle code “k” is in 5/2 format (2 decimals). So, if #k = 4500, it means 45 °.
2. Since Cos(#k) is always less than 1 and HUST H-2 does not operate on decimal (anything smaller than 1 will be discarded), the G65 L31 operation includes a multiplier “#j”.

Ex: Find the value for Cos 45 o and store it as variable #1

G65 L32 P#1 A1000 B4500

The result P#1 = 1000 * Cos 45 o = 707

24. Tangent of an Angle, $\#i = \#j \times \tan(\#k)$

G65 L33 P#i A#j B#k

#1 = tan 45° = 1 , The format in system is 0000001

So the calculation is G65 L33 P#1 A1000 B4500

Ans : #1 = 1000 ×tan 45° =1000

EX1 : Count : #1 = tan 6000 1.732

Program Command : G65 L33 P#1 A1000 B6000

Ans : #1 = 1000 ×tan 60° =1732

25. Arc-tangent of a number, $\#i = \text{Tan}^{-1} (\#j / \#k)$

G65 L34 P#i A#j B#k

The resulted angle code “i” is in 5/2 format (2 decimals).

Ex: Find the angle for $\text{Tan}^{-1} (577/1000)$ and store it as variable #1

G65 L34 P#1 A577 B1000

The result P#1 = Tan-1 (577/1000) = 0003000 =30 o

26. Obtain Data in Register Number #j and Store in P#i, $\#i = R(\#j)$

Functions G65 L51, G65 L52, G65 L53, G65 L54 and G65 L55 are obtained status signals of PLC-IOCSA and A#J in functions are 16-bit data obtained at one time.

Table 3-13

	G65 L51 I-BIT	G65 L52 O-BIT	G65 L53 C-BIT	G65 L54 S-BIT	G65 L55 A-BIT
#J=0	I000..I015	O000..O015	C000..C015	S000..S015	A000..A015
#J=1	I016..I023	xxxxxx	C016..C031	S016..S031	A016..A031
#J=2	xxxxxxx	xxxxxxx	C032..C047	S032..S047	A032..A047
#J=3	xxxxxxx	xxxxxxx	C048..C063	S048..S063	A048..A063
#J=4	xxxxxxx	xxxxxxx	C064..C079	S064..S079	A064..A079
#J=5	xxxxxxx	xxxxxxx	C080..C095	S080..S095	A080..A095
#J=6	xxxxxxx	xxxxxxx	C096..C111	S096..S111	A096..A111
#J=7	xxxxxxx	xxxxxxx	C112..C127	S112..S127	A112..A127
#J=8	xxxxxxx	xxxxxxx	C128..C143	S128..S143	A128..A143
#J=9	xxxxxxx	xxxxxxx	C144..C159	S144..S159	A144..A159
#J=10	xxxxxxx	xxxxxxx	C160..C175	S160..S175	A160..A175
#J=11	xxxxxxx	xxxxxxx	C176..C191	S176..S191	A176..A191
#J=12	xxxxxxx	xxxxxxx	C192..C207	S192..S207	A192..A207
#J=13	xxxxxxx	xxxxxxx	C208..C223	S208..S223	A208..A223
#J=14	xxxxxxx	xxxxxxx	C224..C239	S224..S239	A224..A239
#J=15	xxxxxxx	xxxxxxx	C240..C255	S240..S255	A240..A255

G65 L50 P#i A#j (Register #j range = R000 ~ R255)

Ex: G65 L50 P#10 A#5(#10 = R(#5) = R3, if #5 = 3)

G65 L50 P#10 A31(#10 = R31)

Functions G65 L51, G65 L52, G65 L53, G65 L54, G65 L55 can be used to obtain the state signals from PLC-IOCSA, and the A#J in the function will retrieve a 16-bit data at a time.

27. Obtain I-Bit Signal Data in PLC, #i = #j = i(#j * 16)..... i(#j * 16 + 15)

G65 L51 P#i A#j (#j range = 0 ~ 1 (I000 ~ I023))

16 I-Bit data can be obtained at one time with total of 24 I-bit available according to the value of variable, A#j (0~7) as shown in the example below.

Ex: Obtain data I016~I023 and store in variable #10

G65 L51 P#10 A1

After G65 operation, #10 = I016~I023= 229(I016 ~ I023 data shown below)

Bit									I23	I22	I21	I20	I19	I18	I17	I16
	0	0	0	0	0	0	0	0	1	1	1	0	0	1	0	1

28. Obtain O-Bit Signal Data in PLC, #I = #j = O(#j * 16)..... O(#j * 16 + 15)

G65 L52 P#I A#j (#j range = 0 (O000 ~ O015))

16 O-Bit data can be obtained at one time with total of 16 O-bit available according to the value of variable, A#j (0) as shown in the example below.

Ex: Obtain data O000~O015 and store in variable #10

G65 L52 P#10 A0

After G65 operation, #10 = O000 ~ 015= 229(O000 ~ O015 data shown below)

Bit	015	014	013	012	011	010	009	008	007	006	005	004	003	002	001	000
	0	0	0	0	0	0	0	0	1	1	1	0	0	1	0	1

29. Obtain C-Bit Signal Data in PLC, #I = #j = C(#j * 16)..... C(#j * 16 + 15)

G65 L53 P#I A#j (#j range = 0 ~ 15 (C000 ~ C255))

16 C-Bit data can be obtained at one time with total of 255 C-bit available according to the value of variable, A#j (0~15) as shown in the example below.

Ex: Obtain data C016~C031 and store in variable #10

G65 L53 P#10 A1

After G65 operation, #10 = C016~C031= 229(C016 ~ C031 data shown below)

Bit	C31	C30	C29	C28	C27	C26	C25	C24	C23	C22	C21	C20	C19	C18	C17	C16
	0	0	0	0	0	0	0	0	1	1	1	0	0	1	0	1

30. Obtain S-Bit Signal Data in PLC, #i = #j = S(#j * 16)..... S(#j * 16 + 15)

G65 L54 P#i A#j (#j range = 0 ~ 15 (S000 ~ S255))

16 S-Bit data can be obtained at one time with total of 255 S-bit available according to the value of variable, A#j (0~15) as shown in the example below.

Ex: Obtain data S016~S031 and store in variable #10

G65 L54 P#10 A1

After G65 operation, #10 =S016~S031= 229(S016 ~ S031 data shown below)

Bit	S31	S30	S29	S28	S27	S26	S25	S24	S23	S22	S21	S20	S19	S18	S17	S16
	0	0	0	0	0	0	0	0	1	1	1	0	0	1	0	1

31. Obtain A-Bit Signal Data in PLC, #i = #j = A(#j * 16)..... A(#j * 16 + 15)

G65 L55 P#i A#j (#j range = 0 ~ 15 (A000 ~ A255))

16 A-Bit data can be obtained at one time with total of 255 A-bit available according to the value of variable, A#j (0~15) as shown in the examples below.

Ex: Obtain data A016~A031 and store in variable #10

G65 L55 P#10 A1

After G65 operation, #10 =A016~A031= 229 (A016 ~ A031 data shown below)

Bit	A31	A30	A29	A28	A27	A26	A25	A24	A23	A22	A21	A20	A19	A18	A17	A16
	0	0	0	0	0	0	0	0	1	1	1	0	0	1	0	1

32. Obtain Counter Data

G65 L56 P#i A#j (#i = Counter(#j), range 0~255)

Ex: Obtain data (=100) in Counter #10 and store in variable #3.

G65 L56 P#3 A10

After G65 operation, #3 = 100

33. Store Data into Register

G65 L60 P#i A#j (Register #i = #j = 0~255)

Ex: Store data from variable #3 into Register #10. The content of #3 = 100.

G65 L60 P#10 A#3

After G65 operation, Register #10 = 100

34. Store Data into Counter

G65 L66 P#i A#j (Counter #i = #j = 0~255)

Ex: Store data from variable #3 into Counter #10. The content of #3 = 100.

G65 L66 P#10 A#3

After G65 operation, Counter #10 = 100

35. Inspect the status of IOCSA Bit and do the conditional Branching

G65 L70 Pn A#a B#b ;When the bit of #a on, skip to the (n)th node

#a : IOCSA range	I = 0~255	#b : the status of every bit (on & off)
	O = 256~511	on=1 off=-1
	C = 512~767	
	S = 768~1023	
	A = 1024~2048	

EX1 :

Command : N10 G65 L01 P#1 A20
 N20 G65 L70 P50 A1 B1
 N30 X100.
 N40 Y100.
 N50 M02

Ans :

When the program is executing N20, the judgment formula will judge the I01 if ON or not. As it is ON, it will skip to N50 and end the program. As it is OFF, it will continue to execute N30 to N50.

36. Unconditional Branching

G65 L80 Pn (n = block number)
 Program execution jumps to block number 'n'.

Ex: N10 G65 L80 P40
 N20 G01 X100.
 N30 Y200.
 N40 M02

After program executes block N10, execution will skip block N20, N30 and jumps to block number 40. Note that when in G65 the “P” number must match exactly with the program number. For example, P0010 = N0010, but P0010 ≠ N10.

37. Conditional Branching 1 (Equal)

G65 L81 Pn A#j B#k (n = block number)

This is equal to the statement “If #j = #k, go to block Pn”. Otherwise, execution continues as normal, line by line without interruption.

Ex: N10 G65 L01 P#1 A10
 N20 G65 L81 P50 A#1 B10
 N30 G01 X100.
 N40 Y100.
 N50 M02

Set variable #1 = 10 at block N10. After block N20, execution will branch to N50 (skip block N30, N40) because “#1=10” is true.

38. Conditional Branching 2 (NOT Equal)

G65 L82 Pn A#j B#k (n = block number)

This is equal to the statement “If #j \neq #k, go to block Pn”. Otherwise, execution continues as normal, line by line without interruption.

```
Ex:  N10 G65 L01 P#1 A20
      N20 G65 L82 P50 A#1 B10
      N30 G01 X100.
      N40 Y100.
      N50 M02
```

Set variable #1 = 20 at block N10. After block N20, execution will branch to N50 (skip block N30, N40) because “#1 \neq 10” is true.

39. Conditional Branching 3 (Greater)

```
G65 L83 Pn A#j B#k          (n = block number)
```

This is equal to the statement “If #j > #k, go to block Pn”. Otherwise, execution continues as normal, line by line without interruption.

```
Ex:  N10 G65 L01 P#1 A20
      N20 G65 L83 P50 A#1 B10
      N30 G01 X100.
      N40 Y100.
      N50 M02
```

Set variable #1 = 20 at block N10. After block N20, execution will branch to N50 (skip block N30, N40) because “#1>10” is true.

40. Conditional Branching 4 (Smaller)

```
G65 L84 Pn A#j B#k          (n = block number)
```

This is equal to the statement “If #j < #k, go to block Pn”. Otherwise, execution continues as normal, line by line without interruption.

```
Ex:  N10 G65 L01 P#1 A20
      N20 G65 L84 P50 A#1 B100
      N30 G01 X100.
```

```
N40 Y100.  
N50 M02
```

Set variable #1 = 20 at block N10. After block N20, execution will branch to N50 (skip block N30, N40) because "#1<100" is true.

41. Conditional Branching 5 (Equal or Greater)

```
G65 L85 Pn A#j B#k          (n = block number)
```

This is equal to the statement "If #j ≥ #k, go to block Pn". Otherwise, execution continues as normal, line by line without interruption.

```
Ex:  N10 G65 L01 P#1 A20  
      N20 G65 L85 P50 A#1 B10  
      N30 G01 X100.  
      N40 Y100.  
      N50 M02
```

Set variable #1 = 20 at block N10. After block N20, execution will branch to N50 (skip block N30, N40) because "#1≥10" is true.

42. Conditional Branching 6 (Equal or Smaller)

```
G65 L86 Pn A#j B#k          (n = block number)
```

This is equal to the statement "If #j ≤ #k, go to block Pn". Otherwise, execution continues as normal, line by line without interruption.

```
Ex:  N10 G65 L01 P#1 A20  
      N20 G65 L86 P50 A#1 B20  
      N30 G01 X100.  
      N40 Y100.  
      N50 M02
```

Set variable #1 = 20 at block N10. After block N20, execution will branch to N50 (skip block N30, N40) because "#1≤20" is true.

43. Loop Executed Single Block Commands

G65 L87 Pi Aj B#k will executes #k times the block loop from the initial single block i to the final single block j.

Example:

```
Program : N10 G65 L01 P#1 A20
          N20 G65 L87 P05 A10 B#1
          N30 G01 X0. F1000
          N05 U 100.
          N08 V 100.
          N10 W100.
          N50 M02
```

When the program executes to the N20 single block, the system will execute 20 times (# 1 variable value) the three single block loops contained from N05 single block to N10 single block. Then, the program will proceed to execute the single block N30 following N20 in sequence until it ends.

44. Conditional Branching 7

【Shorten the calculating time of G65 L81 P A** B** 】**

```
G65 L88 P#xxx Ayyy Bzzz
```

```
xxx => The variable to be judged
yyy => The initial factor of (#xxx)
zzz => The final factor of (#xxx)
```

```
G65 L80 Pwww
```

```
www => The serial number to be executed
```

※ These two command can not be used separately

Info :

```
G65 L88 P#xxx Ayyy Bzzz :
```

When the program is executing at this command, the system will read this and judge the information of variable(#xxx)

```
G65 L80 Pwww :
```

Execute the command of the node

Condition :

1. yyy and zzz must be continuous value
2. G65 L80 Pwww must be in order
3. G65 L80 Pwww command maximum is up to 64 lines

EX :

Line number

Must be continuous number

	G65 L88 P#403 A51 B59	
	G65 L80 P06	::#403 = 51 Skip to N06
	G65 L80 P06	::#403 = 52 Skip to N06
	G65 L80 P06	::#403 = 53 Skip to N06
	G65 L80 P64	::#403 = 54 Skip to N64
	G65 L80 P65	::#403 = 55 Skip to N65
	G65 L80 P66	::#403 = 56 Skip to N66
	G65 L80 P67	::#403 = 57 Skip to N67
	G65 L80 P68	::#403 = 58 Skip to N68
	G65 L80 P69	::#403 = 59 Skip to N69
N06	G65 L82 P0 A#403 B60	:: #403 <> 60 skip to N0
	G65 L01 P#663 A8410	; #663 = 8410
N0	M99	
N64	G65 L02 P#663 A#663 B10	; #663 = #663 + 10
	M99	
N65	G65 L02 P#663 A#663 B20	; #663 = #663 + 20
	M99	
N66	G65 L02 P#663 A#663 B30	; #663 = #663 + 30
	M99	
N67	G65 L02 P#663 A#663 B40	; #663 = #663 + 40
	M99	
N68	G65 L02 P#663 A#663 B50	; #663 = #663 + 50
	M99	
N69	G65 L02 P#663 A#663 B60	; #663 = #663 + 60
	M99	

※ In order
 ※ Up to 64 lines

45. Conditional Branching 8

G65 L89 Pn A#j Bk ; Inspect the bit of the variable (#j) if 0 or not. The bit

is determined by k. If the bit is 0, execute the skip operation.

n : Line number
 #j : Variable to be inspect
 k : Bit to be inspect

EX :

Program : N10
 N20 G65 L89 P50 A#1 B0
 N30 X100.
 N40 Y100.
 N50 M02

Ans : When the program is executing to the N20, it will do the judgment of #1 and then do the calculation of BIT:

As #1=6

..... 4 3 2 1 0 ← Bit
 0 0 1 1 0 ← Binary

We can see that Bit0=0 will be set up and skip to N50 to finish the program.

As#1=9

..... 4 3 2 1 0 ← Bit
 0 1 0 0 1 ← Binary

We can see that Bit0=1 will not be set up and continue to N30 till N50

46. Conditional Branching 9

G65 L90 Pn A#j Bk ; Inspect the bit of the variable (#j) if 1 or not. The bit is determined by k. If the bit is 1, execute the skip operation.

n : Line number
 #j : The variable to be inspect
 k : The bit to be inspect.

Ex :

Program : N10
 N20 G65 L90 P50 A#1 B2
 N30 X100.

N40 Y100.

N50 M02

Ans : When the program is executing to the N20, it will do the judgment of #1 and then do the calculation of BIT:

as#1=6

..... 4 3 2 1 0 ← Bit
 0 0 1 1 0 ← Binary

We can see that Bit2=1 will be set up and skip to N50 to finish the program.

as#1=9

..... 4 3 2 1 0 ← Bit
 0 1 0 0 1 ← Binary

We can see that Bit2=0 will not be set up and continue to N30 till N50

47. User Defined Error Signals (Display = i+50, i=1~49)

G65 L99 Pi

i = 1~49, If 'i' is not in this range, it will display Error 50. User defined error number will be added by 50 because Error 1~49 are HUST system errors.

Ex: G65 L99 P10

Error 60 will be displayed when this block is executed.

Example for G65 Application:

Imagine a roll of plastic (or fabric) being fed into a machine to be cut or perforated according to a fixed pattern on the feed stock. Whole roll of plastic has to be stopped before the cutting action. This example is a part of the program that is used to stop the feed stock for cutting. An electronic light beam is used to detect the recurring pattern so that the feed stock can be stopped. In the program, the I005 bit is the signal from the light beam. When I005=1 (ON), it means the desired pattern is detected. Assume that I005 is the only active signal for I000~ I007 group. So, when I005=1, I000~I007=00100000 in binary = 32 numerically.

Variable: #01 = Total cut length

#02 = The length for fixed pattern detection (I005)

#03 = Normal G01 feed-rate

#04 = Slower feed-rate for fixed pattern detection

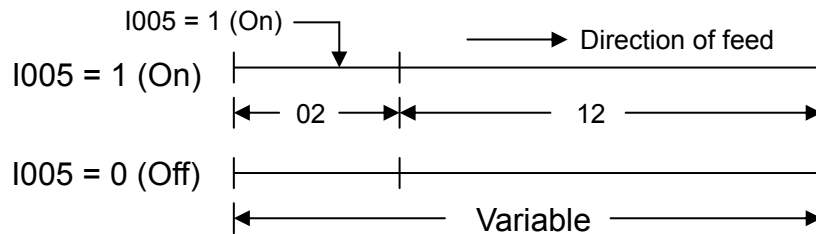



Fig 3-60

G65 L51 P#10 A0	...	Obtain I000~I007 signal
G65 L12 P#11 A#10 B32	...	Check if I005 = 1 (On)
		Note that 32 = 00100000 (binary)
G65 L82 P0010 A#11 B32	...	If I005 ≠ 1, jump to N0010
G65 L84 P0020 A#01 B#02	...	If #01 < #02, jump to N0020
G65 L03 P#12 A#01 B#02	...	#12 = #01 - #02
G01 U#12 F#03		
G31 U#02 F#04	...	Do this when sensor I005 = 1
M02		
N0010 G01 U#01 F#03	...	Do this when sensor I005 = 0
M02		
N0020 G65 L99 P1	...	If #01 < #02, display Error 51
M02		

4 MCM (Machine Constant) PARAMETERS

4.1 MCM Parameter Setting

The MCM parameter setting function allows the user to define the system constants of the controller according to mechanical specifications and machining conditions. The correct and proper setting of these constants is important in the operation of the mechanical system and fabrication of the work-piece. Make sure that the setting is correct. Press  to restart the

machine when the MCM parameter is set successfully.

The MCM Parameter Setting List is shown on the following page. You can configure MCM parameters with reference to this list.

How to Read and Change MCM parameters:

(1) Use the MCM parameter set screen 1

1. Quickly press the key  two times and into the user parameter setting page (if lock setting that will into the lock page first).
2. Press F1 key will into the MCM parameter.

User Parameter	
Motor not home cycle start invalid)	0
Oil Function (0:Jog1:Auto)	0
Backlight close time	000000 s
Count value	0000000
Count value limit	0000000
Parameter	

Fig 4-1

MCM parameter set screen

Parameter	X	Y	Z
Resolution	num	0000000	0000000
	den	0000000	0000000
Encoder factor	0	0	0
Traverse speed	0000000	0000000	0000000
Rotate direction	0	0	0
Home direction	0	0	0
Home speed-1	0000000	0000000	0000000
Home speed-2	0000000	0000000	0000000
Software OT (+)	-0000.000	-0000.000	-0000.000
Software OT (-)	-0000.000	-0000.000	-0000.000
G01 Backlash Comp	-0000.000	-0000.000	-0000.000
G00 Backlash Comp	-0000.000	-0000.000	-0000.000
MPG Resolution	num	0000000	0000000
	den	0000000	0000000
HOME TYPE	0000000	0000000	0000000
Grid check Len.	-0000.000	-0000.000	-0000.000
HOME GRID RESERVED	-0000.000	-0000.000	-0000.000
BN_MCM	RD_MCM	All_MCM	Screw pitch =>

Fig 4-2 Page1

Parameter	X	A	C
Resolution	num	0000000	0000000
	den	0000000	0000000
Encoder factor	0	0	0
Traverse speed	0000000	0000000	0000000
Rotate direction	0	0	0
Home direction	0	0	0
Home speed-1	0000000	0000000	0000000
Home speed-2	0000000	0000000	0000000
Software OT (+)	-0000.000	-0000.000	-0000.000
Software OT (-)	-0000.000	-0000.000	-0000.000
G01 Backlash Comp	-0000.000	-0000.000	-0000.000
G00 Backlash Comp	-0000.000	-0000.000	-0000.000
MPG Resolution	num	0000000	0000000
	den	0000000	0000000
HOME TYPE	0000000	0000000	0000000
Grid check Len.	-0000.000	-0000.000	-0000.000
HOME GRID RESERVED	-0000.000	-0000.000	-0000.000
BN_MCM	RD_MCM	All_MCM	Screw pitch <=

Fig 4-3 Page2

Parameter			
G00 A/D Time	0000 ms	G34-37 DRILLING TYPE(0:G81/1:G83)	0
G01 A/D Time	0000 ms	MPG TYPE(Standard=0,Extern=1)	0
G99 A/D Time	0000 ms	EDIT TYPE 0:default 2:line edit	0
SERVO READY(0:NC/1:NO)	0	G4: OFFSET TYPE 0: R ANGLE 1: RIGHT ANGLE	0
AXES LIMIT(0:NC/1:NO)	0	Master/Slave mode	000
AXES Home(0:NC/1:NO)	0	G41 AND G42 PROCESSING TYPE	0
RS232 Baud rate	0000000	MCM PASSWORD	0000000
PLUSE TYPE (0:P+D 1:P+N 2: AB)	0	A/D TYPE 1:LINE 2: S	000
MPG DIRECTION	0	MPG A/D TIME	000
Incremental limit value	000.000	Operational incremental limit value	000.000
BN_MCM	RD_MCM	All_MCM	Screw pitch =>

Fig 4-4 Page3

SPINDLE			
SPINDLE TYPE(0_OPEN/1_CLOSE)	0	SPINDLE READY(0_NC/1_NO)	0
SP Command (pulse)	000000	SP Run Dir.	0
SP Encoder (pulse)	000000	SP Home Dir.	0
Acceleration Time for SP	0000 ms	SP Home Speed	0000000
Deceleration Time for SP	0000 ms	SP Stop Position Angle	-000.00
Max. SP RPM to 10V	00000	SP Encoder Dir.	0
SP 0V correction	-0000	SP Home Shift	-000.00
SP RPM +10V Slope	-00000	SP Stop to stable time	00000 ms
SP RPM -10V Slope	-00000	SP Search Grid Distane	0000000
SP Gear Ratio Num.	000	SP Gear Ratio Den.	000
G84			
G84 TYPE	0	G84 A/D TIME	0000
Tool Return Distance	-0000.000	G84 A/D TIME ADJUSTMENT	-0000
BN_MCM	RD_MCM	All_MCM	Screw pitch <=

Fig 4-5 Page4



Pitch Compensation	X	Y	Z	A	
Direction(-1,0,1)	-0	-0	-0	-0	
Length Compensation	000.000	000.000	000.000	000.000	
X-Offset compensation(40)					
	01 -0000	11 -0000	21 -0000	31 -0000	
	02 -0000	12 -0000	22 -0000	32 -0000	
	03 -0000	13 -0000	23 -0000	33 -0000	
	04 -0000	14 -0000	24 -0000	34 -0000	
	05 -0000	15 -0000	25 -0000	35 -0000	
	06 -0000	16 -0000	26 -0000	36 -0000	
	07 -0000	17 -0000	27 -0000	37 -0000	
	08 -0000	18 -0000	28 -0000	38 -0000	
	09 -0000	19 -0000	29 -0000	39 -0000	
	10 -0000	20 -0000	30 -0000	40 -0000	
Screw Pitch Setting Page					
X-AXIS	Y-AXIS	Z-AXIS	A-AXIS		

(2) Use the MCM parameter set screen 2 : MCM parameter Table

1. Into the parameter page
2. Press function key of **【All_MCM】** (F3)
3. Use Page↑/Page↓to switch to the next or previous page. 10 parameters are displayed on each page. After modify the MCM parameters, must press the“RESET”button before left.

PGM NO 000 _			
	> PA#0001 =	0.000	
	PA#0002 =	0.000	
	PA#0003 =	0.000	
	PA#0004 =	0.000	
	PA#0005 =	0.000	
	PA#0006 =	0.000	
	PA#0007 =	0.000	
	PA#0008 =	0.000	
	PA#0009 =	0.000	
	PA#0010 =	0.000	
	PA#0011 =	0.000	
	PA#0012 =	0.000	
			A -0000.000
X	-0000.000	Y -0000.000	Z -0000.000
GRAPH — STOP			

Fig 4-6

(3) Change via Upload from RS232C :

Use the transmission software (HCON) to send parameters to the PC for saving as a text file. Change the parameters with PE2, HE, or other document processing software and transmit them back to the CNC. The transmission software also provides real-time online editing functions.

To Clear All Parameters to Factory Default Settings

1. Get into MDI mode by pressing

AUTO
MDI

 key twice in 0.5 seconds.
2. Key in G10 P1000, then press

CYCST

 key.

Special Parameter setting

Parameter		Parameter	
G00 A/D Time	0000 ms	G34-37 DRILLING TYPE(0:G81/1:G83)	0
G01 A/D Time	0000 ms	MPG TYPE(Standard=0,Extern=1)	0
G99 A/D Time	0000 ms	EDIT TYPE 0:default 2:line edit	0
SERVO READY(0:NC/1:NO)	0	G4x OFFSET TYPE 0: R ANGLE 1: RIGHT ANGLE	0
AXES LIMIT(0:NC/1:NO)	0	Master/Slave mode	000
AXES Home(0:NC/1:NO)	0	G41 AND G42 PROCESSING TYPE	0
RS232 Baud rate	0000000	MCM PASSWORD	0000000
PLUSE TYPE (0:P+D 1:P+N 2: AB)	0	A/D TYPE 1:LINE 2: S	000
MPG DIRECTION	0	MPG A/D TIME	000
Incremental limit value	000.000	Operational incremental limit value	000.000
BN_MCM	RD_MCM	All_MCM	Screw pitch =>

Fig 4-7

1. G34-37 drilling type (Fig 4-6) : Interactive program editing mode

= 0 , drilling type is G81

= 1 , drilling type is G83

2. MPG type (Fig 4-6)

= 0 , Standard type (our standard operator panel)

= 1 , MPG hand-wheel (external device)

3. Edit type (Fig 4-6)

Program editing type

= 0 , Default

Ex : edit mode

G01 X100. Y50. F1000

G01 Enter

X100. Enter

Y50. Enter

F1000 Enter

= 1 , Line edit

Ex : edit mode

G01 X100. Y50. F1000 Enter

4. G4* OFFSET TYPE

= 0 , R angle

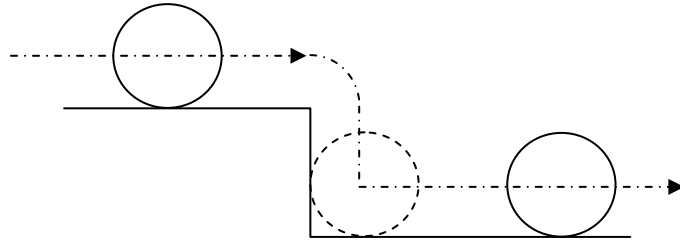

Fig 4-8

= 1 , Right angle

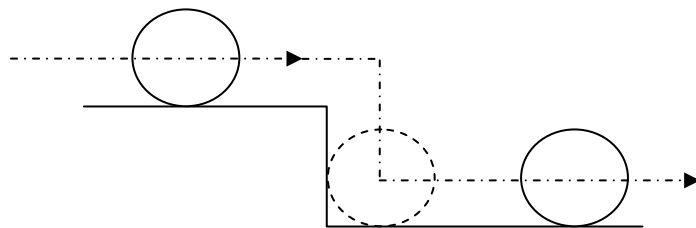

Fig 4-9

5. Servo ready signal (Fig 4-6)

= 0 , Normally Close

= 1 , Normally Open

6. Spindle ready signal (Fig 4-4)

= 0 , Normally Close

= 1 , Normally Open

※ The other setting that please reference the operation manual.

※ MCM start position is 14000 (H4D-M / H6D-M / H9D-M type)

HUST H4D-M / H6D-M / H9D-M MCM Parameter

MCM No.	Factory Default Setting	Unit	Description	Setting
1	0	mm	G54 X-axis 1 st Work coordinate (origin)	
2	0	mm	G54 Y-axis 1 st Work coordinate (origin)	
3	0	mm	G54 Z-axis 1 st Work coordinate (origin)	
4	0	mm	G54 A-axis 1 st Work coordinate (origin)	
5	0	mm	G54 B-axis 1 st Work coordinate (origin)	
6	0	mm	G54 C-axis 1 st Work coordinate (origin)	
7	0	mm	G54 U-axis 1 st Work coordinate (origin)	
8	0	mm	G54 V-axis 1 st Work coordinate (origin)	
9	0	mm	G54 W-axis 1 st Work coordinate (origin)	
10-20			System Reserved !	
21	0	mm	G55 X-axis 2 nd Work coordinate (origin)	
22	0	mm	G55 Y-axis 2 nd Work coordinate (origin)	
23	0	mm	G55 Z-axis 2 nd Work coordinate (origin)	
24	0	mm	G55 A-axis 2 nd Work coordinate (origin)	
25	0	mm	G55 B-axis 2 nd Work coordinate (origin)	
26	0	mm	G55 C-axis 2 nd Work coordinate (origin)	
27	0	mm	G55 U-axis 2 nd Work coordinate (origin)	
28	0	mm	G55 V-axis 2 nd Work coordinate (origin)	
29	0	mm	G55 W-axis 2 nd Work coordinate (origin)	
30-40			System Reserved !	
41	0	mm	G56 X-axis 3 rd Work coordinate (origin)	
42	0	mm	G56 Y-axis 3 rd Work coordinate (origin)	
43	0	mm	G56 Z-axis 3 rd Work coordinate (origin)	
44	0	mm	G56 A-axis 3 rd Work coordinate (origin)	
45	0	mm	G56 B-axis 3 rd Work coordinate (origin)	
46	0	mm	G56 C-axis 3 rd Work coordinate (origin)	
47	0	mm	G56 U-axis 3 rd Work coordinate (origin)	
48	0	mm	G56 V-axis 3 rd Work coordinate (origin)	
49	0	mm	G56 W-axis 3 rd Work coordinate (origin)	
50-60			System Reserved !	
61	0	mm	G57 X-axis 4 th Work coordinate (origin)	
62	0	mm	G57 Y-axis 4 th Work coordinate (origin)	
63	0	mm	G57 Z-axis 4 th Work coordinate (origin)	
64	0	mm	G57 A-axis 4 th Work coordinate (origin)	
65	0	mm	G57 B-axis 4 th Work coordinate (origin)	
66	0	mm	G57 C-axis 4 th Work coordinate (origin)	
67	0	mm	G57 U-axis 4 th Work coordinate (origin)	
68	0	mm	G57 V-axis 4 th Work coordinate (origin)	
69	0	mm	G57 W-axis 4 th Work coordinate (origin)	
70-80			System Reserved !	
81	0	mm	G58 X-axis 5 th Work coordinate (origin)	
82	0	mm	G58 Y-axis 5 th Work coordinate (origin)	

MCM No.	Factory Default Setting	Unit	Description	Setting
83	0	mm	G58 Z-axis 5 th Work coordinate (origin)	
84	0	mm	G58 A-axis 5 th Work coordinate (origin)	
85	0	mm	G58 B-axis 5 th Work coordinate (origin)	
86	0	mm	G58 C-axis 5 th Work coordinate (origin)	
87	0	mm	G58 U-axis 5 th Work coordinate (origin)	
88	0	mm	G58 V-axis 5 th Work coordinate (origin)	
89	0	mm	G58 W-axis 5 th Work coordinate (origin)	
90-100			System Reserved !	
101	0	mm	G59 X-axis 6 th Work coordinate (origin)	
102	0	mm	G59 Y-axis 6 th Work coordinate (origin)	
103	0	mm	G59 Z-axis 6 th Work coordinate (origin)	
104	0	mm	G59 A-axis 6 th Work coordinate (origin)	
105	0	mm	G59 B-axis 6 th Work coordinate (origin)	
106	0	mm	G59 C-axis 6 th Work coordinate (origin)	
107	0	mm	G59 U-axis 6 th Work coordinate (origin)	
108	0	mm	G59 V-axis 6 th Work coordinate (origin)	
109	0	mm	G59 W-axis 6 th Work coordinate (origin)	
110-120			System Reserved !	
121	0	mm	X-axis, G28 reference point coordinate	
122	0	mm	Y-axis, G28 reference point coordinate	
123	0	mm	Z-axis, G28 reference point coordinate	
124	0	mm	A-axis, G28 reference point coordinate	
125	0	mm	B-axis, G28 reference point coordinate	
126	0	mm	C-axis, G28 reference point coordinate	
127	0	mm	U-axis, G28 reference point coordinate	
128	0	mm	V-axis, G28 reference point coordinate	
129	0	mm	W-axis, G28 reference point coordinate	
130-140			System Reserved !	
141	0	mm	X-axis, G30 reference point coordinate	
142	0	mm	Y-axis, G30 reference point coordinate	
143	0	mm	Z-axis, G30 reference point coordinate	
144	0	mm	A-axis, G30 reference point coordinate	
145	0	mm	B-axis, G30 reference point coordinate	
146	0	mm	C-axis, G30 reference point coordinate	
147	0	mm	U-axis, G30 reference point coordinate	
148	0	mm	V-axis, G30 reference point coordinate	
149	0	mm	W-axis, G30 reference point coordinate	
150-160			System Reserved !	
161	0	mm	X-axis, Backlash compensation (G01), 0~9.999	
162	0	mm	Y-axis, Backlash compensation (G01), 0~9.999	
163	0	mm	Z-axis, Backlash compensation (G01), 0~9.999	
164	0	mm	A-axis, Backlash compensation (G01), 0~9.999	
165	0	mm	B-axis, Backlash compensation (G01), 0~9.999	
166	0	mm	C-axis, Backlash compensation (G01), 0~9.999	
167	0	mm	U-axis, Backlash compensation (G01), 0~9.999	

MCM No.	Factory Default Setting	Unit	Description	Setting
168	0	mm	V-axis, Backlash compensation (G01), 0~9.999	
169	0	mm	W-axis, Backlash compensation (G01), 0~9.999	
170-180			System Reserved !	
181	0	mm	X-axis, Backlash compensation (G00), 0~9.999	
182	0	mm	Y-axis, Backlash compensation (G00), 0~9.999	
183	0	mm	Z-axis, Backlash compensation (G00), 0~9.999	
184	0	mm	A-axis, Backlash compensation (G00), 0~9.999	
185	0	mm	B-axis, Backlash compensation (G00), 0~9.999	
186	0	mm	C-axis, Backlash compensation (G00), 0~9.999	
187	0	mm	U-axis, Backlash compensation (G00), 0~9.999	
188	0	mm	V-axis, Backlash compensation (G00), 0~9.999	
189	0	mm	W-axis, Backlash compensation (G00), 0~9.999	
190-200			System Reserved !	
201	1000	mm/min	X-axis, JOG Feed-rate	
202	1000	mm/min	Y-axis, JOG Feed-rate	
203	1000	mm/min	Z-axis, JOG Feed-rate	
204	1000	mm/min	A-axis, JOG Feed-rate	
205	1000	mm/min	B-axis, JOG Feed-rate	
206	1000	mm/min	C-axis, JOG Feed-rate	
207	1000	mm/min	U-axis, JOG Feed-rate	
208	1000	mm/min	V-axis, JOG Feed-rate	
209	1000	mm/min	W-axis, JOG Feed-rate	
210-220			System Reserved !	
221	10000	mm/min	X-axis, G00 Traverse speed limit	
222	10000	mm/min	Y-axis, G00 Traverse speed limit	
223	10000	mm/min	Z-axis, G00 Traverse speed limit	
224	10000	mm/min	A-axis, G00 Traverse speed limit	
225	10000	mm/min	B-axis, G00 Traverse speed limit	
226	10000	mm/min	C-axis, G00 Traverse speed limit	
227	10000	mm/min	U-axis, G00 Traverse speed limit	
228	10000	mm/min	V-axis, G00 Traverse speed limit	
229	10000	mm/min	W-axis, G00 Traverse speed limit	
230-240			System Reserved !	
241	100	pulse	X-axis,Denominator,resolution calc.(Encoder pulse)	
242	100	μm	X-axis,Numerator,resolution calculation.(Ball-screwpitch)	
243	100	pulse	Y-axis,Denominator,resolutioncalc.(Encoder pulse)	
244	100	μm	Y-axis,Numerator,resolutioncalc.(Ball-screwpitch)	
245	100	pulse	Z-axis,Denominator,resolutioncalc.(Encoder pulse)	
246	100	μm	Z-axis,Numerator,resolutioncalc.(Ball-screwpitch)	
247	100	pulse	A-axis,Denominator,resolutioncalc.(Encoder pulse)	
248	100	μm	A-axis,Numerator,resolutioncalc.(Ball-screwpitch)	
249	100	pulse	B-axis,Denominator,resolutioncalc.(Encoder pulse)	
250	100	μm	B-axis,Numerator,resolutioncalc.(Ball-screwpitch)	
251	100	pulse	C-axis,Denominator,resolutioncalc.(Encoder pulse)	

MCM No.	Factory Default Setting	Unit	Description	Setting
252	100	μm	C-axis,Numerator,resolutioncalc.(Ball-screwpitch)	
253	100	pulse	U-axis,Denominator,resolutioncalc.(Encoder pulse)	
254	100	μm	U-axis,Numerator,resolutioncalc.(Ball-screwpitch)	
255	100	pulse	V-axis,Denominator,resolutioncalc.(Encoder pulse)	
256	100	μm	V-axis,Numerator,resolutioncalc.(Ball-screwpitch)	
257	100	pulse	W-axis,Denominator,resolutioncalc.(Encoder pulse)	
258	100	μm	W-axis,Numerator,resolutioncalc.(Ball-screwpitch)	
259-280			System Reserved !	
281	0		X-axis, HOME direction, 0=+ dir.1=-dir	
282	0		Y-axis, HOME direction, 0=+ dir.1=-dir	
283	0		Z-axis, HOME direction, 0=+ dir.1=-dir	
284	0		A-axis, HOME direction, 0=+ dir.1=-dir	
285	0		B-axis, HOME direction, 0=+ dir.1=-dir	
286	0		C-axis, HOME direction, 0=+ dir.1=-dir	
287	0		U-axis, HOME direction, 0=+ dir.1=-dir	
288	0		V-axis, HOME direction, 0=+ dir.1=-dir	
289	0		W-axis, HOME direction, 0=+ dir.1=-dir	
287-300			System Reserved !	
301	2500	mm/min	X-axis, HOME speed 1	
302	2500	mm/min	Y-axis, HOME speed 1	
303	2500	mm/min	Z-axis, HOME speed 1	
304	2500	mm/min	A-axis, HOME speed 1	
305	2500	mm/min	B-axis, HOME speed 1	
306	2500	mm/min	C-axis, HOME speed 1	
207	2500	mm/min	U-axis, HOME speed 1	
308	2500	mm/min	V-axis, HOME speed 1	
309	2500	mm/min	W-axis, HOME speed 1	
310-320			System Reserved !	
321	40	mm/min	X-axis, Home grid speed during HOME execution	
322	40	mm/min	Y-axis, Home grid speed during HOME execution	
323	40	mm/min	Z-axis, Home grid speed during HOME execution	
324	40	mm/min	A-axis, Home grid speed during HOME execution	
325	40	mm/min	B-axis, Home grid speed during HOME execution	
326	40	mm/min	C-axis, Home grid speed during HOME execution	
327	40	mm/min	U-axis, Home grid speed during HOME execution	
328	40	mm/min	V-axis, Home grid speed during HOME execution	
329	40	mm/min	W-axis, Home grid speed during HOME execution	
330-340			System Reserved !	
341	0	0/1	X-axis,Home grid direction during HOME execution	
342	0	0/1	Y-axis,Home grid direction during HOME execution	
343	0	0/1	Z-axis,Home grid direction during HOME execution	
344	0	0/1	A-axis,Home grid direction during HOME execution	
345	0	0/1	B-axis,Home grid direction during HOME execution	
346	0	0/1	C-axis,Home grid direction during HOME execution	
347	0	0/1	U-axis,Home grid direction during HOME execution	

MCM No.	Factory Default Setting	Unit	Description	Setting
348	0	0/1	V-axis,Home grid direction during HOME execution	
349	0	0/1	W-axis,Home grid direction during HOME execution	
350-360			System Reserved !	
361	0	mm	X –axis Home grid setting	
362	0	mm	Y-axis Home grid setting	
363	0	mm	Z-axis Home grid setting	
364	0	mm	A-axis Home grid setting	
365	0	mm	B-axis Home grid setting	
366	0	mm	C-axis Home grid setting	
367	0	mm	U-axis Home grid setting	
368	0	mm	V-axis Home grid setting	
369	0	mm	W-axis Home grid setting	
370-380			System Reserved !	
381	0	mm	X-axis, HOME shift data	
382	0	mm	Y-axis, HOME shift data	
383	0	mm	Z-axis, HOME shift data	
384	0	mm	A-axis, HOME shift data	
385	0	mm	B-axis, HOME shift data	
386	0	mm	C-axis, HOME shift data	
387	0	mm	U-axis, HOME shift data	
388	0	mm	V-axis, HOME shift data	
389	0	mm	W-axis, HOME shift data	
390-400			System Reserved !	
401	10.000	mm	X-axis,Setting the value of search servo grid	
402	10.000	mm	Y-axis,Setting the value of search servo grid	
403	10.000	mm	Z-axis,Setting the value of search servo grid	
404	10.000	mm	A-axis,Setting the value of search servo grid	
405	10.000	mm	B-axis,Setting the value of search servo grid	
406	10.000	mm	C-axis,Setting the value of search servo grid	
407	10.000	mm	U-axis,Setting the value of search servo grid	
408	10.000	mm	V-axis,Setting the value of search servo grid	
409	10.000	mm	W-axis,Setting the value of search servo grid	
410-420	0		System Reserved !	
421	0		X-axis Origin switch (+ :N.O (normallyopen) node; -:N.C (normally closed) node)	
422	0		Y-axis Origin switch (+ :N.O node; -:N.C node)	
423	0		Z-axis Origin switch (+ :N.O node; -:N.C node)	
424	0		A-axis Origin switch (+ :N.O node; -:N.C node)	
425	0		B-axis Origin switch (+ :N.O node; -:N.C node)	
426	0		C-axis Origin switch (+ :N.O node; -:N.C node)	
427	0		U-axis Origin switch (+ :N.O node; -:N.C node)	
428	0		V-axis Origin switch (+ :N.O node; -:N.C node)	
429	0		W-axis Origin switch (+ :N.O node; -:N.C node)	
430-440			System Reserved !	
441	0		X-axis, Direction of motor rotation, 0=CW, 1=CCW	

MCM No.	Factory Default Setting	Unit	Description	Setting
442	0		Y-axis, Direction of motor rotation, 0=CW, 1=CCW	
443	0		Z-axis, Direction of motor rotation, 0=CW, 1=CCW	
444	0		A-axis, Direction of motor rotation, 0=CW, 1=CCW	
445	0		B-axis, Direction of motor rotation, 0=CW, 1=CCW	
446	0		C-axis, Direction of motor rotation, 0=CW, 1=CCW	
447	0		U-axis, Direction of motor rotation, 0=CW, 1=CCW	
448	0		V-axis, Direction of motor rotation, 0=CW, 1=CCW	
449	0		W-axis, Direction of motor rotation, 0=CW, 1=CCW	
450-460			System Reserved !	
461	4		X-axis,Encoder pulse multiplicationfactor,1,2,or 4	
462	4		Y-axis,Encoder pulse multiplicationfactor,1,2,or 4	
463	4		Z-axis,Encoder pulse multiplicationfactor,1,2,or 4	
464	4		A-axis,Encoder pulse multiplicationfactor,1,2,or 4	
465	4		B-axis,Encoder pulse multiplicationfactor,1,2,or 4	
466	4		C-axis,Encoder pulse multiplicationfactor,1,2,or 4	
467	4		U-axis,Encoder pulse multiplicationfactor,1,2,or 4	
468	4		V-axis,Encoder pulse multiplicationfactor,1,2,or 4	
469	4		W-axis,Encoder pulse multiplicationfactor,1,2,or 4	
470-480			System Reserved !	
481	5		X-axis impulse command width adjustment (4=625KPPS)	
482	5		Y-axis impulse command width adjustment (4=625KPPS)	
483	5		Z-axis impulse command width adjustment (4=625KPPS)	
484	5		A-axis impulse command width adjustment (4=625KPPS)	
485	5		B-axis impulse command width adjustment (4=625KPPS)	
486	5		C-axis impulse command width adjustment (4=625KPPS)	
487	5		U-axis impulse command width adjustment (4=625KPPS)	
488	5		V-axis impulse command width adjustment (4=625KPPS)	
489	5		W-axis impulse command width adjustment (4=625KPPS)	
490-500	6		System Reserved !	
501	0		Master/Slave mode, 0=CNC, 1=X-axis, 2=Y-axis 3=Z-axis,4=A-axis,5=B-axis,6=C-axis,7=U-axis, 8=V-axis, 9=w-axis, 256= non-stop mode in a single block	
502	0		Accel/Decel mode,0=exponential,1=linear,2="S" curve	
503	0		Home command mode setting. BIT0 = 0 , X axis find Home grid available,	

MCM No.	Factory Default Setting	Unit	Description	Setting
			= 1 , no need to find.	
			BIT1 = 0 , Y axis find Home grid available, = 1 , no need to find.	
			BIT2 = 0 , Z axis find Home grid available, = 1 , no need to find.	
			BIT3 = 0 , A axis find Home grid available, = 1 , no need to find.	
			BIT4 = 0 , B axis find Home grid available, = 1 , no need to find.	
			BIT5 = 0 , C axis find Home grid available, = 1 , no need to find.	
			BIT6 = 0 , U axis find Home grid available, = 1 , no need to find.	
			BIT7 = 0 , V axis find Home grid available, = 1 , no need to find.	
			BIT8 = 0 , W axis find Home grid available, = 1 , no need to find.	
504	100	msec	G00 Linear accel./decel. Time, 4~512 ms	
505	100	msec	G01 Linear accel./decel. Time, 10~1024 ms	
506	100	msec	Accel/Decel time when in G99 mode (mm/rev)	
507	100	msec	Time Setting for spindle acceleration	
508	0		System Reserved !	
509	4096	pulse	Spindle encoder resolution (pulse/rev)	
510	3000	rpm	Max. spindle rpm at 10 volts	
511	0	v	Spindle voltage command zero drift correction (open circuit)	
512	0		Spindle voltage command acce/dece slope correction (open circuit)	
513	0	rpm	Spindle RPM correction (based on feedback from the encoder)	
514	0		Start number for program block number generation	
515	0		Increment for program block number generation	
516	1		Denominator of feed-rate when in MPG test mode	
517	1		Numerator of feed-rate when in MPG test mode	
518	0		MPG direction	
519	64	ms	Set Acceleration/Deceleration Time for MPG (4~512)	
520	38400		RS232 Baud rate, 38400, 19200 / EVEN /2 Bit	
521	0		Setting whether R000~R199 data in PLC are stored when power is cut off. 0=NO, 256=YES	
522	0	pulse	Servo Error Counter	
523	0		Radius/Diameter Programming mode	
524	0		0=Metric mode, 25400=inch mode mcm541=0,1	
525	3		Error in Circular Cutting, ideal value=1	
526	0		Pulse settings 0: pulse + direction 1: +/- pulse 2: A/B phase	

MCM No.	Factory Default Setting	Unit	Description	Setting
527	1000		Setting G01 speed value at booting	
528	0		Setting tool compensation direction =1 FAUNC, =0 HUST	
529	0		It is used for adjusting the G01's acceleration/deceleration time when the acceleration/deceleration type is set to an "S" curve. When MCM 502=2, the function can then be sustained.	
530	0		G31 input motion stop at hardware	
531	0		Format setting =0 standard, =1 the system will automatically add a decimal point to even numbers, =2 line editing, =4 automatically added with a decimal point in programming	
532	2.000	mm	Mill mode ; Setting the backlash of G83	
533	4096	pulse	Setting the following error count for testing	
534			Testing the function of axial setting of the servo following error (bit0-X..)	
535			Controller ID number	
536			Minimum slope setting of the Auto Teach function (with use of C040)	
537			First distance setting of the Auto Teach function (with use of C040)	
538	0		G41 and G42 processing types	
539			System reserved	
540	0		Adjustment of the axis feedback direction.	
541	0		Arc type	
541-560			System Reserved !	
561	0		"S" curve accel./decel. profile setting for the X-axis	
562	0		"S" curve accel./decel. profile setting for the Y-axis	
563	0		"S" curve accel./decel. profile setting for the Z-axis	
564	0		"S" curve accel./decel. profile setting for the A-axis	
565	0		"S" curve accel./decel. profile setting for the B-axis	
566	0		"S" curve accel./decel. profile setting for the C-axis	
567	0		"S" curve accel./decel. profile setting for the U-axis	
568	0		"S" curve accel./decel. profile setting for the V-axis	
569	0		"S" curve accel./decel. profile setting for the W-axis	
570~580			System Reserved !	
581	9999999	mm	X-axis, Software OT limit, (+) direction (Group 1)	
582	9999999	mm	Y-axis, Software OT limit, (+) direction (Group 1)	
583	9999999	mm	Z-axis, Software OT limit, (+) direction (Group 1)	
584	9999999	mm	A-axis, Software OT limit, (+) direction (Group 1)	
585	9999999	mm	B-axis, Software OT limit, (+) direction (Group 1)	
586	9999999	mm	C-axis, Software OT limit, (+) direction (Group 1)	

MCM No.	Factory Default Setting	Unit	Description	Setting
587	9999999	mm	U-axis, Software OT limit, (+) direction (Group 1)	
588	9999999	mm	V-axis, Software OT limit, (+) direction (Group 1)	
589	9999999	mm	W-axis, Software OT limit, (+) direction (Group 1)	
590-600			System Reserved !	
601	-9999999	mm	X-axis, Software OT limit, (-) direction (Group 1)	
602	-9999999	mm	Y-axis, Software OT limit, (-) direction (Group 1)	
603	-9999999	mm	Z-axis, Software OT limit, (-) direction (Group 1)	
604	-9999999	mm	A-axis, Software OT limit, (-) direction (Group 1)	
605	-9999999	mm	B-axis, Software OT limit, (-) direction (Group 1)	
606	-9999999	mm	C-axis, Software OT limit, (-) direction (Group 1)	
607	-9999999	mm	U-axis, Software OT limit, (-) direction (Group 1)	
608	-9999999	mm	V-axis, Software OT limit, (-) direction (Group 1)	
609	-9999999	mm	W-axis, Software OT limit, (-) direction (Group 1)	
610-620			System Reserved !	
621	9999999	mm	X-axis, Software OT limit, (+) direction (Group 2)	
622	9999999	mm	Y-axis, Software OT limit, (+) direction (Group 2)	
623	9999999	mm	Z-axis, Software OT limit, (+) direction (Group 2)	
624	9999999	mm	A-axis, Software OT limit, (+) direction (Group 2)	
625	9999999	mm	B-axis, Software OT limit, (+) direction (Group 2)	
626	9999999	mm	C-axis, Software OT limit, (+) direction (Group 2)	
627	9999999	mm	U-axis, Software OT limit, (+) direction (Group 2)	
628	9999999	mm	V-axis, Software OT limit, (+) direction (Group 2)	
629	9999999	mm	W-axis, Software OT limit, (+) direction (Group 2)	
630-640			System Reserved !	
641	-9999999	mm	X-axis, Software OT limit, (-) direction (Group 2)	
642	-9999999	mm	Y-axis, Software OT limit, (-) direction (Group 2)	
643	-9999999	mm	Z-axis, Software OT limit, (-) direction (Group 2)	
644	-9999999	mm	A-axis, Software OT limit, (-) direction (Group 2)	
645	-9999999	mm	B-axis, Software OT limit, (-) direction (Group 2)	
646	-9999999	mm	C-axis, Software OT limit, (-) direction (Group 2)	
647	-9999999	mm	U-axis, Software OT limit, (-) direction (Group 2)	
648	-9999999	mm	V-axis, Software OT limit, (-) direction (Group 2)	
649	-9999999	mm	W-axis, Software OT limit, (-) direction (Group 2)	
650-660			System Reserved !	
661	0		X-axis, Cycle clearing w/ M02, M30, M99	
662	0		Y-axis, Cycle clearing w/ M02, M30, M99	
663	0		Z-axis, Cycle clearing w/ M02, M30, M99	
664	0		A-axis, Cycle clearing w/ M02, M30, M99	
665	0		B-axis, Cycle clearing w/ M02, M30, M99	
666	0		C-axis, Cycle clearing w/ M02, M30, M99	
667	0		U-axis, Cycle clearing w/ M02, M30, M99	
668	0		V-axis, Cycle clearing w/ M02, M30, M99	
669	0		W-axis, Cycle clearing w/ M02, M30, M99	
670-680	0		System Reserved !	
681	1		X-axis,0=incremental coord.,1=absolute coordinate	

MCM No.	Factory Default Setting	Unit	Description	Setting
682	1		Y-axis,0=incrementalcoord.,1=absolute coordinate	
683	1		Z-axis,0=incrementalcoord.,1=absolute coordinate	
684	1		A-axis,0=incrementalcoord.,1=absolute coordinate	
685	1		B-axis,0=incrementalcoord.,1=absolute coordinate	
686	1		C-axis,0=incrementalcoord.,1=absolute coordinate	
687	1		U-axis,0=incrementalcoord.,1=absolute coordinate	
688	1		V-axis,0=incrementalcoord.,1=absolute coordinate	
689	1		W-axis,0=incrementalcoord.,1=absolute coordinate	
690-700	1		System Reserved !	
701	64	pulse	X-axis, Position gain, standard=64	
702	64	pulse	Y-axis, Position gain, standard=64	
703	64	pulse	Z-axis, Position gain, standard=64	
704	64	pulse	A-axis, Position gain, standard=64	
705	64	pulse	B-axis, Position gain, standard=64	
706	64	pulse	C-axis, Position gain, standard=64	
707	64	pulse	U-axis, Position gain, standard=64	
708	64	pulse	V-axis, Position gain, standard=64	
709	64	pulse	W-axis, Position gain, standard=64	
710-720	64	pulse	System Reserved !	
721	10	pulse	X-axis,Break-over point for position gain, std=10	
722	10	pulse	Y-axis,Break-over point for position gain, std=10	
723	10	pulse	Z-axis,Break-over point for position gain, std=10	
724	10	pulse	A-axis,Break-over point for position gain, std=10	
725	10	pulse	B-axis,Break-over point for position gain, std=10	
726	10	pulse	C-axis,Break-over point for position gain, std=10	
727	10	pulse	U-axis,Break-over point for position gain, std=10	
728	10	pulse	V-axis,Break-over point for position gain, std=10	
729	10	pulse	W-axis,Break-over point for position gain, std=10	
727-740	10	pulse	System Reserved !	
741	100		X-axis, Denominator, MPG resolution calc.	
742	100		X-axis, Numerator, MPG resolution calc.	
743	100		Y-axis, Denominator, MPG resolution calc.	
744	100		Y-axis, Numerator, MPG resolution calc.	
745	100		Z-axis, Denominator, MPG resolution calc.	
746	100		Z-axis, Numerator, MPG resolution calc.	
747	100		A-axis, Denominator, MPG resolution calc.	
748	100		A-axis, Numerator, MPG resolution calc.	
749	100		B-axis, Denominator, MPG resolution calc.	
750	100		B-axis, Numerator, MPG resolution calc.	
751	100		C-axis, Denominator, MPG resolution calc.	
752	100		C-axis, Numerator, MPG resolution calc.	
753	100		U-axis, Denominator, MPG resolution calc.	
754	100		U-axis, Numerator, MPG resolution calc.	
755	100		V-axis, Denominator, MPG resolution calc.	
756	100		V-axis, Numerator, MPG resolution calc.	

MCM No.	Factory Default Setting	Unit	Description	Setting
757	100		W-axis, Denominator, MPG resolution calc.	
758	100		W-axis, Numerator, MPG resolution calc.	
760-780			System Reserved !	
781	0		Set X-axis as Rotating (1) / Linear axis (0)	
782	0		Set Y-axis as Rotating (1) / Linear axis (0)	
783	0		Set Z-axis as Rotating (1) / Linear axis (0)	
784	0		Set A-axis as Rotating (1) / Linear axis (0)	
785	0		Set B-axis as Rotating (1) / Linear axis (0)	
786	0		Set C-axis as Rotating (1) / Linear axis (0)	
787	0		Set U-axis as Rotating (1) / Linear axis (0)	
788	0		Set V-axis as Rotating (1) / Linear axis (0)	
789	0		Set W-axis as Rotating (1) / Linear axis (0)	
790-800			System Reserved !	
801	0 · 000	mm	Distance of S bit sent before the X-axis reaches in position. (S176)	
802	0 · 000	mm	Distance of S bit sent before the Y-axis reaches in position. (S177)	
803	0 · 000	mm	Distance of S bit sent before the Z-axis reaches in position. (S178)	
804	0 · 000	mm	Distance of S bit sent before the A-axis reaches in position. (S179)	
805	0 · 000	mm	Distance of S bit sent before the B-axis reaches in position. (S180)	
806	0 · 000	mm	Distance of S bit sent before the C-axis reaches in position. (S181)	
807	0 · 000	mm	Distance of S bit sent before the U-axis reaches in position. (S182)	
808	0 · 000	mm	Distance of S bit sent before the V-axis reaches in position. (S183)	
809	0 · 000	mm	Distance of S bit sent before the W-axis reaches in position. (S184)	
810-820			System Reserved !	
821	0	msec	Set Acceleration/Deceleration Time for X-axis	
822	0	msec	Set Acceleration/Deceleration Time for Y-axis	
823	0	msec	Set Acceleration/Deceleration Time for Z-axis	
824	0	msec	Set Acceleration/Deceleration Time for A-axis	
825	0	msec	Set Acceleration/Deceleration Time for B-axis	
826	0	msec	Set Acceleration/Deceleration Time for C-axis	
827	0	msec	Set Acceleration/Deceleration Time for U-axis	
828	0	msec	Set Acceleration/Deceleration Time for V-axis	
829	0	msec	Set Acceleration/Deceleration Time for W-axis	
830-840			System Reserved !	
841	0		X-axis allowable compensation of back screw pitch	
842	0		Y-axis allowable compensation of back screw pitch	
843	0		Z-axis allowable compensation of back screw pitch	

MCM No.	Factory Default Setting	Unit	Description	Setting
844	0		A-axis allowable compensation of back screw pitch	
845	0		B-axis allowable compensation of back screw pitch	
846	0		C-axis allowable compensation of back screw pitch	
847	0		U-axis allowable compensation of back screw pitch	
848	0		V-axis allowable compensation of back screw pitch	
849	0		W-axis allowable compensation of back screw pitch	
850	0		System Reserved !	
851	20000	mm	X-axis length compensation of back screw pitch	
852	20000	mm	Y-axis length compensation of back screw pitch	
853	20000	mm	Z-axis length compensation of back screw pitch	
854	20000	mm	A-axis length compensation of back screw pitch	
855	20000	mm	B-axis length compensation of back screw pitch	
856	20000	mm	C-axis length compensation of back screw pitch	
857~860			System Reserved !	
861-940	0		X-axis,Pitch error compensation of each segment.	
941-1020	0		Y-axis,Pitch error compensation of each segment.	
1021-1100	0		Z-axis,Pitch error compensation of each segment.	
1101-1180	0		A-axis,Pitch error compensation of each segment.	
1181-1260	0		B-axis,Pitch error compensation of each segment.	
1261-1340	0		C-axis,Pitch error compensation of each segment.	
1341	0	mm	Tool #1 radius compensation	
1342	0	mm	X-axis, Tool #1 offset compensation	
1343	0	mm	Y-axis, Tool #1 offset compensation	
1344	0	mm	Z-axis, Tool #1 offset compensation	
1345	0	mm	A-axis, Tool #1 offset compensation	
1346	0	mm	B-axis, Tool #1 offset compensation	
1347	0	mm	C-axis, Tool #1 offset compensation	
1348	0	mm	Tool #2 radius compensation	
1349	0	mm	X-axis, Tool #2 offset compensation	
1350	0	mm	Y-axis, Tool #2 offset compensation	
1351	0	mm	Z-axis, Tool #2 offset compensation	
1352	0	mm	A-axis, Tool #2 offset compensation	
1353	0	mm	B-axis, Tool #2 offset compensation	
1354	0	mm	C-axis, Tool #2 offset compensation	
1355	0	mm	Tool #3 radius compensation	
1356	0	mm	X-axis, Tool #3 offset compensation	
1357	0	mm	Y-axis, Tool #3 offset compensation	
1358	0	mm	Z-axis, Tool #3 offset compensation	
1359	0	mm	A-axis, Tool #3 offset compensation	
1360	0	mm	B-axis, Tool #3 offset compensation	
1361	0	mm	C-axis, Tool #3 offset compensation	

MCM No.	Factory Default Setting	Unit	Description	Setting
1362	0	mm	Tool #4 radius compensation	
1363	0	mm	X-axis, Tool #4 offset compensation	
1364	0	mm	Y-axis, Tool #4 offset compensation	
1365	0	mm	Z-axis, Tool #4 offset compensation	
1366	0	mm	A-axis, Tool #4 offset compensation	
1367	0	mm	B-axis, Tool #4 offset compensation	
1368	0	mm	C-axis, Tool #4 offset compensation	
1369	0	mm	Tool #5 radius compensation	
1370	0	mm	X-axis, Tool #5 offset compensation	
1371	0	mm	Y-axis, Tool #5 offset compensation	
1372	0	mm	Z-axis, Tool #5 offset compensation	
1373	0	mm	A-axis, Tool #5 offset compensation	
1374	0	mm	B-axis, Tool #5 offset compensation	
1375	0	mm	C-axis, Tool #5 offset compensation	
1376	0	mm	Tool #6 radius compensation	
1377	0	mm	X-axis, Tool #6 offset compensation	
1378	0	mm	Y-axis, Tool #6 offset compensation	
1379	0	mm	Z-axis, Tool #6 offset compensation	
1380	0	mm	A-axis, Tool #6 offset compensation	
1381	0	mm	B-axis, Tool #6 offset compensation	
1382	0	mm	C-axis, Tool #6 offset compensation	
1383	0	mm	Tool #7 radius compensation	
1384	0	mm	X-axis, Tool #7 offset compensation	
1385	0	mm	Y-axis, Tool #7 offset compensation	
1386	0	mm	Z-axis, Tool #7 offset compensation	
1387	0	mm	A-axis, Tool #7 offset compensation	
1388	0	mm	B-axis, Tool #7 offset compensation	
1389	0	mm	C-axis, Tool #7 offset compensation	
1390	0	mm	Tool #8 radius compensation	
1391	0	mm	X-axis, Tool #8 offset compensation	
1392	0	mm	Y-axis, Tool #8 offset compensation	
1393	0	mm	Z-axis, Tool #8 offset compensation	
1394	0	mm	A-axis, Tool #8 offset compensation	
1395	0	mm	B-axis, Tool #8 offset compensation	
1396	0	mm	C-axis, Tool #8 offset compensation	
1397	0	mm	Tool #9 radius compensation	
1398	0	mm	X-axis, Tool #9 offset compensation	
1399	0	mm	Y-axis, Tool #9 offset compensation	
1400	0	mm	Z-axis, Tool #9 offset compensation	
1401	0	mm	A-axis, Tool #9 offset compensation	
1402	0	mm	B-axis, Tool #9 offset compensation	
1403	0	mm	C-axis, Tool #9 offset compensation	
1404	0	mm	Tool #10 radius compensation	
1405	0	mm	X-axis, Tool #10 offset compensation	
1406	0	mm	Y-axis, Tool #10 offset compensation	

MCM No.	Factory Default Setting	Unit	Description	Setting
1407	0	mm	Z-axis, Tool #10 offset compensation	
1408	0	mm	A-axis, Tool #10 offset compensation	
1409	0	mm	B-axis, Tool #10 offset compensation	
1410	0	mm	C-axis, Tool #10 offset compensation	
1411	0	mm	Tool #11 radius compensation	
1412	0	mm	X-axis, Tool #11 offset compensation	
1413	0	mm	Y-axis, Tool #11 offset compensation	
1414	0	mm	Z-axis, Tool #11 offset compensation	
1415	0	mm	A-axis, Tool #11 offset compensation	
1416	0	mm	B-axis, Tool #11 offset compensation	
1417	0	mm	C-axis, Tool #11 offset compensation	
1418	0	mm	Tool #12 radius compensation	
1419	0	mm	X-axis, Tool #12 offset compensation	
1420	0	mm	Y-axis, Tool #12 offset compensation	
1421	0	mm	Z-axis, Tool #12 offset compensation	
1422	0	mm	A-axis, Tool #12 offset compensation	
1423	0	mm	B-axis, Tool #12 offset compensation	
1424	0	mm	C-axis, Tool #12 offset compensation	
1425	0	mm	Tool #13 radius compensation	
1426	0	mm	X-axis, Tool #13 offset compensation	
1427	0	mm	Y-axis, Tool #13 offset compensation	
1428	0	mm	Z-axis, Tool #13 offset compensation	
1429	0	mm	A-axis, Tool #13 offset compensation	
1430	0	mm	B-axis, Tool #13 offset compensation	
1431	0	mm	C-axis, Tool #13 offset compensation	
1432	0	mm	Tool #14 radius compensation	
1433	0	mm	X-axis, Tool #14 offset compensation	
1434	0	mm	Y-axis, Tool #14 offset compensation	
1435	0	mm	Z-axis, Tool #14 offset compensation	
1436	0	mm	A-axis, Tool #14 offset compensation	
1437	0	mm	B-axis, Tool #14 offset compensation	
1438	0	mm	C-axis, Tool #14 offset compensation	
1439	0	mm	Tool # radius compensation	
1440	0	mm	X-axis, Tool #15 offset compensation	
1441	0	mm	Y-axis, Tool #15 offset compensation	
1442	0	mm	Z-axis, Tool #15 offset compensation	
1443	0	mm	A-axis, Tool #15 offset compensation	
1444	0	mm	B-axis, Tool #15 offset compensation	
1445	0	mm	C-axis, Tool #15 offset compensation	
1446	0	mm	Tool #16 radius compensation	
1447	0	mm	X-axis, Tool #16 offset compensation	
1448	0	mm	Y-axis, Tool #16 offset compensation	
1449	0	mm	Z-axis, Tool #16 offset compensation	
1450	0	mm	A-axis, Tool #16 offset compensation	
1451	0	mm	B-axis, Tool #16 offset compensation	

MCM No.	Factory Default Setting	Unit	Description	Setting
1452	0	mm	C-axis, Tool #16 offset compensation	
1453	0	mm	Tool #17 radius compensation	
1454	0	mm	X-axis, Tool #17 offset compensation	
1455	0	mm	Y-axis, Tool #17 offset compensation	
1456	0	mm	Z-axis, Tool #17 offset compensation	
1457	0	mm	A-axis, Tool #17 offset compensation	
1458	0	mm	B-axis, Tool #17 offset compensation	
1459	0	mm	C-axis, Tool #17 offset compensation	
1460	0	mm	Tool #18 radius compensation	
1461	0	mm	X-axis, Tool #18 offset compensation	
1462	0	mm	Y-axis, Tool #18 offset compensation	
1463	0	mm	Z-axis, Tool #18 offset compensation	
1464	0	mm	A-axis, Tool #18 offset compensation	
1465	0	mm	B-axis, Tool #18 offset compensation	
1466	0	mm	C-axis, Tool #18 offset compensation	
1467	0	mm	Tool #19 radius compensation	
1468	0	mm	X-axis, Tool #19 offset compensation	
1469	0	mm	Y-axis, Tool #19 offset compensation	
1470	0	mm	Z-axis, Tool #19 offset compensation	
1471	0	mm	A-axis, Tool #19 offset compensation	
1472	0	mm	B-axis, Tool #19 offset compensation	
1473	0	mm	C-axis, Tool #19 offset compensation	
1474	0	mm	Tool #20 radius compensation	
1475	0	mm	X-axis, Tool #20 offset compensation	
1476	0	mm	Y-axis, Tool #20 offset compensation	
1477	0	mm	Z-axis, Tool #20 offset compensation	
1478	0	mm	A-axis, Tool #20 offset compensation	
1479	0	mm	B-axis, Tool #20 offset compensation	
1480	0	mm	C-axis, Tool #20 offset compensation	
1481	0	mm	Tool #21 radius compensation	
1482	0	mm	X-axis, Tool #21 offset compensation	
1483	0	mm	Y-axis, Tool #21 offset compensation	
1484	0	mm	Z-axis, Tool #21 offset compensation	
1485	0	mm	A-axis, Tool #21 offset compensation	
1486	0	mm	B-axis, Tool #21 offset compensation	
1487	0	mm	C-axis, Tool #21 offset compensation	
1488	0	mm	Tool #22 radius compensation	
1489	0	mm	X-axis, Tool #22 offset compensation	
1490	0	mm	Y-axis, Tool #22 offset compensation	
1491	0	mm	Z-axis, Tool #22 offset compensation	
1492	0	mm	A-axis, Tool #22 offset compensation	
1493	0	mm	B-axis, Tool #22 offset compensation	
1494	0	mm	C-axis, Tool #22 offset compensation	
1495	0	mm	Tool #23 radius compensation	
1496	0	mm	X-axis, Tool #23 offset compensation	

MCM No.	Factory Default Setting	Unit	Description	Setting
1497	0	mm	Y-axis, Tool #23 offset compensation	
1498	0	mm	Z-axis, Tool #23 offset compensation	
1499	0	mm	A-axis, Tool #23 offset compensation	
1500	0	mm	B-axis, Tool #23 offset compensation	
1501	0	mm	C-axis, Tool #23 offset compensation	
1502	0	mm	Tool #24 radius compensation	
1503	0	mm	X-axis, Tool #24 offset compensation	
1504	0	mm	Y-axis, Tool #24 offset compensation	
1505	0	mm	Z-axis, Tool #24 offset compensation	
1506	0	mm	A-axis, Tool #24 offset compensation	
1507	0	mm	B-axis, Tool #24 offset compensation	
1508	0	mm	C-axis, Tool #24 offset compensation	
1509	0	mm	Tool #25 radius compensation	
1510	0	mm	X-axis, Tool #25 offset compensation	
1511	0	mm	Y-axis, Tool #25 offset compensation	
1512	0	mm	Z-axis, Tool #25 offset compensation	
1513	0	mm	A-axis, Tool #25 offset compensation	
1514	0	mm	B-axis, Tool #25 offset compensation	
1515	0	mm	C-axis, Tool #25 offset compensation	
1516	0	mm	Tool #26 radius compensation	
1517	0	mm	X-axis, Tool #26 offset compensation	
1518	0	mm	Y-axis, Tool #26 offset compensation	
1519	0	mm	Z-axis, Tool #26 offset compensation	
1520	0	mm	A-axis, Tool #26 offset compensation	
1521	0	mm	B-axis, Tool #26 offset compensation	
1522	0	mm	C-axis, Tool #26 offset compensation	
1523	0	mm	Tool #27 radius compensation	
1524	0	mm	X-axis, Tool #27 offset compensation	
1525	0	mm	Y-axis, Tool #27 offset compensation	
1526	0	mm	Z-axis, Tool #27 offset compensation	
1527	0	mm	A-axis, Tool #27 offset compensation	
1528	0	mm	B-axis, Tool #27 offset compensation	
1529	0	mm	C-axis, Tool #27 offset compensation	
1530	0	mm	Tool #28 radius compensation	
1531	0	mm	X-axis, Tool #28 offset compensation	
1532	0	mm	Y-axis, Tool #28 offset compensation	
1533	0	mm	Z-axis, Tool #28 offset compensation	
1534	0	mm	A-axis, Tool #28 offset compensation	
1535	0	mm	B-axis, Tool #28 offset compensation	
1536	0	mm	C-axis, Tool #28 offset compensation	
1537	0	mm	Tool #29 radius compensation	
1538	0	mm	X-axis, Tool #29 offset compensation	
1539	0	mm	Y-axis, Tool #29 offset compensation	
1540	0	mm	Z-axis, Tool #29 offset compensation	
1541	0	mm	A-axis, Tool #29 offset compensation	

MCM No.	Factory Default Setting	Unit	Description	Setting
1542	0	mm	B-axis, Tool #29 offset compensation	
1543	0	mm	C-axis, Tool #29 offset compensation	
1544	0	mm	Tool #30 radius compensation	
1545	0	mm	X-axis, Tool #30 offset compensation	
1546	0	mm	Y-axis, Tool #30 offset compensation	
1547	0	mm	Z-axis, Tool #30 offset compensation	
1548	0	mm	A-axis, Tool #30 offset compensation	
1549	0	mm	B-axis, Tool #30 offset compensation	
1550	0	mm	C-axis, Tool #30 offset compensation	
1551	0	mm	Tool 31# radius compensation	
1552	0	mm	X-axis, Tool #31 offset compensation	
1553	0	mm	Y-axis, Tool #31 offset compensation	
1554	0	mm	Z-axis, Tool #31 offset compensation	
1555	0	mm	A-axis, Tool #31 offset compensation	
1556	0	mm	B-axis, Tool #31 offset compensation	
1557	0	mm	C-axis, Tool #31 offset compensation	
1558	0	mm	Tool #32 radius compensation	
1559	0	mm	X-axis, Tool #32 offset compensation	
1560	0	mm	Y-axis, Tool #32 offset compensation	
1561	0	mm	Z-axis, Tool #32 offset compensation	
1562	0	mm	A-axis, Tool #32 offset compensation	
1563	0	mm	B-axis, Tool #32 offset compensation	
1564	0	mm	C-axis, Tool #32 offset compensation	
1565	0	mm	Tool #33 radius compensation	
1566	0	mm	X-axis, Tool #33 offset compensation	
1567	0	mm	Y-axis, Tool #33 offset compensation	
1568	0	mm	Z-axis, Tool #33 offset compensation	
1569	0	mm	A-axis, Tool #33 offset compensation	
1570	0	mm	B-axis, Tool #33 offset compensation	
1571	0	mm	C-axis, Tool #33 offset compensation	
1572	0	mm	Tool #34 radius compensation	
1573	0	mm	X-axis, Tool #34 offset compensation	
1574	0	mm	Y-axis, Tool #34 offset compensation	
1575	0	mm	Z-axis, Tool #34 offset compensation	
1576	0	mm	A-axis, Tool #34 offset compensation	
1577	0	mm	B-axis, Tool #34 offset compensation	
1578	0	mm	C-axis, Tool #34 offset compensation	
1579	0	mm	Tool #35 radius compensation	
1580	0	mm	X-axis, Tool #35 offset compensation	
1581	0	mm	Y-axis, Tool #35 offset compensation	
1582	0	mm	Z-axis, Tool #35 offset compensation	
1583	0	mm	A-axis, Tool #35 offset compensation	
1584	0	mm	B-axis, Tool #35 offset compensation	
1585	0	mm	C-axis, Tool #35 offset compensation	
1586	0	mm	Tool #36 radius compensation	

MCM No.	Factory Default Setting	Unit	Description	Setting
1587	0	mm	X-axis, Tool #36 offset compensation	
1588	0	mm	Y-axis, Tool #36 offset compensation	
1589	0	mm	Z-axis, Tool #36 offset compensation	
1590	0	mm	A-axis, Tool #36 offset compensation	
1591	0	mm	B-axis, Tool #36 offset compensation	
1592	0	mm	C-axis, Tool #36 offset compensation	
1593	0	mm	Tool #37 radius compensation	
1594	0	mm	X-axis, Tool #37 offset compensation	
1595	0	mm	Y-axis, Tool #37 offset compensation	
1596	0	mm	Z-axis, Tool #37 offset compensation	
1597	0	mm	A-axis, Tool #37 offset compensation	
1598	0	mm	B-axis, Tool #37 offset compensation	
1599	0	mm	C-axis, Tool #37 offset compensation	
1600	0	mm	Tool #38 radius compensation	
1601	0	mm	X-axis, Tool #38 offset compensation	
1602	0	mm	Y-axis, Tool #38 offset compensation	
1603	0	mm	Z-axis, Tool #38 offset compensation	
1604	0	mm	A-axis, Tool #38 offset compensation	
1605	0	mm	B-axis, Tool #38 offset compensation	
1606	0	mm	C-axis, Tool #38 offset compensation	
1607	0	mm	Tool #39 radius compensation	
1608	0	mm	X-axis, Tool #39 offset compensation	
1609	0	mm	Y-axis, Tool #39 offset compensation	
1610	0	mm	Z-axis, Tool #39 offset compensation	
1611	0	mm	A-axis, Tool #39 offset compensation	
1612	0	mm	B-axis, Tool #39 offset compensation	
1613	0	mm	C-axis, Tool #39 offset compensation	
1614	0	mm	Tool #40 radius compensation	
1615	0	mm	X-axis, Tool #40 offset compensation	
1616	0	mm	Y-axis, Tool #40 offset compensation	
1617	0	mm	Z-axis, Tool #40 offset compensation	
1618	0	mm	A-axis, Tool #40 offset compensation	
1619	0	mm	B-axis, Tool #40 offset compensation	
1620	0	mm	C-axis, Tool #40 offset compensation	
1621	0	mm	Tool #1 radius wear compensation	
1622	0	mm	X-axis, Tool #1 wear compensation	
1623	0	mm	Y-axis, Tool #1 wear compensation	
1624	0	mm	Z-axis, Tool #1 wear compensation	
1625	0	mm	A-axis, Tool #1 wear compensation	
1626	0	mm	B-axis, Tool #1 wear compensation	
1627	0	mm	C-axis, Tool #1 wear compensation	
1628	0	mm	Tool #2 radius wear compensation	
1629	0	mm	X-axis, Tool #2 wear compensation	
1630	0	mm	Y-axis, Tool #2 wear compensation	
1631	0	mm	Z-axis, Tool #2 wear compensation	

MCM No.	Factory Default Setting	Unit	Description	Setting
1632	0	mm	A-axis, Tool #2 wear compensation	
1633	0	mm	B-axis, Tool #2 wear compensation	
1634	0	mm	C-axis, Tool #2 wear compensation	
1635	0	mm	Tool #3 radius wear compensation	
1636	0	mm	X-axis, Tool #3 wear compensation	
1637	0	mm	Y-axis, Tool #3 wear compensation	
1638	0	mm	Z-axis, Tool #3 wear compensation	
1639	0	mm	A-axis, Tool #3 wear compensation	
1640	0	mm	B-axis, Tool #3 wear compensation	
1641	0	mm	C-axis, Tool #3 wear compensation	
1642	0	mm	Tool #4 radius wear compensation	
1643	0	mm	X-axis, Tool #4 wear compensation	
1644	0	mm	Y-axis, Tool #4 wear compensation	
1645	0	mm	Z-axis, Tool #4 wear compensation	
1646	0	mm	A-axis, Tool #4 wear compensation	
1647	0	mm	B-axis, Tool #4 wear compensation	
1648	0	mm	C-axis, Tool #4 wear compensation	
1649	0	mm	Tool #5 radius wear compensation	
1650	0	mm	X-axis, Tool #5 wear compensation	
1651	0	mm	Y-axis, Tool #5 wear compensation	
1652	0	mm	Z-axis, Tool #5 wear compensation	
1653	0	mm	A-axis, Tool #5 wear compensation	
1654	0	mm	B-axis, Tool #5 wear compensation	
1655	0	mm	C-axis, Tool #5 wear compensation	
1656	0	mm	Tool #6 radius wear compensation	
1657	0	mm	X-axis, Tool #6 wear compensation	
1658	0	mm	Y-axis, Tool #6 wear compensation	
1659	0	mm	Z-axis, Tool #6 wear compensation	
1660	0	mm	A-axis, Tool #6 wear compensation	
1661	0	mm	B-axis, Tool #6 wear compensation	
1662	0	mm	C-axis, Tool #6 wear compensation	
1663	0	mm	Tool #7 radius wear compensation	
1664	0	mm	X-axis, Tool #7 wear compensation	
1665	0	mm	Y-axis, Tool #7 wear compensation	
1666	0	mm	Z-axis, Tool #7 wear compensation	
1667	0	mm	A-axis, Tool #7 wear compensation	
1668	0	mm	B-axis, Tool #7 wear compensation	
1669	0	mm	C-axis, Tool #7 wear compensation	
1670	0	mm	Tool #8 radius wear compensation	
1671	0	mm	X-axis, Tool #8 wear compensation	
1672	0	mm	Y-axis, Tool #8 wear compensation	
1673	0	mm	Z-axis, Tool #8 wear compensation	
1674	0	mm	A-axis, Tool #8 wear compensation	
1675	0	mm	B-axis, Tool #8 wear compensation	
1676	0	mm	C-axis, Tool #8 wear compensation	

MCM No.	Factory Default Setting	Unit	Description	Setting
1677	0	mm	Tool #9 radius wear compensation	
1678	0	mm	X-axis, Tool #9 wear compensation	
1679	0	mm	Y-axis, Tool #9 wear compensation	
1680	0	mm	Z-axis, Tool #9 wear compensation	
1681	0	mm	A-axis, Tool #9 wear compensation	
1682	0	mm	B-axis, Tool #9 wear compensation	
1683	0	mm	C-axis, Tool #9 wear compensation	
1684	0	mm	Tool #10 radius wear compensation	
1685	0	mm	X-axis, Tool #10 wear compensation	
1686	0	mm	Y-axis, Tool #10 wear compensation	
1687	0	mm	Z-axis, Tool #10 wear compensation	
1688	0	mm	A-axis, Tool #10 wear compensation	
1689	0	mm	B-axis, Tool #10 wear compensation	
1690	0	mm	C-axis, Tool #10 wear compensation	
1691	0	mm	Tool #11 radius wear compensation	
1692	0	mm	X-axis, Tool #11 wear compensation	
1693	0	mm	Y-axis, Tool #11 wear compensation	
1694	0	mm	Z-axis, Tool #11 wear compensation	
1695	0	mm	A-axis, Tool #11 wear compensation	
1696	0	mm	B-axis, Tool #11 wear compensation	
1697	0	mm	C-axis, Tool #11 wear compensation	
1698	0	mm	Tool #12 radius wear compensation	
1699	0	mm	X-axis, Tool #12 wear compensation	
1700	0	mm	Y-axis, Tool #12 wear compensation	
1701	0	mm	Z-axis, Tool #12 wear compensation	
1702	0	mm	A-axis, Tool #12 wear compensation	
1703	0	mm	B-axis, Tool #12 wear compensation	
1704	0	mm	C-axis, Tool #12 wear compensation	
1705	0	mm	Tool #13 radius wear compensation	
1706	0	mm	X-axis, Tool #13 wear compensation	
1707	0	mm	Y-axis, Tool #13 wear compensation	
1708	0	mm	Z-axis, Tool #13 wear compensation	
1709	0	mm	A-axis, Tool #13 wear compensation	
1710	0	mm	B-axis, Tool #13 wear compensation	
1711	0	mm	C-axis, Tool #13 wear compensation	
1712	0	mm	Tool #14 radius wear compensation	
1713	0	mm	X-axis, Tool #14 wear compensation	
1714	0	mm	Y-axis, Tool #14 wear compensation	
1715	0	mm	Z-axis, Tool #14 wear compensation	
1716	0	mm	A-axis, Tool #14 wear compensation	
1717	0	mm	B-axis, Tool #14 wear compensation	
1718	0	mm	C-axis, Tool #14 wear compensation	
1719	0	mm	Tool #15 radius wear compensation	
1720	0	mm	X-axis, Tool #15 wear compensation	
1721	0	mm	Y-axis, Tool #15 wear compensation	

MCM No.	Factory Default Setting	Unit	Description	Setting
1722	0	mm	Z-axis, Tool #15 wear compensation	
1723	0	mm	A-axis, Tool #15 wear compensation	
1724	0	mm	B-axis, Tool #15 wear compensation	
1725	0	mm	C-axis, Tool #15 wear compensation	
1726	0	mm	Tool #16 radius wear compensation	
1727	0	mm	X-axis, Tool #16 wear compensation	
1728	0	mm	Y-axis, Tool #16 wear compensation	
1729	0	mm	Z-axis, Tool #16 wear compensation	
1730	0	mm	A-axis, Tool #16 wear compensation	
1731	0	mm	B-axis, Tool #16 wear compensation	
1732	0	mm	C-axis, Tool #16 wear compensation	
1733	0	mm	Tool #17 radius wear compensation	
1734	0	mm	X-axis, Tool #17 wear compensation	
1735	0	mm	Y-axis, Tool #17 wear compensation	
1736	0	mm	Z-axis, Tool #17 wear compensation	
1737	0	mm	A-axis, Tool #17 wear compensation	
1738	0	mm	B-axis, Tool #17 wear compensation	
1739	0	mm	C-axis, Tool #17 wear compensation	
1740	0	mm	Tool #18 radius wear compensation	
1741	0	mm	X-axis, Tool #18 wear compensation	
1742	0	mm	Y-axis, Tool #18 wear compensation	
1743	0	mm	Z-axis, Tool #18 wear compensation	
1744	0	mm	A-axis, Tool #18 wear compensation	
1745	0	mm	B-axis, Tool #18 wear compensation	
1746	0	mm	C-axis, Tool #18 wear compensation	
1747	0	mm	Tool #19 radius wear compensation	
1748	0	mm	X-axis, Tool #19 wear compensation	
1749	0	mm	Y-axis, Tool #19 wear compensation	
1750	0	mm	Z-axis, Tool #19 wear compensation	
1751	0	mm	A-axis, Tool #19 wear compensation	
1752	0	mm	B-axis, Tool #19 wear compensation	
1753	0	mm	C-axis, Tool #19 wear compensation	
1754	0	mm	Tool #20 radius wear compensation	
1755	0	mm	X-axis, Tool #20 wear compensation	
1756	0	mm	Y-axis, Tool #20 wear compensation	
1757	0	mm	Z-axis, Tool #20 wear compensation	
1758	0	mm	A-axis, Tool #20 wear compensation	
1759	0	mm	B-axis, Tool #20 wear compensation	
1760	0	mm	C-axis, Tool #20 wear compensation	
1761	0	mm	Tool #21 radius wear compensation	
1762	0	mm	X-axis, Tool #21 wear compensation	
1763	0	mm	Y-axis, Tool #21 wear compensation	
1764	0	mm	Z-axis, Tool #21 wear compensation	
1765	0	mm	A-axis, Tool #21 wear compensation	
1766	0	mm	B-axis, Tool #21 wear compensation	

MCM No.	Factory Default Setting	Unit	Description	Setting
1767	0	mm	C-axis, Tool #21 wear compensation	
1768	0	mm	Tool #22 radius wear compensation	
1769	0	mm	X-axis, Tool #22 wear compensation	
1770	0	mm	Y-axis, Tool #22 wear compensation	
1771	0	mm	Z-axis, Tool #22 wear compensation	
1772	0	mm	A-axis, Tool #22 wear compensation	
1773	0	mm	B-axis, Tool #22 wear compensation	
1774	0	mm	C-axis, Tool #22 wear compensation	
1775	0	mm	Tool #23 radius wear compensation	
1776	0	mm	X-axis, Tool #23 wear compensation	
1777	0	mm	Y-axis, Tool #23 wear compensation	
1778	0	mm	Z-axis, Tool #23 wear compensation	
1779	0	mm	A-axis, Tool #23 wear compensation	
1780	0	mm	B-axis, Tool #23 wear compensation	
1781	0	mm	C-axis, Tool #23 wear compensation	
1782	0	mm	Tool #24 radius wear compensation	
1783	0	mm	X-axis, Tool #24 wear compensation	
1784	0	mm	Y-axis, Tool #24 wear compensation	
1785	0	mm	Z-axis, Tool #24 wear compensation	
1786	0	mm	A-axis, Tool #24 wear compensation	
1787	0	mm	B-axis, Tool #24 wear compensation	
1788	0	mm	C-axis, Tool #24 wear compensation	
1789	0	mm	Tool #25 radius wear compensation	
1790	0	mm	X-axis, Tool #25 wear compensation	
1791	0	mm	Y-axis, Tool #25 wear compensation	
1792	0	mm	Z-axis, Tool #25 wear compensation	
1793	0	mm	A-axis, Tool #25 wear compensation	
1794	0	mm	B-axis, Tool #25 wear compensation	
1795	0	mm	C-axis, Tool #25 wear compensation	
1796	0	mm	Tool #26 radius wear compensation	
1797	0	mm	X-axis, Tool #26 wear compensation	
1798	0	mm	Y-axis, Tool #26 wear compensation	
1799	0	mm	Z-axis, Tool #26 wear compensation	
1800	0	mm	A-axis, Tool #26 wear compensation	
1801	0	mm	B-axis, Tool #26 wear compensation	
1802	0	mm	C-axis, Tool #26 wear compensation	
1803	0	mm	Tool #27 radius wear compensation	
1804	0	mm	X-axis, Tool #27 wear compensation	
1805	0	mm	Y-axis, Tool #27 wear compensation	
1806	0	mm	Z-axis, Tool #27 wear compensation	
1807	0	mm	A-axis, Tool #27 wear compensation	
1808	0	mm	B-axis, Tool #27 wear compensation	
1809	0	mm	C-axis, Tool #27 wear compensation	
1810	0	mm	Tool #28 radius wear compensation	
1811	0	mm	X-axis, Tool #28 wear compensation	

MCM No.	Factory Default Setting	Unit	Description	Setting
1812	0	mm	Y-axis, Tool #28 wear compensation	
1813	0	mm	Z-axis, Tool #28 wear compensation	
1814	0	mm	A-axis, Tool #28 wear compensation	
1815	0	mm	B-axis, Tool #28 wear compensation	
1816	0	mm	C-axis, Tool #28 wear compensation	
1817	0	mm	Tool #29 radius wear compensation	
1818	0	mm	X-axis, Tool #29 wear compensation	
1819	0	mm	Y-axis, Tool #29 wear compensation	
1820	0	mm	Z-axis, Tool #29 wear compensation	
1821	0	mm	A-axis, Tool #29 wear compensation	
1822	0	mm	B-axis, Tool #29 wear compensation	
1823	0	mm	C-axis, Tool #29 wear compensation	
1824	0	mm	Tool #30 radius wear compensation	
1825	0	mm	X-axis, Tool #30 wear compensation	
1826	0	mm	Y-axis, Tool #30 wear compensation	
1827	0	mm	Z-axis, Tool #30 wear compensation	
1828	0	mm	A-axis, Tool #30 wear compensation	
1829	0	mm	B-axis, Tool #30 wear compensation	
1830	0	mm	C-axis, Tool #30 wear compensation	
1831	0	mm	Tool #31 radius wear compensation	
1832	0	mm	X-axis, Tool #31 wear compensation	
1833	0	mm	Y-axis, Tool #31 wear compensation	
1834	0	mm	Z-axis, Tool #31 wear compensation	
1835	0	mm	A-axis, Tool #31 wear compensation	
1836	0	mm	B-axis, Tool #31 wear compensation	
1837	0	mm	C-axis, Tool #31 wear compensation	
1838	0	mm	Tool #32 radius wear compensation	
1839	0	mm	X-axis, Tool #32 wear compensation	
1840	0	mm	Y-axis, Tool #32 wear compensation	
1841	0	mm	Z-axis, Tool #32 wear compensation	
1842	0	mm	A-axis, Tool #32 wear compensation	
1843	0	mm	B-axis, Tool #32 wear compensation	
1844	0	mm	C-axis, Tool #32 wear compensation	
1845	0	mm	Tool #33 radius wear compensation	
1846	0	mm	X-axis, Tool #33 wear compensation	
1847	0	mm	Y-axis, Tool #33 wear compensation	
1848	0	mm	Z-axis, Tool #33 wear compensation	
1849	0	mm	A-axis, Tool #33 wear compensation	
1850	0	mm	B-axis, Tool #33 wear compensation	
1851	0	mm	C-axis, Tool #33 wear compensation	
1852	0	mm	Tool #34 radius wear compensation	
1853	0	mm	X-axis, Tool #34 wear compensation	
1854	0	mm	Y-axis, Tool #34 wear compensation	
1855	0	mm	Z-axis, Tool #34 wear compensation	
1856	0	mm	A-axis, Tool #34 wear compensation	

MCM No.	Factory Default Setting	Unit	Description	Setting
1857	0	mm	B-axis, Tool #34 wear compensation	
1858	0	mm	C-axis, Tool #34 wear compensation	
1859	0	mm	Tool #35 radius wear compensation	
1860	0	mm	X-axis, Tool #35 wear compensation	
1861	0	mm	Y-axis, Tool #35 wear compensation	
1862	0	mm	Z-axis, Tool #35 wear compensation	
1863	0	mm	A-axis, Tool #35 wear compensation	
1864	0	mm	B-axis, Tool #35 wear compensation	
1865	0	mm	C-axis, Tool #35 wear compensation	
1866	0	mm	Tool #36 radius wear compensation	
1867	0	mm	X-axis, Tool #36 wear compensation	
1868	0	mm	Y-axis, Tool #36 wear compensation	
1869	0	mm	Z-axis, Tool #36 wear compensation	
1870	0	mm	A-axis, Tool #36 wear compensation	
1871	0	mm	B-axis, Tool #36 wear compensation	
1872	0	mm	C-axis, Tool #36 wear compensation	
1873	0	mm	Tool #37 radius wear compensation	
1874	0	mm	X-axis, Tool #37 wear compensation	
1875	0	mm	Y-axis, Tool #37 wear compensation	
1876	0	mm	Z-axis, Tool #37 wear compensation	
1877	0	mm	A-axis, Tool #37 wear compensation	
1878	0	mm	B-axis, Tool #37 wear compensation	
1879	0	mm	C-axis, Tool #37 wear compensation	
1880	0	mm	Tool #38 radius wear compensation	
1881	0	mm	X-axis, Tool #38 wear compensation	
1882	0	mm	Y-axis, Tool #38 wear compensation	
1883	0	mm	Z-axis, Tool #38 wear compensation	
1884	0	mm	A-axis, Tool #38 wear compensation	
1885	0	mm	B-axis, Tool #38 wear compensation	
1886	0	mm	C-axis, Tool #38 wear compensation	
1887	0	mm	Tool #39 radius wear compensation	
1888	0	mm	X-axis, Tool #39 wear compensation	
1889	0	mm	Y-axis, Tool #39 wear compensation	
1890	0	mm	Z-axis, Tool #39 wear compensation	
1891	0	mm	A-axis, Tool #39 wear compensation	
1892	0	mm	B-axis, Tool #39 wear compensation	
1893	0	mm	C-axis, Tool #39 wear compensation	
1894	0	mm	Tool #40 radius wear compensation	
1895	0	mm	X-axis, Tool #40 wear compensation	
1896	0	mm	Y-axis, Tool #40 wear compensation	
1897	0	mm	Z-axis, Tool #40 wear compensation	
1898	0	mm	A-axis, Tool #40 wear compensation	
1899	0	mm	B-axis, Tool #40 wear compensation	
1900	0	mm	C-axis, Tool #40 wear compensation	
1901			Tool-tip #1 radius compensation	

MCM No.	Factory Default Setting	Unit	Description	Setting
1902			Tool-tip #2 radius compensation	
1903			Tool-tip #3 radius compensation	
1904			Tool-tip #4 radius compensation	
1905			Tool-tip #5 radius compensation	
1906			Tool-tip #6 radius compensation	
1907			Tool-tip #7 radius compensation	
1908			Tool-tip #8 radius compensation	
1909			Tool-tip #9 radius compensation	
1910			Tool-tip #10 radius compensation	
1911			Tool-tip #11 radius compensation	
1912			Tool-tip #12 radius compensation	
1913			Tool-tip #13 radius compensation	
1914			Tool-tip #14 radius compensation	
1915			Tool-tip #15 radius compensation	
1916			Tool-tip #16 radius compensation	
1917			Tool-tip #17 radius compensation	
1918			Tool-tip #18 radius compensation	
1919			Tool-tip #19 radius compensation	
1920			Tool-tip #20 radius compensation	
1921			Tool-tip #21 radius compensation	
1922			Tool-tip #22 radius compensation	
1923			Tool-tip #23 radius compensation	
1924			Tool-tip #24 radius compensation	
1925			Tool-tip #25 radius compensation	
1926			Tool-tip #26 radius compensation	
1927			Tool-tip #27 radius compensation	
1928			Tool-tip #28 radius compensation	
1929			Tool-tip #29 radius compensation	
1930			Tool-tip #30 radius compensation	
1931			Tool-tip #31 radius compensation	
1932			Tool-tip #32 radius compensation	
1933			Tool-tip #33 radius compensation	
1934			Tool-tip #34 radius compensation	
1935			Tool-tip #35 radius compensation	
1936			Tool-tip #36 radius compensation	
1937			Tool-tip #37 radius compensation	
1938			Tool-tip #38 radius compensation	
1939			Tool-tip #39 radius compensation	
1940			Tool-tip #40 radius compensation	

PS: Press PAGE↑ or PAGE↓ once will change twelve items.

4.2 Description of MCM Machine Constants

The decimal format for MCM data in this section is based on 4/3 format.

MCM #1~#36 are for G54~G59 work coordinates data. The setting value is the distance between the origin of each work coordinate system and the machine HOME position. All input data have the same format and unit as shown below:

G54 (1st) Work Coordinate, X-axis.

G54 (1st) Work Coordinate, Y-axis.

G54 (1st) Work Coordinate, Z-axis.

G54 (1st) Work Coordinate, A-axis.

G54 (1st) Work Coordinate, B-axis.

G54 (1st) Work Coordinate, C-axis.

G54 (1st) Work Coordinate, U-axis.

G54 (1st) Work Coordinate, V-axis.

G54 (1st) Work Coordinate, W-axis.

Format : □.□□□ , Unit: mm (Default=0.000)

MCM# 10~20 System Reserved !

21. G55 (2nd) Work Coordinate, X-axis.

22. G55 (2nd) Work Coordinate, Y-axis.

23. G55 (2nd) Work Coordinate, Z-axis.

24. G55 (2nd) Work Coordinate, A-axis.

25. G55 (2nd) Work Coordinate, B-axis.

26. G55 (2nd) Work Coordinate, C-axis.

27. G55 (2nd) Work Coordinate, U-axis.

28. G55 (2nd) Work Coordinate, V-axis.

29. G55 (2nd) Work Coordinate, W-axis.

Format : □.□□□ , Unit: mm (Default=0.000)

MCM# 30~40 System Reserved !

41. G56 (3rd) Work Coordinate, X-axis.

42. G56 (3rd) Work Coordinate, Y-axis.

43. G56 (3rd) Work Coordinate, Z-axis.

44. G56 (3rd) Work Coordinate, A-axis.

- 45. G56 (3rd) Work Coordinate, B-axis.
 - 46. G56 (3rd) Work Coordinate, C-axis.
 - 47. G56 (3rd) Work Coordinate, U-axis.
 - 48. G56 (3rd) Work Coordinate, V-axis.
 - 49. G56 (3rd) Work Coordinate, W-axis.
- Format : □.□□□ , Unit: mm (Default=0.000)

MCM# 50~60 System Reserved !

- MCM# 61~69 G57 (4th) Work Coordinate.
- MCM# 70~80 System Reserved !

- MCM# 81~89 G58 (5th) Work Coordinate.
- MCM# 90~100 System Reserved !

- MCM# 101~109 G59 (6th) Work Coordinate.
- MCM# 110~120 System Reserved !

MCM Parameters 121~160 are used for setting the coordinates of the reference point. Its value is the mechanical coordinates of the reference point relative to the mechanical origin.

- 121. G28 1st Reference Point Data, X-axis.
 - 122. G28 1st Reference Point Data, Y-axis.
 - 123. G28 1st Reference Point Data, Z-axis.
 - 124. G28 1st Reference Point Data, A-axis.
 - 125. G28 1st Reference Point Data, B-axis.
 - 126. G28 1st Reference Point Data, C-axis.
 - 127. G28 1st Reference Point Data, U-axis.
 - 128. G28 1st Reference Point Data, V-axis.
 - 129. G28 1st Reference Point Data, W-axis.
- Format : □.□□□ , Unit: mm (Default=0.000)

MCM# 130~140 System Reserved !

- 141. G30 2st Reference Point Data, X-axis.
- 142. G30 2st Reference Point Data, Y-axis.
- 143. G30 2st Reference Point Data, Z-axis.
- 144. G30 2st Reference Point Data, A-axis.

- 145. G30 2st Reference Point Data, B-axis.
 - 146. G30 2st Reference Point Data, C-axis.
 - 147. G30 2st Reference Point Data, U-axis.
 - 148. G30 2st Reference Point Data, V-axis.
 - 149. G30 2st Reference Point Data, W-axis.
- Format : □.□□□ , Unit: mm (Default=0.000)

MCM# 150~160 System Reserved !

- 161. Backlash Compensation (G01), X-axis.
 - 162. Backlash Compensation (G01), Y-axis.
 - 163. Backlash Compensation (G01), Z-axis.
 - 164. Backlash Compensation (G01), A-axis.
 - 165. Backlash Compensation (G01), B-axis.
 - 166. Backlash Compensation (G01), C-axis.
 - 167. Backlash Compensation (G01), U-axis.
 - 168. Backlash Compensation (G01), V-axis.
 - 169. Backlash Compensation (G01), W-axis.
- Format : □.□□□ , Unit: pulse (Default=0) Range:0~9.9999

MCM# 170~180 System Reserved !

- 181. Backlash Compensation (G00), X-axis.
 - 182. Backlash Compensation (G00), Y-axis.
 - 183. Backlash Compensation (G00), Z-axis.
 - 184. Backlash Compensation (G00), A-axis.
 - 185. Backlash Compensation (G00), B-axis.
 - 186. Backlash Compensation (G00), C-axis.
 - 187. Backlash Compensation (G00), U-axis.
 - 188. Backlash Compensation (G00), V-axis.
 - 189. Backlash Compensation (G00), W-axis.
- Format : □.□□□ , Unit: pulse (Default=0) Range:0~9.9999

MCM# 170~200 System Reserved !

- 201. Jog Speed, X-axis.
- 202. Jog Speed, Y-axis.
- 203. Jog Speed, Z-axis.
- 204. Jog Speed, A-axis.

205. Jog Speed, B-axis.

206. Jog Speed, C-axis.

207. Jog Speed, U-axis.

208. Jog Speed, V-axis.

209. Jog Speed, W-axis.

Format : □.□□□ , Unit: mm/min (Default=1000)

MCM# 210~220 System Reserved !

221. Traverse Speed Limit, X-axis.

222. Traverse Speed Limit, Y-axis.

223. Traverse Speed Limit, Z-axis.

224. Traverse Speed Limit, A-axis.

225. Traverse Speed Limit, B-axis.

226. Traverse Speed Limit, C-axis.

227. Traverse Speed Limit, U-axis.

228. Traverse Speed Limit, V-axis.

229. Traverse Speed Limit, W-axis.

Format : □□□□□ , Unit: mm/min (Default=10000)

Note : The format is only for integer.

The traverse speed limit can be calculated from the following equation:

$$F_{max} = 0.95 * RPM * Pitch * GR$$

RPM : The ratio. rpm of servo motor

Pitch : The pitch of the ball-screw

GR : Gear ratio of ball-screw/motor

Ex: Max. rpm = 3000 rpm for X-axis, Pitch = 5 mm/rev, Gear Ratio = 5/1

$$F_{max} = 0.95 * 3000 * 5 / 5 = 2850 \text{ mm/min}$$

Therefore, it is recommended to set MCM #148=2850.

MCM# 230~240 System Reserved !

241. Denominator of Machine Resolution, X-axis.

242. Numerator of Machine Resolution, X-axis.

243. Denominator of Machine Resolution, Y-axis.

244. Numerator of Machine Resolution, Y-axis.

- 245. Denominator of Machine Resolution, Z-axis.
- 246. Numerator of Machine Resolution, Z-axis.
- 247. Denominator of Machine Resolution, A-axis.
- 248. Numerator of Machine Resolution, A-axis.
- 249. Denominator of Machine Resolution, B-axis.
- 250. Numerator of Machine Resolution, B-axis.
- 251. Denominator of Machine Resolution, C-axis.
- 252. Numerator of Machine Resolution, C-axis.
- 253. Denominator of Machine Resolution, U-axis.
- 254. Numerator of Machine Resolution, U-axis.
- 255. Denominator of Machine Resolution, V-axis.
- 256. Numerator of Machine Resolution, V-axis.
- 257. Denominator of Machine Resolution, W-axis.
- 258. Numerator of Machine Resolution, W-axis.

Format : □.□□□ , (Default=100)

Denominator (D) = pulses/rev for the encoder on motor.

Numerator (N) = pitch length (mm/rev) of the ball-screw.

Gear Ratio (GR) = Tooth No. on ball-screw / Tooth No. on motor.

Pulse Multiplication Factor (MF) = MCM #416~#469.

$$\text{Machine Resolution} = \frac{(\text{Pitch of Ball - screw})}{(\text{Encoder Pulse}) * (\text{MF})} * \frac{1}{\text{GR}}$$

Ex1: X-axis as linear axis (MCM #781=0), pitch = 5 mm = 5000 μm
 Encoder = 2500 pulses, MCM #461 = 4, and GR = 5 (motor rotates 5 times while ball-screw rotates once)

Machine resolution = 5000/(2500 × 4)/5 = 5000/50000 = 1/10 = 0.1 μm/pulse

Therefore, the setting value for MCM #118 (D) and #119 (N) can be set as or the same ratio of N/D such as. They are all correct.

(1) D=50000, N=5000 (2) D=10, N=1 (3) D=100, N=10

Ex2: Y-axis as rotating axis (MCM #782=1), Angle = 360.000 deg/circle
 Encoder = 2500 pulses, MCM #161 = 4, and GR = 5 (motor rotates 5 times while ball-screw rotates once)

$$\text{Machine resolution} = 360000 / (2500 \times 4) / 5 = 360000 / 50000 = 36/5 = 72/10$$

Therefore, the setting value for MCM #120 (D) and #121 (N) can be one of the three combinations. They are all correct.

(1) D=5, N=36 (2) D=10, N=72 (3) D=50000, N=360000

Ex 3 (Position Linear Axis):

The X-axis is an ordinary linear axis (MCM#781= 0) with the guide screw pitch = 5.000 mm.

When the motor rotates one turn, 10000 pulses will be generated.

Gear ratio is 5:1 (When the servo motor rotates 5 turns, the guide screw rotates 1 turn.)

$$\begin{aligned} \text{Resolution} &= \frac{5000}{10000} \times \frac{1}{5} \\ &= \frac{1}{10} \end{aligned}$$

X-axis resolution: denominator setting value (**MCM#241**)= 10

X-axis resolution: numerator setting value (**MCM#242**)= 1

Ex 4 (Position type rotational axis):

The Y-axis is a rotational axis (MCM#782 = 1). The angle for rotating 1 turn = 360.000 (degree)

One turn of the motor will generate 10000 pulses.

Gear ratio is 5:1 (When the servo motor rotates 5 turns, the Y-axis rotates 1 turn.)

$$\begin{aligned} \text{Resolution} &= \frac{360000}{10000} \times \frac{1}{5} \\ &= \frac{36}{5} \end{aligned}$$

Y-axis resolution: denominator setting value (**MCM#243**) = 5

Y-axis resolution: numerator setting value (**MCM#244**) = 36

Note 1: When the resolution $< 1/20$, the motor may have the problem of not able to reach its maximum rotation speed.

**Note 2: When the resolution $< 1/100$, the software travel limit should be within the following range:
-9999999 ~ 999999, otherwise an error message may occur which cannot be released.**

Ex: For MCM#241=400 and MCM#242=2, when the X-axis resolution is smaller than 1/100, the setting values of the software travel limit for the X-axis: Parameter 581 should be less than 9999999 and Parameter 601 should be greater than -999999.

MCM# 259~280 System Reserved !

- 281. Home Direction for Tool, X-axis.
- 282. Home Direction for Tool, Y-axis.
- 283. Home Direction for Tool, Z-axis.
- 284. Home Direction for Tool, A-axis.
- 285. Home Direction for Tool, B-axis.
- 286. Home Direction for Tool, C-axis.
- 287. Home Direction for Tool, U-axis.
- 288. Home Direction for Tool, V-axis.
- 289. Home Direction for Tool, W-axis.

Format : □ , (Default=0)

Setting = 0, Tool returning to HOME in the positive direction.

Setting = 1, Tool returning to HOME in the negative direction

MCM# 290~300 System Reserved !

- 301. Home Speed When Tool Going to Home, X-axis.
- 302. Home Speed When Tool Going to Home, Y-axis.
- 303. Home Speed When Tool Going to Home, Z-axis.
- 304. Home Speed When Tool Going to Home, A-axis.
- 305. Home Speed When Tool Going to Home, B-axis.
- 306. Home Speed When Tool Going to Home, C-axis.
- 307. Home Speed When Tool Going to Home, U-axis
- 308. Home Speed When Tool Going to Home, V-axis

309. Home Speed When Tool Going to Home, W-axis
Format : □□□□ , Unit: mm/min (Default=2500)

MCM# 310~320 System Reserved !

321. Home Grid Speed When Tool Going to Home, X-axis.
322. Home Grid Speed When Tool Going to Home, Y-axis.
323. Home Grid Speed When Tool Going to Home, Z-axis.
324. Home Grid Speed When Tool Going to Home, A-axis.
325. Home Grid Speed When Tool Going to Home, B-axis.
326. Home Grid Speed When Tool Going to Home, C-axis.
327. Home Grid Speed When Tool Going to Home, U-axis.
328. Home Grid Speed When Tool Going to Home, V-axis.
329. Home Grid Speed When Tool Going to Home, W-axis.
Format : □□□□ , Unit: mm/min (Default=40)

MCM# 330~340 System Reserved !

341. The direction that servo motor search the Grid when X-axis going back to HOME.
342. The direction that servo motor search the Grid when Y-axis going back to HOME.
343. The direction that servo motor search the Grid when Z-axis going back to HOME.
344. The direction that servo motor search the Grid when A-axis going back to HOME.
345. The direction that servo motor search the Grid when B-axis going back to HOME.
346. The direction that servo motor search the Grid when C-axis going back to HOME.
347. The direction that servo motor search the Grid when U-axis going back to HOME.
348. The direction that servo motor search the Grid when V-axis going back to HOME.
349. The direction that servo motor search the Grid when W-axis going back to HOME.
Format : □ , (Default=0)

EX:

When MCM#341= 0, the 2nd and 3rd direction is the same with 1st
 MCM#341= 1, the 2nd is the same with 1st .
 MCM#341= 128, the 2nd direction is opposite to 1st .
 MCM#341= 256, the 2nd and 3rd direction is opposite to 1st .

Set the moving speed when the tool, after having touched the HOME limit switch, is searching for the encoder grid signal during HOME execution. HUST H4D / H6D/ H9D CNC has three (3) different speeds when you execute HOME function as shown by Fig 7.2.

- Speed 1: The motor accelerates to Speed 1 and its maximum speed is determined by the settings of MCM #301 ~ #309, (X, Y, Z, A, B, C, U, V, W-axis) and the direction by MCM #281 ~ #289. When tool touches the home limit switch, it starts deceleration to a stop.
- Speed 2: The motor accelerates again to speed 2 and its maximum speed is equal to 1/4 of Speed 1 and the direction is by MCM #341~#349. When tool starts leaving the home limit switch, it starts deceleration to a stop.
- Speed 3: The motor accelerates to speed 3 and its maximum speed is determined by the settings of MCM #321~#329 and the direction by MCM #341~#349. Once the encoder grid index is found, motor decelerates to a stop. This is the HOME position.

Note that the length of the Home limit switch should be longer than the distance for the deceleration of Speed 1. Otherwise, serious error may result. The equation to calculate the length of the Home limit switch is

$$\text{Length of Home Limit Switch (mm)} \geq \frac{\text{FDCOM} * \text{ACC}}{60000}$$

FDCOM = Speed 1, in mm/min. (MCM #301~ #309)
 ACC = Time for acceleration/deceleration, in ms. (MCM #505)
 60000 = 60 seconds = 60 * 1000 milliseconds

When the C-bit C063=1 in PLC program, it commands the controller to do homing operation. Do homing operation for X-axis if R232=1, do

Y-axis if R232=2, do Z-axis if R232=4, do A-axis if R232=8 and do four axes simultaneously if R232=15.

Ex: FDCOM = 3000.00 mm/min, and ACC = 100 ms

Length of Home Limit Switch = $3000 * 100 / 60000 = 5$ mm

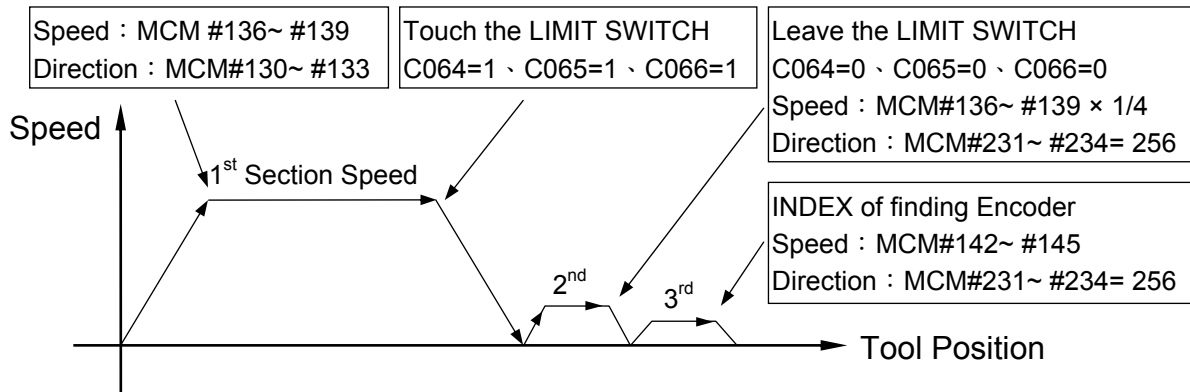

Fig 4-7 (A) Homing Speed and Direction of finding (GRID)

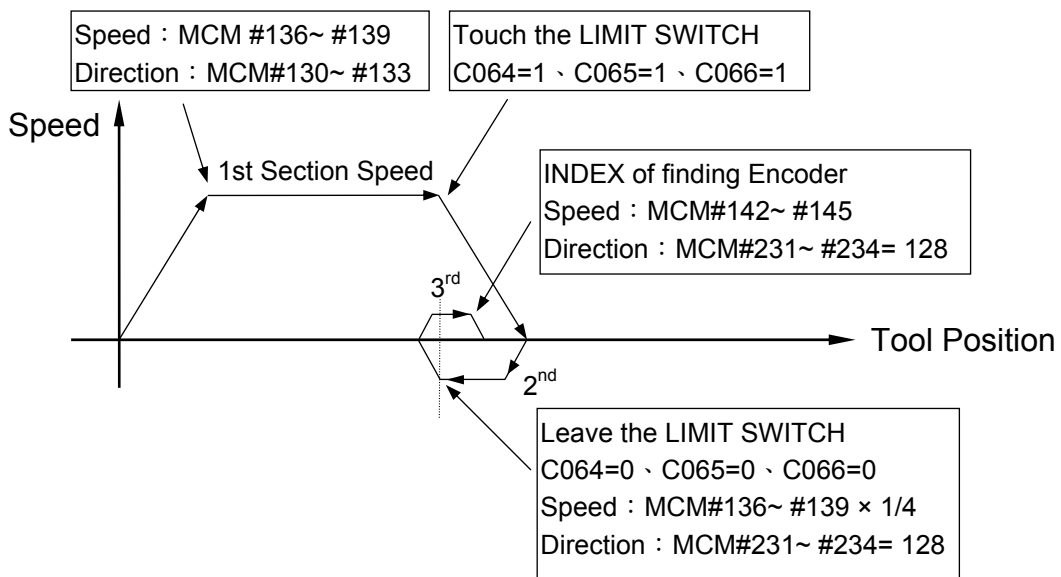

Fig 4-7 (B) Homing Speed and Direction of finding (GRID)

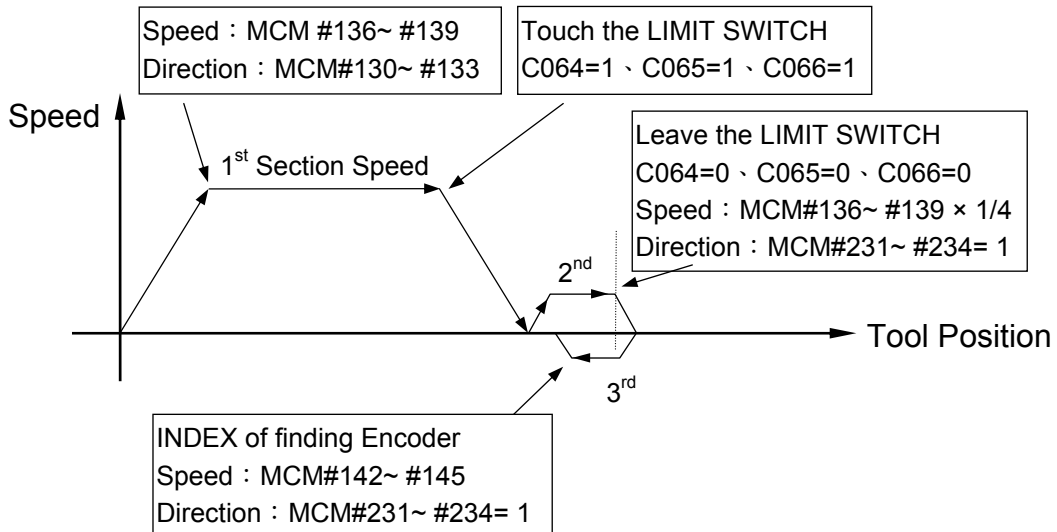

Fig 4-7 (C) Homing Speed and Direction of finding (GRID)

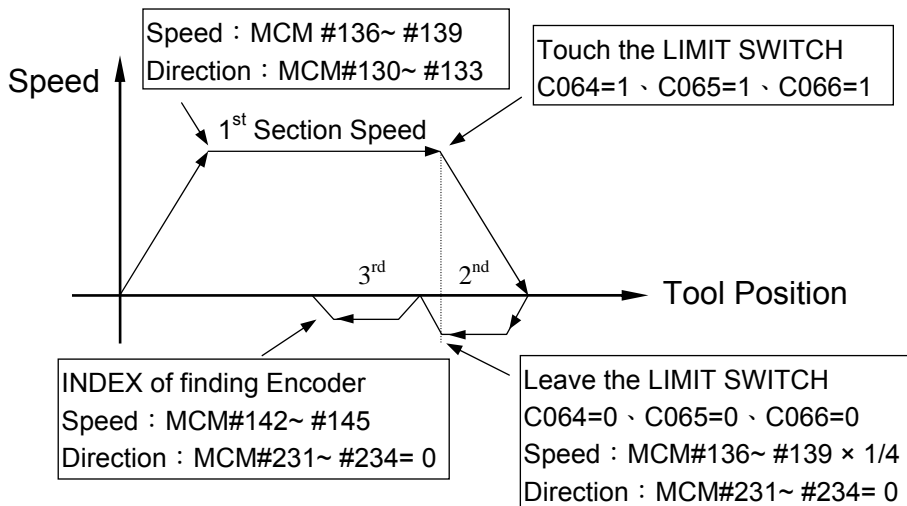

Fig 4-7 (D) Homing Speed and Direction of finding (GRID)

MCM# 350~360 System Reserved !

- 361. Setting the X-Home grid setting.
- 362. Setting the Y-Home grid setting.
- 363. Setting the Z-Home grid setting.
- 364. Setting the A-Home grid setting.
- 365. Setting the B-Home grid setting.
- 366. Setting the C-Home grid setting.
- 367. Setting the U-Home grid setting.
- 368. Setting the V-Home grid setting.
- 369. Setting the W-Home grid setting.

Format=□□□□.□□□ (Default=0.000), unit: mm

Leaving from the origin switch signal, deviating from the above set distance, and then you can start to execute the Homing process (third section) to locate the motor Grid signal.

MCM# 370~380 System Reserved !

381. Home-Shift Data, X-axis.

382. Home-Shift Data, Y-axis.

383. Home-Shift Data, Z-axis.

384. Home-Shift Data, A-axis.

385. Home-Shift Data, B-axis.

386. Home-Shift Data, C-axis.

387. Home-Shift Data, U-axis.

388. Home-Shift Data, V-axis.

389. Home-Shift Data, W-axis.

Format : □.□□□ , Unit: mm/min (Default=0.000)

Set the amount of coordinate shift for HOME location (or machine origin). With these settings, the machine coordinate will be shifted by the same amount when you execute "Home". If home shift data are zero for all axes, the machine coordinate after "Home" operation will be zero also. Note that the work coordinate will be shifted by the same amount.

MCM# 390~400 System Reserved !

401. The distance that servo motor search the Grid when X-axis going back to HOME.

402. The distance that servo motor search the Grid when Y-axis going back to HOME.

403. The distance that servo motor search the Grid when Z-axis going back to HOME.

404. The distance that servo motor search the Grid when A-axis going back to HOME.

405. The distance that servo motor search the Grid when B-axis going back to HOME.

406. The distance that servo motor search the Grid when C-axis going back to HOME.

- 407. The distance that servo motor search the Grid when U-axis going back to HOME.
- 408. The distance that servo motor search the Grid when V-axis going back to HOME.
- 409. The distance that servo motor search the Grid when W-axis going back to HOME.
Format=□□□□.□□□ (Default 10.000)

The distance's maximum when servo motor searching the Grid signal:

EX :

- The servo motor of X-axis turns 3/4 round = 5.000 mm, MCM# 401 = 5.200
- The servo motor of Y-axis turns 3/4 round = 5.000 mm, MCM# 402 = 5.200
- The servo motor of Z-axis turns 3/4 round = 5.000 mm, MCM# 403 = 5.200
- The servo motor of A-axis turns 3/4 round = 5.000 mm, MCM# 404 = 5.200
- The servo motor of B-axis turns 3/4 round = 5.000 mm, MCM# 405 = 5.200
- The servo motor of C-axis turns 3/4 round = 5.000 mm, MCM# 406 = 5.200

- ※ If it exceeds the range and the motor can not find the Grid still. ERR15 will be shown up.

MCM# 410~420 System Reserved !

- 421. X-axis origin switch (+: N.O node; -: N.C node)
- 422. Y -axis origin switch (+: N.O node; -: N.C node)
- 423. Z -axis origin switch (+: N.O node; -: N.C node)
- 424. A-axis origin switch (+: N.O node; -: N.C node)
- 425. B -axis origin switch (+: N.O node; -: N.C node)
- 426. C-axis origin switch (+: N.O node; -: N.C node)
- 427. U-axis origin switch (+: N.O node; -: N.C node)
- 428. V-axis origin switch (+: N.O node; -: N.C node)
- 429. W-axis origin switch (+: N.O node; -: N.C node)

Example: MCM 421=5

Set I5 to be the X-axis origin signal with format NO

MCM 425=-6

Set I6 to be the A-axis origin signal with format NC

- ※ **Default = 0, Functions are inactive, ≠ 0, Functions are active.**
- ※ **If a homing process with C64-69 is planned in PLC, it shall be based on the activity set by PLC.**

MCM# 430~440 System Reserved !

- 441. Direction of Motor Rotation, X-axis.
- 442. Direction of Motor Rotation, Y-axis.
- 443. Direction of Motor Rotation, Z-axis.
- 444. Direction of Motor Rotation, A-axis.
- 445. Direction of Motor Rotation, B-axis.
- 446. Direction of Motor Rotation, C-axis.
- 447. Direction of Motor Rotation, U-axis.
- 448. Direction of Motor Rotation, V-axis.
- 449. Direction of Motor Rotation, W-axis.

Format : □ , (Default=0)

Setting = 0, Motor rotates in the positive direction. (CW)

Setting = 1, Motor rotates in the negative direction. (CCW)

This MCM can be used to reverse the direction of motor rotation if desired. So you don't have to worry about the direction of rotation when installing motor. These parameters will affect the direction of HOME position

IMPORTANT: Motor Divergence

Due to the variations in circuit design of the servo drivers that are available from the market, the proper electrical connections from servo encoder to the driver, then to the CNC controller may vary. If the connections do not match properly, the motor RPM may become divergent (Rotate @ HIGH RPM) and damage to the machine may result. For this reason, HUST strongly suggest separate the servo motor and the machine before you are 100% sure the direction of the motor rotation. If a motor divergence occurs, please inter-change the connections of (A and B phase) and (A- and B- phase) on the driver side.

(This statement has nothing to do with MCM #154~ #157 but it's very important when connecting electrical motor.)

If a motor divergence occurs, please inter-change the connections of (A and B phase) and (A- and B- phase) on the driver side.

EX:

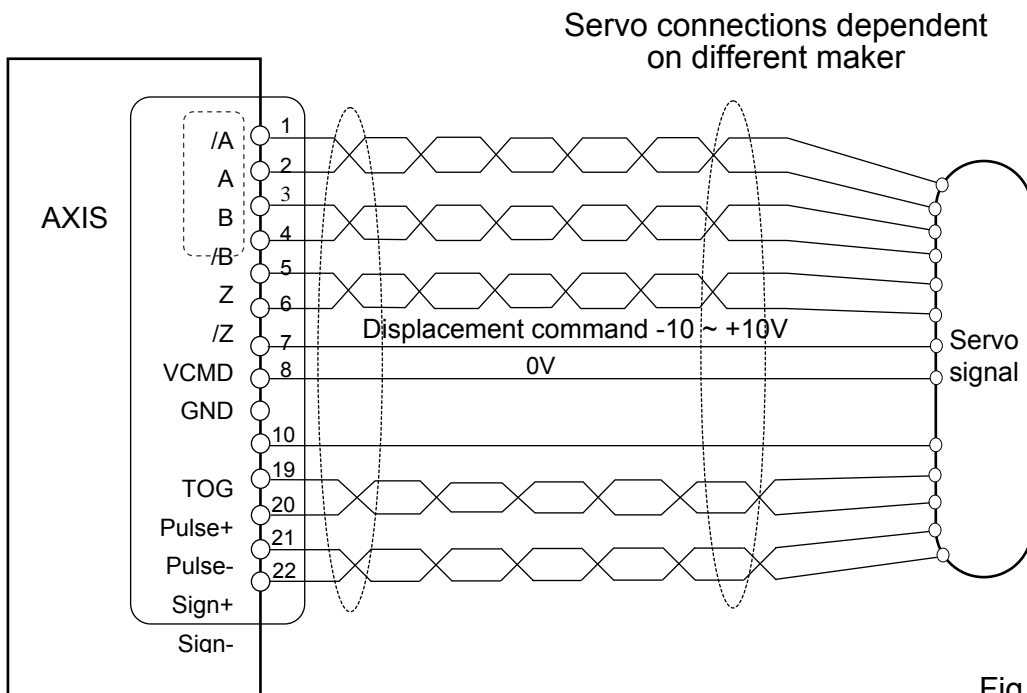

Fig 4-8

MCM# 450~460 System Reserved !

- 461. Encoder Multiplication Factor, X-axis.
- 462. Encoder Multiplication Factor, Y-axis.
- 463. Encoder Multiplication Factor, Z-axis.
- 464. Encoder Multiplication Factor, A-axis.
- 465. Encoder Multiplication Factor, B-axis.
- 466. Encoder Multiplication Factor, C-axis.
- 467. Encoder Multiplication Factor, U-axis.
- 468. Encoder Multiplication Factor, V-axis.
- 469. Encoder Multiplication Factor, W-axis.

Format : □ , (Default=4)

Only one the following 3 numbers:

Setting = 1, Encoder pulse number is multiplied by 1.

Setting = 2, Encoder pulse number is multiplied by 2.

Setting = 4, Encoder pulse number is multiplied by 4.

Note:

The setting of multiplication is highly relative with machine's rigidity. If a motor divergence occurs too heavily, it means that the rigidity is too big. And then it can be improved by lowering the multiplication.

Ex: If factor = 2 for MCM #161 and the encoder resolution is 2000 pulses/rev, then the feed-back signals = $2000 * 2 = 4000$ pulses/rev for Y-axis.

MCM# 470~480 System Reserved !

- 481. X-axis impulse command width adjustment.
- 482. Y-axis impulse command width adjustment.
- 483. Z-axis impulse command width adjustment.
- 484. A-axis impulse command width adjustment.
- 485. B-axis impulse command width adjustment.
- 486. C-axis impulse command width adjustment.
- 487. U-axis impulse command width adjustment.
- 488. V-axis impulse command width adjustment.
- 489. W-axis impulse command width adjustment.

Format=□□ (Default=4)

Setting range 1~63 °

Used to adjust each axial impulse command width

If the pulse frequency from H4D / H6D / H9D controller is 1Hz, then the cycle time of a pulse is 0.25us. If it is required to extend the pulse cycle time, it can be achieved through adjustment of the impulse width.

For example:

If MCM 486=4, the impulse cycle time in the X-axis direction is $4 \times 0.25 = 1.5\mu s$ and the frequency is 625KHz.

MCM# 490~500 System Reserved !

501. Master/Slave Mode Setting

Format : □.□□□ , (Default=0)

Setting = 0, CNC mode, Master/Slave mode NOT set.

= 1, X-axis as master axis, Y, Z, A, B, C, U, V, W-axis as slave axes.

= 2, Y-axis as master axis, X, Z, A, B, C, U, V, W-axis as slave axes.

= 3, Z-axis as master axis, X, Y, A, B, C, U, V, W-axis as slave axes.

= 4, A-axis as master axis, X, Y, Z, B, C, U, V, W-axis as slave axes.

= 5, B-axis as master axis, X, Y, Z, A, C, U, V, W-axis as slave axes.

= 6, C-axis as master axis, X, Y, Z, A, B, U, V, W-axis as slave axes.

= 7, U-axis as master axis, X, Y, Z, A, B, C, V, W-axis as slave axes.

= 8, V-axis as master axis, X, Y, Z, A, B, C, U, W-axis as slave axes.

= 9, W-axis as master axis, X, Y, Z, A, B, C, U, V-axis as slave axes.

= 256, Round Corner Non-stop Operation

502. Type of Motor Acceleration/Deceleration

Format : □ , (Default=1)

Setting = 1, Linear type.

Setting = 2, "S" curve.

503. Home command mode setting.

BIT0 = 0 X axis find Home grid available, =1 X axis no need to find Home grid.

BIT1 = 0 Y axis find Home grid available, =1 Y axis no need to find Home grid.

BIT2 = 0 Z axis find Home grid available, =1 Z axis no need to find Home grid.

BIT3 = 0 A axis find Home grid available, =1 A axis no need to find Home grid.

BIT4 = 0 B axis find Home grid available, =1 B axis no need to find Home grid.
 BIT5 = 0 C axis find Home grid available, =1 C axis no need to find Home grid.
 BIT6 = 0 U axis find Home grid available, =1 U axis no need to find Home grid.
 BIT7 = 0 V axis find Home grid available, =1 V axis no need to find Home grid.
 BIT8 = 0 W axis find Home grid available, =1 W axis no need to find Home grid.

504. Servo Motor Acceleration/Deceleration Time, G00.

Format : □□□ , Unit: millisecond (Default=100)

Setting Range: 2 ~ 3000 millisecond

505. Servo Motor Acceleration/Deceleration Time (T), G01.

Format : □□□ , Unit: millisecond (Default=100)

Setting Range: 2 ~ 3000 millisecond.

100 milliseconds is the recommended setting for both G00 and G01.

If MCM #502 setting = 0, type of accel./decel. for G01 = exponential

If MCM #502 setting = 1, type of accel./decel. for G01 = Linear.

If MCM #502 setting = 2, type of acceleration/deceleration for G01 = "S" curve. In this case, the actual acceleration/deceleration time is twice the setting value.

506. Acceleration/Deceleration Time for G99 Mode.

Format : □□□ , Unit: Millisecond (Default=100)

Setting Range: 4 ~ 3000 ms.

507. Set the spindle Acceleration/Deceleration time in master mode.

Format : □□□ , Unit: Millisecond (Default=100)

Setting Range: 4 ~ 3000 ms.

508. System Reserved

509. Spindle Encoder Pulse Per Revolution

Format : □□□□ , Unit: Pulse/rev (Default=4096)

510. Set Spindle Motor RPM When Vcmd = 10 Volt.

Format : □□□□ , Unit: RPM (Default=3000)

511. Spindle voltage command 0V output balance adjustment (open circuit).

- 512. Spindle voltage command slope correction (open circuit).
Format : S= □□□□ , (Default=0), Set the reference value 2047.
- 513. Spindle RPM correction (based on feedback from the encoder).
- 514. Starting Number for Auto Generation of Program Block Number.
Format : S= □ , (Default=0)
- 515. Increment for Auto-generation of Program Block Number.
Format : D= □ , (Default=0)
- 516. If D = 0, the program block number of a single program block will not be generated automatically.

In the Edit or Teach mode, the block number of a single block can be automatically generated by simply press the INSERT key. If the RESET key is pressed, the block number of a single block will be renumbered according to the setting values in Parameters 514 and 515.

Ex: S = 0 , D = 5

The program block number will be generated in the sequence:
5,10,15,20,25 ...

- 517. Denominator of Feed-rate Multiplication Factor for MPG Test.
- 518. Numerator of Feed-rate Multiplication Factor for MPG Test.
Format : □□□□□ , (Default=100)

Note: If the MPG rotation speed is not proper, it can be adjusted by MCM#516, #517. The two items are up to 5 units and it must be integer. They also can not set as zero.

- 519. Handwheel direction
Format=□ (Default= 0).

If it is necessary to change the relation between the current handwheel rotational direction and the axial displacement direction, it can be achieved by setting the value to 0 or 1.

It can be adjusted separately the corresponding axial direction bit 0 =x
bit 1 =y....

Example: BIT 0=1 The X-axis handwheel command is reverse, but other
axes remain at the default.

520. Set Acceleration / Deceleration Time for MPG

Format=□□□, (Default = 64), Unit: milliseconds

Setting Range: 4~512 ms.

The motor acceleration / deceleration time is equal to MCM #519 when
MPG hand-wheel is used in JOG mode.

521. RS232C Baud Rate.

Format : □□□□ , (Default = 38400)

Set RS232C communication speed. Choose from, 9600, 19200, 38400,
57600, 115200 Speed rate 38400 stands for 38400 bits per second.

In addition, use the following settings for your PC:

Parity -- Even

Stop Bits-- 2 bits

Data Bits – 7 bits

522. Flag to Save the Data of R000~R199 in PLC when power-off.

Format : □ , (Default=0)

Setting = 0, NOT to save.

Setting = 256, Save R000~R199 data.

523. Servo Error Count

Format : □ , (Default=0)

When executing locating operation, the controller has sent out the voltage
command, but the motor maybe fall behind some distance. This parameter
is used to set that the controller could execute next operation or not
according to the setting range of pulse

Set MCM#522 = 0 for generating 4096 pulses.

Set MCM#522 \neq 0 for user defined value.

524. Radius / diameter programming mode

Format= (Default = 0)

0: Radius programming

1: Diameter programming

525. METRIC/INCH Mode Selection (default = 0)

Format : , (Default = 0)

Setting = 0, Measurement in METRIC unit.

Setting = 1, Measurement in INCH unit.

526. Error in Circular Cutting

Format : , (Default = 1)

Range:1 ~ 32

In circular cutting, the ideal cutting path is a circular arc, but the actual motor path is along the arc cord (a straight line). Therefore, there is a cutting error as shown in the figure below.

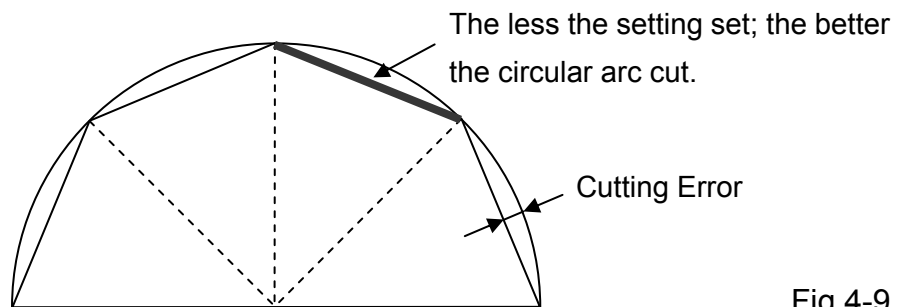

Fig 4-9

This parameter enables the user to adjust acceptable error. The smaller is the setting (=1, the best), the better the circular cutting result. However, the setting should not be too small to the point that it's not able to drive the motor.

527. 6-axis parameter settings in pulse type

Format =, Default: 0

Setting =0: pulse + direction
 Setting =1: +/- pulse
 Setting =2: in the format of Phase A or B

528. Setting the G01 speed value at booting

Format=□□□□□□ (Default=1000)

After booting, in executing the program or MDI command, if you have not used the F command yet, nor the current single block has designated the F value, then use the MCM 527 value as the F value of the current single block.

529. Setting the tool compensation direction

Format=□ (Default=0)

0 : HUST

1 : FANUC

Tool-wear compensation direction - HUST: same direction; FANUC: reverse direction.

530. It is used for adjusting the G01's acceleration/deceleration time when the acceleration/deceleration type is set to an "S" curve.

Format=□□□ (Default=100) in unit of millisecond (msec).

When MCM 502=2, the function can then be sustained.

Setting range 10~512 ms.

531. Line editing entry format and numeral decimal's automatic-generating setting.

Format=□ (default setting 0)

=0 The standard mode.

=1 When setting the parameter values in the system master list, the system will automatically add a decimal point to even numbers.

Ex : MCM 401 setting

Enter "1 " = 1.000

Enter "1.999" = 1.999

=2 Line Editing.

Ex : Enter G00 X10.

Standard mode steps :

Step 1	Step 2	Step 3	Step 4
GOO	ENTER	X10.	ENTER

Line editing :

Step 1	Step 2
GOO X10.	ENTER

=4 At editing, decimal point will be automatically generated for the variable value.

At program editing and also entering even numbers, the system will automatically add decimal point to even numbers.

532. In the milling mode, set the gap for drill to withdraw.

Format=. (Default= 2.000) unit:mm

533. Setting the test following count

Format= (Default= 0)

With use of parameter Item No.534

534. Testing the axial setting of the servo following error function

Format= (Default = 0)

Set the testing corresponding to the axis with Bit

Description:

When MCM534 = 1 and Bit0 = 1, test the X-axis.

When MCM534 = 2 and Bit1 = 1, test the Y-axis.

When MCM534 = 4 and Bit2 = 1, test the Z-axis.

When MCM534 = 8 and Bit3 = 1, test the A-axis.

When MCM534 = 16 and Bit4 = 1, test the B-axis.

When MCM534 = 32 and Bit5 = 1, test the C-axis.

When MCM534 = 64 and Bit6 = 1, test the U-axis.

When MCM534 = 128 and Bit7 = 1, test the V-axis.

When MCM534 = 256 and Bit8 = 1, test the W-axis.

When MCM534 = 511, i.e. Bit0 ~ Bit8= 1, then test X/Y/Z/A/B/C/U/V/W-axes at the same time.

Caution: For HUST H4D / H6D / H9D controller, if the servo motor used is a voltage command type, it is necessary to set testing the following error function (not applicable for the impulse command type).

The controller will compare the actual feedback difference of the servo motor with the setting of the parameter Item No 533. If the controller detects that the axis has been set beyond the range, the system will display an error message.

Example: When the parameter Item No 533= 4096, the parameter Item No 534=1, and

The actual motor following error

>

4096 (Parameter Item No 533), it will generate ERROR 02 X

535. Controller ID number
Control connection of multiple units with PC. Currently, the function is reserved.
536. Setting the minimum slope of the Auto Teach function
Format=□□□□□.□□ (Default= 0)
Setting range: +360.00 ~ -360.00
537. Setting the first point distance of the Auto Teach function.
Format=□□□□.□□□ (Default= 0)
538. G41 and G42 Handling type
Format=□ (Default 0)
- When the setting value =0, an error is displayed, the interference problem is not handled, and the motion is stopped.
- =1 Automactilly handle the interference problem.
- =2 The error message is not displayed and the interference problem is not handeled.
539. System Reserved
540. Adjustment of the feedback direction for the axes

Format= (Default 0)

Set the corresponding axes by the bit pattern.

Description:

If MCM540=1, Bit0 = 1, the feedback direction is reverse for the X-axis.

If MCM540=2, Bit1 = 1, the feedback direction is reverse for the Y-axis.

If MCM540=4, Bit2 = 1, the feedback direction is reverse for the Z-axis.

If MCM540=8, Bit3 = 1, the feedback direction is reverse for the A-axis.

If MCM540=16, Bit4 = 1, the feedback direction is reverse for the B-axis.

If MCM540=32, Bit5 = 1, the feedback direction is reverse for the C-axis.

If MCM540=64, Bit6 = 1, the feedback direction is reverse for the U-axis.

If MCM540=128, Bit7 = 1, the feedback direction is reverse for the V-axis.

If MCM540=256, Bit8 = 1, the feedback direction is reverse for the W-axis.

541. Arc type

Format= (Default 0)

Setting =0 arc cord height control.

=1 arc cord length control.

=2 system internal automatic control (500 sections/sec).

MCM# 542~560 System Reserved !

561. "S" curve accel./decel. profile setting for the X-axis.

562. "S" curve accel./decel. profile setting for the Y-axis.

563. "S" curve accel./decel. profile setting for the Z-axis.

564. "S" curve accel./decel. profile setting for the A-axis.

565. "S" curve accel./decel. profile setting for the B-axis.

566. "S" curve accel./decel. profile setting for the C-axis.

567. "S" curve accel./decel. profile setting for the U-axis.

568. "S" curve accel./decel. profile setting for the V-axis.

569. "S" curve accel./decel. profile setting for the W-axis.

When R209 Bit30=1, the "S" curve accel./decel. profile settings can be configured independently.

MCM# 570~580 System Reserved !

581. Software OT Limit in (+) Direction, X-axis. (Group 1)

- 582. Software OT Limit in (+) Direction, Y-axis. (Group 1)
 - 583. Software OT Limit in (+) Direction, Z-axis. (Group 1)
 - 584. Software OT Limit in (+) Direction, A-axis. (Group 1)
 - 585. Software OT Limit in (+) Direction, B-axis. (Group 1)
 - 586. Software OT Limit in (+) Direction, C-axis. (Group 1)
 - 587. Software OT Limit in (+) Direction, U-axis. (Group 1)
 - 588. Software OT Limit in (+) Direction, V-axis. (Group 1)
 - 589. Software OT Limit in (+) Direction, W-axis. (Group 1)
- Format : □□□□□□□ , Unit: mm/min (Default=9999.999)

Set the software over-travel (OT) limit in the positive (+) direction, the setting value is equal to the distance from positive OT location to the machine origin (HOME).

MCM# 590~600 System Reserved !

- 601. Software OT Limit in (-) Direction, X-axis. (Group 1)
 - 602. Software OT Limit in (-) Direction, Y-axis. (Group 1)
 - 603. Software OT Limit in (-) Direction, Z-axis. (Group 1)
 - 604. Software OT Limit in (-) Direction, A-axis. (Group 1)
 - 605. Software OT Limit in (-) Direction, B-axis. (Group 1)
 - 606. Software OT Limit in (-) Direction, C-axis. (Group 1)
 - 607. Software OT Limit in (-) Direction, U-axis. (Group 1)
 - 608. Software OT Limit in (-) Direction, V-axis. (Group 1)
 - 609. Software OT Limit in (-) Direction, W-axis. (Group 1)
- Format : □□□□.□□□ , Unit: mm/min (Default=-9999.999)

Set the software over-travel (OT) limit in the negative (-) direction, the setting value is equal to the distance from negative OT location to the machine origin (HOME). Figure below shows the relationship among the software OT limit, the emergency stop, and the actual hardware limit.

MCM# 610~620 System Reserved !

- 621. Software OT Limit in (+) Direction, X-axis. (Group 2)
- 622. Software OT Limit in (+) Direction, Y-axis. (Group 2)
- 623. Software OT Limit in (+) Direction, Z-axis. (Group 2)
- 624. Software OT Limit in (+) Direction, A-axis. (Group 2)
- 625. Software OT Limit in (+) Direction, B-axis. (Group 2)

- 626. Software OT Limit in (+) Direction, C-axis. (Group 2)
 - 627. Software OT Limit in (+) Direction, U-axis. (Group 2)
 - 628. Software OT Limit in (+) Direction, V-axis. (Group 2)
 - 629. Software OT Limit in (+) Direction, W-axis. (Group 2)
- Format : □□□□□□ , Unit: mm/min (Default=9999.999)

- ※ In PLC when C10=1, it detects unit 2 software's range limit.
- ※ Set the software over-travel (OT) limit in the positive (+) direction, the setting value is equal to the distance from positive OT location to the machine origin (HOME).

MCM# 630~640 System Reserved !

- 641. Software OT Limit in (-) Direction, X-axis. (Group 2)
 - 642. Software OT Limit in (-) Direction, Y-axis. (Group 2)
 - 643. Software OT Limit in (-) Direction, Z-axis. (Group 2)
 - 644. Software OT Limit in (-) Direction, A-axis. (Group 2)
 - 645. Software OT Limit in (-) Direction, B-axis. (Group 2)
 - 646. Software OT Limit in (-) Direction, C-axis. (Group 2)
 - 647. Software OT Limit in (-) Direction, U-axis. (Group 2)
 - 648. Software OT Limit in (-) Direction, V-axis. (Group 2)
 - 649. Software OT Limit in (-) Direction, W-axis. (Group 2)
- Format : □□□□.□□□ , Unit: mm/min (Default=-9999.999)

- ※ In PLC when C10=1, it detects unit 2 software's range limit.
- ※ Set the software over-travel (OT) limit in the negative (-) direction, the setting value is equal to the distance from negative OT location to the machine origin (HOME).

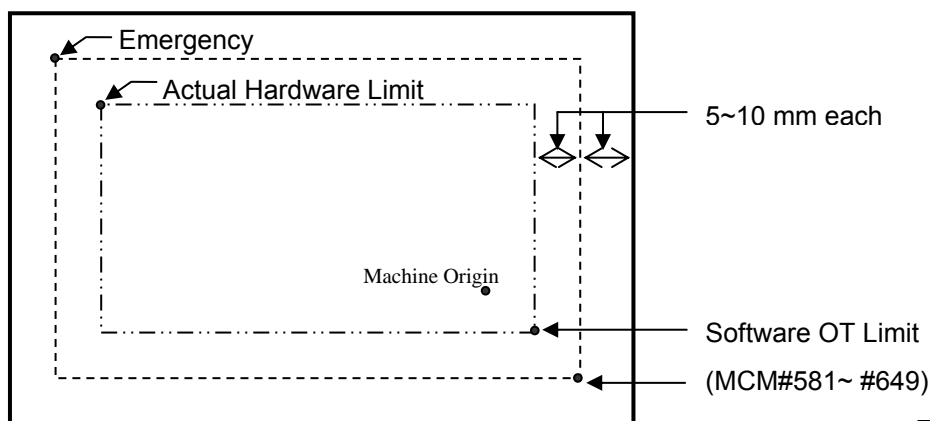

Fig 4-10

MCM# 650~660 System Reserved !

- 661. Flag to Clear X-axis Program Coordinate on M02, M30 or M99 Command.
 - 662. Flag to Clear Y-axis Program Coordinate on M02, M30 or M99 Command.
 - 663. Flag to Clear Z-axis Program Coordinate on M02, M30, or M99 Command.
 - 664. Flag to Clear A-axis Program Coordinate on M02, M30, or M99 Command.
 - 665. Flag to Clear B-axis Program Coordinate on M02, M30, or M99 Command.
 - 666. Flag to Clear C-axis Program Coordinate on M02, M30, or M99 Command.
 - 667. Flag to Clear U-axis Program Coordinate on M02, M30, or M99 Command.
 - 668. Flag to Clear V-axis Program Coordinate on M02, M30, or M99 Command.
 - 669. Flag to Clear W-axis Program Coordinate on M02, M30, or M99 Command.
- Format : □ , (Default=0)

Used as flag to clear the coordinate when program execution encounters M02, M30 or M99 function. The following settings are valid for both X and Y-axis.

Setting = 0, Flag is OFF, NOT to clear.

Setting = 1, Flag is ON, YES to clear when encountering M02 and M30.

Setting = 2, Flag is ON, YES to clear when encountering M99.

Setting = 3, Flag is ON, YES to clear when encountering M02, M30 and M99.

MCM# 670~680 System Reserved !

- 681. Set Incremental/Absolute Mode, X-axis coordinate.
 - 682. Set Incremental/Absolute Mode, Y-axis coordinate.
 - 683. Set Incremental/Absolute Mode, Z-axis coordinate.
 - 684. Set Incremental/Absolute Mode, A-axis coordinate.
 - 685. Set Incremental/Absolute Mode, B-axis coordinate.
 - 686. Set Incremental/Absolute Mode, C-axis coordinate.
 - 687. Set Incremental/Absolute Mode, U-axis coordinate.
 - 688. Set Incremental/Absolute Mode, V-axis coordinate.
 - 689. Set Incremental/Absolute Mode, W-axis coordinate.
- Format : □ , (Default=1) for absolute positioning

Ex: Set MCM 681 = 0, X value represents the incremental position and U value is ineffective.

= 1, X value represents the incremental position and U value is the incremental position.

- *Note 1: After the parameters are set, execute the command **G01 X***,Y***,Z*** F*****, the program will perform the axial motions according to the configured incremental or absolute positions.
 H9D: When R209 = 4, the incremental address codes of X,Y,Z will be U,V,W. However, the A,B,C axes have no incremental address code, they cannot be used in the same way as the X,Y,Z axes which allow the conversion between the incremental positioning and the absolute positioning. It is necessary to use the **G90/G91** modes to use them.
 H9D: X,Y,Z,A,B,C,U,V,W have no incremental address codes, so they cannot allow the conversion between the incremental positioning and the absolute positioning. It is necessary to use the G90/G91 mode to use them.
- *Note 2: For H9D using the incremental address codes U,V,W, it is necessary to set the parameters 1 of the X,Y,Z axes for the absolute positioning so that the U,V,W commands can be performed in the program.
- *Note 3: If the G90/G91 mode is used for the 9-axis absolute or incremental positioning change, no matter the parameters are configured for absolute positioning or for incremental positioning, the single block X,Y,Z,A,B,C,U,V,W commands will use the G90/G91 mode for absolute positioning or absolute increments after the G90/G91 mode is used.
- *Note 4: When the controller in H9D is configured to use U,V,W as the incremental address codes, it will not be influenced by the G90/G91 mode.

Format of mode appointment:

G90 Absolute coordinate
 G91 Incremental coordinate

1. G90 :

When writing G90 in the program, all the axes of X,Y,Z,A,B,C,U,V,W are the absolute coordinate. All following nodes` axes direction will also feed absolutely.

(See EX1)

The incremental codes U,V,W also can be used in G90 mode. Then X, Y, Z axes will feed incrementally. But A-axis still feed absolutely. Until it meeting G91 or recycling the program, then the G90 will be over.

EX1: G90 Set Absolute Coordinate

```

N1 G90
N2 G1 X20.000 Y15.000      ....   P0 to P1
N3 X35.000 Y25.000        ....   P1 to P2
N4 X60.000 Y30.000        ....   P2 to P3

```

2. G91 :

When writing G90 in the program, all the axes of X,Y,Z,A,B,C,U,V,W are the incremental coordinate. All following nodes` axes direction will also feed incrementally. (See EX2)

In G91 mode, X,Y,Z represent the incremental value. The codes of U, V, W are not necessary. The axis will move to nowhere.

Until it meeting G90 or recycling the program, then the G91 will be over.

EX2: G91 Set Incremental Coordinate

```

N1 G91
N2 G1 X20.000 Y15.000      ....   P0 to P1
N3 X15.000 Y10.000        ....   P1 to P2
N4 X25.000 Y5.000         ....   P2 to P3

```

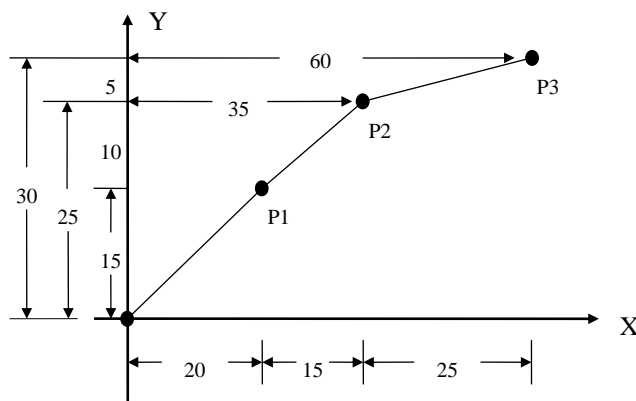

Fig 4-11

MCM# 690~700 System Reserved !

701. X-axis, Position gain.

702. Y-axis, Position gain.

- 703. Z-axis, Position gain.
- 704. A-axis, Position gain.
- 705. B-axis, Position gain.
- 706. C-axis, Position gain.
- 707. U-axis, Position gain.
- 708. V-axis, Position gain.
- 709. W-axis, Position gain.

Format : □□□ , (Default=64) , Setting Range: 8~640 ◦

Parameters 701~709 are used to set the loop gain. The recommended value is 64. This setting value is essential to the smooth operation of the motor. Once it is configured, please do not change it arbitrarily.

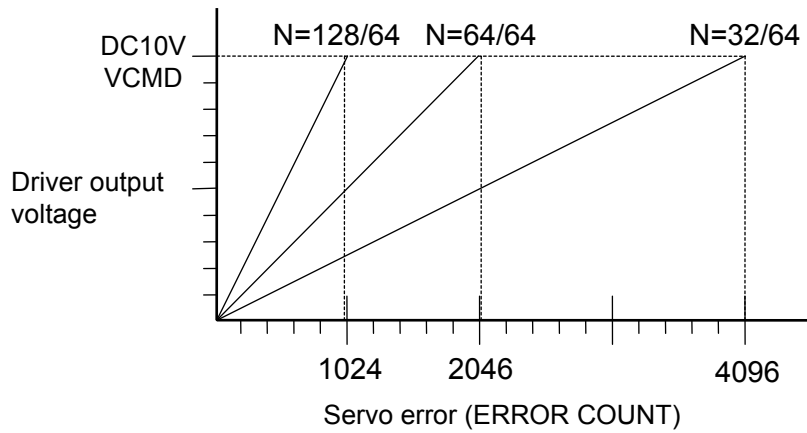

Fig 4-12 Driver output voltage vs. the servo error

The position gain and HUST H4D / H6D / H9D output voltage command can be calculated as follows:

$$\text{Position Gain} = \frac{\text{Setting value}}{64}$$

$$\text{NC controller output voltage command} = \text{GAIN} * \text{Servo feedback error} * \left(\frac{10V}{2048} \right)$$

The controller in HUST is a closed-loop system. The servo error is the difference between the controller position command and the actual feedback value of the servo motor. The controller will adjust the output voltage of the controller properly according to this difference value. The

setting value of the position gain is related to the stability and the follow-up of the system servo, so please modify it with care. If:

Servo mismatch > 4096, the ERROR 02 will occur.

In this case, please correct the values of MCM Parameters 701~709 and then press the “Reset” key. If the problem still exists, please check if the wire connection of the servo motor is correct.

Adjustment procedure for smooth motor operation: (recommended)

- (1) Adjust the servo driver. (Please refer to the operation manual of the driver)
- (2) Adjust the MCM Parameters 461~469 for the multipliers (1,2,4) of the signals from the the speed sensors. In normal condition, if the motor is locked, the Servo Error will be oscillating between 0 and 1; if it is oscillating between 4 and 5, the problem can be solved usually by adjusting the MCM Parameters 461 ~ 469 for the multipliers, i.e., 4 --> 2, or 2 --> 1.
- (3) Adjust the values of MCM Parameters 701~709 for the position loop gain.

MCM# 710~720 System Reserved !

- 721. Break-over Point (in Error Count) for Position Gain, X-axis.
- 722. Break-over Point (in Error Count) for Position Gain, Y-axis.
- 723. Break-over Point (in Error Count) for Position Gain, Z-axis.
- 724. Break-over Point (in Error Count) for Position Gain, A-axis.
- 725. Break-over Point (in Error Count) for Position Gain, B-axis.
- 726. Break-over Point (in Error Count) for Position Gain, C-axis.
- 727. Break-over Point (in Error Count) for Position Gain, U-axis.
- 728. Break-over Point (in Error Count) for Position Gain, V-axis.
- 729. Break-over Point (in Error Count) for Position Gain, W-axis.

Format : □□□ , (Default=10)

The proper setting of this parameter will assure smooth start-up of servo motor. When servo error is smaller than the setting value of MCM #721~#729, the position gain is 64. Otherwise, position gain will be calculated based on the setting value of MCM #701~ #709 and the setting

values depend on the frictional load on the motor. If the frictional load is high, setting value is small and vice versa.

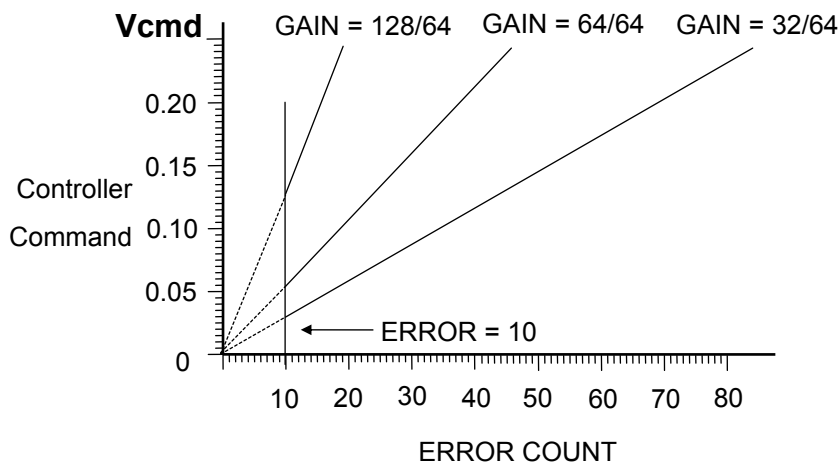

Fig 4-13

MCM# 730~740 System Reserved !

741. X-axis Denominator, MPG Hand-wheel Resolution Adjustment. (pulse)

742. X-axis Numerator, MPG Hand-wheel Resolution Adjustment. (μm)

743. Y-axis Denominator, MPG Hand-wheel Resolution Adjustment. (pulse)

744. Y-axis Numerator, MPG Hand-wheel Resolution Adjustment. (μm)

745. Z-axis Denominator, MPG Hand-wheel Resolution Adjustment. (pulse)

746. Z-axis Numerator, MPG Hand-wheel Resolution Adjustment. (μm)

747. A-axis Denominator, MPG Hand-wheel Resolution Adjustment. (pulse)

748. A-axis Numerator, MPG Hand-wheel Resolution Adjustment. (μm)

749. B-axis Denominator, MPG Hand-wheel Resolution Adjustment. (pulse)

750. B-axis Numerator, MPG Hand-wheel Resolution Adjustment. (μm)

751. C-axis Denominator, MPG Hand-wheel Resolution Adjustment. (pulse)

752. C-axis Numerator, MPG Hand-wheel Resolution Adjustment. (μm)

753. U-axis Denominator, MPG Hand-wheel Resolution Adjustment. (pulse)

754. U-axis Numerator, MPG Hand-wheel Resolution Adjustment. (μm)

755. V-axis Denominator, MPG Hand-wheel Resolution Adjustment. (pulse)

756. V-axis Numerator, MPG Hand-wheel Resolution Adjustment. (μm)

757. W-axis Denominator, MPG Hand-wheel Resolution Adjustment. (pulse)

758. W-axis Numerator, MPG Hand-wheel Resolution Adjustment. (μm)

Format : $\square\square\square\square$, (Default = 100)

Unit: Denominator = pulses, Numerator = μm

Ex1: For X-axis, MCM #741 = 100 pulses, MCM #742 = 100 μm .

The resolution for X-axis = $100/100 = 1 \mu\text{m}/\text{pulse}$.

If MPG hand-wheel moves 1 notch (=100 pulses), the feed length in X-axis = $100 \times (100/100) = 100 \mu\text{m} = 0.1 \text{ mm}$.

Ex2: For Y-axis, MCM #743 = 200 pulses, MCM #744 = 500 μm .

The resolution for Y-axis = $500/200 = 2.5 \mu\text{m}/\text{pulse}$.

If MPG hand-wheel moves 1 notch (=100 pulses), the feed length in Y-axis = $100 \times (500/200) = 250 \mu\text{m} = 0.25 \text{ mm}$.

MCM# 759~780 System Reserved !

781. Set if X-axis is rotational axis.

782. Set if Y-axis is rotational axis.

783. Set if Z-axis is rotational axis.

784. Set if A-axis is rotational axis.

785. Set if B-axis is rotational axis.

786. Set if C-axis is rotational axis.

787. Set if U-axis is rotational axis.

788. Set if V-axis is rotational axis.

789. Set if W-axis is rotational axis.

Format= \square (Default 0)

Setting= 0 Linear Axis

Setting= 1 Rotational Axis

MCM# 787~800 System Reserved !

801. The distance of S bit sent before the X-axis reaches in position. (S176)

802. The distance of S bit sent before the Y-axis reaches in position. (S177)

803. The distance of S bit sent before the Z-axis reaches in position. (S178)

804. The distance of S bit sent before the A-axis reaches in position. (S179)

- 805. The distance of S bit sent before the B-axis reaches in position. (S180)
- 806. The distance of S bit sent before the C-axis reaches in position. (S181)
- 807. The distance of S bit sent before the U-axis reaches in position. (S182)
- 808. The distance of S bit sent before the V-axis reaches in position. (S183)
- 809. The distance of S bit sent before the W-axis reaches in position. (S184)

Format=□□□□.□□□ (Default= 0.000)

Unit: mm

For example: MCM 801 =10.00mm

Giving the command: When G01 U30.000 F1000, when the X-axis move 20.000mm and 10.000mm away from the final value, the system will send S176=ON °

MCM# 807~820 System Reserved !

- 821. The accelerate/decelerate time of X-axis.
- 822. The accelerate/decelerate time of Y-axis.
- 823. The accelerate/decelerate time of Z-axis.
- 824. The accelerate/decelerate time of A-axis.
- 825. The accelerate/decelerate time of B-axis.
- 826. The accelerate/decelerate time of C-axis.
- 827. The accelerate/decelerate time of U-axis.
- 828. The accelerate/decelerate time of V-axis.
- 829. The accelerate/decelerate time of W-axis.

Format=□□□□ (Default 0), Unit (msec)

Acceleration/Deceleration Time (2~3000)

When R209 Bit30=1, the acceleration/deceleration speed can be programmed independently.

MCM# 830~840 System Reserved !

The pitch error compensation of the guide screw in HUST H4D / H6D / H9D is relative to the **mechanical origin as the base point**.

- 841. Pitch Error Compensation Mode Setting, X-axis.
- 842. Pitch Error Compensation Mode Setting, Y-axis.
- 843. Pitch Error Compensation Mode Setting, Z-axis.
- 844. Pitch Error Compensation Mode Setting, A-axis.

- 845. Pitch Error Compensation Mode Setting, B-axis.
- 846. Pitch Error Compensation Mode Setting, C-axis.
- 847. Pitch Error Compensation Mode Setting, U-axis.
- 848. Pitch Error Compensation Mode Setting, V-axis.
- 849. Pitch Error Compensation Mode Setting, W-axis.

Format:□ , Default=0

Setting = 0, Compensation canceled.

Setting = -1, Negative side of compensation.

Setting = 1, Positive side of compensation.

X-axis	Y-axis	Z-axis	A-axis	B-axis	C-axis	U-axis	V-axis	W-axis	Explanation
0	0	0	0	0	0	0	0	0	Compensation cancel
-1	-1	-1	-1	-1	-1	-1	-1	-1	Do compensation when tool is on the (-) side of the reference point
1	1	1	1	1	1	1	1	1	Do compensation when tool is on the (+) side of the reference point.

Ex:

MCM # 841= -1

The pitch error in the X-axis will not be compensated when the tool travels to the positive side of the X-HOME location. It will be compensated when the tool travels to the negative side of machine origin.

MCM # 841= 1

The pitch error in the X-axis will be compensated when the tool travels to the positive side of Y-HOME location. No compensation will be done when it travels to the negative side of machine origin.

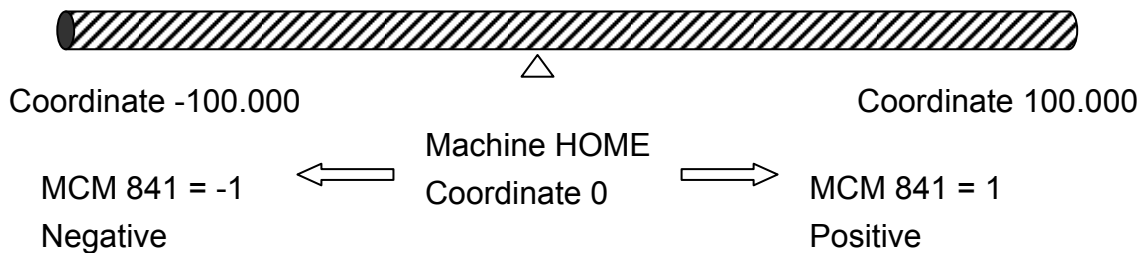

Fig 4-14

MCM#850 System Reserved !

- 851. Segment Length for Pitch Error Compensation, X-axis.
- 852. Segment Length for Pitch Error Compensation, Y-axis.
- 853. Segment Length for Pitch Error Compensation, Z-axis.
- 854. Segment Length for Pitch Error Compensation, A-axis.
- 855. Segment Length for Pitch Error Compensation, B-axis.
- 856. Segment Length for Pitch Error Compensation, C-axis.

Format=□.□□□, Default=0, Unit=mm

Axis	Corresponding MCM# for Segment Length	Segment Length	Max. Number of Segment
X	MCM# 861 ~ 940	20 ~ 480 mm	80
Y	MCM# 941 ~ 1020	20 ~ 480 mm	80
Z	MCM# 1021 ~ 1100	20 ~ 480 mm	80
A	MCM# 1101 ~ 1180	20 ~ 480 mm	80
B	MCM# 1181 ~ 1260	20 ~ 480 mm	80
C	MCM# 1261 ~ 1340	20 ~ 480 mm	80

1. Segment length is the total length of ball-screw divided by the number of segment.

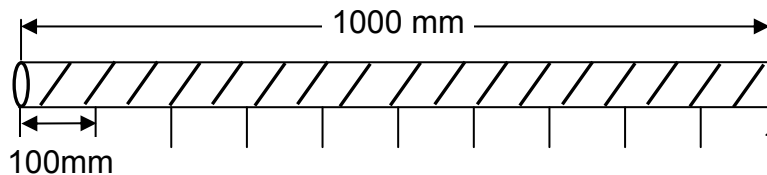

Fig 4-15

Ex:

If you want to divide the ball-screw on X-axis, which is 1 meter in length, into 10 segments, the segment length is $1000.00/10=100.00$ mm. This 100.00 mm will be stored in MCM# 851.(Each compensation of them is set by MCM#861~#940)

2. If the average segment length is less than 20 mm, use 20 mm.
3. When doing compensation, HUST H4D / H6D / H9D controller will further divide each segment into 8 sections. The amount of compensation for each section is equal to the whole number, in μm , of 1/8 of the amount in MCM #861~#940. The remainder will be added to the next section.

Ex:

Segment length =100.00mm and the amount of compensation is 0.026mm as set in MCM#861. Then, the compensation for each section is $0.026/8=0.00325$ mm. The compensation for this segment will be done in a manner as tabulated below:

Section	Tool Position	Avg. comp. For each section	Actual comp. At each section	Accumulated compensation
1	12.5	0.00325	0.003	0.003
2	25	0.00325	0.003	0.006
3	37.5	0.00325	0.003	0.009
4	50	0.00325	0.004	0.013
5	62.5	0.00325	0.003	0.016
6	75	0.00325	0.003	0.019
7	87.5	0.00325	0.003	0.022
8	100	0.00325	0.004	0.026

MCM# 857~860 System Reserved !

861~1340. Amount of Compensation for each segment (X.Y.Z.A.B.C-axis) is 80.

The Compensation value is in incremental mode. If the number of segment is less than 80, please fill the uncompensated segments with zero to avoid any potential errors.

Ex:

If the segment of compensation is 10, the amount of the compensation from Seg.11 to 40 (X-axis MCM#861~940, Y-axis MCM#941~1020, Z-axis MCM#1021~1100, A-axis MCM #1101~1180, B-axis MCM#1181~1260, C-axis MCM#1261~1340) must be set as zero.

MCM#861~940 Pitch error compensation of each segment, X-axis.

MCM#941~1020 Pitch error compensation of each segment, Y-axis.

MCM#1021~1100Pitch error compensation of each segment, Z-axis.

MCM#1101~1180Pitch error compensation of each segment, A-axis.

MCM#1181~1260Pitch error compensation of each segment, B-axis.

MCM#1261~1340Pitch error compensation of each segment, C-axis.

Format : □.□□□ , Unit: mm (Default=0.000)

- 1341. Tool#1, Radius Offset Data.
- 1342. X-axis Offset Data, Tool#1.
- 1343. Y-axis Offset Data, Tool#1.
- 1344. Z-axis Offset Data, Tool#1.
- 1345. A-axis Offset Data, Tool#1.
- 1346. B-axis Offset Data, Tool#1.
- 1347. C-axis Offset Data, Tool#1.

Format : □.□□□ , Unit: mm (Default=0.000)

- 1348. Tool#2, Radius offset data.
- 1349. X-axis offset data, Tool#2.
- 1350. Y-axis offset data, Tool#2.
- 1351. Z-axis offset data, Tool#2.
- 1352. A-axis offset data, Tool#2.
- 1353. B-axis offset data, Tool#2.
- 1354. C-axis offset data, Tool#2.

Format : □.□□□ , Unit: mm (Default=0.000)

MCM#1355~1620 : Tool#3~40, Radius offset data and X/Y/Z/A/B/C-axis offset data °

- 1621. Tool #1 radius wear compensation.
- 1622. X-axis, Tool #1 wear compensation.
- 1623. Y-axis, Tool #1 wear compensation.
- 1624. Z-axis, Tool #1 wear compensation.
- 1625. A-axis, Tool #1 wear compensation.
- 1626. B-axis, Tool #1 wear compensation.
- 1627. C-axis, Tool #1 wear compensation.

Format : □.□□□ , Unit: mm (Default=0.000)

- 1628. Tool #2 radius wear compensation.
- 1629. X-axis, Tool #2 wear compensation.
- 1630. Y-axis, Tool #2 wear compensation.
- 1631. Z-axis, Tool #2 wear compensation.
- 1632. A-axis, Tool #2 wear compensation.
- 1633. B-axis, Tool #2 wear compensation.
- 1634. C-axis, Tool #2 wear compensation.

Format : □.□□□ , Unit: mm (Default=0.000)

MCM#1635~1900 : Tool#3~40, Radius wear compensation and X/Y/Z/A/B/C-axis wear compensation °

1901~1940 : Tool-tip radius compensation (Tool-tip#1~40)

5 CONNECTIONS

5.1 Connections Configuration

H4D-M Controller connections schematic

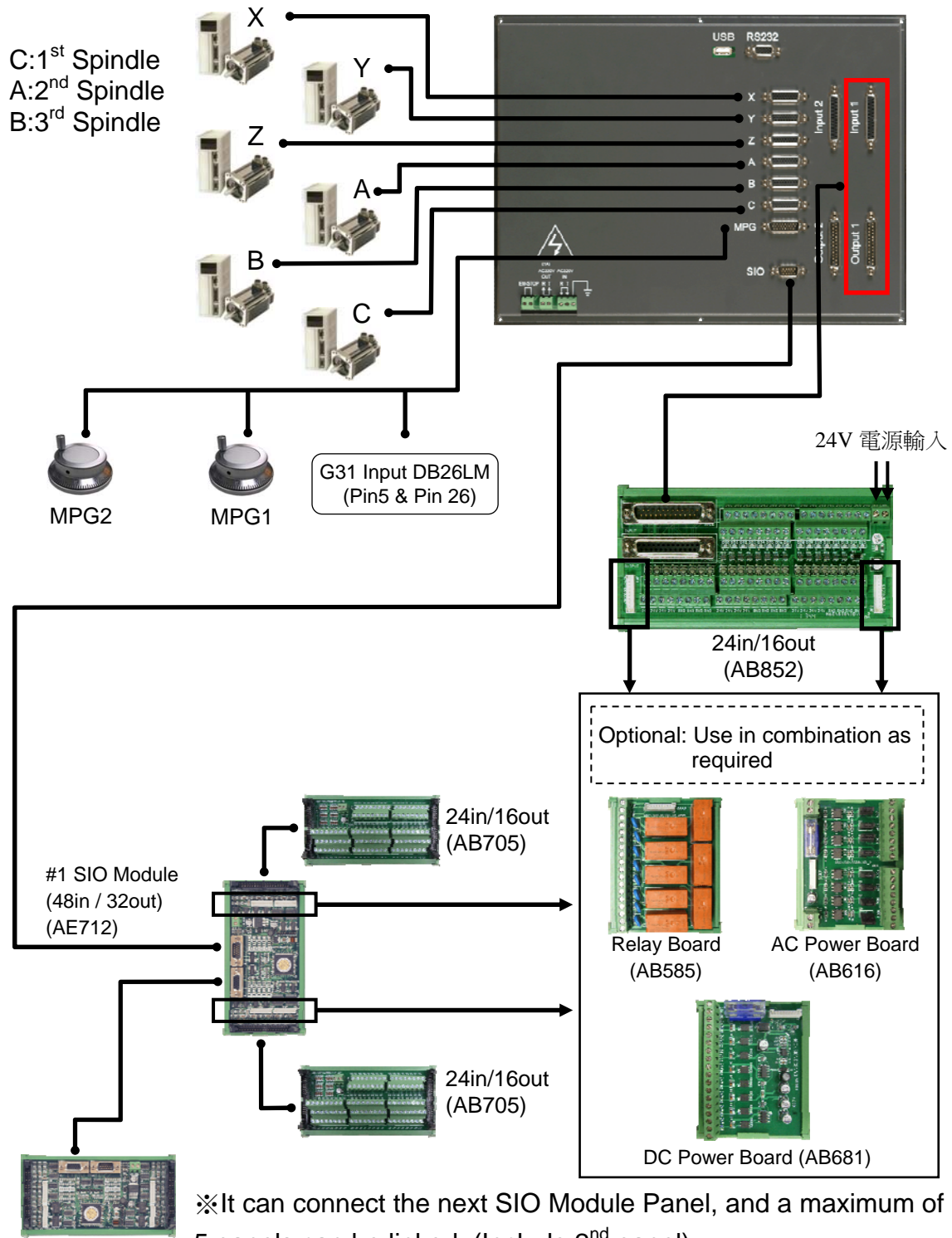

Fig.5-1

5.2 System installation

5.2.1 Operating Environment

H4D-M Serial Controllers must be used in the following surroundings; anomaly may occur if the specified range is exceeded.

- * Temperature of surroundings
 - Operation — 0°C to 45°C.
 - Storage or transfer — -20°C to 55°C.

- * Rate of temperature variation — Max. 1.1°C/min

- * Relative Humidity
 - Normal — < 80% RH
 - Short period — Max. 95% RH

- * Vibration limits
 - In operation — 0.075 mm max. at 5 HZ

- * Noise
 - In operation — Max. voltage pulse in 0.01 S
 - 2000 V/0.1×10⁻⁶ S

- * Other
 - Please consult our company for operations with a high amount of dust, cutting fluid or organic solvent.

5.2.2 Notes on the Control Unit Case Design

- * The controller and auxiliary panels shall be of a totally enclosed type to prevent dust ingress.
- * The internal temperature shall not exceed the surrounding temperature by more than 10°C.
- * Cable entries shall be sealed.
- * To prevent noise inference, a net clearance of 100mm shall be kept between the cables of each unit, AC power supply and CRT. If magnetic fields exist, a net clearance of 300mm shall be kept.

- * Refer to Server Operation Manual for the installation of servo driver.

5.2.3 Thermal Design of Cabinet

The internal temperature shall not exceed the surrounding temperature by more than 10°C. The main considerations for designing the cabin are the heat source and the heat dissipation area. For the controller, the customer is usually unable to control the heat source, however the heat dissipation area is a key factor to be considered. The internal temperature rise can be estimated using the following equations:

- (1) With a cooling fan, the permissible temperature rise shall be $1^{\circ}\text{C}/6\text{W}/1\text{m}^2$.
- (2) Without a cooling fan, the permissible temperature rise shall be $1^{\circ}\text{C}/4\text{W}/1\text{m}^2$.

The equations indicate that for a cabinet having a heat dissipation area of 1m^2 and a 6W heat source and a cooling fan (or 4W heat source without cooling fan), the internal temperature rise shall be 1°C . The heat dissipation area is the total surface area of the cabin minus the area in contact with the ground surface.

Ex.1:(with cooling fan)

heat dissipation area = 2 m^2

internal permissible temperature rise = 10°C

therefore the max. permissible heat source in the cabin is = $6\text{W} \times 2 \times 10 = 120\text{W}$. If heat source within the cabin exceeds 120W, a cooling fin or other heat dissipation device must be provided.

Ex.2:(without cooling fan)

heat dissipation area = 2 m^2

internal permissible temperature rise = 10°C

therefore the max. permissible heat source in the cabin is = $4\text{W} \times 2 \times 10 = 80\text{W}$. If heat source within the cabin exceeds 80W, a cooling fin or other heat dissipation device must be provided.

5.2.4 H4D-M External Dimensions

* H4D-M The Controller Panel



Fig.5-2 Panel of H4D-M Controller

* **H4D-M Cabinet Dimensions and Rear View port**

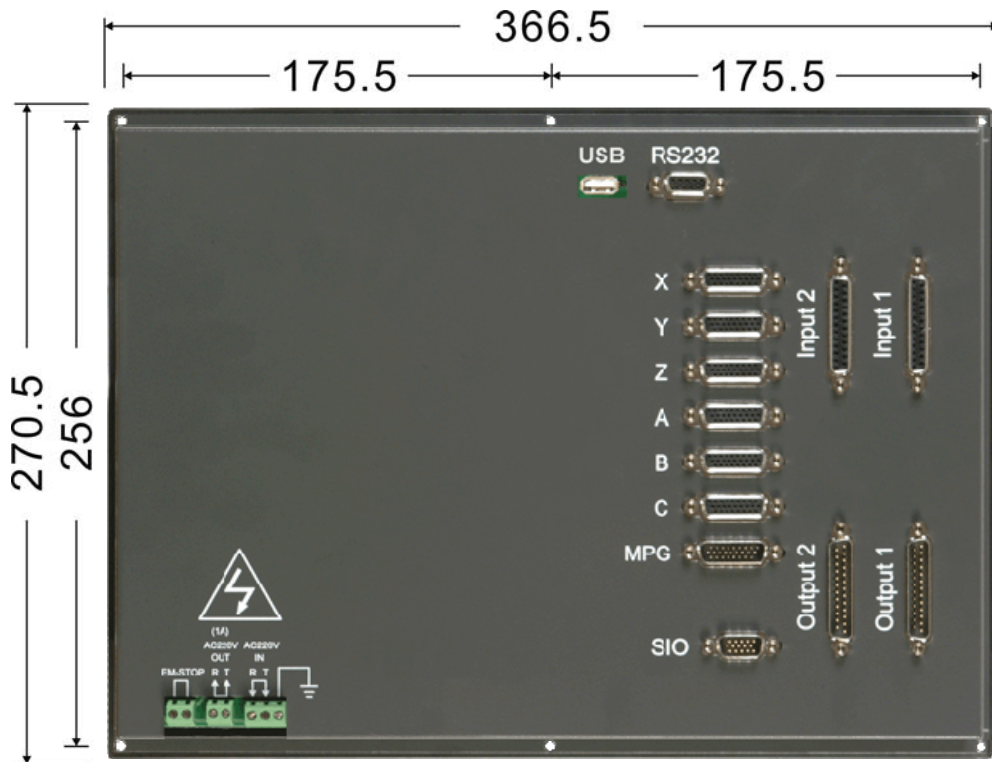

Fig.5-3 H4D-M Cabinet Dimensions and Rear View port

* **H4D-M Cutout Dimensions**

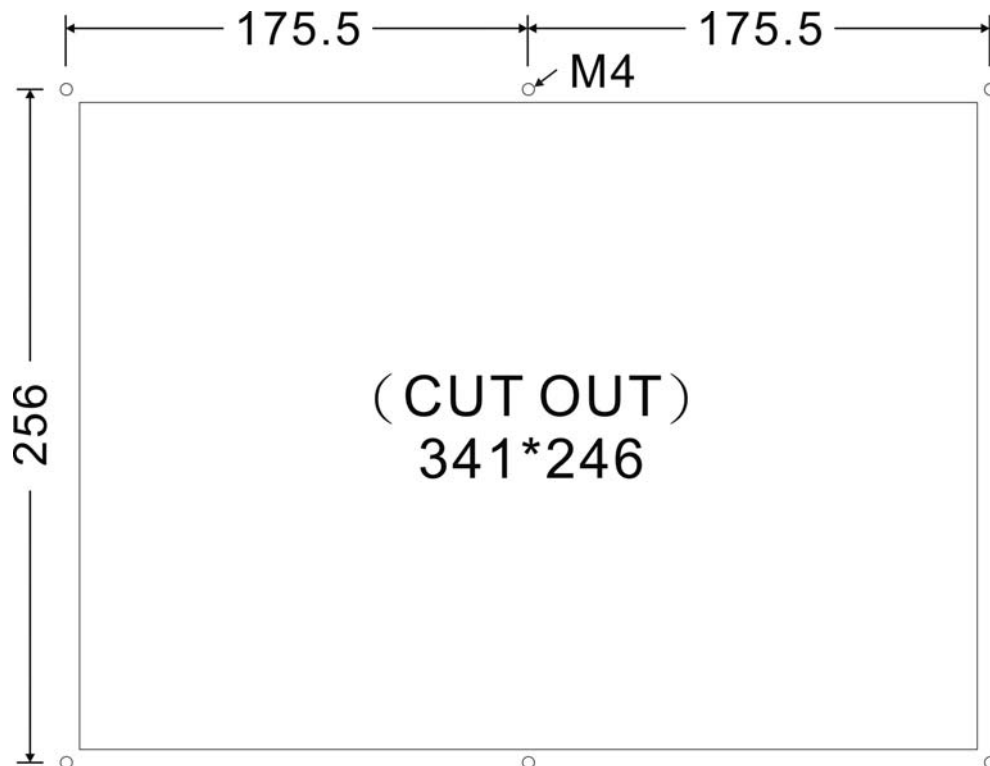

Fig.5-4 H4D-M Cutout Dimensions

5.2.5 H4D-M Accessories Dimensions

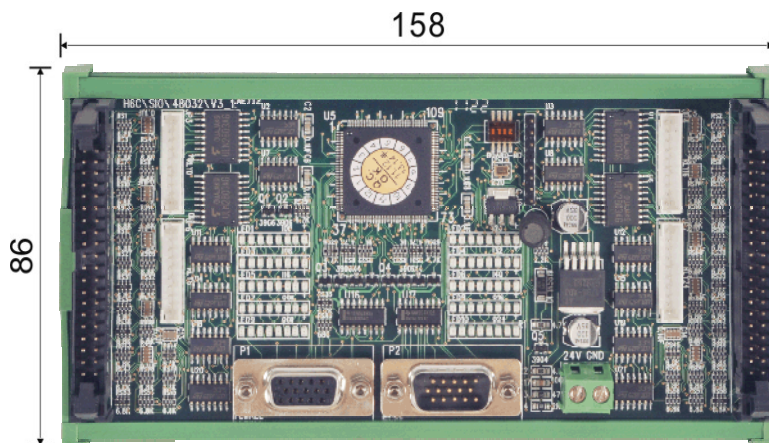

Fig.5-5 SIO Module : 48IN/32OUT

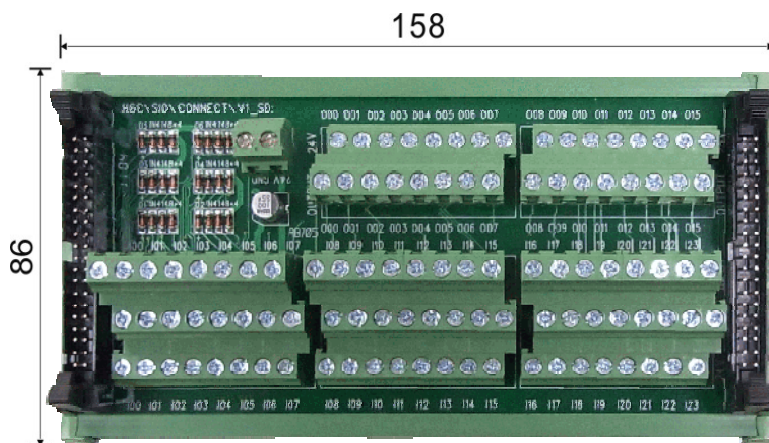

Fig.5-6 IO connect board : 24IN/16OUT

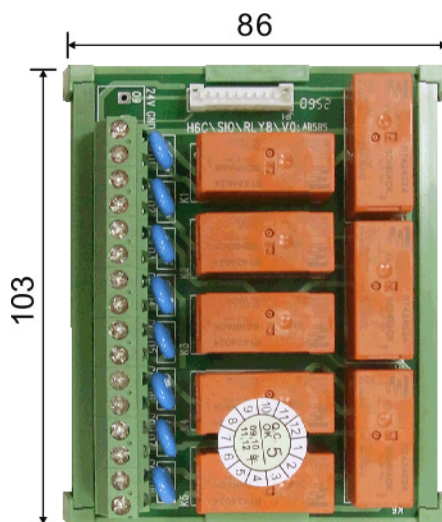

Fig.5-7 NPN Output relay board : 8 Out

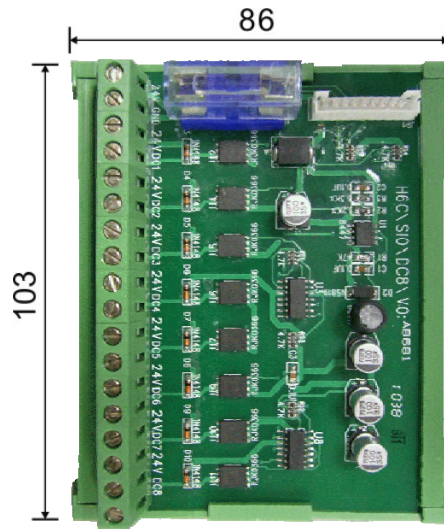

Fig.5-8 DC Power module board : 8 Out

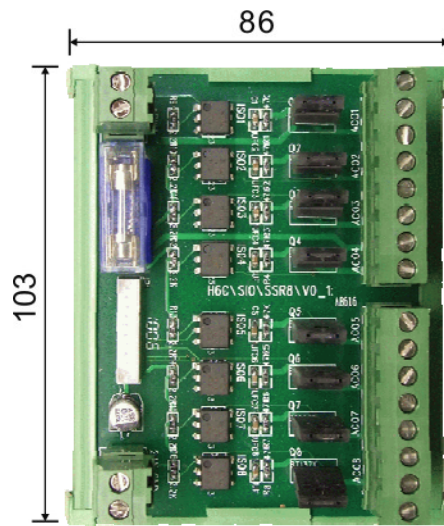

Fig.5-9 AC Power output module board : 8 Out

5.3 Connector Type

HUST H4D/H6D/H9D Series Controller rear panel connectors:

- DBxx : xx indicates number of pins
- DB26L : 26-pin connector
- DB26LF : a terminal with a female 26-pin connector
- DB26LM : a terminal with a male 26-pin connector

5.4 Connector name

Connector types of the controller are as follows:

Table 5-1 Names and types of connectors

Connector Name	Connector Designation	Type
X-axis servo	X-AXIS	DB26LF (F)
Y-axis servo	Y-AXIS	DB26LF (F)
Z-axis servo	Z-AXIS	DB26LF (F)
A-axis servo	A-AXIS	DB26LF (F)
B-axis servo	B-AXIS	DB26LF (F)
C-axis servo	C-AXIS	DB26LF (F)
MPG Handwheel	MPG	DB26LM (M)
Standard INPUT-1	INPUT-1	DB25LF (F)
Standard OUTPUT-1	OUTPUT-1	DB25LF (M)
Standard INPUT-2	INPUT-2	DB25LF (F)
Standard OUTPUT-2	OUTPUT-2	DB25LF (M)
Communication Interface	RS232	DB9LF (F)
	USB	USB (F)

5.5 Connector Pin-out Definition

* X-AXIS



DB26LF (F)

Table 5-2 X Axis Connector Pin

Pin No	Definition	Description
1	/A	/A phase input
2	A	A phase input
3	B	B phase input
4	/B	/B phase input
5	Z	Z phase input
6	/Z	/Z phase input
7	VCMD	0~10V analog command
8	GND	5V GND (V-command、Torgue & +5V GND)
9	5V	+5V Power
10	TOG	Torgue input
11	-	-
12	-	-
13	-	-
14	-	-
15	-	-
16	-	-
17	IN-49	Group 2 Input signal
18	OUT-49	Group 2 Output signal
19	Pulse+	
20	Pulse-	
21	Sign+	Pulse Direction+
22	Sign-	Pulse Direction -
23	IN-48	Group 1 Input signal
24	OUT-48	Group 1 Output signal
25	24V	+24V Power
26	24VGND	24V GND I/O & +24V GND

※ Output current at O: 30mA (H6D\CPU\V6_1 : 50mA)

*** Y-AXIS**



DB26LF (F)

Table 5-3 Y Axis Connector Pin

Pin No	Definition	Description
1	/A	/A phase input
2	A	A phase input
3	B	B phase input
4	/B	/B phase input
5	Z	Z phase input
6	/Z	/Z phase input
7	VCMD	0~10V analog command
8	GND	5V GND (V-command · Torgue & +5V GND)
9	5V	+5V Power
10	TOG	Torgue input
11	-	-
12	-	-
13	-	-
14	-	-
15	-	-
16	-	-
17	IN-51	Group 2 Input signal
18	OUT-51	Group 2 Output signal
19	Pulse+	
20	Pulse-	
21	Sign+	Pulse Direction+
22	Sign-	Pulse Direction -
23	IN-50	Group 1 Input signal
24	OUT-50	Group 1 Output signal
25	24V	+24V Power
26	24VGND	24V GND I/O & +24V GND

※ Output current at O: 30mA (H6D\CPU\V6_1 : 50 mA)

* Z-AXIS



DB26LF (F)

Table 5-4 Z Axis Connector Pin

Pin No	Definition	Description
1	/A	/A phase input
2	A	A phase input
3	B	B phase input
4	/B	/B phase input
5	Z	Z phase input
6	/Z	/Z phase input
7	VCMD	0~10V analog command
8	GND	5V GND (V-command · Torgue & +5V GND)
9	5V	+5V Power
10	TOG	Torgue input
11	-	-
12	-	-
13	-	-
14	-	-
15	-	-
16	-	-
17	IN-53	Group 2 Input signal
18	OUT-53	Group 2 Output signal
19	Pulse+	
20	Pulse-	
21	Sign+	Pulse Direction+
22	Sign-	Pulse Direction -
23	IN-52	Group 1 Input signal
24	OUT-52	Group 1 Output signal
25	24V	+24V Power
26	24VGND	24V GND I/O & +24V GND

※ Output current at O: 30mA (H6D\CPU\V6_1 : 50mA)

*** A-AXIS**



DB26LF (F)

Table 5-5 A Axis Connector Pin

Pin No	Definition	Description
1	/A	/A phase input
2	A	A phase input
3	B	B phase input
4	/B	/B phase input
5	Z	Z phase input
6	/Z	/Z phase input
7	VCMD	0~10V analog command
8	GND	5V GND (V-command · Torgue & +5V GND)
9	5V	+5V Power
10	TOG	Torgue input
11	-	-
12	-	-
13	-	-
14	-	-
15	-	-
16	-	-
17	IN-55	Group 2 Input signal
18	OUT-55	Group 2 Output signal
19	Pulse+	
20	Pulse-	
21	Sign+	Pulse Direction+
22	Sign-	Pulse Direction -
23	IN-54	Group 1 Input signal
24	OUT-54	Group 1 Output signal
25	24V	+24V Power
26	24VGND	24V GND I/O & +24V GND

※ Output current at O: 30mA (H6D\CPU\V6_1 : 50mA)

* B-AXIS



DB26LF (F)

Table 5-6 B Axis Connector Pin

Pin No	Definition	Description
1	/A	/A phase input
2	A	A phase input
3	B	B phase input
4	/B	/B phase input
5	Z	Z phase input
6	/Z	/Z phase input
7	VCMD	0~10V analog command
8	GND	5V GND (V-command · Torgue & +5V GND)
9	5V	+5V Power
10	TOG	Torgue input
11	-	-
12	-	-
13	-	-
14	-	-
15	-	-
16	-	-
17	IN-57	Group 2 Input signal
18	OUT-57	Group 2 Output signal
19	Pulse+	
20	Pulse-	
21	Sign+	Pulse Direction+
22	Sign-	Pulse Direction -
23	IN-56	Group 1 Input signal
24	OUT-56	Group 1 Output signal
25	24V	+24V Power
26	24VGND	24V GND I/O & +24V GND

※ Output current at O: 30mA (H6D\CPU\V6_1 : 50mA)

*** C-AXIS**



DB26LF (F)

Table 5-7 C Axis Connector Pin

Pin No	Definition	Description
1	/A	/A phase input
2	A	A phase input
3	B	B phase input
4	/B	/B phase input
5	Z	Z phase input
6	/Z	/Z phase input
7	VCMD	0~10V analog command
8	GND	5V GND (V-command · Torgue & +5V GND)
9	5V	+5V Power
10	TOG	Torgue input
11	-	-
12	-	-
13	-	-
14	-	-
15	-	-
16	-	-
17	IN-59	Group 2 Input signal
18	OUT-59	Group 2 Output signal
19	Pulse+	
20	Pulse-	
21	Sign+	Pulse Direction+
22	Sign-	Pulse Direction -
23	IN-58	Group 1 Input signal
24	OUT-58	Group 1 Output signal
25	24V	+24V Power
26	24VGND	24V GND I/O & +24V GND

※ Output current at O: 30mA (H6D\CPU\V6_1 : 50mA)

* MPG (H4D/H6D)

H4D & H9D that Pin10、Pin11 different only, Please reference the Table 5-8、
Table 5-9



DB26LM (M)

Table 5-8 H4D/H6D <MPG> Definition

PinNo	Definition	Description	MPG1	MPG2	DA1	DA2	AD1	AD2	G31
1	A1	A phase output (MPG1)	●						
2	B1	B phase output (MPG1)	●						
3	A2	A phase output (MPG2)		●					
4	B2	B phase output (MPG2)		●					
5	G31 IN	Inputs signal to control high-speed axial stop							●
6	GND	5V GND MPG、AD/DA & +5V GND	●	●	●	●	●	●	
7									
8									
9	5V	+5V Power	●	●					
10	IN-86	Group 18 input signal							
11	IN-87	Group 19 input signal							
12	DA1	0~10V analog command 1			●				
13	DA2	0~10V analog command 2				●			
14	AD1	±10V analog command Input 1					●		
15	AD2	±10V analog command Input 2						●	
16									
17	D+	CANOpen Signal							
18	D-	CANOpen Signal							
19	IN-80	Group 12 input signal							
20	IN-81	Group 13 input signal							
21	IN-82	Group 14 input signal							
22	IN-82	Group 15 input signal							
23	IN-84	Group 16 input signal							
24	IN-85	Group 17 input signal							
25	24V	+24V Power							
26	24VGND	24V GND I/O、G31、+24VGND							●

*** MPG (H9D)**

H4D & H9D that Pin10、Pin11 different only, Please reference the Table 5-8、Table 5-9.



DB26LM (M)

Table 5-9 H9D <MPG> Definition

PinNo	Definition	Description	MPG1	MPG2	DA1	DA2	AD1	AD2	G31
1	A1	A phase output (MPG1)	●						
2	B1	B phase output (MPG1)	●						
3	A2	A phase output (MPG2)		●					
4	B2	B phase output (MPG2)		●					
5	G31 IN	Inputs signal to control high-speed axial stop							●
6	GND	5V GND MPG、AD/DA & +5V GND	●	●	●	●	●	●	
7									
8									
9	5V	+5V Power	●	●					
10	IN-86	+12V Power							
11	IN-87	-12V Powe							
12	DA1	0~10V analog command 1			●				
13	DA2	0~10V analog command 2				●			
14	AD1	±10V analog command Input 1					●		
15	AD2	±10V analog command Input 2						●	
16									
17	D+	CANOpen Signal							
18	D-	CANOpen Signal							
19	IN-80	Group 12 input signal							
20	IN-81	Group 13 input signal							
21	IN-82	Group 14 input signal							
22	IN-82	Group 15 input signal							
23	IN-84	Group 16 input signal							
24	IN-85	Group 17 input signal							
25	24V	+24V Power							
26	24VGND	24V GND I/O、G31、+24VGND							●

* Axial Control, pin assignment and wiring

Connections for the Axis Connectors on the Controller to the Servo Driver in Fig.5-10 (pin assignment identical for all axes).

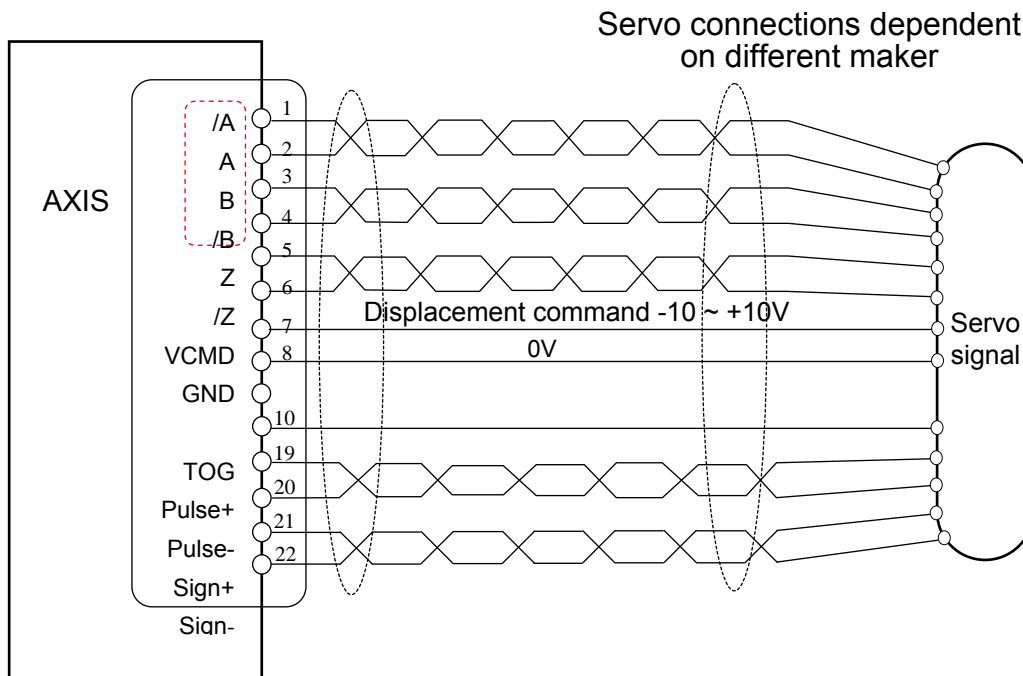

Fig 5-10 Wiring for Axial Control

1. **Isolated twist-pair cables** shall be used.
2. Pay special attention to Pins 1-4 of the axial connection. In case the motor runs scattering, alter the terminal A with the terminal B at the driver end.
3. HUST miller controller, when voltage-command type servo motor is used, you need to set the Follow Error checking function. (Not applicable to pulse commands.)
 - (a) Parameter 533 = 4096 → check the value of Follow Error.
 - (b) Parameter 543 = 63 → check Follow Error of the axis X/Y/Z/A/B/C simultaneously (set by BIT: Bit0=1 for X-axis, Bit1=1 for Y-axis.....).
 - (c) When the ERROR COUNT of the actual feedback of X-axis motor >4096, the system will issue an error message.

*** MPG Hand-wheel Connecting Diagram**

- HUST H4D Series can be provided with 2 manual pulse generators at the same time.
- If the direction of tool travel is not the same as indicated by the MPG, use Parameter 518, handwheel direction, to correct it.
(If the machine is equipped with two handwheels, the directions of the two handwheels will be modified at the same time.)
- Use 2nd hand wheel .
 - If C237=1 in the PLC, MPG2 terminals can be used.
 - Use R243 to control the axes.
 - Adjust the multiplier using R245.
- MPG Pin 6、7、8 are 5V GND.

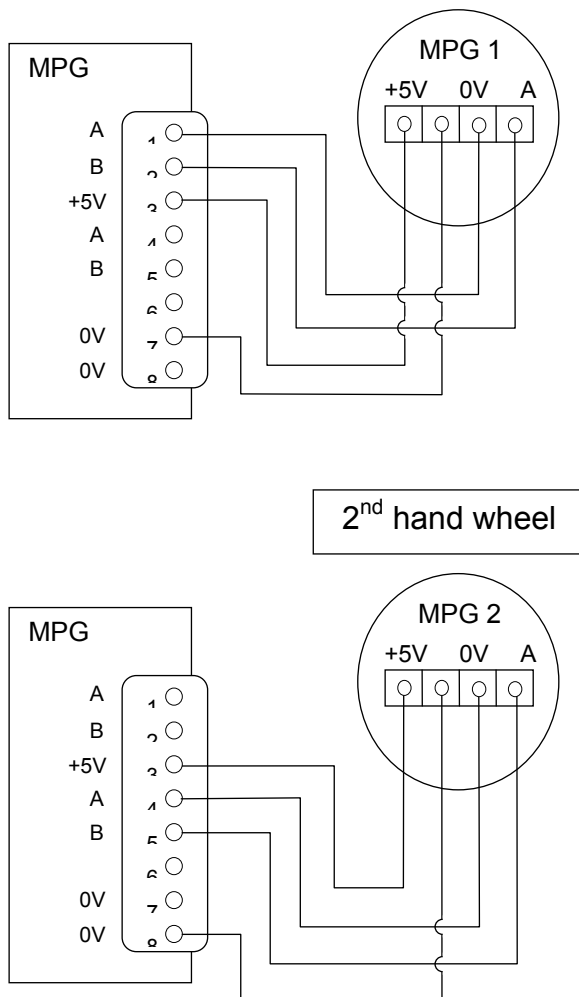

Fig 5-11

* **G31 INPUT Control signals**

Contol High-Speed axial stop, responding in 0.5 μ sec.

Table 5-10

Settings for related Parameters and Registers	Description
R250	Setting = 0, I-bit Input signal is an ascending (0→1) trigger signal
	Setting = 1, I-bit Input signal is a descending (1→0) trigger signal
	Setting = 2, I-bit Input signal is a Normal Open (0) signal
	Setting = 3, I-bit Input signal is a Normal Close (1) signal

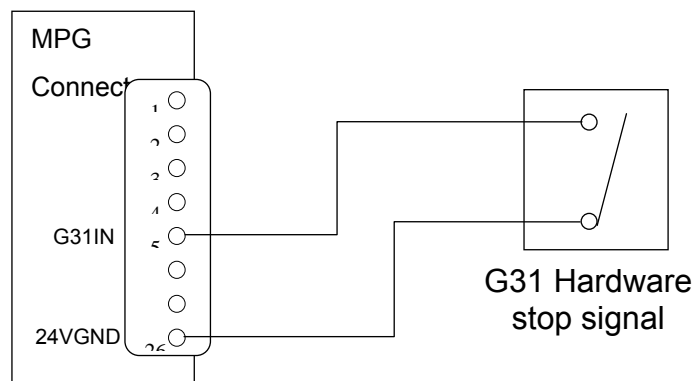

Fig 5-12 G31 INPUT Signal Wiring

*** AD/DA Analog Signal Wiring**

Table 5-11

Register	Function	Description
R209	Analog Input & Torque function enable	Edit by PLC <R209 bit3=1>
R142	AD1, Indicates balue of #1 analog voltage input	Pin 14 · Pin 8
R143	AD2, Indicates balue of #2 analog voltage input	Pin 15 · Pin 8
R146	AD1, Indicates balue of #1 analog voltage output	Pin 12 · Pin 8
R147	AD2, Indicates balue of #2 analog voltage output	Pin 13 · Pin 8

※ Note : R209 bit3=1 that analog Input function must enable.

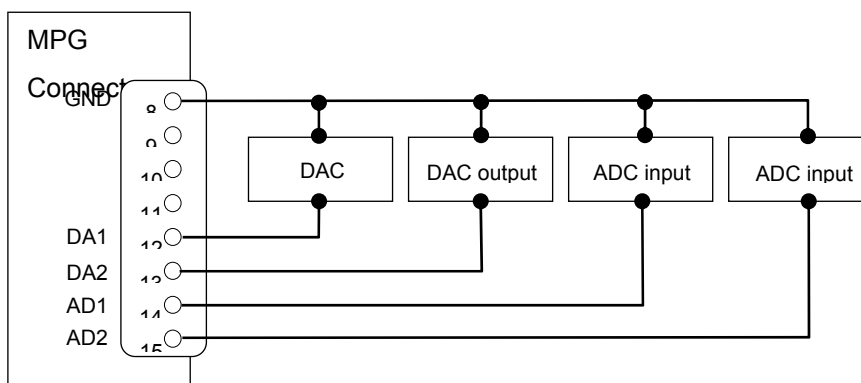

Fig 5-13 AD/DA AD/DA Analog Signal Wiring

* **Wiring of spindle control**

There are 2 types of Spindle Control:

- (a) Voltage Command type
- (b) Pulse Command type

(a) Wiring of spindle control : Voltage Command type

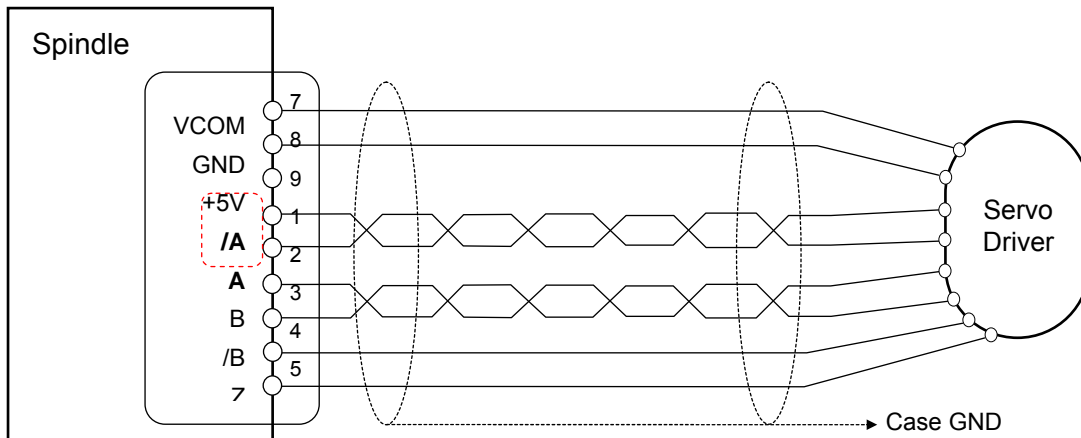

Fig 5-14 Spindle (servo) voltage command control-**closed circuit wiring**

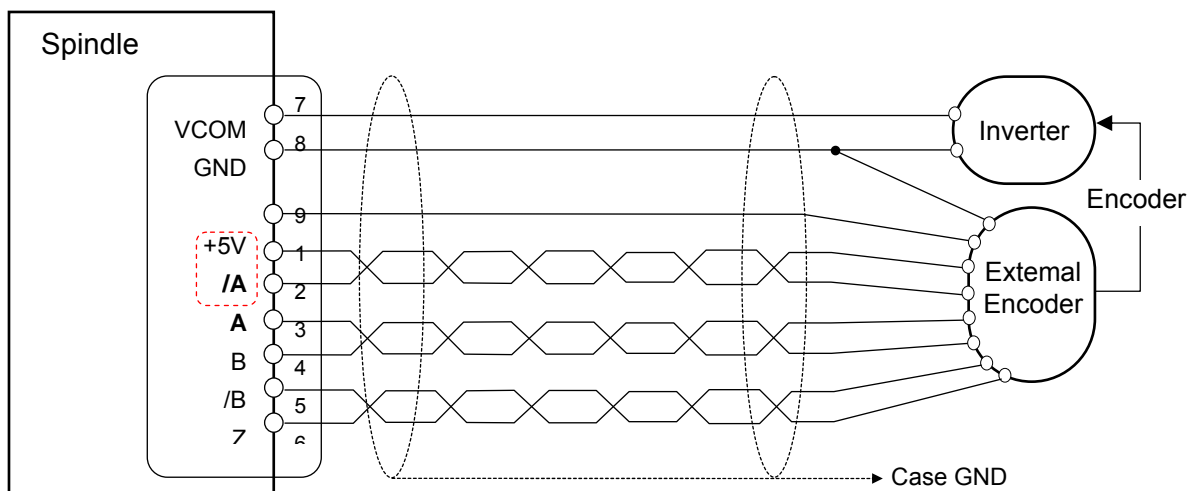

Fig 5-15 Spindle (Inverter) Voltage Command Control- **Open circuit wiring**

(b) Wiring of spindle control : Pulse Command Type

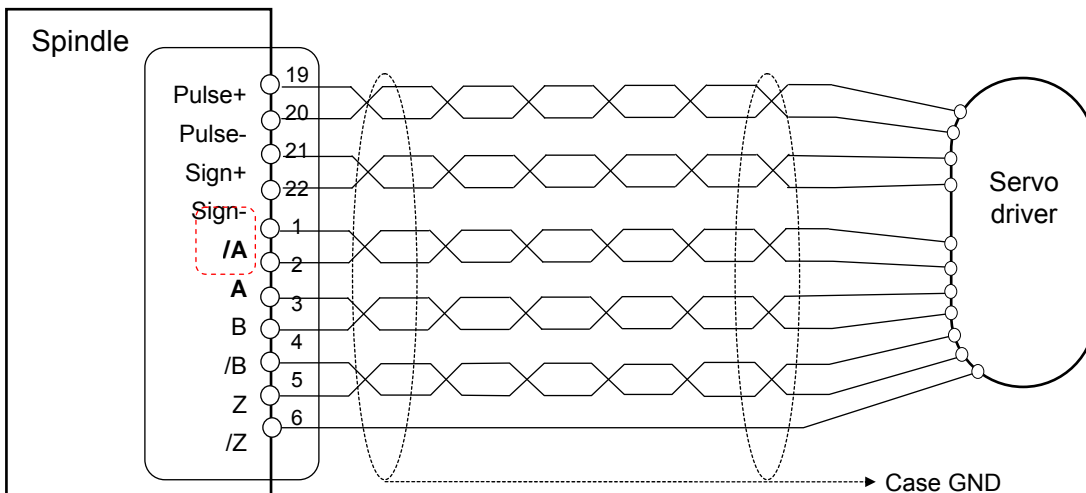

Fig 5-16 Spindle (servo) pulse command control- **closed circuit wiring**

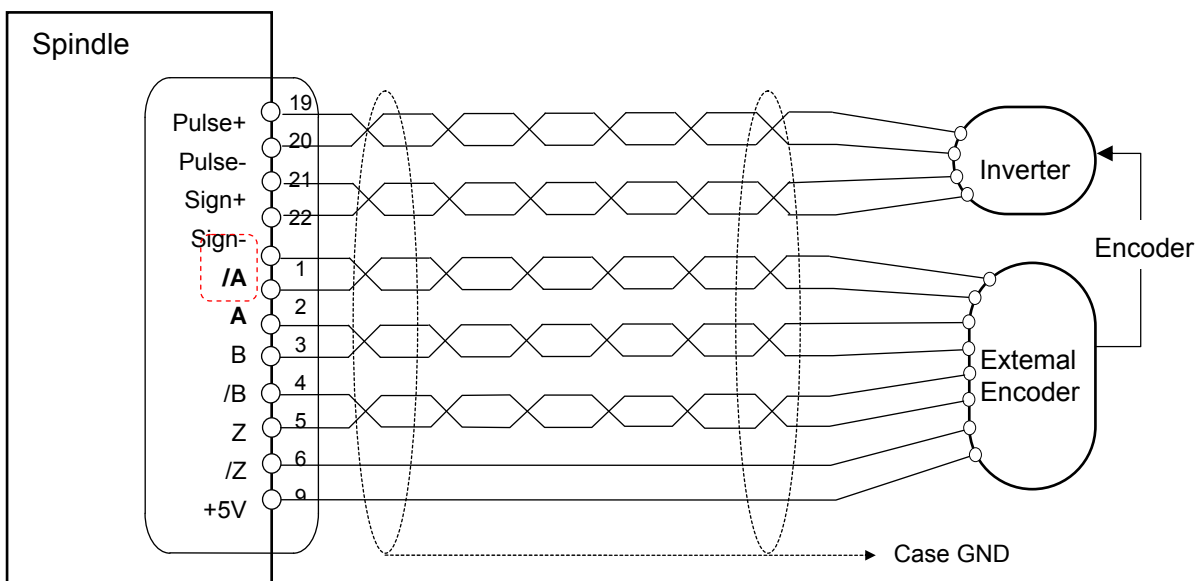

Fig 5-17 Spindle (Inverter) pulse command control- **closed circuit wiring**

*** AC Power System Connection**

In order to avoid controller anomalies caused by voltage fluctuations, it is recommended to provide sequential differences for the ON/OFF of the CNC power and Servo power.

1. SERVO ON signal shall be activated in a slight delay after the activation of system power supply, when the latter is stabilized.
2. Before switching off the system power supply, provide a delay for switching off the SERVO ON signal first.

CNC Power/ SERVO Power ON-OFF sequence diagram

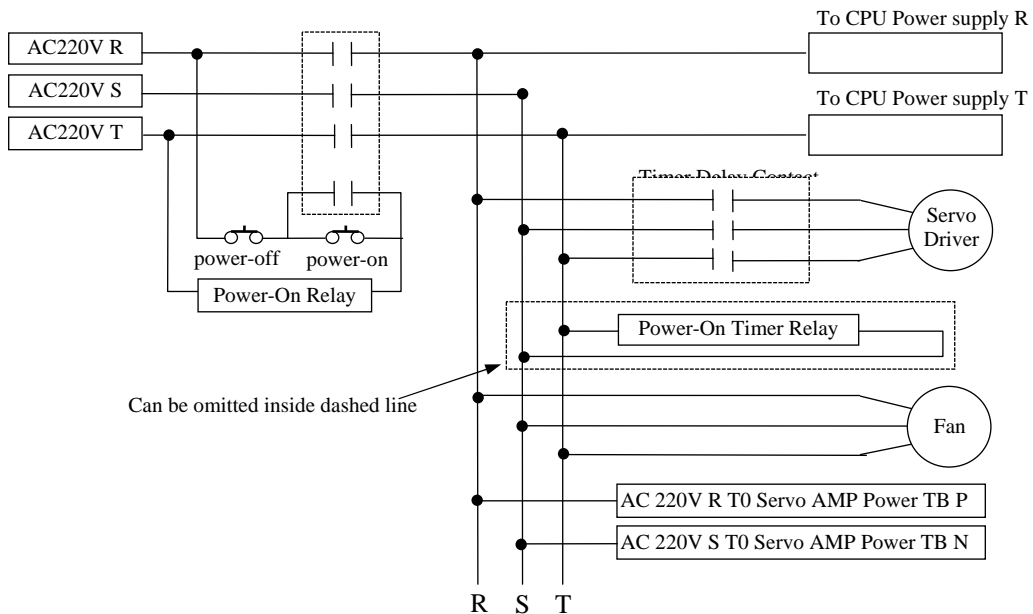
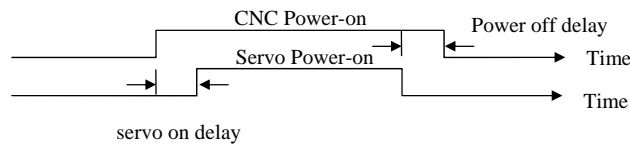

Fig 5-18 Wiring of System AC Power Supply

*** RS232 Connector Pin Assignment and Connection Diagram**

Fig 5-19 shows the connection between the HUST H4D controller and the PC. Please observe the following guidelines:

1. Do not exceed 15 meters for the cable connecting RS232 port and the PC.
2. The interface voltage on the PC side should be in the range 10 ~ 15V.
3. Try NOT to work in an environment where electrical noises are common, such as EDM machine and electric welder. Do not use the same power source as EDM machine or electric welder. Twist RS232 cables if possible.

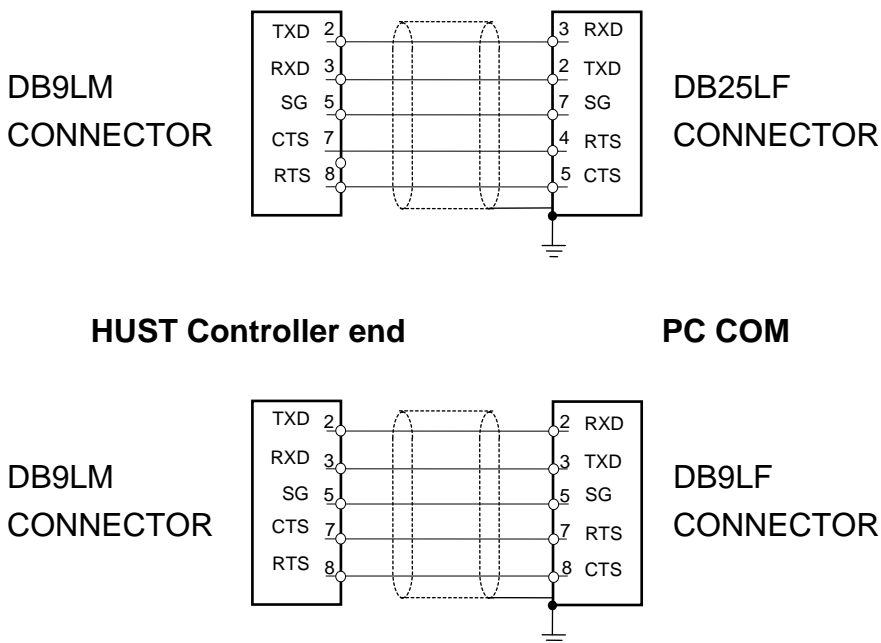
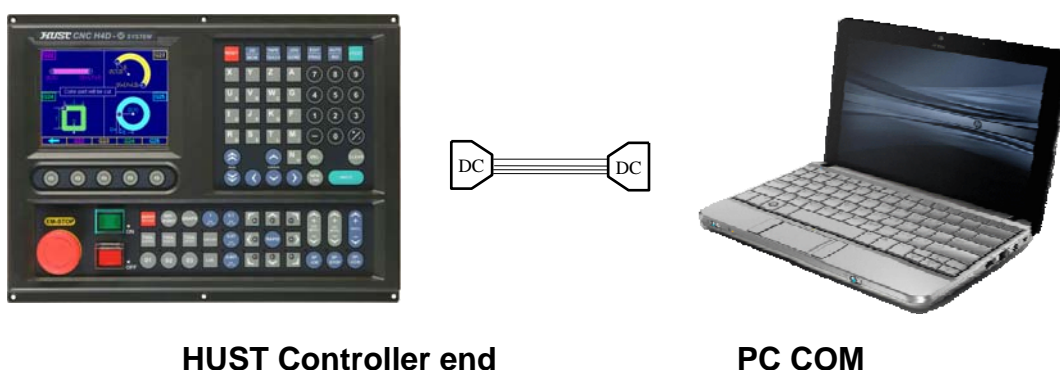

Fig 5-19 RS232C Connector Pin Assignment

6 ERROR MESSAGES

When an error occurs in the execution of an HUST H4D-M series controller, an error message will appear in the LCD screen as shown in Fig.6-1. Possible error messages regarding the HUST H4D-M series controller, together with their remedies, are described as follows.

Code	Causes	Code	Causes	Code	Causes
01	MCM Data Error	13	G/M/T & R Code Error	32	G76/G92 E,P Command Error
02	Follow error > setting value	14	Axis Hardware Over-Travel	36	Transferred Error
04	USB/SDC Error	15	Search Grid Distance Exceed	37	OutSide Device Error
05	System Error	18	End of Program Error	38	Screen Reading time > 3s
07	Flash rom "Write to" Error	20	Axis Software Over-Travel	39	Tool-Life Reaching
08	MDI Command Error	22	EM-Stop	50	User Defined Error(G65)
09	G31 Signal Read Error	25	G02/G03 Command Error	51	User defined error by G65 macro
10	RS232 Error	28	G71~G73 Command Error	99	
11	Program Check Sum Error	29	A,R,C of G Code Error		
12	Program Burning Error	31	PLC Error		
Spindle		Spindle error			
Axes		X Axis Error Y Axis Error Z Axis Error A Axis Error			
Other Device					

Fig 6-1 Error Message Display

Error Code	Details	Causes
01		Incorrect MCM parameter setting.
	B	Each axis returned to origin, GRID limit of the servo motor >1024.

Remedy:

1. Check MCM parameter for correct setting or double-press  to enter "MDI" mode, execute command **G10 P1000** to delete parameter, then re-set parameter.
2. If the controller has rested for more than a year without switching on, the internal memory will disappear. The controller will display [BT1] indicating the battery power is low and you need to contact the dealer.

Error Code	Details	Causes
02	X~C	Excessive error in Axial Follow.
	S	Excessive error in Spindle Follow (>3072).

Remedy:

1. Check the program for excessive setting of F value;
2. Check whether the Resolution setting is correct (Check items 241~ 252, MCM parameters);
3. Check if machine or motor is obstructed. Check the wiring.
4. Check Parameter 533; the default value is 4096.

Error Code	Details	Causes
03	L	M99 count exceeds maximum limit (#10922>#10921).

Message:

Setting of the M02, M30, or M99 counter exceeds the limit of system variables, 10921.

Remedy:

1. Double press "0" button in AUTO mode to clear the counting value.
2. Clear the system variable count of 10922 so it returns to 0, then press to remove the error.
3. Or run G10 P201 command in AUTO or MDI mode, for clearing the system variable (10921) to 0, then press again to clear the error.

Error Code	Details	Causes
04	A	U USB/SDC error —FR_DISK_ERR
	B	USB/SDC error —FR_INT_ERR
	C	USB/SDC error —FR_NOT_READY
	D	USB/SDC error —FR_NO_FILE
	E	USB/SDC error —FR_NO_PATH
	F	USB/SDC error —FR_INVALID_NAME
	G	USB/SDC error —FR_DENIED
	H	USB/SDC error —FR_EXIST
	I	USB/SDC error —FR_INVALID_OBJECT
	J	USB/SDC error —FR_WRITE_PROTECTED
	K	USB/SDC error —FR_INVALID_DRIVE
	L	USB/SDC error —FR_NOT_ENABLED
	M	USB/SDC error —FR_NO_FILESYSTEM
	N	USB/SDC error —FR_MKFS_ABORTED
	O	USB/SDC error —FR_TIMEOUT

Remedy:

1. Make sure the USB is of FAT format and the file extension of the transferred program is correct.
2. Consult the dealer or the manufacturer.

Error Code	Details	Causes
08	D	Incorrect Data Address retrieved when executing ZDNC.
	M	MDI command error (command size greater than 128bytes).
	E	Size of current program segment exceeds 128bytes.

Remedy:

Check the program and make sure that each segment is within 128 characters.

Error Code	Details	Causes
10	O	RS232 error —OVERRUN ERROR
	P	RS232 error —PARITY ERROR
	F	RS232 error —FRAME ERROR
	B	RS232 error —BREAK ERROR
	N	RS232 error —OTHER ERROR

Remedy:

1. Check transmission speed of controller communication port, i.e., parameter 520 of MCM is the same value as that of PC or man-machine interface.
2. Check the communication cables between the controller and the PC or the man-machine interface.

Error Code	Details	Causes
11	1	CHECKSUM error of program
	A	SUM error in the Start-up check
	D	Program Memory address error (DOWN MODE)
	F	Program Memory is full
	U	Program Memory address error (UP MODE)

Remedy:



Double-press  button to enter MDI mode. Run **G10 P2001** command to clear all the program data, check the memory battery. If the controller displays battery low (BT1) message, you need to replace the battery (data in the memory will be lost if the controller remains OFF for more than one year).

Error Code	Details	Causes
12		The size of the burn-in program exceeds the limit H4 Series:56k H6 Standard: 56k= 896 lines, 64bytes per line H6 Turning/Milling: 56k +128k (saving capacity for function key) =2944 lines. Since the current limit for burn-in is 128k, therefore the maximum size is 128k (=2048 lines).
	N	The declared command exceeds 20 program lines (G11, G12, G04, M-code).
	L	L error in "G10 P0920 Lxxxx" (L shall not be empty, and 0<=LA<1000)
	P	Program specified by Lxxxx in "G10 P0921 Lxxxx" has not been declared.

Remedy:

1. Check the program for incorrect writing.
2. Check the capacity for the program.

Error Code	Details	Causes
13	G	G error code. During the G87 command, neither of R209 BIT10 and 11 is ON.
	T	T error code.
	M	M error code (MA<0).
	R	An R error in commands G81~G89. (1) R and Z(A) have different symbols. (2) R and [Z(A)-R] have different symbols.

Remedy:

1. Check the program and make sure the G-code setting is correct
2. Check if the PLC is set to support the G-command.

Error Code	Details	Causes
14	X C	X, Y, Z, A, B, or C-axis Hard limit (OT) .

Remedy:

Manually move the axis into its working range.

Error Code	Details	Causes
15	L	Servo motor returns to Origin to find GRID signal, the distance exceeds the setting range of the parameter.

Remedy:

1. Make sure that values set for parameters 401~406 are greater than the distance made by one revolution of the servo motor.

Ex.:

Distance of one revolution of the X-axis servo motor = 5.000mm, then
MCM401 = 5.200

2. Check the CPU for correct wiring.

Error Code	Details	Causes
18		There have some error in programming occurs when executing the program in AUTO mode.
	C	Error of copied segment in the program; cause for the error may be one of the following: <ol style="list-style-type: none"> 1. Non-existence of the source program. 2. Starting line-no. > Ending line-no. in the source program 3. Starting line-no. > total line-number of the source program 4. Ending line-no. > total line-number of the source program 5. Missing program number in the pasting target. 6. Starting line-no. of the pasting target > total line-number. 7. Memory is full when the pasting content has not been fully pasted. 8. Source program = pasting target program no.; and, starting line of source program <= starting line no. of pasting target <= ending line no. of source program.
	M	Trigger C25 segment data retrieval error: cannot find initial address of specified segment.
	T	Failure in finding initial address of specified program.
	Q	M95Qxxx error (QA is out of 0~127, or QA specified program does not exist).
	L	M99 jump-back program error (G10P301 specified line-no. error).
P	Empty CALL in sub-program. (G60...G63)	

Remedy:

1. Check the ending of the program and add M02 or M03 segment.
2. Check the program for excessive size.
3. Check for any error in the segment content and in serial setting (N) of the specified segment.

Error Code	Details	Causes
20	X C	X, Y, Z, A, B, C- axis software OT limit.
	N	Number of position limits set in the dynamic range of the software exceeds 4000.

Remedy:

Check the program or re-set MCM parameters 581~586 and 601~606, the software travel limits.

Error Code	Details	Causes
22		Emergency Stop (C002=1).

Remedy:

After removal of error, turn off the Emergency Stop pushbutton, followed by pressing the RESET button.

Error Code	Details	Causes
24		Memory Stack error.

Remedy:

Check for repetitive use of CALL subroutine.

Error Code	Details	Causes
25		G02/G03 command error (Radius of starting point unequal to radius of ending point).
	R	Incorrect input format of R in G02/G03 No displacement in both axes of arc interpolation, or (R<0 in lathe mode).
	L	2*[RAR]>[LENGTH].
	G	I, J, R not specified in G02/G03 command.

Remedy:

Check the program. Re-calculate arc intersection and verify its coordinates.

Error Code	Details	Causes
27	X . . . C	For X~C, when C28=1 and R190 ≠ 0, R190 < the deceleration distance of respective axis after the motor receives the INPUT of G31.

Remedy:

1. Check if R190 setting is too short so that it is less than the acceleration distance.
2. Shorten the acceleration/ deceleration time setting (**Motor load to be considered**).

Error Code	Details	Causes
28	N	MISSING G70 WITH G7x COMMAND.
	W	[ZA] DIR. SHOULD BE DIFFERENT FROM [G70WA].
	U	[XA] DIR. SHOULD BE DIFFERENT FROM [G70UA].

Remedy:

Check for any error in the cutting cycle command of the lathe.

Error Code	Details	Causes
29	G	The G code that includes C, R, or A segment is not G00..G04.
	P	Incorrect parameter setting.
	A	Incorrect setting of A_ or its relative parameter.
	R	Incorrect setting of R_ or its relative parameter.
	C	Incorrect setting of C_ or its relative parameter

Remedy:

Check if the relative parameter setting is incorrect.

Error Code	Details	Causes
31		Missing PLC.

Remedy:

1. Upload the PLC.
2. Consult the dealer or the manufacturer.

Error Code	Details	Causes
32	E	E in G92 is not within the (1.0~100.0) range (imperial unit).
	P	P in G76 is not within the (30~90) range.
	L	End of cutting – preset length < max. cutting depth.
	D	G76 (max. cutting depth) < 0.
	C	CANPX-CANPR < CHAMX Threading length < threading tool withdraw length.

Remedy:

Check for any error in the cyclic tapping command of the lathe.

Error Code	Details	Causes
33	4	Kxx=0 in G34.
	5	Kxx=0 in G35.
	6	Kxx=0 in G36.
	7	Pxx<=0 or Kxx=0 in G37.
		Execute G35, G36, or G37 in lathe mode.

Remedy:

Check for any error in K setting in commands G34~37 of the lathe.

Error Code	Details	Causes
36	B	Header of USB/SDC file is not 'O8001'. Header of USB/SDC file is not 'O8002'.
	C	Header of MCM file is not 'O9002'.
	F	Header of function key file is not 'O9140'. Header of variable file is not 'O9004'.
	L	Header of PLC file is not 'O9003'. Size of PLC document exceeds upper limit.
	P	Input program no. exceeds 1000 (Oxxxx).
	R	LENGTH OR SUM ERROR #13245, #13246, #13247, #13248.
	S	Header of SYS file is not 'O9100'. Size of SYS document exceeds upper limit.
	T	Header of TBL file is not 'O9110'.
	W	Input hex file is not in XXXX,0DH format.

Remedy:

Check for incorrect data transfer format.

Error Code	Details	Causes
37		NC ALARM (C007=1).

Remedy:

Check external control device, remove error and RESET.

Error Code	Details	Causes
38		Excessive screen display time (>3000ms).

Remedy:

1. Re-transfer screen data file.
2. Consult dealer or manufacturer.

Error Code	Details	Causes
41		In Tool Offset mode, the command paths between 2 single blocks are 2 parallel lines.
42		OVER CUT
43		Insufficient distance between Start and End (<0.005).
45		C251=0, Between the single block that the radius of circular arc compensation < 0
46		In Tool Offset mode, the system fails to determine the center-of-arc when executing an arc command.
48		Radius of tool offset < 0.
49		Direction of tool tip in the lathe is not of the 0~9 type Number of segment of axial displacement is greater than 10

Remedy:

1. Check for any error in tool offset value.
2. Check the program for any error.

Error Code	Details	Causes
50 . . . 99		Customer-defined error alarm using G65.

Remedy:

Check for any error in the setting of G65, customer-defined error message.

7 APPENDIX A

* Input Arrangement (For H4D-M-3)

Input	Description	Note
I00	EM-STOP	NC
I01	X-axis Home Limit	
I02	Y-axis Home Limit	
I03	Z-axis Home Limit	
I04	CYCST	
I05		
I06		
I07		
I08		
I09		
I10		
I11		
I12	MPG×10	I14 must be NO, then it will be work
I13	MPG×100	I14 must be NO, then it will be work
I14	Use MPG hand-wheel	
I15	X-axis of MPG	I14 must be NO, then it will be work
I16	Y-axis of MPG	I14 must be NO, then it will be work
I17	Z-axis of MPG	I14 must be NO, then it will be work
I18	X - LIMIT (+)	NC
I19	X - LIMIT (-)	NC
I20	Y - LIMIT (+)	NC
I21	Y - LIMIT (-)	NC
I22	Z - LIMIT (+)	NC
I23	Z - LIMIT (-)	NC

PARAMATER:

MPG TYPE = 0

I14~I17 will be Servo Ready signal

I14 X-SERVO READY (NC)

I15 Y-SERVO READY (NC)

I16 Z-SERVO READY (NC)

I17 SPINDLE SERVO READY (NC)

Parameter		
G00 AND Time	0000 ms	G00 AND TIME (Standard-0,Extern-1) 0
G01 AND Time	0000 ms	MPG TYPE(Standard-0,Extern-1) 0
G99 AND Time	0000 ms	MPG TYPE(Standard-0,Extern-1) 0
SERVO READY(0-NC1:NO)	0	G41 OFFSET TYPE: R:R ANGLE:0:RIGHT ANGLE:0
AXES LIMIT(0-NC1:NO)	0	Master/Slave mode 000
AXES Home(0-NC1:NO)	0	G41 AND G42 PROCESSING TYPE 0
R5232 Baud rate	0000000	MCM PASSWORD 0000000
PLUSE TYPE (0:P+D 1:P+N 2:AB)	0	AID TYPE 1:LINE 2: S 000
MPG DIRECTION	0	MPG AND TIME 000
Incremental limit value	000.000	Operational incremental limit value 000.000
BN_MCM	RD_MCM	All_MCM Screw pitch =>

MPG TYPE = 1 (HAND-WHEEL)
 I14~I17 will choose the axis signal.

*** Input Planning (For H4D-M-4)**

INPUT	Descriptions	Remarks
I00	EM-STOP	NC
I01	X-axis Home Limit	
I02	Y-axis Home Limit	
I03	Z-axis Home Limit	
I04	CYCST	NO
I05	Edit mode lock	NO
I06	A-axis Origin LIMIT	Displayed in compliance with 4 th axis setting
I07	A SERVO READY	Displayed in compliance with 4 th axis setting
I08		
I09		
I10		
I11		
I12		
I13		
I14	X SERVO READY	
I15	Y SERVO READY	
I16	Z SERVO READY	
I17	SPINDLE READY	
I18	X - LIMIT (+)	NC
I19	X - LIMIT (-)	NC
I20	Y - LIMIT (+)	NC
I21	Y - LIMIT (-)	NC
I22	Z - LIMIT (+)	NC
I23	Z - LIMIT (-)	NC

Parameter page settings:

1. Hand-wheel type =0, (as shown in the circle on the right) indicates fixed type hand wheel; I14~17 are for SERVO READY signal status.
2. I08~13 are left blank.

Parameter			
G00 A/D Time	0000 ms	PARAMETER: LING-EMERG (G00M-G00)	0
G01 A/D Time	0000 ms	MPG TYPE (Standard=0, Extern=1)	0
G99 A/D Time	0000 ms	FEED TYPE (Pulse/Rev=0, Servo=1)	0
SERVO READY (0-NC1-NO)	0	USE OFFSET TYPE: 0: R ANGLE 1; 1: RIGHT ANGLE	0
AXES LIMIT (0-NC1-NO)	0	Master/Slave mode	000
AXES Home (0-NC1-NO)	0	G41 AND G42 PROCESSING TYPE	0
RS232 Baud rate	0000000	MCM PASSWORD	00000000
PLUSE TYPE (0:P+D 1:P+N 2:AB)	0	A/D TYPE 1: LINE 2: S	000
MPG DIRECTION	0	MPG A/D TIME	000
Incremental limit value	000.000	Operational incremental limit value	000.000

*** Output Arrangement**

Output	Description	Note
O00	Spindle CW	
O01	Spindle CCW	
O02	Coolant	
O03		
O04		
O05	Lubrication	
O06		
O07		
O08		
O09		
O10		
O11		
O12		
O13	Servo-on	
O14	Servo-on	
O15	Servo-on	

*** M-code Versus I/O**

M code	Description	I/O	Note
M03	Spindle CW	003=1	
M04	Spindle CCW	004=1	
M05	Spindle stop	003=0,004=0	
M08	Coolant On	002=1	
M09	Coolant Off	002=0	
M10	Chuck On	005=1	
M11	Chuck Off	005=0	

*** Others**

In PLC arrangement, the taken parts are the followings:

1. Variables: 1-1000.
2. Temporal Memory Saving Machine 20 or 90 after.
3. A_Bit 0~400, don't use it during the arrangement.

8 Appendix B – PC On-line Operation

8.1 Using USB Device in H4D-M

1. Enter JOG key

WORK-POS G54 PGM NO 000			
PROGRAM-POS	FL-ERR.	MACHINE-POS	RELATIVE-POS
X: -0000.000	-0000	-0000.000	-0000.000
Y: -0000.000	-0000	-0000.000	-0000.000
Z: -0000.000	-0000	-0000.000	-0000.000
A: -0000.000	-0000	-0000.000	-0000.000
SP: -000.00			
G00 MFO 000 %	M:00000	MPG X: 000	
G01 MFO 000 %	T:00000	SP-RPM: 0000000	
SSO MFO 000 %	S:00000	F:0000000	Fc:0000000
TIME: 0000000 S			
JOG — HOLD			
WORKPOS	DRILL	Relative-Pos	USB-H

Fig 8-1

2. After pressing the function key USB-H for reading the data in the flash drive, the file transmission operation screen is displayed.

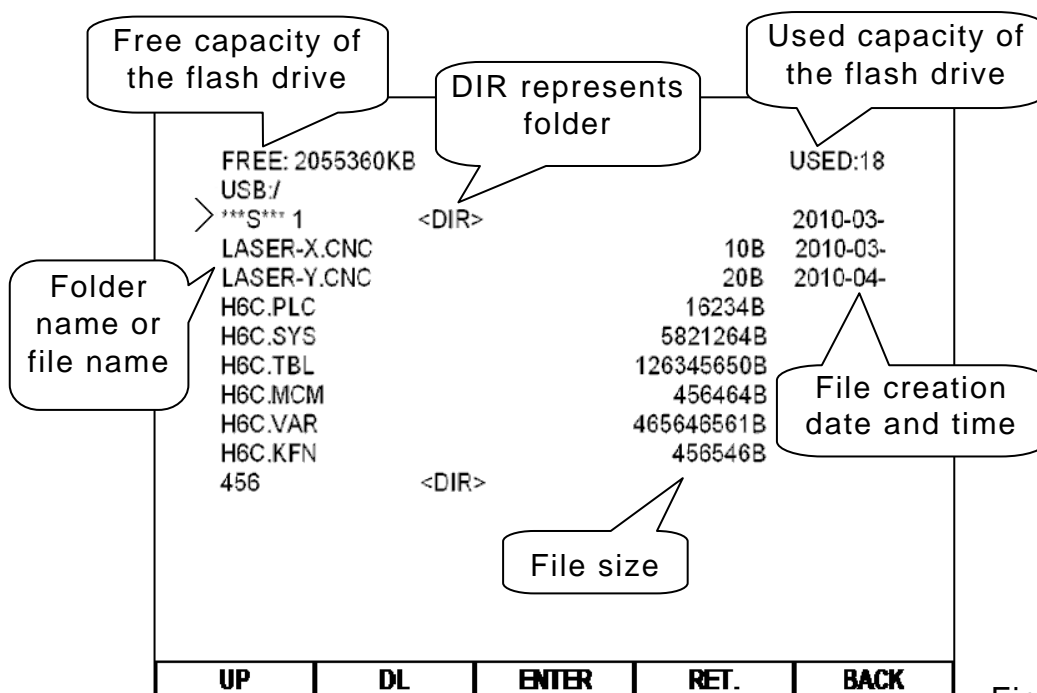

Fig 8-2

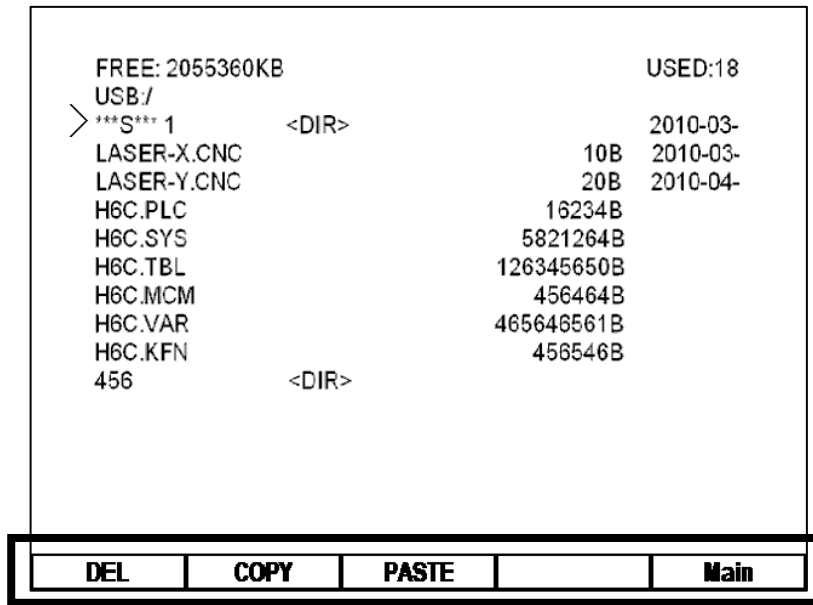

Fig 8-3

CURSOR RIGHT KET

Function Keys:

UP : <Upload> Transfer the data in the controller into the flash drive.

DL : <Download> Transfer the data in the flash drive into the controller.

Enter : Open a folder.

Return : Exit the USB operation mode and go back to the transmission mode.

Back : <Back to Upper Lever> Go back to the upper level.

3. Upload (Save) Screen

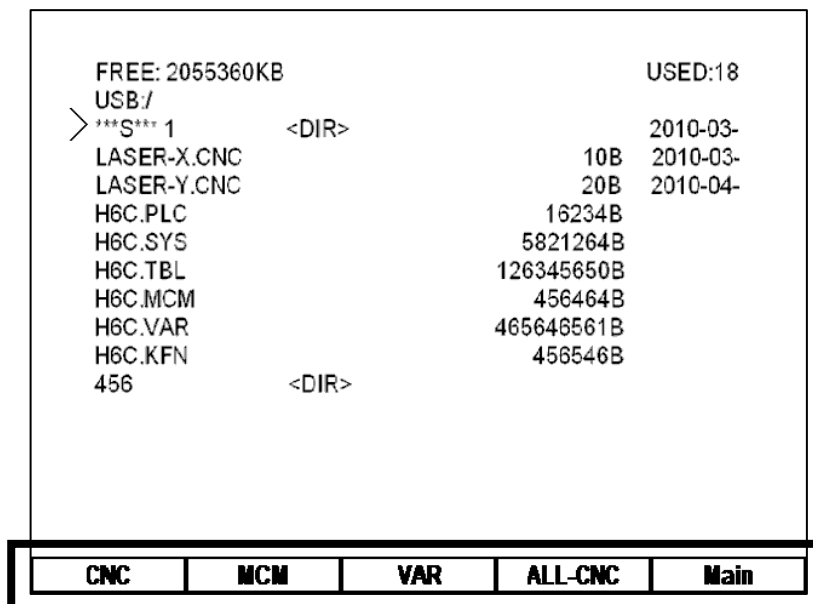

Fig 8-4

- “Save machining program” → Save the currently selected program from the controller into the USB device.
- “Save parameters” → Save the parameters from the controller into the USB device.
- “Save variables” → Save the variables from the controller into the USB device.
- “Save all program” → Save the all program from the controller into the USB device.
- “Read machining program” → Read the machining program from the USB device into the controller.
- “Read parameters” → Read the machining program from the USB device into the controller.
- “Transfer and execute” → Read the machining program from the USB device into the controller and execute the program simultaneously.
- “Read all programs” → Read all the machining programs from the USB device into the controller.
- “Read the parameters” → Read the parameters from the USB device into the controller.
- “Read PLC” → Read the PLC files from the USB device into the controller.
- “Read screen layout” → Read the screen layout file from the USB device into the controller.
- “Read system” → Read the system file from the USB device into the controller.
- “Read variables” → Read the variable files from the USB device into the controller.

To read the data, please move the cursor to the file to be read and then press the corresponding key.

To save the data, please enter the filename first and then press the corresponding key to save the data with the entered filename.

8.2 ZDNC Operation

When executed the DNC function from PC that move the cursor to the files then press the DNC key to run this program.

1. Getting Started

Click  on the desktop to execute zDNC
zDNC

2. Open the Option Setting Screen

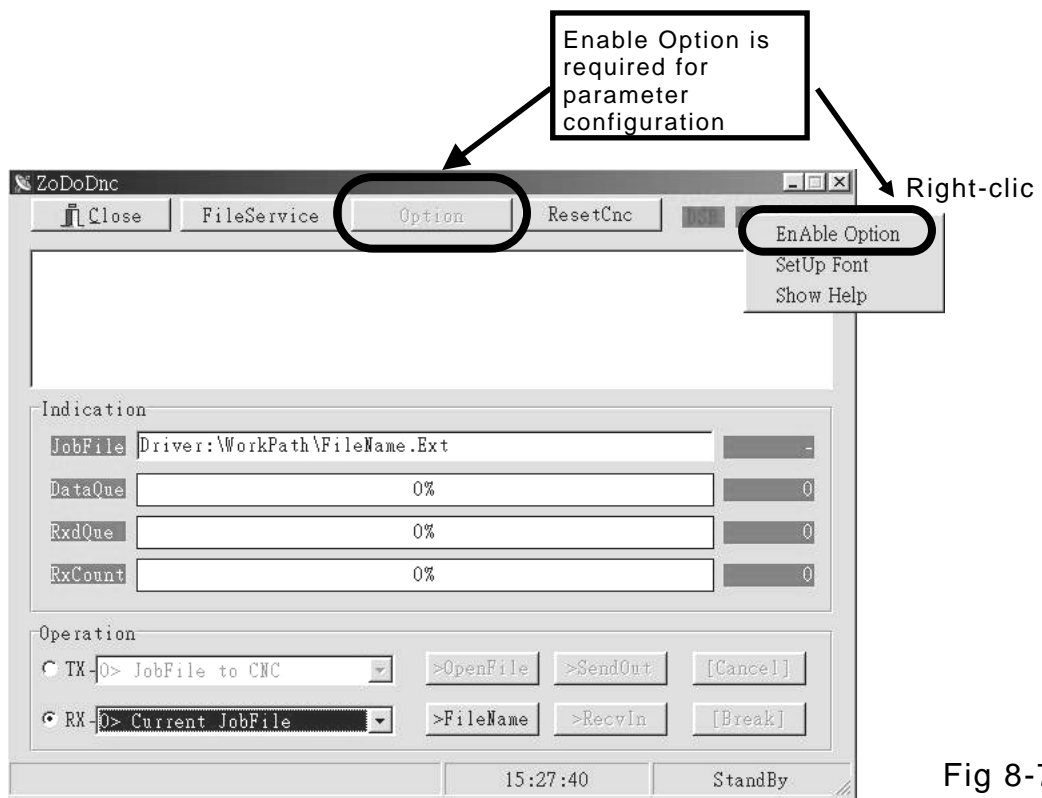

Fig 8-7

3. Display Settings

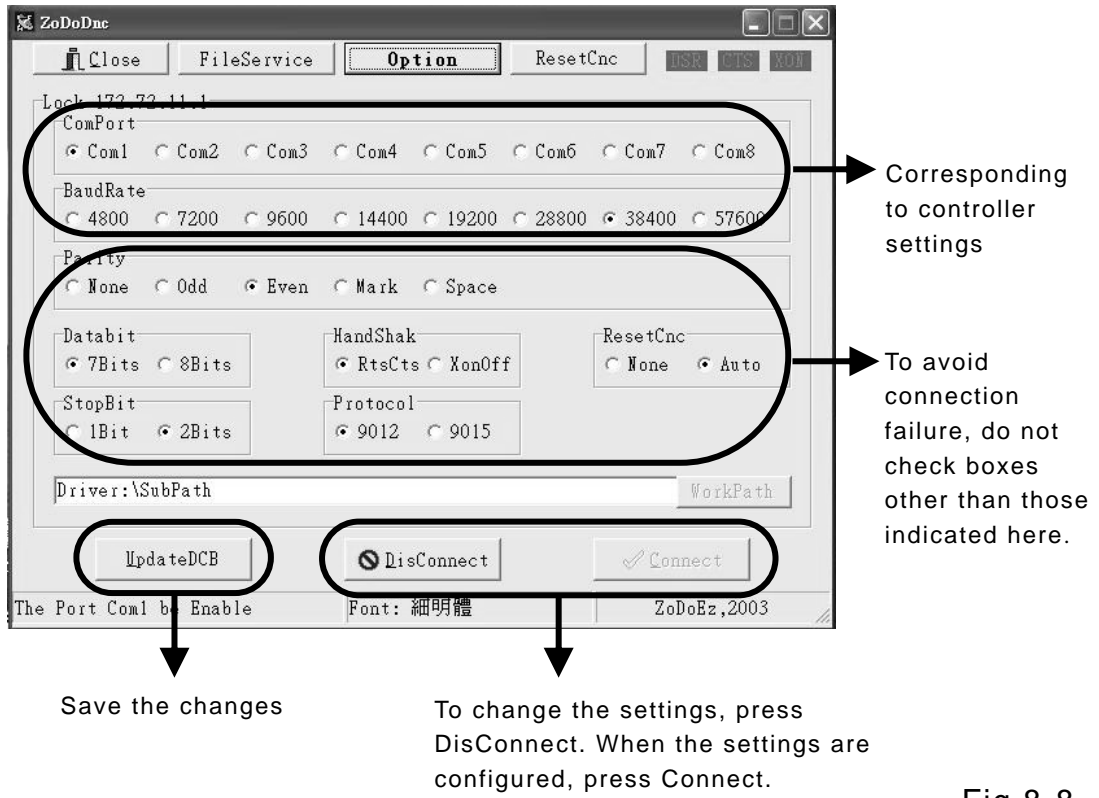
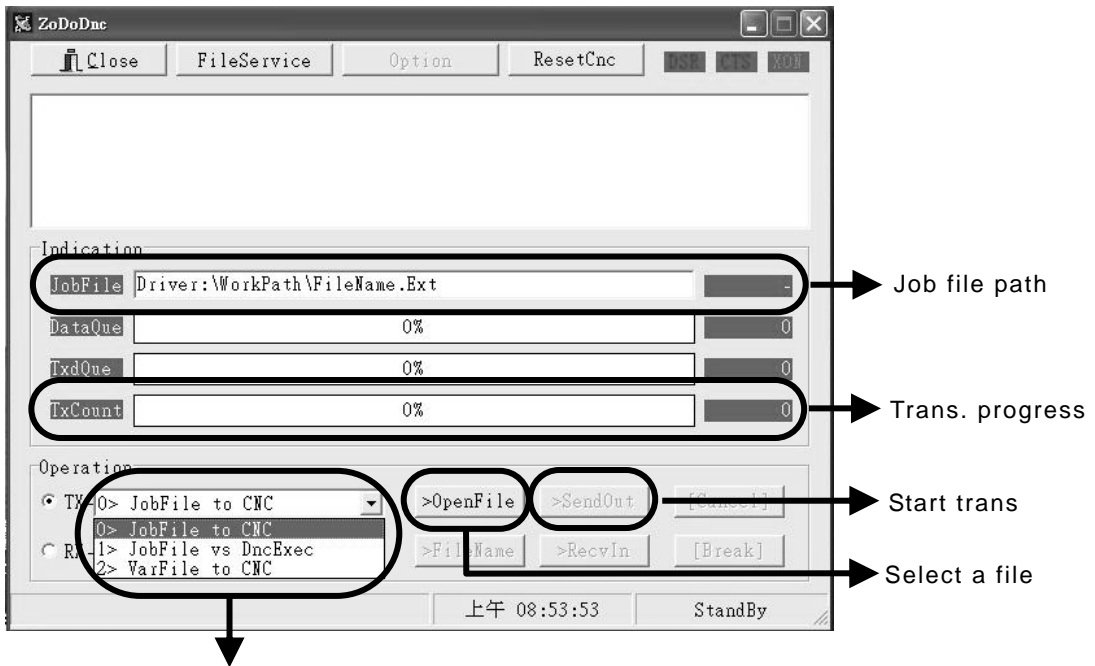

Fig 8-8

4. PC TO CNC



- 0: Transmit the part program to CNC
- 1: Transmit the part program to CNC and execute simultaneously (PLC required)
- 2: Transmit variables to CNC

Fig 8-9

5. CNC TO PC

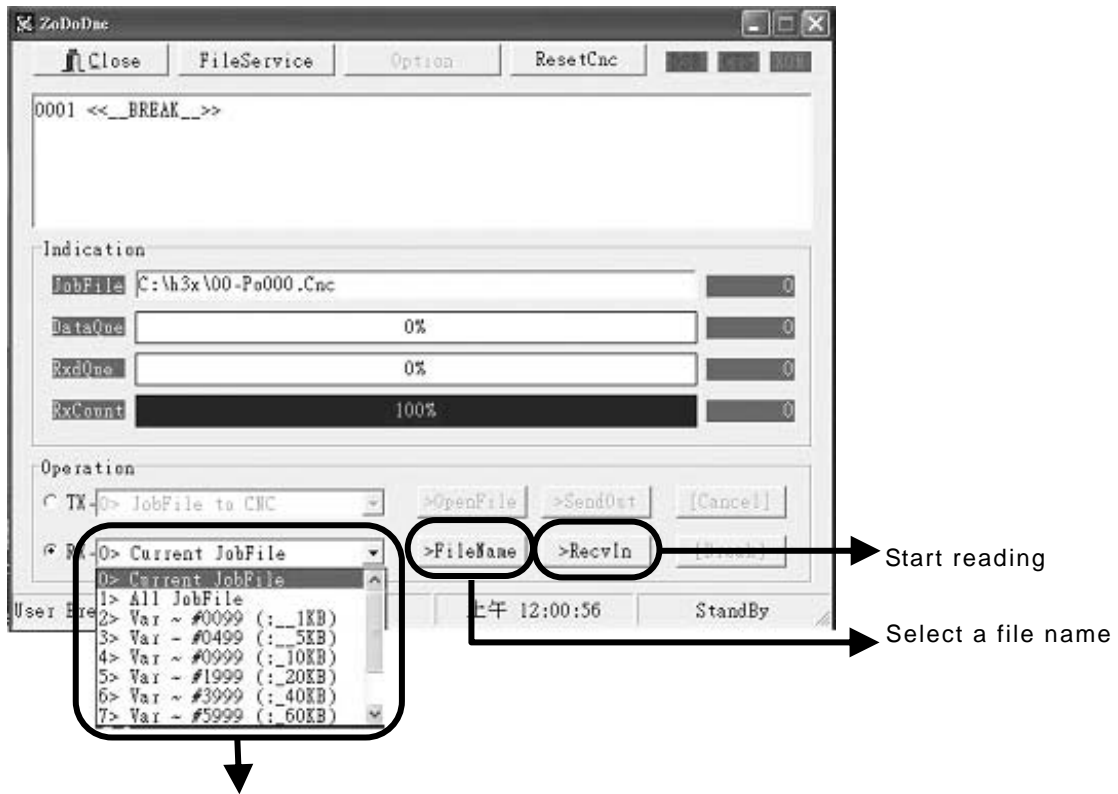

- 0>transmit the current file
- 1>transmit all part programs
- 2-9&M>transmit variables

Fig 8-10

6. Attention

- ※ DNC function is required to transmit huge part programs.
- ※ PLC should not restrict the availability of R100, R239, C04 when DNC is required, because the system needs to change the value of these three items to enter DNC mode.
- ※ For DNC operation, settings are only required at the ZDNC (computer) end rather than the controller end, if PLC does not give any restrictions.

9 APPENDIX C - Master Axis Settings and G84 Mode

H4D-M Spindle Type =1 Close Loop Control , G84 Threading mode is G94 (mm/min), where Z-axis and C-axis activate simultaneously.

SPINDLE	
SPINDLE TYPE(0_OPEN/1_CLOSE)	1
SP Command (pulse)	000000
SP Encoder (pulse)	000000
Acceleration Time for SP	0000 ms
Deceleration Time for SP	0000 ms
Max. SP RPM to 10V	00000
SP 0V correction	-0000
SP RPM +10V Slope	-00000
SP RPM -10V Slope	-00000
SP Gear Ratio Num.	000
G84	
G84 TYPE	0
Tool Return Distance	-0000.000
SPINDLE READY(0_NC/1_NO)	0
SP Run Dir.	0
SP Home Dir.	0
SP Home Speed	0000000
SP Stop Position Angle	-000.00
SP Encoder Dir.	0
SP Home Shift	-000.00
SP Stop to stable time	00000 ms
SP Search Grid Distane	0000000
SP Gear Ratio Den.	000
BN_MCM	RD_MCM
All_MCM	Screw pitch
	<=

Fig 9-1 Voltage Command Spindle

When Spindle set as the closed loop control , as well as the rotation axis, is set (see framed selection in the above figure), Master Positioning and Master Origin function optional items will be displayed in the manual and auto screens as shown below:

WORK-POS G54 PGM NO 000			
PROGRAM-POS	FL-ERR.	MACHINE-POS	RELATIVE-POS
X: -0000.000	-0000	-0000.000	-0000.000
Y: -0000.000	-0000	-0000.000	-0000.000
Z: -0000.000	-0000	-0000.000	-0000.000
A: -0000.000	-0000	-0000.000	-0000.000
SP: -000.00			
G00 MFO 000 %	M:00000	MPG X: 000	
G01 MFO 000 %	T:00000	SP-RPM: 0000000	
SSO MFO 000 %	S:00000	F:0000000 Fc:0000000	
TIME: 0000000 S			
HOME —READY			
		SP-HOME	Relative-Pos
			Z>XYA

Fig 9-2 Home Mode

Master axis origin: In Origin Mode, pressing Master Origin key will activate “Return to Grid” by retrieving Grid direction and Grid speed from Page 4 of Parameter Settings (as shown below).

Master axis positioning:

When power on and after Home operation:

1. Execution the spindle rotating any mode
2. Spindle will stop to the setting angle every time.

SPINDLE			
SPINDLE TYPE(0_OPEN/1_CLOSE)	0	SPINDLE READY(0_NC/1_NO)	0
SP Command (pulse)	000000	SP Run Dir.	0
SP Encoder (pulse)	000000	SP Home Dir.	0
Acceleration Time for SP	0000 ms	SP Home Speed	0000000
Deceleration Time for SP	0000 ms	SP Stop Position Angle	-000.00
Max. SP RPM to 10V	00000	SP Encoder Dir.	0
SP 0V correction	-0000	SP Home Shift	-000.00
SP RPM +10V Slope	-00000	SP Stop to stable time	00000 ms
SP RPM -10V Slope	-00000	SP Search Grid Distane	0000000
SP Gear Ratio Num.	000	SP Gear Ratio Den.	000
G84			
G84 TYPE	0	G84 A/D TIME	0000
Tool Return Distance	-0000.000	G84 A/D TIME ADJUSTMENT	-0000
BN_MCM	RD_MCM	AN_MCM	Screw pitch <=>

Fig 9-3

- ※ **Master Axis rotation Display:** this is a reference value and not for setting. Factory Default is 360.0.
- ※ **For a servo master axis, performing G84 threading activates Z-axis and C-axis simultaneously;** therefore resolution of C-axis needs to be set. For coping with the programming process, resolution of C-axis must be worked out with 36mm as the definition denominator.
 Example: Say feedback of master axis per revolution is 10000, then the C-axis resolution setting is:

$$\frac{\text{Resolution numerator}}{\text{Resolution denominator}} = \frac{36000}{10000}$$

Parameter	X	A	C
Resolution num den	0000000	0000000	36000
	0000000	0000000	10000
Encoder factor	0	0	0
Traverse speed	0000000	0000000	0000000
Rotate direction	0	0	0
Home direction	0	0	0
Home speed-1	0000000	0000000	0000000
Home speed-2	0000000	0000000	0000000
Software OT (+)	-0000.000	-0000.000	-0000.000
Software OT (-)	-0000.000	-0000.000	-0000.000
G01 Backlash Comp	-0000.000	-0000.000	-0000.000
G00 Backlash Comp	-0000.000	-0000.000	-0000.000
MPG Resolution num den	0000000	0000000	0000000
	0000000	0000000	0000000
HOME TYPE	0000000	0000000	0000000
Grid check Len.	-0000.000	-0000.000	-0000.000
HOME GRID RESERVED	-0000.000	-0000.000	-0000.000
BN_MCM	RD_MCM	All_MCM	Screw pitch <=

Fig 9-4

H4D-M Spindle type = 0 Open loop control. threading mode is G95 (mm/rev), feed per revolution mode.

SPINDLE	
SPINDLE TYPE(0_OPEN/1_CLOSE) 0	SPINDLE READY(0_NCH/1_NO) 0
SP Command (pulse) 000000	SP Run Dir. 0
SP Encoder (pulse) 000000	SP Home Dir. 0
Acceleration Time for SP 0000 ms	SP Home Speed 0000000
Deceleration Time for SP 0000 ms	SP Stop Position Angle -000.00
Max. SP RPM to 10V 00000	SP Encoder Dir. 0
SP 0V correction -0000	SP Home Shift -000.00
SP RPM +10V Slope -00000	SP Stop to stable time 00000 ms
SP RPM -10V Slope -00000	SP Search Grid Distane 0000000
SP Gear Ratio Num. 000	SP Gear Ratio Den. 000
G84	
G84 TYPE 0	G84 A/D TIME 0000
Tool Return Distance -0000.000	G84 A/D TIME ADJUSTMENT -0000
BN_MCM	RD_MCM All_MCM Screw pitch <=

Fig 9-5

