

AN7900T/AN7900F Series

3-pin Negative Output Voltage Regulators (1A Type)

Overview

The AN7900T/AN7900F series is 3-pin fixed negative output type monolithic voltage regulators. A stabilized fixed negative output voltage is obtained from an unstable DC input voltage without using any external parts. Eleven types of fixed output voltage are available from $-5V$ through $-10V$, $-12V$, $-15V$, $-18V$, $-20V$, and $-24V$. They can be used widely as power circuits with a current capacitance of up to 1A.

Features

- No external components
- Output voltage : $-5V$, $-6V$, $-7V$, $-8V$, $-9V$, $-10V$, $-12V$, $-15V$, $-18V$, $-20V$, $-24V$
- Overcurrent limit circuit built-in
- Thermal over-load protection built-in
- Area of safe operation (ASO) circuit built-in

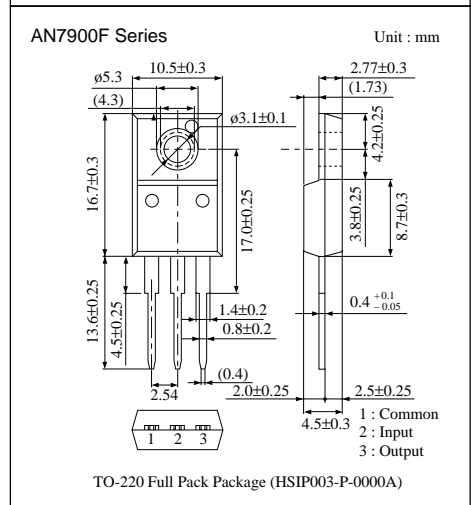
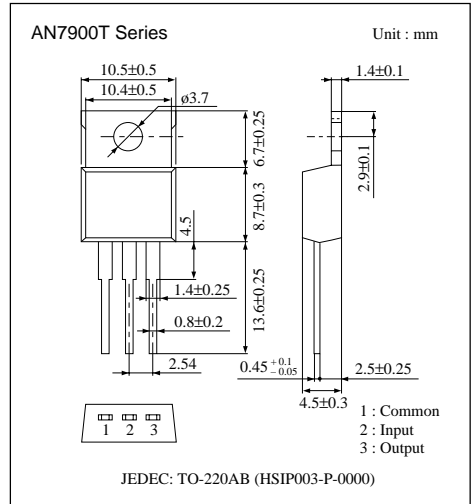

Block Diagram

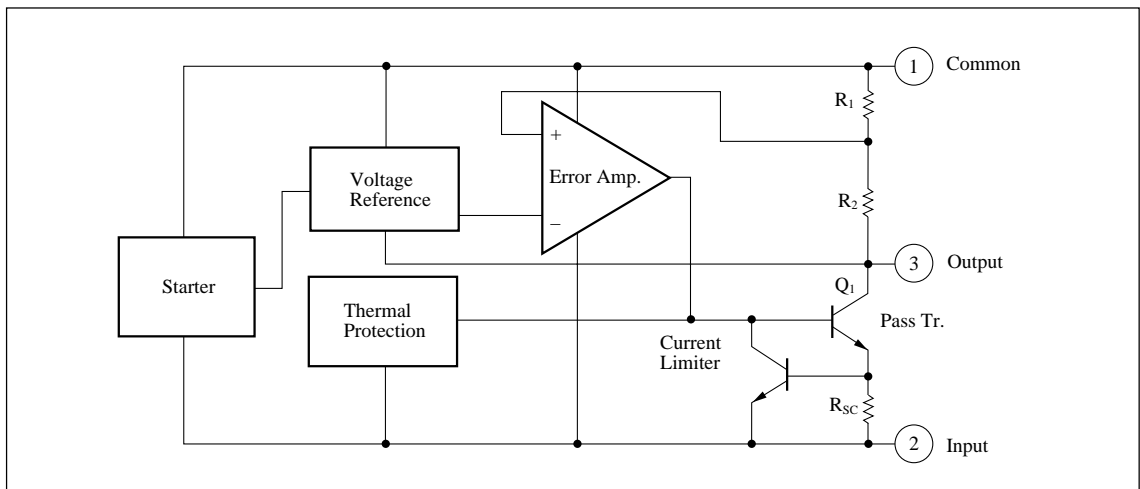

■ Absolute Maximum Ratings (Ta=25°C)

Parameter		Symbol	Rating	Unit
Input voltage		V _i	-35 *1	V
			-40 *2	V
Power dissipation	AN7900T Series	P _D	15 *3	W
	AN7900F Series		10.25 *3	
Operating ambient temperature		T _{opr}	-30 to +80	°C
Storage temperature		T _{stg}	-55 to +150	°C

*1 AN7905T/F, AN7906T/F, AN7907T/F, AN7908T/F, AN7909T/F, AN7910T/F, AN7912T/F, AN7915T/F, AN7918T/F

*2 AN7920T/F, AN7924T/F

*3 Follow the derating curve. When T_j exceeds 150°C, the internal circuit shuts off the output.

■ Electrical Characteristics (Ta=25°C)

• AN7905T/AN7905F (-5V Type)

Parameter	Symbol	Condition	min	typ	max	Unit
Output voltage	V _O	T _j =25°C	-4.8	-5	-5.2	V
Output voltage tolerance	V _O	V _i =-7 to -20V, I _O =5mA to 1A, P _D ≤*	-4.75	—	-5.25	V
Line regulation	REG _{IN}	V _i =-7 to -25V, T _j =25°C	—	3	100	mV
		V _i =-8 to -12V, T _j =25°C	—	1	50	mV
Load regulation	REG _L	I _O =5mA to 1.5A, T _j =25°C	—	10	100	mV
		I _O =250 to 750mA, T _j =25°C	—	3	50	mV
Bias current	I _{bias}	T _j =25°C	—	2	4	mA
Input bias fluctuation	ΔI _{bias (IN)}	V _i =-7 to -25V, T _j =25°C	—	—	1.3	mA
Load bias current fluctuation	ΔI _{bias (L)}	I _O =5mA to 1A, T _j =25°C	—	—	0.5	mA
Output noise voltage	V _{no}	f=10Hz to 100kHz, Ta=25°C	—	40	—	μV
Ripple rejection ratio	RR	V _i =-8 to -18V, I _O =100mA, f=120Hz	62	74	—	dB
Minimum i/o voltage difference	V _{DIF (min.)}	I _O =1A, T _j =25°C	—	1.1	—	V
Peak output current	I _{O (Peak)}	T _j =25°C	—	2.1	—	A
Output voltage temperature coefficient	ΔV _O /Ta	I _O =5mA, T _j =0 to 125°C	—	-0.4	—	mV/°C

Note 1) The specified condition T_j=25°C means that the test should be carried out with the test time so short (within 10ms) that the drift in characteristic value due to the rise in chip junction temperature can be ignored.

Note 2) Unless otherwise specified, V_i=-10V, I_O=500mA, C_i=2μF, C_O=1μF, T_j=0 to 125°C

* AN7900T series : 15W, AN7900F series : 10.25W

■ Electrical Characteristics (Ta=25°C) (continued)

• AN7906T/AN7906F (–6V Type)

Parameter	Symbol	Condition	min	typ	max	Unit
Output voltage	V _O	T _J =25°C	–5.75	–6	–6.25	V
Output voltage tolerance	V _O	V _I =–8 to –21V, I _O =5mA to 1A, P _D ≤*	–5.7	—	–6.3	V
Line regulation	REG _{IN}	V _I =–8 to –25V, T _J =25°C	—	4	120	mV
		V _I =–9 to –13V, T _J =25°C	—	1.5	60	mV
Load regulation	REG _L	I _O =5mA to 1.5A, T _J =25°C	—	10	120	mV
		I _O =250 to 750mA, T _J =25°C	—	3	60	mV
Bias current	I _{bias}	T _J =25°C	—	2	4	mA
Input bias fluctuation	ΔI _{bias (IN)}	V _I =–8 to –25V, T _J =25°C	—	—	1.3	mA
Load bias current fluctuation	ΔI _{bias (L)}	I _O =5mA to 1A, T _J =25°C	—	—	0.5	mA
Output noise voltage	V _{no}	f=10Hz to 100kHz, Ta=25°C	—	44	—	μV
Ripple rejection ratio	RR	V _I =–9 to –19V, I _O =100mA, f=120Hz	60	73	—	dB
Minimum i/o voltage difference	V _{DIF (min.)}	I _O =1A, T _J =25°C	—	1.1	—	V
Peak output current	I _{O (Peak)}	T _J =25°C	—	2.1	—	A
Output voltage temperature coefficient	ΔV _O /Ta	I _O =5mA, T _J =0 to 125°C	—	–0.5	—	mV/°C

Note 1) The specified condition T_J=25°C means that the test should be carried out with the test time so short (within 10ms) that the drift in characteristic value due to the rise in chip junction temperature can be ignored.

Note 2) Unless otherwise specified, V_I=–11V, I_O=500mA, C_I=2μF, C_O=1μF, T_J=0 to 125°C

* AN7900T series : 15W, AN7900F series : 10.25W

• AN7907T/AN7907F (–7V Type)

Parameter	Symbol	Condition	min	typ	max	Unit
Output voltage	V _O	T _J =25°C	–6.7	–7	–7.3	V
Output voltage tolerance	V _O	V _I =–79 to –22V, I _O =5mA to 1A, P _D ≤*	–6.65	—	–7.35	V
Line regulation	REG _{IN}	V _I =–9 to –25V, T _J =25°C	—	5	140	mV
		V _I =–10 to –14V, T _J =25°C	—	1.5	70	mV
Load regulation	REG _L	I _O =5mA to 1.5A, T _J =25°C	—	12	140	mV
		I _O =250 to 750mA, T _J =25°C	—	4	70	mV
Bias current	I _{bias}	T _J =25°C	—	2	4	mA
Input bias fluctuation	ΔI _{bias (IN)}	V _I =–9 to –25V, T _J =25°C	—	—	1.3	mA
Load bias current fluctuation	ΔI _{bias (L)}	I _O =5mA to 1A, T _J =25°C	—	—	0.5	mA
Output noise voltage	V _{no}	f=10Hz to 100kHz, Ta=25°C	—	48	—	μV
Ripple rejection ratio	RR	V _I =–10 to –20V, I _O =100mA, f=120Hz	58	72	—	dB
Minimum input/output voltage difference	V _{DIF (min.)}	I _O =1A, T _J =25°C	—	1.1	—	V
Peak output current	I _{O (Peak)}	T _J =25°C	—	2.1	—	A
Output voltage temperature coefficient	ΔV _O /Ta	I _O =5mA, T _J =0 to 125°C	—	–0.5	—	mV/°C

Note 1) The specified condition T_J=25°C means that the test should be carried out with the test time so short (within 10ms) that the drift in characteristic value due to the rise in chip junction temperature can be ignored.

Note 2) Unless otherwise specified, V_I=–12V, I_O=500mA, C_I=2μF, C_O=1μF, T_J=0 to 125°C

* AN7900T series : 15W, AN7900F series : 10.25W

■ Electrical Characteristics (Ta=25°C) (continued)

• AN7908T/AN7908F (–8V Type)

Parameter	Symbol	Condition	min	typ	max	Unit
Output voltage	V_O	$T_j=25^\circ\text{C}$	–7.7	–8	–8.3	V
Output voltage tolerance	V_O	$V_i=-10$ to -23V , $I_O=5\text{mA}$ to 1A , $P_D \leq *$	–7.6	—	–8.4	V
Line regulation	REG_{IN}	$V_i=-10.5$ to -25V , $T_j=25^\circ\text{C}$	—	6	160	mV
		$V_i=-11$ to -17V , $T_j=25^\circ\text{C}$	—	2	80	mV
Load regulation	REG_{L}	$I_O=5\text{mA}$ to 1.5A , $T_j=25^\circ\text{C}$	—	12	160	mV
		$I_O=250$ to 750mA , $T_j=25^\circ\text{C}$	—	4	80	mV
Bias current	I_{bias}	$T_j=25^\circ\text{C}$	—	2.2	4.5	mA
Input bias fluctuation	$\Delta I_{\text{bias (IN)}}$	$V_i=-10.5$ to -25V , $T_j=25^\circ\text{C}$	—	—	1	mA
Load bias current fluctuation	$\Delta I_{\text{bias (L)}}$	$I_O=5\text{mA}$ to 1A , $T_j=25^\circ\text{C}$	—	—	0.5	mA
Output noise voltage	V_{no}	$f=10\text{Hz}$ to 100kHz , $T_a=25^\circ\text{C}$	—	52	—	μV
Ripple rejection ratio	RR	$V_i=-11$ to -21V , $I_O=100\text{mA}$, $f=120\text{Hz}$	56	71	—	dB
Minimum input/output voltage difference	$V_{\text{DIF (min.)}}$	$I_O=1\text{A}$, $T_j=25^\circ\text{C}$	—	1.1	—	V
Peak output current	$I_{\text{O (Peak)}}$	$T_j=25^\circ\text{C}$	—	2.1	—	A
Output voltage temperature coefficient	$\Delta V_O/T_a$	$I_O=5\text{mA}$, $T_j=0$ to 125°C	—	–0.6	—	$\text{mV}/^\circ\text{C}$

Note 1) The specified condition $T_j=25^\circ\text{C}$ means that the test should be carried out with the test time so short (within 10ms) that the drift in characteristic value due to the rise in chip junction temperature can be ignored.

Note 2) Unless otherwise specified, $V_i=-14\text{V}$, $I_O=500\text{mA}$, $C_i=2\mu\text{F}$, $C_o=1\mu\text{F}$, $T_j=0$ to 125°C

* AN7900T series : 15W, AN7900F series : 10.25W

• AN7909T/AN7909F (–9V Type)

Parameter	Symbol	Condition	min	typ	max	Unit
Output voltage	V_O	$T_j=25^\circ\text{C}$	–8.65	–9	–9.35	V
Output voltage tolerance	V_O	$V_i=-11.5$ to -24V , $I_O=5\text{mA}$ to 1A , $P_D \leq *$	–8.55	—	–9.45	V
Line regulation	REG_{IN}	$V_i=-11.5$ to -26V , $T_j=25^\circ\text{C}$	—	7	180	mV
		$V_i=-12$ to -18V , $T_j=25^\circ\text{C}$	—	2	90	mV
Load regulation	REG_{L}	$I_O=5\text{mA}$ to 1.5A , $T_j=25^\circ\text{C}$	—	12	180	mV
		$I_O=250$ to 750mA , $T_j=25^\circ\text{C}$	—	4	90	mV
Bias current	I_{bias}	$T_j=25^\circ\text{C}$	—	2.2	4.5	mA
Input bias fluctuation	$\Delta I_{\text{bias (IN)}}$	$V_i=-11.5$ to -26V , $T_j=25^\circ\text{C}$	—	—	1	mA
Load bias current fluctuation	$\Delta I_{\text{bias (L)}}$	$I_O=5\text{mA}$ to 1A , $T_j=25^\circ\text{C}$	—	—	0.5	mA
Output noise voltage	V_{no}	$f=10\text{Hz}$ to 100kHz , $T_a=25^\circ\text{C}$	—	58	—	μV
Ripple rejection ratio	RR	$V_i=-12$ to -22V , $I_O=100\text{mA}$, $f=120\text{Hz}$	56	71	—	dB
Minimum input/output voltage difference	$V_{\text{DIF (min.)}}$	$I_O=1\text{A}$, $T_j=25^\circ\text{C}$	—	1.1	—	V
Peak output current	$I_{\text{O (Peak)}}$	$T_j=25^\circ\text{C}$	—	2.1	—	A
Output voltage temperature coefficient	$\Delta V_O/T_a$	$I_O=5\text{mA}$, $T_j=0$ to 125°C	—	–0.6	—	$\text{mV}/^\circ\text{C}$

Note 1) The specified condition $T_j=25^\circ\text{C}$ means that the test should be carried out with the test time so short (within 10ms) that the drift in characteristic value due to the rise in chip junction temperature can be ignored.

Note 2) Unless otherwise specified, $V_i=-15\text{V}$, $I_O=500\text{mA}$, $C_i=2\mu\text{F}$, $C_o=1\mu\text{F}$, $T_j=0$ to 125°C

* AN7900T series : 15W, AN7900F series : 10.25W

■ Electrical Characteristics (Ta=25°C) (continued)

• AN7910T/AN7910F (–10V Type)

Parameter	Symbol	Condition	min	typ	max	Unit
Output voltage	V _O	T _J =25°C	–9.6	–10	–10.4	V
Output voltage tolerance	V _O	V _I =–12.5 to –25V, I _O =5mA to 1A, P _D ≤*	–9.5	—	–10.5	V
Line regulation	REG _{IN}	V _I =–12.5 to –27V, T _J =25°C	—	8	200	mV
		V _I =–13 to –19V, T _J =25°C	—	2.5	100	mV
Load regulation	REG _L	I _O =5mA to 1.5A, T _J =25°C	—	12	200	mV
		I _O =250 to 750mA, T _J =25°C	—	4	100	mV
Bias current	I _{bias}	T _J =25°C	—	2.5	5	mA
Input bias fluctuation	ΔI _{bias (IN)}	V _I =–12.5 to –27V, T _J =25°C	—	—	1	mA
Load bias current fluctuation	ΔI _{bias (L)}	I _O =5mA to 1A, T _J =25°C	—	—	0.5	mA
Output noise voltage	V _{no}	f=10Hz to 100kHz, Ta=25°C	—	64	—	μV
Ripple rejection ratio	RR	V _I =–13 to –23V, I _O =100mA, f=120Hz	56	71	—	dB
Minimum input/output voltage difference	V _{DIF (min.)}	I _O =1A, T _J =25°C	—	1.1	—	V
Peak output current	I _{O (Peak)}	T _J =25°C	—	2.1	—	A
Output voltage temperature coefficient	ΔV _O /Ta	I _O =5mA, T _J =0 to 125°C	—	–0.7	—	mV/°C

Note 1) The specified condition T_J=25°C means that the test should be carried out with the test time so short (within 10ms) that the drift in characteristic value due to the rise in chip junction temperature can be ignored.

Note 2) Unless otherwise specified, V_I=–16V, I_O=500mA, C_I=2μF, C_O=1μF, T_J=0 to 125°C

* AN7900T series : 15W, AN7900F series : 10.25W

• AN7912T/AN7912F (–12V Type)

Parameter	Symbol	Condition	min	typ	max	Unit
Output voltage	V _O	T _J =25°C	–11.5	–12	–12.5	V
Output voltage tolerance	V _O	V _I =–14.5 to –27V, I _O =5mA to 1A, P _D ≤*	–11.4	—	–12.6	V
Line regulation	REG _{IN}	V _I =–14.5 to –30V, T _J =25°C	—	10	240	mV
		V _I =–16 to –22V, T _J =25°C	—	3	120	mV
Load regulation	REG _L	I _O =5mA to 1.5A, T _J =25°C	—	12	240	mV
		I _O =250 to 750mA, T _J =25°C	—	4	120	mV
Bias current	I _{bias}	T _J =25°C	—	2.5	5	mA
Input bias fluctuation	ΔI _{bias (IN)}	V _I =–14.5 to –30V, T _J =25°C	—	—	1	mA
Load bias current fluctuation	ΔI _{bias (L)}	I _O =5mA to 1A, T _J =25°C	—	—	0.5	mA
Output noise voltage	V _{no}	f=10Hz to 100kHz, Ta=25°C	—	75	—	μV
Ripple rejection ratio	RR	V _I =–15 to –25V, I _O =100mA, f=120Hz	55	70	—	dB
Minimum input/output voltage difference	V _{DIF (min.)}	I _O =1A, T _J =25°C	—	1.1	—	V
Peak output current	I _{O (Peak)}	T _J =25°C	—	2.1	—	A
Output voltage temperature coefficient	ΔV _O /Ta	I _O =5mA, T _J =0 to 125°C	—	–0.8	—	mV/°C

Note 1) The specified condition T_J=25°C means that the test should be carried out with the test time so short (within 10ms) that the drift in characteristic value due to the rise in chip junction temperature can be ignored.

Note 2) Unless otherwise specified, V_I=–19V, I_O=500mA, C_I=2μF, C_O=1μF, T_J=0 to 125°C

* AN7900T series : 15W, AN7900F series : 10.25W

■ Electrical Characteristics (Ta=25°C) (continued)

• AN7915T/AN7915F (–15V Type)

Parameter	Symbol	Condition	min	typ	max	Unit
Output voltage	V_O	$T_j=25^\circ\text{C}$	–14.4	–15	–15.6	V
Output voltage tolerance	V_O	$V_I=-17.5$ to -30V , $I_O=5\text{mA}$ to 1A , $P_D \leq *$	–14.25	—	–15.75	V
Line regulation	REG_{IN}	$V_I=-17.5$ to -30V , $T_j=25^\circ\text{C}$	—	11	300	mV
		$V_I=-20$ to -26V , $T_j=25^\circ\text{C}$	—	3	150	mV
Load regulation	REG_{L}	$I_O=5\text{mA}$ to 1.5A , $T_j=25^\circ\text{C}$	—	12	300	mV
		$I_O=250$ to 750mA , $T_j=25^\circ\text{C}$	—	4	150	mV
Bias current	I_{bias}	$T_j=25^\circ\text{C}$	—	2.5	5	mA
Input bias fluctuation	$\Delta I_{\text{bias (IN)}}$	$V_I=-17.5$ to -30V , $T_j=25^\circ\text{C}$	—	—	1	mA
Load bias current fluctuation	$\Delta I_{\text{bias (L)}}$	$I_O=5\text{mA}$ to 1A , $T_j=25^\circ\text{C}$	—	—	0.5	mA
Output noise voltage	V_{no}	$f=10\text{Hz}$ to 100kHz , $T_a=25^\circ\text{C}$	—	90	—	μV
Ripple rejection ratio	RR	$V_I=-18.5$ to -28.5V , $I_O=100\text{mA}$, $f=120\text{Hz}$	54	69	—	dB
Minimum input/output voltage difference	$V_{\text{DIF (min.)}}$	$I_O=1\text{A}$, $T_j=25^\circ\text{C}$	—	1.1	—	V
Peak output current	$I_{\text{O (Peak)}}$	$T_j=25^\circ\text{C}$	—	2.1	—	A
Output voltage temperature coefficient	$\Delta V_O/T_a$	$I_O=5\text{mA}$, $T_j=0$ to 125°C	—	–0.9	—	$\text{mV}/^\circ\text{C}$

Note 1) The specified condition $T_j=25^\circ\text{C}$ means that the test should be carried out with the test time so short (within 10ms) that the drift in characteristic value due to the rise in chip junction temperature can be ignored.

Note 2) Unless otherwise specified, $V_I=-23\text{V}$, $I_O=500\text{mA}$, $C_I=2\mu\text{F}$, $C_O=1\mu\text{F}$, $T_j=0$ to 125°C

* AN7900T series : 15W, AN7900F series : 10.25W

• AN7918T/AN7918F (–18V Type)

Parameter	Symbol	Condition	min	typ	max	Unit
Output voltage	V_O	$T_j=25^\circ\text{C}$	–17.3	–18	–18.7	V
Output voltage tolerance	V_O	$V_I=-21$ to -33V , $I_O=5\text{mA}$ to 1A , $P_D \leq *$	–17.1	—	–18.9	V
Line regulation	REG_{IN}	$V_I=-21$ to -33V , $T_j=25^\circ\text{C}$	—	15	360	mV
		$V_I=-24$ to -30V , $T_j=25^\circ\text{C}$	—	5	180	mV
Load regulation	REG_{L}	$I_O=5\text{mA}$ to 1.5A , $T_j=25^\circ\text{C}$	—	12	360	mV
		$I_O=250$ to 750mA , $T_j=25^\circ\text{C}$	—	4	180	mV
Bias current	I_{bias}	$T_j=25^\circ\text{C}$	—	2.5	5	mA
Input bias fluctuation	$\Delta I_{\text{bias (IN)}}$	$V_I=-21$ to -33V , $T_j=25^\circ\text{C}$	—	—	1	mA
Load bias current fluctuation	$\Delta I_{\text{bias (L)}}$	$I_O=5\text{mA}$ to 1A , $T_j=25^\circ\text{C}$	—	—	0.5	mA
Output noise voltage	V_{no}	$f=10\text{Hz}$ to 100kHz , $T_a=25^\circ\text{C}$	—	110	—	μV
Ripple rejection ratio	RR	$V_I=-22$ to -32V , $I_O=100\text{mA}$, $f=120\text{Hz}$	53	68	—	dB
Minimum input/output voltage difference	$V_{\text{DIF (min.)}}$	$I_O=1\text{A}$, $T_j=25^\circ\text{C}$	—	1.1	—	V
Peak output current	$I_{\text{O (Peak)}}$	$T_j=25^\circ\text{C}$	—	2.1	—	A
Output voltage temperature coefficient	$\Delta V_O/T_a$	$I_O=5\text{mA}$, $T_j=0$ to 125°C	—	–1	—	$\text{mV}/^\circ\text{C}$

Note 1) The specified condition $T_j=25^\circ\text{C}$ means that the test should be carried out with the test time so short (within 10ms) that the drift in characteristic value due to the rise in chip junction temperature can be ignored.

Note 2) Unless otherwise specified, $V_I=-27\text{V}$, $I_O=500\text{mA}$, $C_I=2\mu\text{F}$, $C_O=1\mu\text{F}$, $T_j=0$ to 125°C

* AN7900T series : 15W, AN7900F series : 10.25W

■ Electrical Characteristics (Ta=25°C) (continued)

• AN7920T/AN7920F (–20V Type)

Parameter	Symbol	Condition	min	typ	max	Unit
Output voltage	V _O	T _J =25°C	–19.2	–20	–20.8	V
Output voltage tolerance	V _O	V _I =–23 to –35V, I _O =5mA to 1A, P _D ≤*	–19	—	–21	V
Line regulation	REG _{IN}	V _I =–23 to –35V, T _J =25°C	—	16	400	mV
		V _I =–26 to –32V, T _J =25°C	—	5.5	200	mV
Load regulation	REG _L	I _O =5mA to 1.5A, T _J =25°C	—	12	400	mV
		I _O =250 to 750mA, T _J =25°C	—	4	200	mV
Bias current	I _{bias}	T _J =25°C	—	3	5	mA
Input bias fluctuation	ΔI _{bias (IN)}	V _I =–23 to –35V, T _J =25°C	—	—	1	mA
Load bias current fluctuation	ΔI _{bias (L)}	I _O =5mA to 1A, T _J =25°C	—	—	0.5	mA
Output noise voltage	V _{no}	f=10Hz to 100kHz, Ta=25°C	—	135	—	μV
Ripple rejection ratio	RR	V _I =–24 to –34V, I _O =100mA, f=120Hz	52	67	—	dB
Minimum input/output voltage difference	V _{DIF (min.)}	I _O =1A, T _J =25°C	—	1.1	—	V
Peak output current	I _{O (Peak)}	T _J =25°C	—	2.1	—	A
Output voltage temperature coefficient	ΔV _O /Ta	I _O =5mA, T _J =0 to 125°C	—	–1	—	mV/°C

Note 1) The specified condition T_J=25°C means that the test should be carried out with the test time so short (within 10ms) that the drift in characteristic value due to the rise in chip junction temperature can be ignored.

Note 2) Unless otherwise specified, V_I=–29V, I_O=500mA, C_I=2μF, C_O=1μF, T_J=0 to 125°C

* AN7900T series : 15W, AN7900F series : 10.25W

• AN7924T/AN7924F (–24V Type)

Parameter	Symbol	Condition	min	typ	max	Unit
Output voltage	V _O	T _J =25°C	–23	–24	–25	V
Output voltage tolerance	V _O	V _I =–27 to –38V, I _O =5mA to 1A, P _D ≤*	–22.8	—	–25.2	V
Line regulation	REG _{IN}	V _I =–27 to –38V, T _J =25°C	—	18	480	mV
		V _I =–30 to –36V, T _J =25°C	—	6	240	mV
Load regulation	REG _L	I _O =5mA to 1.5A, T _J =25°C	—	12	480	mV
		I _O =250 to 750mA, T _J =25°C	—	4	240	mV
Bias current	I _{bias}	T _J =25°C	—	3	5	mA
Input bias fluctuation	ΔI _{bias (IN)}	V _I =–27 to –38V, T _J =25°C	—	—	1	mA
Load bias current fluctuation	ΔI _{bias (L)}	I _O =5mA to 1A, T _J =25°C	—	—	0.5	mA
Output noise voltage	V _{no}	f=10Hz to 100kHz, Ta=25°C	—	170	—	μV
Ripple rejection ratio	RR	V _I =–28 to –38V, I _O =100mA, f=120Hz	50	65	—	dB
Minimum input/output voltage difference	V _{DIF (min.)}	I _O =1A, T _J =25°C	—	1.1	—	V
Peak output current	I _{O (Peak)}	T _J =25°C	—	2.1	—	A
Output voltage temperature coefficient	ΔV _O /Ta	I _O =5mA, T _J =0 to 125°C	—	–1	—	mV/°C

Note 1) The specified condition T_J=25°C means that the test should be carried out with the test time so short (within 10ms) that the drift in characteristic value due to the rise in chip junction temperature can be ignored.

Note 2) Unless otherwise specified, V_I=–33V, I_O=500mA, C_I=2μF, C_O=1μF, T_J=0 to 125°C

* AN7900T series : 15W, AN7900F series : 10.25W

■ Characteristic Curve

P_D - T_a (AN7900T Series)

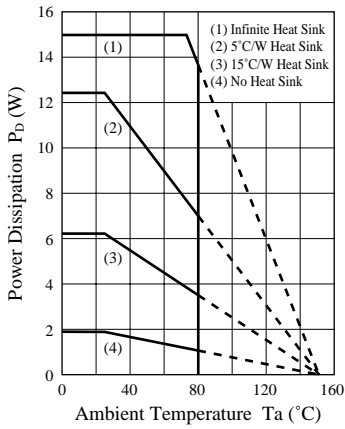

P_D - T_a (AN7900F Series)

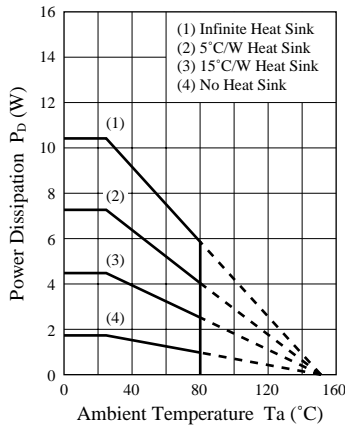

$V_{DIF}(\text{min.})-T_j$

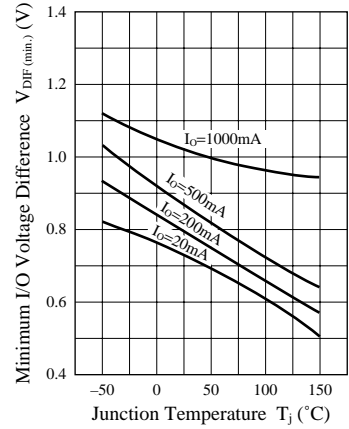

Input Transient Response

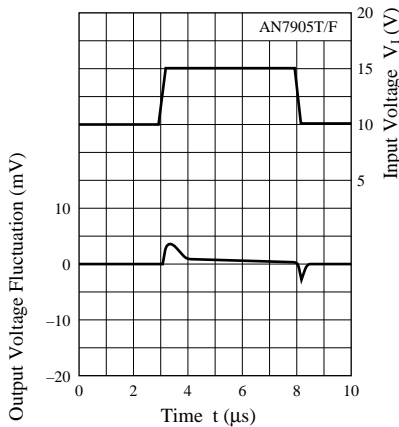

Load Transient Response

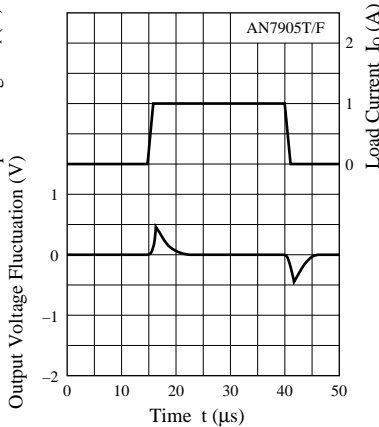

RR-f

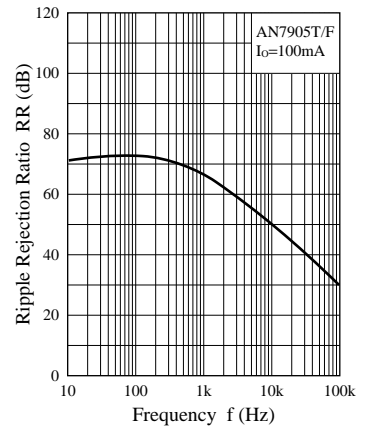

■ Basic Regulator Circuit

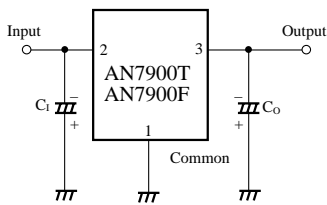

C_1 : Required when the input line is long
 C_0 : Improves the transient response.

■ Application Circuit

1) Current Bootstrap Circuit

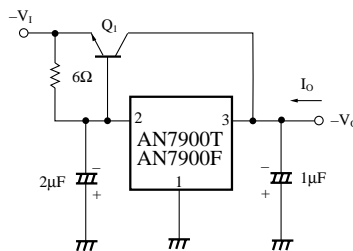

2) Adjustable Output Regulator

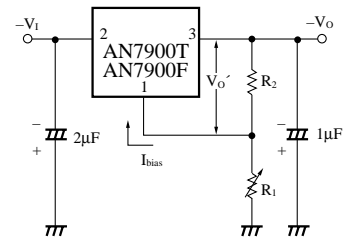

$$|V_O| = V_O' + \left(I_{\text{bias}} + \frac{V_O'}{R_2} \right) R_1$$