



Inverter

RX Series  
LX Series  
MX2 Series

# LCD Digital Operator

User's Manual

3G3AX-OP05



I579-E2-01

© **OMRON, 2013**

All rights reserved. No part of this publication may be reproduced, stored in a retrieval system, or transmitted, in any form, or by any means, mechanical, electronic, photocopying, recording, or otherwise, without the prior written permission of OMRON.

No patent liability is assumed with respect to the use of the information contained herein. Moreover, because OMRON is constantly striving to improve its high-quality products, the information contained in this manual is subject to change without notice. Every precaution has been taken in the preparation of this manual. Nevertheless, OMRON assumes no responsibility for errors or omissions. Neither is any liability assumed for damages resulting from the use of the information contained in this publication.

# Introduction

---

Thank you for purchasing the LCD Digital Operator (Model: 3G3AX-OP05).

This manual explains how to set parameters required to use the LCD Digital Operator (Model: 3G3AX-OP05), operation procedures and the remedies needed if problems occur.

For the use of the LCD Digital Operator 3G3AX-OP05, please refer also to RX (I560-E2), LX (I120E-EN) or MX2 (I570-E2) User's Manuals.

## Intended Readers

This manual is intended for the following individuals.

Those who have electrical knowledge (certified electricians or individuals who have equivalent knowledge) and also are qualified for one of the following:

- Introducing control equipment
- Designing control systems
- Installing and connecting control systems
- Managing control systems and facilities

## Notice

This manual contains information you need to know in order to correctly use the LCD Digital Operator 3G3AX-OP05.

Before using the LCD Digital Operator (Model: 3G3AX-OP05), read this manual and gain a full understanding of the information provided herein.

After you finished reading this manual, keep it in a convenient place so that it can be referenced at any time.

Make sure this manual is delivered to the end user.

# Manual Configuration

---

This manual is compiled section by section for user's convenience as follows.

		Overview
Section 1	Overview	This section provides features and specifications of the LCD Digital Operator.
Section 2	Part Names and Functions	This section describes the part names and functions of the LCD Digital Operator.
Section 3	Installation and Wiring	This section provides information on the installation and wiring of the LCD Digital Operator.
Section 4	Operation Procedures	This section provides an overview of the display modes supported by LCD Digital Operator and how to operate the LCD Digital Operator in each display mode.
Section 5	LCD Digital Operator Related Parameters	This section describes the Inverter parameters related to the LCD Digital Operator.
Section 6	Read/Write Functions	This section describes how to read and write Inverter parameter settings using the LCD Digital Operator.
Section 7	Error Messages and Troubleshooting	This section describes the error messages and troubleshooting of the LCD Digital Operator.
Section 8	Maintenance	This section provides information on the maintenance of the LCD Digital Operator.

# Manual Structure

## Page Structure and Symbol Icons

The following page structure and symbol icons are used in this manual.

Level 1 heading

Level 2 heading

Level 3 heading

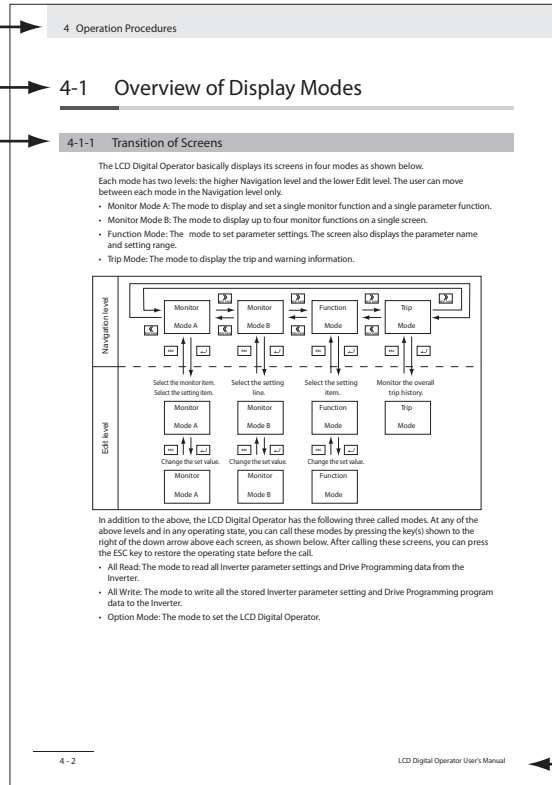

Manual Name

Operation Steps

Describes the operation steps.

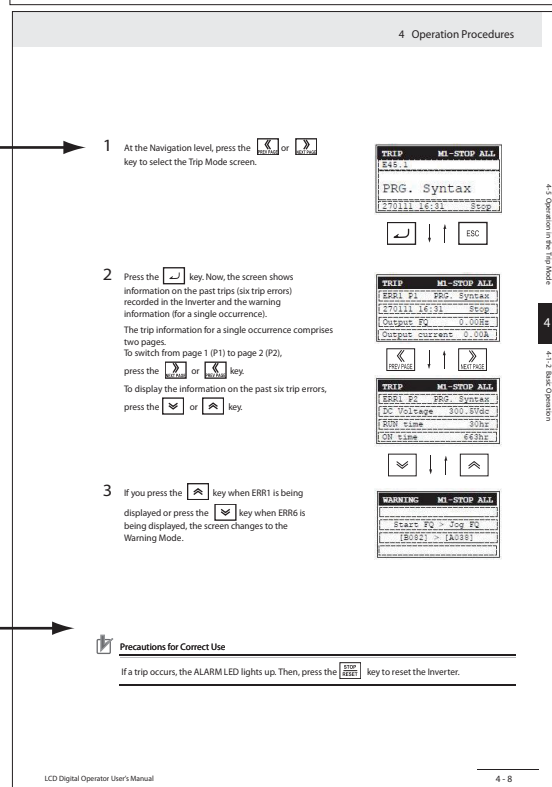

Note, Supplementary Information, Reference Target

A note, supplementary information, reference target, etc. are provided with difference icons.



**Note** The above page is only a sample for illustrative purposes. It is not the actual content of the manual.

Level 2 heading Shows which sub-section the content of the current page belongs to.

Section Number of Level 1 heading Shows which section the content of the current page belongs to.

Level 3 heading Shows which paragraph the content of the current page belongs to.

## Special Information

Special information in this manual is classified as follows:



---

### **Precautions for Safe Use**

---

Precautions on what to do and what not to do to ensure safe usage of the product.



---

### **Precautions for Correct Use**

---

Precautions on what to do and what not to do to ensure proper operation and performance.



---

### **Additional Information**

---

Additional information to read as required.

This information is provided to increase understanding or make operation easier.

# Sections in this Manual

---

<b>1</b>	<b>Overview</b>	<b>1</b>
<b>2</b>	<b>Part Names and Functions</b>	<b>2</b>
<b>3</b>	<b>Installation and Wiring</b>	<b>3</b>
<b>4</b>	<b>Operation Procedures</b>	<b>4</b>
<b>5</b>	<b>LCD Digital Operator Related Parameters</b>	<b>5</b>
<b>6</b>	<b>Read/Write Functions</b>	<b>6</b>
<b>7</b>	<b>Error Messages and Troubleshooting</b>	<b>7</b>
<b>8</b>	<b>Maintenance</b>	<b>8</b>
<b>I</b>	<b>Index</b>	<b>I</b>

# CONTENTS

---

Introduction .....	1
Manual Configuration .....	2
Manual Structure .....	3
Sections in this Manual .....	5
CONTENTS.....	6
Read and Understand this Manual .....	8
Safety Precautions .....	11
Precautions for Safe Use.....	13
Precautions for Correct Use.....	15
Regulations and Standards .....	16
Items to Check after Unpacking.....	17
Related Manuals .....	18
Revision History .....	19

## Section 1 Overview

---

1-1 Features.....	1-2
1-2 Supported Models .....	1-4
1-3 Specifications .....	1-5
1-4 External Dimensions .....	1-6
1-5 Recommended Cables .....	1-7

## Section 2 Part Names and Functions

---

2-1 Part Names .....	2-2
2-2 Operation Keys .....	2-4
2-3 LCD Display .....	2-6

## Section 3 Installation and Wiring

---

3-1 Installation on the Inverter.....	3-2
3-1-1 Direct Installation on the Inverter .....	3-3
3-1-2 Installation on the Inverter via Cable.....	3-4
3-1-3 Checking the Operation After Installation.....	3-5
3-1-4 Date and Time Setting .....	3-6
3-1-5 Other Settings .....	3-6



## Section 4 Operation Procedures

---

<b>4-1 Overview of Display Modes .....</b>	<b>4-2</b>
4-1-1 Transition of Screens .....	4-2
4-1-2 Overview of Each Mode.....	4-3
4-1-3 Changing the Display in Each Mode.....	4-5
<b>4-2 Operation in the Monitor Mode A.....</b>	<b>4-6</b>
<b>4-3 Operation in the Monitor Mode B.....</b>	<b>4-7</b>
<b>4-4 Operation in the Function Mode .....</b>	<b>4-8</b>
<b>4-5 Operation in the Trip Mode .....</b>	<b>4-9</b>

## Section 5 LCD Digital Operator Related Parameters

---

<b>5-1 Parameter Setting.....</b>	<b>5-2</b>
5-1-1 Operation in the Option Mode.....	5-2
5-1-2 Details of Each Option Mode Parameter .....	5-4
<b>5-2 Related Inverter Parameters .....</b>	<b>5-6</b>

## Section 6 Read/Write Functions

---

<b>6-1 Single READ Function .....</b>	<b>6-2</b>
<b>6-2 Single WRITE Function .....</b>	<b>6-3</b>
<b>6-3 Quad READ Function .....</b>	<b>6-4</b>
<b>6-4 Quad VERIFY Function .....</b>	<b>6-6</b>
<b>6-5 Quad WRITE Function.....</b>	<b>6-8</b>
<b>6-6 Conditions for the Read/Write Operations.....</b>	<b>6-10</b>

## Section 7 Error Messages and Troubleshooting

---

<b>7-1 Error Messages and Remedies .....</b>	<b>7-2</b>
7-1-1 Inverter Error Messages .....	7-2
7-1-2 LCD Digital Operator Error Messages .....	7-2
<b>7-2 Troubleshooting .....</b>	<b>7-5</b>

## Section 8 Maintenance

---

<b>8-1 Battery Replacement.....</b>	<b>8-2</b>
-------------------------------------	------------

## Index

---

# Read and Understand this Manual

---

## ***Warranty and Limitations of Liability***

<b><i>WARRANTY</i></b>
<p>OMRON's exclusive warranty is that the products are free from defects in materials and workmanship for a period of one year (or other period if specified) from date of sale by OMRON.</p> <p>OMRON MAKES NO WARRANTY OR REPRESENTATION, EXPRESS OR IMPLIED, REGARDING NONINFRINGEMENT, MERCHANTABILITY, OR FITNESS FOR PARTICULAR PURPOSE OF THE PRODUCTS. ANY BUYER OR USER ACKNOWLEDGES THAT THE BUYER OR USER ALONE HAS DETERMINED THAT THE PRODUCTS WILL SUITABLY MEET THE REQUIREMENTS OF THEIR INTENDED USE. OMRON DISCLAIMS ALL OTHER WARRANTIES, EXPRESS OR IMPLIED.</p>

<b><i>LIMITATIONS OF LIABILITY</i></b>
<p>OMRON SHALL NOT BE RESPONSIBLE FOR SPECIAL, INDIRECT, OR CONSEQUENTIAL DAMAGES, LOSS OF PROFITS OR COMMERCIAL LOSS IN ANY WAY CONNECTED WITH THE PRODUCTS, WHETHER SUCH CLAIM IS BASED ON CONTRACT, WARRANTY, NEGLIGENCE, OR STRICT LIABILITY.</p> <p>In no event shall the responsibility of OMRON for any act exceed the individual price of the product on which liability is asserted.</p> <p>IN NO EVENT SHALL OMRON BE RESPONSIBLE FOR WARRANTY, REPAIR, OR OTHER CLAIMS REGARDING THE PRODUCTS UNLESS OMRON'S ANALYSIS CONFIRMS THAT THE PRODUCTS WERE PROPERLY HANDLED, STORED, INSTALLED, AND MAINTAINED AND NOT SUBJECT TO CONTAMINATION, ABUSE, MISUSE, OR INAPPROPRIATE MODIFICATION OR REPAIR.</p>

## ***Application Considerations***

### ***SUITABILITY FOR USE***

OMRON shall not be responsible for conformity with any standards, codes, or regulations that apply to the combination of products in the customer's application or use of the products.

At the customer's request, OMRON will provide applicable third party certification documents identifying ratings and limitations of use that apply to the products. This information by itself is not sufficient for a complete determination of the suitability of the products in combination with the end product, machine, system, or other application or use.

The following are some examples of applications for which particular attention must be given. This is not intended to be an exhaustive list of all possible uses of the products, nor is it intended to imply that the uses listed may be suitable for the products:

- Outdoor use, uses involving potential chemical contamination or electrical interference, or conditions or uses not described in this manual.
- Nuclear energy control systems, combustion systems, railroad systems, aviation systems, medical equipment, amusement machines, vehicles, safety equipment, and installations subject to separate industry or government regulations.
- Systems, machines, and equipment that could present a risk to life or property. Please know and observe all prohibitions of use applicable to the products.

**NEVER USE THE PRODUCTS FOR AN APPLICATION INVOLVING SERIOUS RISK TO LIFE OR PROPERTY WITHOUT ENSURING THAT THE SYSTEM AS A WHOLE HAS BEEN DESIGNED TO ADDRESS THE RISKS, AND THAT THE OMRON PRODUCTS ARE PROPERLY RATED AND INSTALLED FOR THE INTENDED USE WITHIN THE OVERALL EQUIPMENT OR SYSTEM.**

### ***PROGRAMMABLE PRODUCTS***

OMRON shall not be responsible for the user's programming of a programmable product, or any consequence thereof.

## ***Disclaimers***

### ***CHANGE IN SPECIFICATIONS***

Product specifications and accessories may be changed at any time based on improvements and other reasons. It is our practice to change model numbers when published ratings or features are changed, or when significant construction changes are made. However, some specifications of the products may be changed without any notice. When in doubt, special model numbers may be assigned to fix or establish key specifications for your application on your request. Please consult with your OMRON representative at any time to confirm actual specifications of purchased products.

### ***DIMENSIONS AND WEIGHTS***

Dimensions and weights are nominal and are not to be used for manufacturing purposes, even when tolerances are shown.

### ***PERFORMANCE DATA***

Performance data given in this manual is provided as a guide for the user in determining suitability and does not constitute a warranty. It may represent the result of OMRON's test conditions, and the users must correlate it to actual application requirements. Actual performance is subject to the OMRON Warranty and Limitations of Liability.

### ***ERRORS AND OMISSIONS***

The information in this manual has been carefully checked and is believed to be accurate; however, no responsibility is assumed for clerical, typographical, or proofreading errors, or omissions.

# Safety Precautions

## Indications and Meanings of Safety Information

This manual uses the following precautionary symbols and signal words to ensure the safe use of the LCD Digital Operator. The precautions explained in this section describe important information regarding safety and must be followed without fail.

The precautionary symbols and signal words used in this manual and their meanings are explained below.

## Meanings of Signal Words



Indicates an imminently hazardous situation which, if not avoided, is likely to result in serious injury or may result in death. Additionally there may be severe property damage.



Indicates a potentially hazardous situation which, if not avoided, may result in minor or moderate injury or in property damage.

## Explanation of Symbols



⊘ This symbol indicates a prohibited item (an item you must not do).

The specific instruction is indicated using an illustration or text inside or near ⊘.  
The symbol shown to the left indicates “disassembly prohibited”.



⚠ This symbol indicates danger and caution.

The specific instruction is indicated using an illustration or text inside or near ⚠.  
The symbol shown to the left indicates “beware of electric shock”.



⚠ This symbol indicates danger and caution.

The specific instruction is indicated using an illustration or text inside or near ⚠.  
The symbol shown to the left indicates a “non-specific general danger”.



⚠ This symbol indicates caution (including warning).

The specific instruction is indicated using an illustration or text inside or near ⚠.  
The symbol shown to the left indicates “risk of hot surface”.



● This symbol indicates a compulsory item (an item that must be done).









The specific instruction is indicated using an illustration or text inside or near ●.  
The symbol shown to the left indicates a “general compulsory item”.









● This symbol indicates a compulsory item (an item that must be done).

The specific instruction is indicated using an illustration or text inside or near ●.  
The symbol shown to the left indicates “grounding required”.

## ⚠ WARNING

	Turn off the power supply and implement wiring correctly. Not doing so may result in a serious injury due to an electric shock.
	Wiring work must be carried out only by qualified personnel. Not doing so may result in a serious injury due to an electric shock.
	Do not change wiring and slide switches (SW1), put on or take off Operator and optional devices, replace cooling fans while the input power is being supplied. Doing so may result in a serious injury due to an electric shock.
	Be sure to ground the unit. Not doing so may result in a serious injury due to an electric shock or fire. (200V class: type-D grounding, 400V class: type-C grounding)
	Do not remove the terminal cover during the power supply and 10 minutes after the power shut off. Doing so may result in a serious injury due to an electric shock.
	Do not operate the Operator or switches with wet hands. Doing so may result in a serious injury due to an electric shock.
	Inspection of the Inverter must be conducted after the power supply has been turned off. Not doing so may result in a serious injury due to an electric shock. The main power supply is not necessarily shut off even if the emergency shut off function is activated.
	Do not touch the Inverter fins, braking resistors and the motor, which become too hot during the power supply and for some time after the power shut off. Doing so may result in a burn.

## ⚠ CAUTION

	Do not connect resistors to the terminals (+1, P/+2, N/-) directly. Doing so might result in a small-scale fire, heat generation or damage to the unit.
	Install a stop motion device to ensure safety. Not doing so might result in a minor injury. (A holding brake is not a stop motion device designed to ensure safety.)
	Be sure to use a specified type of braking resistor/regenerative braking unit. In case of a braking resistor, install a thermal relay that monitors the temperature of the resistor. Not doing so might result in a moderate burn due to the heat generated in the braking resistor/regenerative braking unit. Configure a sequence that enables the Inverter power to turn off when unusual over heating is detected in the braking resistor/regenerative braking unit.
	The Inverter has high voltage parts inside which, if short-circuited, might cause damage to itself or other property. Place covers on the openings or take other precautions to make sure that no metal objects such as cutting bits or lead wire scraps go inside when installing and wiring.
	Take safety precautions such as setting up a molded-case circuit breaker (MCCB) that matches the Inverter capacity on the power supply side. Not doing so might result in damage to property due to the short circuit of the load.
	Do not dismantle, repair or modify the product. Doing so may result in an injury.

# Precautions for Safe Use

---

## Installation and Storage

Do not store or use the product in the following places.

- Locations subject to direct sunlight.
- Locations subject to ambient temperature exceeding the specifications.
- Locations subject to relative humidity exceeding the specifications.
- Locations subject to condensation due to severe temperature fluctuations.
- Locations subject to corrosive or flammable gases.
- Locations subject to exposure to combustibles.
- Locations subject to dust (especially iron dust) or salts.
- Locations subject to exposure to water, oil, or chemicals.
- Locations subject to shock or vibration.

## Transporting, Installation, and Wiring

- Take sufficient shielding measures when using the product in the following locations. Not doing so may result in damage to the product.

Locations subject to static electricity or other forms of noise.

Locations subject to strong magnetic fields.

Locations close to power lines.

- If a parameter is set incorrectly when starting up, adjusting, maintaining, or replacing, an unexpected operation may occur.

Perform the operation after enough confirmation.

## Operation and Adjustment

- If the clock command is used in Drive Programming, an unexpected operation may occur due to weak battery. Take measures such as detecting a weak battery by a check that the clock data returns to the initial setting and stopping the Inverter or programs. When the LCD Digital Operator is removed or disconnected, Drive Programming is in a waiting status by the clock command.

## Maintenance and Inspection

- When disposing of LCD digital operators and wasted batteries, follow the applicable ordinances of your local government.

When disposing of the battery, insulate it using tape.



廢電池請回收

The following display must be indicated when products using lithium primary batteries (with more than 6 ppb of perchlorate) are transport to or through the State of California, USA.

Perchlorate Material - special handling may apply.  
See [www.dtsc.ca.gov/hazardouswaste/perchlorate](http://www.dtsc.ca.gov/hazardouswaste/perchlorate)

The 3G3AX-OP05 has the lithium primary battery (with more than 6 ppb of perchlorate). Label or mark the above display on the exterior of all outer shipping packages of your products when exporting your products which the 3G3AX-OP05 are installed to the State of California, USA.

- Do not short + and -, charge, disassemble, heat, put into the fire, or apply strong impact on the battery. The battery may leak, explode, produce heat or fire. Never use the battery which was applied strong impact due to such as fall on the floor, it may leak.
- UL standards establish that the battery shall be replaced by an expert engineer.  
The expert engineer must be in charge of the replacement and also replace the battery according to the method described in this manual.
- When the display of LCD Digital Operator can not be recognized due to the service life, replace the LCD Digital Operator.



# Precautions for Correct Use

---

## Retry Selection Function

- Be sure to confirm the RUN signal is turned off before resetting the alarm because the machine may abruptly start.

## Operation Stop Command

- Provide a separate emergency stop switch because the STOP Key on the Operator is valid only when function settings are performed.

# Regulations and Standards

---

## Overseas Use

To export (or provide to nonresident aliens) any part of this product that falls under the category of goods (or technologies) for which an export certificate or license is mandatory according to the Foreign Exchange and Foreign Trade Control Law of Japan, an export certificate or license (or service transaction approval) according to this law is required.

# Items to Check after Unpacking

After unpacking the product, check the following items:

- Is this the model you ordered?
- Was there any damage sustained during shipment?

## Checking the Nameplate

The product has the following nameplate labels on its rear face.



## Checking the Model

3 G 3 A X - O P 0 5

LCD Digital Operator

# Related Manuals

---

To operate this product, you must be familiar with the equipment connected to it. Please refer to the following manual for information on the related product.

Name	Catalog No.
RX User's Manual	I560-E2
LX User's Manual	I120E-EN
MX2 User's Manual	I570-E2



## Additional Information

---

For Inverter operation, please refer to the manual for the Inverter.

---

# Revision History

---

The manual revision code is a number appended to the end of the catalog number found in the bottom right-hand corner of the front and back covers.

## Example

<b>Cat. No.</b>	<b>I579-E2-01</b>
-----------------	-------------------

↑  
Revision code

Revision Code	Revision Date	Revised Content
01	January 2013	This manual replaces the LCD 5 Line Digital Operator Manual (I171E-EN-01)





# 1

## Overview

---

This section provides features and specifications of the LCD Digital Operator.

---

<b>1-1 Features</b> .....	<b>1-2</b>
<b>1-2 Supported Models</b> .....	<b>1-4</b>
<b>1-3 Specifications</b> .....	<b>1-5</b>
<b>1-4 External Dimensions</b> .....	<b>1-6</b>
<b>1-5 Recommended Cables</b> .....	<b>1-7</b>

# 1-1 Features

---

This LCD Digital Operator is intended for use with the RX, LX or MX2 inverter series.

It can be connected with the RX and LX inverters directly or with the RX, LX and MX2 inverters via cable (optional).

The LCD Digital Operator provides the following features:

## 5-Line English LCD

---

A large 5-line LCD displays the name and setting range of parameters as well as the parameter number, which improves the user's recognition performance during parameter setting and adjustment.

In addition, the display of up to four monitor functions enables you to check the status, adjust the Inverter, and etc.

In case of a trip warning, both the code and name of warning are displayed so that you can perform early troubleshooting.

## All Read/Write Functions for Inverter Parameters and Drive Programming

---

The all READ function enables to read all the parameter setting data stored in the Inverter. Up to four sets of Inverter parameter setting data can be read and stored in the internal memory of the LCD Digital Operator.

The parameter setting data in the memory can be all written, only if the Inverters are of the same model and version.

Using this feature, the time for setting parameters can be reduced when the same devices are started up or specifications are changed.

Or it is possible to store, upload and download up to a single set of Inverter parameter setting data and a Drive Programming program.

## VERIFY Function for Inverter Parameters and Drive Programming

---

This function enables to compare and verify parameters of the connected Inverter, Drive Programming, and data stored in the internal memory of the LCD Digital Operator. It is useful when checking conditions before shipment or in case of a trouble.

## Installation on the System Panel

---

Using the optional cable (Model: 3G3AX-OPCN1/OPCN3) enables you to mount the LCD Digital Operator on the surface of system panel. You can check and adjust the system status from outside the control panel.

## Built-in Clock Function

---

The LCD Digital Operator has the built-in clock function and a backup battery.

This enables the display of time information on the Current Time Monitor (d031).

This clock function is also available in the Drive Programming program.





### Precautions for Safe Use

---

- If the clock command is used in Drive Programming, an unexpected operation may occur due to weak battery. Take measures such as detecting a weak battery by a check that the clock data returns to the initial setting and stopping the Inverter or programs. When the LCD Digital Operator is removed or disconnected, Drive Programming is in a waiting status by the clock command.
- 



### Precautions for Correct Use

---

- The all WRITE function is available to write inverter parameters and Drive Programming only with Inverters of the same model and version.

If the all WRITE function does not work, check the Inverter models and versions and, if they are different, consider using the Inverter/Servo Parameter Support Tool CX-Drive.

---

## 1-2 Supported Models

---

RX series inverter (Model: 3G3RX-□).

LX series inverter (Model: 3G3LX-□).

MX2 series inverter (Model: 3G3MX2-□).

# 1-3 Specifications

	Item	Specification
Electrical specifications	Input power supply voltage	4.9 to 5.2 VDC
	Transmission method	RS-422 (R45)
	Transmission rate	19.2 Kbps/4,800 bps (switching)
Environment	Ambient operating temperature	-10 to 50°C
	Ambient operating humidity	20% to 90% (with no condensation)
	Ambient storage temperature	-20 to 65°C
	Location of use	1,000 m or less in height (at a place with no corrosive gas and dust)
Installation	External dimensions	123 (H) x 80 (W) x 21 (D) mm
	Connection type	Direct or via cable (3G3AX-OPCN1/OPCN3)
	Weight	0.1 kg
Display specifications	Display	Digital display on LCD (132 x 64 dots)
	Display language	English
Others	Number of writes to built-in EEPROM during service life	100,000 times
	Battery specifications	Coin type lithium battery CR1220 (Recommended manufacturer: Hitachi Maxell) * Built-in real time clock backup duration: About 4 years (at 25°C) (Including power OFF time)
	Clock accuracy	Error per month: -1.5 to 1.5 min

# 1-4 External Dimensions

The following figures show the dimensions of LCD Digital Operator and panel cut dimensions to install. When installing the LCD Digital Operator to the control panel, secure it from the back side using M3 screws (5 mm).

The recommended torque is 0.9 to 1.0 N·m.

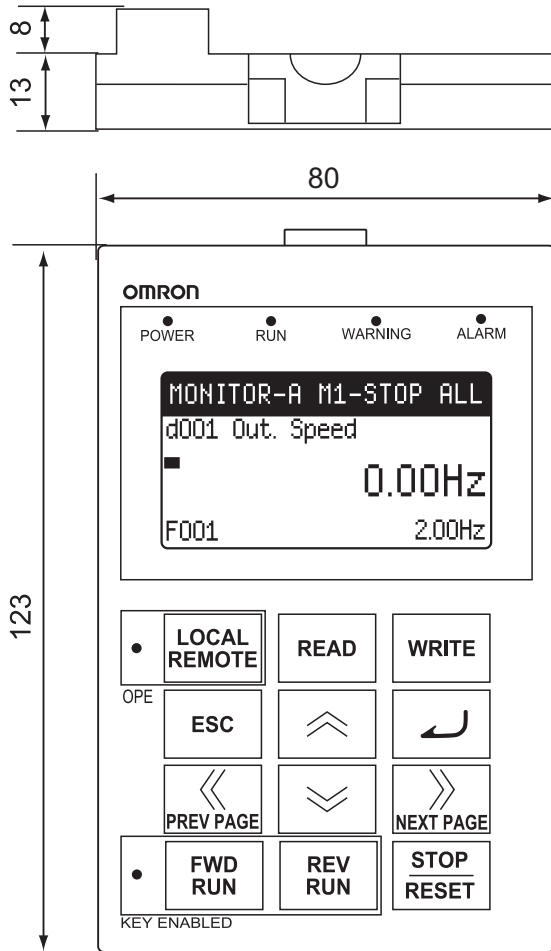

External Appearance of the LCD Digital Operator

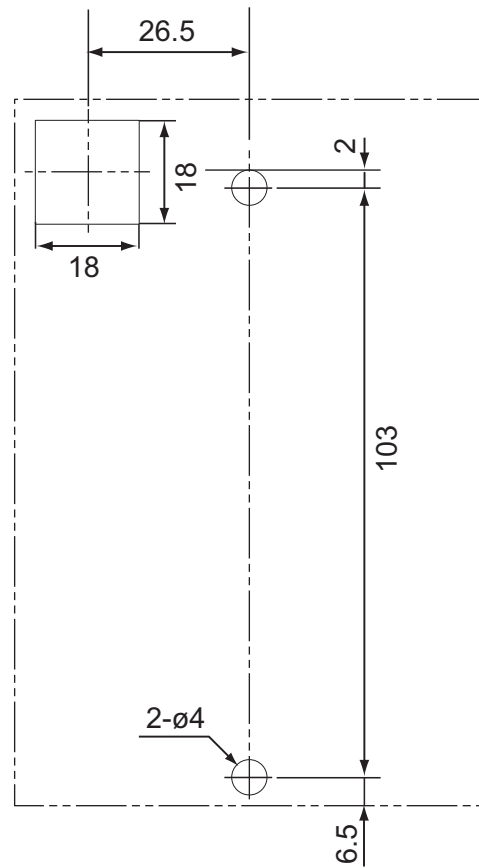

Panel Cutout Diagram

## 1-5 Recommended Cables

---

Use any of the following cables when installing the LCD Digital Operator separately from the RX, LX or MX2 inverter series.

Digital Operator cables

- 3G3AX-CAJOP300-EE (Cable length: 3 m)





# Part Names and Functions

This section describes the part names and functions of the LCD Digital Operator.

---

<b>2-1 Part Names</b> .....	<b>2-2</b>
<b>2-2 Operation Keys</b> .....	<b>2-4</b>
<b>2-3 LCD Display</b> .....	<b>2-6</b>

# 2-1 Part Names

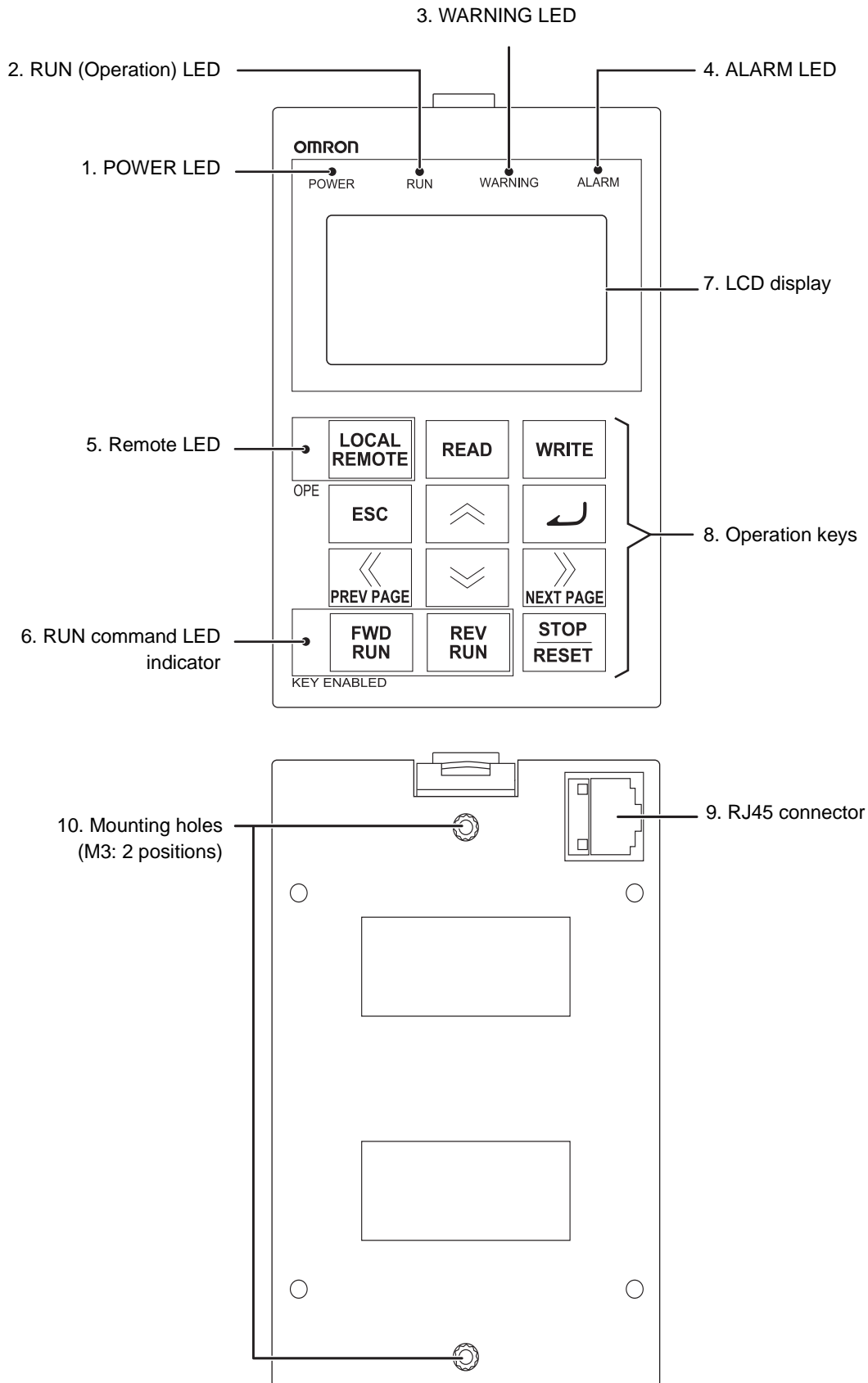



No.	Name	Color	Description
1	POWER LED	Green	Lights when power is supplied to the LCD Digital Operator.
2	RUN (Operation) LED	Green	Lights during Inverter operation.
3	WARNING LED	Red	Lights when the Inverter parameter settings are incorrect.
4	ALARM LED	Red	Lights when the Inverter trips.
5	Remote (OPE) LED	Green	Lights when the forced operator function is enabled by the LOCAL REMOTE key. (Press the LOCAL REMOTE key for 2 seconds or more.).
6	RUN command LED indicator	Green	Lights when the RUN command is enabled on the LCD Digital Operator. At this time, the FWD RUN, REV RUN, and STOP/RESET keys can be used to operate the Inverter.
7	LCD display		Displays various parameter settings, frequency, or other information. For details, refer to <i>Section 4 Operation Procedures</i> , <i>Section 5 LCD Digital Operator Related Parameters</i> , and <i>Section 6 Read/Write Functions</i> .
8	Operation keys		These keys are used for display and setting. For details, refer to <i>Section 4 Operation Procedures</i> , <i>Section 5 LCD Digital Operator Related Parameters</i> , and <i>Section 6 Read/Write Functions</i> .
9	RJ45 connector		Connects the LCD Digital Operator with the Inverter directly or via cable (sold separately).
10	Mounting holes		Use these holes to install the LCD Digital Operator on the control panel. Secure it from the back side using M3 screws.



#### Precautions for Correct Use

- Determine whether the operation keys (FWD RUN, REV RUN, and STOP/RESET keys) are enabled based on the ON/OFF status of the RUN command LED indicator. Remember that the operation keys may be enabled even when the remote LED is not lit.
- The remote LED lights only when the forced operator function is enabled by pressing the LOCAL REMOTE key for 2 seconds or more.

Note that the remote LED does not light if the forced operator function is enabled by the multi-function input which is set the forced operator function (OPE).





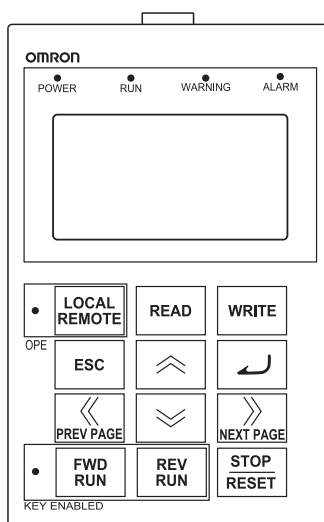

In this case, determine whether the forced operator function (OPE) is enabled based on the status of the multi-function input terminal.

## 2-2 Operation Keys



Operation keys

No.	Key image	Name	Function
1		LOCAL REMOTE key	Switches between the Local and Remote modes. If the key is pressed for 2 seconds or more, the mode is switched; from Local to Remote or from Remote to Local. When the LCD Digital Operator is in the Local mode, the Remote (OPE) LED is lit. Use the Local mode to operate the Inverter using the LCD Digital Operator's operation keys (FWD RUN, REV RUN, and STOP/RESET).
2		READ key	Reads all the parameter setting data into the LCD Digital Operator's memory. For details, refer to <i>Section 5 LCD Digital Operator Related Parameters</i> .
3		WRITE key	Copies a single set of Inverter parameter setting data, or a single set of Inverter parameter setting data and a Drive Programming program, stored on the LCD Digital Operator into the Inverter. For details, refer to <i>Section 5 LCD Digital Operator Related Parameters</i> .
4		ESC key	Returns to a screen in the one level higher layer. If pressed during a parameter change, the LCD Digital Operator displays the previous screen with the change cancelled.
5		Enter key	Brings you forward to the screen that is one level lower in the hierarchy. If pressed during a parameter change, the LCD Digital Operator displays the previous screen with the change fixed and stored.
6		Increment key	Moves the cursor up. It is also used to increase the parameter number or parameter value.

No.	Key image	Name	Function
7		Decrement key	Moves the cursor down. It is also used to decrease the parameter number or parameter value.
8		PREV PAGE key	Moves the cursor to the left. In Navigation level display mode, moves to the previous mode.
9		NEXT PAGE key	Moves the cursor to the right. In Navigation level display mode, moves to the next mode.
10		FWR RUN key *1	Runs the motor in the forward direction. This key is enabled in the following cases. <ul style="list-style-type: none"> <li>• The remote mode is enabled by pressing the LOCAL REMOTE key for 2 seconds (the remote LED is lit).</li> <li>• RUN Command Selection (A002) is set to "02: Digital operator".</li> <li>• The forced operator function is enabled by the multi-function input which is set the forced operator function (OPE).</li> </ul>
11		REV RUN key *1	Runs the motor in the reverse direction. This key is enabled in the following cases. <ul style="list-style-type: none"> <li>• The remote mode is enabled by pressing the LOCAL REMOTE key for 2 seconds (the remote LED is lit).</li> <li>• RUN Command Selection (A002) is set to "02: Digital operator".</li> <li>• The forced operator function is enabled by the multi-function input which is set the forced operator function (OPE).</li> </ul>
12		STOP/RESET key	Stops the motor, or resets the alarm. When the parameter b087 (Stop key selection) is set to "01: Disable," this key is enabled in the following cases only. <ul style="list-style-type: none"> <li>• The remote mode is enabled by pressing the LOCAL REMOTE key for 2 seconds (the remote LED is lit).</li> <li>• RUN Command Selection (A002) is set to "02: Digital operator".</li> <li>• The forced operator function is enabled by the multi-function input which is set the forced operator function (OPE).</li> </ul>

\*1 Check the KEY ENABLED indicator (RUN command LED indicator).



#### Precautions for Safe Use

- Provide a separate emergency stop switch because the STOP key on the operator is valid only when function settings are performed.
- The FWD RUN, REV RUN, and STOP/RESET keys are disabled while the Inverter parameter settings are all read or written. Perform the all read/write functions during Inverter stop.

## 2-3 LCD Display

### Backlight

The LCD display has two backlight colors; white and orange.

The color of the backlight indicates the state of the Inverter, as shown in the following table.

Backlight color	State
White	Normal (No relation to the RUN/Stop state of the Inverter)
Orange	Warning (Parameter mismatch)
White/Orange (Flashing alternately at intervals of 1 second)	Trip (Same as the ALARM LED)

### LCD Display

The first line of LCD display always shows the display mode, the selected motor, the Inverter RUN status, and the display selection.

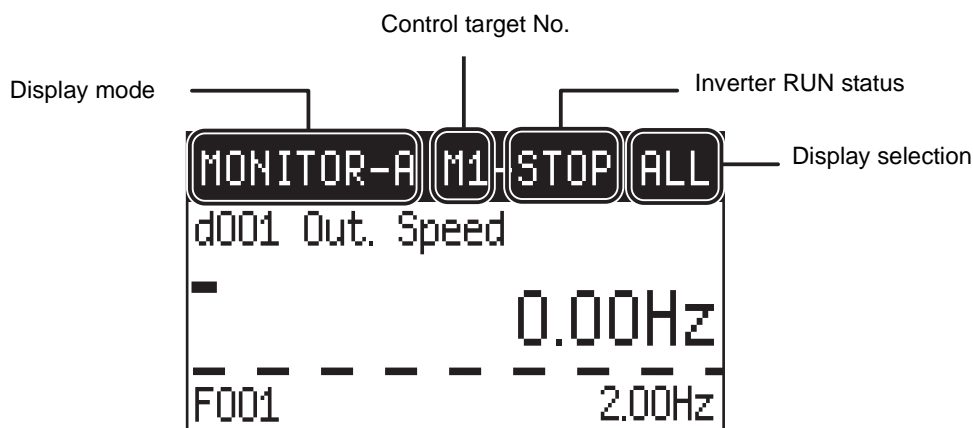

Item	Display item	Description
Display mode	MONITOR-A	Monitor Mode A
	MONITOR-B	Monitor Mode B
	FUNCTION	Function Mode
	TRIP	Trip Mode (Error)
	WARNING	Warning Mode (Warning)
	READ	Read Mode
	WRITE	Write Mode
	OPTION	Option Mode
Control target No.	M1	1st control (Normal)
	M2	2nd control (allocate Multi-function Input S1 to S8 Selection (C001 to C008) to "08: SET" and turn ON to switch)
	M3	3rd control (allocate Multi-function Input S1 to S8 Selection (C001 to C008) to "17: SET3" and turn ON to switch)

Item	Display item	Description
Inverter RUN status	STOP	Stop
	FWD	Forward
	REV	Reverse
Setting in b037 (Display Selection)	ALL	Complete display
	UTL	Individual display of functions
	USR	User setting display
	CMP	Data comparison display
	BAS	Basic display



# 3

## Installation and Wiring

This section provides information on the installation and wiring of the LCD Digital Operator.

---

<b>3-1</b>	<b>Installation on the Inverter</b>	<b>3-2</b>
3-1-1	Direct Installation on the Inverter (RX, LX models)	3-3
3-1-2	Installation on the Inverter via Cable (RX, LX, MX2 models)	3-4
3-1-3	Checking the Operation After Installation	3-5
3-1-4	Date and Time Setting	3-6
3-1-5	Other Settings	3-6

## 3-1 Installation on the Inverter

---

This section shows how to install the LCD Digital Operator on the RX, LX and MX2 inverter series.

The installation procedure differs with installation methods. This section describes the following 2 methods.

- Direct installation on the Inverter
- Installation on the Inverter via cable

Section	Title	Description
3-1-1	Direct installation on the Inverter	Describes the procedure for installing the LCD Digital Operator directly on the Inverter.
3-1-2	Installation on the Inverter via Cable	Describes the procedure for installing the LCD Digital Operator on the Inverter via cable in situations where: <ul style="list-style-type: none"> <li>• The LCD Digital Operator is installed on the control panel.</li> <li>• The use of a Communications Unit prevents direct installation on the Inverter.</li> </ul>



### Precautions for Correct Use

---

- Shut off the power supply to the Inverter before installing or removing the LCD Digital Operator. Not doing so may result in failure.
  - The LCD Digital Operator cannot be installed directly on an Inverter that is already mounted with a Communications Unit.
-



### 3-1-1 Direct Installation on the Inverter (RX, LX models)

This section describes the procedure for installing the LCD Digital Operator directly on the Inverter.



#### Precautions for Correct Use

The LCD Digital Operator cannot be installed directly on an Inverter that is already mounted with a Communications Unit.

- 1 Remove the Digital Operator and the spacer cover from the Inverter.

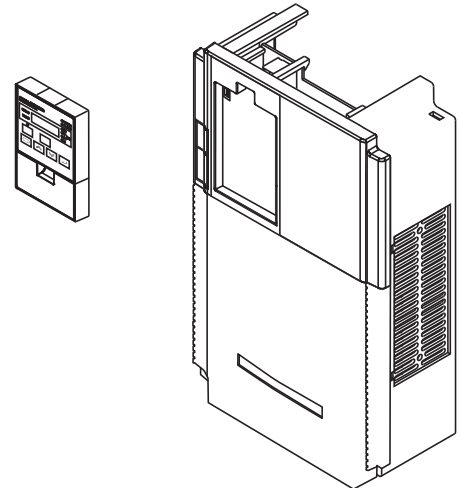

- 2 Install the LCD Digital Operator on the Inverter.

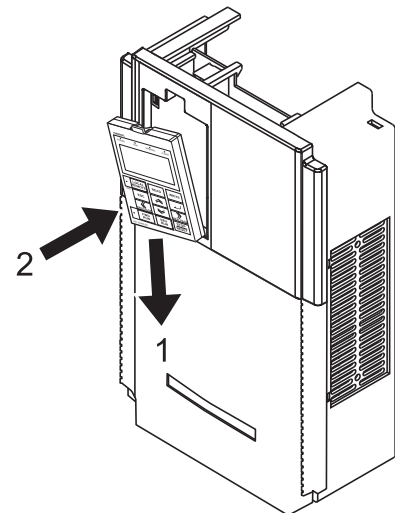

#### Additional Information

To facilitate installation, raise the connector of the Inverter and push the LCD Digital Operator into the Inverter.

### 3-1-2 Installation on the Inverter via Cable (RX, LX, MX2 models)

- 1** If necessary, mount the LCD Digital Operator to the panel. Cut out the panel according to the panel cutout diagram and, using M3 screws, secure the LCD Digital Operator to the panel from the back side.

The recommended torque is 0.9 to 1.0 N·m.

For panel cutout dimensions, refer to 1-4 *External Dimensions* on page 1-6.

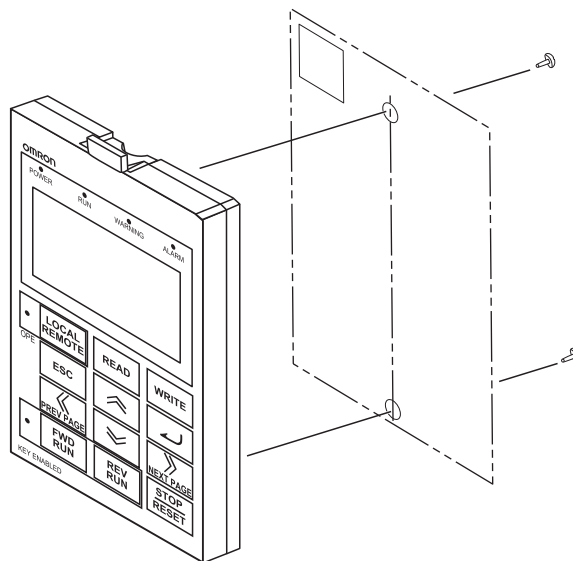

- 2** Connect the LCD Digital Operator with the Inverter via cable.

- Recommended cable model:  
3G3AX-CAJOP300-EE (Cable length: 3 m)

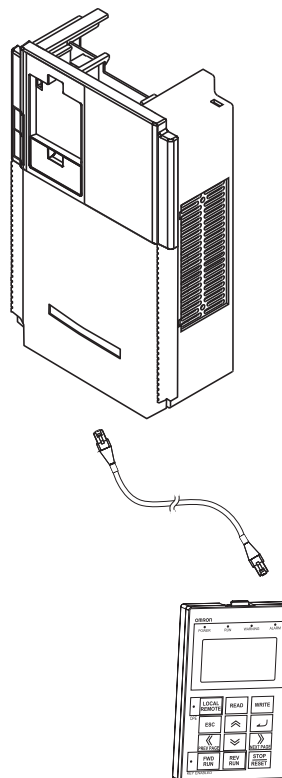

### 3-1-3 Checking the Operation After Installation

After checking that the system and surrounding areas are safe, turn ON the power supply to the Inverter.

Check the LCD Digital Operator display.

The installation is completed successfully if the following Monitor screen is displayed.

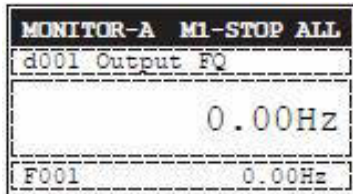

However, when the power is supplied to the LCD Digital Operator for the first time after purchase, when the built-in battery is consumed, or when the power supply is turned on for the first time after battery replacement, the following screen appears, which prompts you to set the clock. If this screen is displayed, press the ESC key to move to the normal screen and perform the Date and Time setting from the OPTION MODE menu. For the Date and Time setting, refer to 3-1-4 *Date and Time Setting* on page 3-6.

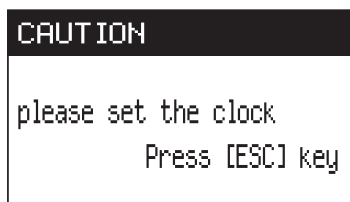

The LCD Digital Operator may display the COM ERROR screen, or the Read & Copy only screen when the power is supplied. In this case, choose INV Type Select from the OPTION MODE menu and set the type of the Inverter to be used.

For details, refer to 5-1-2 *Details of Each Option Mode Parameter* on page 5-4.





#### Precautions for Correct Use

- The LCD Digital Operator can be used without configuring the Date and Time setting. However, if the clock command is used in Drive Programming, configure the Date and Time setting. Not doing so may result in an unexpected operation due to the lack of the correct date and time information.
- The available display language is only English on this LCD Digital Operator. Be sure to set the Language option to "01: English". If the language display is abnormal, check from the OPTION MODE menu to be sure that the Language is set to "01: English". For details, refer to 5-1-1 *Operation in the Option Mode* on page 5-2.

### 3-1-4 Date and Time Setting

If the screen, which prompts you to set the clock, appears as shown below, press the ESC key to return to the normal screen

and simultaneously press the , , and  keys to enter the Option Mode.

Select Date and Time by pressing the  key to set the current date and time.

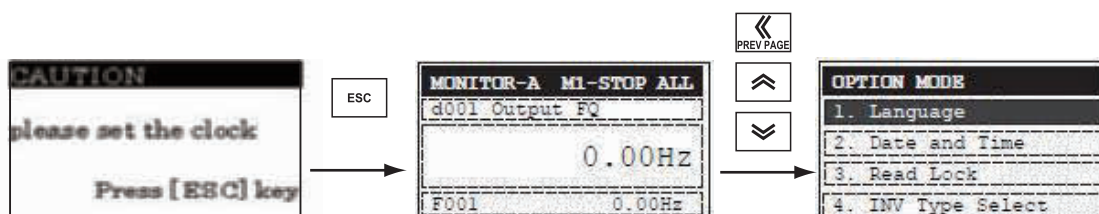

#### Additional Information

The screen, which prompts you to set the clock, disappears automatically in 3 minutes after the power supply is turned on.

### 3-1-5 Other Settings

Change the LCD Digital Operator settings (in the Option Mode) and Inverter parameter settings as required.

For details about changing the parameter settings, refer to *Section 5 LCD Digital Operator Related Parameters*.

# 4

## Operation Procedures

This section provides an overview of the display modes supported by LCD Digital Operator and how to operate the LCD Digital Operator in each display mode. For the Option Mode, refer to *Section 5 LCD Digital Operator Related Parameters*. For the Read/Write Mode, refer to *Section 6 Read/Write Functions*.

4

---

<b>4-1 Overview of Display Modes</b> .....	<b>4-2</b>
4-1-1 Transition of Screens .....	4-2
4-1-2 Overview of Each Mode .....	4-3
4-1-3 Changing the Display in Each Mode .....	4-5
<b>4-2 Operation in the Monitor Mode A</b> .....	<b>4-6</b>
<b>4-3 Operation in the Monitor Mode B</b> .....	<b>4-7</b>
<b>4-4 Operation in the Function Mode</b> .....	<b>4-8</b>
<b>4-5 Operation in the Trip Mode</b> .....	<b>4-9</b>

# 4-1 Overview of Display Modes

## 4-1-1 Transition of Screens

The basic display screens of LCD Digital Operator are displayed in four modes as shown below.

Each mode has two levels: the higher Navigation level and the lower Edit level. The user can move between each mode in the Navigation level only.

- Monitor Mode A: The mode to display and set a single monitor function and a single parameter function.
- Monitor Mode B: The mode to display up to four monitor functions on a single screen.
- Function Mode: The mode to set parameter settings. The screen also displays the parameter name and setting range.
- Trip Mode: The mode to display the trip and warning information.

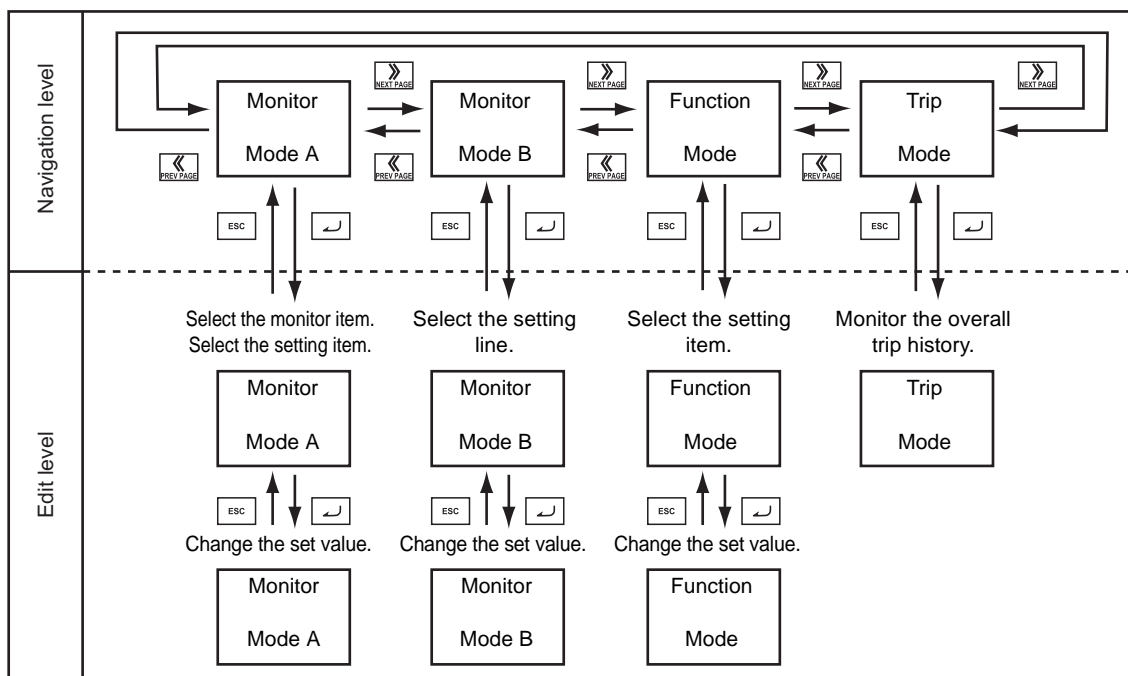

In addition to the above, the LCD Digital Operator has the following three called modes. At any of the above levels and in any operating state, you can call these modes by pressing the key(s) shown to the right of the down arrow above each screen, as shown on the next page. After calling these screens, you can press the ESC key to restore the operating state before the call.

- All Read: The mode to read all Inverter parameter settings and Drive Programming data from the Inverter.
- All Write: The mode to write all Inverter parameter setting and Drive Programming data to the Inverter.
- Option Mode: The mode to set the LCD Digital Operator.

These modes can be called at any level and in any operating state.  
Press the ESC key to restore the operating state before the call.



## 4-1-2 Overview of Each Mode

### Monitor Mode A

In this mode, one “d” group Inverter monitor function and one “F to U” group Inverter parameter are displayed on the same screen.  
The content of “d” group Inverter monitor function is displayed in a large font size. The parameter number such as “F001” and the content of “F to U” parameter are displayed without the function name.

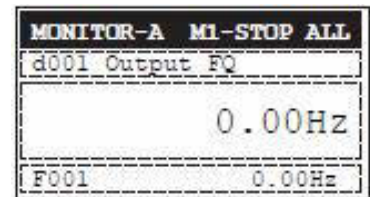

### Monitor Mode B

In this mode, four “d” group Inverter monitor functions can be displayed on the same screen. At this time, the parameter numbers are not displayed.

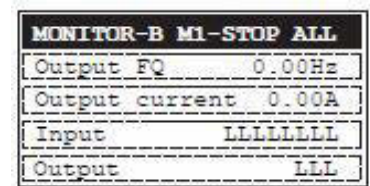

## Function Mode

In this mode, “F to U” group Inverter parameters can be displayed and set.

The screen shows the parameter number, function name, parameter data and setting range of the parameter.

FUNCTION	M1-STOP	ALL
E001		
Set Frequency (E2SQ)		
0.00Hz		
[0.00 - 50.00]		



### Precautions for Correct Use

In the Function Mode, “d” group Inverter monitor functions cannot be displayed and set.

## Trip Mode

Trip information and warning information are displayed in this mode.

If a trip or a warning occurs in the Inverter, the trip screen is displayed from any display mode.

In the Option Mode, Read Mode, and Write Mode, the trip screen is not displayed even if an Inverter trip or warning occurs.

The ALARM or WARNING LED lights up.

TRIP	M1-STOP	ALL
E45.1		
PRG. Syntax		
270111	16:31	Stop

TRIP	M1-STOP	ALL
ERR1 P1	UnderVoltage	
090104	11:52	0Hz-RUN
Output FQ	0.00Hz	
Output current	0.00A	

## Read Mode

In this mode, a single set of Inverter parameter settings, or a single set of parameter settings and a Drive Programming program, can be all read and stored in the LCD Digital Operator.

Select a single set or four sets of storage data by 5. R/W Storage Mode in the OPTION MODE menu.

For details about the Read Mode, refer to *Section 6 Read/Write Functions*.

Case: 5. R/W Storage Mode = “01 :Single”

READ
Data reading...
OPE <- INV
Please keep power ON!

Case: 5. R/W Storage Mode = “02: Quad”

READ
1. 1.141210 10:33 INV81
2. -----
3. -----
4. -----



## Write Mode

In this mode, the Inverter parameter settings and Drive Programming program data stored in the LCD Digital Operator can be all written to the Inverter.

Change the number of storage data by selecting 5. R/W Storage Mode in the OPTION MODE menu.

For details about the Write Mode, refer to *Section 6 Read/Write Functions*.

Case: 5. R/W Storage Mode = "01 :Single"

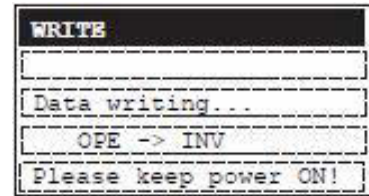

Case: 5. R/W Storage Mode = "02: Quad"

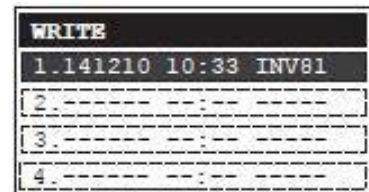

## Option Mode

In this mode, the parameter settings of the LCD Digital Operator can be set and changed.



This mode supports the following settings of the LCD Digital Operator.

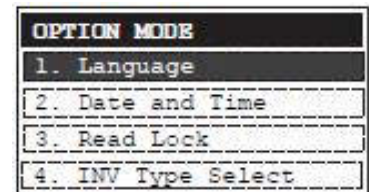



1. Language
2. Date and Time
3. Read Lock
4. INV Type Select
5. R/W Storage Mode
6. Backlight Auto-off
7. Backlight Flicker
8. Operator Reset
9. Check Mode



For details about the Option Mode, refer to *Section 5 LCD Digital Operator Related Parameters*.

### 4-1-3 Changing the Display in Each Mode

Each display mode can be switched by pressing the  or  key in the Navigation level.

In each mode, press the  key to move to the Edit level and press the  key to move to the Navigation level. To move to the Read or Write Mode, press the  or  key.

To move to the Option Mode, press the , , and  keys simultaneously.

For the transition between display modes, refer to the figure in *4-1-1 Transition of Screens* on page 4-2.

## 4-2 Operation in the Monitor Mode A

- 1** At the Navigation level, press the  or  key to select the Monitor Mode A (MONITOR-A) screen.



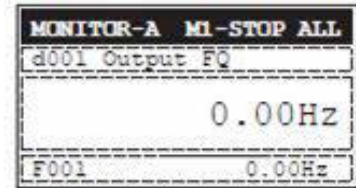

Press the  key to show the cursor on the “d” group monitor function.

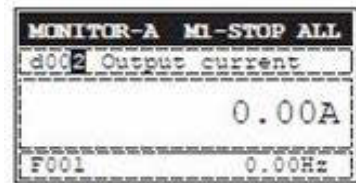

- 2** Press the  or  key to select the monitor function to display on the MONITOR-A screen. Select the parameter number corresponding to the monitor function to display.

- Press the  key to return to the Navigation level.



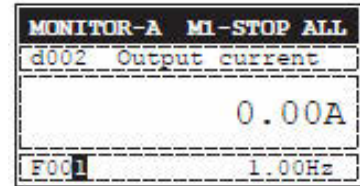

- 3** To move the cursor position displayed on the screen, press the  or  key. When the cursor moves to the Inverter parameter number displayed on the last line (in this case, F001), you can change the parameter number by the  or  key.

- Press the  key to return to the Navigation level.



- 4** After changing the Inverter parameter number, press the  key to move the cursor to the parameter data position.

Change the parameter data using the  or  key.

- To save the change, press the  key. The cursor returns to the parameter number.
- To cancel the change, press the  key. The cursor returns to the parameter number.

Press the  key to return to the Navigation level.

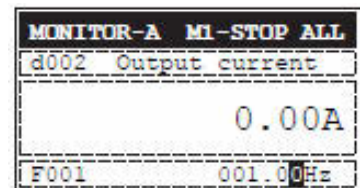

## 4-3 Operation in the Monitor Mode B

- 1** At the Navigation level, press the  or  key to select the Monitor Mode B (MONITOR-B) screen.

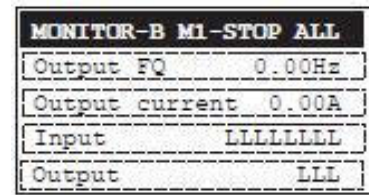

- 2** Press the  key to show the cursor in the first parameter line of the “d” group monitor function.

Press the  or  key to move between the four inverter parameters.

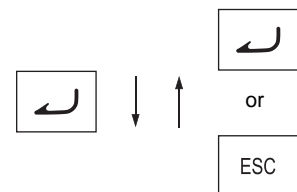
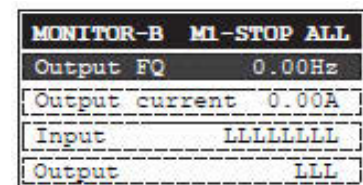

- Press the  key to return to the Navigation level.



- 3** Select the parameter to change and press the  key.



The cursor moves to the parameter number of the selected “d” group monitor function.

Press the  or  key to select the parameter number to monitor.

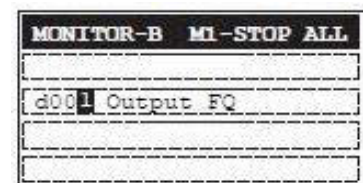



- To register the parameter number, press the  key. The screen returns to the parameter display screen.
- To cancel the change, press the  key. The screen returns to the parameter display screen.
- Press the  key again to return to the Navigation level.



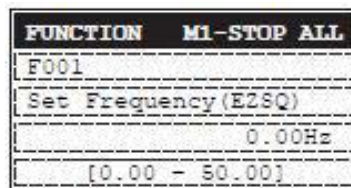

## 4-4 Operation in the Function Mode



- 1** At the Navigation level, press the  or  key to select the Function Mode screen.

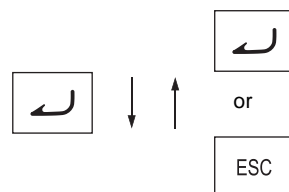
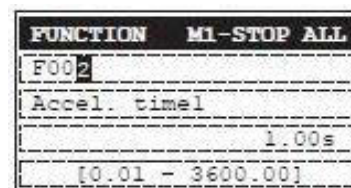



- 2** Press the  key. The cursor moves to the parameter number. Then, press the , , , or  key to select the parameter No. to change.



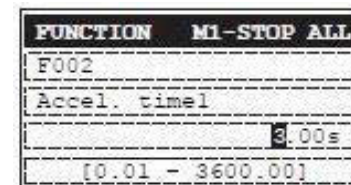

- Press the  key to return to the Navigation level.

- 3** Press the  key. The cursor is now placed over the parameter data. Press the  or  key to select the value to set.



- To save the parameter value, press the  key. When saved, the cursor moves to the parameter number.
- To cancel the change, press the  key. The cursor moves to the parameter number.

## 4-5 Operation in the Trip Mode

- 1** At the Navigation level, press the  or  key to select the Trip Mode screen.

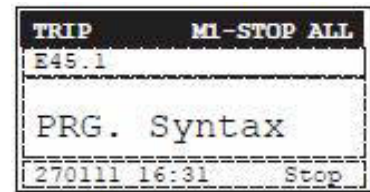

- 2** Press the  key to show the information on the past trips (six trip errors) recorded in the Inverter and the information on the warning (one warning).

The information on one trip error comprises two pages. To switch from page 1 (P1) to page 2 (P2),

press the  or  key.

To display the information on the past six trip errors,

press the  or  key.

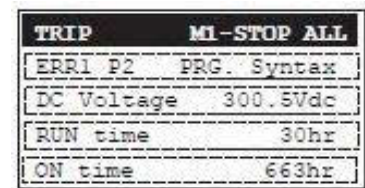
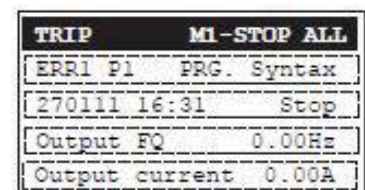

- 3** If you press the  key when ERR1 is displayed or press the  key when ERR6 is displayed, the screen switches to the Warning Mode.

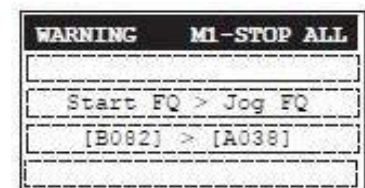

### Precautions for Correct Use

If a trip occurs, the ALARM LED lights up. Then, press the  key to reset the Inverter.



# 5

## LCD Digital Operator Related Parameters

This section describes the Inverter parameters related to the LCD Digital Operator.

---

<b>5-1</b>	<b>Parameter Setting</b> .....	<b>5-2</b>
5-1-1	Operation in the Option Mode .....	5-2
5-1-2	Details of Each Option Mode Parameter .....	5-4
<b>5-2</b>	<b>Related Inverter Parameters</b> .....	<b>5-6</b>

# 5-1 Parameter Setting



The LCD Digital Operator parameters can be set and changed in the Option Mode.



The Option Mode provides the following nine settings:

1. Language
2. Date and Time
3. Read Lock
4. INV Type Select
5. R/W Storage Mode
6. Backlight Auto-off
7. Backlight Flicker
8. Operator Reset
9. Check Mode

The next section describes how to operate in the Option Mode.

## 5-1-1 Operation in the Option Mode

- 1** Press the , , and  keys simultaneously to enter the Option Mode.

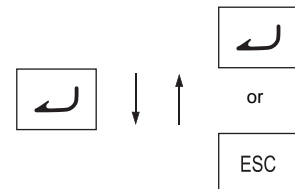
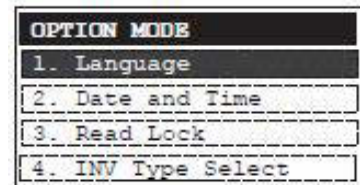

The cursor appears in the first line of the OPTION MODE menu. Press the  or  key to move between the OPTION MODE menu.

To return to the Navigation level, press the  key.



- 2** Select Language and press the  key. The cursor moves to the Language setting.

Press the  or  key to change the set value.

- To save the change, press the  key. The screen returns to the OPTION MODE menu.
- To cancel the change, press the  key. The screen returns to the OPTION MODE menu.

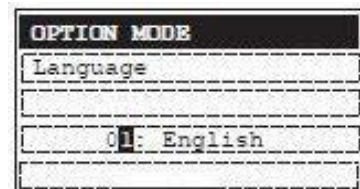

### Precautions for Correct Use

The available display language is only English on this LCD Digital Operator. Even if other language is set, the screen is displayed in English.

In the Language setting, always select "01: English".



- 3** Press the  to move the cursor over 2. Date and Time in the second line.

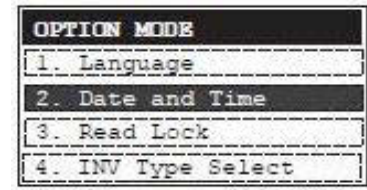

- 4** In 2. Date and Time, press the  key. The cursor moves over the date and time data.

Press the  or  key to move among the day, month, year, and time data. When the cursor is placed over any of these data, you can change the value by the  or  key.



- To save the change, press the  key. The screen returns to the OPTION MODE menu.
- To cancel the change, press the  key. The screen returns to the OPTION MODE menu.

### 5-1-2 Details of Each Option Mode Parameter

The table below shows the setting of each Option Mode item.

Item	Description	Setting range	Default
1. Language	Select the display language.	01: English	01
2. Date and Time	Set the date and time for the LCD Digital Operator. * On the screen, move the cursor over the Format number and select the desired format (1 to 3).	Format 1: (YYYY/MM/DD) Date: 2000/01/01 to 2099/12/31 Time: 00:00 to 23:59 Format 2: (MM/DD/YYYY) Date: 01/01/2000 to 12/31/2099 Time: 00:00 to 23:59 Format 3: (DD/MM/YYYY) Date: 01/01/2000 to 31/12/2099 Time: 00:00 to 23:59	2009/01/01 THU 00:00 Format 1
3. Read Lock	Select this to protect the parameter settings stored in the LCD Digital Operator from overwriting.	01: Enable 02: Disable	02
4. INV Type Select	Select the type of the Inverter used with this LCD Digital Operator. If the set Inverter type does not match the Inverter actually connected, the LCD Digital Operator will display "COM ERROR" automatically.	01: Type 1 (All models) 02: Type 2 (Do not set)	01
5. R/W Storage Mode	Select a single set or four sets of Inverter parameters to store in the LCD Digital Operator's internal memory. Setting this to "01: Single" facilitates the operability and is effective for writing to more than one Inverter. For details, refer to <i>Section 6 Read/Write Functions</i> .	01: Single (Single set of parameter settings and one Drive Programming program) 02: Quad (Four sets of parameter settings)	02
6. Backlight Auto-off	Set the Backlight Auto-off function. The backlight of LCD Digital Operator automatically turns off if any key is not pressed for 1 minute. The backlight will light up again if you press any key. The Backlight Auto-off function will not work if a trip occur.	01: Off (Disable) 02: 1 minute	01

Item	Description	Setting range	Default
7. Backlight Flicker	Set this to enable or disable the orange backlight illumination.	01: Enable 02: Disable	01
8. Operator Reset	Use this function to reset the LCD Digital Operator to its default settings. The following items will be reset: 1) Language: English 2) Date and Time: 2009/01/01 THU 00:00 3) Time Format: 01: YY/MM/DD 4) Read Lock: Disable 5) R/W Storage Mode: Quad 6) Backlight Auto-off: Off 7) Backlight Flicker: Enable After resetting the LCD Digital Operator, you need to perform the Date and Time setting again.	01: YES 02: NO	02
9. Check Mode	Select this to check whether the LEDs, keys etc. work normally.	1: Key&Led Check 2: Lcd Check 3: RTC Check 4: EEPROM Check 5: Serial Loopback 6: Debug Mode 7: Firmware Version	—



#### Precautions for Correct Use

- The applicable Language option is “01: English” only.  
The LCD Digital Operator may not provide the expected operation with other settings.
- Do not enable the EEPROM check. If you perform the EEPROM check, the data (parameter setting and Drive Programming program data) stored in the LCD Digital Operator will be lost.

## 5-2 Related Inverter Parameters

The table below shows the RX and MX2 Inverter parameters related to the LCD Digital Operator.  
For details, please refer to RX (I560-E2) or MX2 (I570-E2) User's Manuals.

Parameter No.	Function name	Data	Default value	Unit
b031	Soft Lock Selection	00: Data other than b031 cannot be changed when terminal SFT is ON. 01: Data other than b031 and set frequency cannot be changed when terminal SFT is ON. 02: Data other than b031 cannot be changed. 03: Data other than b031 and set frequency cannot be changed. 10: Data can be changed during RUN.	01	–
b037	Display Selection	00: Complete display 01: Individual display of functions 02: User setting + b037 03: Data comparison display 04: Basic display	00	–
b038	Initial Screen Selection	000: Screen on which the Enter key was last pressed 001 to 060: d001 to d060 201: F001 202: Do not set	001	–
b087	STOP Key Selection	00: Enable 01: Disable 02: Only resetting enabled	00	–
b166	Data Read/Write Selection <sup>*1</sup>	00: R/W OK 01: R/W protected	00	–

\*1 Setting b166 (Data Read/Write Selection) to "01: R/W protected" disables the all read/write functions and thus data cannot be read/written from the LCD Digital Operator.

The table below shows the LX Inverter parameters related to the LCD Digital Operator.

For details, please refer to LX (I120E-EN) User's Manual.

Parameter No.	Function name	Data	Default value	Unit
F010	STOP Key Enable	00: Enable 01: Disable 02: Reset (disabling only the function to stop)	00	—
F011	Function Code Display Restriction	00: ALL (full display) 01: FUNCTION (function-specific display) 02: USER (user setting) 03: COMPARE (data comparison display) 05: MONITOR (monitor only display)	00	—
F013	Soft Lock Selection	00: MD0 (disabling change of data other than "F013" when SFT is ON) 01: MD1 (disabling change of data other than "F013" and frequency settings when SFT is ON) 02: MD2 (disabling change of data other than "F013") 03: MD3 (disabling change of data other "F013" and frequency settings)	00	—
F014	Copy Function Enable	00: Disable 01: Enable	00	—





# Read/Write Functions

This section describes how to read and write Inverter parameter settings using the LCD Digital Operator.

---

<b>6-1</b>	<b>Single READ Function</b> .....	<b>6-2</b>
<b>6-2</b>	<b>Single WRITE Function</b> .....	<b>6-3</b>
<b>6-3</b>	<b>Quad READ Function</b> .....	<b>6-4</b>
<b>6-4</b>	<b>Quad VERIFY Function</b> .....	<b>6-6</b>
<b>6-5</b>	<b>Quad WRITE Function</b> .....	<b>6-8</b>
<b>6-6</b>	<b>Conditions for the Read/Write Operations</b> .....	<b>6-10</b>

## 6-1 Single READ Function

The Single READ function is enabled when 5. R/W Storage Mode in the OPTION MODE menu is set to "01: Single".

The Single Read function is executed immediately just by pressing the  key.

The Single READ function reads a single set of Inverter parameter setting data and a Drive Programming program and stores them to the LCD Digital Operator. When reading is completed, the screen returns to the previous screen.

This is time-saving when you need to repeat the all read/write operations.



### Precautions for Correct Use

- The Single READ function cannot be executed by pressing the  key in the Write Mode or Option Mode.  
Use this function in other modes.
- The Single READ function overwrites the data existing in the LCD Digital Operator because its memory is set to store a single set of Inverter data.
- This function attempts to read a Drive Programming program even when it is not stored in the Inverter. At that time, it stores the status of no Drive Programming program.



## 6-2 Single WRITE Function

The Single WRITE function is enabled when 5. R/W Storage Mode in the OPTION MODE menu is set to "01: Single".

The Single WRITE function is executed immediately just by pressing the  key.

The Single WRITE function writes a single set of Inverter parameter setting data and a Drive Programming program stored in the LCD Digital Operator to the connected Inverter.

When writing is completed, the screen returns to the previous screen.

This is time-saving when you need to repeat the all read/write operations.



### Precautions for Correct Use

- The Single WRITE function cannot be executed by pressing the  key in the READ Mode or Option Mode.  
Use this function in other modes.
- The Single WRITE function is available only with Inverters of the same model and of the same version.



If the all WRITE function does not work, check the Inverter models and versions and, if they are different, consider using the Inverter/Servo Parameter Support Tool CX-Drive.

## 6-3 Quad READ Function

The Quad READ function is enabled when 5. R/W Storage Mode in the OPTION MODE menu is set to "02: Quad". The Quad READ function provides the following two operations.

- Reads a single set of all Inverter parameter setting data and stores up to four sets in the specified memory number 1 to 4.
- Reads a single set of all Inverter parameter setting data and a Drive Programming program, and stores the data in the memory number 1. At this time, the Drive Programming program is stored in the other three sets of internal memory.

Press the  key. When the READ screen appears, select the memory number to store the data.

Press the  key. The Select data is displayed. Select one of the following operations to execute and press the  key again.



- 01: Read Data (reads a single set of all Inverter parameter setting data)
- 02: Read Data+EzSQ (reads a single set of all Inverter parameter setting data and a Drive Programming program)
- 05: Cancel (cancels the read operation)

When reading is completed, the screen returns to the previous screen.

For the Quad VERIFY function, refer to 6-4 Quad VERIFY Function on page 6-6.



When no Inverter parameter setting data is stored in the LCD Digital Operator, "-" is shown.

For selection of number to store the Inverter parameter setting data, press the  or  key to move the cursor and press the  key to fix.

After pressing the  key, you can select one of the following operations under Select data.



- 01: Read data (reads parameter setting data)
- 02: Read data+EzSQ (reads parameter setting data and a Drive Programming program)
- 03: Verify data (verifies parameter setting data)
- 04: Verify EzSQ (verifies a Drive Programming program)
- 05: Cancel (cancels the operation)

**Note** When the memory number 2, 3, or 4 is selected, the above three selection numbers (01, 03, and 05) are displayed.

Select "01: Read data" or "02: Read data+EzSQ" and press the  key to fix.

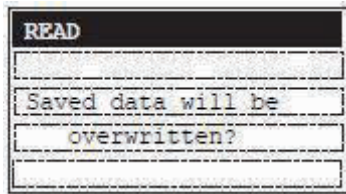
**Note** In the LCD Digital Operator, the Drive Programming is named as "EzSQ".



After pressing the  key, an overwriting confirmation message appears on the screen. To proceed, press the  key. To cancel, press the  key.

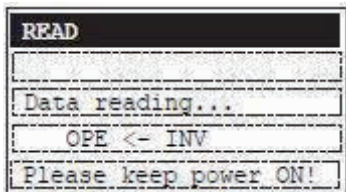

Completed

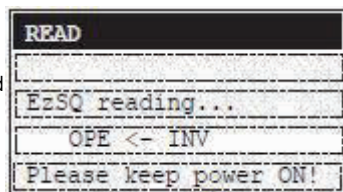

Completed

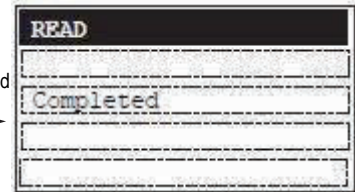

After 2 seconds

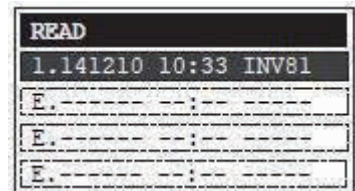

### Precautions for Correct Use

- The Quad READ function cannot be executed by pressing the  key in the Write Mode or Option Mode.  
Use this function in other modes.
- If the read data of a single set of Inverter parameter setting data or a Drive Programming program is stored in a specified memory number, the existing data stored in that specified memory number is overwritten.



**Note** In the LCD Digital Operator, the Drive Programming is named as “EzSQ”.

## 6-4 Quad VERIFY Function

The Quad VERIFY function is enabled when 5. R/W Storage Mode in the OPTION MODE menu is set to "02: Quad". The Quad VERIFY function provides the following operations.

- Verifies the read data of a single set of Inverter parameter setting data and the parameter data stored in a specified memory number.
- Verifies a read Drive Programming program and the program stored in the memory number 1.

Press the  key. When the READ screen appears, select the memory number to verify the data.

Press the  key. The Select Data is displayed. Select one of the following operations to execute and press the  key again.

- 03: Verify Data (verifies a single set of Inverter parameter setting data)
- 04: Verify EzSQ (verifies a Drive Programming program)
- 05: Cancel (cancels the verify operation)

When verification is completed, the result appears. Press the  key to return to the previous screen.

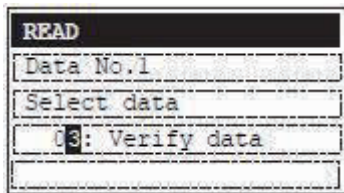
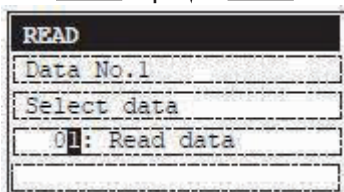
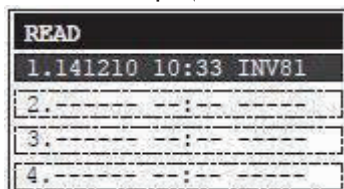
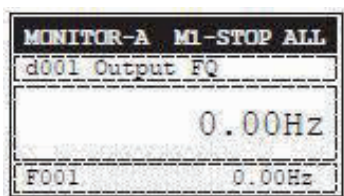

When no Inverter parameter setting data is stored in the LCD Digital Operator, "--" is shown.

For selection of number to store the Inverter parameter setting data, press the

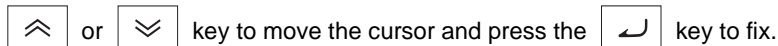

After pressing the  key, you can select one of the following operations under Select data.

- 01: Read data (reads parameter setting data)
- 02: Read data+EzSQ (reads parameter setting data and a Drive Programming program)
- 03: Verify data (verifies parameter setting data)
- 04: Verify EzSQ (verifies a Drive Programming program)
- 05: Cancel (cancels the operation)

**Note** When the memory number 2, 3, or 4 is selected, the above three selection numbers (01, 03, and 05) are displayed.

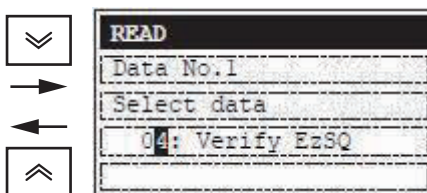

Select "03: Verify data" or "04: Verify EzSQ" and press the



key to fix.



**Note** In the LCD Digital Operator, the Drive Programming is named as "EzSQ".

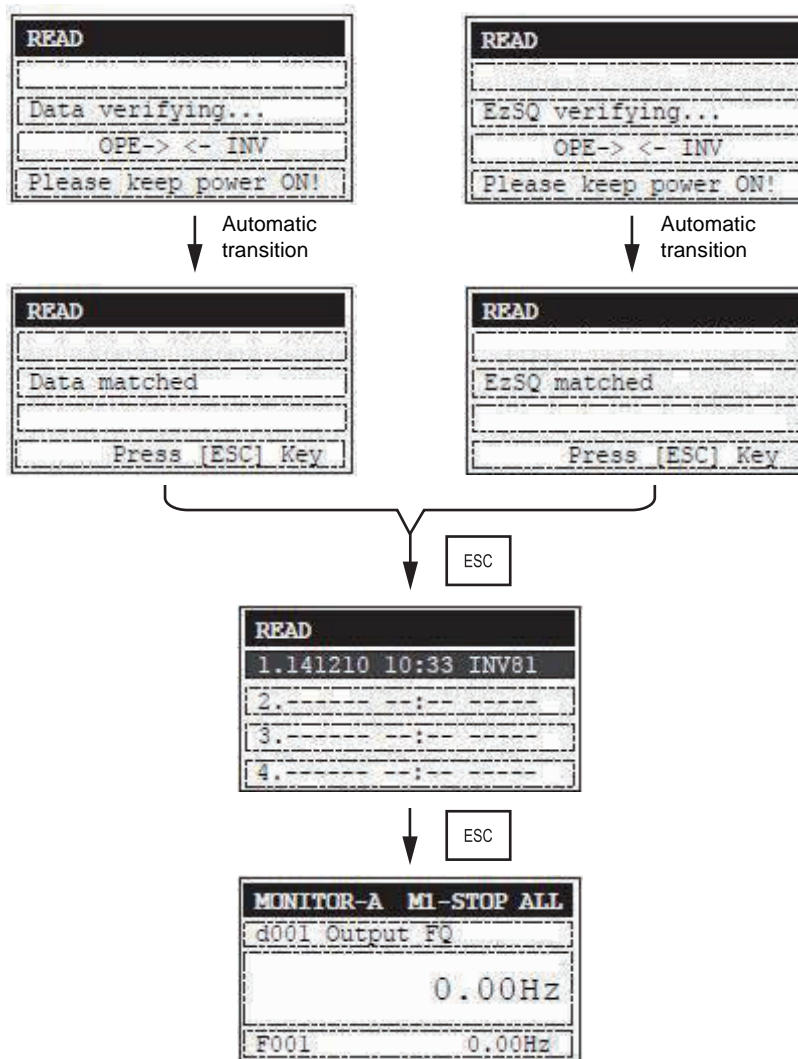

When the verification of the parameter setting data or Drive Programming program is completed, the result appears.

- Match: matched
- Unmatch: unmatched



### Precautions for Correct Use

- The Quad VERIFY function cannot be executed by pressing the **READ** key in the Write Mode or Option Mode.  
Use this function in other modes.
- In the following cases, the screen returns to the first display of the Quad READ when the Quad VERIFY cannot be executed.
  - 1) If the data to compare is not stored in the LCD Digital Operator.
  - 2) If the Drive Programming has a password set.

**Note** In the LCD Digital Operator, the Drive Programming is named as “EzSQ”.

## 6-5 Quad WRITE Function

The Quad WRITE function is enabled when 5. R/W Storage Mode in the OPTION MODE menu is set to "02: Quad".

The Quad WRITE function provides the following two operations.

- Writes a single set of all Inverter parameter setting data, which is stored in a specified memory number 1 to 4, to the connected Inverter.
- Writes a single set of all Inverter parameter setting data and a Drive Programming program, which are stored in the memory number 1, to the connected Inverter.

Press the  key. Select a memory number from 1 to 4 to write a set of Inverter parameter setting data stored in the LCD Digital Operator.

Press the  key. The Select Data is displayed. Select one of the following operations to execute and press the  key again.

01: Write data (writes a single set of all Inverter parameter setting data)

02: Write data+EzSQ (writes a single set of all Inverter parameter setting data and a single Drive Programming program)

03: Cancel (cancels the write operation)

When writing is completed, the screen returns to the previous screen.

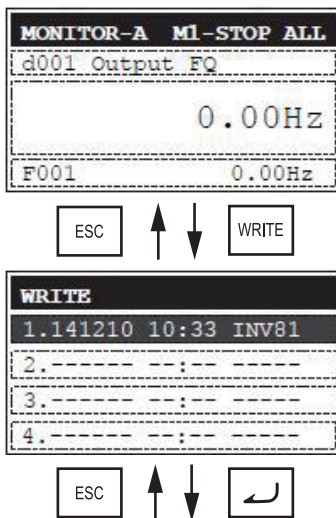

When no Inverter parameter setting data is stored in the LCD Digital Operator, "--" is shown.

For selection of number to store the Inverter parameter setting data, press the

 or  key to move the cursor and press the  key to fix.

**Note** In the LCD Digital Operator, the Drive Programming is named as "EzSQ".



After pressing the  key, you can select one of the following operations under Select data.

- 01: Write data (writes parameter setting data)
- 02: Write data+EzSQ (writes parameter setting data and a Drive Programming program)
- 03: Cancel (cancels the operation)

**Note** When the memory number 2, 3, or 4 is selected, the above selection numbers (01 and 03) are displayed.

**Note** If you select "02" when no Drive Programming program is stored in the memory number 1, the screen returns to the first display of Quad WRITE.



### Precautions for Correct Use

- The Quad WRITE function cannot be executed by pressing the  key in the Read Mode or Option Mode.  
Use this function in other modes.
- The Quad WRITE function is available only with Inverters of the same model and of the same version.  
If the all WRITE function does not work, check the Inverter models and versions and, if they are different, consider using the Inverter/Servo Parameter Support Tool CX-Drive.

**Note** In the LCD Digital Operator, the Drive Programming is named as "EzSQ".

## 6-6 Conditions for the Read/Write Operations

The read/write operations may not be executed depending on the state and setting of the Inverter. The operation conditions are shown below.

### ● Conditions for Read/Verify Operations (from Inverter to LCD Digital Operator)

Inverter state and setting	Parameter settings only	Parameter setting data and Drive Programming program
Inverter is running, Drive Programming program is running, writing disabled	Executable	Executable
Soft lock enabled in b031 (Soft Lock Selection)	Executable	Executable
Display restricted in b037 (Display Selection)	Executable	Executable
During password setting	Executable	Not executable
Read/Write-protected in b166 (Data Read/Write Selection)	Not executable	Not executable <sup>*1</sup>
Trip occurred	Executable	Executable

\*1 Only the verification of Drive Programming data is possible if "R/W protected" is selected in b166 (Data Read/Write Selection).

### ● Conditions for Write Operation (from LCD Digital Operator to Inverter)

Inverter state and setting	Parameter settings only	Parameter setting data and Drive Programming program
Inverter is running, Drive Programming program is running, writing disabled	Not executable	Not executable
Soft lock enabled in b031 (Soft Lock Selection)	Not executable	Not executable
Display restricted in b037 (Display Selection)	Executable	Executable
During password setting	Executable	Not executable
Read/Write-protected in b166 (Data Read/Write Selection)	Not executable	Not executable
Trip occurred	Not executable	Not executable





# Error Messages and Troubleshooting

---

This section describes the error messages and troubleshooting of the LCD Digital Operator.

---

<b>7-1 Error Messages and Remedies</b> .....	<b>7-2</b>
7-1-1 Inverter Error Messages .....	7-2
7-1-2 LCD Digital Operator Error Messages .....	7-2
<b>7-2 Troubleshooting</b> .....	<b>7-5</b>

# 7-1 Error Messages and Remedies

The error messages that appear on the LCD Digital Operator screen are categorized into the following three:

Inverter Trip

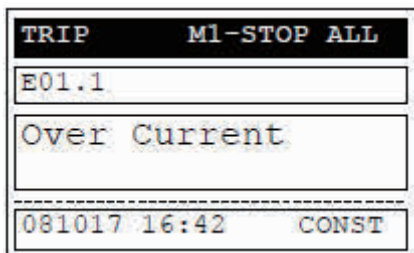

\* Screen flashes alternately in white and orange

Inverter Warning

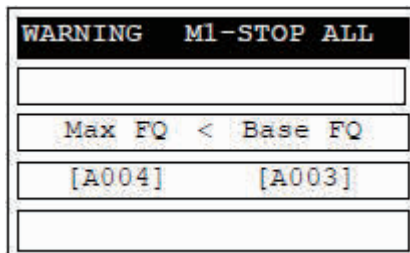

\* Screen is illuminated in orange

LCD Digital Operator Error

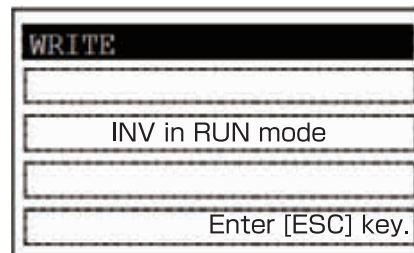

\* Screen remains in white

## 7-1-1 Inverter Error Messages

For details about Inverter errors (trip and warning), refer to RX (I560-E2), LX (I120E-EN) or MX2 (I570-E2) User's Manuals.

## 7-1-2 LCD Digital Operator Error Messages

Message	Cause	Check items	Remedies	Reset method
COM ERROR	<ul style="list-style-type: none"> <li>The LCD Digital Operator could not establish communications with the Inverter for 4 seconds or more.</li> </ul>	<ul style="list-style-type: none"> <li>The issue of the RESET signal continues for 5 seconds or more.</li> <li>The settings of the LCD Digital Operator and those of the connected Inverter are different.</li> <li>A connector is disconnected.</li> <li>The cable is broken.</li> </ul>	<ul style="list-style-type: none"> <li>Limit the issue of the RESET signal to less than 4 seconds.</li> <li>In the Option Mode, set the INV Type Select to "01: Type 1".</li> <li>Reconnect the cable appropriately.</li> <li>Replace the cable.</li> </ul>	Press the STOP/RESET key.

Message	Cause	Check items	Remedies	Reset method
INV in RUN mode	<ul style="list-style-type: none"> <li>An attempt was made to write parameter data during Inverter operation.</li> <li>The soft lock function is enabled.</li> <li>The Inverter data is read/write-protected.</li> <li>The Drive Programming is activated.</li> <li>The Drive Programming has a password set.</li> </ul>	<ul style="list-style-type: none"> <li>The WRITE key was pressed during Inverter operation.</li> <li>The soft lock function is enabled in b031 (Soft lock selection).</li> <li>The data is read/write-protected in b166 (Data Read/Write Selection).</li> <li>The start signal of the Drive Programming is ON.</li> <li>The Drive Programming has a password set.</li> </ul>	<ul style="list-style-type: none"> <li>Press the WRITE key when the Inverter is stopped.</li> <li>Disable the soft lock on the Inverter parameter data.</li> <li>Disable the read/write-protection.</li> <li>Stop the Drive Programming.</li> <li>Disable a password of the Drive Programming.</li> </ul>	Press the STOP/RESET key.
INV in TRIP mode	<ul style="list-style-type: none"> <li>An attempt was made to write parameter data during Inverter trip.</li> </ul>	<ul style="list-style-type: none"> <li>Check the state of the Inverter trip.</li> </ul>	<ul style="list-style-type: none"> <li>Remove the error cause of the Inverter trip and reset the Inverter.</li> </ul>	
INV Type Un-match	<ul style="list-style-type: none"> <li>An attempt was made to write all parameter data to a wrong Inverter.</li> </ul>	<ul style="list-style-type: none"> <li>Check the data to write and the connected Inverter model and version.</li> </ul>	<ul style="list-style-type: none"> <li>If the model or version does not match, use CX-Drive.</li> </ul>	
Read lock enabled	<ul style="list-style-type: none"> <li>The Inverter data is read/write-protected.</li> </ul>	<ul style="list-style-type: none"> <li>The data is read/write-protected in b166 (Data Read/Write Selection).</li> </ul>	<ul style="list-style-type: none"> <li>Disable the read/write protection.</li> </ul>	
Data Check Sum Error	<ul style="list-style-type: none"> <li>The EEPROM check data (checksum value) is abnormal.</li> <li>The EEPROM reached the maximum number of writes.</li> </ul>	<ul style="list-style-type: none"> <li>Turn OFF and then ON the power supply again to see if the value is reset to normal.</li> <li>In the Option Mode, execute the Operator Reset function to see if the value is reset to normal.</li> </ul>	<ul style="list-style-type: none"> <li>If the error cannot be cleared, replace the LCD Digital Operator.</li> </ul>	Turn OFF and then ON the power supply again. Or replace the LCD Digital Operator.
INV Check Sum Error	<ul style="list-style-type: none"> <li>The parameter data to write to the Inverter does not match that stored in the LCD Digital Operator.*1</li> </ul>	<ul style="list-style-type: none"> <li>Retry writing all the parameter data again.</li> </ul>	<ul style="list-style-type: none"> <li>If the error cannot be cleared by retrying after initializing the Inverter, consider replacing the Inverter.</li> </ul>	Consider replacing the Inverter.
EEPROM Error	<ul style="list-style-type: none"> <li>An EEPROM error occurred in the LCD Digital Operator.</li> </ul>	<ul style="list-style-type: none"> <li>Turn OFF and then ON the power supply again to see if the writing is possible.</li> </ul>	<ul style="list-style-type: none"> <li>If the copy function is required, replace the LCD Digital Operator.</li> </ul>	—
not support	<ul style="list-style-type: none"> <li>The Inverter is not supported.</li> </ul>	<ul style="list-style-type: none"> <li>Check the Inverter model.</li> </ul>	<ul style="list-style-type: none"> <li>Connect with a Inverter, or use CX-Drive.</li> </ul>	—

Message	Cause	Check items	Remedies	Reset method
Read & Copy only	<ul style="list-style-type: none"> <li>Writing to the Inverter is disabled.</li> </ul>	<ul style="list-style-type: none"> <li>In the Option Mode, set the INV Type Select to "01: Type 1".</li> <li>The soft lock function is enabled in b031 (Soft Lock Selection).</li> <li>The data is read/write-protected in b166 (Data Read/Write Selection).</li> </ul>	<ul style="list-style-type: none"> <li>Stop the Inverter and Drive Programming if they are running.</li> <li>Reset the trip state if the Inverter is tripped.</li> <li>Disable the soft lock function.</li> <li>Disable the read/write protection.</li> </ul>	Press the STOP/RESET key.
change the battery	<ul style="list-style-type: none"> <li>The built-in battery voltage dropped.</li> </ul>	<ul style="list-style-type: none"> <li>Check the current date and time in d031 (Current Time Monitor).</li> </ul>	<ul style="list-style-type: none"> <li>Replace the battery with a new one and set the date and time again.</li> </ul>	—
please set the clock <sup>*2</sup>	<ul style="list-style-type: none"> <li>The current date and time are not set.</li> </ul>	<ul style="list-style-type: none"> <li>The current date and time are not set by selecting Date and Time in the Option Mode.</li> <li>The date and time data cannot be backed up because the built-in battery voltage is completely dropped.</li> </ul>	<ul style="list-style-type: none"> <li>Perform the date and time setting.</li> <li>Replace the battery with a new one and set the date and time again.</li> </ul>	—

\*1 This may occur if an attempt is made to write data to an Inverter whose voltage class and capacity are different. For the troubleshooting of Inverter problems, refer to RX (I560-E2), LX (I120E-EN) or MX2 (I570-E2) User's Manuals.

\*2 The screen disappears automatically in 3 minutes after the power supply is turned on.

## 7-2 Troubleshooting

This section describes the troubleshooting of LCD Digital Operator problems.

For the troubleshooting of Inverter problems, please refer to RX (I560-E2), LX (I120E-EN) or MX2 (I570-E2) User's Manuals.

### No Data is Displayed on the Screen



## Key Operations are Ignored

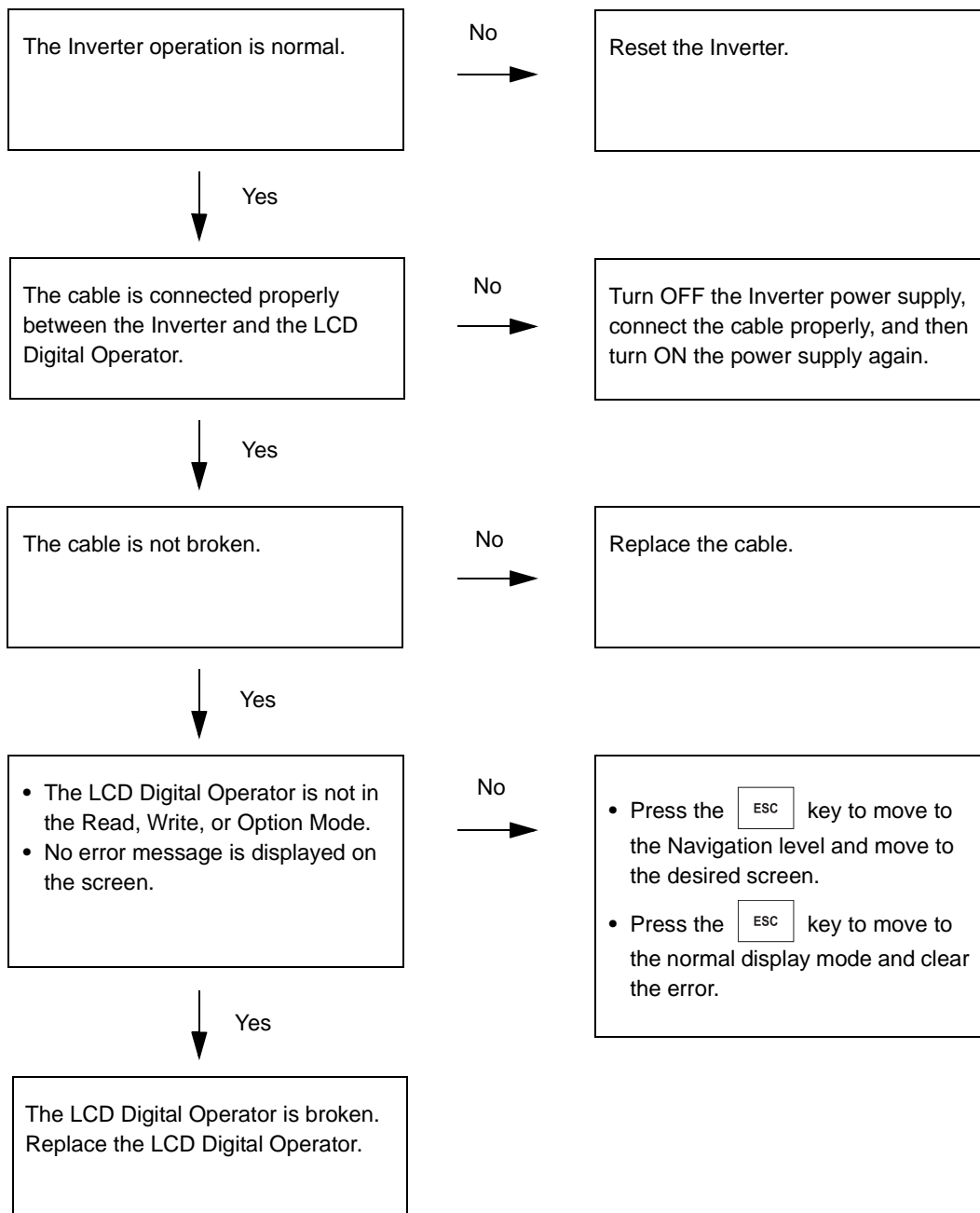

## LCD Digital Operator has a Dark Screen or Displays Unreadable Characters

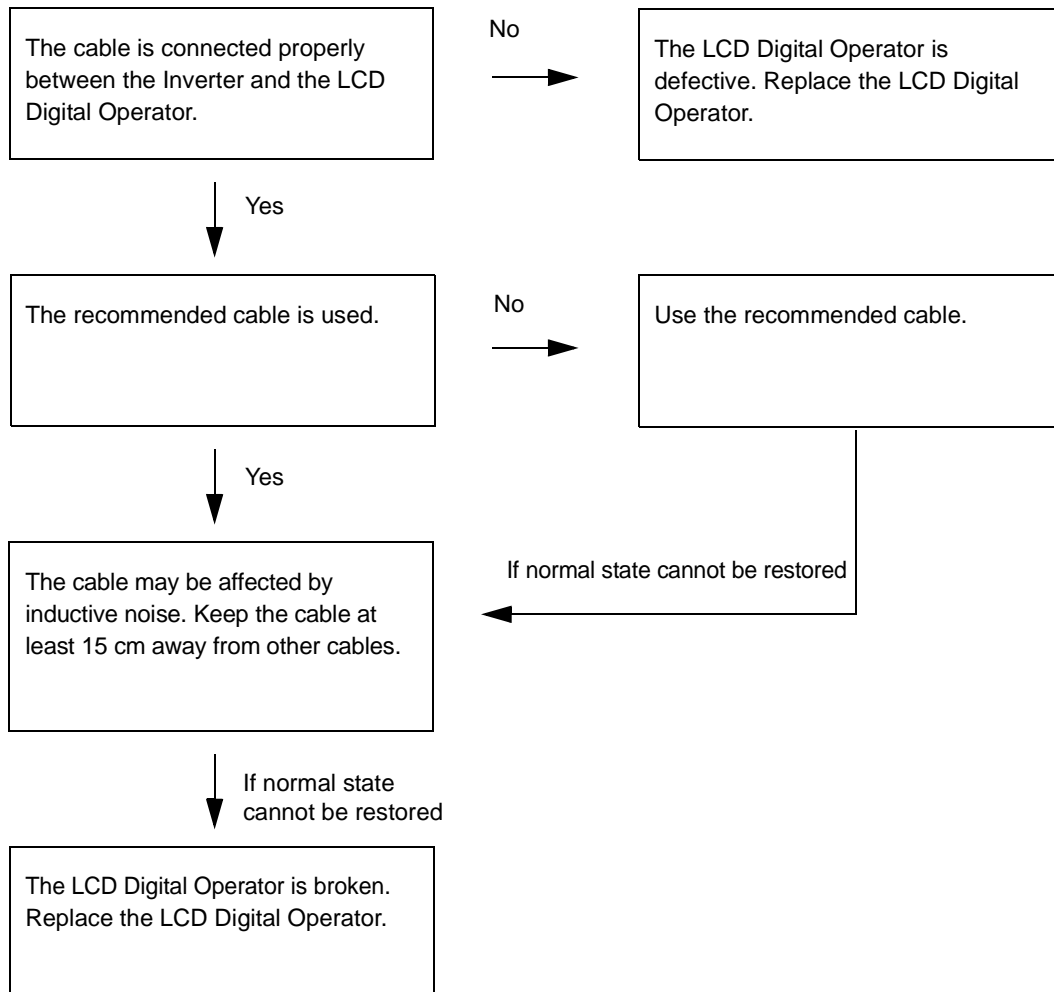







# Maintenance

---

This section provides information on the maintenance of the LCD Digital Operator.

---

<b>8-1</b>	<b>Battery Replacement</b> .....	<b>8-2</b>
------------	----------------------------------	------------

## 8-1 Battery Replacement

---

The LCD Digital Operator contains a battery, which is a service part. This built-in battery is used as a backup for the clock function of the LCD Digital Operator. Below is the procedure for replacing this part.

### Purpose of the Built-in Battery

---

This LCD Digital Operator has a built-in real time clock IC for the date and time information. When the external power supply is OFF, the power is supplied from this built-in battery to update the date and time information.

If the battery life expires, the date and time information is not updated when power supply to the LCD Digital Operator is OFF. In this case, the date and time information stored in the real time clock IC is reset to the default value (THU 00:00, January 1, 2009) when the power supply to the LCD Digital Operator is turned ON. Therefore, when you turn ON the LCD Digital Operator for the first time after purchase or battery replacement, set the correct time and date in the Option Mode. Otherwise, the LCD Digital Operator does not show the date and time information correctly in the Trip Mode, Read Mode, and Write Mode.

Except for the current date and time display, a battery voltage drop will not affect the normal operation of the LCD Digital Operator.



### Precautions for Safe Use

---

- If the clock command is used in Drive Programming, an unexpected operation may occur due to weak battery. Take measures such as detecting a weak battery by a check that the clock data returns to the initial setting and stopping the Inverter or programs. When the LCD Digital Operator is removed or disconnected, Drive Programming is in a waiting status by the clock command.
- 

### Battery Replacement Procedure

---

- 1** Turn OFF the Inverter power supply.
- 2** Remove the LCD Digital Operator from the Inverter, if installed on the Inverter.  
Disconnect the cable from the LCD Digital Operator, if connected via cable.

- 3** Remove the four screws located on the rear face of the LCD Digital Operator to disassemble the chassis.



- 4** Remove the old battery using a thin slotted screwdriver.



Be careful not to damage the PCB and its parts.

When disposing of the old battery, insulate it using such as tape according to the specified method to prevent short-circuit.

Type of replacement battery: Coin type lithium battery CR1220



- 5** Install a new battery, with attention paid to the positive and negative sides of the battery.
- 6** Reassemble the chassis by reversing the steps described in step 3.
- 7** Install or connect the LCD Digital Operator with the Inverter as before.
- 8** Turn ON the Inverter power supply and set the date and time on the LCD Digital Operator.



### Precautions for Safe Use

---

- When disposing of LCD digital operators and wasted batteries, follow the applicable ordinances of your local government.

When disposing of the battery, insulate it using tape.



廢電池請回收

The following display must be indicated when products using lithium primary batteries (with more than 6 ppb of perchlorate) are transport to or through the State of California, USA.

Perchlorate Material - special handling may apply.  
See [www.dtsc.ca.gov/hazardouswaste/perchlorate](http://www.dtsc.ca.gov/hazardouswaste/perchlorate)

The 3G3AX-OP05 has the lithium primary battery (with more than 6 ppb of perchlorate). Label or mark the above display on the exterior of all outer shipping packages of your products when exporting your products which the 3G3AX-OP05 are installed to the State of California, USA.

- Do not short + and -, charge, disassemble, heat, put into the fire, or apply strong impact on the battery. The battery may leak, explode, produce heat or fire. Never use the battery which was applied strong impact due to such as fall on the floor, it may leak.
  - UL standards establish that the battery shall be replaced by an expert engineer.  
The expert engineer must be in charge of the replacement and also replace the battery according to the method described in this manual.
  - When the display of LCD Digital Operator can not be recognized due to the service life, replace the LCD Digital Operator.
-



# Index

---

# Index

---

## B

---

Backlight ..... 2-6

## F

---

Function Mode ..... 4-4, 4-8

## M

---

Monitor Mode A ..... 4-3, 4-6

Monitor Mode B ..... 4-3, 4-7

## O

---

Option Mode ..... 4-5, 5-2

## P

---

Purpose of the Built-in Battery ..... 8-2

## R

---

Read Mode ..... 4-4

## T

---

Trip Mode ..... 4-4, 4-9

## W

---

wasted batteries ..... 8-4

Write Mode ..... 4-5



**OMRON Corporation Industrial Automation Company**

Tokyo, JAPAN

Contact: [www.ia.omron.com](http://www.ia.omron.com)

**Regional Headquarters**

OMRON EUROPE B.V.  
Wegalaan 67-69-2132 JD Hoofddorp  
The Netherlands  
Tel: (31)2356-81-300/Fax: (31)2356-81-388

OMRON ELECTRONICS LLC  
One Commerce Drive Schaumburg,  
IL 60173-5302 U.S.A.  
Tel: (1) 847-843-7900/Fax: (1) 847-843-7787

OMRON ASIA PACIFIC PTE. LTD.  
No. 438A Alexandra Road # 05-05/08 (Lobby 2),  
Alexandra Technopark,  
Singapore 119967  
Tel: (65) 6835-3011/Fax: (65) 6835-2711

OMRON (CHINA) CO., LTD.  
Room 2211, Bank of China Tower,  
200 Yin Cheng Zhong Road,  
PuDong New Area, Shanghai, 200120, China  
Tel: (86) 21-5037-2222/Fax: (86) 21-5037-2200

Authorized Distributor:

© OMRON Corporation 2013 All Rights Reserved.  
In the interest of product improvement,  
specifications are subject to change without notice.

Cat. No. I579-E2-01

0912