

Table of Contents

Contents

1.	Introduction	3
1.1	What's New in Version 4.X	3
1.2	Multi-Rack Changes	4
2.	Computer/Controller Requirements	4
2.1	The Computer	4
2.2	The Controller	4
3.	Installation	6
3.1	Changing the Editor's Directory	7
4.	Logic Control Relays	7
4.1	General	7
4.2	Control Relay Listing	7
4.3	Application Specific Modfiles	7
4.4	Multi-Chassis Addressing	8
5.	General Programming	10
6.	Running the Program	11
6.1	The Configuration Menu	12
6.1.1	Logic Files Directory	12
6.1.2	Copy/cut Capture Directory	12
6.1.3	MACO Compiler Version Entry	13
6.1.4	Output Designator Entry	15
6.1.5	Transfer Options	15
7.	The Label Editor	16
7.1	Creating a Labels File	16
7.2	Editing a Labels File	20
7.3	Outputting a Labels File	22
7.3.1	Using Output to CRT or Printer	22
7.3.2	Using Output to File	24
7.3.3	Printing using the LABEL.PRN File	26
8.	The Logic (RLD) Editor	27
8.1	Introduction	27
8.2	Creating a Relay Ladder Diagram	27
8.3	Editing a Relay Ladder Diagram	31
8.4	The RLD Text Editor (F6)	33
8.5	Compiling the RLD	34
9.	Outputting the RLD	37
9.1	Using Output to CRT or Printer	37
9.2	Using Output to File	39
9.3	Printing using the LOGIC.PRN File	40
10.	Transferring (Downloading) to the Controller	44
10.1	General	44
10.2	Procedure	44
11.	Transferring (Downloading) to a Cartridge	44
12.	Transferring (Downloading) to a Multi-rack System (Alpha Systems)	45

Figures

Figure 1.	A System Overview	5
Figure 2.	The Chexedir Menu Screen	6
Figure 3.1	Counting Instructions	10
Figure 3.2	The Main Menu	11

Figures (continued)

Figure 4.	The Configuration Menu Screen	12
Figure 5.	The Version 02 Compiler Screen	13
Figure 6.	The Version 03 Compiler Screen	13
Figure 7.	The Version 03A Compiler Screen	14
Figure 8.	The MACO 8000 Compiler Screen	14
Figure 9.	Labels Editor Screen	17
Figure 10.1	Labels Editor Symbols (Test Instructions)	18
Figure 10.2	Labels Editor Symbols (Coils)	19
Figure 11.	Labels File Printout (using Output Designator "1")	25
Figure 12.	Two Rungs Cannot Share the Same Line	29
Figure 13.	Logic Can Only Run Left to Right through Contacts	30
Figure 14.	Text Editor Screen	34
Figure 15.	Sample RLD with Text	41
Figure 16.	Cross Reference File Printout	42
Figure 17.	MACO 4000/5000/6000 Series Transfer Screens	43
Figure 18.	MACO 8000 Series Transfer Screens	43
Figure 19.	Communications Cable Assemblies	46
Figure 20.	Downloading the Sequence Logic Program	47

1. Introduction

The RLD (Relay Ladder Diagram) Editor and the OptiGrafix™ Screen Editor are the "tools" used to create a custom control system utilizing MACO products. The RLD editor is used to create the sequence logic used by the controller. The screen editor is used to create the screens used by the machine operator.

Sequence logic is the means by which information is passed from card to card and control is achieved. Sequence logic programming is performed using a personal computer and this program. The program was developed specifically for MACO sequence logic and contains all of the subsidiary programs necessary to create, edit, compile, and transfer the logic to the control system.

1.1 What's New in Version 4.X

The MACO RLD Editor Version 4.X was introduced in order to add new features and support multi-chassis RLD editing. The new features include:

Install program - all software files are now installed onto the system hard drive via the RLD enhanced editor installation program.

Harddisk residency - the program now installs onto the system hard disk drive.

Color Display - numerous screens within the program are now displayed in color.

Configuration Menu - addition of a menu enabling the user to modify the logic files (RLD) directory, the copy/cut files directory, the controller type, and the destination of any output created (note that any directories to be used must first be created using DOS).

Change Executable Directory Utility - change the directory specification pointing to where the executable files reside on the system hard disk (used when installing to other than the default (MACOSYS) directory).

Logic Editor modifications - modifications to the logic editor portion of the program are as follows:

- Auto Energize Coil Insert - allows the user to automatically enter an energize coil at the last position of the current rung.
- Select Logic - by utilizing the F7 function key, the user identifies the logic rungs to be manipulated.
- Full Function copy to buffer/copy to file - once the desired logic rungs are selected using the F7 function key, the user will then have the option of copying the selected logic to a data buffer or to a file whose name is defined by the user.
- Full Function cut to buffer/cut to file - once the desired logic rungs are selected using the F7 function key, the user will then have the option of copying the selected logic to a data buffer or to a file whose name is defined by the user.
- Full Function paste from buffer/paste from file - once the user defines the area in the relay ladder diagram using the F7 function key, the user will then have the option of pasting previously copied or cut logic into the current logic rung position from either a data buffer or from a file named by the user.
- Force full logic rung manipulation - through the use of the logic rung selection process (function key F7), the user is forced by the software to perform operations on only full rungs of logic.

- Warn of Multiple Device Outputs on a Logic Rung - force only one device output to be present on any single logic rung.
- Multi-page Editor Operations - the user can perform cut/copy/paste operations across several display screens of RLD logic.
- Multi Controller Type Compiler Support - program supports the entire line of MACO™ controllers and their compilation processes.
- Precompilation Logic Validity Checking - prior to the compilation process, a validity check is performed on all logic devices in the relay ladder diagram.
- Warn of Multiple Energize Coils at Compilation - prior to compilation, a check for multiple (same address) energize coils in the RLD is performed.
- Additional Timer Support in V2 - version two compiler now supports an additional 16 sequence timers.
- Printout Modification - hard copy output format modifications in several areas.
- File output of defined label table - labels now output to a file format.
- Support for the Accel/Decel (EZ PRO) board (RLD V4.7).

1.2 Multi-Rack Changes

Some menu items have been changed in order to make it easier to identify exactly which version of the "compiler" to use when compiling RLD. Changes were made to the configuration menu, which now contains a more definite means of identifying the compiler to be used, and text screens were added which explain each of the different compilers available.

2. Computer/Controller Requirements

2.1 The Computer

The program software is designed to operate on a DOS based computer. The minimum requirements are:

- 3-1/2" Disk Drive
- MS DOS 5.0 or greater (The RLD Editor has NOT been thoroughly tested with Windows. We suggest running the RLD Editor from DOS.)
- 640K Memory
- Color Graphics Monitor Adapter (not applicable for "Notebooks")
- Asynchronous Communications Adapter (RS-232C Interface)
- Printer Adapter Card (Parallel Port)
- Color Display (not applicable for "Notebooks")
- Graphics Printer (Epson FX with Downloadable Character Set or compatible)
- Minimum of 5M bytes of Hard Disk space available

2.2 The Controller

The controller must have a communications card with an RS232 port in order to download the program into the controller. In addition, an RS232 cable is needed to connect the computer to the controller.

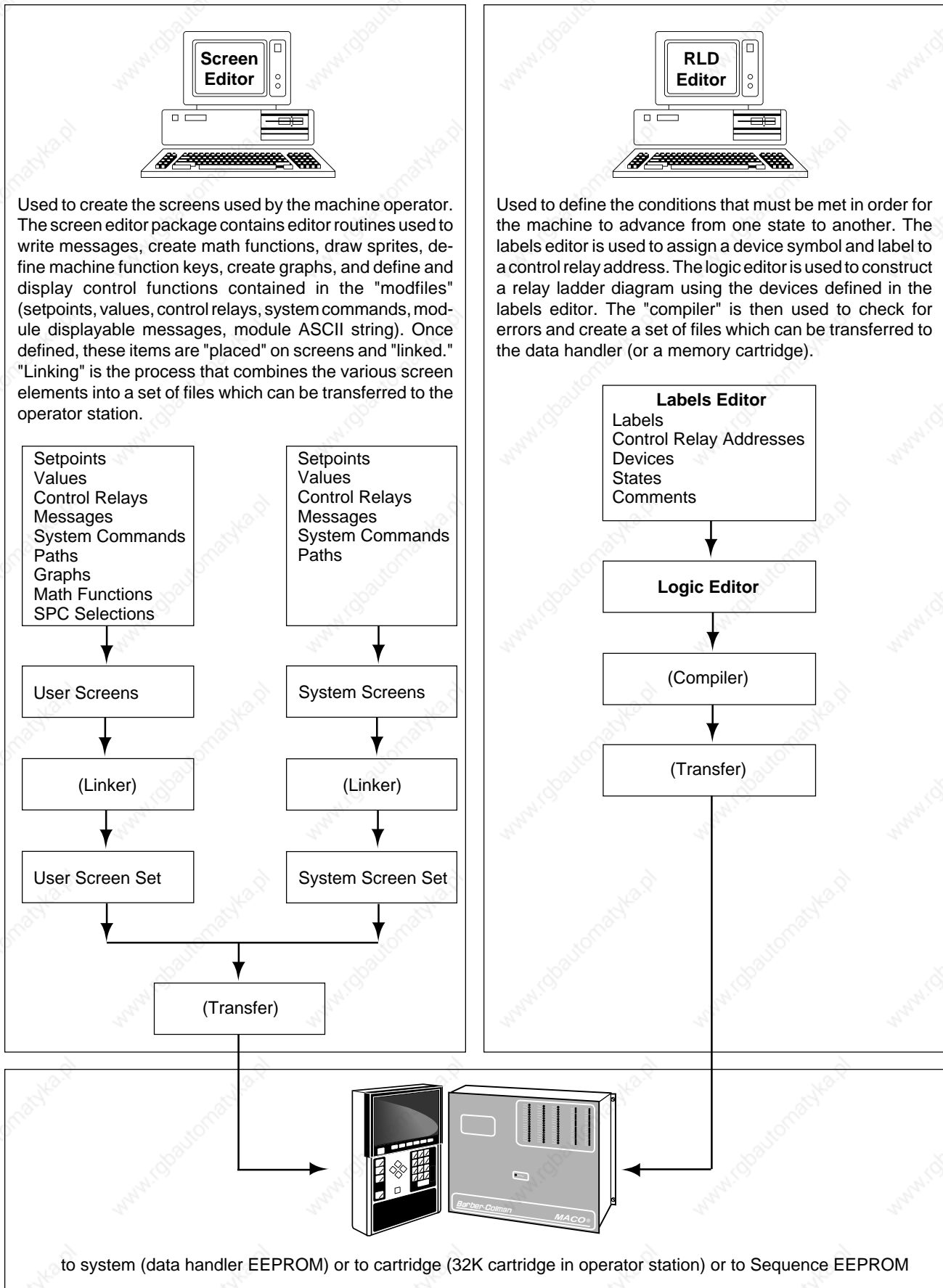

Figure 1. A System Overview

3. Installation

IMPORTANT: Before beginning the installation procedure, make a backup copy of the program disk ("XCOPY") and store it in an appropriate place.

For the sake of this description, the hard drive will always be simply the "C" drive and the floppy drive will always be the "A" drive. Insert the program disk into Drive A. Access Drive A and then type:

INSTALL (return)

The install routine will create a subdirectory named "MACOSYS" on the hard drive and install the program files in that subdirectory.

Note that only one program (the major files are LABELS.IN, TEXT.IN, LABELCMT.IN, and LOGIC.IN) can be stored in a single subdirectory. If additional programs are created, they must be stored in separate subdirectories. If multiple programs do exist, it will be necessary to change the logic files directory (see "Configuration" under "Running the Program") each time a different program is to be edited.

Once the install routine is executed, the computer will return to the MACOSYS directory. If this directory is satisfactory, the editor is now ready for operation.

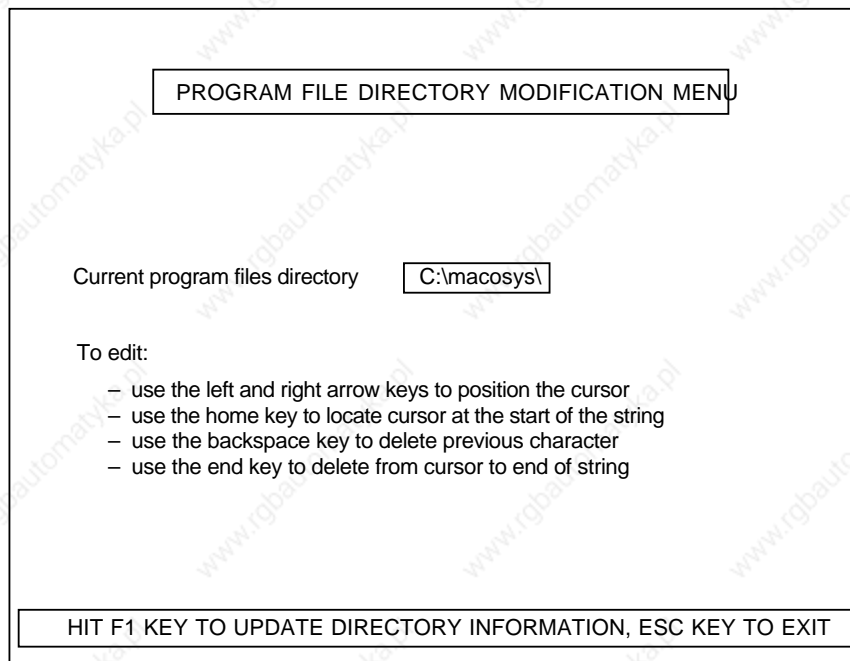

Figure 2. The Chexedir Menu Screen

3.1 Changing the Editor's Directory

Note that if the editor is to be operated from the MACOSYS directory (as installed), it is NOT necessary to use this routine.

If the default installation (or directory name) is not acceptable, consult your DOS manual for renaming or relocating the directory. Once the directory has been renamed or moved, the "CHEXEDIR" routine must be used to redefine the "path" to the executable files.

From the directory containing the installed files, type:

```
CHEXEDIR (return)
```

The menu in Figure 2 will appear. Follow the directions given on the screen and make certain the entire path (from the root directory to the editor) is shown. Once the proper directory has been entered, press "F1" to exit and save the changes.

4. Logic Control Relays

4.1 General

Sequence logic is contained in EEPROM (Electrically Erasable Programmable Read Only Memory). The logic contains the conditions that must be met in order for the machine to advance from one state to another. The program is an electronic version of a relay ladder diagram, including contacts, timers, switches, counters.

This stored, fixed program is continuously compared to the actual state of inputs, outputs, timers, etc., and decisions are made based on the comparisons. In order to build the logic to make the comparisons, it must be possible to communicate with specific addressable locations. "Addressable locations" means that each location is assigned a specific function and location number.

These locations mimic the function of electromechanical control relays. Like electromechanical relays, they are either on or off. Unlike electromechanical relays, they can assume an infinite number of contacts, which means they can be used in the logic program as many times as necessary in either the on or off state. The on or off state of each individual control relay is controlled by the state of an input, an operator panel function, the logic program, or process conditions.

4.2 Control Relay Listing

Each subsection of this manual contains a listing of the control relays within that function, along with a detailed description of their operation and use. In addition, at the end of this manual, there is a complete list of all control relays and their system addresses.

4.3 Application Specific Modfiles

With the addition of MACO 5000 Series controllers (for extrusion), it became helpful to rename many of the control functions originally included in the hydraulic modfile. These renamed functions are more generic in nature and are aimed at extrusion and blow molding applications. This more generic version of the hydraulic modfile is labeled the "Analog I/O" modfile and should be used in place of the hydraulic modfile for extrusion and blow molding applications. When choosing modfiles (from the OptiGrafix™ Screen Editor program), choose the modfiles directory that corresponds with the application type, i.e., "INJMOD" for injection; "EXTMOD" for extrusion; and "BLOWMOD" for blow molding.

Refer to the Alternative Modfile Description column in the Control Relay Tables.

4.4 Multi-Chassis Addressing

Each controller of a multi-chassis system has its own set of control relay system addresses as follows:

Controller No. 1 ("Primary")	1 to 10,000
Controller No. 2	10,001 to 20,000
Controller No. 3	20,001 to 30,000
Controller No. 4	30,001 to 40,000

The addresses referred to in this manual are those of a primary controller. Depending on which "secondary" controller is being programmed, just add 10,000 (20,000 or 30,000) to the primary controller address. Almost all control relays repeat in a multi-chassis system. The few exceptions relate to recipes or some SPC items (data handler modfile), print CR's or switch LED CR's (sequence modfile), as well as the status CR's from the display processor, data handler, RS-232 communications, and RS-485 communications modfiles.

Refer to the control relay tables for a complete list of control relays. The table contains a column headed "Multi-Chassis Addressing?" Those control relays which have a "yes" entry in that column can be written into the RLD if a multi-chassis system is being utilized. With the exception of control relay addressing, multi-chassis operation is transparent to the RLD. All downloading and recipe storage is to Controller 1. "Enabling" relays which relate to system operation (recipe saving and reading, setpoint change, etc.) are in Controller 1.

IMPORTANT: There is a group of sequence control relays (addresses 604-607) relating to the number of digital I/O cards in a controller and high density I/O cards which must be properly energized for each controller of a multi-rack system. These CR's must be energized for EACH of the controllers (the addresses for Controller No. 2 would be 10604-10607, etc.). Note that the controllers in a multi-rack system do NOT have to be all of the same type (e.g., 12-Slot and 16-Slot systems can be combined; different numbers of digital I/O can be combined; high density systems and low density systems can be combined).

The "Other Racks are Optional" control relay (data handler modfile, system address 658) is used in multi-rack systems to allow a rack to operate independently of others. If this control relay is off, the other racks in the system are required. If this control relay is on, the other racks in the system are optional. The control relay can be applied to either the primary or secondary racks of a multi-chassis system. When used in a primary rack, it denotes whether the secondary racks are required. When used in a secondary rack, it denotes whether the primary rack is required. These CR's would be used in the circumstance where all of the functions necessary to run the machine were in Controller No. 1 and all of the optional features were located in the other rack (e.g., extra mold temperature control). In this case, CR 658 would be turned on so that the machine could cycle without the second rack being present. A controller can thus continue to operate even if there is a critical failure in the other controller. For example, if there was a failure in the communications between racks or a failure of one of the racks, the status CR's passed from one controller to the other would not change, but would remain at their last transferred status.

If it is necessary for functions and I/O for machine motion to be in both Controller No. 1 and Controller No. 2, the machine would not be able to function without the second controller. In this case, CR 658 would not be turned on. The system would be disabled (timeslot would go down) if the system is powered up without the second controller. Both controllers will go down if there is a critical failure in either controller.

General Programming using the RLD Editor

The "Racks Not Present" control relay (data handler modfile, system address 819) is used to indicate the multi-rack link status. It will be off if the multi-rack link is operating and will be on if the multi-rack link is not operating. This CR can be applied to both primary and secondary racks and can be used in the sequence logic to disable/enable portions of the logic that might be interrelated with the logic in a particular rack.

Control relay 10819 (and 20819 and 30819) will be turned on at powerup. They will remain on until the primary controller comes up. Once Rack-to-Rack (RTR) timeslot communication is established, CR 10819 (and 20819 and 30819) will turn off. If communication with the primary controller is lost or if there is a critical failure in the primary and timeslot goes down, this CR will turn on within one (1) second.

Note: When counting boards in multi-rack systems (for switch settings, RLD/ screen programming) count each control rack separately. For example, if a multi-rack system consisted of two control racks, each with two temperature boards, EACH controller would have a Temperature Board #1 and a Temperature Board #2. The same numbering scheme holds true for all types of boards (including Input and Output boards).

5. General Programming

The program is divided into two parts, a Label Editor and a Logic Editor. The Label Editor is used to enter every control relay address that is to be used in the logic, define its logic symbol (relay coil or contact, timer, switch, etc.) and give it a name. The Logic Editor is used to draw the relay ladder diagram (RLD) using the devices defined in the Label Editor.

While using the Logic Editor to draw the logic diagram, type in the assigned label, press enter and the appropriate symbol will appear. The symbol can then be changed to represent a normally open or normally closed contact. In addition to the Logic file and Labels file, there is a label comments file and a text file to assist in documenting the logic.

The maximum RLD size will depend on the controller (check the model number):

12-slot Injection (40BX)	4000 instructions
12-slot Injection (42XX)	2000 or 4000 instructions
16-slot Injection (45XX)	4000 or more instructions
12-slot Extrusion (50BX)	1000 or 2000 instructions
16-slot Extrusion (55XX)	4000 or more instructions
16-slot Blowmolding (65XX)	4000 or more instructions

Each device (including OR nodes) in a path across a rung of logic counts as an instruction (see Figure 3.1).

Note that because of differences in individual RLD files, it is not possible to determine EXACTLY how many instructions are possible for a given system.

For Version 2 and 3 Compilers multiply the above number by eight and add 96. The result will approximately equal the maximum file size (for example, with 4000 instructions, the maximum file size would be approximately 32,096 bytes).

For Version 3A and later Compilers multiply the above number by six (for example, 5333 instructions would result in a file size of approximately 31,998 bytes, still less than the maximum of 32,096 bytes).

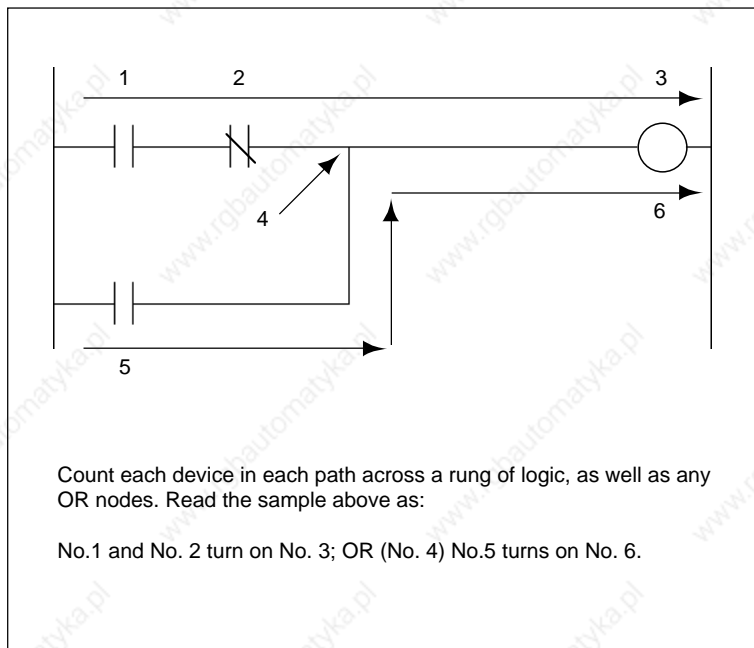

Figure 3.1 Counting Instructions

6. Running the Program

From the directory in which the program is stored, type:

MACORLD (return)

Checksum verifications are performed at powerup. During this process a screen is displayed that provides the serial number and software numbers for the disk. Refer to these numbers when communicating with Barber-Colman personnel. If the checksum test fails, it indicates that 1) the CHEXEDIR is not set to the correct path to the executable files directory, 2) there is a file that is corrupted, or 3) a file is incorrect or missing. Check the CHEXEDIR for the proper subdirectory containing the executable program files or contact your local Barber-Colman representative for repair or replacement of the faulty disk. Once the checksum is successfully performed, the main menu will appear.

Use the up and down arrows to move the cursor and use the page down or return key to activate the selection. "Exit" returns the computer to DOS.

Before any other work is performed, check the Configuration to see that both the logic files directory and MACO Series Controller setting are properly set (the current settings are displayed in the lower left corner of the main menu pictured above). Configuration also needs to be checked to see whether the output setting goes to File or Printer (see next page).

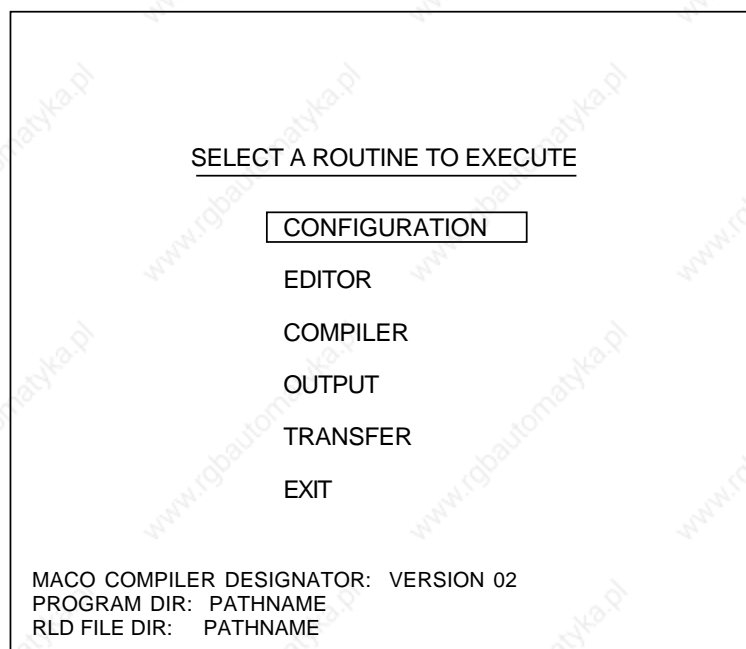

Figure 3.2 The Main Menu

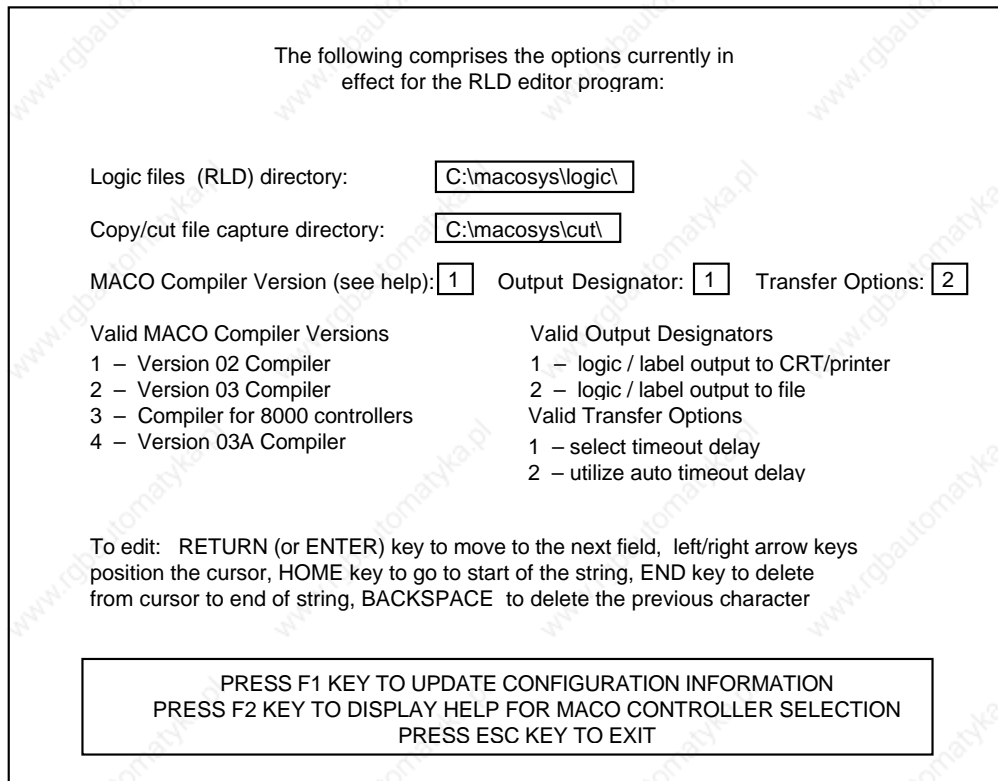

Figure 4. The Configuration Menu Screen

IMPORTANT: *before opening, editing, or saving a file, make certain the logic file directory setting is pointing to the correct sub-directory.*

6.1 The Configuration Menu

From the main menu, use the arrow keys to position the reverse video cursor over "Configuration" and press return. The screen shown in Figure 4 will appear.

6.1.1 Logic Files Directory

At installation, the path to the (potential) logic file is defaulted to the path created by the install routine. **Do not put Logic files in the same sub-directory as the executable files.** Use DOS to create a subdirectory and then configure for that sub-directory. If more than one logic file is needed (which is probably the case), then each of the logic files will require its own sub-directory.

IMPORTANT: If multiple logic files exist, before opening, editing, or saving a file, make certain the logic file directory setting is pointing **to the correct sub-directory.**

When opening an RLD file, the logic files (RLD) directory setting determines which RLD file will be opened. When saving, the logic files (RLD) directory setting determines the directory to which the file will be saved. Follow the directions on the screen and make certain the entire path (from the root directory to the file) is shown.

6.1.2 Copy/cut Capture Directory

This setting determines the directory setting for the copy/cut function described in "Editing a Relay Ladder Diagram." The default setting is the path created by the install routine (in most cases it should be left to match the logic files directory path). Follow the directions on the screen and make certain the entire path (from the root directory to the file) is shown.

6.1.3 MACO Compiler Version Entry

The MACO compiler version entry determines which version of the executable file is used to create the logic. In most cases this entry can be set and forgotten.

Press F2 from the Configuration Menu to bring up the Compiler Menu. From the Compiler Menu, a Help screen is available for each compiler. Examine the screens carefully to determine which compiler to use and then return to the Configuration Menu and enter the number of the correct choice (refer to Figures 5-8).

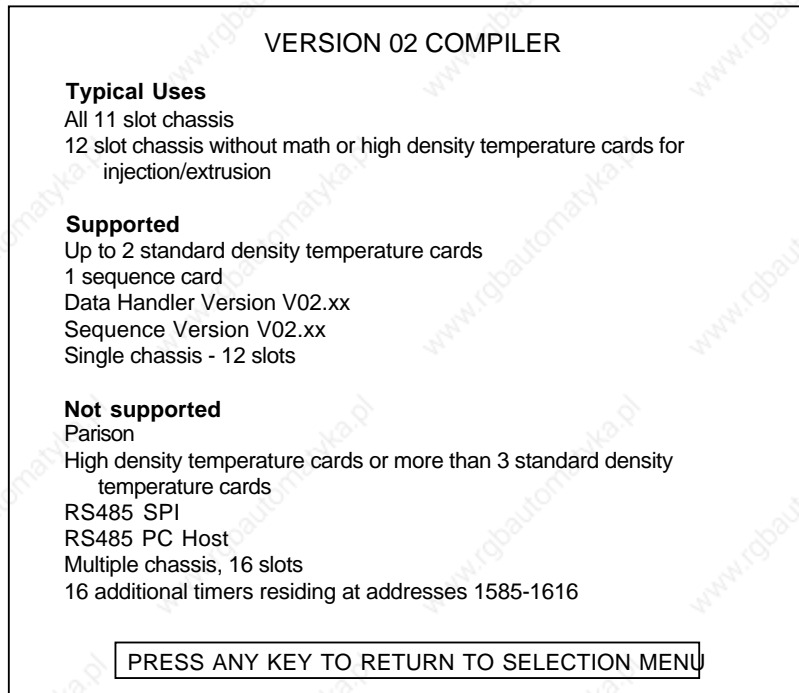

Figure 5. The Version 02 Compiler Screen

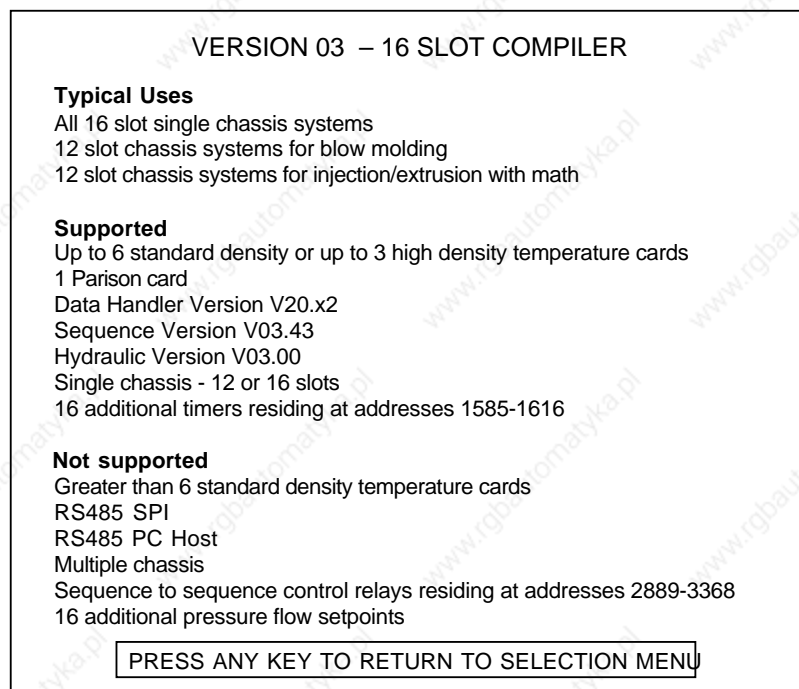

Figure 6. The Version 03 Compiler Screen

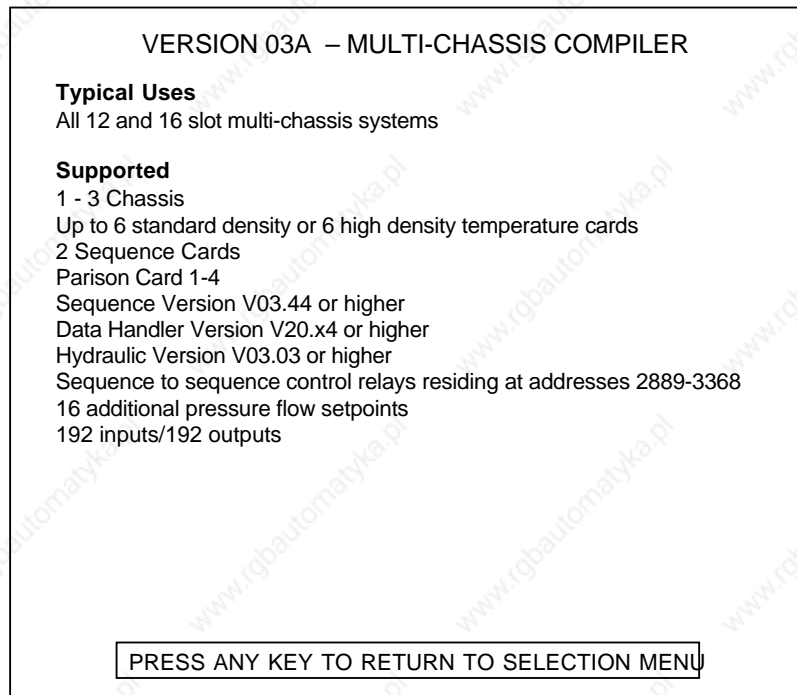

Figure 7. The Version 03A Compiler Screen



Figure 8. The MACO 8000 Compiler Screen

6.1.4 Output Designator Entry

The output designator allows the user to output the labels and logic to an ASCII file which can then be edited using common editors or word processing programs and then printed using a wide variety of printers. This entry determines where the files will output.

Use "1" to examine the file on the CRT or to print the file using a printer that utilizes downloadable fonts. This setting is comparable to "old" versions of the editor.

Use "2" to write the logic file and label file to two respective text files (LOGIC.PRN and LABEL.PRN) which can then be edited using common text editors and then archived or printed on a wide variety of printers.

Note that the logic CANNOT be edited in this manner (there is no means of re-converting this text file into a workable logic file).

Once the directory, controller type and output designator have been entered, press "F1" to exit and save the changes. The changes will be stored in an MCP.OPT file (the file is stored both in the program directory where the executable files are stored and in the sub-directory where the logic files will be). The program will exit to DOS. As prompted, type MACORLD (return) to re-enter the program.

6.1.5 Transfer Options

The transfer options selection was added in Version 4.7 of the editor and allows the user either to set the timeout delay manually (as in older versions of the editor) or to have it set automatically (the new default). The only reason for using the old method is if for some reason the new auto timeout causes problems.

7. The Label Editor

7.1 Creating a Labels File

From the main menu select EDITOR and press return.

```
SELECT A ROUTINE TO EXECUTE

CONFIGURATION
EDITOR
COMPILER
OUTPUT
TRANSFER
EXIT

MACO COMPILER DESIGNATOR: VERSION 02
PROGRAM DIR:  PATHNAME
RLD FILE DIR:  PATHNAME
```

The editor menu will appear. Select EDIT LABELS and press return.

```
SELECT EDITOR TO BE EXECUTED

EDIT LOGIC
EDIT LABELS
EXIT
```

NOTE: If this is the initial Labels file, EXISTING LABELS will not appear.

IMPORTANT: Selecting **BLANK FILE** when a Labels file or Logic file already exists will **DELETE** those files and the existing work will be lost!

```
SELECT THE LABEL SOURCE FILE

EXISTING LABELS
BLANK FILE
ABORT EDIT
```

General Programming using the RLD Editor

Make the proper selection and press return. The screen shown in Figure 9 will appear. This is the screen that is used to define Labels, Addresses, Device symbols and State symbols. They will appear as defined when the logic diagram is drawn. The top of the screen shows the logic symbols which can be assigned. The columns on the lower portion are where data is to be entered.

The following reference material is needed in order to make the definitions: a) control relay address tables, b) definition of the logic symbols, and c) a sketch of the machine logic or other written documentation showing the logic configuration. An explanation of the data entry is provided in the following paragraphs. To save time creating the Labels file, either mark up an existing logic diagram with the appropriate addresses or write out the Label file to be entered.

LABEL

When a Blank File is first opened, the Label Editor will be in the "insert" mode (INSERT ON will be displayed in the lower right corner). A seven character maximum label can be entered. **The first character must be a letter.** (If a number is used, the compiler will use that number as the address, regardless of the alpha characters following the number.) The rest of the characters can be a combination of letters (case sensitive) and numbers. Type in the desired label and press the return key. The brackets will shift to the address column.

If there is a typing error, make the corrections prior to pressing the return key. The F1 and F2 keys move the cursor and the F3 and F4 keys are used to insert and delete characters. If the return key has already been pressed and the brackets have moved to the next column, continue on and make all corrections when the table is edited. If a previously defined label is entered, when the return key is

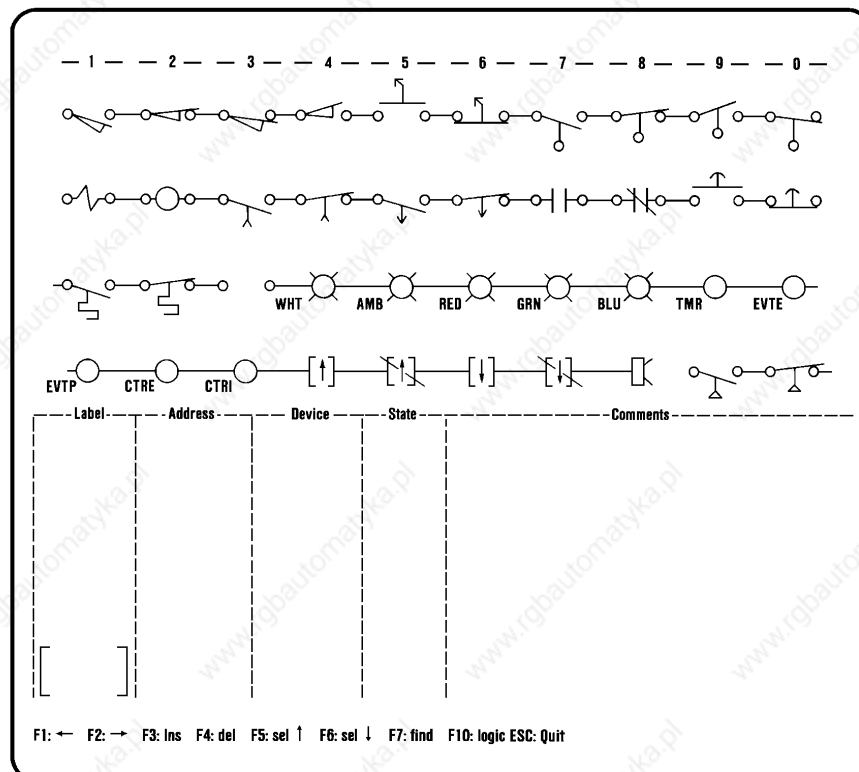

Figure 9. Labels Editor Screen

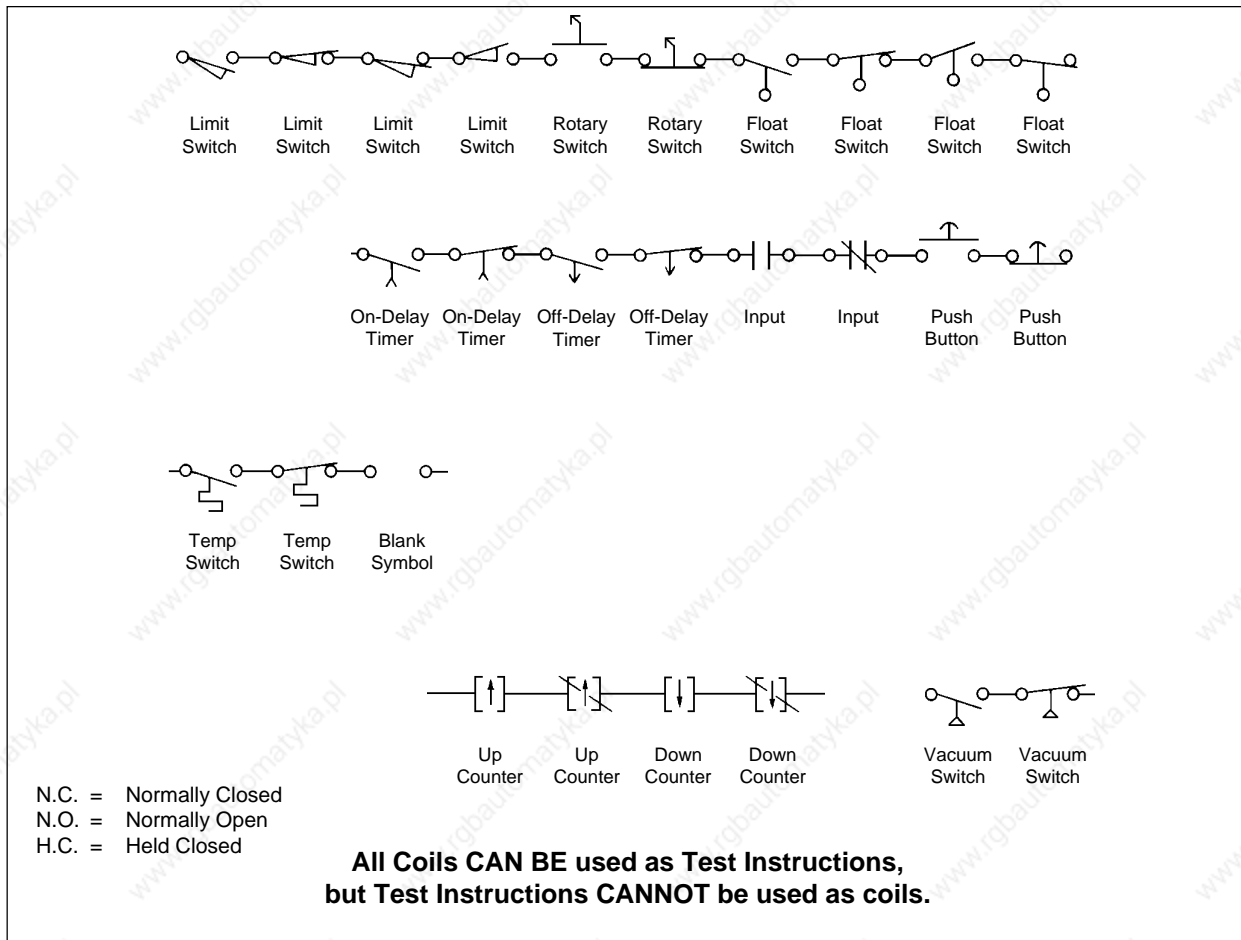

Figure 10.1 Labels Editor Symbols (Test Instructions)

pressed the computer will beep and the message "Error: This device is already defined" will appear. Press the return key and the brackets will move to the address column. Press the return key again and the brackets will move back to the label column. Key in the correct label.

ADDRESS

Addresses are listed in the control relay tables as "system addresses." Key in the address and press the return key. The brackets will shift to the device column. Addresses can be changed prior to pressing the return key or when a final edit is made. Even though it is possible to use the same address for different labels, the practice should be avoided.

DEVICE

This column is used to assign a graphic symbol to the device. The graphic symbol choices are shown at the top of the screen. An explanation of each choice is provided in Figures 10.1 and 10.2. A device should be thought of as either a "Test Instruction" or a "Coil." All Coils CAN BE used as Test Instructions, but Test Instructions CANNOT be used as coils.

CAUTION: For safety reasons, use ONLY the Normally Open (N.O.) symbol when entering the device. The Normally Closed (N.C.) symbol will be available in the logic editor.

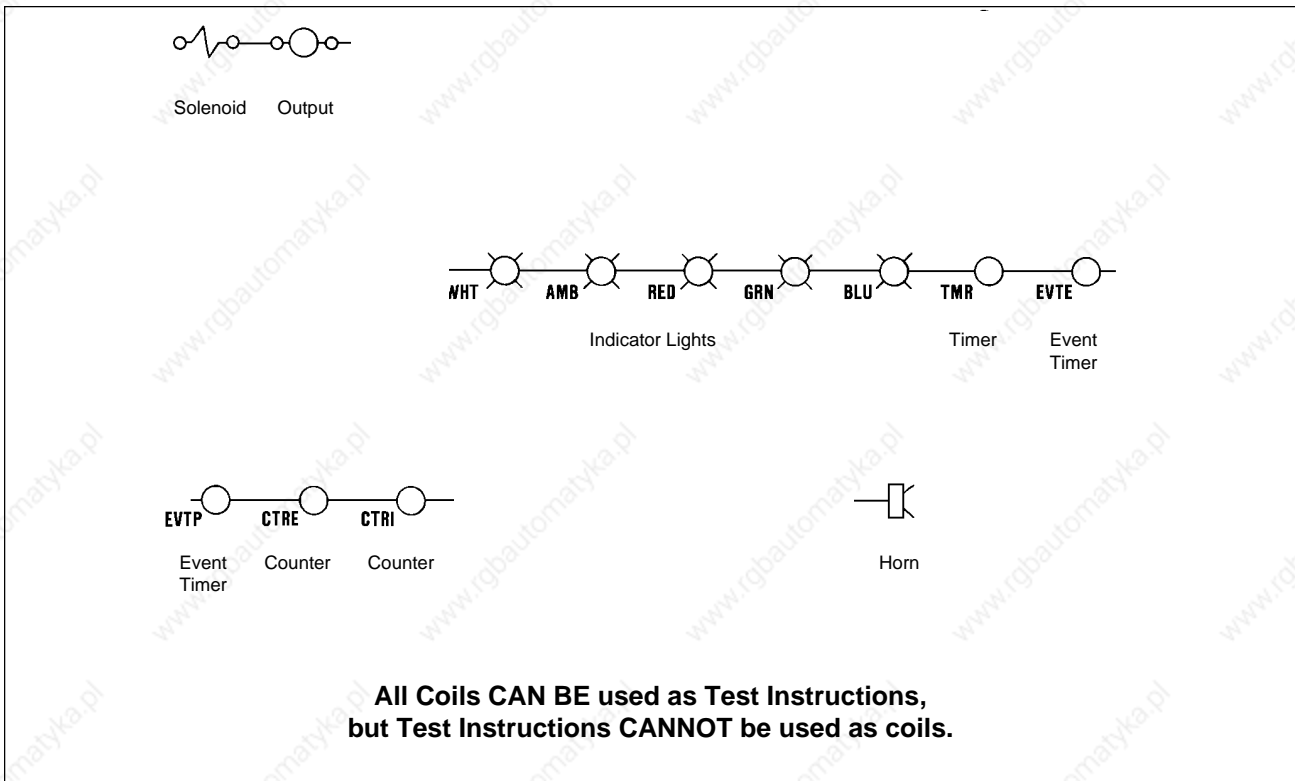

Figure10.2 Labels Editor Symbols (Coils)

IMPORTANT: It is the address of the coil which determines where a particular rung of logic is stored. If a coil with an address contained in Sequence Card 2 is found in the logic file (during compiling), a second RLD file will automatically be created.

Logic from the first sequence card will be in a file named RLD_SEQ.M1. If a coil or address from the second sequence card is found, the logic for the second sequence card will be stored in a file named RLD_SEQ.M2. The first sequence in the second rack will cause RLD_SEQ.M3 to be created, and so on, until Rack 4, Sequence 2 is reached and RLD_SEQ.M8 is created.

Use the F5 (Up) and F6 (Down) function keys to position the upper brackets to the row containing the appropriate symbol and then use the numeric keys (1 through 9 and 0) to make the selection. Press the return key and the brackets will shift one or two columns to the right. Symbols can be changed or corrected prior to pressing the return key or when a final edit is made.

STATE

The state column is only used when one of the multi-position selector switch symbols (row 1, selections 5 and 6) has been selected. Each selector switch is allowed to have a maximum of 4 on or off states or positions. Entering a 1 (or X) denotes the on state and entering a zero (or O) denotes the off state. Enter the desired status and press the return key. The brackets will move to the Comments column. States can be changed or corrected prior to pressing the return key or when a final edit is made. States are only used on the printout and have no effect on the compilation of logic.

COMMENTS

A forty character comment can be written for each device. When a printout of the logic diagram is made, the comments will be placed above the device. Comments are entered by typing in the desired information. They should be kept as short as possible as they will expand the printout of the logic diagram. After the comments are keyed in, press the return key to enter them and press the page down key to move the cursor to the label column for the next entry.

7.2 Editing a Labels File

After the labels file is created it should be edited for accuracy and correctness. Come out of the Insert mode by pressing page down and then the escape key. The screen will show the labels file sorted in alphanumeric order (not the order in which it was entered). Note that it is not possible to sort by address or symbol, only by label. Go through the file to make corrections and changes as necessary. The following list describes the use of the special function keys used when editing.

Cursor Keypad Arrows

When not in the insert mode, these keys allow the user to position the lower brackets in any existing field of the label file. Hold down either the up or down arrow to scroll through the entire file. Page Up and Page Down also work for scanning through the labels.

Escape Key

Generally the escape key will remove the user from the mode or routine being used. It is also used to exit the Label Editor.

Insert Key

The insert key allows the user to insert new labels into an existing labels file. A new file is automatically put into the insert mode. To return from the insert mode first press page down and then press escape. The entered labels are automatically sorted in alphanumeric order.

Delete Key

The delete key deletes an entire label entry. The position of the lower brackets is the determining factor in the selection of the removed entry. The brackets can be in any field of the entry targeted for deletion. After the delete key is pressed, a message on how to continue will appear at the bottom of the screen.

Function 1 (F1) Key

When the lower brackets are in the label, address, state, or comment field, the F1 key repositions the editing cursor one space to the left within the border of the field pointed to by the lower bracket.

Function 2 (F2) Key

When the lower brackets are in the label, address, state, or comment field, the F2 key repositions the cursor one space to the right within the border of the field pointed to by the lower bracket.

Function 3 (F3) Key

When the lower brackets are in the label, address, state, or comment field, the F3 key inserts a character in the text of the field at the location of the editing cursor.

Function 4 (F4) Key

When the lower brackets are in the label, address, state, or comment field, the F4 key deletes a character in the text of the field at the location of the editing cursor.

Function 5 (F5) Key

Moves the device selection brackets up one line.

Function 6 (F6) Key

Moves the device selection brackets down one line.

Function 7 (F7) Key

The F7 key activates the "find" function. The cursor brackets will appear at the bottom of the screen under the label heading. Type in the label or address to be found and press the return key and then the page down key. If the label or address is in the file, it will appear at the top of the column along with the six subsequent labels or addresses.

Function 10 (F10) Key

The F10 key exits the label editor and goes directly to the logic (RLD) editor without using menus. Entered data is automatically saved when the F10 key is pressed.

Return Key

When changes are made in the label, address, or comments fields, the return key must be pressed in order to enter the data and unlock the cursor keypad. If the return key has not been pressed, when it is attempted to move the cursor, the computer will beep and the brackets will stay where they are.

After the labels file is completely edited, the file must be saved. Press the escape key to exit the edit mode. The following menu will appear.

SELECT AN EXIT PROCEDURE:

RETURN – to editor

BACKUP – labels

EXIT – and save labels

ABORT – editor

Cursor to "EXIT - and save labels" and press return. The labels will be saved and the main menu will appear.

NOTE: During the process of making and editing labels, they should be periodically saved to avoid the possibility of someone inadvertently removing power from the computer or pressing keys which would not save the entered data.

To save the data in the middle of an editing session, press the escape key and then select Backup labels from the menu.

SELECT AN EXIT PROCEDURE:

RETURN – to editor

EXIT – and save labels

ABORT – editor

Whatever has been entered up to then will be saved and the program will return to the point where it was exited.

7.3 Outputting a Labels File

To aid in drawing the sequence logic diagram, a hardcopy of the labels file should be made. Depending on the output designation choice made in Configuration, the label file will output to the CRT or printer (an Output Designator of "1" on the Config menu), or to an output file (LABEL.PRN - a "2" on the Config menu). Using the output file (a "2") allows the data format to be manipulated so that the file can then be saved and stored for reference or printed on a variety of printers. Using the CRT or printer (a "1") is comparable to using previous versions of the editor - it requires a specific printer which utilizes downloadable fonts.

7.3.1 Using Output to CRT or Printer

This routine was used in previous versions of the editor. If printing, make certain the printer is connected and turned on before entering the Output routine (in order to download the character set to the printer).

On the main menu, cursor to OUTPUT and press return.

SELECT A ROUTINE TO EXECUTE

CONFIGURATION

EDITOR

COMPILER

TRANSFER

EXIT

MACO COMPILER DESIGNATOR: VERSION 02
PROGRAM DIR: PATHNAME
RLD FILE DIR: PATHNAME

General Programming using the RLD Editor

The following menu will appear. Cursor to RLD LABEL and press return.

SELECT THE FILE TO BE LISTED

RLD LOGIC

COMPILER ERRORS

EXIT listing

The following menu will appear.

SELECT THE DESTINATION DEVICE

CRT SCREEN

If CRT Screen is selected as the destination device, the labels file will appear on the screen and begin scrolling by. Press any key to stop/start scrolling. Press Esc to return to the List Menu. If Line Printer is selected as the destination device, the following screen will appear

DOUBLE STRIKE MODE

EMPHASIZED MODE

DOUBLE STRIKE AND EMPHASIZED MODE

Select the desired print mode and press return. The following screen will appear.

Enter the header to be displayed on each page of the listing.
Press the 'RETURN' key when complete.

Type in a header and press return. The label file will print out with the header appearing on each page. A sample printout of a label file is shown in Figure 11.

7.3.2 Using Output to File

This is an updated method of outputting which was new with version 4.0 of the editor. No "printer setup" is required at this time. Move the cursor to OUTPUT and press return.

```
SELECT A ROUTINE TO EXECUTE

CONFIGURATION
EDITOR
COMPILER
OUTPUT
TRANSFER
EXIT

MACO COMPILER DESIGNATOR: VERSION 02
PROGRAM DIR:  PATHNAME
RLD FILE DIR:  PATHNAME
```

The following screen will appear.

```
This file output operation will create files which may exceed 1 megabyte in size

RECOMMENDED PROCEDURE

Utilize a directory on the system hard drive as the defined logic
(RLD) directory-use CONFIGURATION option from main menu to modify path

Do you wish to terminate the file output operation (Y or N) ? N
```

Warning screens were included (beginning with version 4.4) as a precaution in order to inform users that the files being created are of significant size and probably

















Injection Molding Machine		Label Table		
01 JUN 1993		10:33:31.67		page 1
LABEL	ADDRESS	DEVICE	STATE	COMMENT
A-119	258	CTRE 		CTR 2 ENABLE
A-114TR	195	TMR 		3TR COOLING CURING TIMER #3
A-115TR	196	TMR 		4TR DECOMPRESSION TIMER #4
A-116TR	197	TMR 		5TR CLAMP OPEN TIMER #5
A-120TR	198	TMR 		6TR MOLD PROTECT TIMER #6
A-121TR	199	TMR 		MS 1&8 DELAY TIMER #7
A-122TR	200	TMR 		MS 4&6 DELAY TIMER #8
A-123TR	201	TMR 		MS 7 DELAY TIMER #9
A-126TR	202			W SOL EXTENDER TIMER #10
B-113TR	1052			2TR HOLD TIMEOUT
B-114TR	219			3TR COOLING/CURING TIMEOUT #3
B-115TR	220			4TR DECOMPRESSION TIMEOUT #4
B-116TR	221			5TR CLAMP OPEN TIMEOUT #5
B-120TR	222			6TR MOLD PROTECTION TIMEOUT #6
B-121TR	223			MS 1&8 DELAY TIMEOUT #7
B-122TR	224			MS 4&6 DELAY TIMEOUT #8
B-123TR	225			MS 7 DELAY TIMEOUT #9
B-126TR	226			W SOL EXTENDER TIMEOUT #10
CO128	124			A SOL CLAMP CLOSE (SEQ OUT 28)
CO129	126		XOO	E SOL INJECT FRWRD (SEQ OUT 30)
CO130	120			MANUAL (10LTA)(SEQ OUT 24)
CO131	128			W SOL DIVERT (SEQ OUT 32)
CO132	1013			J SOLENOID INJ HIGH (BOOST)
CO133	1015			O SOL SCREW ROTATE
		RED 		

Figure 11. Labels File Printout (using Output Designator "1")

General Programming using the RLD Editor

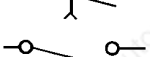
will NOT fit on a floppy disk. Determine whether or not to continue (press return) or abort (type "Y" and return) the operation and modify the path (in Configuration).

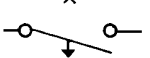
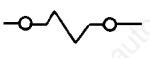
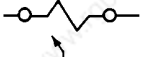
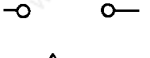
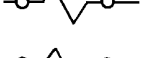
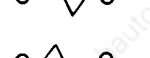
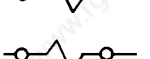
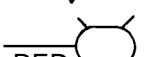

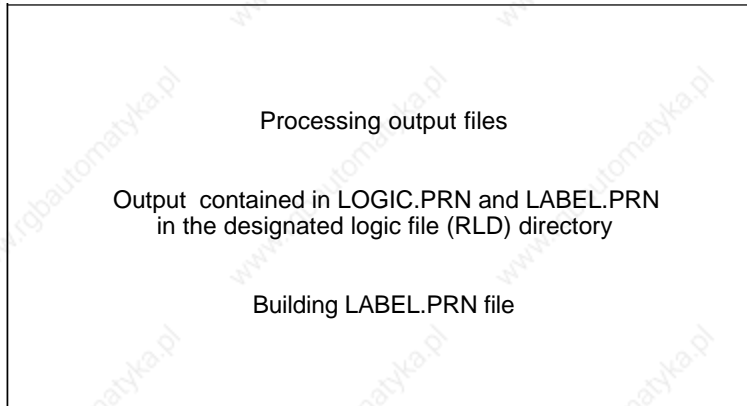
Once processing is complete (at the prompt), press any key to return to the main menu.

7.3.3 Printing using the LABEL.PRN File

The output contained in the ".PRN" files (logic and labels) is formatted to be 125 columns wide, in order to accommodate the logic device text and rung comments. If the file is to be printed in an 80 column format (the most common), the data contained in the file will need to be reformatted using a word processing program or standard editor. The following example is a description of using Microsoft Word for Windows Version 2.0 to perform the formatting. It should be noted that numerous other software programs can be utilized.

1. Open Microsoft Word for Windows.
2. Import LABEL.PRN from the label file directory.
3. From the pull-down menus at the top of the command bar, select "Edit" and then "Select All."
4. From the font command bar, select "Courier New."
5. From the font size bar, select size "7."
6. From the pull-down menus at the top of the command bar, select "Format" and then "Page Setup."
7. Select definition of margins. Set the margins to the following values:

Top	0.2 inches
Bottom	0.2 inches
Left	0.5 inches
Right	0.5 inches
Gutter	0.0 inches
8. Select size and orientation. Set the orientation to "Landscape."

The printout is now formatted for an 80 column output. The same procedure can be used for the logic file. Note that 7-point Courier New "works" well in this example. For other programs, it may be necessary to experiment with different type faces and sizes in order to achieve the best results.

8. The Logic (RLD) Editor

8.1 Introduction

The RLD Editor allows the programmer to build a sequence logic diagram using graphic symbols. Once the Labels file has been created and saved, the logic editor can be used to create the logic program.

8.2 Creating a Relay Ladder Diagram

From the main menu select EDITOR and press return.

```
SELECT A ROUTINE TO EXECUTE

CONFIGURATION
EDITOR
COMPILER
OUTPUT
TRANSFER
EXIT

MACO COMPILER DESIGNATOR: VERSION 02
PROGRAM DIR:  PATHNAME
RLD FILE DIR:  PATHNAME
```

The editor menu will appear.

```
SELECT EDITOR TO BE EXECUTED

EDIT LOGIC
EDIT LABELS
EXIT
```

Select EDIT LOGIC and press return. The following menu will appear.

```
SELECT THE RLD SOURCE FILE

EXISTING RLD
BLANK FILE
ABORT EDIT
```

IMPORTANT: Selecting BLANK FILE when a Labels file or Logic file already exists will DELETE those files and the existing work will be lost!

Assuming that no file exists, select BLANK FILE and press return. (The first time through, the menu will not display EXISTING RLD.) The screen will now display a pair of movable brackets in the upper left-hand corner and function key codes at the bottom.

The brackets are a movable cursor indicating where a symbol or wire is to be inserted. To initialize the function press the return key. The screen should now display two short vertical lines placed on either side of the screen and the number 1. The two vertical lines represent L1 and L2, between which the rung is going to be constructed. The number indicates Rung 1.

The cursor keypad and the function keys are used to do the actual editing.

F1 – Will insert a normally open contact within the bracketed area.

F2 – Will insert a normally closed contact within the bracketed area.

F3 – Will insert a coil or output device at the end of the logic rung.

F4 – Is used to draw the connecting wires.

F5 – (Find) Takes the editor to a specific location in the logic diagram without scrolling line by line or page by page. Used mainly in the editing mode, not in the initial programming mode.

F6 – (Text) Allows access to the RLD Text Editor. The Text Editor provides a means to add text to a rung of logic. Up to 20 lines (80 characters each) of text can be used per rung to be entered. The text will not appear on the computer display of the RLD. It is, however, printed out in the correct position.

See the RLD Text Editor section for additional details.

F7 – (Select) Allows selection of entire rungs of logic which can then either be cut, copied or pasted to a buffer (for temporary storage) or to a file (for more permanent storage); or can be discarded.

F10 – The F10 key exits the Logic Editor and goes to the Label Editor without using menus. Entered data is automatically saved when the F10 key is pressed.

Cursor Keypad – The up/down and left/right keys move the brackets to the desired position.

Insert Key – Used to insert new lines of logic.

Delete Key – Used to delete logic.

To place the labels created in the Label Editor into the relay ladder diagram, position the brackets to the appropriate place on the screen and type in the label assigned to the device. Press return and the appropriate symbol will appear. The F1 and F2 keys can be used to change between normally open and normally closed contacts and the F3 key will define the device as an output.

For example, in the label file CR1 was defined as an output control relay. When the logic diagram is built and "CR1" is typed in, when return is pressed a normally open

General Programming using the RLD Editor

relay contact will appear. The symbol can be changed to a normally closed contact by pressing the F2 key, or to an output coil by pressing the F3 key.

To establish a new line of logic, first enter the "insert" mode by pressing the Insert key ("Insert On" appears on the screen), then move the brackets to the left side of the screen and press return. A new line number will appear.

Certain rules must be followed:

- There can be a maximum of nine devices per line.
- There can be only one output device per rung.
- Two different ladder rungs cannot share the same line (see Figure 12).
- Logic can only flow from left to right through contacts (see Figure 13).
- A rung cannot exceed 20 lines.
- A rung cannot have more than 40 contacts.

NOTE: During the course of creating the logic diagram, periodically save the created portions on disk. Storing portions at a time will eliminate the possibility of someone inadvertently removing power from the computer or pressing keys which would not save the program.

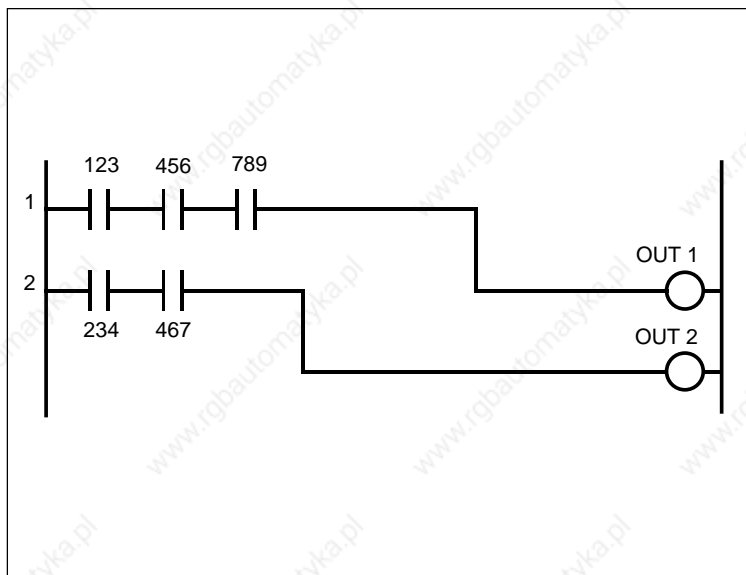

Figure 12. Two Rungs Cannot Share the Same Line

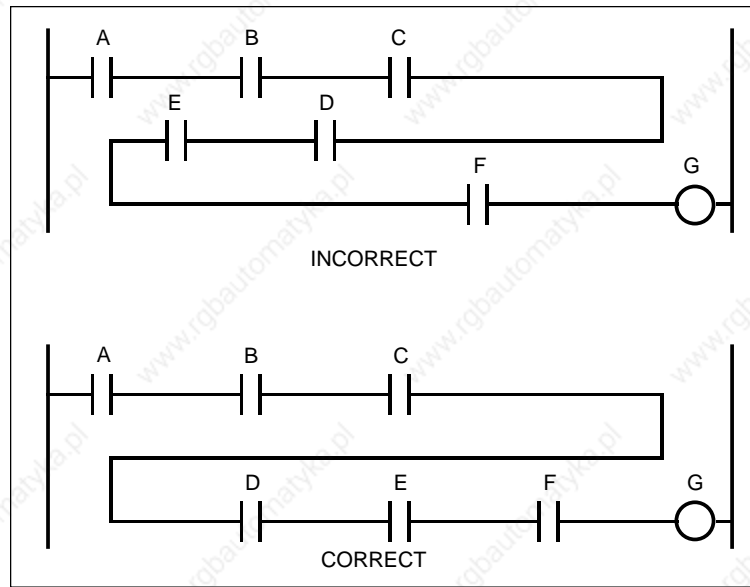
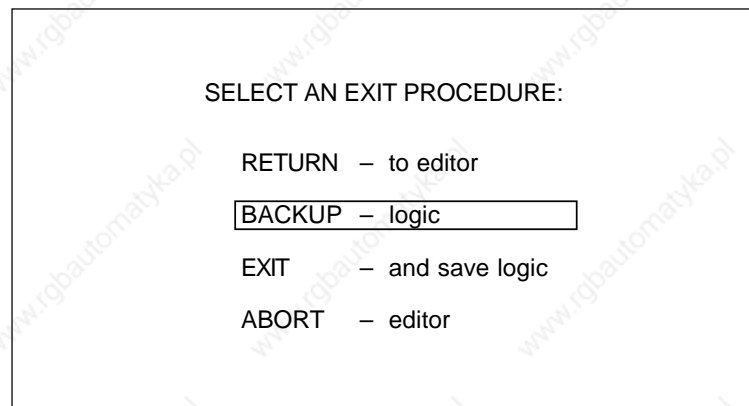

Figure 13. Logic Can Only Run Left to Right through Contacts

To save the data in the middle of an editing session, press the escape key (twice if in the insert mode) and then select Backup logic from the menu.



Whatever has been entered will be saved and the program will return to the point where it was exited.

During the course of entering the program this symbol (>) may appear on the screen after a label has been typed in and entered. This means that a label that is not in the label file has been entered, or was not entered exactly as it appears in the label file (wrong case, a space may have been put in or left out, letters or numbers transposed, etc.). An undefined or incorrectly entered label may also not give the correct logic symbol (a normally open relay contact will be used).

If what was entered was indeed what was wanted and is either missing or incorrectly entered in the label file, just continue on with the editor. Go back and correct the label file after the RLD is completed. When the label file is corrected, the appropriate symbol will appear.

After the complete sequence logic diagram has been entered, exit the RLD editor (press escape and do an "EXIT - and save logic"). The RLD will be saved and the program will return to the main menu.

8.3 Editing a Relay Ladder Diagram

After the ladder diagram is created, examine each and every rung for correctness. In all probability there will be some errors to correct or some changes to be made. The following is a listing of the keys used when editing sequence logic.

Cursor Keypad Arrows

Use the cursor arrows to position the brackets to any column of a defined line for the purpose of indicating the symbol or wire to be edited.

Escape Key

Generally, used to remove the user from the mode or routine being used. It is also used to exit the editor.

Insert Key

The insert key allows the user to insert new lines of logic to an existing logic file. A new file is automatically put in the insert mode. Upon return from the insert mode, the entered logic can then be edited. The insert key acts as an on/off toggle. Press this key to enter/exit the insert mode. To enter a new line or lines of logic, position the brackets at the left of the line where the logic is to be inserted, press the insert key, and press return. The logic on that line will be pushed down to make room for the new logic. Press return a second time to push it down another line and so on.

Delete Key

The delete key deletes a single symbol, a line of symbols, or an entire page of logic. The amount of logic deleted is dependent upon the width and position of the brackets. Press the delete key to place the editor in the delete mode. The cursor keypad arrows then control the right bracket. Position the right bracket to include as much or as little logic as desired. Press the delete key a second time and press "Y" to remove the logic.

Function 1 (F1) Key

Inserts a normally open contact in the bracketed area.

Function 2 (F2) Key

Inserts a normally closed contact in the bracketed area.

Function 3 (F3) Key

Inserts a coil or output device at the end of the logic rung.

Function 4 (F4) Key

The "wire" mode. Connects all of the devices to L1 and L2. Once in the "wire" mode, moving the brackets will lay a wire behind the brackets, until the wire hits an existing symbol or F4 is toggled again.

Function 5 (F5) Key

The "find" mode. Allows the user to locate any previously entered label by keying in the variable name of any device symbol. The editor jumps to that position in the

file. There is a choice of five finding procedures, selectable from a standard menu and the cursor keypad. The types of variables are:

REPEAT LAST FIND COMMAND
EC (Energize Coil)
TEST INSTRUCTION
FIRST OCCURENCE
UNDEFINED LABEL
SCROLL TO RUNG #
quit flnd

Once a category is selected, the editor will ask the name of the label being searched for (except in the first case. Once the name is entered, press return (the backspace key will allow the choice to be edited).

Scroll To Rung

Another screen will appear asking for the rung number. Type in the number and press return. The rung number entered will appear with the cursor brackets. If an invalid rung number is entered, the message "Invalid Rung #" will appear. Press any key to escape.

Function 7 (F7) Key

The "select" mode. Use the arrow keys to position the brackets to the left end of the first line to be selected and press F7. Then cursor to the right end of the last line to be selected and press F7 again. Up to 25 lines can be selected at once. Only complete lines can be selected. Once the selection is made it disappears from the screen and three new functions appear on the screen:

F1: copy to either a buffer or file.

Copy to the buffer for temporary storage within the program. Then relocate the brackets (even change logic files), use F7 to select a new position and paste from the buffer.

Copy to a file for more permanent storage in a DOS file. If copy to file is selected, a prompt for a valid DOS filename appears. Type in up to eight characters and press return. Then relocate the brackets (even change logic files), use F7 to select a new position and paste from the file. Note that you must know the filename in order to retrieve it – record it when you create it.

Note that if an invalid filename is used, the logic will be copied to a file titled NONAME.BUF.

Once the selected logic is copied to either the buffer or a file, the selection returns to the screen.

F2: cut to either a buffer or file.

Cut to the buffer for temporary storage within the program. Then relocate the brackets (even change logic files), use F7 to select a new position and paste from the buffer.

Cut to a file for more permanent storage in a DOS file. If cut to file is selected, a prompt for a valid DOS filename appears. Type in up to eight characters and press return. Then relocate the brackets (even change logic files), use F7 to select a new position and paste from the file. Note that you must know the filename in order to retrieve it – record it when you create it.

Note that if an invalid filename is used, the logic will be copied to a file titled NONAME.BUF. Once the selected logic is cut, it will disappear permanently from the present program screen.

F3 paste from either buffer or file.

The complementary function of cut or copy. Use F7 to select an area for the paste to occur and then paste either from the buffer or from a file. Note that you must know the filename in order to retrieve it – record it when you create it.

F4 discard the selected rungs (equivalent to deleting the selection).

Backspace Key

Allows the user to edit any entered variable name (provided the return key has not been pressed).

Page Up Key

Scrolls the logic file up 6 lines at a time.

Page Down Key

During the edit mode, the page down key scrolls the logic file down 6 lines.

After the sequence logic is completely edited, the revised logic must be saved. Press escape to exit the editor and then cursor to the "EXIT - and save logic" selection and press return.

8.4 The RLD Text Editor (F6)

The RLD Text Editor provides a means for adding descriptive or explanatory text to a rung or group of rungs of logic. Each text entry may contain up to 20 lines (80 characters per line) of text. The Text Editor function is keyed to output devices (EC's - Energize Coils) which means that the bracketed cursor must be positioned on an output device when the F6 key is pressed. If the EC is moved, the text will move with it. If the EC is deleted, the text will not be displayed.

If the cursor is not on an output when F6 is pressed, an error message (ERROR; Cursor is not positioned over an ECed Output) will be displayed. Press return to escape, move the cursor over an output and press F6. The screen shown in Figure 14 will be displayed.

At the top of the screen is the label and the address for the output selected. The text is entered between the horizontal lines. A small blinking cursor shows the location on the screen. The cursor keypad controls the position of the cursor. The return key moves the cursor to the left margin and down a line. Press the insert key to put the editor in the insert mode. Characters can then be inserted at the cursor. Editing is accomplished by moving the cursor and correcting the mistake. The space bar will remove characters.

To delete the entire text entry, press the F8 key. To save the text, press the F7 key. To delete segments of the text use the delete key and the cursor control to bracket the desired area. Press the delete key again and the area to be deleted will be covered by the cursor. Press the "Y" key and the segment will be deleted. Text after

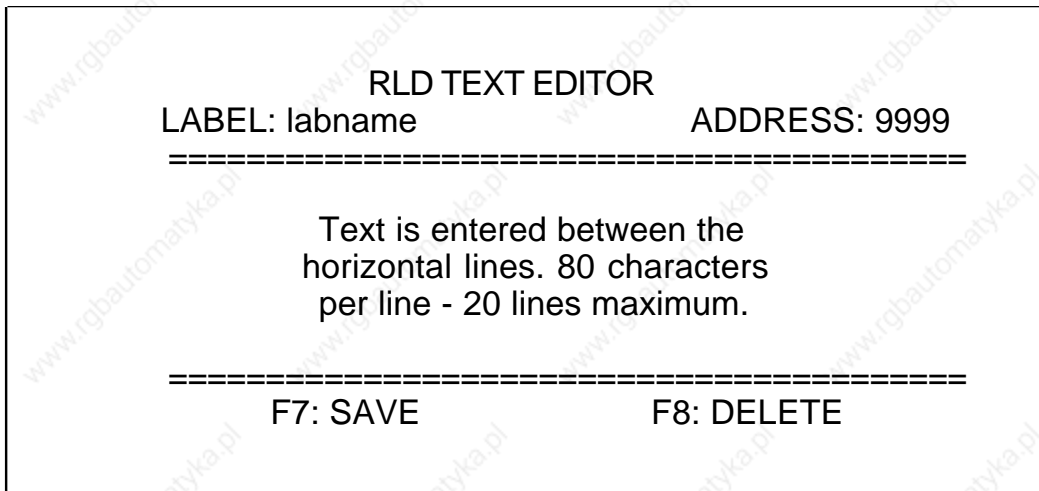

Figure 14. Text Editor Screen

the deleted area will be repositioned into the vacated area. A sample of a printout of a logic program using the text editor is shown in Figure 15. The text editor copy is in the middle of the printout above the ladder rung.

8.5 Compiling the RLD

The COMPILER portion of the RLD Editor package is the next step in the process of creating a relay ladder diagram and transferring to the controller. The RLD compiler package is a debugging tool and a communication interpreter for interfacing with the controller.

From the main menu, cursor to COMPILER and press return.

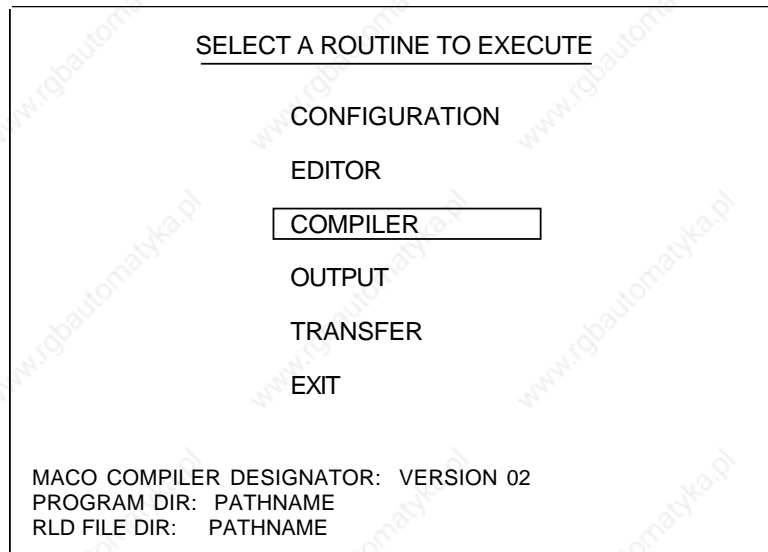

The compiler has a syntactical error handling program. It is the first of three steps in the compiling process and is used to correct the relay logic. The following error messages are displayed on the CRT after the error processing is completed:

- label error - label not defined in table
- range error - oversized or overlapping function(s)
- range error - invalid symbol address

- range error - error limit exceeded
- termination error - invalid termination not an EC (Energize Coil)
- connection error - function not connected to L1
- connection error - function not connected to L2
- connection error - wire with open connections
- connection error - symbol with open connections

The error messages are accompanied by the appropriate line and column number associated with the detected error message. It is quite possible that numerous errors may occur, necessitating the capability to review the list of errors without rerunning the program; therefore, a file of the current errors from the present run is built concurrent with program execution. This also facilitates an error dump to the printer.

In addition, there are two unrecoverable errors that can occur during processing. The following errors print directly on the screen and result in premature termination of the RLD compiler. They are:

- RELAY LADDER DIAGRAM HAD NOT BEEN PROGRAMMED CORRECTLY
- NOT ENOUGH ROOM ON DISK TO FINISH PROGRAM

These result from problems with files. Error 1 is the result of not finding the necessary files to run the error handling program. This is due to not starting or finishing the RLD editor program.

Error 2 is the result of large quantities of disk memory being taken up by oversized RLD programs. It may be necessary to be more conservative in programming. These unrecoverable errors have highest priority and will not allow lower priority errors to be displayed.

After the error processing routines have tested the logic file, they will end with one of three messages. They are:

- PROCESSING FINISHED, CORRECT ERRORS BEFORE PROCEEDING
- PROCESSING FINISHED, UNRECOVERABLE ERRORS ENCOUNTERED
- PROCESSING FINISHED, NO ERRORS ENCOUNTERED

All errors must be corrected and checked with the error processing program before continuing. If errors occur, the program must be re-edited with the proper editor.

The second step in the RLD compiler is referred to as "pseudo-translation." The pseudo-translator follows the rungs of logic from beginning to end, converts the logic into a series of T.S.O.'s (Test Switch Open), T.S.C.'s (Test Switch Closed), and E.C.'s (Energize Coil). The pseudo-translator also catches many of the subtle errors possible with a rung of relay ladder logic. These are:

- Too many errors encountered
- Problems with files (probable bad disk)
- Problems with translator (rerun RLD compiler)
- Problems reading file for translator (rerun RLD compiler)
- Potential improper device structure
- Rung of logic too long
- Rung of logic has too many energize coils
- Rung of logic has too many nodal branches

- Rung of logic is too deeply nested
- Rung of logic has a branch which points to too many branches
- Rung of logic has improper output(s) from a branch
- Rung of logic has an illegal test

As with the error handling program, the pseudo-translator terminates the execution of the RLD compiler for serious infractions. The actual errors will be accompanied by the line numbers to assist in debugging.

The final step in the RLD compiler is to actually convert the instruction into a machine language code which can be understood by the MACO. This compiling routine, like the others, has resident error messages. They are:

- Error due to input file not found (rerun RLD compiler)
- Error due to incorrect information in input file (rerun RLD compiler)
- Error due to exceeding the maximum number of instructions
- Error due to exceeding system sequence-to-module byte limit
- Error due to exceeding system module-to-sequence byte limit
- Error due to exceeding system sequence-to-sequence byte limit
- Invalid mix of digital boards

Note that in MACO 4000, 5000 and 6000 series controllers with the advent of multi-rack systems and systems containing 2 sequence cards, the sequence-to-sequence byte limit can be a nuisance. Follow the suggestions outlined below to avoid STS problems.

Sequence to Sequence in a Single Rack containing 2 Sequence Cards

Up to 30 bytes of STS can be passed from Seq 1 to Seq 2.

Up to 30 bytes of STS can be passed from Seq 2 to Seq 1.

If you use the CR addresses that are automatically copied from one sequence card to another, NO STS bits will be used:

Addresses 2889 - 3128 EC in Seq 1 and are copied to Seq 2
7889 - 8128 Reserved (do not use in RLD)

Addresses 8129 - 8368 EC in Seq 2 and are copied to Seq 1
3129 - 3368 Reserved (do not use in RLD)

For example:

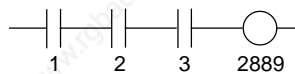

NO STS bits are used

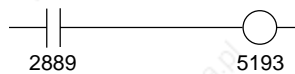

If you do it this way:

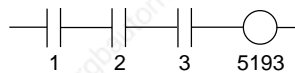

3 STS bits are used

Sequence to Sequence in a Multi-rack System

Each RACK can pass a total of 30 bytes of STS. In the event that you have 2 sequence cards in a rack, remember that any STS bytes used to pass STS between Seq 1 and Seq 2 (of that rack) are part of that 30 byte total above. Use

the method previously outlined to reduce or eliminate STS between two sequence cards in the same rack and follow the example below to minimize STS form rack to rack. To save STS, use a temporary CR in the rack you are coming FROM and then test that temporary CR in the rack in which it goes.

For example:

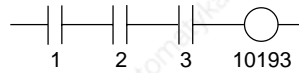

3 STS bits are used

If you do it this way:

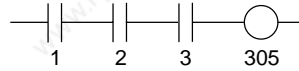

1 STS bit is used



9. Outputting the RLD

After the sequence logic program has been edited and errors corrected as much as possible, print a copy for final review. The printed copy makes final corrections easier. The labels and RLD printouts are important tools for troubleshooting machine operation, while examining the compiler errors is a necessity for correcting the errors found while compiling.

Depending on the output designation choice made in Config, the logic file will output to the CRT or printer (a "1" on the Config menu), or to an output file (LOGIC.PRN - a "2" on the Config menu). Using the output file (a "2") allows the data format to be manipulated so that the file can then be saved and stored for reference or printed on a variety of printers. Using the output to CRT or printer (a "1") is comparable to using previous versions of the editor - it requires a specific printer which utilizes downloadable fonts.

9.1 Using Output to CRT or Printer

This routine was used in previous versions of the editor. If printing, make certain the printer is connected and turned on before entering the Output routine (in order to download the character set to the printer). On the main menu, cursor to OUTPUT and press return.

```
SELECT A ROUTINE TO EXECUTE

CONFIGURATION
EDITOR
COMPILER
OUTPUT
TRANSFER
EXIT

MACO COMPILER DESIGNATOR: VERSION 02
PROGRAM DIR:  PATHNAME
RLD FILE DIR:  PATHNAME
```

The following menu will appear.



```
SELECT THE FILE TO BE LISTED

RLD LOGIC
RLD LABEL
COMPILER ERRORS
EXIT listing
```

Choose the item to be output. Selecting RLD LABELS or COMPILER ERRORS takes the program to a menu with a destination choice - CRT Screen or Printer. Select Line Printer for a hardcopy printout. The computer will then download the file or list to the printer.

If RLD LOGIC is selected, the following menu appears.

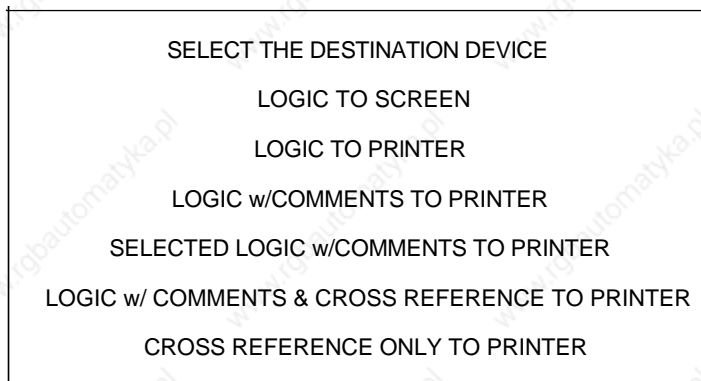

```
SELECT THE DESTINATION DEVICE

LOGIC TO SCREEN
LOGIC TO PRINTER
LOGIC w/COMMENTS TO PRINTER
SELECTED LOGIC w/COMMENTS TO PRINTER
LOGIC w/ COMMENTS & CROSS REFERENCE TO PRINTER
CROSS REFERENCE ONLY TO PRINTER
```

LOGIC TO SCREEN

Displays RLD on the computer CRT. Toggling the return key stops and starts scrolling of the logic program. Press escape to return to the list menu (there is no escape from the destination device menu – use this as a back door).

LOGIC TO PRINTER

Prints the RLD logic program without comments.

LOGIC w/COMMENTS TO PRINTER

Prints the RLD logic program along with comments.

SELECTED LOGIC w/COMMENTS TO PRINTER

Prints a selected portion of the logic program along with comments. The following screen will appear:

Enter the number of the first rung to be listed. DEFAULT = 1

Enter the number of the last rung to be listed. DEFAULT = 32767

The blinking cursor will appear beneath the 1. Enter the rung (line) number at which to start printing and then press return. The cursor will appear beneath 32767. Enter the rung (line) number of the last rung to be printed and press return. Press "Y" (Yes) to execute.

LOGIC w/COMMENTS & CROSS REFERENCE TO PRINTER

Prints the RLD logic program with comments and a cross reference listing (Figure 16). The cross reference listing is sorted numerically by control relay addresses. The listing also gives all the line numbers where the device is used in the program. The inverse state is indicated by an underline. For output devices, the symbol (<xxxx>) indicates the line number of the coil.

CROSS REFERENCE ONLY TO PRINTER

Prints the cross reference listing only. The message, "WARNING: The cross reference listing may not match your last logic listing" will appear at the top of the printout. If changes have been made to the RLD, the cross reference listing will reflect the latest changes but the RLD printout will not. It is recommended to always print the logic and the cross reference at the same time.

9.2 Using Output to File

Note that the logic CANNOT be edited in this manner (there is no means of re-converting this text file into a workable logic file).

This is an updated method of outputting which was new with version 4.0 of the editor. No "printer setup" is required at this time. Move the cursor to OUTPUT and press return.

```
SELECT A ROUTINE TO EXECUTE

CONFIGURATION
EDITOR
COMPILER
OUTPUT
TRANSFER
EXIT

MACO COMPILER DESIGNATOR: VERSION 02
PROGRAM DIR:  PATHNAME
RLD FILE DIR:  PATHNAME
```

The following screen will appear.

```
This file output operation will create files which may exceed 1 megabyte in size

RECOMMENDED PROCEDURE

Utilize a directory on the system hard drive as the defined logic
(RLD) directory-use CONFIGURATION option from main menu to modify path

Do you wish to terminate the file output operation (Y or N) ? N
```

Warning screens were included (beginning with version 4.4) as a precaution in order to inform users that the files being created are of significant size and probably will NOT fit on a floppy disk. Determine whether or not to continue (press return) or abort (type "Y" and return) the operation and modify the path (in Configuration).

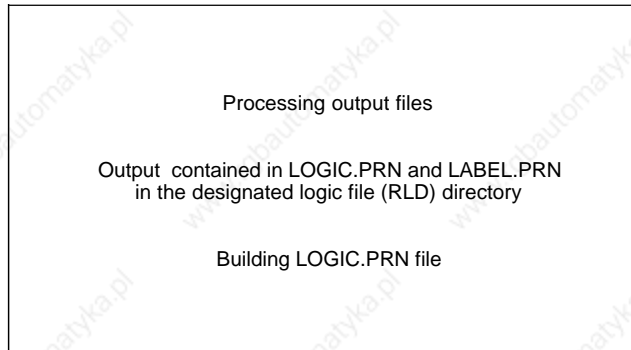

Once processing is complete (at the prompt), press any key to return to the main menu.

9.3 Printing using the LOGIC.PRN File

The output contained in the ".PRN" files (logic and labels) is formatted to be 125 columns wide, in order to accommodate the logic device text and rung comments. If the file is to be printed in an 80 column format (the most common), the data contained in the file will need to be reformatted using a word processing program or standard editor. The following example is a description of using Microsoft Word for Windows Version 2.0 to perform the formatting. It should be noted that numerous other software programs can be utilized.

1. Open Microsoft Word for Windows.
2. Import LOGIC.PRN from the logic file directory.
3. From the pull-down menus at the top of the command bar, select "Edit" and then "Select All."
4. From the font command bar, select "Courier New."
5. From the font size bar, select size "7."
6. From the pull-down menus at the top of the command bar, select "Format" and then "Page Setup."
7. Select definition of margins. Set the margins to the following values:

Top	0.2 inches
Bottom	0.2 inches
Left	0.5 inches
Right	0.5 inches
Gutter	0.0 inches

8. Select size and orientation. Set the orientation to "Landscape."

The printout is now formatted for an 80 column output. The same procedure can be used for the label file. Note that 7-point Courier New "works" well in this example. For other programs, it may be necessary to experiment with different type faces and sizes in order to achieve the best results.

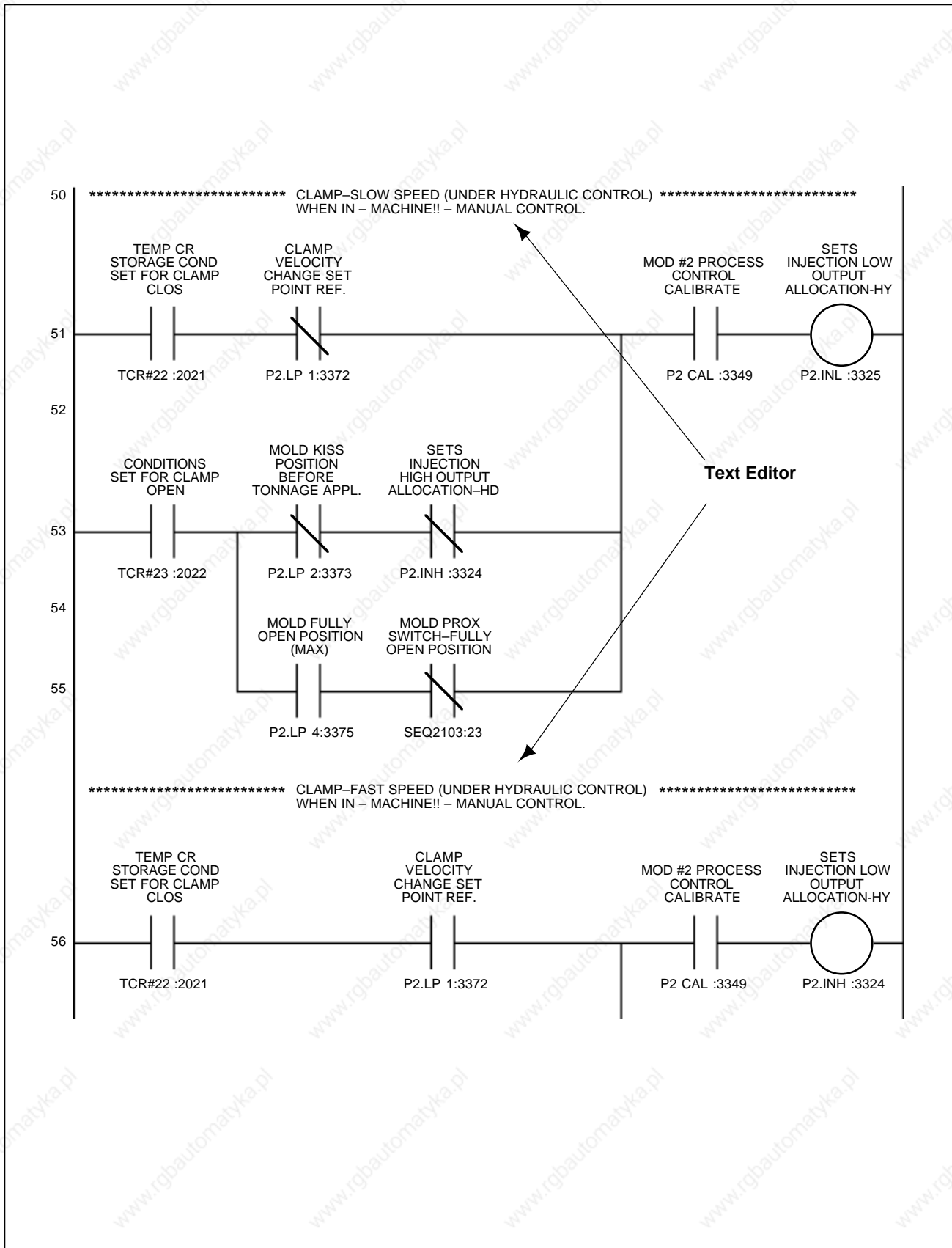

Figure 15. Sample RLD with Text

30 APR 1993		11:06:15.62						Page 1	
CR	1:	171	172	177	179	180	187	<u>210</u>	
		<u>212</u>	<u>243</u>	<u>246</u>					
CR	2:	241	<u>243</u>	<u>246</u>	277				
CR	3:	<u>241</u>	242	242					
CR	4:	248		62					
CR	5:	61	62	57					
CR	6:	56	57	192	203				
CR	7:	87	192						
CR	8:	88							
CR	9:	89		157					
CR	10:	250		150					
CR	11:	162		52					
CR	12:	166			248				
CR	13:	172	157	217					
CR	14:	171	150	52					
CR	15:	131	52	<u>162</u>	141	145			
CR	16:	124		166					
		<u>48</u>	217	172	119	140	<u>147</u>	<u>148</u>	
CR	17:	150	52	61	62				
CR	321:	<u>130</u>	<u>162</u>		106	87	88	89	
		34	166	171	249	259	107	124	
		57	172	131		195	162	166	
CR	322:	<241>		56	105	274	206	233	
CR	323:	<247>		96	192				
CR	324:	46	171	150	133		176	232	
CR	325:	32	131	187	88	175	160	177	

Figure 16. Cross Reference File Printout

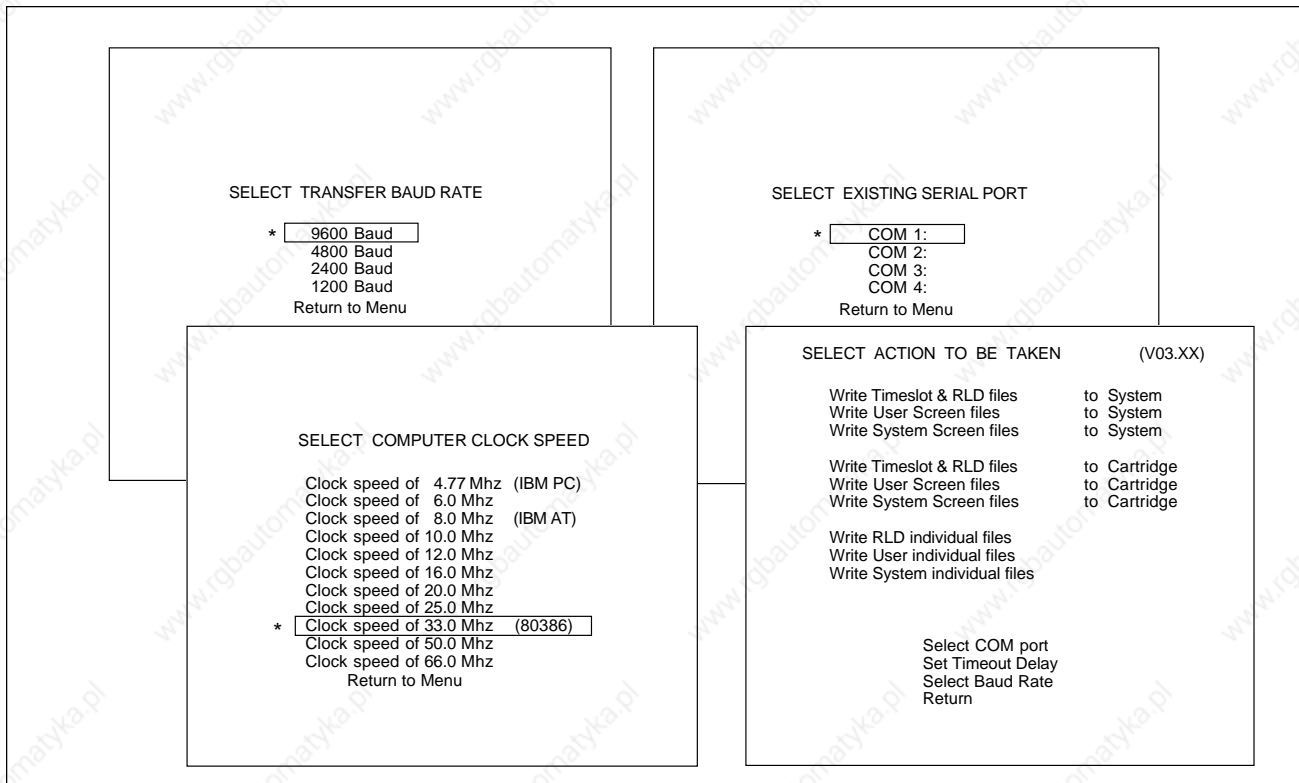

Figure 17. MACO 4000/5000/6000 Series Transfer Screens

Note that the choice for "Set Timeout Delay" as well as the Clock Speed menu will not appear if the auto timeout delay function has been selected on the Configuration screen.

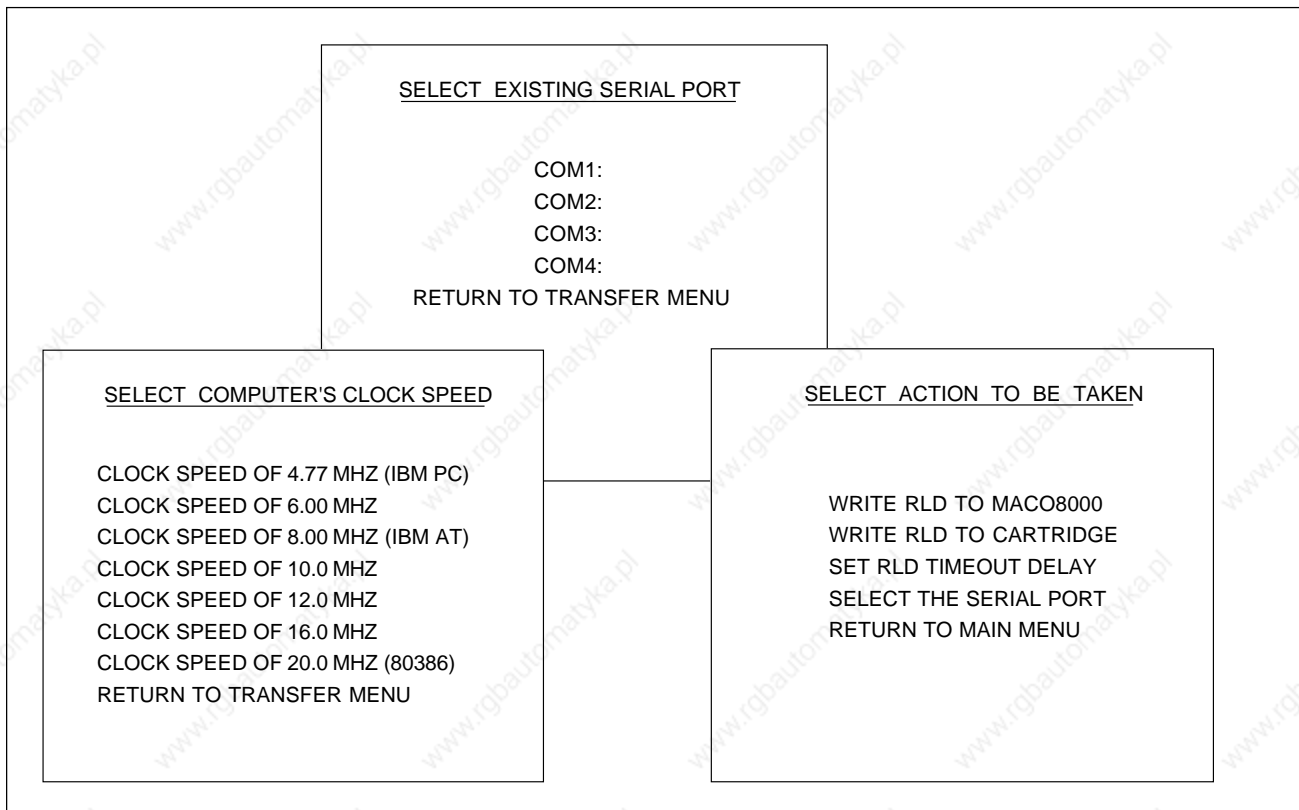

Figure 18. MACO 8000 Series Transfer Screens

Note that the choice for "Set RLD Timeout Delay" as well as the Clock Speed menu will not appear if the auto timeout delay function has been selected on the Configuration screen.

10. Transferring (Downloading) to the Controller

10.1 General

The last step of this process is to transfer the RLD to the controller where it is stored in EEPROM. The controller and computer must be connected to one another and the controller must have an operator station connected to it. The controller requires a cable with a DB9 connector at one end (the MACO 8000 requires a DB25 connector). The serial port of the computer dictates the connector at the other end. Refer to the figures showing cable pinouts at the end of this section.

10.2 Procedure

At the Controller Operator Station:

- From the SYSTEM CONTROL screen, turn off timeslot.

At the Computer:

- From the main menu, select TRANSFER.
- Cursor to "Select COM port" and press return. The currently selected communications port will be asterisked. Use the arrow keys to position the reverse video cursor over the proper communications port and press return. The program will return to the transfer menu.
- Cursor to "Select Baud Rate" and press return. The currently selected baud rate will be asterisked. A baud rate of 9600 generally works best, but make certain the computer and controller agree. Use the arrow keys to position the reverse video cursor over the proper baud rate and press return. The program will return to the transfer menu.
- Cursor to "Set Timeout Delay" and press return (note that if the auto timeout delay function has been selected on the configuration screen, "Set Timeout Delay" does not appear here). The currently selected timeout delay will be asterisked. For the timeout delay, if uncertain of the clockspeed, choose a higher clockspeed from the menu. Use the arrow keys to position the reverse video cursor over the proper clockspeed and press return. The program will return to the transfer menu.
- From TRANSFER, select WRITE RLD & TIMESLOT TO MACO.

At this point the computer should start downloading the data. The MACO operator station and the computer CRT will display the data being sent. The file TIMESLOT will be transferred to the Insta-Set module in the MACO 8000 or the Data Handler board on an Alpha system. The other files (SEQ_RLD_.M?) will be transferred to the various sequence control modules or sequence cards in a system. On completion of transmission, the computer will exit the transfer routine and return to the transfer menu.

Note that replacement of the Insta-Set module or the Sequence module in a MACO 8000 or the Data Handler board or Sequence board in an Alpha system will require reloading the RLD.

11. Transferring (Downloading) to a Cartridge

The sequence logic program may also be downloaded from the computer and stored in a memory cartridge. Insert an Insta-Set cartridge into the operator station and follow the previous procedure except select WRITE RLD TO CARTRIDGE.

12. Transferring (Downloading) to a Multi-rack System (Alpha Systems)

Transferring RLD to a multirack system is no different than transferring to a single rack system if a complete set of files is being transferred. Follow the steps outlined in the Procedure subsection for preparing the controller and computer, and from the "Select Action to be Taken" menu, choose "Write Timeslot & RLD Files to System." Individual files for multiple racks will automatically be directed to the correct controller (and sequence card).

In order to transfer a single RLD file, from the "Select Action to be Taken" menu, choose "Write RLD individual files" and press return. A menu like the one shown below will appear. *Note that care should be taken when transferring single RLD files. All headers must match in order for timeslot to start. If a file from a different RLD is transferred, a "Sequence RLD Header Mismatch" will occur and timeslot will not start.*

```
SELECT SINGLE FILE TO BE SENT

Write RLD Files                to Controller

Write Timeslot                to Controller
Write RLD file                to Controller
Write RLD file #2            to Controller

Write Timeslot                to Cartridge
Write RLD file                to Cartridge
Write RLD file #2            to Cartridge

Select Controller
Return to Menu

Controller #1
```

Make certain the correct controller is displayed in the lower left corner of this screen. If the controller number needs to be changed, cursor to "Select Controller" and press return. Once the correct controller is selected, return to the screen above and choose the individual file to be transferred. Note that the first line choice (Write RLD Files to Controller) will transfer RLD #1, RLD #2 (if it exists) and Timeslot to the chosen controller.

Continue the transfer as necessary. Note that RLD #2 will exist only if an output device with an address contained in a second sequence card (in an individual rack) is used in RLD. It is the address of the OUTPUT DEVICE in a particular rung of logic that determines where (RLD #1 or RLD #2) that particular logic is stored.



DB9	Shield	
1	DCD	Black
2	RXD	White
3	TXD	Red
4	DTR	Green
5	SG	Brown
6	DSR	Blue
7	RTS	Orange
8	CTS	Yellow
9	RI	Purple

PC to MACO

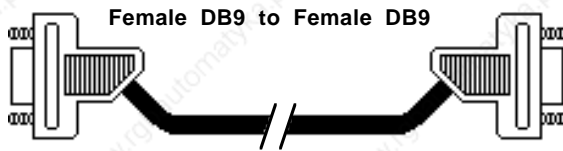

DB9	Shield		DB9
1	DCD	Black	DCD 1
2	RXD	White	TXD 3
3	TXD	Red	RXD 2
4	DTR	Green	DSR 6
5	SG	Brown	SG 5
6	DSR	Blue	DTR 4
7	RTS	Orange	CTS 8
8	CTS	Yellow	RTS 7
9	RI	Purple	RI 9

PC to MACO



DB9	Shield	Chassis Gnd	DB25
1	DCD	Black	DCD 8
2	RXD	White	TXD 2
3	TXD	Red	RXD 3
4	DTR	Green	DSR 6
5	SG	Brown	SG 7
6	DSR	Blue	DTR 20
7	RTS	Orange	CTS 5
8	CTS	Yellow	RTS 4
9	RI	Purple	RI 22

MACO to Printer

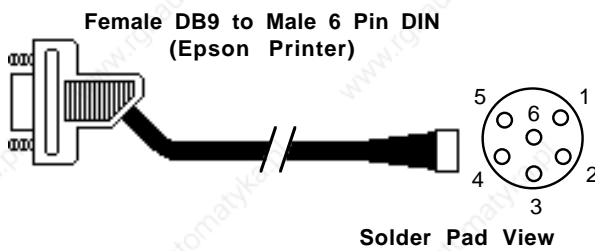

DB9	Shield	Chassis Gnd	6 Pin DIN
1	DCD		6
2	RXD	Black	TXD 1
3	TXD	White	RXD 3
4	DTR		
5	SG	Red	Signal Gnd 5
6	DSR	Green	DTR 2
7	RTS		Not Used 4
8	CTS		
9	RI		

Stub these Wires:
Brown
Blue
Orange
Yellow
Purple

MACO to Epson Printer

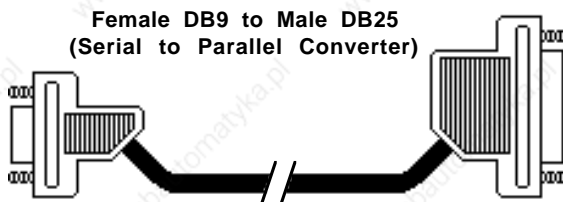

DB9	Shield	Chassis Gnd	DB25
1	DCD		1
2	RXD		
3	TXD	Red	RXD 3
4	DTR		
5	SG	Black	SG 7
6	DSR	Green	DTR 20
7	RTS		
8	CTS		
9	RI		

Figure 19. Communications Cable Assemblies

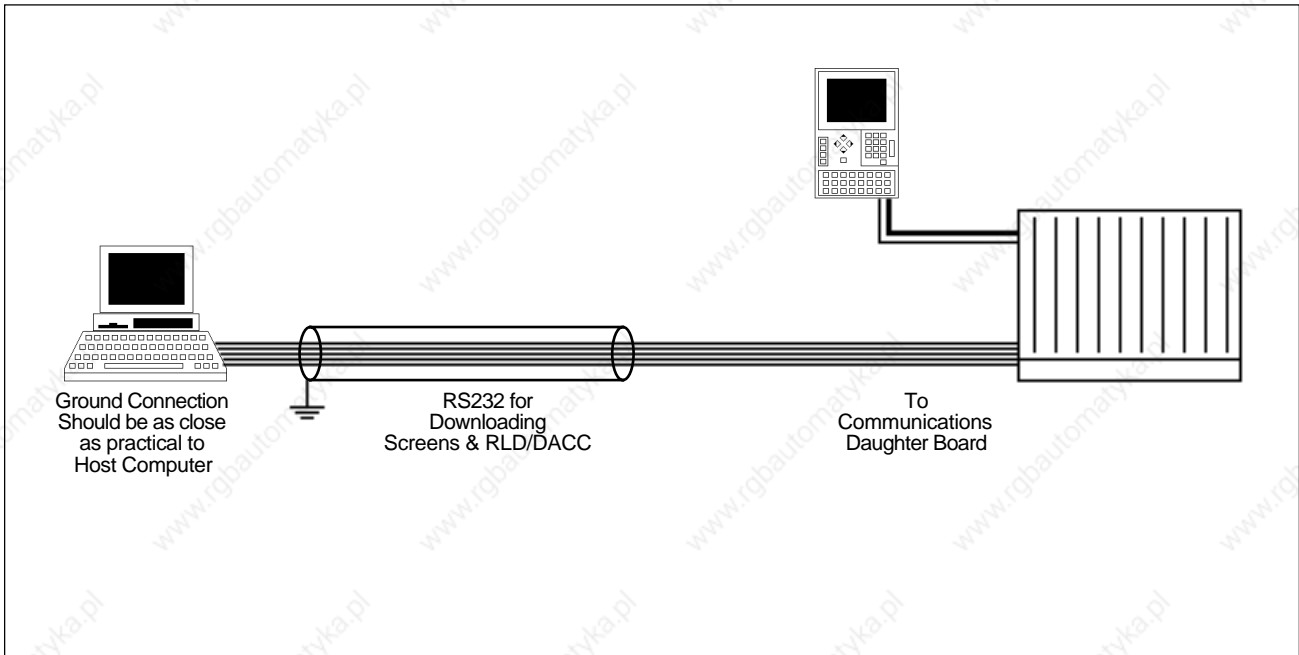

Figure 20. Downloading the Sequence Logic Program



Barber-Colman Company / Eurotherm Controls, Inc.

741-F Miller Drive, Leesburg, VA 20175

Phone: 703-443-0000

Fax: 703-669-1300

<http://www.barber-colman.com> <http://www.eurotherm.com>

An Invensys Company

Copyright © 2001 Barber-Colman Company.